



# OWNER'S INSTRUCTIONS

ENGLISH

SR -V52/V57 : TYPE A  
SR-519/569 : TYPE B, C

## REFRIGERATOR

Before operating the unit, please read this manual throughly, and retain for future reference.

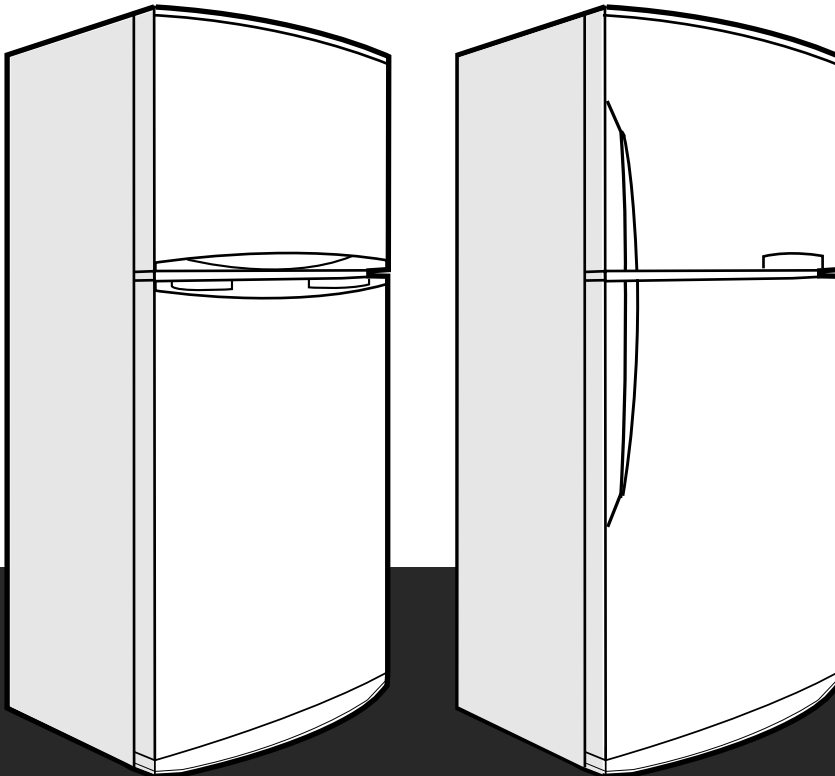

If you took out of the power supply outlet, you should plug in again after five minutes.

# FEATURE

## Uniform supply of cold in refrigerating room!

- Food can be refrigerated more freshly and evenly by supplying cold even to the corners by means of rotating wings to distribute cold, which are installed to the cold outlet of the refrigerating room. (Rotating cooling system).

## Uniform supply of cold in the freezing room!

- Foods can be frozen more evenly by the air shower function to jet cold evenly in the freezing room.

## Being fresh by Bio deodorizer!

- Bio deodorizer that remove every kinds of foods smell in refrigerator maintains the origin flavor of foods newly.

## Rapid opening and closing by rail system!

- Vegetables and fruits can be rapidly accessible to prevent loss of cold by employing a rail style design in high-humidity vegetable room and high-umidity special room which operates smoothly only by pulling and pushing a handle effortlessly.

## Even slightly opened door is closed automatically by itself!

- In case of slight opening of refrigerator door, it will be closed automatically by employing energy-saving, automatic closing function.



X-Flow cooling system is a new rotating cooling system that refrigerates the inside of refrigerator quickly and uniformly by rotating wings transmitting cold in all the corners.

TYPE A only: Please refer to page 11.

## CONTENTS



---

FEATURE .....	1
WARNING FOR SAFETY .....	2
CAUTION FOR SAFETY .....	4
PREPARATIONS PRIOR TO USE .....	6
HOW TO STORE FOODS CORRECTLY .....	7
INSTALLATION METHOD .....	8
HOW TO USE FREEZING ROOM.....	9
HOW TO USE FEFRIGERATING ROOM.....	11
HOW TO DISASSEMBLE ACCESSORIES...14	
CLEANING METHODCE.....	16
PROCEDURE OF INSTALLATION .....	18
CAUTIONS WHEN USING.....	19
CHECK PRIOR TO SERVICE REQUEST.....	20
ANSWER TO THE QUESTION.....	22







# WARNING FOR SAFETY

This is to prevent users or other persons from being wounded or injured, by using the present product properly. Be sure to observe these contents for safety. (After reading these contents, please keep in such a safe place as to look up)



## Contents of Caution/Warning

 <b>WARNING</b>	Represents the contents that death or heavy injury of a person is foreseen.
 <b>CAUTION</b>	Represents the contents that injury of a person or damage of material is foreseen.

## Contents of indication

	Represents the contents of prohibition.
	Represents the prohibition of disassembly.
	Represents the prohibition of contact.
	Represents what has to be observed.
	Represents that a power plug has to be separated from the plug socket.
	Represents earth for prevention of electric shock.

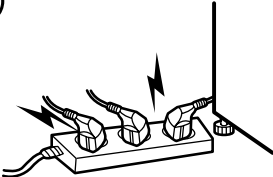
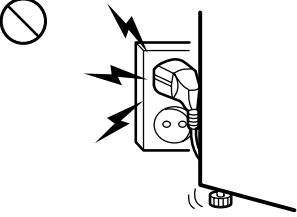
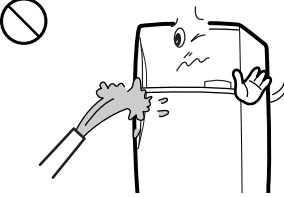
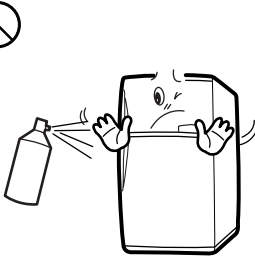
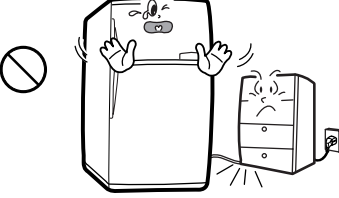
## WARNING

<p><b>Do not insert the power plugs for many products at the same time.</b></p> <ul style="list-style-type: none"> <li>• May cause abnormal generation of heat or fire.</li> </ul> <div style="text-align: center;">  </div>	<p><b>Set the power plug free from the back side of the refrigerator.</b></p> <ul style="list-style-type: none"> <li>• Damaged power plug may cause fire due to overheating.</li> </ul> <div style="text-align: center;">  </div>	<p><b>Do not directly spray water inside or outside of the refrigerator</b></p> <ul style="list-style-type: none"> <li>• May cause fire or electric shock.</li> </ul> <div style="text-align: center;">  </div>
<p><b>Do not spray inflammable gas near the refrigerator.</b></p> <ul style="list-style-type: none"> <li>• May cause explosion or fire.</li> </ul> <div style="text-align: center;">  </div>	<p><b>Do not bend the power cord with excessive force or do not have the power cord pressed by heavy article.</b></p> <ul style="list-style-type: none"> <li>• May cause fire or electric shock.</li> </ul> <div style="text-align: center;">  </div>	<p><b>Do not store a volatile and inflammable substance in the refrigerator.</b></p> <ul style="list-style-type: none"> <li>• Storage of benzene, thinner, alcohol, ether, LP gas, etc., may cause explosion.</li> </ul> <div style="text-align: center;">  </div>

**! WARNING**

**Do not put a container filled with water on the product.**

- If water poured, it cause bad insulation of the electric parts which may lead to fire or electric shock.

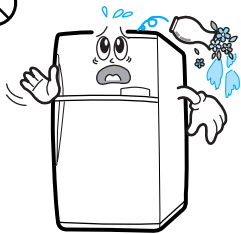

**Do not install the refrigerator in the wet place or the place which water splashes.**

- Deterioration of insulation of electric parts may cause electric shock or fire.

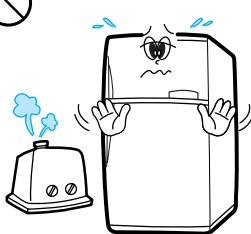

**Do not insert the power plug with the wet hand.**

- May cause electric shock.

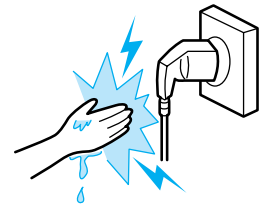

**Do not disassemble, repair or alter.**

- It may cause fire or abnormal operation which leads to injury.

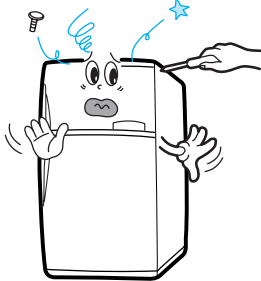

**Pull the power plug out for exchanging the interior lamp of the refrigerator.**

- It may cause electric shock.

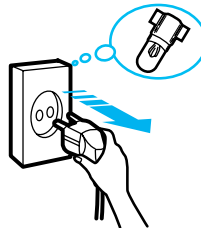

**Be sure to earth.**

- If earthing is not done, it will cause breakdown and electric shock. (Please refer to page 6).

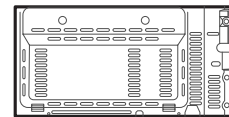

**If and when gas leaks, immediately ventilate without touching the refrigerator and the plug.**

- Explosion of gas may cause fire and a burn.

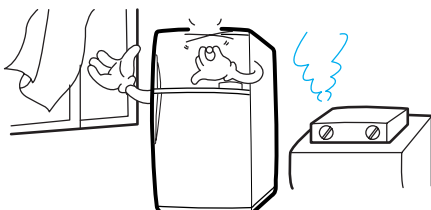

**Dispose refrigerator after door or door's packing is removed, if disposition is required.**

- It is dangerous for child to enter the refrigerator for play-in with door closed.

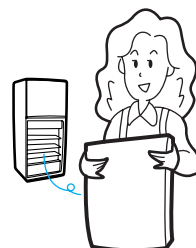

# CAUTION FOR SAFETY



CAUTION

## Do not store too much foodstuffs therein.

- Opening of the door may cause pouring over which may inflict a wound.



## Do not store narrow and lengthy bottles or foods in a small multi-purpose room.

- It may hurt you when refrigerator door is opened and closed resulting in falling stuff down.



## If the hole of the power plug socket is loose, do not insert the power plug.

- It may cause electric shock and fire.

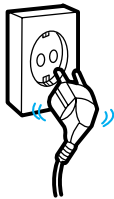

## Do not put bottles or kinds of glass in the freezing room.

- Freezing of the contents may inflict a wound.



## Do not store articles on the product.

- Opening or closing of the door may cause throwing down which may inflict a wound.



## Do not pluck out the power cord by pulling the portion of it.

- Damage of the cord portion may cause fire and electric shock.

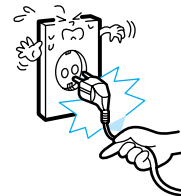

## Do not let a child be hung down from the door.

- Injury may occur, when the product falls down or a finger is jammed in the door.

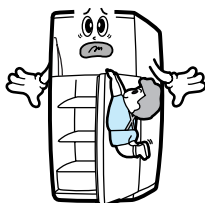

## Do not store pharmaceutical products, scientific materials, etc., in the refrigerator.

- The products which temperature control shall be strict shall not be stored in the refrigerator.



**CAUTION**

**Do not touch the container and the food stuffs of the freezing room with the wet hand.**

- It may cause frostbite.



**Do not enter the hand into the bottom surface of the product.**

- Sharp edge may inflict a wound.

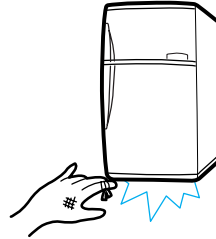

**Please wipe out foreign materials of the metal option of the power plug cleanly.**

- Use of it as it is may cause fire.

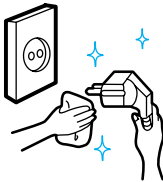

**If you want to insert the power plug again, please insert it five minutes after pulling out of the plug socket.**

- Abnormal operation of freezing device may cause breakdown of it.

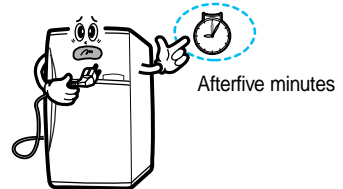

**Move it by catching the upper handle of rear side and the lower handle of front side.**

- Slippery is caused to hurt, when other part is grasped.

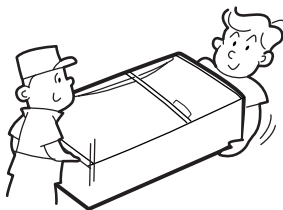

**Use handle when opening and closing the refrigerator door.**

- In case of using other parts than handle, it may hurt you with your finger jammed.

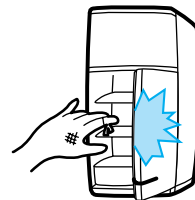

**If the refrigerator is not to be used for a long time, pull out the power plug.**

- Due to deterioration of insulation, may cause fire.



**When abnormal sound, smell or smoke is noticed, pull a power plug off immediately, then call service center.**

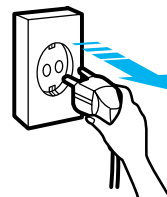

# PREPARATIONS PRIOR TO USE

## 1

The refrigerator should be installed on flat floor leaving adequate space.

- Unusual noises or poor cooling may arise when the unit is not levelled.

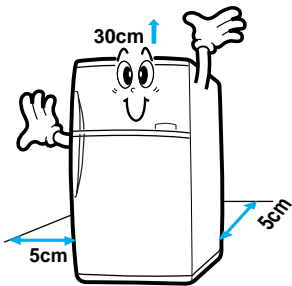

## 2

Clean up the refrigerator

- Wipe out the inner and outer parts of the unit with a dish cloth which was squeezed dry.

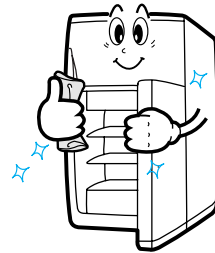

## 3

Insert a power plug into the exclusive receptacle.

- Earth connection should be done.
- It is recommended to connect power one hour after installation.

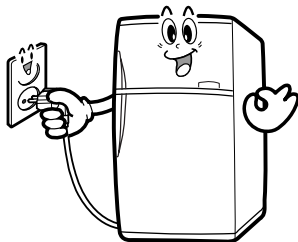

## 4

Put foods into the refrigerator.

- It is recommended to put foods into the unit after plugging-in 2 or 3 hours before stuffing to allow cooling in the unit.

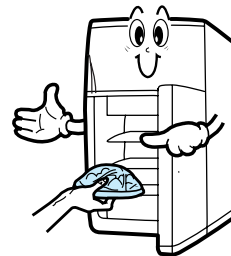

### Grounding method

- Grounding should be done to prevent short circuit or electric shock resulting from the electricity leaking from the refrigerator.
- Do not ground with gas pipe, telephone line or lightning arrester without fail because of being very dangerous when lightning strikes.



**In case of the exclusive electric outlet with a grounding terminal.**

- In case of electric outlet with a grounding terminal, it does not require a separate grounding connection.

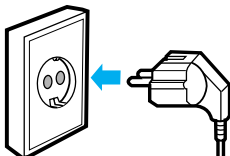

**In case of the electric outlet without a grounding terminal.**

- Connect the "grounding wire" to the copper plate, and bury it in the wet ground 25cm deeper.

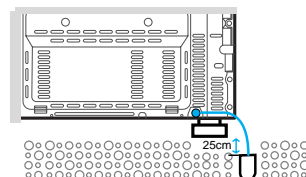

# HOW TO STORE FOODS CORRECTLY

**Store watery foods in front of shelf of refrigerating room.**

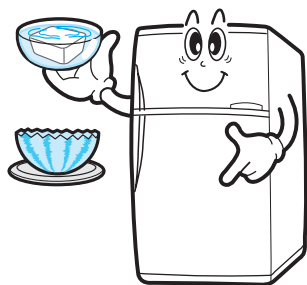

**Cool the hot foods, then store them.**

- Electric charges will reduce and cooling will be much effective provided that hot foods are cooled.

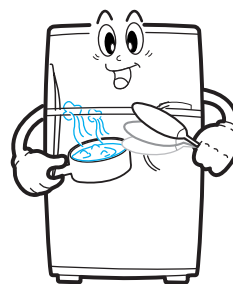

**Do not store the foods which are perishable at low temperature.**

- i.e.: Banana, Pineapple, Tomato etc



**Put foods at proper space.**

- In case of cooling outlet plugged, storing effect of food decreases because of poor circulation of cold.

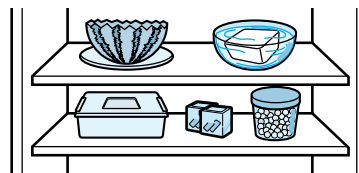

**It is recommended to store in a vessel with cover or after wrapping-up with a vinyl sheet.**

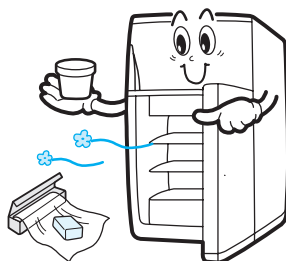



# INSTALLATION METHOD

Allowing a 5cm space on the right, left and back sides when installing the unit, makes you have an advantage in saving power consumption.

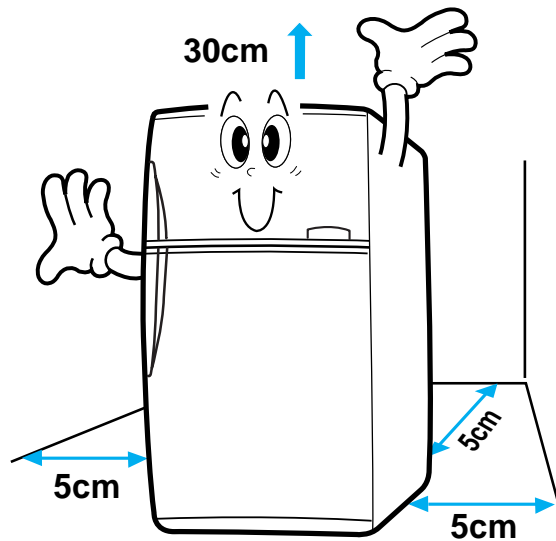

## LEVEL THE REFRIGERATOR

When you install the front of the unit on a little higher level, its door can be easily opened and closed.

**1**

**When the door is sagged to the left, downward.**

Turn the left adjusting leg to the arrow direction and level the unit.

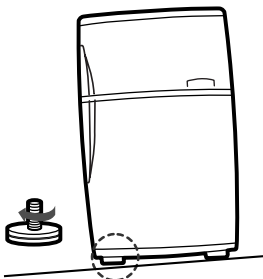

**2**

**When the door is sagged to the right, downward.**

Turn the right adjusting leg to the arrow direction and level the unit.

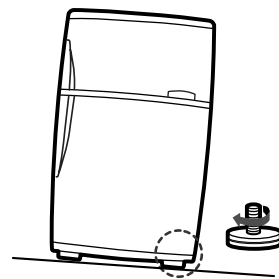

# HOW TO USE FREEZING ROOM

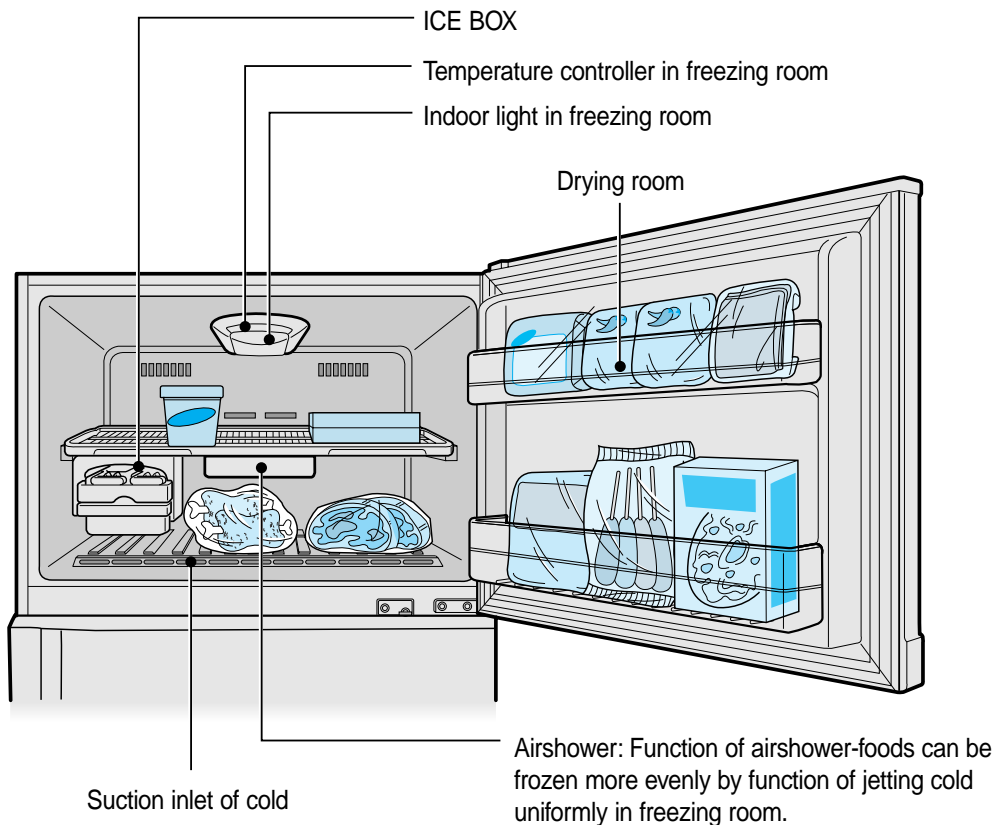

## HOW TO PRODUCE ICE

1

Pour water into ice box at a level of water(Arrow).

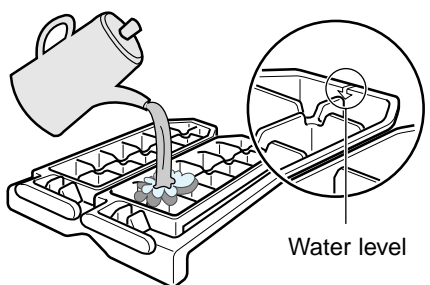

2

Put the ice box in the air shower shelf of the freezing room.

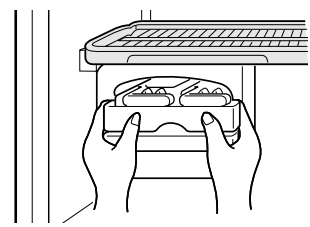



---

## HOW TO CONTROL TEMPERATURE IN FREEZING ROOM

---

### **HIGH:**

**When storing much quantity of foods to be frozen, or producing ice quickly.**

- Adjust the temperature controller in the freezing room to the "HIGH" position.
- 

### **HIGH to LOW:**

**When using in average.**

- Adjust the temperature controller in the freezing room between "HIGH" and "LOW" position.
- 

### **LOW:**

**When storing few quantity of foods to be frozen.**

- Adjust the temperature controller in the freezing room to the "LOW" position.



### **REFERENCE**

- Put the foods to be stored for a long time in the freezing room, such as ice cream, fish, and meat, etc.
- It is recommended to store the dried foods in the dry room, such as dried fish, pepper powder which dislike humidity.

**In the following case, smell may arise from ice.**

- Storing the uncovered meat or fish.
- Storing the uncovered dried foods such as dried cuttle fish, anchovy, laver and other dried fish.
- Storing foods packed with the smelling package such as vinyl.

# HOW TO USE REFRIGERATING ROOM

Temperature controller in refrigerating room (HIGH-LOW)

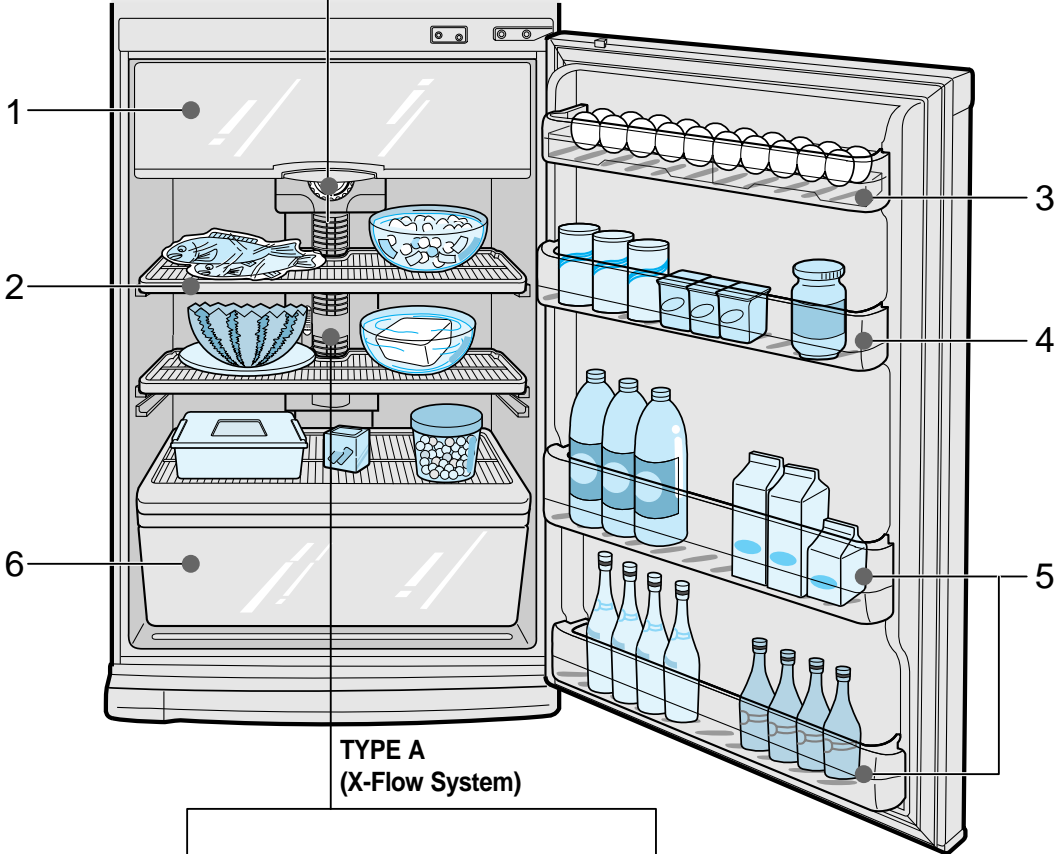

**TYPE A**  
(X-Flow System)

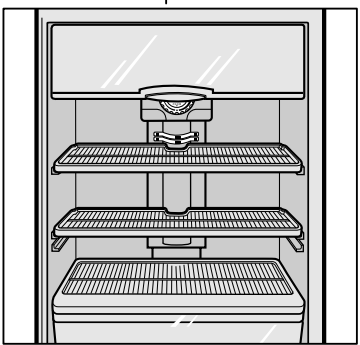

**TYPE B**  
(Multi Flow System)

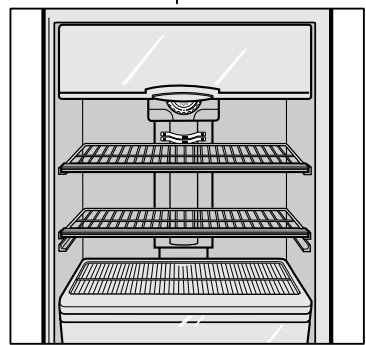

**TYPE C**  
(Multi Flow System+Wire Shelf)

  
**REFERENCE**

Frequent opening of refrigerator door may produce dew inside of the unit.



---

## HOW TO CONTROL TEMPERATURE IN REFRIGERATING ROOM

---

### **HIGH:**

**When storing much quantity of foods to be refrigerated or not being cold enough.**

- Adjust the temperature controller in refrigerating room to the "HIGH" position.
- 

### **HIGH to LOW:**

**When using in average.**

- Adjust the temperature controller in refrigerating room between "HIGH" and "LOW" position.
- 

### **LOW:**

**When the food refrigerated are frozen, or the foods are in a small quantity.**

- Adjust the temperature controller in refrigerating room to the "LOW" position.



### **REFERENCE**

In case surrounding temperature is less than 5°C, the temperature should be lower than average to prevent the stored foods against getting frozen.



## HOW TO STORE FOODS FOR REFRIGERATION

**1**

### High-humidity special room

- Store the foods which are just ready for cooking such as meat, fish and raw fish, and are slightly frozen.

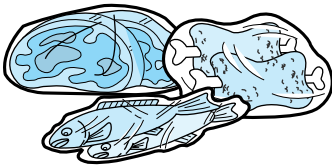

**2**

### Shelf of refrigerating room

- Store the side dishes contained in storage vessels and other storage foods at suitable intervals.

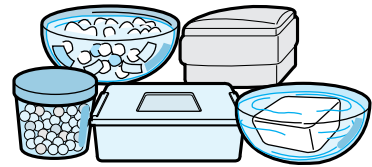

**3**

### Egg tray

- Store eggs.
- Egg tray may be used as a multipurpose room only by removing the egg tray.

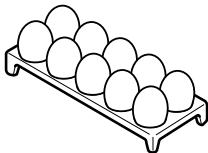

**4**

### Guard variety

- Store the small-packed storage foods like butter, milk, yogurt etc. and beverages.

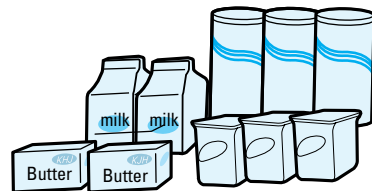

**5**

### Jumbo Guard bottle

- store beer, 1L milk, juice in the lower part, and 1.5L or 2.0L vessel or water bottle in the upper part.



**6**

### High-humidity vegetable room

- The rail style high-humidity vegetable box is a cased indirect cooling system to reach the foods with cold. So that origin moisture is maintained for a long time.

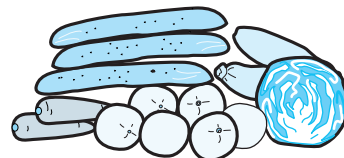

# HOW TO DISASSEMBLE ACCESSORIES

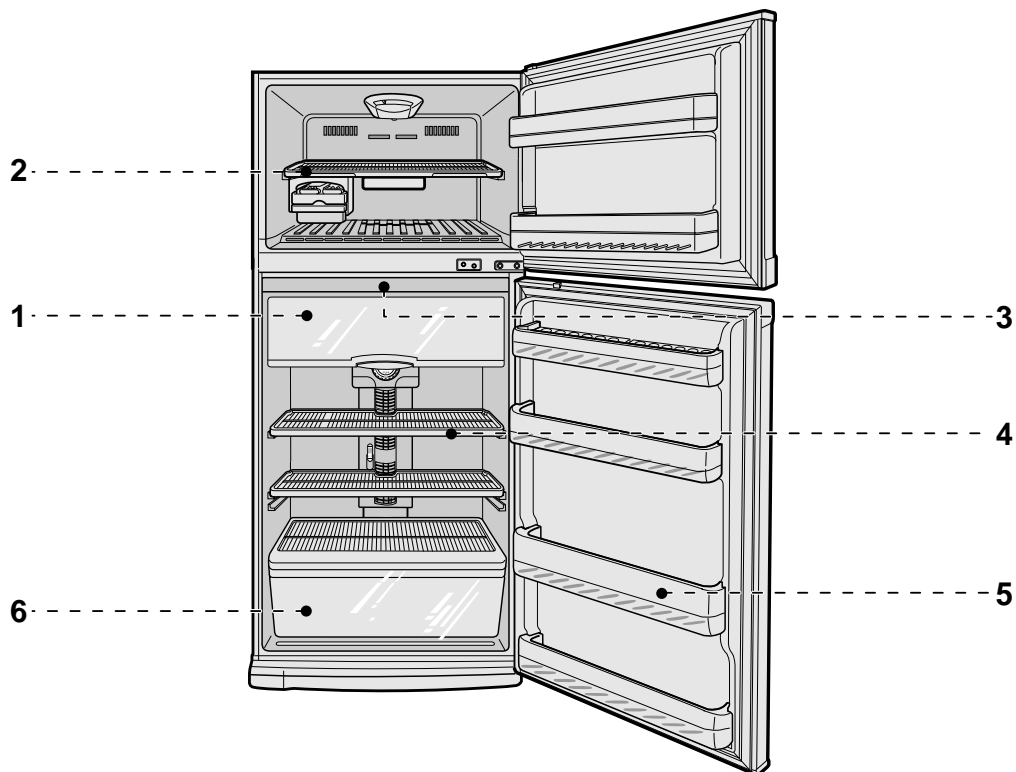

## 1

### Shelf of High humidity special room

- Lift upward the special room cover, and push the right side (No. ①) inward to remove, and remove the left side (No. ②) toward arrow, then pull it.
- While removing the special room shelf toward arrow, lift it upward at the hanging point for removal.
- Lift slightly the front part of special room shelf, and insert roller between rails, then push it.
- Insert the left part (No. ①) of special room as direction of arrow, and pull the right hanging part (No. ②) inward as direction of arrow until inserting.

#### Procedure of disassemble

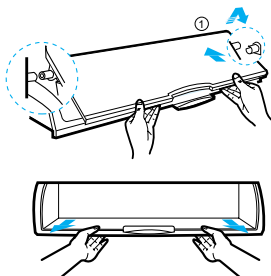

#### Procedure of assemble

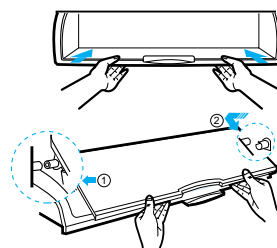

**2****Shelf of freezing room**

- First, remove ice box, and lift the front part of the shelf and pull out to remove it.

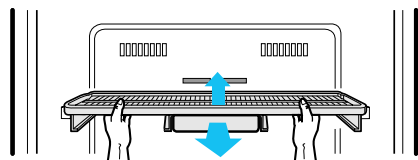
**3****Bio deodorizing device**

- Press and remove downward the end part of hanging jaw in front of Bio deodorizing device located on the top of refrigerating room.

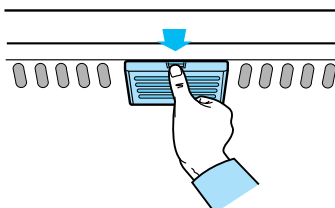
**4****Shelf of refrigerating room**

- Hold the front part of the shelf in refrigerating room, and pull it forward until removing.

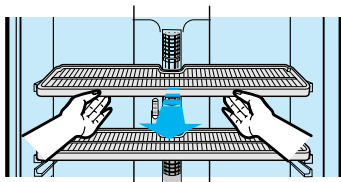
**5****Beverage room**

- Lift it upward, then remove it.

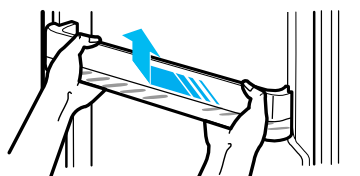
**6****Cover and box of vegetable room**

- Lift upward and remove the vegetable box, and pull the vegetable box forward to the middle, then remove it raising it upward.

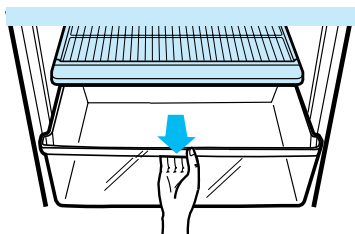



# CLEANING METHOD

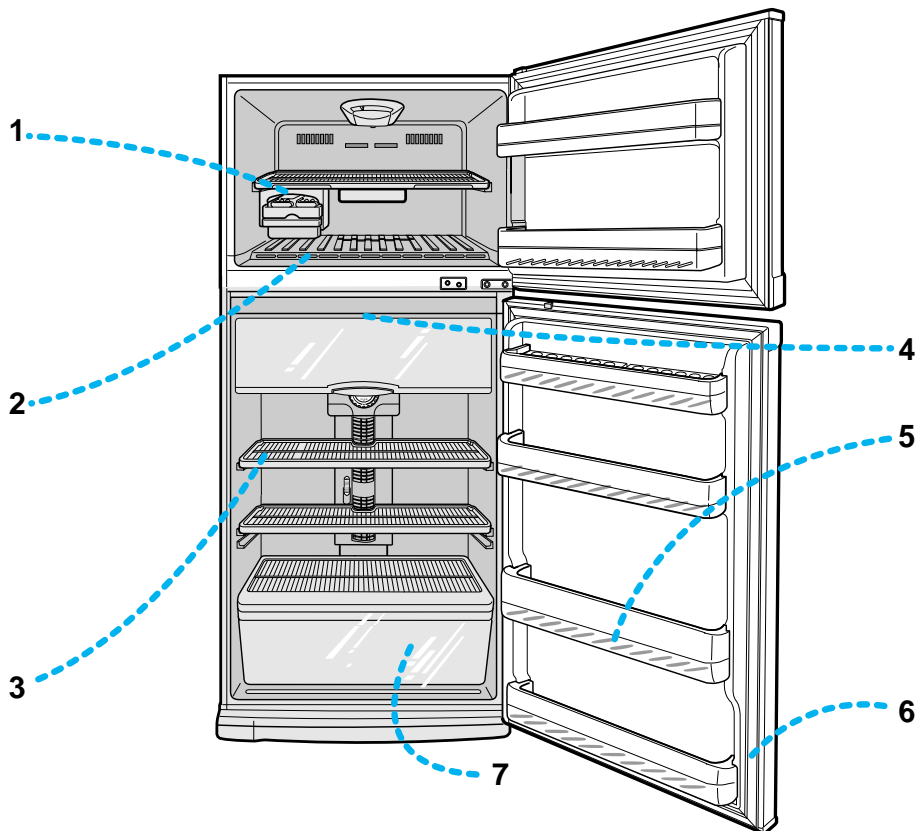

**1**

## Ice cube maker

- Clean up the ice cube maker with water after pulling it out.

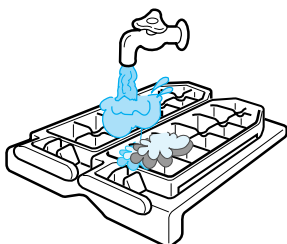

**2**

## Suction inlet of cooling air in freezing room.

- Wipe the suction inlet with a dried cloth according to vertical texture not to cover with alien substance.

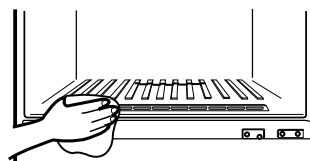

**3****Shelf of refrigerating room.**

- Remove the shelf of refrigerating room, then clean it up using water and detergent.

**4****Bio Deodorizer**

- If the refrigerating room smells bad, please separate the Bio deodorizer, soak the catalyst in pure water and dry it to sunlight before use.

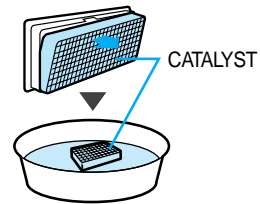
**5****Guard bottle**

- Wash the guard bottle with water after pulling it out.

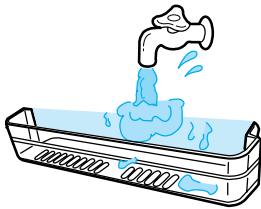
**6****Rubber packing**

- Clean up the rubber packing with a dish cloth which is wet with detergent, and between grooves with a wooden chopstick wrapped up by a cut of cloth.

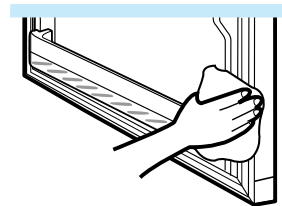
**7****High-humidity ware vegetable**

- Wipe out the vegetable drawer using a wet cloth after pulling it out.

**Warning**

- Disconnect the power plug and open the door for dry when cleaning or out of operating for a long time.
- Do not spray water for clean-up, and do not use benzene or thinner, either.

# PROCEDURE OF INSTALLATION



## CAUTIONS WHEN INSTALLING

### 1

**Do not put the inflammables into the unit.**

- Flammable sprays may cause fire.
- Plugging-out is dangerous while leaking gas.

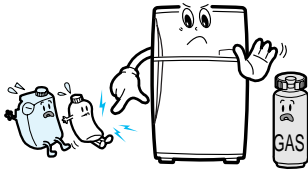

### 2

**Avoid heat sources or moisture.**

- Rusting or decolorating may happen.

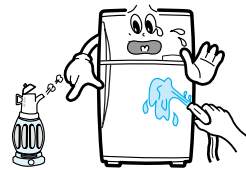

### 3

**Do not store goods on the top or rear.**

- Poor circulation of air may affect cooling function because heat does not escape.
- Do not put things on the top of the refrigerator because they are liable for dropping down.

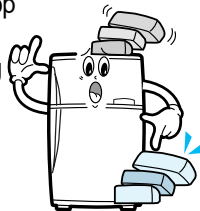

### 4

**Install the unit in the place where surrounding temperature is low.**

- Cooling efficiency gets better.
- The unit should be away from the direct sunray.

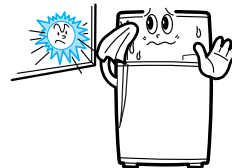

## REPLACING METHOD OF INDOOR LIGHT



- Pluck out the power cord, first.

### CAUTION

### 1

**Indoor light of freezing room.**

- insert driver into the rear groove of light cover, and pull it forward,

then remove it downward.

After replacing the light, insert the front part first, and then the rear part by fixing the groove.

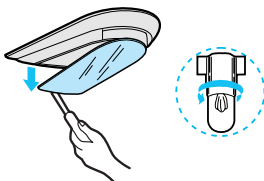

### 2

**Indoor light of refrigerating room.**

- Remove the shelf of special room.

Press the top of the light cover with driver, and pull it forward lowering a little, then replace the indoor light after removing the cover.

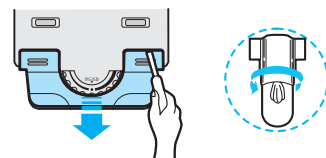

# CAUTIONS WHEN USING

**1**

**Do not put bottles or kinds of glass in the freezing room.**

- Freezing of the contents may inflict a wound.

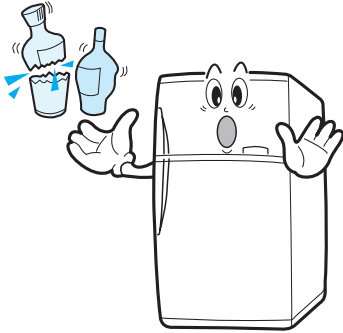

**2**

**Do not bend the power cord with excessive force or donot have the power cord pressed by heavy article.**

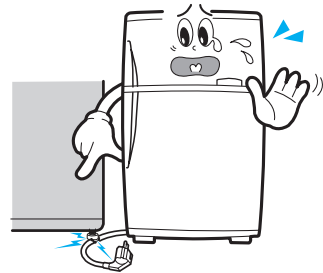

**3**

**Do not let a child be hung down from the door.**

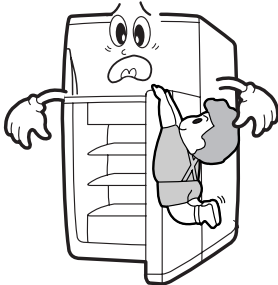

**4**

**Cool the hot foods, then store them.**

- Electric charges will reduce and cooling be much effective provided that hot foods are cooled.

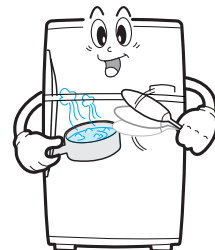

**5**

**Store watery foods in front of shelf of refrigerating room.**

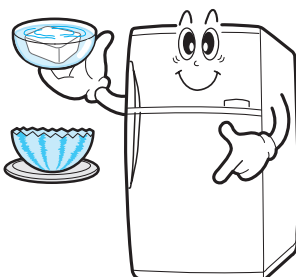

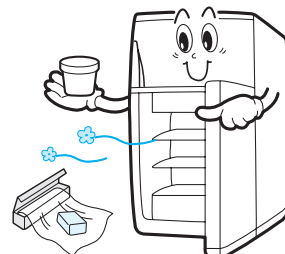

**6**

**Foods should be stored in a vessel with cover or after wrapping-up with a vinyl sheet.**

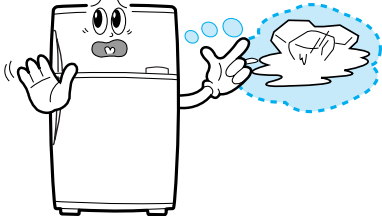
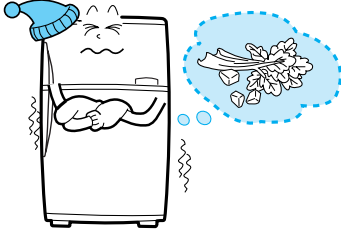
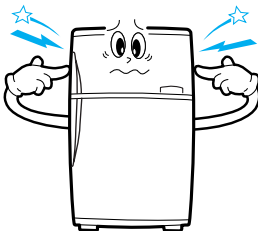
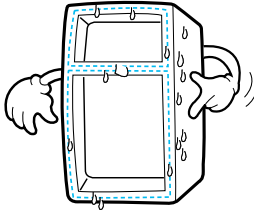

# CHECKS PRIOR TO SERVICE REQUEST

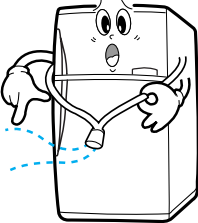
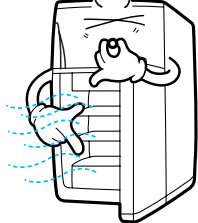
SYMPTOMS	CHECKS
<p><b>The unit is not operating at all, or refrigerating weakly.</b></p> 	<ul style="list-style-type: none"> <li>• Check if power plug is connected well.</li> <li>• Is the temperature control in front operating part "LOW"?</li> <li>• Does sun shine on the unit, or are there heat sources near by?</li> <li>• Is there the back of the unit too near to the wall?</li> </ul>
<p><b>The foods in the refrigerator are frozen</b></p> 	<ul style="list-style-type: none"> <li>• Is the temperature control in front operating part "HIGH"?</li> <li>• Is the surrounding temperature too low?</li> <li>• Did you put the watery foods into the cold inside?</li> </ul>
<p><b>There are unusual noises</b></p> 	<ul style="list-style-type: none"> <li>• Check if the unit is installed on a firm or weak floor.</li> <li>• Is there the back of the unit too near to the wall?</li> <li>• Is any foreign material dropped behind or under the unit?</li> <li>• Isn't the noise from the compressor in the unit?</li> <li>• Sound of "ticking" may be heard from the unit's inside, but it is not out of order. This sound comes when various accessories are contracted or expanded by cooling function.</li> </ul>
<p><b>The front corners and sides of the unit are getting hot and dewdrops form thereon.</b></p> 	<ul style="list-style-type: none"> <li>• Heat-proof pipes are installed in the front corners of the unit to prevent forming dew. When the surrounding temperature rises, there might be not feeling in some cases. However, this is not abnormal.</li> <li>• In high humid weather, dewdrops might form on the outer surface of the unit with the result that the moisture in the air contacts with the cool surface of the unit.</li> </ul>

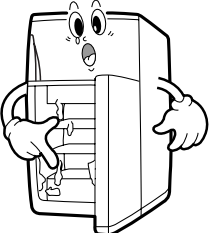
SYMPTOMS	CHECKS
<p data-bbox="123 335 543 360"><b>There are babbling of water in the unit</b></p> 	<ul data-bbox="722 335 1243 393" style="list-style-type: none"> <li>• This is a babbling of refrigerant which refrigerates the inside of the unit.</li> </ul>
<p data-bbox="123 701 498 727"><b>There is odoring inside of the unit</b></p> 	<ul data-bbox="722 701 1275 825" style="list-style-type: none"> <li>• You did not seal the foods which had an odor.</li> <li>• When it smells bad, please clean the bio deodorizer.</li> <li>• Store the odoring foods after they are covered, and clean up the cold inlet.</li> </ul>
<p data-bbox="123 1068 585 1093"><b>There is a layer of frost in the unit's walls.</b></p> 	<ul data-bbox="722 1068 1191 1162" style="list-style-type: none"> <li>• Isn't the air outlet of the unit plugged?</li> <li>• Keep the foods spaced to be ventilated well.</li> <li>• Isn't the door closed fully?</li> </ul>
<p data-bbox="123 1434 694 1493"><b>Dew forms on the inside wall of the unit and around ware vegetable.</b></p> 	<ul data-bbox="722 1434 1254 1558" style="list-style-type: none"> <li>• When the watery foods are stored without cover in the high humid surrounding, or with the door opened for a long time.</li> <li>• Store the foods with cover or sealed.</li> </ul>

# ANSWER TO THE QUESTION



## WHAT IS BIO DEODORIZER?

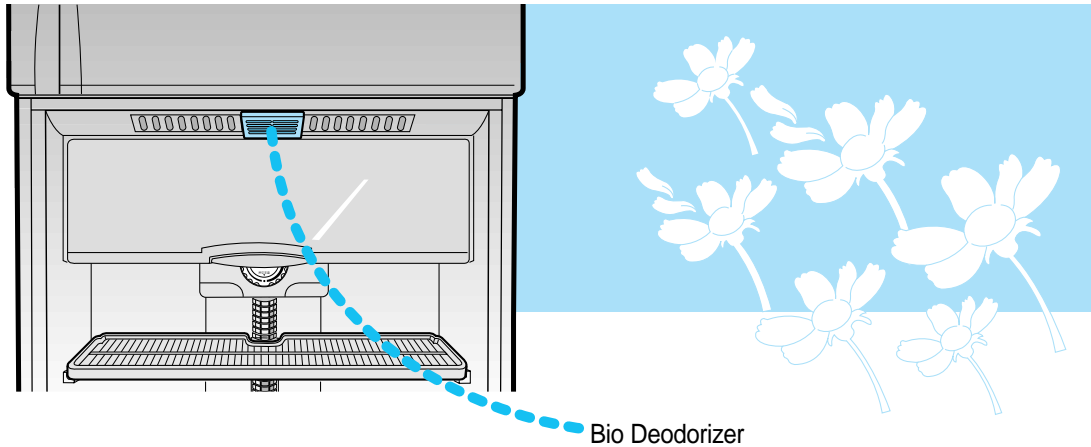

Bio Deodorizer

**1**

The Bio deodorizer is installed to the suction inlet of cold in the refrigerator so that air circulates automatically without any assist and removes food smell.

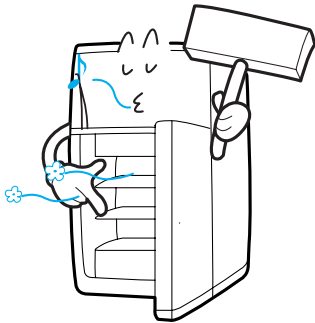

**2**

This deodorizer is designed to absorb and dissolve completely, and its ability of depolarization is excellent. In particular, it excludes the smell with which the Korean favored foods are easily soaked.

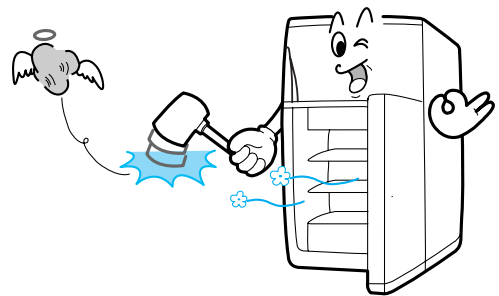

### REFERENCE

- The Bio deodorizer's life span is semi-permanent.
- The function of the Bio deodorizer is not harmful to the storage foods or person at all, but is used only to remove the smell from the storage foods in the refrigerator.



### CAUTION

- For the storage of the food which have a strong smell, store it using lap or putting in a covered container, because it may have a decreased effect of depolarization resulting from soaking smell into the refrigerator wall or other foods.





## Free Manuals Download Website

<http://myh66.com>

<http://usermanuals.us>

<http://www.somanuals.com>

<http://www.4manuals.cc>

<http://www.manual-lib.com>

<http://www.404manual.com>

<http://www.luxmanual.com>

<http://aubethermostatmanual.com>

Golf course search by state

<http://golfingnear.com>

Email search by domain

<http://emailbydomain.com>

Auto manuals search

<http://auto.somanuals.com>

TV manuals search

<http://tv.somanuals.com>