

**SAMSUNG**

# OWNER'S INSTRUCTIONS

**SR-608EV/648EV/688EV** (dispenser Applied)  
**606EV/646EV/686EV**



## REFRIGERATOR

Before operating the unit, please read this manual thoroughly,  
and retain for future reference.

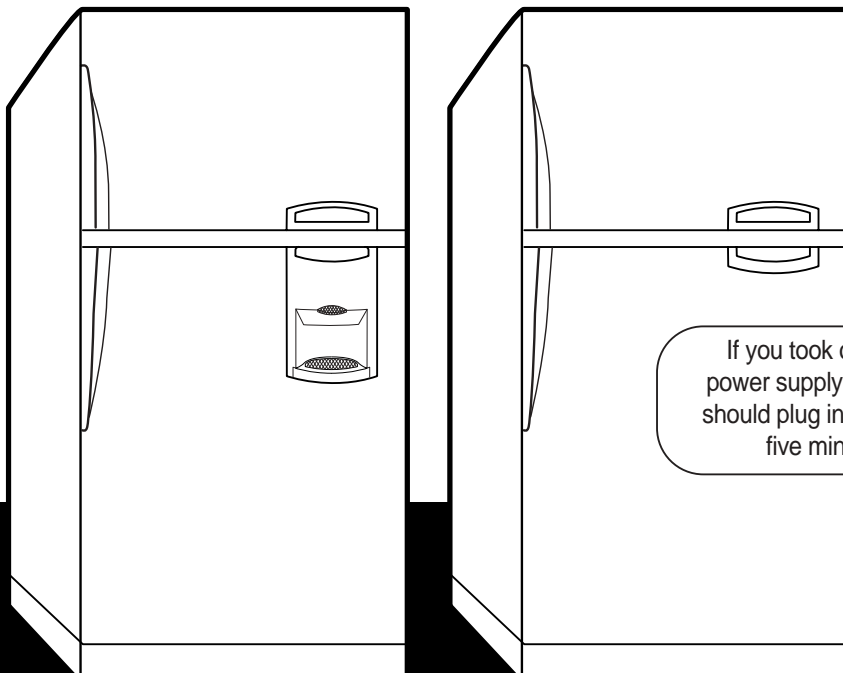

If you took out of the  
power supply outlet, you  
should plug in again after  
five minutes.

# FEATURE

## What is H.M.CYCLE(High-efficiency Multi-evaporator CYCLE)?

- A high efficiency cooling method adopting an independent cooler and an independent cooling fan in freezing room and refrigerating room, respectively.
- A new cooling method providing an economic energy, power cooling function and supply of high humidity cool air by independent cooler and cooling fan.

## What is sensitivity technology?

- A theory for meeting the sensuous demands from consumers by supplying the cool air that suits their tastes for preserving foods. Neuro-fuzzy genic algorithm theory was applied so that the optimum uniform refrigeration can be maintained by automatically activating the rotating fan for distribution of cool air at the locations where foods are stored and supplying the cool air quickly to places where it is mostly needed.

## What is genic algorithm (GA-FUZZY)

- A theory that senses the inside temperature of refrigerator with temperature sensor and controls it to be in an optimum state of uniform refrigeration by applying the genetic principle of natural ecosystem, i.e the law of the fittest Øs survival and training to Micom.

# CONTENTS

---

## Ready to use

Contents .....	1
Warnings for safety .....	2
Cautions for safety .....	4
Features .....	6
Ready to use .....	8
Front operating panel.....	10

## How to use

How to use freezing room.....	12
How to use refrigerating room .....	14
How to preserve the refrigerated foods.....	17
Functions of water dispenser.....	19

## Installation and cares

How to clean .....	21
How to disassemble and assemble the water supply device.....	23
How to disassemble the accessories .....	26
How to install .....	27

## Before asking for service

Before asking for service .....	31
Questions .....	33

**! WARNING**

**Do not put a tank filled with water on the product.**

- If water poured, it cause bad insulation of the electric parts which may lead to fire or electric shock.

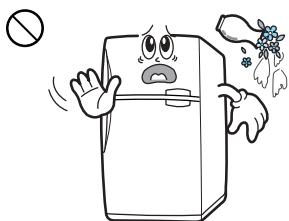

**Do not install the refrigerator in the wet place or the place which water splashes.**

- Deterioration of insulation of electric parts may cause electric shock or fire.

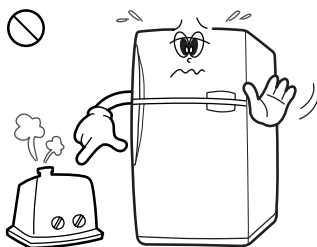

**Do not insert the power plug with the wet hand.**

- May cause electric shock.



**Do not disassemble, repair or alter.**

- It may cause fire or abnormal operation which leads to injury.

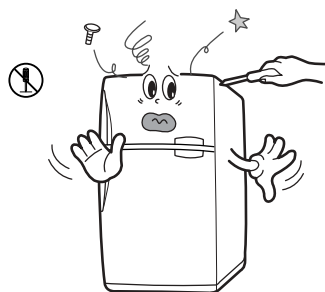

**Pull the power plug out for exchanging the interior lamp of the refrigerator.**

- It may cause electric shock.

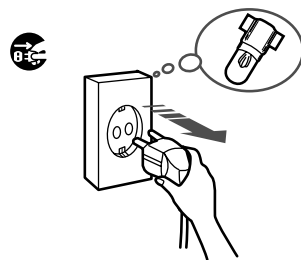

**Be sure to earth.**

- If earthing is not done, it will cause breakdown and electric shock. (Please refer to page 29.)

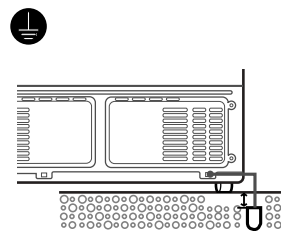

**If and when gas leaks, immediately ventilate without touching the refrigerator and the plug.**

- Explosion of gas may cause fire and a burn.

**Dispose refrigerator after door or door's packing is removed, if disposition is required.**

- It is dangerous for child to enter the refrigerator for play-in with door closed.

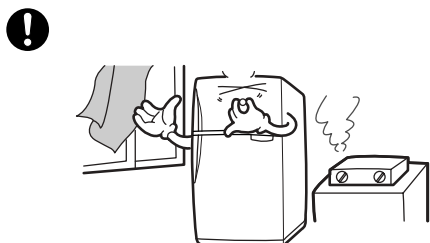

**CAUTION**

**Do not touch the tank and the food stuffs of the freezing room with the wet hand.**

- It may cause frostbite.



**Do not enter the hand into the bottom surface of the product.**

- Sharp edge may inflict a wound.

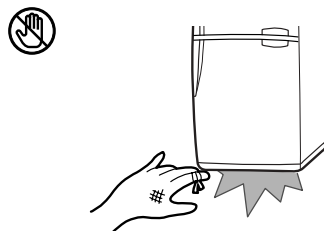

**Please wipe out foreign materials of the metal option of the power plug cleanly.**

- Use of it as it is may cause fire.

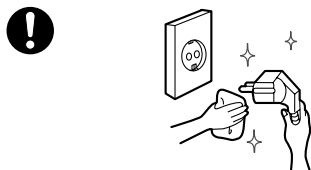

**If you want to insert the power plug again, please insert it five minutes after pulling out of the plug socket.**

- Abnormal operation of freezing device may cause breakdown of it.

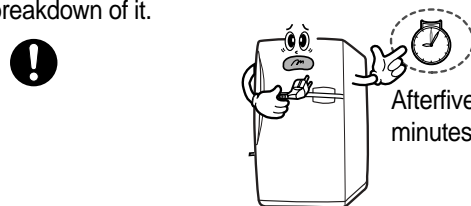

**Move it by catching the upper handle of rear side and the lower handle of front side.**

- Slippery is caused to hurt, when other part is grasped.

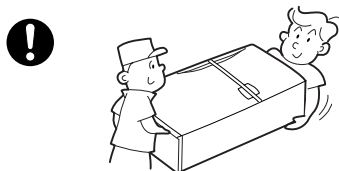

**Use handle when opening and closing the refrigerator door.**

- In case of using other parts than handle, it may hurt you with your finger jammed.

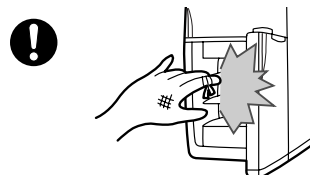

**If the refrigerator is not to be used for a long time, pull out the power play.**

- Due to deterioration of insulation, mau cause fire.

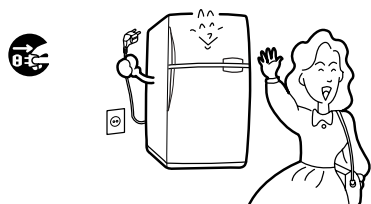

**When abnormal sound, smell or smoke is noticed, pull a power plug off immediately, then call service center.**

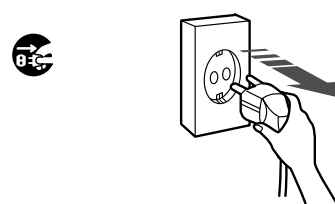



---

## **SEPARATE AND INDEPENDENT COOLING OF REFRIGERATING AND FREEZING ROOMS!**

---

### **Refrigerator of energy-saving type**

- It adopts the high-efficiency Multi-evaporator CYCLE that makes it possible to cool the refrigerating room and freezing room separately and to reduce the power consumption and energy.

---

### **Super-power cooling technique for quick refrigeration.**

- Selection of power freezing and power refrigerating by independent cooler and cooling fan allows the quick cooling and preserving the freshness of foods.(pages 13, 15)

---

### **Natural humidity vegetable room lasting 3 times longer even without vinyl wraps.**

- The independent cooling method is supplying the cool air with 4°~5 times of more humidity than conventional refrigerator through the indirect cooling technique by which the cool air can not touch the vegetables and fruits directly and therefore the freshness with the same natural humidity as that of producing areas can be maintained for a long time



---

## **NATURALISM FOR REFRIGERATORS, TOO!**

---

### **Refrigerator that does not destroy the ozone layer!**

- It uses the new insulating materials, the new refrigerant (R-134A) whose ODP(Azone Depletion Potential) is zero



## THE CORRECT WAY OF PRESERVING FOODS.

**Please keep them after washing.**



**Please store foods after dividing into small pieces.**

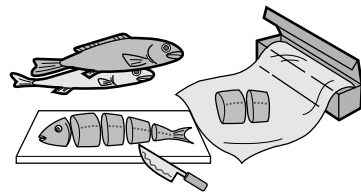

**Please do not store foods which are apt to go bad in low temperature.**

(Examples : Bananas, Pineapples, Tomatoes etc.)

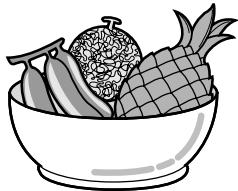

**Please place watery foods(particularly bean curds) on the front area of shelf in refrigerating room.**

- It may be possible that foods placed on areas where cool air is coming out are frozen.

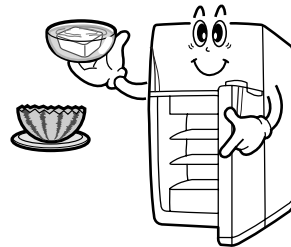

**Please arrange foods with proper distance each other.**

- If the exit of cool air is blocked, the storing efficiency gets low due to the bad cool air circulation.

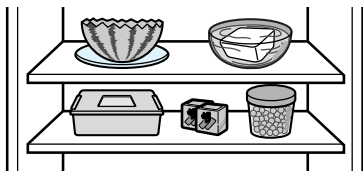

**Please cool off the hot foods before putting them in the refrigerator.**

- It reduces power consumption and also makes a better cooling.

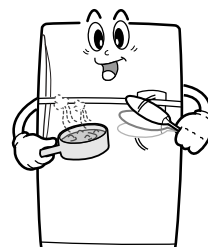



## DISPLAY PANEL

1

### High moisture refrigerating function

A high moisture refrigerating display lamp is always on when the refrigerator is in operation.

- The refrigerator adopted separate coolers in freezing and refrigerating rooms, respectively, that can supply a high moist cool air and therefore it can preserve the foods in fresh state.

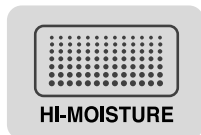

2

### Door-alarm function (Door opening)

A warning sound(Dingdong-Dingdong) indicates that door is open.

- In case the door is open wider than 15°, after 2 minutes the warning sounds for about 10 seconds with about 1 minute interval.



3

### Deodorizing display lamp

This lamp is always on when the refrigerator is in operation.

Without any specific operation, the refrigerator remains in deodorizing mode while air is circulating.

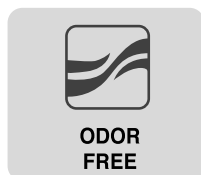

4

### Display of super X-flow function

If temperature in refrigerating room is getting high with a lot of foods in it or the door is open, the half-circle red lamps in the center turn on in automatic sequence.

- You do not have to worry about any leakage of cool air even though the door is open because the rotating cool air is moving around foods in center.
- The display lamp is on when the temperature in refrigerating room gets uniform since the cooling is made quickly by the rotation cooling technique.



### Power savings of indoor lamp

- When the door is open for over 10 minutes, the indoor lamps automatically go off.



---

## POWER FREEZING/TEMPERATURE CONTROL OF FREEZING ROOM

---

The artificial intelligent function keeps the adjusted temperature of freezing room in the optimum state conforming with conditions of use.

### Power freezing(Quick freezing)

**When you want to freeze foods at a fast speed or to get ice quickly,**

- The red lamp is on when selecting Power freezing by pressing “QUICK FRE” Button
- Please press the button one more time if you want to cancel “QUICK FRE”

---

### LOW

**When the amount of foods to be stored is small,**

- Please select “LOW” by pressing FRE. control button.
- Whenever pressing the button at “LOW”, temperature is set in sequence of “LOW MID → MID”.

---

### MID

**When using it normally,**

- Please select an appropriate position between “LOW” and “MID” or “MID” and “HIGH”, depending on the amount of foods to be stored and frequency of use.
- “MID” is the normal position.
- The temperature is changed in sequence of “MID HIGH → HIGH” whenever pressing the button at “MID”.

---

### HIGH

**When making ice or there are a lot of foods to be stored.**

- Please select “HIGH” by pressing the temperature control button.
- When pressing one more time at “HIGH”, “LOW” is selected.



- Whenever pressing the temperature control, the temperature setting is changed in sequence of “LOW” → MID LOW → MID → MID HIGH → HIGH” and it goes to “LOW” when pressing the button one more time at “HIGH”.
- Since power freezing function is automatically completed, it is automatically transferred, after power freezing, to the previous temperature setting before the power freezing function is operated. (Example : If it had been used in “LOW” mode, it automatically goes back to “LOW” after completing “POWER FREEZING”.
- “MID” of freezing room is automatically set after initial power supply or power failure.





---

## POWER REFRIGERATION/TEMPERATURE CONTROL OF REFRIGERATING ROOM

---

The artificial intelligent function keeps the adjusted temperature of refrigerating room in an optimum state conforming with conditions of use.

### Power refrigeration

#### When you want to cool the foods quickly.

- The red lamp is on when selecting POWER REFRIGERATING by pressing "QUICK ref" button
  - Please press the button one more time for cancelling power refrigeration.
- 

### LOW

#### When foods are frozen or the quantity of foods is small,

- Please select "LOW" by pressing the temperature control button
  - Whenever pressing the button at "LOW", the temperature setting is changed in sequence of "LOW MID → MID".
- 

### MID

#### When in normal use or storing Kimchi,

- Please select an appropriate position between "LOW" and "MID" or "MID" and "HIGH", depending on the quantity of foods to be stored and frequency of use.
  - "MID" is the normal position.
  - Whenever pressing the button from "MID", the temperature setting is changed in sequence of "MID HIGH → HIGH".
- 

### HIGH

#### When refrigeration is bad or there are a lot of foods to be stored,

- Please select "HIGH" by pressing the temperature control button.
- When pressing one more time from "HIGH", the temperature is set to "LOW".

# HOW TO PRESERVE THE REFRIGERATED FOODS

## 1 High humidity special fresh room (chilled Room)

- Please use this room for foods to be stored in colder environments than refrigerating room.
- \* Please keep meat or fish in freezing room for its long storage.

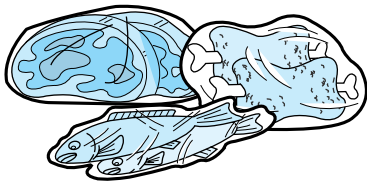

## 2 Re-enforced glass shelf

- Please keep the side dish foods in storage bowl or other refrigerated foods with a proper distance apart.
- \* The shelf in refrigerating room is a re-enforced glass one unliable to destruction even when falling down, making sure of its safe use.

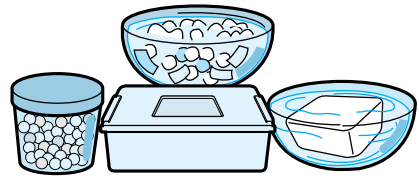

## 3 Eggs carrier

- Please keep eggs in the eggs carrier.
- \* The products with water dispensers (Models applied: SR-608EV/648EV/668EV) contains two eggs carriers. (Refer to figure of page 14)

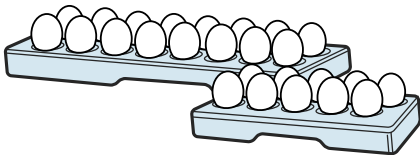

## 4 Space for multi-use

- Please use this space for storing butter, milk, yogurt in small package or drinks.

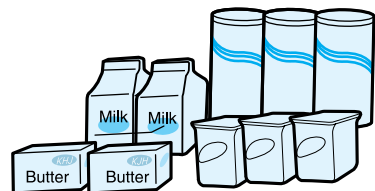

# FUNCTIONS OF WATER DISPENSER

**Models applied : SR-608EV/648EV/688EV**

What is the water dispenser? If a water tank full of water and equipped with water supply device is inserted into the location where the water supply lever in the refrigerating room is connected to, the cold water can be available at the outside of door even without opening the door by pressing the water supply lever.

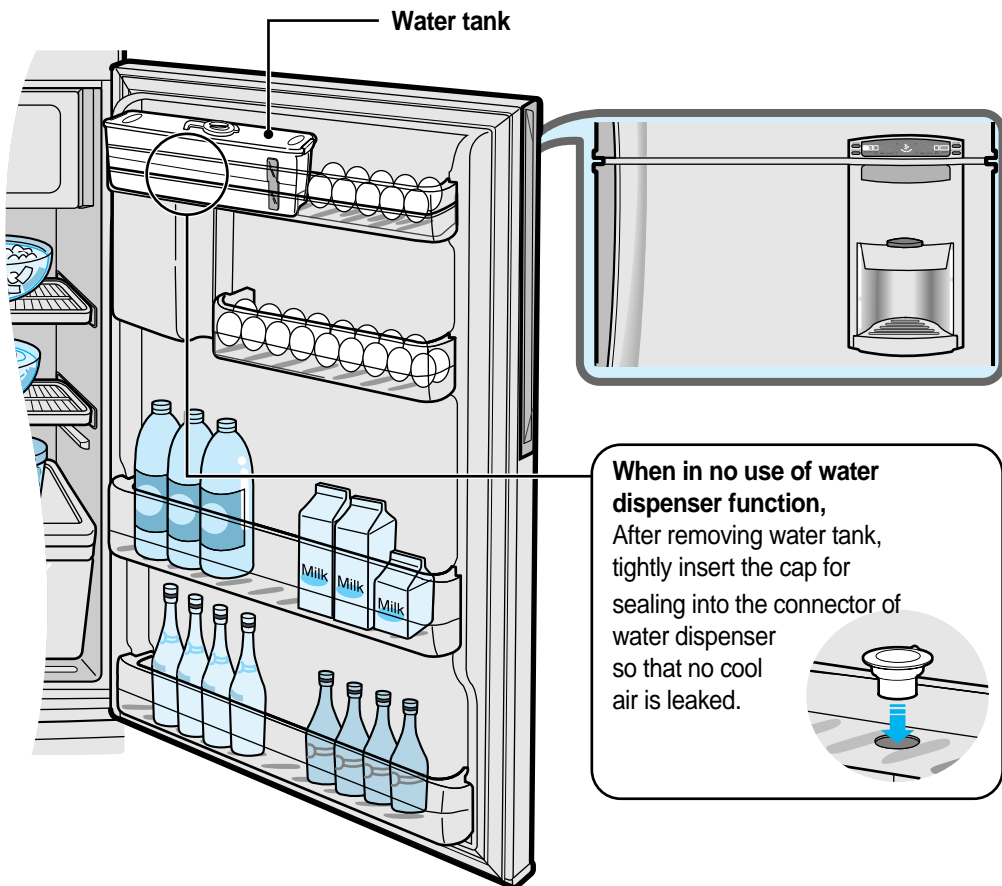

- Please drain the water completely from water tank by pressing the water supply lever after emptying it when in no frequent use of water dispenser.
- Please do not use juice or soda drinks because water tank or water supply system can be polluted by their sugar contents. When it was used with those drinks, please make sure to wash it with clean water.
- A cold water will be available right after the cold water stored in refrigerating room in advance is put into water tank.
- Please clean the water tank frequently after it was filled with tea etc. for a long time since the water tank is subject to change of color or smell and also the residues of tea may cause an abnormal operation of water dispenser.

# HOW TO CLEAN



## HOW TO CLEAN WATER DISPENSER (MODELS APPLIED : SR-608EV/648EV/688EV)

1

Please separate the large lid from water tank after pulling it out.

- It can be separated from water tank when pulling up both hand-grips of large lid.

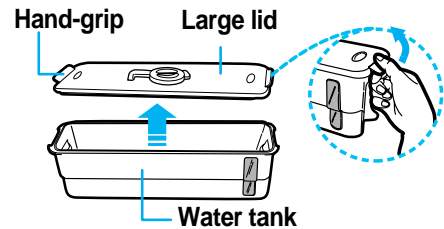

2

Please separate the water tank from water supply device.

- Please hold the upper part of water supply device and turn it to arrow direction.

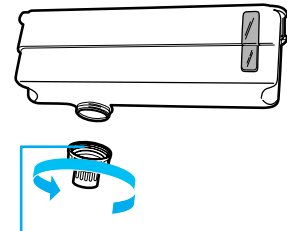

Water supply device

3

After washing water tank and large lid with neutral detergents, please rinse them with water.

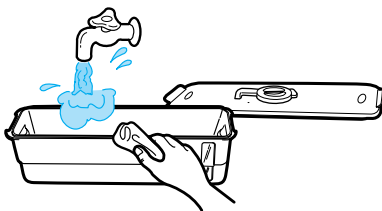

4

Please clean the water supply device with a soft brush.

- Please disassemble and clean once in a while.

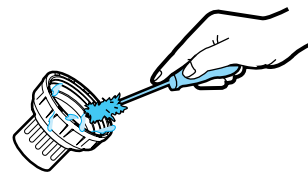

5

How to use water-spout

- Please frequently throw away water collected on the water-spout and wipe it out with dry cloth after separating it from cup platform by slightly pressing "PUSH".

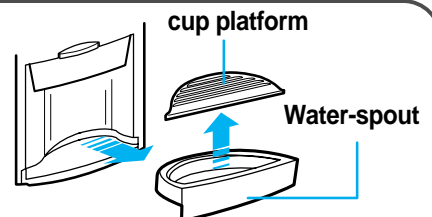

Caution

- Please do not boil the water supply device in hot water of over 60°
- Please be careful not to damage or lose the water supply device.
- Please do not let children mishandle the water supply lever. It may cause the water overflow or any trouble.

# HOW TO DISASSEMBLE AND ASSEMBLE THE WATER SUPPLY DEVICE

When you want to further clean every corners of the water supply device, disassemble and assemble it after cleaning as follows.



## HOW TO DISASSEMBLE (MODELS APPLIED : SR-608EV/648EV/688EV)

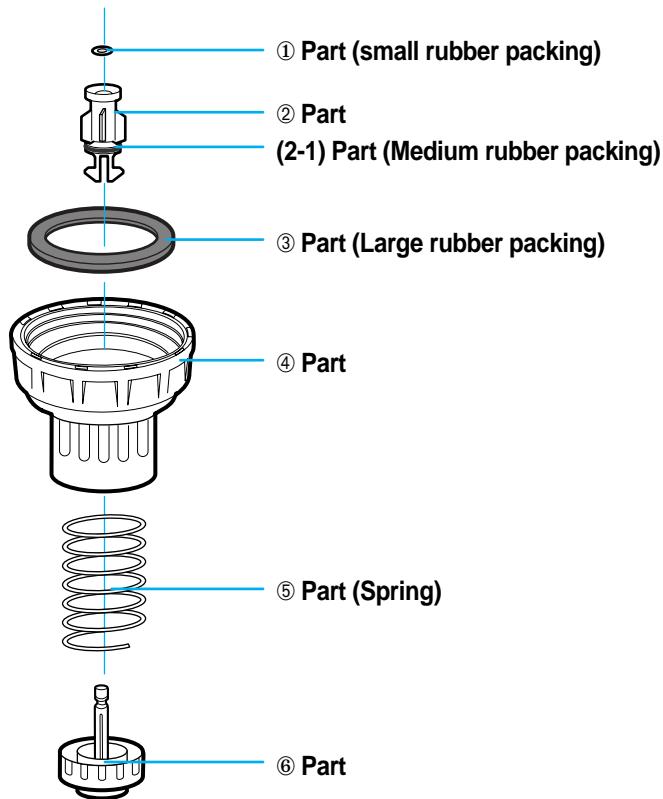



## HOW TO ASSEMBLE

1

Fit the ③part, while pressing it, into ④part.

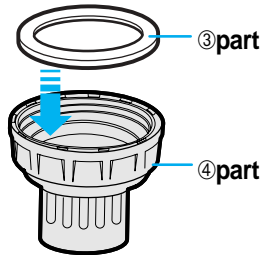

2

Fit the locking part of ②part into the hole of ④part.

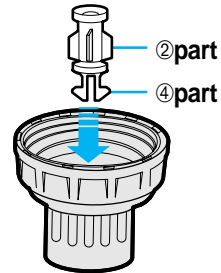

3

Insert ⑤part and ⑥part into ④part.

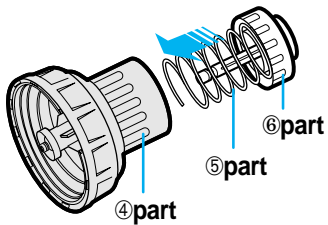

4

Insert the long portion of ⑥part into the hole of ②part.

- At this time, the popping portion of ⑥part has to be fitted into the grooves of ②part.

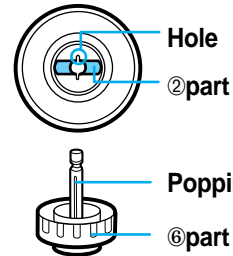

5

Insert ⑧ part while pressing the lower end of ⑧ A part.

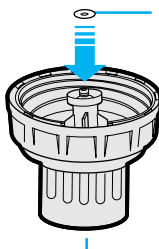

Caution

- Be careful not to recklessly pull out spring or not to make the spring stretched.
- Water leakage may be caused by filling water tank with water or by pressing water supply lever if rubber packing or rubber ring were missing while assembling. Assemble all parts in steps without missing any one of them.

# HOW TO INSTALL



## HOW TO ADJUST LEVELING

### Adjust the leveling of refrigerator.

- If the refrigerator is so installed to make its front a little high, the door can be easily opened and closed.

1

#### Refrigerator leaning to the left.

Make leveling by filling ⊖ driver into the groove of adjustable leg on the left side and turning it to arrow direction.

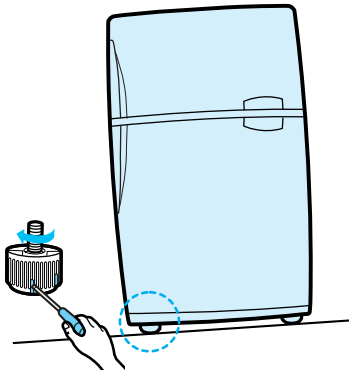

2

#### Refrigerator leaning to the right

Make leveling by fitting ⊖ driver into the groove of adjustable leg on the right side and turning it to arrow direction.

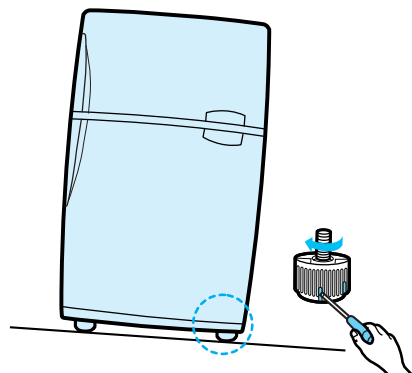



## HOW TO GROUND

### The refrigerator should be grounded.

The purpose of grounding is to prevent any power leakage or electric shock caused by the current leakage from the refrigerator.

\* Never ground to gas pipes, telephone line and lightning rod as it is very dangerous at the time of lightning strikes.

#### In case of outlets without ground terminals.

- Bury the ground cable connected to a copper plate into the ground with plenty of moistures at the depth of over 25CM, or use a power source which is equipped with circuit breakers.

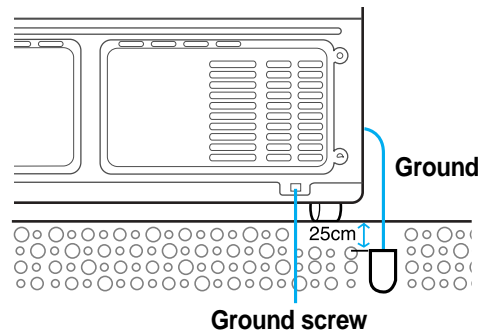

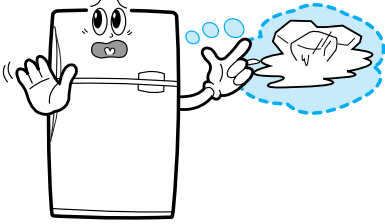
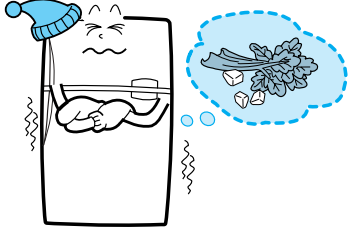
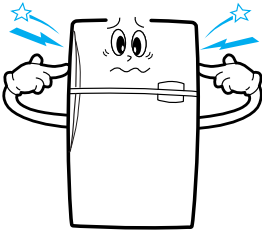
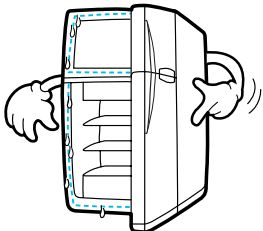

# BEFORE ASKING FOR SERVICE

SYMPTIOMS	CHECK
<p><b>Non-operation or bad refrigeration</b></p> 	<ul style="list-style-type: none"> <li>• Check the connection of power plug.</li> <li>• Isn't the temperature control lamp of front operating panel in "LOW" mode?</li> <li>• Isn't there sunshine or heat directly applied to refrigerator.</li> <li>• Isn't the rear plate of refrigerator too close to the wall?</li> </ul>
<p><b>Foods in refrigerating room are frozen</b></p> 	<ul style="list-style-type: none"> <li>• Isn't the temperature control lamp of front operating panel in "HIGH" mode?</li> <li>• Isn't the environmental temperature around the installing place too high?</li> <li>• Isn't the watery foods put into the inside of refrigerator when the cool air is coming out?</li> </ul>
<p><b>Noises and strange sound</b></p> 	<ul style="list-style-type: none"> <li>• Check if the floor is not flat or not hard.</li> <li>• Isn't the rear plate of refrigerator too close to walls?</li> <li>• Is there any stuffs fallen down at rear or beneath of refrigerator?</li> <li>• Isn't it the sound of compressor within the product?</li> <li>• The sound of "TICK TICK" from inside of refrigerator is the one to be heard when various parts are contracted or expanded by cooling operation, therefore it does not mean any trouble with it.</li> </ul>
<p><b>Too hot at the front corner and side wall areas of refrigerator. Dew are forming</b></p> 	<ul style="list-style-type: none"> <li>• This is because heat pipe is installed at the front corner to prevent dew-forming. It is likely to feel that the temperature on these area is very high in the environmental conditions of high exterior temperature. However, it does not mean any trouble with it.</li> <li>• It happens that dews form on the outer wall of refrigerator under the high humidity environment. This is because the moisture in the air touches the cold surface of refrigerator.</li> </ul>

# QUESTIONS



## WHAT IS THE LOW TEMPERATURE CATALYZING DEODORIZER?

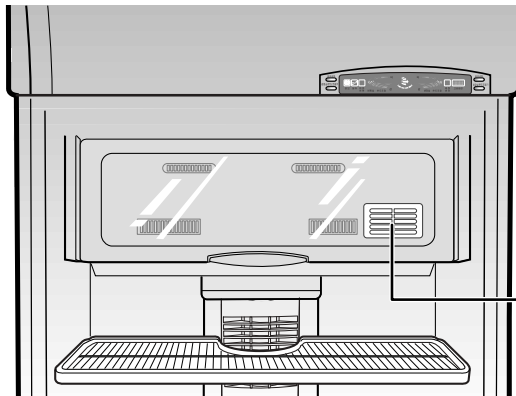

Low temperature catalyzing deodorizer

1

Low temperature catalyzing deodorizer is installed at cool air suction hole where the air of refrigerating room is sucked, therefore, even without any additional operation, smells are removed while air is in a natural circulation.

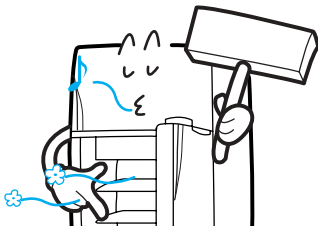

2

It is so designed as to suck and completely remove smells. Also it has an excellent capability of deodorizing the bad smell of the favorite foods particularly at home.

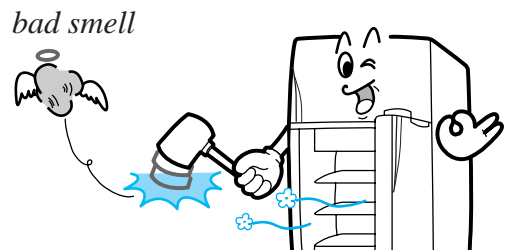

Caution

- Low temperature catalyzing deodorizer has a semi-permanent lifetime.
- The function of low temperature catalyzing deodorizer has no harmful effect on human bodies and is applied only to remove smells from the stored foods within the refrigerator.



NOTE

- Use wraps or sealed tank when preserving foods with much smells. Deodorizing effect may be reduced as the smells are adhered to inner wall of refrigerator or to other foods.

**English**

**Correct Disposal of This Product (Waste Electrical & Electronic Equipment)  
(Applicable in the European Union and other European countries with separate collection systems)**



This marking shown on the product or its literature, indicates that it should not be disposed with other household wastes at the end of its working life. To prevent possible harm to the environment or human health from uncontrolled waste disposal, please separate this from other types of wastes and recycle it responsibly to promote the sustainable reuse of material resources.

Household users should contact either the retailer where they purchased this product, or their local government office, for details of where and how they can take this item for environmentally safe recycling.

Business users should contact their supplier and check the terms and conditions of the purchase contract. This product should not be mixed with other commercial wastes for disposal.



## Free Manuals Download Website

<http://myh66.com>

<http://usermanuals.us>

<http://www.somanuals.com>

<http://www.4manuals.cc>

<http://www.manual-lib.com>

<http://www.404manual.com>

<http://www.luxmanual.com>

<http://aubethermostatmanual.com>

Golf course search by state

<http://golfingnear.com>

Email search by domain

<http://emailbydomain.com>

Auto manuals search

<http://auto.somanuals.com>

TV manuals search

<http://tv.somanuals.com>