



# USER MANUAL

SR - S20...

SR - S22...

## FRIDGE/FREEZER

Before operating the appliance, please read this manual thoroughly and retain it for future reference.

# FEATURES

## Energy-saving fridge/freezer

- Power consumption is kept to a minimum by distributing cool air separately to the refrigerator and freezer.

## Faster cooling times

- The quick freezing function allow you to freeze food more quickly.

## High humidity for fresher food

- You can keep food, fruit and vegetables fresh for longer because your refrigerator supplies highly humidified cold air. This can be up to four or five times more effective than a normal refrigerator.

## Door alarm

- When the refrigerator door is left open for more than two minutes, a musical alarm is automatically triggered. This feature helps you save electricity and preserve stored foods.

## Abundant supply of ice and cold water

- The ice and water dispenser provides ice and cold water at any time.

## Extra refrigerating compartment

- You do not have to open the main door to access frequently used food in the extra refrigerating compartment. This saves time and money.



## What is the H. M. Cycle (High-efficiency, Multi-evaporator Cycle)?

- The refrigerator and freezer have separate evaporators. Given this independent system, the refrigerator and freezer are cooled individually as required and are, therefore, more efficient. Food odour from the refrigerator does not affect food in the freezer because the two are not connected.

# CONTENTS

FEATURES .....	2
SAFETY WARNINGS .....	2
INSTALLING THE APPLIANCE .....	4
PREPARING THE APPLIANCE .....	5
FRONT CONTROL PANEL .....	6
CONTROLLING THE FREEZER AND REFRIGERATOR TEMPERATURES .....	7
ICE/COLD WATER DISPENSER .....	9
STORING FOOD .....	10
VIEW OF YOUR FRIDGE/FREEZER .....	11
REMOVING THE FREEZER ACCESSORIES .....	12
REMOVING THE REFRIGERATOR ACCESSORIES .....	13
EXTRA REFRIGERATING COMPARTMENT .....	13
CLEANING THE ACCESSORIES .....	13
CHANGING THE INTERIOR LIGHT .....	14
ICE-MAKING FILTER .....	15
PROBLEMS AND SOLUTIONS .....	15

# SAFETY WARNINGS

## CAUTION/WARNING SYMBOLS USED

 <b>WARNING</b>	Indicates that a danger of death or serious injury exists.
 <b>CAUTION</b>	Indicates that a risk of personal injury or material damage exists.

## OTHER SYMBOLS USED

	Represents something you must NOT do.
	Represents something you must NOT disassemble.
	Represents something you must NOT touch.
	Represents something you must observe.
	Indicates that you must disconnect the power plug from the socket.
	Represents something that must be earthed to prevent electric shock.

**These warnings are to prevent injury to users or other persons. Please observe them. After reading the warnings, keep them in a safe place for future reference.**



## WARNING



**Do not use the fridge/freezer with a multi-plug adapter.**

- This causes a potential fire hazard.

**Make sure that the power plug is not squashed or damaged by the back of the fridge/freezer.**

- A damaged power plug may overheat and cause a fire.

**Do not allow water to splash or run on to the fridge/freezer.**

- There is a risk of fire or electric shock.

**Do not use aerosols near the fridge/freezer.**

- There is a risk of explosion or fire.

**Do not place heavy articles on the power cord.**

- There is a risk of a short circuit and fire.

**Do not insert the power plug with wet hands.**

- You may receive an electric shock.

**Do not put a container filled with water on the appliance.**

- If spilled, there is a risk of fire or electric shock.

**Do not install the fridge/freezer in a damp place or a place where it might be splashed with water.**

- Deteriorated insulation of the electric parts may cause electric shock or fire.

**Do not store volatile or inflammable substances in the refrigerator.**

- The storage of benzene, thinner, alcohol, ether, LP gas and other such products may cause explosions.



**Do not disassemble, repair or alter the appliance.**

- You run the risk of causing a fire, malfunctions and/or personal injury.



**Pull the power plug out before changing the interior light of the refrigerator.**

- Otherwise, there is a risk of electric shock.



**If you wish to dispose of the fridge/freezer, first remove the door and its seals.**

- If a child plays in the appliance, the door can close and the child can become trapped. The child will die from suffocation.

**Be sure to earth the appliance.**

- If the appliance is not properly earthed, it may break down or cause electric shock.



## CAUTION



**Do not overfill the refrigerator with food.**

- If food falls out when you open the doors, there is a risk of personal injury and/or material damage.

**Do not put bottles or glass containers in the freezer.**

- When the contents freeze, the glass may break and cause personal injury.

**If the power plug socket is loose, do not insert the power plug.**

- There is a risk of electric shock or fire.



**Do not remove the power cord by pulling on its lead.**

- Damage to the cord may cause a short-circuit, fire and/or electric shock.
- If the power cord is damaged, it must be replaced by the manufacturer, a certified service agent or qualified service personnel.

**Do not store articles on the appliance.**

- When you open or close the door, the articles may fall and cause personal injury and/or material damage.

**Do not store medicine, scientific materials and temperature-sensitive products in the refrigerator.**

- Check product labels to make sure that refrigeration is not prohibited.

**Do not let children hang from the door.**

**If you detect abnormal sounds, smells or smoke, pull out the power plug immediately and contact your SAMSUNG Electronics service centre.**



**Do not touch the inside walls of the freezer or products stored in the freezer with wet hands.**

- It may cause frostbite.

**Do not put your hands under the fridge/freezer.**

- Sharp edges may cause personal injury.

**Never put fingers or other objects into the dispenser opening and ice chute.**



**Do not use a wet or damp cloth when cleaning the plug. Remove any foreign matter from the power plug pins.**

- There is a risk of burning and fire.

**If you wish to move the fridge/freezer, hold it by the back and bottom handles.**

- If the appliance is disconnected from the power supply, you should wait for at least five minutes before plugging it back in.



**If the fridge/freezer is not to be used for a long time, pull out the power plug.**

- Any deterioration in the insulation may cause fire.

# INSTALLING THE APPLIANCE

Allow a clearance of 1 cm to the right, left and back when installing the appliance; this has the advantage of reducing power consumption.

1

## Allow sufficient space to install the appliance on a flat surface.

- If your appliance is not level, the internal cooling system may not work correctly.

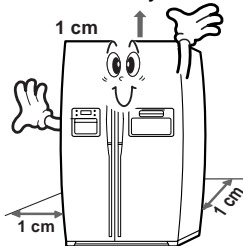

2

## Clean your fridge/freezer.

- Wipe the inside and outside of your fridge/freezer with a dry cloth.

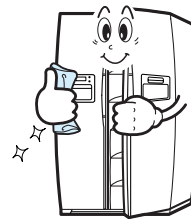

3

## Store food in the refrigerator.

- Wait for at least two or three hours after plugging your appliance in before storing food and other items in it.

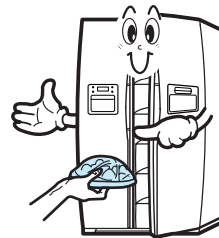

## LEVELLING

When you adjust the level of the fridge/freezer, set the front legs slightly higher than the rear legs, so that you can open and close the door more easily.

First disassemble the leg cover and then adjust the level of the fridge/freezer.

1

If your fridge/freezer tilts to the left, turn the left adjusting screw.

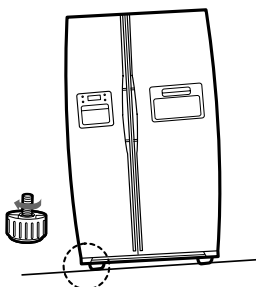

2

If your fridge/freezer tilts to the right, turn the right adjusting screw.

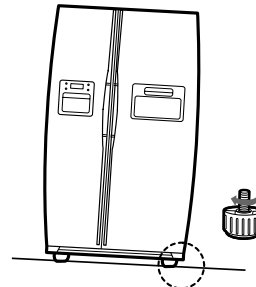



## EARTHING THE APPLIANCE



### WARNING

#### The appliance must be earthed.

You must earth the fridge/freezer to prevent any power leakage or electric shock caused by current leakage from the appliance.

- Never use gas pipes, telephone lines or other potential lightning rods as earths.

#### You are using a power plug without earth.

- Connect one end of the earthing wire (yellow/green or green) to the earthing screw and the other end to a steel or copper pipe, such as a water pipe.

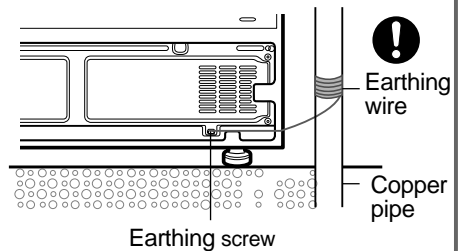

## PREPARING THE APPLIANCE

Once you have performed the following steps, your fridge/freezer should be fully operational. If not, check the power supply and electricity source. If you have any doubts or problems, contact your SAMSUNG service centre.

1

Place the shelves and containers which were removed for transport in their appropriate positions (refer to pages 10 to 12).

4

Set the temperature control to the coldest temperature and wait for one hour. The freezer should get slightly chilled and the motor should run smoothly producing a soft humming noise.

2

Clean the fridge/freezer and accessories to remove any dust that accumulated during packing and shipping (refer to page 13).

5

Once the refrigerator temperature is sufficiently low, you can store food in the appliance. It takes a few hours after starting the fridge/freezer to reach the appropriate temperature.

3

When the refrigerator is plugged in, the interior light should come on each time you open the refrigerator door.

Your fridge/freezer is operated by a compressor which switches "on and off" to maintain the internal temperature. When the compressor is new, it requires a running-in period, which can last for up to five months. During this period, it may be slightly noisy. This is quite normal and does not represent a fault.

# FRONT CONTROL PANEL

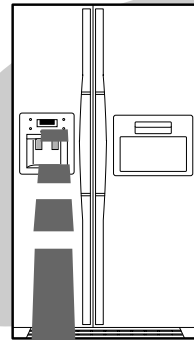
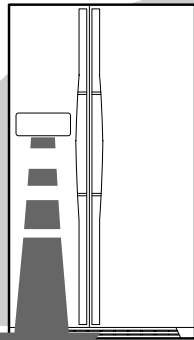

## Basic model

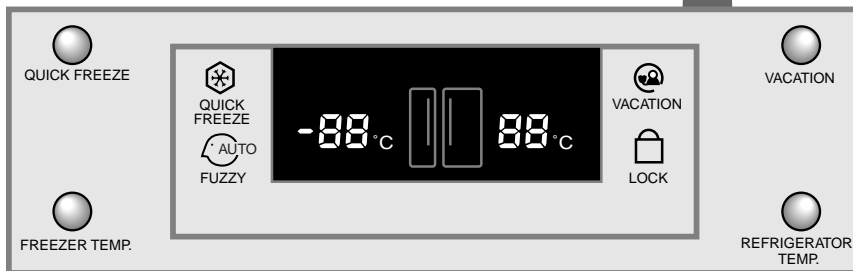

## Model with ice and water dispenser



### FREEZER TEMPERATURE BUTTON

Sets the freezer temperature. Press the button repeatedly to change the temperature in sequence between -14°C and -26°C.

### REFRIGERATOR TEMPERATURE BUTTON

Sets the refrigerator temperature. Press the button repeatedly to change the temperature in sequence between 7°C and -1°C.

### QUICK FREEZE BUTTON

Speeds up the freezing process in the freezer.

### VACATION BUTTON

Turns the refrigerator off but not the freezer.

### ICE TIMER BUTTON

Schedules ice making. On the specified day, the ice maker makes the ice cubes.

### ICE MODE BUTTON

Sets the ice dispensing mode: ice cubes, crushed ice or ice off.

# CONTROLLING THE FREEZER AND REFRIGERATOR TEMPERATURES

## Freezer

- The freezer can be set to a temperature between -14°C and -26°C.
- Press the **FREEZER TEMP.** button **repeatedly** until the required temperature is shown in the temperature display.
- The temperature display changes in sequence between -14°C and -26°C. When the display reaches -26°C, it returns to -14°C.
- After five seconds, the display reverts to the average freezer temperature, which changes as the freezer reaches the new temperature.



### Temperature Display

Displays the current and selected freezer temperatures.

### Freezer Display

Indicates that you are setting the freezer temperature or have opened the freezer door.

## Refrigerator

- The refrigerator can be set to a temperature between 7°C and -1°C.
- Press the **REFRIGERATOR TEMP.** button **repeatedly** until the required temperature is shown in the temperature display.
- The temperature display changes in sequence and reverts same as the freezer control methods.
- When the setting temperature is -1°C or 0°C, it can cause water on the shelf freeze slightly. If your unit has Auto Icemaker & Water Dispenser, be sure to **set the refrigerator temperature above 0°C**, because a reservoir system is in the refrigerator compartment.

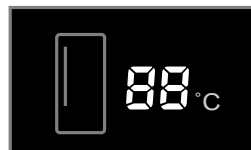

### Temperature Display

Displays the current and selected refrigerator temperatures.

### Refrigerator Display

Indicates that you are setting the refrigerator temperature or have opened the refrigerator door.



## INDICATORS (BASIC MODEL)

### Quick Freeze



- This light switches on when you press the QUICK FREEZE button.
- Press the button again to cancel the Quick Freeze mode. The freezer automatically switches back to the normal control mode after 2.5 hours.

### Fuzzy



- When the power cord is connected to the wall socket, the Fuzzy light is on. The compressor, fan and defrosting heater are automatically controlled to optimise food storage.

### Vacation



- When the vacation light is on, the refrigerator is switched off but not the freezer. Press the button again to cancel the Vacation mode. Be sure to remove all food in the refrigerator when you select this mode.

### Lock



- This light indicates that the four function buttons have been locked.
- To lock the buttons, press the FREEZER TEMP. and REFRIGERATOR TEMP. buttons at the same time for about three seconds. Press both buttons again for about three seconds to unlock them.



## OTHER INDICATORS (MODEL WITH ICE AND WATER DISPENSER)

### Ice Cubes, Crushed Ice and Ice Off

- Press the ICE MODE button to make ice cubes or crushed ice and also to stop making ice.
- Press the button one or more times to change between ice cubes, crushed ice and ice off in sequence. The appropriate light comes on.
- If you select "Ice off", the ice maker in the freezer is switched off until the ice mode is changed to ice cubes or crushed ice, also be sure to remove any ice cubes already in the ice bucket.



### Ice Timer and Vacation

- Press the ICE TIMER button to schedule ice making.
- The "Ice off" mode is automatically selected. Remove any ice from the ice bucket.
- You can set the ice timer to between 3 and 30 days. When the display reaches 30 days, it goes back to 3 days. For example, if you are going to come back after 10 days, set the ice timer to 10 days; the ice maker will start making ice automatically after about 8 days.
- Press the ICE MODE button to cancel the ice timer. Be sure to remove any ice cubes in the ice bucket after setting the timer.



- If you select both the Vacation and Ice Timer modes, the refrigerator is switched off. Remove all food from the refrigerator but leave the water tap open. Check that the tap and other pipe connections do not leak. When the start time is reached, the appliance begins making ice, the Vacation mode is cancelled and the refrigerator operates normally.
- If you select the Vacation mode but not the Ice Timer mode and when you are away for an extended period of time, close the water tap. The refrigerator switches off and the "Ice off" mode is selected. Remove any food from the refrigerator and any ice from the ice bucket.
- If the Vacation mode is selected for long periods of time, pour out about 10 cups of water from the water dispenser when you return home.

### Water Filter Indicator

- The water filter indicator initially lights up green. Press the ICE TIMER and ICE MODE buttons at the same time for about three seconds to reset the water filter installation date.
- The green light changes to orange after five months to indicate that you should soon change the water filter. It changes to red after an additional one month (six months after the water filter was changed or installed) to indicate that you must change the water filter.
- If you wish to turn off the filter indicator lamp or the filter is not connected, press the ice timer & icemode button simultaneously for 5 seconds. If you wish to turn ON the filter indicator lamp again, press the ice timer & ice mode button simultaneously for 3 seconds.







## MAKING ICE (BASIC MODEL)

**1** Pull out the ice tray.



**2** Add water until it reaches the water level indicator.

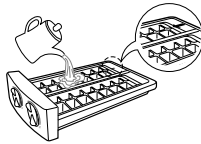

**3** Put the ice tray back in place.

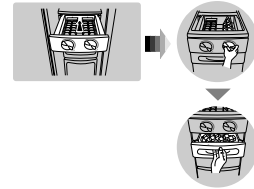

## ICE / COLD WATER DISPENSER (MODEL WITH ICE AND WATER DISPENSER ONLY)

The ice making device makes 10 cubes at a time and about 100 cubes a day automatically. This quantity may be influenced by such factors as the freezer temperature and the number of times that the door is opened. When your appliance is first plugged in, the Cubed Ice mode is selected automatically.

Press the **ICE MODE** button to select the type of ice:

- Ice cubes
- Crushed ice
- No ice

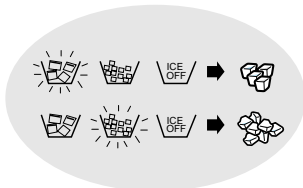

The water dispenser can serve six glasses of water in succession. You must then wait for several minutes to allow the stored water to cool again.

### Cold Water

- Push the water dispenser lever with a cup.
- If you have just installed the appliance, you must pour the first six glasses of water away, to remove the initial plastic smell of the water storage case.

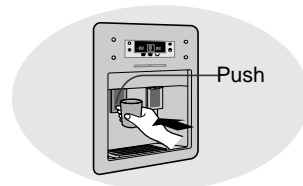

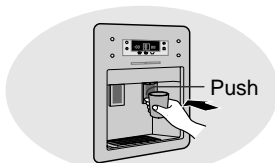

Push the ice dispenser lever with a cup.

- Place a cup near the dispenser to prevent the ice from jumping out.
- If you wish to use the ice dispenser and the cold water dispenser, use the ice dispenser first.

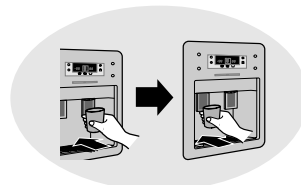

- If the water from the cold water dispenser is not chilled, pour the warm water away, add ice from the ice dispenser and fill your glass with water.



 Never put your fingers or any other objects in the dispenser opening.

 The refrigerator is provided with anti sweat-heater inside of dispenser panel and is delivered to user with heater switch "ON"  
You'd better turn off the anti sweat-heater under normal use for saving energy by pressing heater switch. Please turn on the anti sweat-heater the time when sweat occurs on the surface of dispenser panel.(position : ON)

# STORING FOOD



## REFRIGERATED FOOD STORAGE METHODS

1

### Tempered glass shelf

- Can be used safely because it will not break if it falls.



2

### Chilled compartment (option)

- Helps preserve the taste of food and prolongs its freshness. Use the chiller to store cheese, meat, snacks, fish or any food to be used quickly.

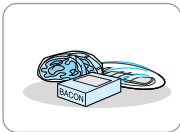

3

### High-humidity vegetable compartment

- Is used to store vegetables.
- This compartment is airtight. The cooling system does not, therefore, directly affect the food stored in it. It maintains the water content and freshness of the food for a long time.



4

### Fruit compartment

- Is used to store fruit.
- This compartment preserves freshness for a long time by maintaining the moisture in the food.

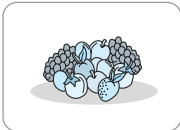

5

### Dairy compartment

- Can be used to store fatty foods, like butter and cheese.



6

### Multiple guard

- Can be used to store foods in small packages, such as milk and yoghurt.



7

### Extra refrigerating compartment (model with Home Bar)

- Can be used to store frequently used items, such as beverages.



8

### Beverage shelf

- Can be used to store a variety of bottles, cans and cartons.



9

### Egg rack

- Put eggs in the egg rack and then place the rack on the tempered glass shelf.



## FROZEN FOOD STORAGE METHODS

1

### Multiple guard

- Can be used for small packages of frozen food.

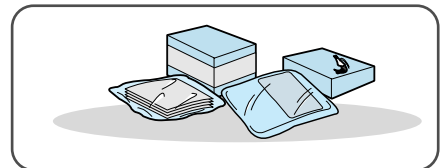

2

### Tempered glass shelf

- Can be used to store all types of frozen food.

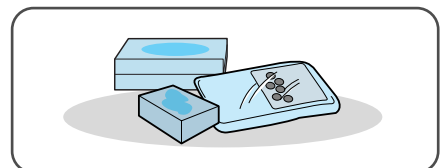

### 3 Meat and dry goods storage compartment

- Can be used to store meat and dry goods. Stored food should be wrapped securely using foil or other suitable wrapping materials.

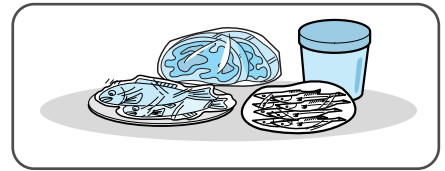

### 4 Door guard

- Can be used for frozen foods.

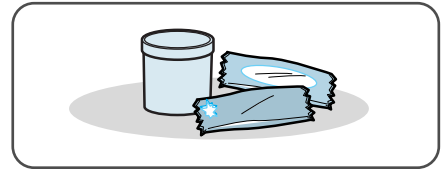

### 5 Ice chute and ice-maker cover

- Do not put your fingers, hands or any foreign object in the chute and ice-maker cover.

## VIEW OF YOUR FRIDGE/FREEZER



### FREEZER

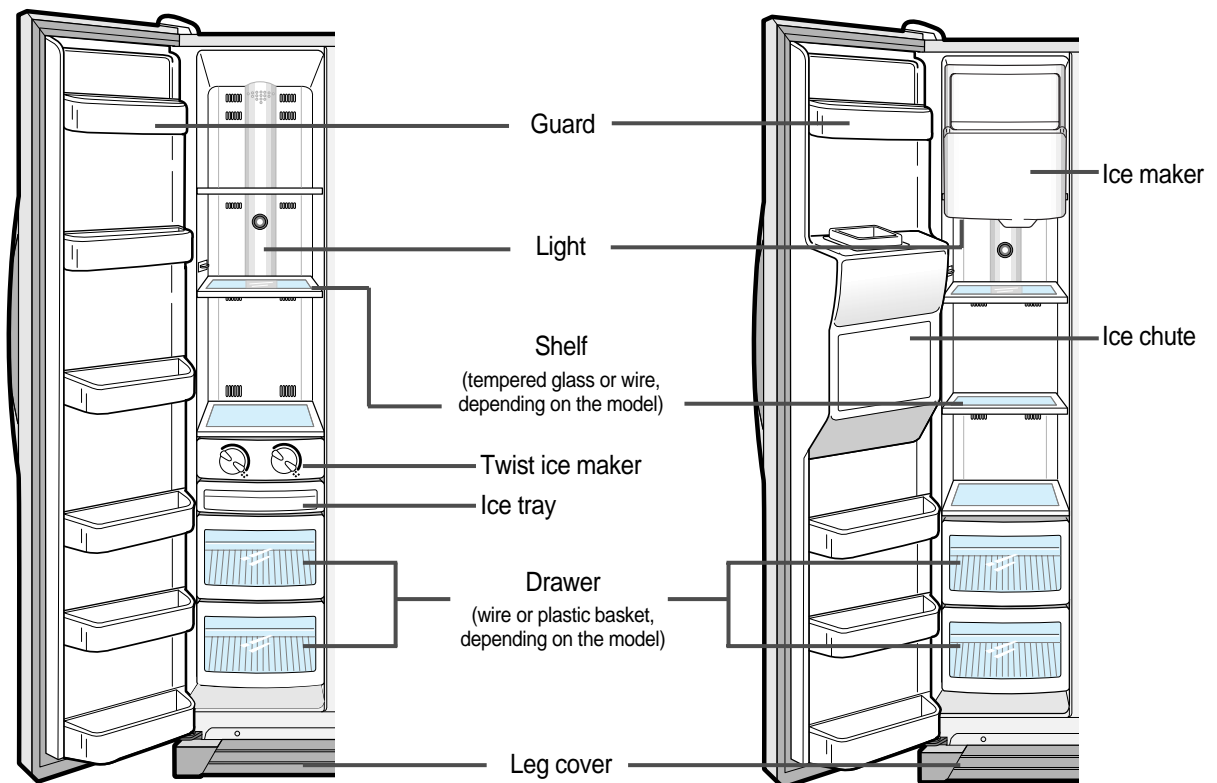

Basic model

Model with ice and water dispenser



# REFRIGERATOR

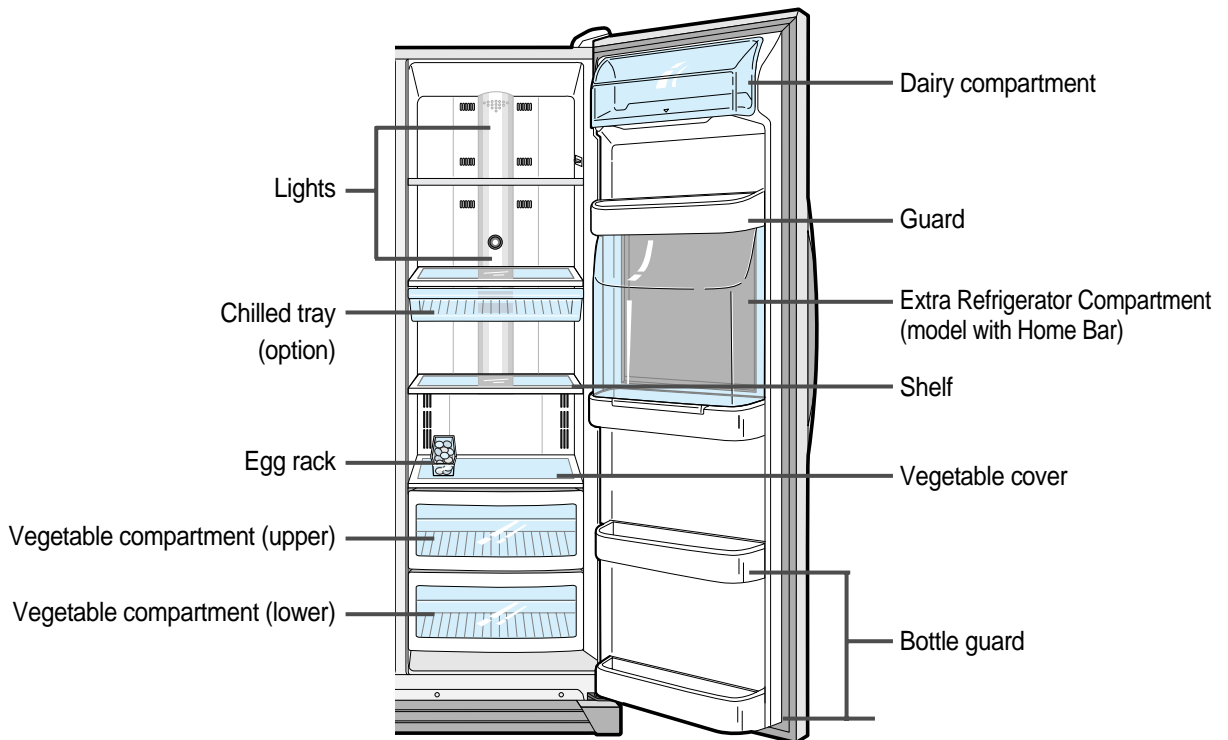

## REMOVING THE FREEZER ACCESSORIES

### 1 Tempered glass shelf

- Pull the shelf out as far as it goes. Then lift it up and remove it.

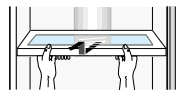

### 2 Multiple guard and door guard

- Hold the multiple guard and door shelf in both hands and then lift it up.

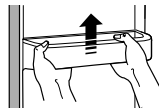

### 3 Meat and dry goods storage compartment

- Remove the compartment by pulling it out and lifting it up slightly.



### 4 Ice maker and tray

- Remove the ice tray by pulling it towards you. Then remove the ice maker (basic model only).

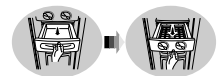

### 5 Leg cover

- Open the freezer and refrigerator doors, remove the three screws and detach the cover.
- To reassemble the leg cover, put it back into position and tighten the three screws.

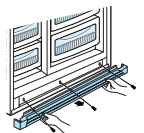

- \* Only remove the leg cover if strictly necessary.



#### NOTE

- Do not use excessive force when disassembling the cover; otherwise, you may cause damage.

# REMOVING THE REFRIGERATOR ACCESSORIES

- 1 Tempered glass shelf**
  - Pull the shelf out as far as it will go. Then lift it up and remove it.
- 2 High-humidity vegetable compartment and cover**
  - Remove the compartment by holding the handle, pulling the compartment towards you and lifting it up slightly.
  - Remove the cover by pulling it towards you.
- 3 Bottle and door guard**
  - Hold the shelf in both hands and remove it by lifting it up.

## EXTRA REFRIGERATING COMPARTMENT (MODEL WITH HOME BAR)

To access the extra refrigerating compartment, hold the compartment door handle and pull it downwards.

- The extra refrigerating compartment gives you added convenience because you do not need to open the main refrigerator door. In addition, this saves energy.

It is recommended that you use the extra refrigerating compartment for frequently used foods like beverages.

When the door is opened, it can be used as a tray to support items, such as beverage bottles and glasses.

- Do not scratch the surface of the door.



### NOTE

- The door of the extra refrigerating compartment should never be removed. The extra refrigerating compartment cannot function if the door is missing.
- When closing the extra refrigerating compartment door, be careful not to put your hands or fingers in a position where they can be caught or injured.
- If you use the open door as a tray, do not place heavy objects on it. Do not allow children to hang from the door; there is a risk of personal injury or material damage.

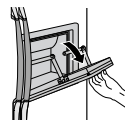

## CLEANING THE ACCESSORIES

### Inside

- Clean the accessories using a mild detergent. Then wipe with a dry cloth.
- After washing the accessories, make sure that they are dry before using them again.



### Exterior

- Wipe the front control panel with a clean cloth.
- The doors and door handles should be cleaned with a mild detergent and cloth. Dry them with a clean cloth.
- The exterior should be polished once or twice a year.



### Rear

- Use a vacuum cleaner to remove dust once or twice a year.

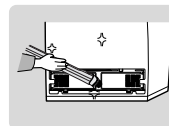

### Ice and water dispenser and drainage grid (model with ice and water dispenser )

- Use a damp cloth to clean the ice and water dispenser. Then wipe it with a dry cloth.
- Keep the ice and water dispenser and drainage grid dry.

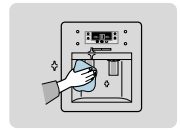

### Extra refrigerating compartment (model with Home Bar)

- Use a damp cloth to clean the extra refrigerating compartment. Then wipe it with a dry cloth.

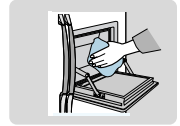

### Rubber door seals

- If the rubber door seals are dirty, the door will not close properly and the refrigerator and freezer will be unable to function efficiently. Clean them with a mild detergent and damp cloth. Then wipe them with a dry cloth.



- When cleaning the appliance or if you are not going to use it for a long time, remove the power plug, leave the doors open and keep the appliance dry.
- Do not clean it by spraying it directly with water.
- Do not clean it with benzene, thinner or car detergent.

## CHANGING THE INTERIOR LIGHT



### WARNING

Before changing the interior light, unplug the appliance from the power supply. If you experience difficulty when changing the light, contact your service centre.



### INTERIOR LIGHT IN THE FREEZER (BASIC MODEL ONLY) / REFRIGERATOR

- 1** Place a flat screwdriver under the light cover hooks and push in the direction of the arrow.
- 2** Pull the cover in the direction of the arrow.
- 3** After changing the bulb, replace the light cover.

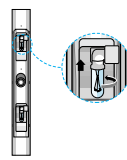
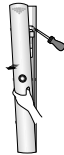

### INTERIOR LIGHT IN THE FREEZER (MODEL WITH ICE AND WATER DISPENSER)

- 1** Lift and pull out the ice maker cover (①).
- 2** Use a screwdriver to remove the light cover (②).
- 3** Replace the bulb with a new one (③), and then secure the light cover back into place using a screwdriver.
- 4** Replace the ice maker cover.

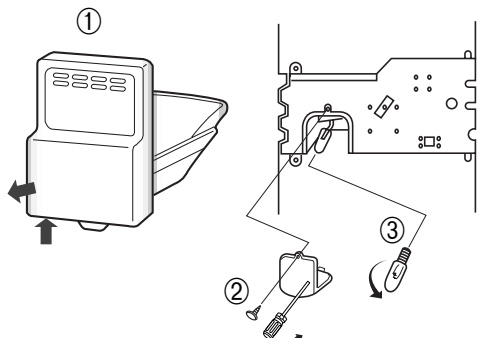

# ICE-MAKING FILTER

## What is the ice-making filter?

- The ice-making filter is a device which removes impurities from the water.

## How do I install the ice-making filter?

- Connect the ice-making filter provided to the water tap (refer to the installation manual).
- Remove the residue in the ice-making filter by rinsing it with water.

## How often should I change the ice-making filter?

- Every 6 months on average but it may vary, depending on the water quality.
- The water filter indicator turns orange to inform you that you should replace the water filter soon. When it turns red, replace the filter with a new one. Water filters are available from your dealer and authorised service centres.

## Filtering chemicals and purification

- The ice-making filter uses carbon to filter odours, chemicals and other impurities.

# PROBLEMS AND SOLUTIONS

## The fridge/freezer does not work at all or it does not chill sufficiently

- Check that the power plug is properly connected.
- Check that the power plug fuse has not blown.
- Is the temperature control on the front panel set to the correct temperature?
- Is the fridge/freezer in direct sunlight or located near a heat source?
- Is the back of the fridge/freezer too close to the wall?

## The food in the refrigerator is frozen

- Is the temperature control on the front panel set to the correct temperature?
- Is the temperature in the room too low?
- Did you put food with a high water content in the coldest part of the refrigerator.

## You can hear unusual noise or sounds

- Check that the floor is level and stable.
- Is the back of the appliance too near to the wall?
- Was anything dropped behind or under the appliance?
- Is the noise from the compressor in the appliance?
- A "ticking" sound may be heard from inside the appliance, but this is normal. It is caused when the various accessories contract or expand.

## The front corners and sides of the fridge/freezer are hot; condensation forms

- Heat-proof pipes are installed in the front corners of the refrigerator to prevent condensation.
- Condensation can occur when you leave the door open for too long or you store food with a high water content unwrapped in the refrigerator and the temperature and humidity levels are high.

## Ice is not dispensed

- Did you stop the ice making function?
- Is there any ice in the ice storage unit?
- Is the water tap open and the water pipe connected?
- Is the freezer temperature too warm? (Set it to a lower temperature.)
- Did you wait for 12 hours after installation before making ice?

## You can hear water babbling in the refrigerator

- The babbling comes from the refrigerant circulating in the fridge/freezer.

## There is a bad smell in the fridge/freezer

- You did not wrap food with a strong smell or you have forgotten something in the refrigerator.
- Wrap food with a strong smell so that it is airtight. Throw away any food that has gone off.

## Frost forms on the wall of the freezer

- Is the air inlet/outlet blocked?
- Allow sufficient space between the food items for air to circulate efficiently.
- Is the door closed properly?

## No water is dispensed

- Is the water tap open and the water pipe connected?
- Is the water pipe blocked?
- Is the water tank frozen because the refrigerator temperature is too low? Select a warmer setting via the front control panel.

## Ambient Room Temperature Limits

This appliance is designed to operate at the ambient temperatures specified by its temperature class marked on the rating plate.

Temperature Class	Symbol	Ambient Temperature	
		Maximum	Minimum
Extended Temperate	SN	32°C (90°F)	10°C (50°F)
Temperate	N	32°C (90°F)	16°C (61°F)
Subtropical	ST	38°C (100°F)	18°C (64°F)
Tropical	T	43°C (109°F)	18°C (64°F)

**NOTE:** The internal temperature may be affected by such factors as the location of the appliance, ambient temperature and the frequency with which you open the doors. Adjust the temperature as required to compensate for these factors.





## Free Manuals Download Website

<http://myh66.com>

<http://usermanuals.us>

<http://www.somanuals.com>

<http://www.4manuals.cc>

<http://www.manual-lib.com>

<http://www.404manual.com>

<http://www.luxmanual.com>

<http://aubethermostatmanual.com>

Golf course search by state

<http://golfingnear.com>

Email search by domain

<http://emailbydomain.com>

Auto manuals search

<http://auto.somanuals.com>

TV manuals search

<http://tv.somanuals.com>