

SAMSUNG

DIGITAL HOME CINEMA SYSTEM

HT-THQ22

HT-THQ25

THIS APPLIANCE IS MANUFACTURED BY:

Instruction Manual

SAMSUNG

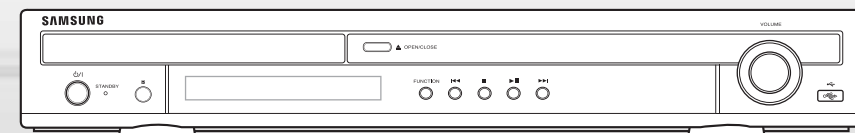

AH68-01888B



HDMI



Safety Warnings

CLASS 1 LASER PRODUCT
KLASSE 1 LASER PRODUKT
LUOKAN 1 LASER LAITE
KLASS 1 LASER APPARAT
PRODUCTO LASER CLASE 1



CAUTION

RISK OF ELECTRIC SHOCK.
DO NOT OPEN



CAUTION:

TO REDUCE THE RISK OF ELECTRIC SHOCK, DO NOT REMOVE REAR COVER. NO USER SERVICEABLE PARTS INSIDE. REFER SERVICING TO QUALIFIED SERVICE PERSONNEL.

Use of controls, adjustments or performance of procedures other than those specified herein may result in hazardous radiation exposure.

CAUTION-INVISIBLE LASER RADIATION WHEN OPEN AND INTERLOCKS DEFEATED, AVOID EXPOSURE TO BEAM.



This symbol indicates that dangerous voltage which can cause electric shock is present inside this unit.



This symbol alerts you to important operating and maintenance instructions accompanying the unit.

WARNING: To reduce the risk of fire or electric shock, do not expose this appliance to rain or moisture.

CAUTION: TO PREVENT ELECTRIC SHOCK, MATCH WIDE BLADE OF PLUG TO WIDE SLOT, FULLY INSERT.

CLASS 1 LASER PRODUCT

This Compact Disc player is classified as a CLASS 1 LASER product.

- This apparatus shall always be connected to a AC outlet with a protective grounding connection.
- To disconnect the apparatus from the mains, the plug must be pulled out from the mains socket, therefore the mains plug shall be readily operable.

Wiring the Main Power Supply Plug(UK Only)

IMPORTANT NOTICE

The main lead on this equipment is supplied with a moulded plug incorporating a fuse. The value of the fuse is indicated on the pin face of the plug and if it requires replacing, a fuse approved to BS1362 of the same rating must be used.

Never use the plug with the fuse cover removed. If the cover is detachable and a replacement is required, it must be of the same colour as the fuse fitted in the plug. Replacement covers are available from your dealer.

If the fitted plug is not suitable for the power points in your house or the cable is not long enough to reach a power point, you should obtain a suitable safety approved extension lead or consult your dealer for assistance.

However, if there is no alternative to cutting off the plug, remove the fuse and then safely dispose of the plug. Do not connect the plug to a main socket as there is a risk of shock hazard from the bared flexible cord.

Never attempt to insert bare wires directly into a main socket. A plug and fuse must be used at all times.

IMPORTANT

The wires in the main lead are coloured in accordance with the following code:-

BLUE = NEUTRAL BROWN = LIVE

As these colours may not correspond to the coloured markings identifying the terminals in your plug, proceed as follows:-

The wire coloured BLUE must be connected to the terminal marked with the letter N or coloured BLUE or BLACK. The wire coloured BROWN must be connected to the terminal marked with the letter L or coloured BROWN or RED.

WARNING: DO NOT CONNECT EITHER WIRE TO THE EARTH TERMINAL WHICH IS MARKED WITH THE LETTER E OR BY THE EARTH SYMBOL , OR COLOURED GREEN OR GREEN AND YELLOW.

This marking shown on the product or its literature, indicates that it should not be disposed with other household wastes at the end of its working life. To prevent possible harm to the environment or human health from uncontrolled waste disposal, please separate this from other types of wastes and recycle it responsibly to promote the sustainable reuse of material resources. Household users should contact either the retailer where they purchased this product, or their local government office, for details of where and how they can take this item for environmentally safe recycling. Business users should contact their supplier and check the terms and conditions of the purchase contract. This product should not be mixed with other commercial wastes for disposal.

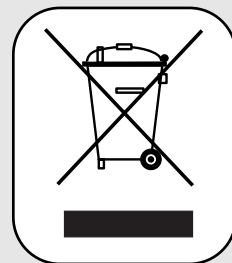

Precautions

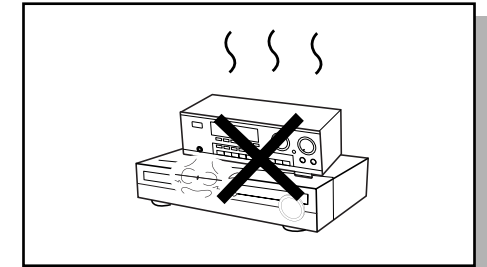
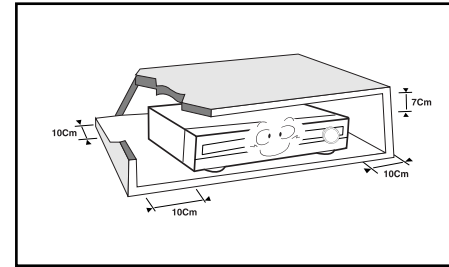

Ensure that the AC power supply in your house complies with the identification sticker located on the back of your player. Install your player horizontally, on a suitable base (furniture), with enough space around it for ventilation (7.5~10cm). Make sure the ventilation slots are not covered. Do not stack anything on top of the player. Do not place the player on amplifiers or other equipment which may become hot. Before moving the player, ensure the disc tray is empty. This player is designed for continuous use. Switching off the DVD player to the stand-by mode does not disconnect the electrical supply. In order to disconnect the player completely from the power supply, remove the main plug from the wall outlet, especially when left unused for a long period of time.

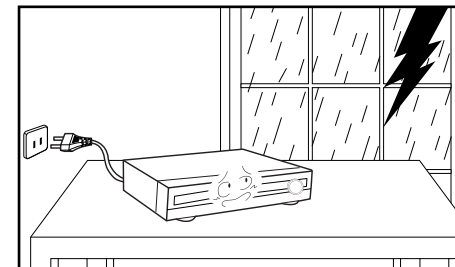

During thunderstorms, disconnect AC main plug from the wall outlet. Voltage peaks due to lightning could damage the unit.

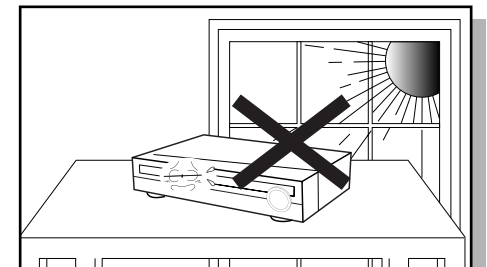

Do not expose the unit to direct sunlight or other heat sources. This could lead to overheating and malfunction of the unit.

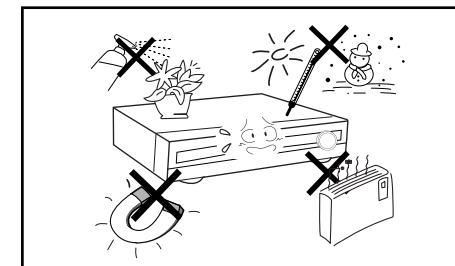

Protect the player from moisture(i.e. vases) , and excess heat (e.g.fireplace) or equipment creating strong magnetic or electric fields (i.e.speakers...). Disconnect the power cable from the AC supply if the player malfunctions. Your player is not intended for industrial use. Use of this product is for personal use only. Condensation may occur if your player or disc has been stored in cold temperatures. If transporting the player during the winter, wait approximately 2 hours until the unit has reached room temperature before using.

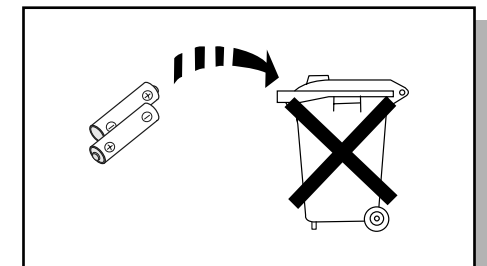

The batteries used with this product contain chemicals that are harmful to the environment. Do not dispose of batteries in the general household trash.

Features

● Multi-Disc Playback & FM Tuner

The HT-THQ22/HT-THQ25 combines the convenience of multi-disc playback capability, including DVD-VIDEO, VCD, CD, MP3-CD, WMA-CD, DivX, CD-R/RW, and DVD-R/RW, with a sophisticated FM tuner, all in a single player.

● USB HOST Function support

You can connect and play files from external USB storage devices such as MP3 players, USB flash memory, etc. using the Home Theater's USB HOST function.

● Dolby Pro Logic II

Dolby Pro Logic II is a new form of multi-channel audio signal decoding technology that improves upon existing Dolby Pro Logic.

● DTS (Digital Theater Systems)

DTS is an audio compression format developed by Digital Theater Systems Inc. It delivers full-frequency 5.1 channel sound.

● TV Screen Saver Function

The HT-THQ22/HT-THQ25 automatically brightens and darkens your TV screen after 3 minutes in the stop mode.

The HT-THQ22/HT-THQ25 automatically switches itself into the power saving mode after 20 minutes in the screen saver mode.

● Power Saving Function

The HT-THQ22/HT-THQ25 automatically shuts itself off after 20 minutes in stop mode.

● Customized TV Screen Display

The HT-THQ22/HT-THQ25 allows you to select your favorite image during JPEG, DVD or VCD playback and set it as your background wallpaper.

● HDMI

HDMI transmits DVD video and audio signals simultaneously, and provides a clearer picture.

Contents

● PREPARATION

Safety Warnings	1
Precautions	2
Features	3
Notes on Discs	5
Description	7

● CONNECTIONS

Connecting the Speakers	11
Speaker Installation	13
Connecting the Video Out to TV	15
HDMI Function	16
Connecting External Components	18
Connecting the FM Antenna	19

● OPERATION

Before Using Your Home Theater	20
Disc Playback	22
MP3/WMA-CD Playback	23
Displaying Disc Information	24
JPEG File Playback	25
DivX Playback	27
Checking the Remaining Time	29
Fast/Slow Playback	30
Skipping Scenes/Songs	30
Repeat Playback	31
A-B Repeat Playback	32
Step Function	33
Angle Function	33
Zoom (Screen Enlarge) Function	34
EZ VIEW Function	34
Selecting Audio Language	35
Selecting Subtitle Language	36
Playing Media Files using the USB HOST feature	37
Moving Directly to a Scene/Song	39
Using Disc Menu	40
Using the Title Menu	40

● SETUP

Setting the Language	41
Setting TV Screen type	43
Setting Parental Controls (Rating Level)	45
Setting the Password	46
Setting the Wallpaper	47
DivX (R) registration	49
Setting the Speaker Mode	50
Setting the Delay Time	51
Setting the Test Tone	53
Setting the DRC (Dynamic Range Compression)	54
Setting the Audio Quality	55
AV SYNC Setup	57
Sound Field (DSP)/EQ Function	58
Dolby Pro Logic II Mode	59
Dolby Pro Logic II Effect	60

● RADIO OPERATION

Listening to Radio	61
Presetting Stations	62
About RDS broadcasting	63

● MISCELLANEOUS

Convenient Functions	65
Operating a TV with the Remote Control	67
Before Calling for Service	68
Cautions on Handling and Storing Discs	71
Language Code List	72
USB Host Feature Supported Products	73
Specifications	74



DVD (Digital Versatile Disc) offers fantastic audio and video, thanks to Dolby Digital surround sound and MPEG-2 video compression technology. Now you can enjoy these realistic effects in the home, as if you were in a movie theater or concert hall.



DVD players and the discs are coded by region. These regional codes must match in order for the disc to play. If the codes do not match, the disc will not play.

The Region Number for this player is given on the rear panel of the player.
(Your DVD player will only play DVDs that are labeled with identical region codes.)

Playable Discs

Disc Type	Mark (Logo)	Recorded Signals	Disc Size	Max. Playing Time
DVD-VIDEO		Video	12cm	Approx. 240 min. (single-sided) Approx. 480 min. (double-sided)
			8cm	Approx. 80 min. (single-sided) Approx. 160 min. (double-sided)
AUDIO-CD VIDEO-CD		Audio Audio + Video	12cm 8cm	74 min. 20 min.
Divx		MPEG4 MP3	12cm	74 min.
			8cm	20 min.

Do not use the following types of disc!

- LD, CD-G, CD-I, CD-ROM and DVD-ROM discs cannot be played on this player. If such discs are played, a "WRONG DISC FORMAT" message appears on the TV screen.
- DVD discs purchased abroad may not play on this player. If such discs are played, a "WRONG REGION CODE" message appears on the TV screen.

Copy Protection

- Many DVD discs are encoded with copy protection. Because of this, you should only connect your DVD player directly to your TV, not to a VCR. Connecting to a VCR results in a distorted picture from copy-protected DVD discs.
- This product incorporates copyright protection technology that is protected by methods claims of certain U.S. patents and other intellectual property rights owned by Macrovision Corporation and other rights owners. Use of this copyright protection technology must be authorized by Macrovision Corporation, and is intended for home and other limited viewing uses only unless otherwise authorized by Macrovision Corporation. Reverse engineering or disassembly is prohibited.

Disc Recording Format

This product does not support Secure (DRM) Media files.

CD-R Discs

- Some CD-R discs may not be playable depending on the disc recording device (CD-Recorder or PC) and the condition of the disc.
- Use a 650MB/74 minute CD-R disc.
Do not use CD-R discs over 700MB/80 minute as they may not be play back.
- Some CD-RW (Rewritable) media, may not be playable.
- Only CD-Rs that are properly "closed" can be fully played. If the session is closed but the disc is left open, you may not be able to fully play the disc.

CD-R MP3 Discs

- Only CD-R discs with MP3 files in ISO 9660 or Joliet format can be played.
- MP3 file names should be 8 characters or less in length and contain no blank spaces or special characters (. / = +).
- Use discs recorded with a compression/decompression data rate greater than 128Kbps.
- Only files with the ".mp3" and ".MP3" extensions can be played.
- Only a consecutively written Multisession disc can be played. If there is a blank segment in the Multisession disc, the disc can be played only up to the blank segment.
- If the disc is not closed, it will take longer to begin playback and not all of the recorded files may be played.
- For files encoded in Variable Bit Rate (VBR) format, i.e. files encoded in both low bit rate and high bit rate (e.g., 32Kbps ~ 320Kbps), the sound may skip during playback.
- A maximum of 500 tracks can be played per CD.
- A maximum of 300 folders can be played per CD.

CD-R JPEG Discs

- Only files with the ".jpeg" and ".JPEG" extensions can be played.
- If the disc is not closed, it will take longer to start playing and not all of the recorded files may be played.
- Only CD-R discs with JPEG files in ISO 9660 or Joliet format can be played.
- JPEG file names should be 8 characters or less in length and contain no blank spaces or special characters (. / = +).
- Only a consecutively written multisession disc can be played. If there is a blank segment in the multisession disc, the disc can be played only up to the blank segment.
- A maximum of 9,999 images can be stored on a single CD.
- When playing a Kodak/Fuji Picture CD, only the JPEG files in the picture folder can be played.
- Picture discs other than Kodak/Fuji Picture CDs may take longer to start playing or may not play at all.

CD-R/RW DivX Discs

- Since this product only provides encoding formats authorized by DivX Networks, Inc., a DivX file created by the user might not be played.
- Software update for unsupported formats is not supported.
(Example: QPEL, GMC, resolution higher than 720 x 480 pixels, etc.)
- Sections with high frame rate might not be played while playing a DivX file.
- For more information about the formats authorized by DivX Networks, Inc., visit "www.divxnetworks.net".

Description

—Front Panel—

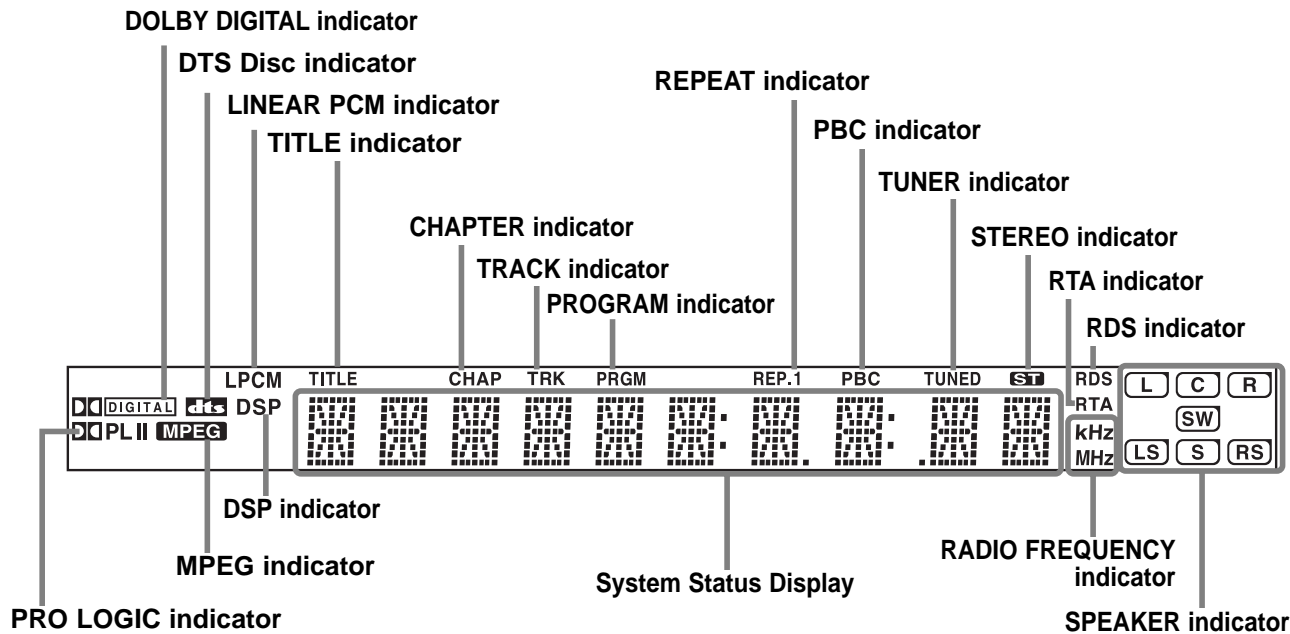
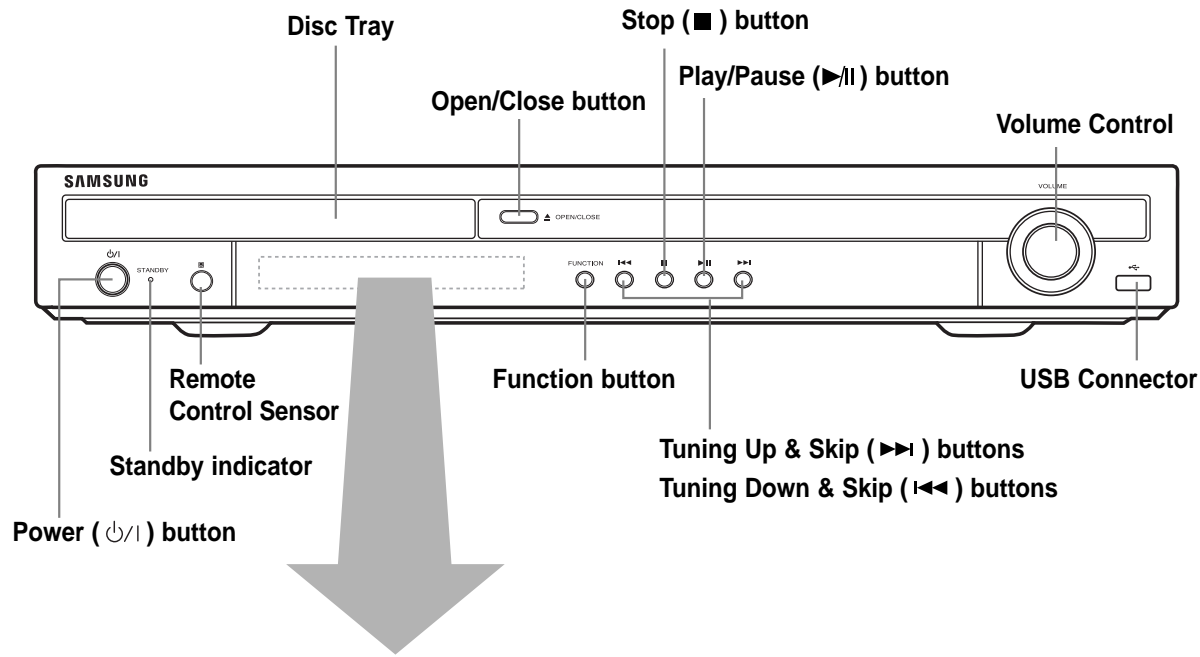

—Rear Panel—

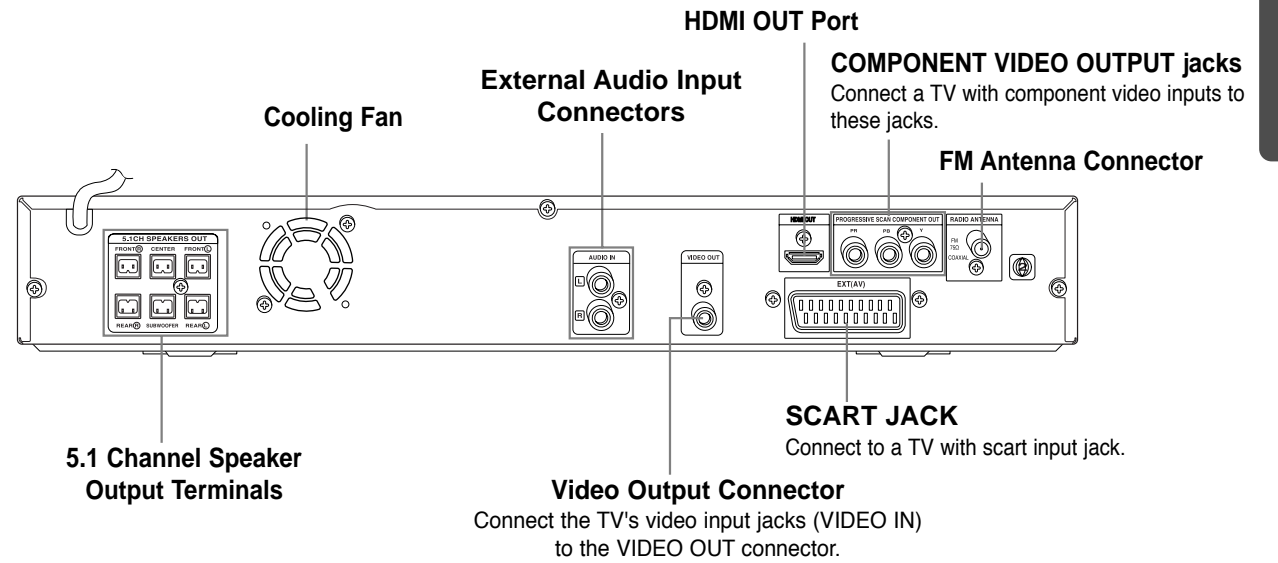

Accessories

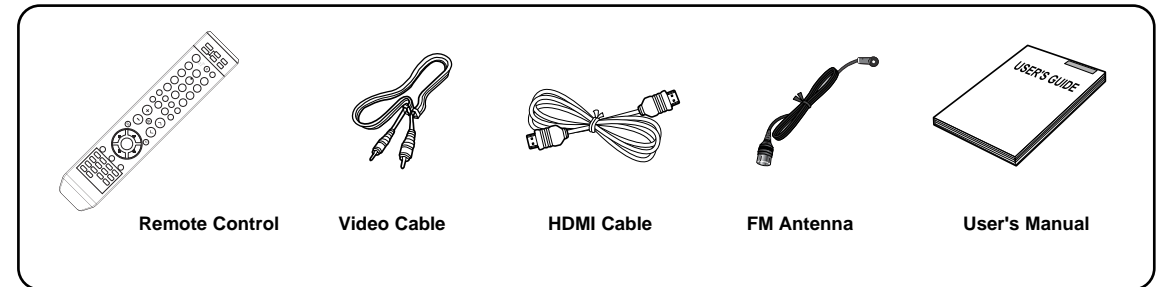

—Remote Control—

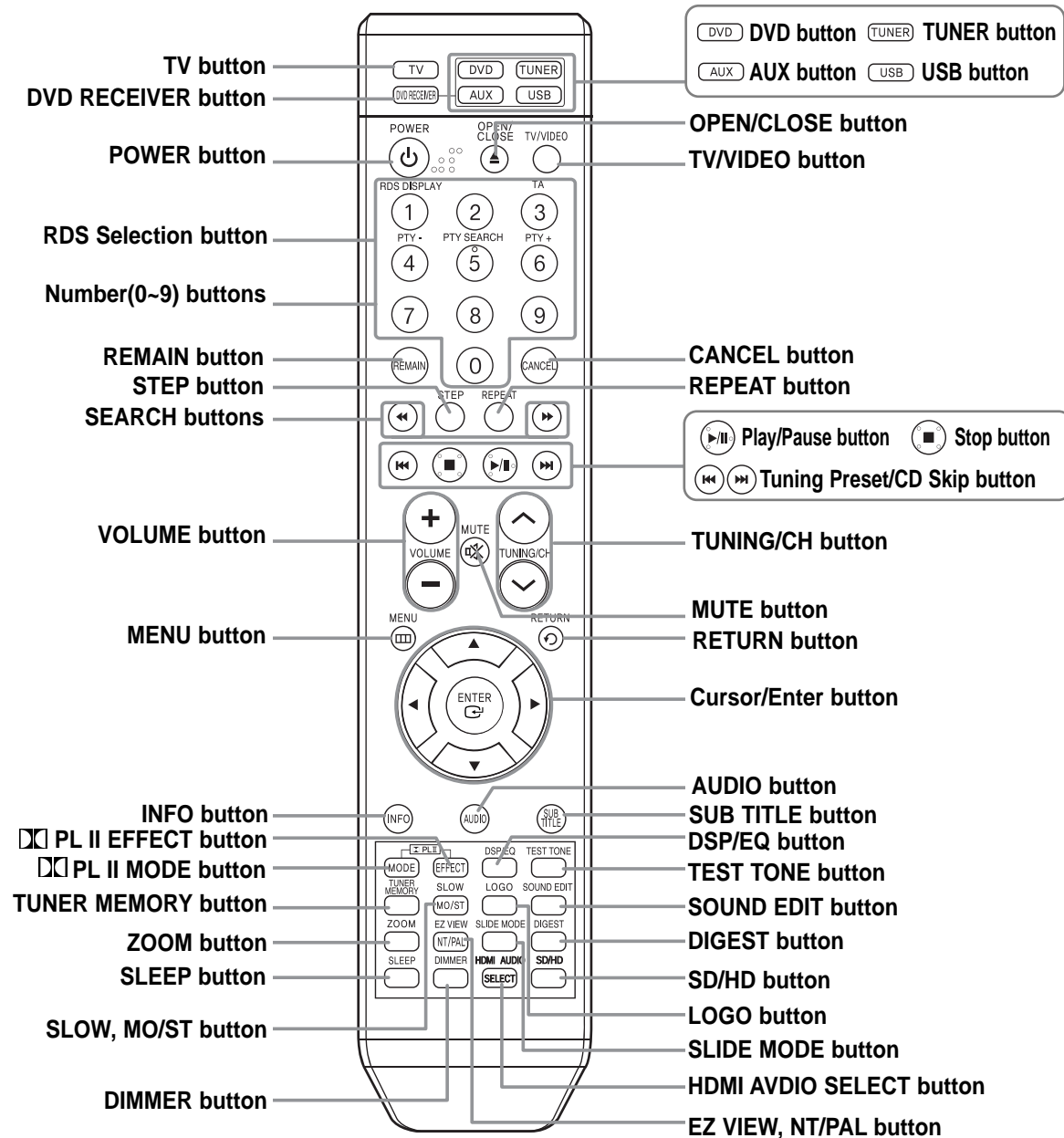

Insert Remote Batteries

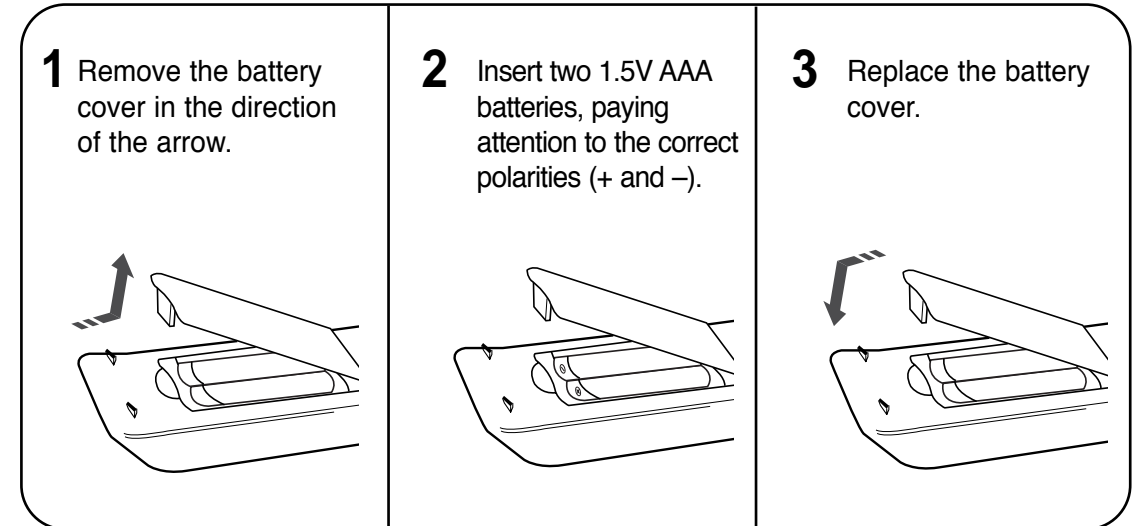

Caution Follow these precautions to avoid leaking or cracking cells:

- Place batteries in the remote control so they match the polarity:(+) to (+)and (-)to (-).
- Use the correct type of batteries.Batteries that look similar may differ in voltage.
- Always replace both batteries at the same time.
- Do not expose batteries to heat or flame.

Range of Operation of the Remote Control

The remote control can be used up to approximately 23 feet/7 meters in a straight line. It can also be operated at a horizontal angle of up to 30° from the remote control sensor.

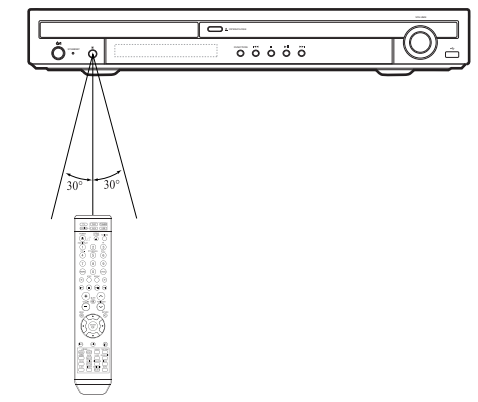

Connecting the Speakers

Before moving or installing the product, be sure to turn off the power and disconnect the power cord.

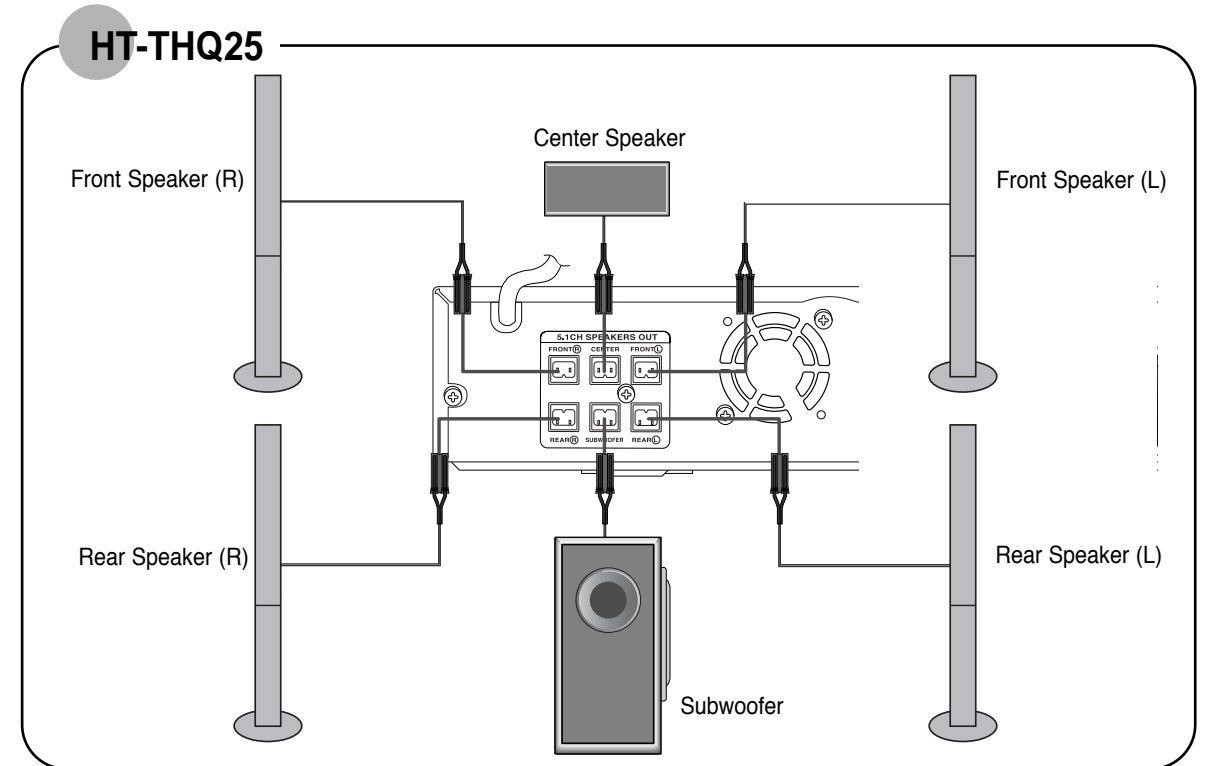
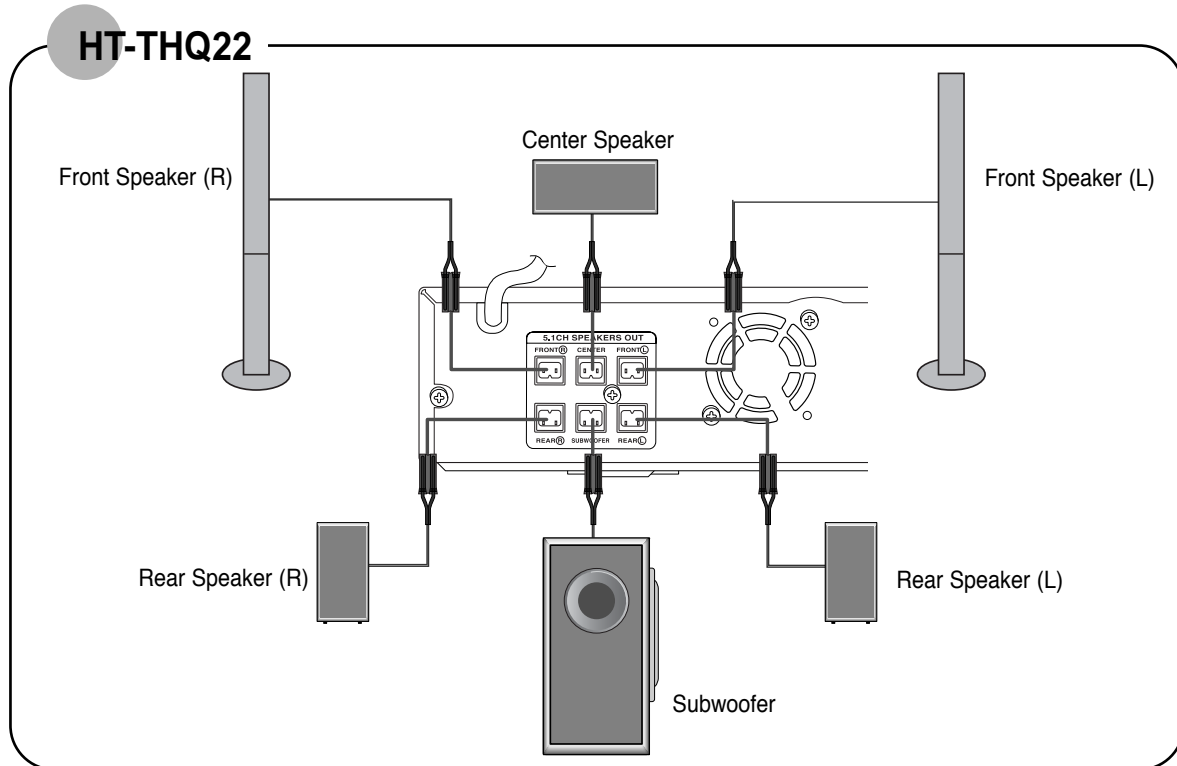

Position of the DVD Player

- Place it on a stand or cabinet shelf, or under the TV stand.

Front Speakers **L R**

- Place these speakers in front of your listening position, facing inwards (about 45°) toward you.
- Place the speakers so that their tweeters will be at the same height as your ear.
- Align the front face of the front speakers with the front face of the center speaker or place them slightly in front of the center speakers.

Center Speaker **C**

- It is best to install it at the same height as the front speakers.
- You can also install it directly over or under the TV.

Selecting the Listening Position

The listening position should be located about 2.5 to 3 times the distance of the TV's screen size away from the TV. Example: For 32" TVs 2~2.4m (6~8feet)
For 55" TVs 3.5~4m (11~13feet)

Rear Speakers **SL SR**

- Place these speakers behind your listening position.
- If there isn't enough room, place these speakers so they face each other.
- Place them about 60 to 90cm (2 to 3feet) above your ear, facing slightly downward.

* Unlike the front and center speakers, the rear speakers are used to handle mainly sound effects and sound will not come from them all the time.

Subwoofer **SW**

- The position of the subwoofer is not so critical. Place it anywhere you like.

Connecting the Speakers

- Press down the terminal tab on the back of the speaker.
- Insert the black wire into the black terminal (-) and the red wire into the red (+) terminal, and then release the tab.
- Connect the correct color speaker cable to the same color speaker output terminal on the rear of the subwoofer, according to the polarity markings (+/-).

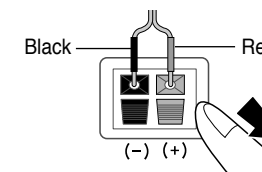
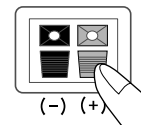

- Example:** Connect the green center speaker cable to the green center speaker output terminal on the rear of the subwoofer according to the polarity markings (+/-).

Caution

- Do not let children play with or near the speakers. They could get hurt if a speaker falls.
- When connecting the speaker wires to the speakers, make sure that the polarity (+/-) is correct.
- Keep the subwoofer speaker out of reach of children so as to prevent children from inserting their hands or alien substances into the duct (hole) of the subwoofer speaker.
- Do not hang on the wall through the duct (hole).

Note

- If you place a speaker near your TV set, screen color may be distorted because of the magnetic field generated by the speaker. If this occurs, place the speaker away from your TV set.

Speaker Installation

How to install the speaker and the stand (Tallboy type)

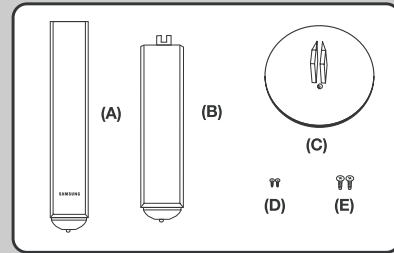

Component
A: SPEAKER
B: STAND
C: STAND BASE
D: Screw
E: Screw

1 Turn the STAND (B) upside-down and connect it to the STAND BASE (C).

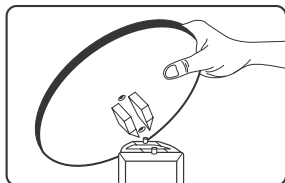

2 Turning the screw (D) clockwise, connect it to two holes marked with the arrow using a screwdriver as shown in the illustration.

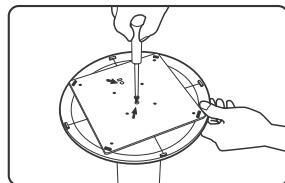

3 Turning the supplied screw (E) clockwise, connect it to a hole on the rear of the Speaker.

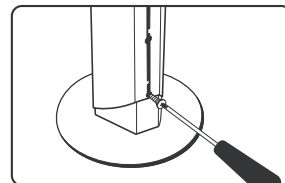

4 Connect the assembled stand to the SPEAKER (A).

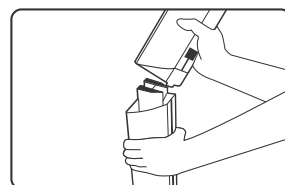

5 Turning the screw (E) clockwise, connect to a hole on the rear of the speaker using a screwdriver as shown in the illustration.

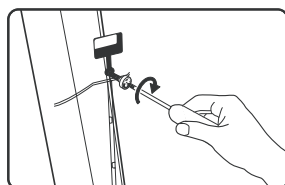

6 This is the successfully assembled speaker.
 * Make sure that the TALLBOY type speaker should be installed on the flat and stable area. Otherwise it may fall down due to external shock.

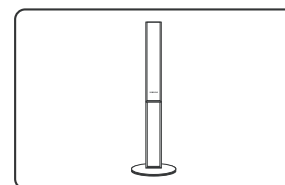

How to install the speaker and the stand (Half tallboy type)

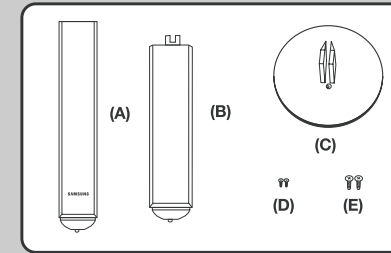

Component
A: SPEAKER
B: STAND
C: STAND BASE
D: Screw
E: Screw

1 Connect the SPEAKER (A) with the STAND BASE (C).

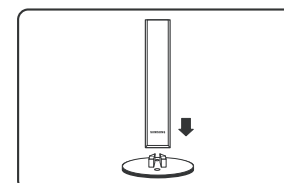

2 Turning the screw (D) clockwise, connect it to two holes marked with the arrow using a screwdriver as shown in the illustration.

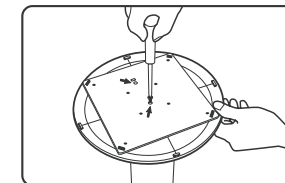

3 Turning the screw (E) clockwise, connect to a hole on the rear of the speaker using a screwdriver as shown in the illustration.

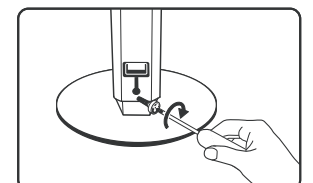

4 This is the successfully assembled SPEAKER (A).

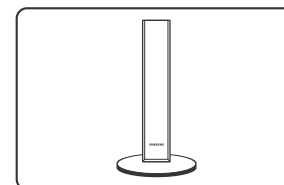

Connecting the Video Out to TV

Choose one of the four methods for connecting to a TV.

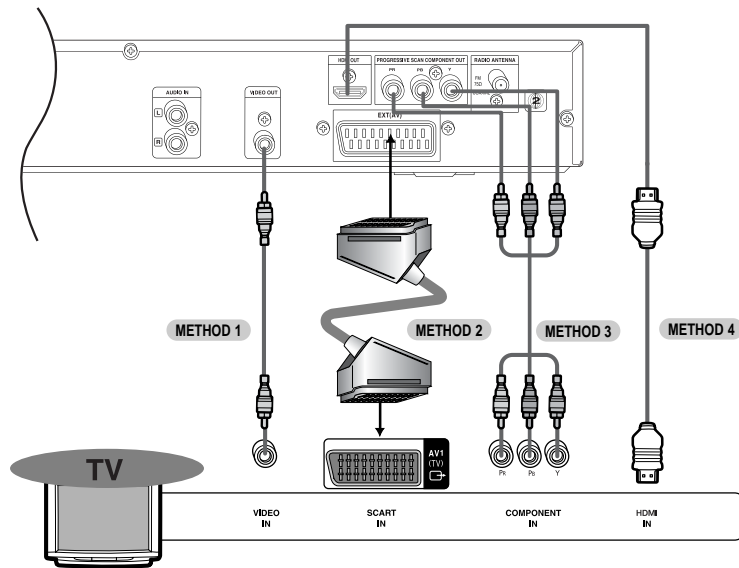

METHOD 1 Composite Video Good Quality

Connect the supplied video cable from the VIDEO OUT jack on the back panel of the system to the VIDEO IN jack on your television.

METHOD 2 Scart Good Quality

If your television is equipped with an SCART input, connect an Scart Jack (not supplied) from the AV OUT jack on the back panel of the system to the SCART IN jack on your television.

METHOD 3 Component Video Better Quality

If your television is equipped with Component Video inputs, connect a component video cable (not supplied) from the Pr, Pb and Y jacks on the back panel of the system to the corresponding jacks on your television.

METHOD 4 HDMI Best Quality

Connect the HDMI out to the HDMI input on your TV.

HDMI Function

What is HDMI (High Definition Multimedia Interface)?

This device transmits DVD video signal digitally without the process of converting to analog. You can get sharper digital pictures by connecting the video to your TV using an HDMI connection cable.

HDMI Audio ON/OFF function

- The audio signals transmitted over the HDMI Cable can be toggled ON/OFF.

Press the **HDMI AUDIO** button on the remote control.

- This toggles between "AUDIO ON" and "AUDIO OFF" on the display.
- **AUDIO ON** : Both video and audio signals are transmitted over the HDMI connection cable, and audio is output through your TV speakers only.
- **AUDIO OFF** : Video is transmitted over the HDMI connection cable only, and audio is output through the home theater speakers only.

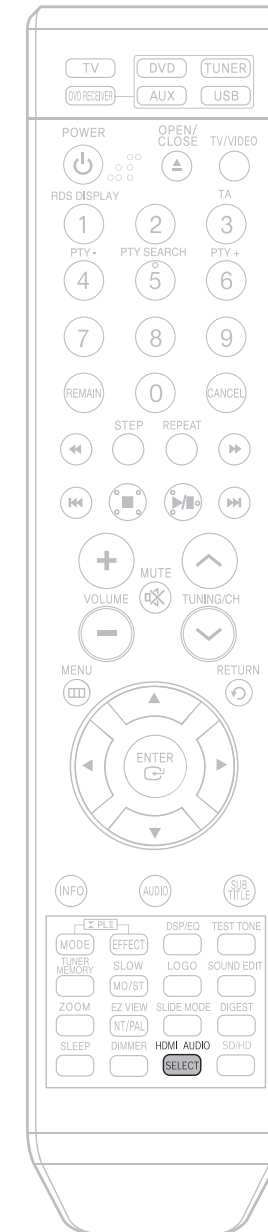

Note

- The default setting value of this product is HDMI AUDIO OFF.
- HDMI AUDIO is automatically down-mixed to 2ch for TV speakers.
- If you turn the unit off and on, or switch functions when the HDMI AUDIO is set to ON, the HDMI AUDIO is automatically set to OFF.

HDMI Function(Con't)

Resolution Selection

- This function allows the user to select screen resolution for HDMI output.

In Stop mode, press and hold the **SD/HD** (Standard Definition/High Definition) button on the remote control.

- Resolutions available for the HDMI output are 576p(480p), 720p and 1080i.
- SD(Standard Definition) resolution is 576p(480p) and HD(High Definition) resolution is 720p/1080i.

Example: If the TV supports resolution up to 576p(480p):

Press the **SD/HD** button.

- A 576p(480p) video signal is output through the HDMI output.
- If the TV does not support the configured resolution, you will not be able to see the picture properly.

Note

- You do not have to make separate adjustments, since the Home Theater and TV will be automatically adjust themselves to the optimal resolution and aspect ratio if connected to HDMI. (If the TV is an HDTV and has an HDMI Input jack, output is automatically converted to 1080i resolution (if supported by the TV).)
- See your TV owner's manual for more information on how to select the TV's Video Input source.



Connecting External Components

GB

Connecting an External Analog Component

Example: Analog signal components such as a VCR.

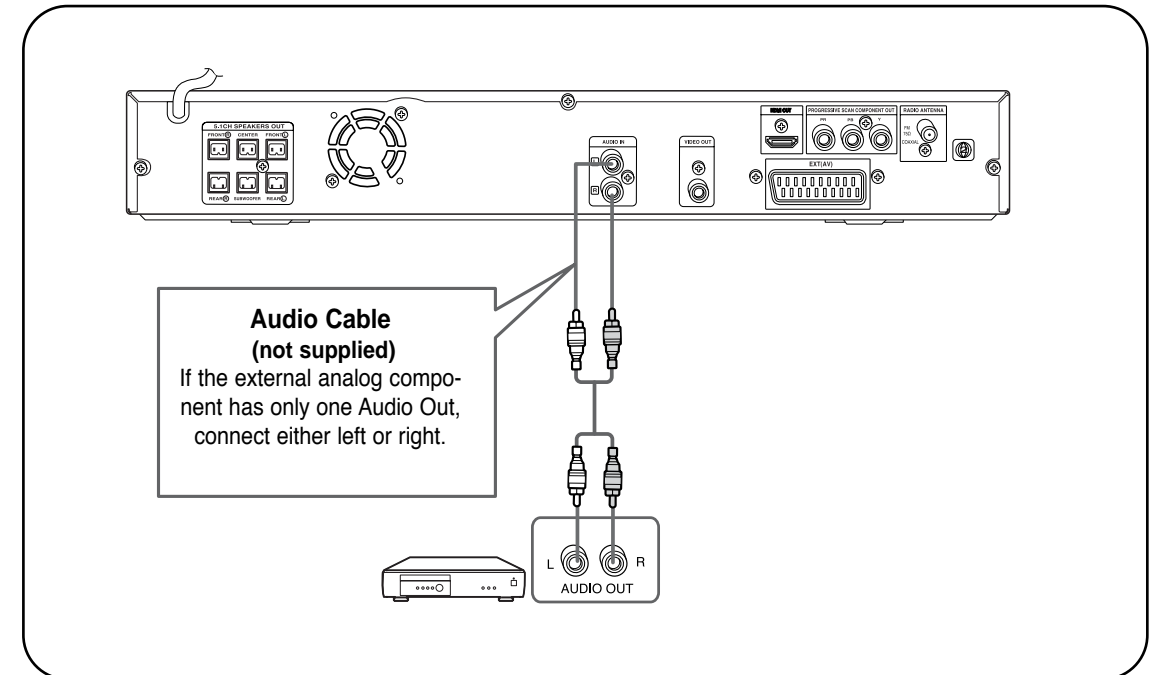

CONNECTIONS

- 1 Connect AUX (Audio) In on the Home Theater to Audio Out on the external analog component.
 - Be sure to match connector colors.
- 2 Press **AUX** button on the remote control to select 'AUX' input.
 - You can also use the **FUNCTION** button on the main unit.
 - The mode switches as follows: DVD/CD → AUX → USB → FM

Note

- You can connect the Video Output jack on your VCR to the TV, and connect the Audio Output jacks on the VCR to this product.

Connecting the FM Antenna

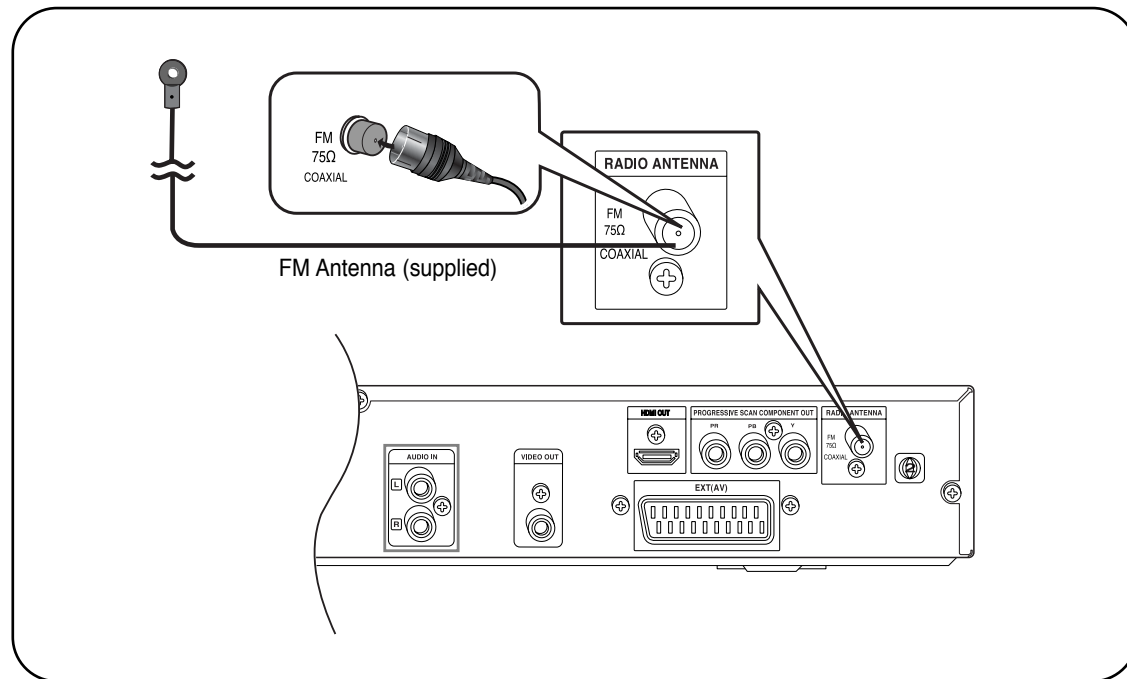

- 1 Connect the FM antenna supplied to the FM 75Ω COAXIAL terminal.
- 2 Slowly move the antenna wire around until you find a location where reception is good, then fasten it to a wall or other rigid surface.

Note • This unit does not receive AM broadcasts.

Cooling Fan

The cooling fan supplies cool air to the unit to prevent overheating.

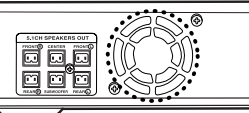

Please observe the following cautions for your safety.

- Make sure the unit is well-ventilated. If the unit has poor ventilation, the temperature inside the unit could rise and may damage it.
- Do not obstruct the cooling fan or ventilation holes. (If the cooling fan or ventilation holes are covered with a newspaper or cloth, heat may build up inside the unit and fire may result.)

Before Using Your Home Theater

Your Home Theater is capable of playing DVD, VCD, CD, MP3/WMA and JPEG discs. Depending on the disc you are using, these instructions may vary slightly. Read the instructions carefully before using.

To Operate your Samsung TV and the Home Theater with the HT-THQ22/HT-THQ25's Remote Control

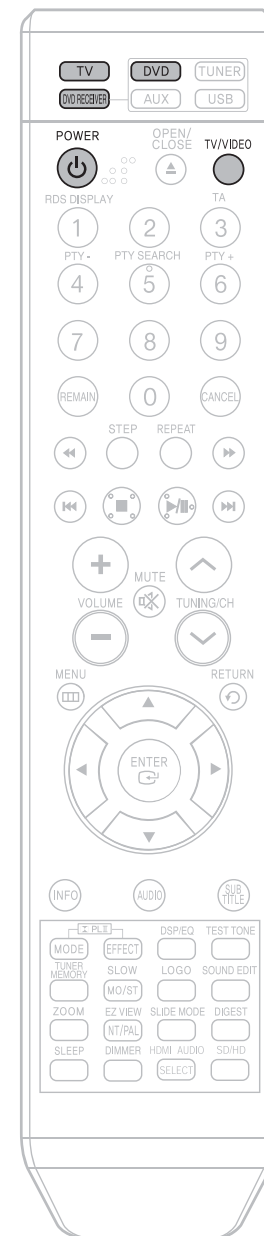

- 1 Plug the main unit's power cord into the AC power supply.
- 2 Press TV button to set the remote to TV mode.
- 3 Press the **POWER** button to turn on your Samsung TV with this remote.
- 4 Press **TV/VIDEO** button to select VIDEO mode on your TV.
- 5 Press **DVD RECEIVER** button to switch to DVD RECEIVER mode.
- 6 Press **FUNCTION** button on the main unit or DVD button on the remote to enable DVD/CD playback.

Selecting the Video Format

Press and hold **NT/PAL** button on the remote controller for over 5 seconds while the power is turned off.

- By default, the video format is set to "PAL".
- "NTSC" or "PAL" will appear in the display. At this time, press the **NT/PAL** button shortly to select between "NTSC" and "PAL".
- Each country has a different video format standard.
- For normal playback, the video format of the disc must be the same as the video format of your TV.

Note • Buttons Enabled for TV Operation: POWER, CHANNEL, VOLUME, TV/VIDEO, and Numeric (0-9) buttons.

• By default, the remote control is set to work with Samsung TVs.

See page 67 for more information about remote control operation with other manufacturer's TVs.

Disc terminology

Titles and chapters (DVD-VIDEO)

- DVD-video is divided into several large sections called "titles" and smaller sections called "chapters". Numbers are allotted to these sections. These numbers are called "title numbers" and "chapter numbers".

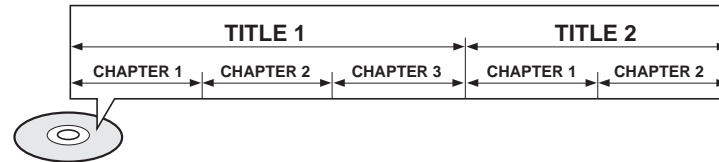

Tracks (Video and music CDs)

- Video and music CDs are divided into sections called "tracks". Numbers are allotted to these sections. These numbers are called "track numbers".

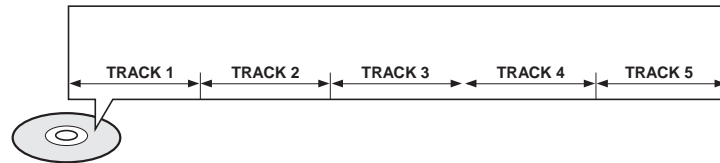

Files (DivX)

- DivX is divided into sections called "files". Numbers are allotted to these sections. These numbers are called "file numbers".

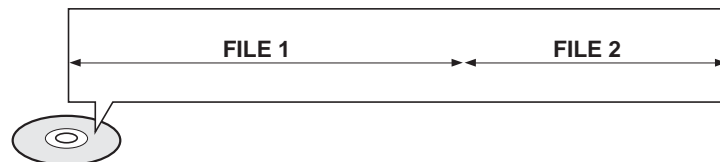

- Note**
- In this manual, the instructions marked with "DVD (DVD)" are applicable to DVD-VIDEO and DVD-R/RW discs. Where a particular DVD type is mentioned, it is indicated separately.
 - Depending on the content of the disc, the initial screen may appear different.



1 Press **OPEN/CLOSE** button to open the disc tray.

2 Load a disc.
• Place a disc gently into the tray with the disc's label facing up.

3 Press **OPEN/ CLOSE** button to close the disc tray.



- Playback starts automatically.

To stop playback, press **STOP** during playback.

- If pressed once, "PRESS PLAY" is displayed and the stop position will be stored in memory. If **PLAY/PAUSE** (▶/||) button or **ENTER** button is pressed, playback resumes from the stop position. (This function works only with DVDs.)
- If pressed twice, "STOP" is displayed, and if **PLAY/PAUSE** (▶/||) button is pressed, playback starts from the beginning.

To temporarily pause playback, press **PLAY/PAUSE** during playback.

- To resume playback, press **PLAY/PAUSE** (▶/||) button again.

What is Content Scrambling System (CSS)?

The Content Scrambling System is a copy protection device that prevents the content of a DVD from being copied into the HDD of the PC as it is, unlike other media, executable directly from the PC. And it is also a data decryption system that decrypts the key encryption with the encrypted title key (of the DVD title) and the player key (of the DVD player).

Note

- Depending on the content of the disc, the initial screen may appear different.
- Any piracy could not be runnable in the player. Otherwise, it violates the CSS recommendations.

MP3/WMA-CD Playback

Data CDs (CD-ROM, CD-R, CD-RW) encoded in MP3/WMA format can be played.

1 Press the **OPEN/CLOSE** button to open the disc tray, and then load the MP3/WMA disc.

- The MP3/WMA menu screen will appear and playback will start.
- The appearance of the menu depends on the MP3/WMA disc.
- WMA-DRM files cannot be played.

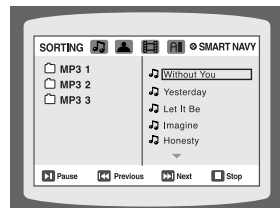

2 In Stop mode, use **◀▶▲▼** to select the album, and then press the **ENTER** button.

- Use **▲▼** to select the track.

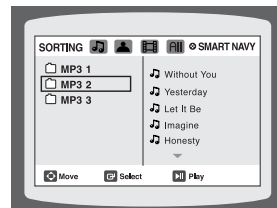

3 To change the album, use **◀▶▲▼** to select another album in Stop mode, and then press the **ENTER** button.

- To select another album and track, repeat Steps 2 and 3 above.

- Note**
- Depending on the recording mode, some MP3/WMA-CDs may not play.
 - Table of contents of a MP3-CD varies depending on the MP3/WMA track format recorded on the disc.

4 Press the **STOP** button to stop playback.

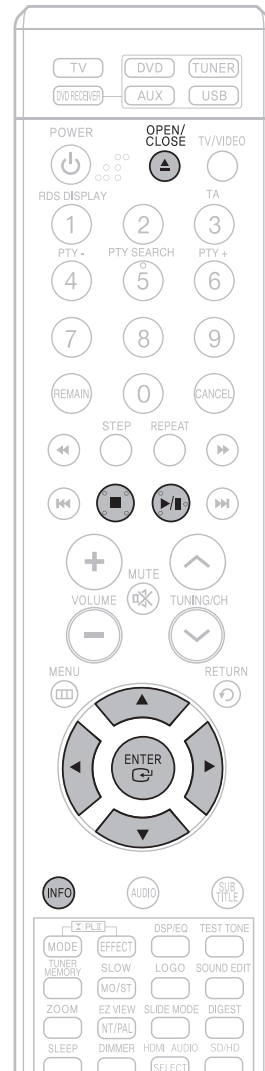

To play a file icon in the screen,

Press the **◀▶▲▼** button when it is in stop status and select a desired icon from the top part of the menu.

- To play music files only, select the icon.
- To view image files only, select the icon.
- To view movie files only, select the icon.
- To select all files select the icon.

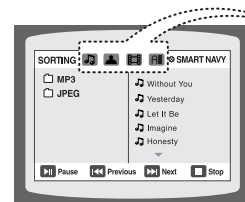

- Music File Icon
- Image File Icon
- Movie File Icon
- All File Icon

Displaying Disc Information

You can view disc playback information on the TV screen.

Press **INFO** button.

- Each time the button is pressed, the display changes as follows:

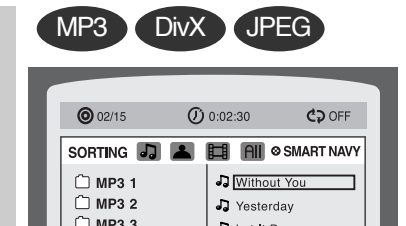

The information Display disappears from the screen

The information Display disappears from the screen

appears on the TV screen!

If this symbol appears on the TV screen while buttons are being operated, that operation is not possible with the disc currently being played.

The information Display disappears from the screen

Note

- Depending on the disc, the disc information display may appear different.
- Depending on the disc, you can also select DTS, DOLBY DIGITAL, or PRO LOGIC.

- **What is a Title?**
A movie contained in a DVD-VIDEO disc.
- **What is a Chapter?**
Each title on a DVD disc is divided into several smaller sections called "chapters".
- **What is a Track (File)?**
A section of video or a music file recorded on a CD, or MP3-CD.

Screen Display

- | | | | |
|-----------------|----------------------|-------------------------|-------------------------|
| DVD DVD display | TITLE display | ELAPSED TIME display | LR STEREO (L/R) display |
| VCD VCD display | CHAPTER display | REPEAT PLAYBACK display | DOLBY DIGITAL display |
| CD CD display | TRACK (FILE) display | AUDIO LANGUAGE display | ANGLE display |
| | | SUBTITLE display | |

JPEG File Playback JPEG

Images captured with a digital camera or camcorder, or JPEG files on a PC can be stored on a CD and then played back with this Home Theater.

Slide Mode

1 Place the JPEG disc on the disc tray.

2 Press **SLIDE MODE** button.

- Playback starts automatically.
- Each time the button is pressed, the image makes the transition as follows:

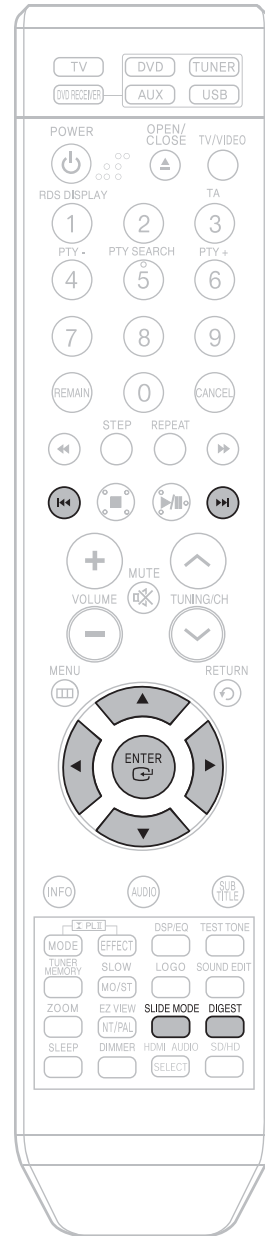
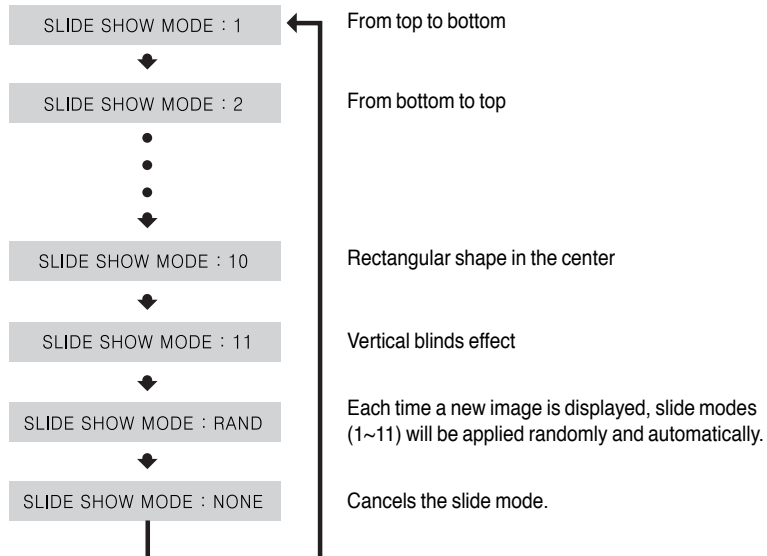

Press **◀◀▶▶** to skip to the next slide.

- Each time the button is pressed, the slide moves backward or forward.

Digest Function

You can view 9 JPEG images on the TV screen.

1 Press **DIGEST** button during playback.

- JPEG files will be shown in 9 windows.



2 Press Cursor **▲, ▼, ◀, ▶** buttons to select the desired image and then press **ENTER** button.

- The selected image is played for 5 seconds before moving to the next image.



To view the previous or next image with 9 windows, press **◀◀▶▶**.

Rotate/Flip Function

Press Cursor **▲, ▼, ◀, ▶** buttons during playback.

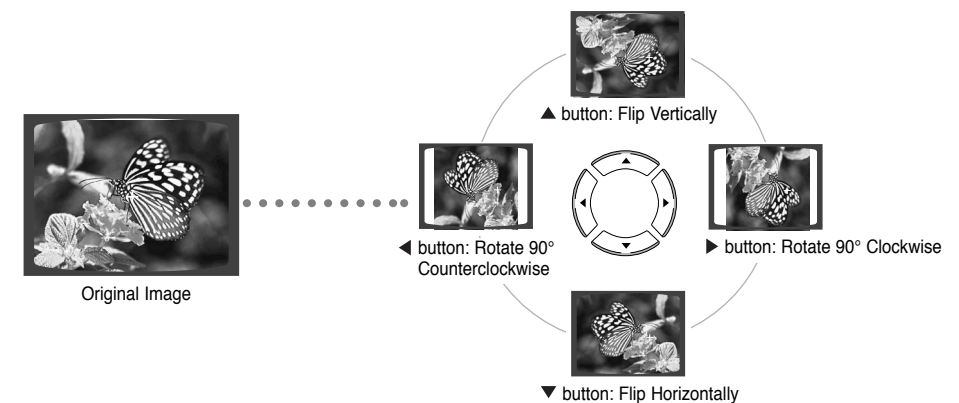

Note

- The maximum resolutions supported by this product are 5120 x 3480 (or 19.0 MPixel) for standard JPEG files and 2048 x 1536 (or 3.0 MPixel) for progressive image files.

DivX Playback

The functions on this page apply to DIVX disc playback.

Skip Forward/Back

During playback, press the **⏮ ⏭** button.

- Goes to the next file whenever you press **⏭** button, if there are over 2 files in the disk.
- Goes to the previous file whenever you press **⏮** button, if there are over 2 files in the disk.

Fast playback

To play back the disc at a faster speed, press **⏮** or **⏭** during playback.

- Each time you press either button, the playback speed will change as follows:
2x → 4x → 8x → 32x → Normal.

5 Minute Skip function

During playback, press the **⏮, ⏭** button.

- Playback skips 5 minutes forward whenever you press **⏭** button.
- Playback skips 5 minutes back whenever you press **⏮** button.

Zoom Function

1 Press **ZOOM** button.

2 Press Cursor **▲, ▼, ◀, ▶** buttons to move to the area you want to enlarge.

- Each time you press the button, your selection will toggle between "ZOOM X2" and "ZOOM OFF".

Note

- DIVX file can be zoomed only in ZOOM X2 mode.
- DivX files have .Avi file extensions, however, not all .Avi files are DivX and may not be playable in this unit.

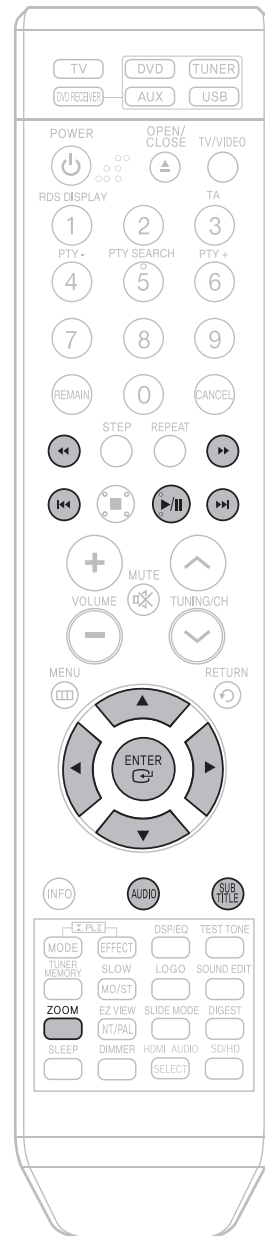

Subtitle Display

Press the **SUBTITLE** button.

- Each time you press the button, your selection will toggle between "SUBTITLE (1/8, 2/8 ...)" and "SUBTITLE OFF".
- If the disc has only one subtitle file, it will be played automatically.
- See number 2 (Caption Function) below for more details concerning Subtitle usage with DIVX discs.

Audio Display

Press the **AUDIO** button.

- If there are multiple audio tracks on a disc, you can toggle between them.
- Each time you press the button, your selection will toggle between "AUDIO(1/8, 2/8 ...)" and "👉".

Note

- "👉" is displayed when there is one supported language in the disc.

DivX(Digital internet video eXpress)

DivX is a video file format developed by Microsoft and is based on MPEG4 compression technology to provide audio and video data over the Internet in real-time. MPEG4 is used for video encoding and MP3 for audio encoding so that the users can watch a movie at near DVD-quality video and audio.

1. Supported Formats

- This product only supports the following media formats. If both video and audio formats are not supported, the user may experience problems such as broken images or no sound.

• Supported Video Formats

Format	AVI	WMV
Supported Versions	DivX3.11 ~ 5.1	V1/V2/V3/V7

• Supported Audio Formats

Format	MP3	WMA	AC3	DTS
Bit Rate	80~384kbps	56~128kbps	128~384kbps	1.5Mbps
Sampling Frequency	44.1khz		44.1/48khz	44.1khz

- DivX files, including audio and video files, created in the DTS format can only support up to 6Mbps.
- Aspect Ratio: Although default DivX resolution is 640*480 pixels (4:3), this product supports up to 720*480 pixels (16:9). TV screen resolutions higher than 800 will not be supported.
- When you play a disc whose sampling frequency is higher than 48khz or 320kbps, you may experience shaking on the screen during playback.

2. Caption Function

- You must have some experience with video extraction and editing in order to use this feature properly.
- To use the caption function, save the caption file (*.smi) in the same file name as that of the DivX media file (*.avi) within the same folder.

Example. Root Samsung_007CD1.avi
Samsung_007CD1.smi

- Up to 60 alphanumeric characters or 30 East Asian characters (2 byte characters such as Korean and Chinese) for the file name.

Checking the Remaining Time

Press the **REMAIN** button.

- For checking the total and remaining time of a title or chapter being played.

Each time the **REMAIN** button is pressed

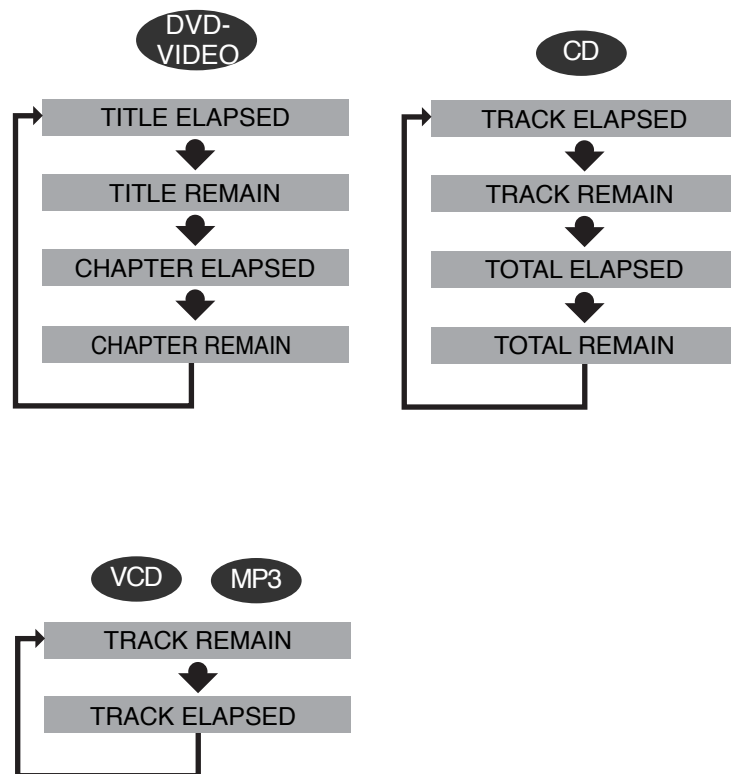

Fast/Slow Playback

Fast Playback

DVD VCD CD MP3

Press **◀▶▶▶**.

- Each time the button is pressed during playback, the playback speed changes as follows:

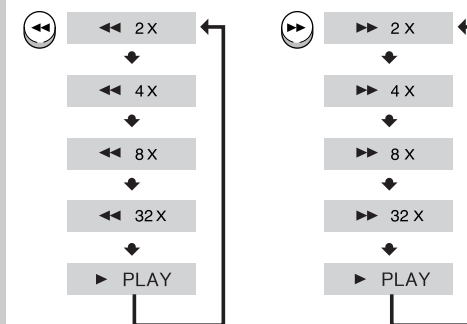

Note

- During fast playback of a CD or MP3-CD, sound is heard only at 2x speed, and not at 4x, 8x, and 32x speeds.

Slow Playback

Press **SLOW** button.

- Each time the button is pressed during playback, the playback speed changes as follows:

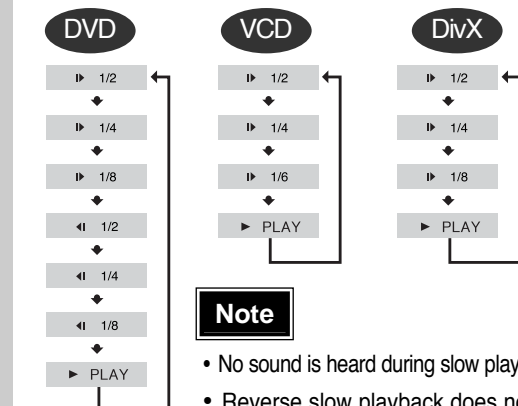

Note

- No sound is heard during slow playback.
- Reverse slow playback does not work with VCD and DivX.

Skipping Scenes/Songs

Press **◀▶▶▶**.

- Each time the button is pressed during playback, the previous or next chapter, track, or directory (file) will be played.
- You cannot skip chapters consecutively.

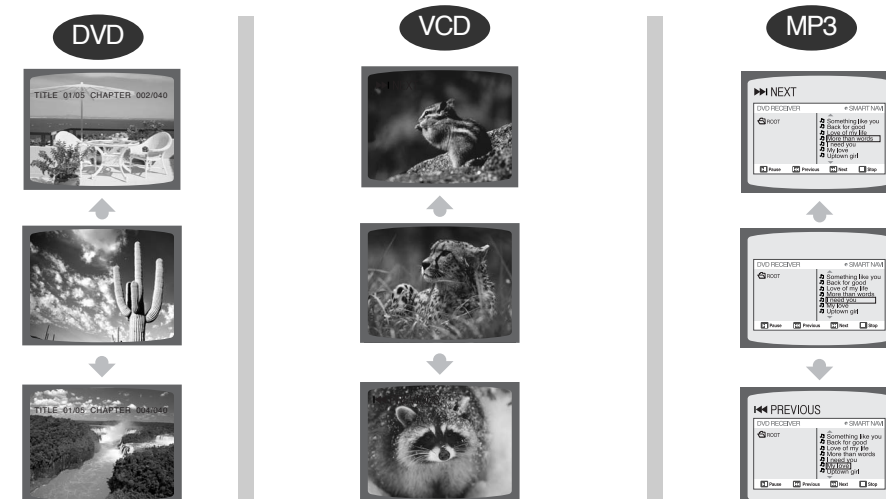

- When watching a VCD with a track longer than 15 minutes, each time **◀▶▶▶** is pressed, playback will skip back or forward 5 minutes.

Repeat Playback

Repeat playback allows you to repeatedly play a chapter, title, track (song), or directory (MP3 file).

DVD VCD CD MP3 JPEG

Press **REPEAT** button.

- Each time the button is pressed during playback, the repeat playback mode changes as follows:

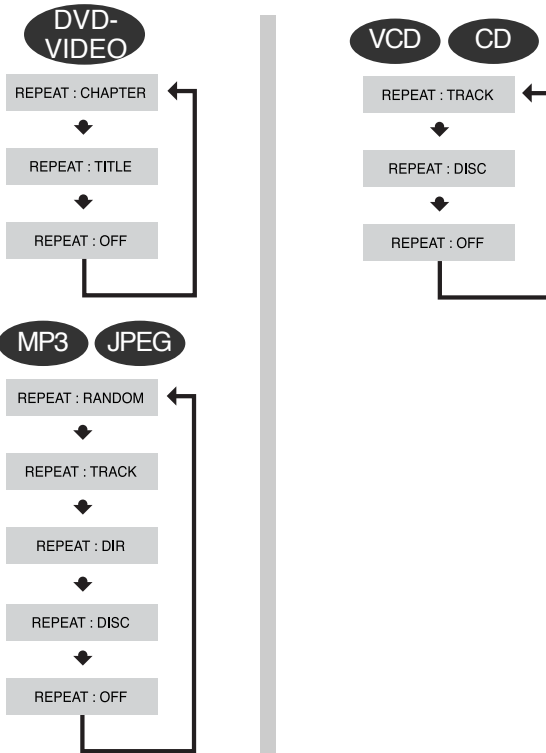

Repeat Playback Options

- CHAPTER**
Repeatedly plays the selected chapter.
- TITLE**
Repeatedly plays the selected title.
- RANDOM**
Plays tracks in random order.
(A track that has already been played may be played again.)
- TRACK**
Repeatedly plays the selected track.
- DIR**
Repeatedly plays all tracks in the selected folder.
- DISC**
Repeatedly plays the entire disc.
- OFF**
Cancels Repeat Playback.

Note

- Repeat playback operation is not possible with version 2.0 VCD discs if PBC is turned on. To use Repeat Playback on a VCD with PBC, you should set the MENU to OFF in the disc menu. (See page 40.)

To Select a Repeat Playback Mode in the Disc Information Screen

- Press **INFO** button twice.
- Press Cursor **▶** button to move to REPEAT PLAYBACK (↻) display.
- Press Cursor **▼** button to select the desired Repeat Playback mode.
- Press **ENTER** button.

* For MP3 and JPEG discs, you cannot select Repeat Play from the information display screen.

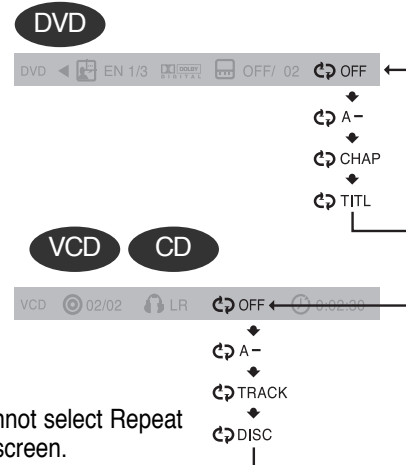

A-B Repeat Playback

You can repeatedly play back a designated section of a DVD.

GB

DVD VCD

- Press **INFO** button twice.

- For a VCD, press **INFO** button once.

DVD ◀ EN 1/3 OFF/02 ↻ OFF

- Press Cursor **▶** button to move to REPEAT PLAYBACK (↻) display.

DVD ◀ EN 1/3 OFF/02 ↻ OFF

- Press Cursor **▲**, **▼** buttons to select 'A-' and then press **ENTER** button at the beginning of the desired segment.

- When **ENTER** button is pressed, the selected position will be stored in memory.

DVD ◀ EN 1/3 OFF/02 ↻ A-

DVD ◀ EN 1/3 OFF/02 ↻ A-?
REPEAT : A-

- Press **ENTER** button at the end of the desired segment.

- The specified segment will be played repeatedly.

DVD ◀ EN 1/3 OFF/02 ↻ A-B
REPEAT : A-B

- To return to normal playback, press Cursor **▲**, **▼** buttons to select **↻ OFF**.

Note

- The A-B Repeat function does not operate with MP3, CD or JPEG discs.

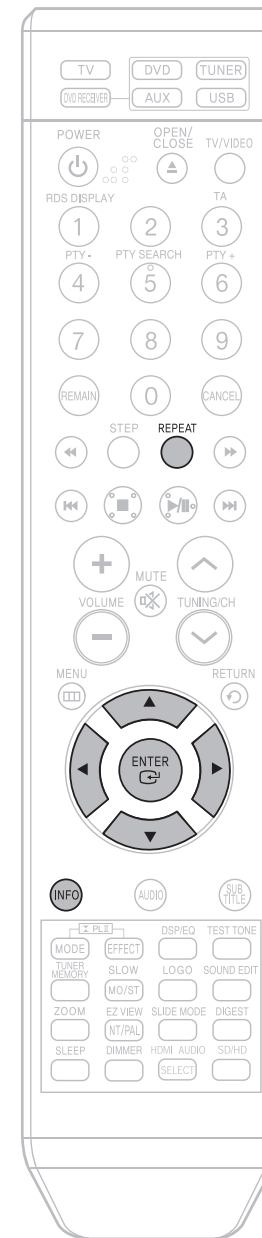

OPERATION

Step Function DVD VCD

Press **STEP** button.

- The picture moves forward one frame each time the button is pressed during playback.

Note • No sound is heard during step motion playback.



Angle Function DVD

This function allows you to view the same scene in different angles.

1 Press **INFO** button.

2 Press Cursor **▶** button to move to **ANGLE (&)** display.

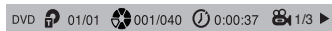

3 Press Cursor **▲, ▼** or numeric buttons to select the desired angle.

- Each time the button is pressed, the angle changes as follows:

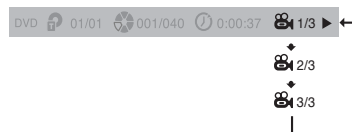

Note • The Angle function works only with discs on which multiple angles have been recorded.

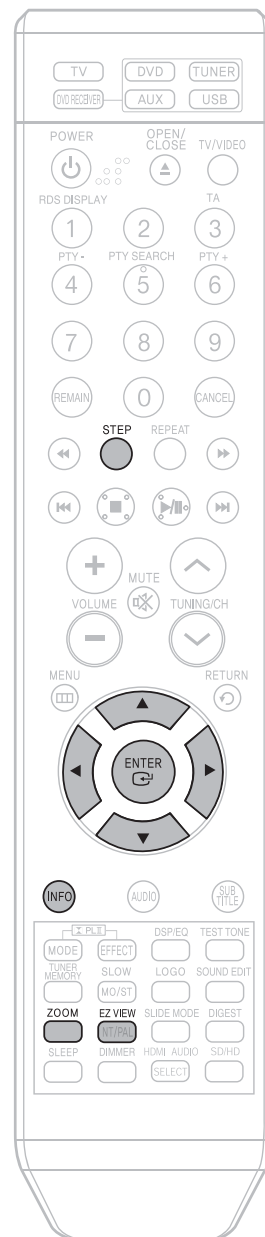

Zoom (Screen Enlarge) Function DVD VCD

This function allows you to enlarge a particular area of the displayed image.

1 Press **ZOOM** button.



2 Press Cursor **▲, ▼, ◀, ▶** buttons to move to the area you want to enlarge.



3 Press **ENTER** button.

- Each time the button is pressed, the zoom level changes as follows:

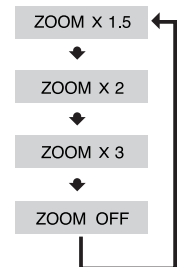

Note • When a DivX disc is being played, only the 2:1 zoom-in is available.

EZ VIEW Function DVD

Press **EZ VIEW** button.

- Each time the button is pressed, the zoom function will switch between On and Off.
- When a movie is played in Widescreen format, black bars at the top and bottom of the TV screen can be removed by pressing the **EZ VIEW** button.

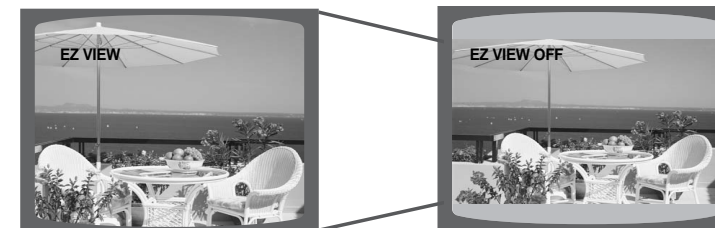

Note

- This function will not work if the DVD is recorded with multi-camera angle format.
- Black bars may not disappear because some DVD discs have a built-in horizontal to vertical ratio.
- This feature is not supported for DivX discs.

Selecting Audio Language

Audio Language Selection Function

1 Press **INFO** button twice.

DVD ◀ EN 1/3  OFF/ 02  OFF

2 Press Cursor **▲**, **▼** buttons or numeric buttons to select the desired audio language.

- Depending on the number of languages on a DVD disc, a different audio language (ENGLISH, SPANISH, FRENCH, etc.) is selected each time the button is pressed.

DVD ◀ EN 1/3  OFF/ 02  OFF

SP 2/3
FR 3/3

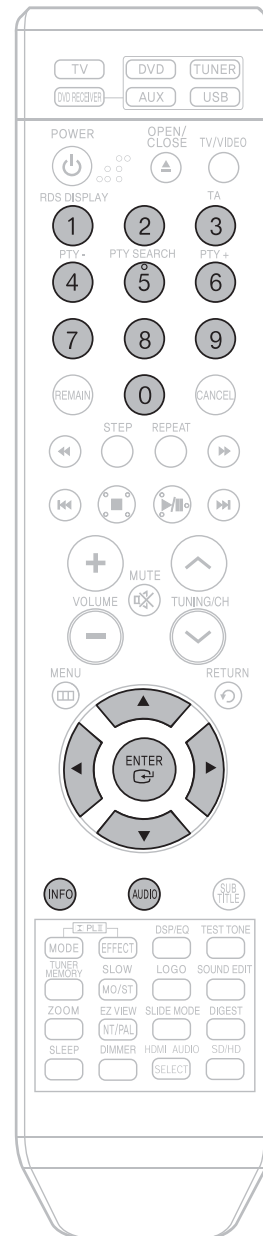

Selecting Subtitle Language

GB

Subtitle Language Selection Function

1 Press **INFO** button twice.

DVD ◀ EN 1/3  OFF/ 02  OFF

2 Press Cursor **▶** button to move to **SUBTITLE** () display.

DVD ◀ EN 1/3  OFF/ 02  OFF

3 Press Cursor **▼** button or numeric buttons to select the desired subtitle.

DVD ◀ EN 1/3  EN 01/ 03  OFF

SP 02/ 03
FR 03/ 03
OFF / 03

Note

- To operate this function, you can also press the Select AUDIO or Select SUBTITLE buttons on the remote control.
- Depending on the disc, the Subtitle and Audio Language functions may not be available.



OPERATION

Playing Media Files using the USB HOST feature

You can enjoy media files such as pictures, movies and music saved in an MP3 player, USB memory or digital camera in high quality video with 5.1 channel home theater sound by connecting the storage device to the USB port of the home theater.

- 1 Connect the USB device to the USB port on the front of the unit.

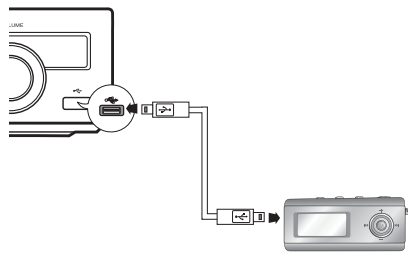

- 2 Press the **FUNCTION** button on the main unit or the **USB** button on the remote control to select the USB mode.

- "USB" appears on the display screen and then disappears.
- USB MENU screen appears on the TV screen and the saved file is played.

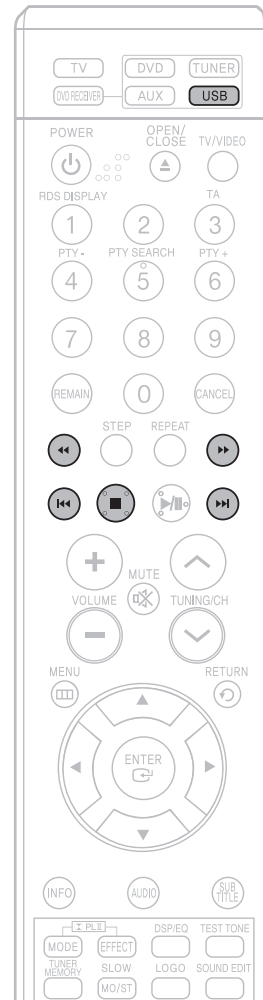
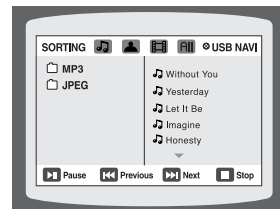

To stop playback, press the **STOP** (■) button.

Safe USB Removal

To prevent damage to the memory stored in the USB device, perform safe removal before disconnecting the USB cable.

- (1) Press the Stop button twice in a row.
The display will show **REMOVE → USB**.
- (2) Remove the USB cable.

Skip Forward/Back

During playback, press the **⏮** or **⏭** button.

- When there is more than one file, when you press the **⏭** button, the next file is selected.
- When there is more than one file, when you press the **⏮** button, the previous file is selected.

Fast playback

To play back the disc at a faster speed, press **⏮** or **⏭** during playback.

- Each time you press either button, the playback speed will change as follows: 2x → 4x → 8x → 32x → Normal.

Compatible Devices

1. USB devices that support USB Mass Storage v1.0.
(USB devices that operate as a removable disk in Windows (2000 or later) without additional driver installation.)
2. MP3 Player: HDD and flash type MP3 players.
3. Digital camera: Cameras that support USB Mass Storage v1.0.
 - Cameras that operate as a removable disk in Windows (2000 or later) without additional driver installation.
4. USB HDD and USB Flash Drive: Devices that support USB2.0 or USB1.1.
 - You may experience a difference in playback quality when you connect a USB1.1 device.
 - For a USB HDD, make sure to connect an auxiliary power cord to the USB HDD for proper operation.
5. USB card Reader: One slot USB card reader and Multi slot USB card reader
 - Depending on the manufacturer, the USB card reader may not be supported.
 - If you install multiple memory devices into a multi card reader, you may experience problems.
6. If you use a USB extension cable, the USB device might not be recognized.

Supported Formats

	File name	File extension	Bit rate	Version	Pixel	Sampling Frequency
Still Picture	JPG	JPG .JPEG	–	–	640*480	–
Music	MP3	.MP3	80~384kbps	–	–	44.1kHz
	WMA	.WMA	56~128kbps	V8	–	44.1kHz
Movie	VCD	MPG.MPEG .DAT	1.5Mbps	VCD1.1,VCD2.0	320*480	44.1KHz
	WMV	.WMV	4Mbps	V1,V2,V3,V7	720*480	44.1KHz~48KHz
	DivX	.AVI,.ASF	4Mbps	DivX3.11~DivX5.1,Xvid	720*480	44.1KHz~48KHz

- CBI (Control/Bulk/Interrupt) is not supported.
- Digital Cameras that use PTP protocol or require additional program installation when connected to a PC are not supported.
- A device using NTFS file system is not supported.
(Only FAT 16/32 (File Allocation Table 16/32) file system is supported.)
- Some MP3 players, when connected to this product, may not operate depending on the sector size of their file system.
- The USB HOST function is not supported if a product that transfers media files by its manufacturer-specific program is connected.
- Does not operate with Janus enabled MTP(Media Transfer Protocol) devices.
- **The USB host function of this product does not support all USB devices. For information on the supported devices, see page 73.**

Moving Directly to a Scene/Song

DVD VCD CD

1 Press **INFO** button.

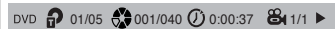

Moving to a Title/Track

2 Press Cursor **▲**, **▼** buttons or numeric buttons to select the desired title/track and then press **ENTER** button.



Moving to a Chapter

3 Press Cursor **◀**, **▶** buttons to move to Chapter () display.

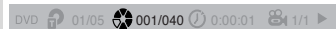

Moving to a Chapter

4 Press Cursor **▲**, **▼** buttons or numeric buttons to select the desired chapter and then press **ENTER** button.



Moving to a Specific Time

5 Press Cursor **◀**, **▶** buttons to move to time display.



Moving to a Specific Time

6 Press the numeric buttons to select the desired time and then press **ENTER** button.



MP3 JPEG

Press the **numeric** buttons.

- The selected file will be played.
- When playing an MP3 or JPEG disc, you cannot use **▲**, **▼** to move to a folder. To move a folder, press **■** (Stop) and then press **▲**, **▼**.

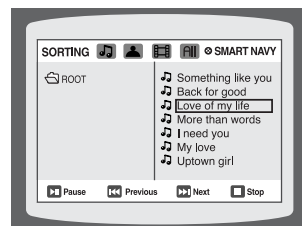

Note

- You can press **◀◀▶▶** on the remote control to move directly to the desired title, chapter, or track.
- Depending on the disc, you may not be able to move to the selected title or time.

Using Disc Menu

You can use the menus for the audio language, subtitle language, profile, etc. DVD menu contents differ from disc to disc.

1 In Stop mode, press **MENU** button.

- When playing a VCD (version 2.0), this toggles between MENU ON and OFF.



2 Press Cursor **▲**, **▼** buttons to move to 'DISC MENU' and then press **ENTER** button.

- When you select Disc Menu and it is not supported by the disc, the "This menu is not supported" message appears on the screen.



3 Press Cursor **▲**, **▼**, **◀**, **▶** buttons to select the desired item.

- Press **ENTER** button.



Note

- Disc menu display may be different depending on the disc.

MENU ON/OFF (PBC) Function

When playing a VCD (version 2.0), you can select and view various scenes according to the menu screen.

MENU ON: This VCD disc is version 2.0. The disc is played back according to the menu screen. Some functions may be disabled. When some functions are disabled, select "MENU OFF" to enable them.

MENU OFF: This VCD disc is version 1.1. The disc is played back in the same way as with a music CD.

Using the Title Menu

For DVDs containing multiple titles, you can view the title of each movie. Depending on the disc, the availability of this feature may vary.

1 In Stop mode, press **MENU** button.



2 Press Cursor **▲**, **▼** button to move to 'Title Menu'.



3 Press **ENTER** button.

- The title menu appears.



Press **MENU** button to exit the setup screen.

Note

- Title menu display may be different depending on the disc.

Setting the Language

OSD(On-Screen Display) language is set to English by default.

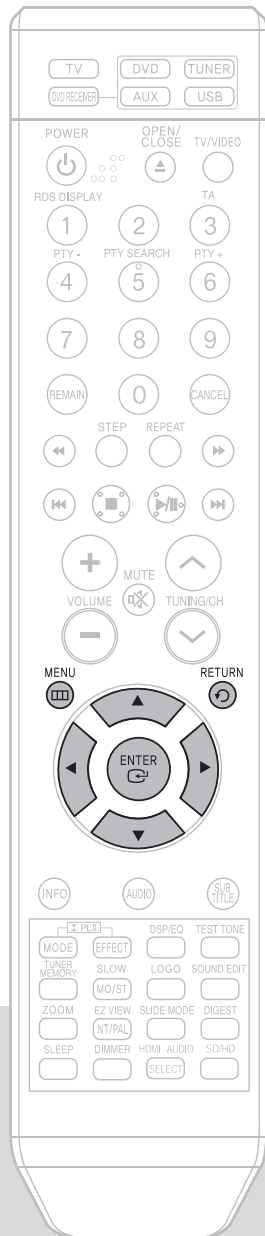

1 In Stop mode, press **MENU** button.

2 Press Cursor **▼** button to move to 'Setup' and then press **ENTER** button.

3 Select 'Language' and then press **ENTER** button

4 Press Cursor **▲, ▼** button to select 'OSD Language' and then press **ENTER** button.

5 Press Cursor **▲, ▼** button to select the desired language and then press **ENTER** button.

- Once the setup is complete, the OSD will be English if English has been selected as language.

- Press **RETURN** button to return to the previous level.
- Press **MENU** button to exit the setup screen.

SETUP

Note

To select another language, select OTHER and enter the language code of your country. (See page 72 for language codes)
AUDIO, SUB TITLE and DISC MENU language can be selected.

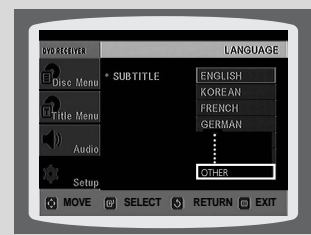

Selecting the OSD Language



Selecting the Audio Language (recorded on the disc)



Selecting the Subtitle Language (recorded on the disc)



Selecting the Disc Menu Language (recorded on the disc)

* If the language you selected is not recorded on the disc, menu language will not change even if you set it to your desired language.

Setting TV Screen type

Depending on your TV type (Wide Screen or conventional 4:3), you can select the TV's aspect ratio.



1 In Stop mode, press **MENU** button.



2 Press Cursor **▼** button to move to 'Setup' and then press **ENTER** button.



3 Press Cursor **▼** button to move to 'TV DISPLAY' and then press **ENTER** button.

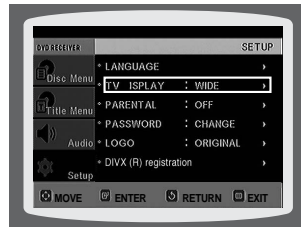

4 Press Cursor **▲, ▼** button to select the desired item and then press **ENTER** button.

• Once the setup is complete, you will be taken to the previous screen.



Adjusting the TV Aspect Ratio (Screen Size)

The horizontal to vertical screen size ratio of conventional TVs is 4:3, while that of widescreen and high definition TVs is 16:9. This ratio is called the aspect ratio. When playing DVDs recorded in different screen sizes, you should adjust the aspect ratio to fit your TV or monitor.

• For a standard TV, select either "4:3LB" or "4:3PS" option according to personal preference. Select "16:9" if you have a widescreen TV.

WIDE

: Select this to view a 16:9 picture in the full-screen mode on your widescreen TV.
• You can enjoy the widescreen aspect.



4:3LB (4:3 Letterbox)

: Select this to play a 16:9 picture in the letter box mode on a conventional TV.
• Black bars will appear at the top and bottom of the screen.



4:3PS (4:3 Pan&Scan)

: Select this to play a 16:9 picture in the pan & scan mode on a conventional TV.
• You can see the central portion of the screen only (with the sides of the 16:9 picture cut off).



Note

• If a DVD is in the 4:3 ratio, you cannot view it in widescreen.
• Since DVD discs are recorded in various image formats, they will look different depending on the software, the type of TV, and the TV aspect ratio setting.

Press **RETURN** button to return to the previous level.

Press **MENU** button to exit the setup screen.

Setting Parental Controls (Rating Level)

Use this to restrict playback of adult or violent DVDs you do not want children to view.

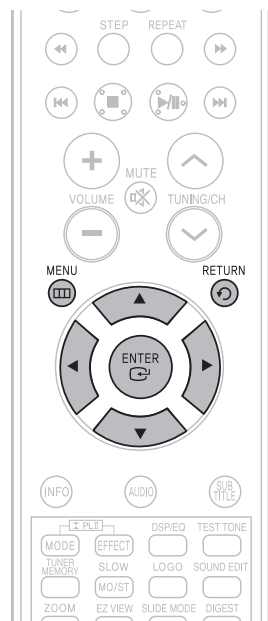

1 In Stop mode, press **MENU** button.



2 Press Cursor **▼** button to move to 'Setup' and then press **ENTER** button.

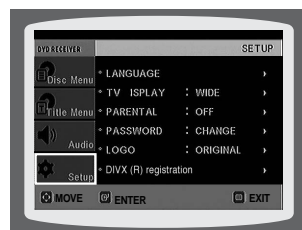

3 Press Cursor **▼** button to move to 'PARENTAL' and then press **ENTER** button.

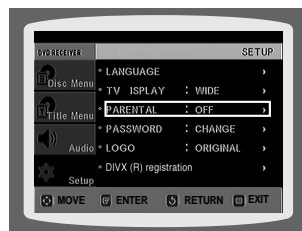

4 Press Cursor **▲**, **▼** button to select the desired rating level and then press **ENTER** button.

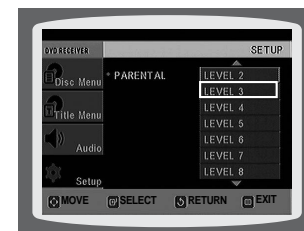

5 Enter the password and then press **ENTER** button.

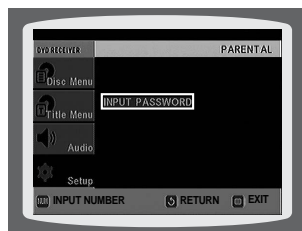

- If you have selected Level 6, you cannot view DVDs with Level 7 or higher.
- The higher the level, the closer the content is to violent or adult material.

- The password is set to "7890" by default.
- Once the setup is complete, you will be taken to the previous screen.

Note • This function works only if a DVD disc contains the rating level information.

Press **RETURN** button to return to the previous level.

Press **MENU** button to exit the setup screen.

Setting the Password

You can set the password for the Parental (rating level) setting.

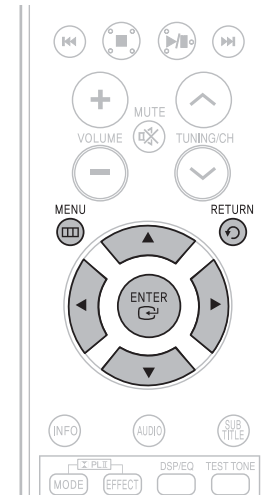

1 Press **MENU** button.



2 Press Cursor **▼** button to move to 'Setup' and then press **ENTER** button.



3 Press Cursor **▼** button to move to 'PASSWORD' and then press **ENTER** button.

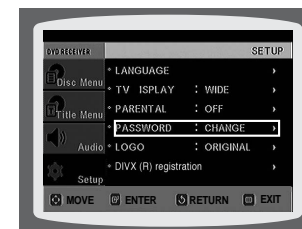

4 Press **ENTER** button.



5 Enter the password and then press **ENTER** button.

- Enter the old password, a new password, and confirm new password.
- The setting is complete.

Note • The password is set to "7890" by default.

If you have forgotten the rating level password, do the following:

- While the player is in the no disc mode, hold the main unit's  button for longer than 5 seconds. "INITIALIZE" appears on the display and all settings will return to the default values.
- Press the POWER button.

Using the RESET function will erase all stored settings. Do not use this unless necessary.

Setting the Wallpaper

JPEG DVD VCD

While watching a DVD, VCD or JPEG CD, you can set the image you like as background wallpaper.

Setting the Wallpaper

1 During playback, press **PLAY/PAUSE** button when an image you like appears.



2 Press **LOGO** button.

- "COPY LOGO DATA" will be displayed on the TV screen.



3 The power will turn off and then back on.

- The selected wallpaper will be displayed.
- You can select up to 3 wallpaper settings.



To select one of the 3 wallpaper settings you've made

1 In Stop mode, press **MENU** button.



2 Press Cursor **▼** button to move to 'Setup' and then press **ENTER** button.



3 Press Cursor **▼** button to move to 'LOGO' and then press **ENTER** button.

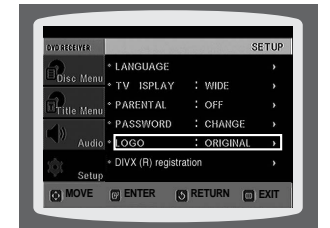

4 Press **▼** to select the desired 'USER', and then press **ENTER**.

- This selects one of the 3 wallpaper screens



5 Press **MENU** button to exit the setup screen.



Select this to set the Samsung Logo image as your wallpaper.



Select this to set the desired image as your wallpaper.

Press **RETURN** button to return to the previous level.

Press **MENU** button to exit the setup screen.

DivX (R) registration

Please use the Registration code to register this player with the DivX (R) video on demand format. To learn more, go to www.divx.com/vod.



1 Press the **MENU** button while the disc tray is open.



2 Press Cursor **▼** button to move to 'Setup' and then press **ENTER** button.



3 Press Cursor **▼** button to move to 'DIVX(R) registration' and then press **ENTER** button.



Setting the Speaker Mode

Signal outputs and frequency responses from the speakers will automatically be adjusted according to your speaker configuration and whether certain speakers are used or not.

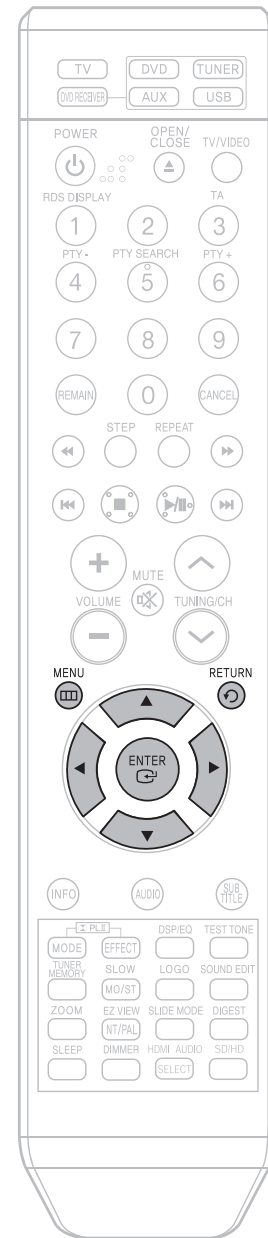

1 In Stop mode, press **MENU** button.



2 Press Cursor **▼** button to move to 'Audio' and then press **ENTER** button.



3 In the Speaker Setup, press the **ENTER** button again.



4 Press Cursor **▲, ▼, ◀, ▶** buttons to move to the desired speaker and then press **ENTER** button.

- For C, SL, and SR, each time the button is pressed, the mode switches alternately as follows: SMALL → NONE.
- For L and R, the mode is set to SMALL.

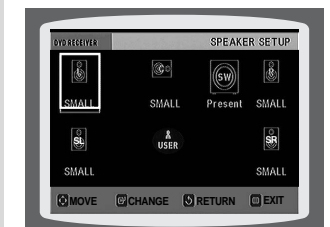

SMALL : Select this when using the speakers.
NONE : Select this when no speakers are connected.

Note

- Depending on PRO LOGIC and STEREO settings, the speaker mode may vary (see page 59).

Setting the Delay Time

If the speakers cannot be placed at equal distances from the listening position, you can adjust the delay time of the audio signals from the center and rear speakers.

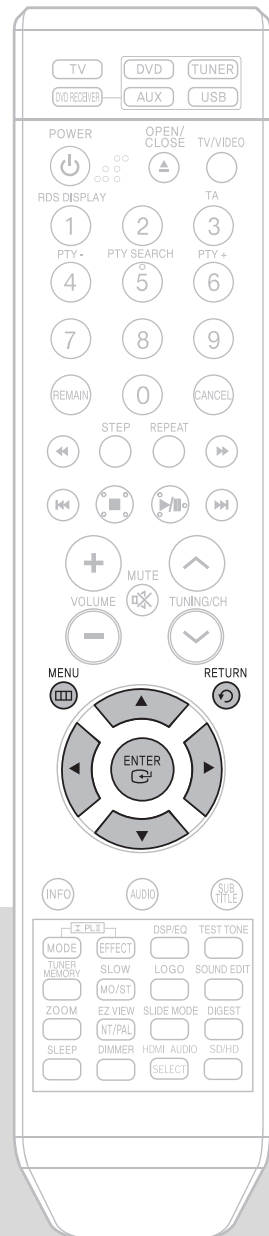

1 In Stop mode, press **MENU** button.



2 Press Cursor **▼** button to move to 'Audio' and then press **ENTER** button.



3 Press Cursor **▼** button to move to 'DELAY TIME' and then press **ENTER** button.



4 Press Cursor **▲, ▼, ◀, ▶** buttons to move to the desired speaker and then press **ENTER** button.



5 Press Cursor **◀, ▶** to set the Delay time.

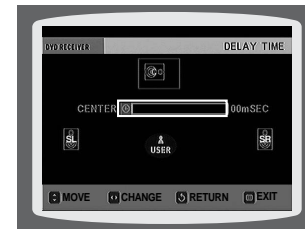

- You can set the delay time for C between 00 and 05mSEC and for SL and SR between 00 and 15mSEC.

Setting up the Speaker Delay Time

When 5.1CH Surround Sound is played, you can enjoy the best sound if the distance between you and each speaker is the same. Since the sounds arrive at the listening position at different times depending on the placement of speakers, you can adjust this difference by adding a delay effect to the sound of the Center and Surround Speakers.

Note

- With DOLBY II (Dolby Pro Logic II), the delay time may be different for each mode.
- With AC-3 and DTS, the delay time can be set between 00 and 15mSEC.
- The Center channel is only adjustable on 5.1 channel discs.

Setting CENTER SPEAKER

If the distance of D_c is equal to or longer than the distance of D_f in the figure, set the mode as 0ms. Otherwise, change the setting according to the table.

Distance between D_f and D_c	Delay Time
0.00 m	0 ms
0.34 m	1 ms
0.68 m	2 ms
1.02 m	3 ms
1.36 m	4 ms
1.70 m	5 ms

Setting REAR (SURROUND) SPEAKERS

If the distance of D_f is equal to the distance of D_s in the figure, set the mode as 0ms. Otherwise, change the setting according to the table.

Distance between D_f and D_s	Delay Time
0.00 m	0 ms
1.02 m	3 ms
2.04 m	6 ms
3.06 m	9 ms
4.08 m	12 ms
5.10 m	15 ms

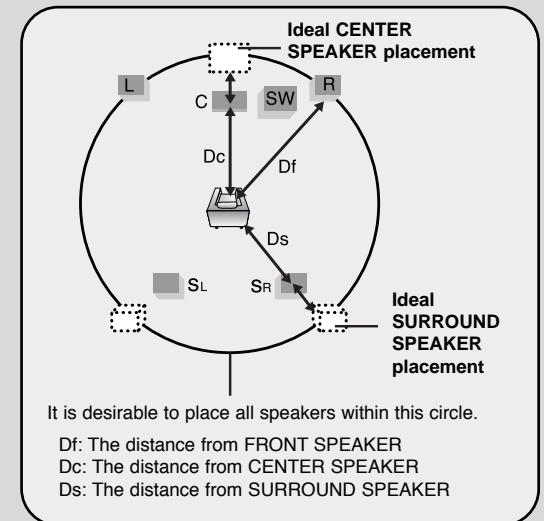

Setting the Test Tone

Use the Test Tone feature to check the speaker connections.

1 In Stop or no disc mode, press **MENU** button.



2 Press Cursor **▼** button to move to 'Audio' and then press **ENTER** button.



3 Press Cursor **▼** button to move to 'TEST TONE' and then press **ENTER** button.

- The test tone will be sent to L → C → R → SR → SL → SW in order. If the **ENTER** button is pressed again at this time, the test tone will stop.



Press **RETURN** button to return to the previous level.

Press **MENU** button to exit the setup screen.

Alternative method: press the **TEST TONE** button on the remote.

Press **TEST TONE** button.

- Test tone will be produced as follows:
When playing a DVD or CD, this will work only in Stop mode.
- Use this function to check that each speaker is correctly connected and that there is no problem.

To end the test tone, press **TEST TONE** button again.

L: Front Speaker (L) C: Center Speaker SW: Subwoofer
R: Front Speaker (R) SL: Rear Speaker (L) SR: Rear Speaker (R)

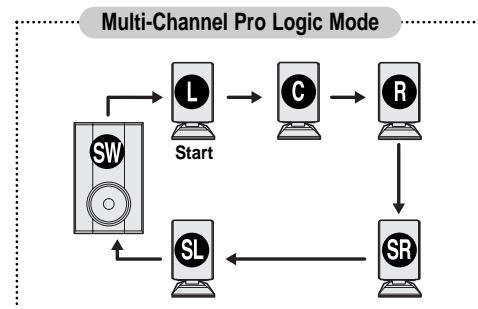

Setting the DRC (Dynamic Range Compression)

This feature balances the range between the loudest and quietest sounds. You can use this function to enjoy Dolby Digital sound when watching movies at low volume at night.

1 In Stop or no disc mode, press **MENU** button.



2 Press Cursor **▼** button to move to 'Audio' and then press **ENTER** button.



3 Press Cursor **▼** button to move to 'DRC' and then press **ENTER** button.

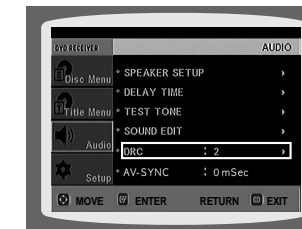

4 Press Cursor **▲**, **▼** to adjust the 'DRC'.

- When the Cursor **▲** button is pressed, the effect is greater, and when the Cursor **▼** button is pressed, the effect is smaller.

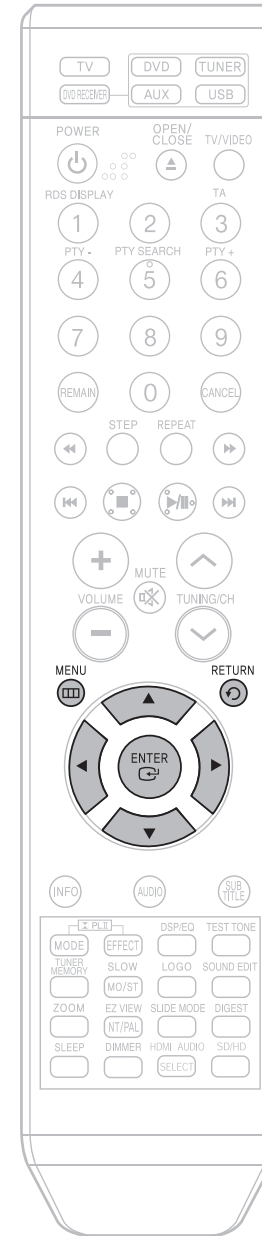
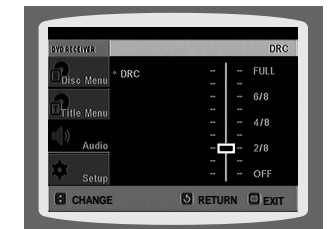

Press **RETURN** button to return to the previous level.

Press **MENU** button to exit the setup screen.

Setting the Audio

You can adjust the balance and level for each speaker.

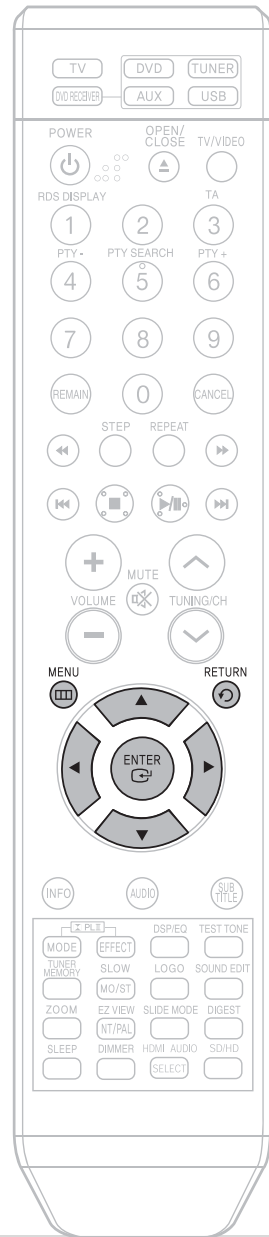

Method 1 When adjusting the audio quality using the setup screen

- 1** In Stop mode, press **MENU** button.
- 2** Press Cursor **▼** button to move to 'Audio' and then press **ENTER** button.
- 3** Press Cursor **▼** button to move to 'SOUND EDIT' and then press **ENTER** button.
- 4** Press Cursor **▲, ▼** buttons to select and adjust the desired item. Press the **◀, ▶** buttons to adjust the settings.

Method 2 When manually adjusting with the SOUND EDIT button

Adjusting Front Speaker Balance

- 1** Press **SOUND EDIT** button and then press Cursor **◀, ▶**.

Adjusting Rear Speaker Balance

- 2** Press **SOUND EDIT** button and then press Cursor **◀, ▶**.

Adjusting Center Speaker Level

- 3** Press **SOUND EDIT** button and then press Cursor **◀, ▶**.

Adjusting Rear Speaker Level

- 4** Press **SOUND EDIT** button and then press Cursor **◀, ▶**.

Adjusting Subwoofer Speaker Level

- 5** Press **SOUND EDIT** button and then press Cursor **◀, ▶**.

SETUP

- Press **RETURN** button to return to the previous level.
- Press **MENU** button to exit the setup screen.

Note

- Adjusting Front/Rear Speaker Balance**
 - You can select between 00 and -06 and OFF.
 - The volume decreases as you move closer to -6.
- Adjusting Center/Rear/Subwoofer Speaker Level**
 - The volume level can be adjusted in steps from +6dB to -6dB.
 - The sound gets louder as you move closer to +6dB and quieter as you get closer to -6dB.

AV SYNC Setup

Video may look slower than the audio if it is connected to a digital TV.
If this occurs, adjust the audio delay time to match the video.

1 Press the **MENU** button.



2 Press Cursor **▲**, **▼** buttons to move to 'Audio' and then press **ENTER** button.



3 Press Cursor **▲**, **▼** buttons to move to 'AV-SYNC' and then press **ENTER** button.

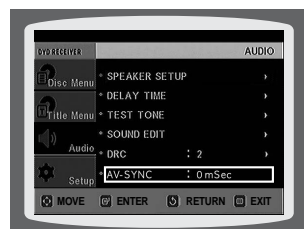

4 Press Cursor **▲**, **▼** buttons to select the AV-SYNC Delay Time and then press the **ENTER** button.

- You can set the audio delay time between 0 ms and 300 ms. Set it to the optimal status.

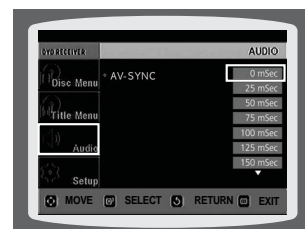

Press **RETURN** button to return to the previous level.

Press **MENU** button to exit the setup screen.

Sound Field (DSP)/EQ Function

DSP(Digital Signal Processor) DSP modes have been designed to simulate different acoustic environments.
EQ: You can select ROCK, POP, or CLASSIC to optimize the sound for the genre of music you are playing

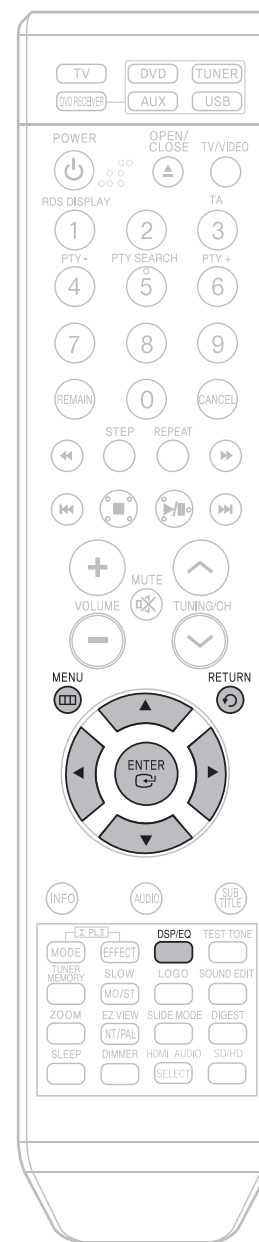

Press **DSP/EQ** button.

- "DSP" appears on the display panel.
- Each time the button is pressed, the selection changes as follows:

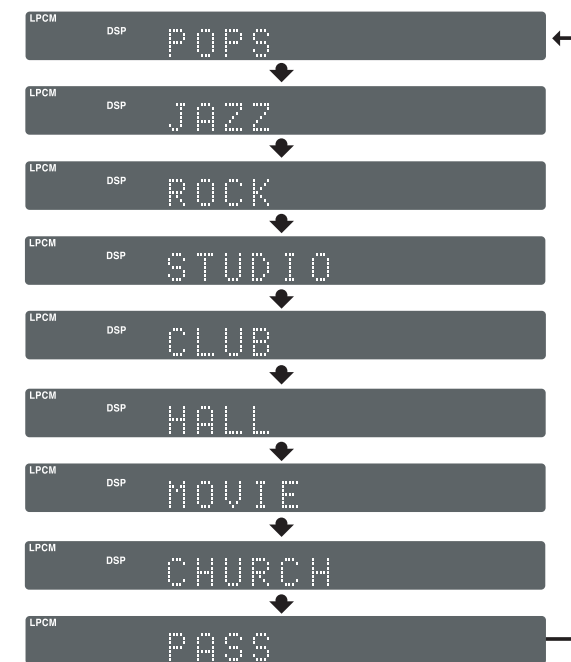

- Note**
- DSP/EQ function is only available in STEREO mode. Press the **PL II** mode button to show STEREO on the display.
 - This feature works with CDs, MP3-CDs, 2 channel DivX and Dolby Digital discs.
 - When playing a DVD disc encoded with two or more channels, multi-channel mode will be selected automatically and DSP/EQ function does not work.

- POP, JAZZ, ROCK:** Depending on the genre of music, you can select POP, JAZZ, and ROCK.
- STUDIO :** Provides a sense of presence as if in a studio.
- CLUB :** Simulates the sound of a dance club with a throbbing bass beat.
- HALL :** Provides a clear vocal as if listening in a concert hall.
- MOVIE:** Provides the feeling of a movie theater.
- CHURCH:** Gives the feel of being in a grand church.
- PASS:** Select this for normal listening.

Dolby Pro Logic II Mode

You can select the desired Dolby Pro Logic II audio mode.

Press **PL II MODE** button.

- Each time the button is pressed, the mode changes as follows.



Note

- When selecting Pro Logic II mode, connect your external device to the AUDIO INPUT jacks (L and R) on the player. If you connect to only one of the inputs (L or R), you cannot listen to surround sound.



PRO LOGIC II

- **MUSIC:** When listening to music, you can experience sound effects as if you are listening to the actual performance.
 - **CINEMA:** Adds realism to the movie soundtrack.
 - **PRO LOGIC:** You will experience a realistic multi-channel effect, as if using five speakers, while using just the front left and right speakers.
 - **MATRIX:** You will hear 5.1 channel surround sound.
- STEREO:** Select this to listen to sound from the front left and right speakers and the subwoofer only.

Dolby Pro Logic II Effect

This function works only in Dolby Pro Logic MUSIC mode.

1 Press **PL II MODE** button to select 'MUSIC' mode.



2 Press **PL II EFFECT** button to select Panorama, then press Cursor **←**, **→** buttons to select the desired effect setting.

- You can select either 0 or 1.
- This mode extends the front stereo image to include the surround speakers for an exciting "wraparound" effect with side wall imaging.



3 Press **PL II EFFECT** button to select C-Width, then press Cursor **←**, **→** buttons to select the desired effect setting.

- You can select between 0 and 7.
- This sets the width of the center image. The higher the setting, the less sound comes from the center speaker.



4 Press **PL II EFFECT** button to select Dimension, then press the Cursor **←**, **→** buttons to select the desired setting.

- You can select between 0 and 6.
- Incrementally adjusts the sound field (DSP) from the front or rear.



Note

- When playing a DVD disc encoded with two or more channels, multi-channel mode will be selected automatically and **PL II** (Dolby Pro Logic II) button does not work.

Listening to Radio

Presetting Stations

Remote Control Unit

1 Press the **TUNER** button to select the FM band.

2 Tune in to the desired station.

Automatic Tuning 1 When **◀▶▶▶▶** is pressed, a preset broadcast station is selected.

Automatic Tuning 2 Press and hold **TUNING/CH** to automatically search for active broadcasting stations.

Manual Tuning Briefly press **TUNING/CH** to increase or decrease the frequency incrementally.

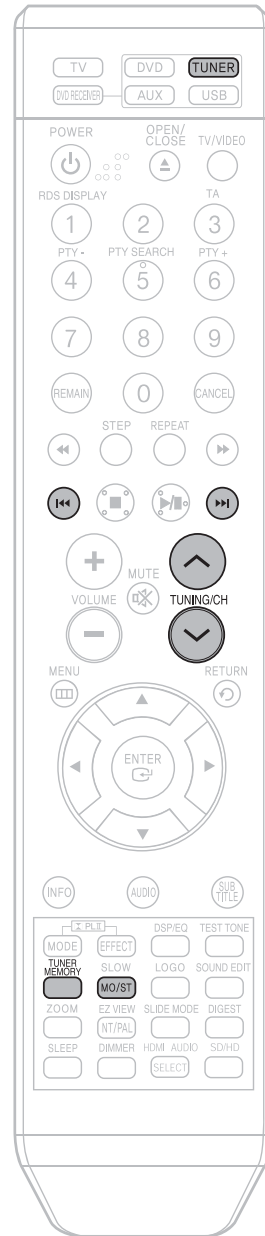

Main Unit

1 Press the **FUNCTION** button to select the FM band.

2 Select a broadcast station.

Automatic Tuning 1 Press the **STOP** (■) button to select PRESET and then press **◀▶▶▶▶** button to select the preset station.

Automatic Tuning 2 Press the **STOP** (■) button to select "MANUAL" and then press and hold **◀▶▶▶▶** button to automatically search the band.

Manual Tuning Press **STOP** (■) to select MANUAL and then briefly press **◀▶▶▶▶** to tune in to a lower or higher frequency.

Example: Presetting FM 89.10 in the memory

1 Press the **TUNER** button to select the FM band.

2 Press **TUNING/CH** to select "89.10".

3 Press the **TUNER MEMORY** button.

- Refer to Step 2 on page 61 to automatically or manually tune in to a station.

- "PRGM" flashes in the display.

FM 91.90 MHz

FM 89.10 MHz

PRGM FM 89.10 MHz

4 Press **◀▶▶▶▶** to select preset number.

5 Press the **TUNER MEMORY** button again.

6 To preset another station, repeat steps 2 to 5.

- You can select between 1 and 15 presets.

- Press the **TUNER MEMORY** button before 'PRGM' disappears from the display.
- 'PRGM' disappears from the display and the station is stored in memory.

2 FM 89.10 MHz

FM 89.10 MHz

Note • This unit does not receive AM broadcasts.

Press **MO/ST** button to listen in Mono/Stereo. (This applies only when listening to an FM station.)

- Each time the button is pressed, the sound switches between "STEREO" and "MONO".
- In a poor reception area, select MONO for a clear, interference-free broadcast.

To tune in to a preset station, press **◀▶▶▶▶** on the remote control to select a channel.

Using the RDS (Radio Data System) to receive FM stations

RDS allows FM stations to send an additional signal along with their regular program signals. For example, the stations send their station names, as well as information about what type of program they broadcast, such as sports or music, etc.

When tuned to an FM station which provides the RDS service, the RDS indicator lights up on the display.

Description on RDS function

- 1. PTY (Program Type)** : Displays the type of programme currently being broadcast
- 2. PS NAME (Program Service Name)** : Indicates the name of broadcasting station and is composed of 8 characters.
- 3. RT (Radio Text)** : Decodes the text broadcast by a station (if any) and is composed of maximum 64 characters.
- 4. CT (Clock Time)** : Decodes the real time clock from the FM frequency.
 - Some stations may not transmit PTY, RT or CT information therefore this may not be displayed in all cases.
- 5. TA (Traffic Announcement)** : When this symbol flashes it shows that the traffic announcement is in progress.

Note • RDS may not operate correctly if the station tuned is not transmitting RDS signal properly or if the signal strength is weak.

What information can RDS signals provide?

You can see the RDS signals the station sends on the display.

TO show the RDS signals

Press RDS DISPLAY while listening to an FM station.

Each time you press the button, the display change to show you the following information:



PS (Program Service) :While searching, "PS" appears and then the station names will be displayed. "NO PS" appears if no signal is sent.

RT(Radio Text) : while searching, "RT" appears and then text messages the station sends will be displayed. "NO RT" appears if no signal is sent.

Frequency : station frequency (non-RDS service)

About characters shown in the display

When the display shows PS, or RT signals, the following characters are used.

- The display window cannot differentiate upper case and lower case letters and always uses upper case letters.
- The display window cannot show accented letters, "A," for instance, may stand for accented "A's" like "À, Â, Ä, Å and Ã."

Note • If searching finishes at once, "PS", and "RT" will not appear on the display.

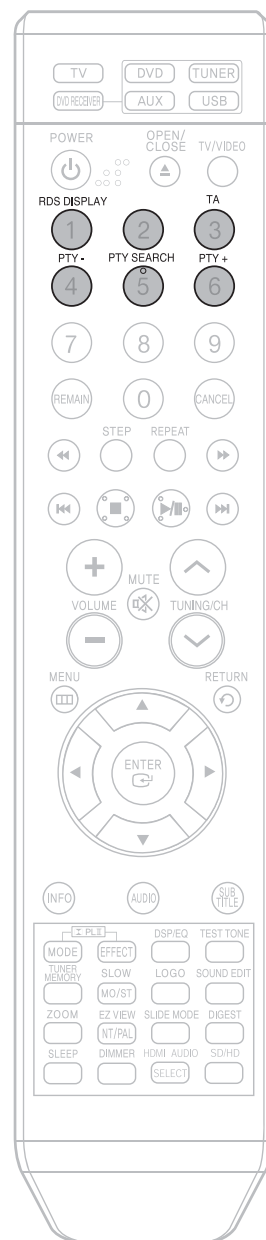

PTY (Program Type) indication and PTY-SEARCH function

One of the advantages of the RDS service is that you can locate a particular kind of program from the preset channels by specifying the PTY codes.

To search for a program using the PTY codes

Before you start, remember...

- The PTY Search is only applicable to preset stations.
- To stop searching any time during the process, press PTY SEARCH while searching.
- There is a time limit in doing the following steps. If the setting is cancelled before you finish, start from step 1 again.
- When pressing the buttons on the primary remote control, make sure that you have selected the FM station using the primary remote control.

1 Press PTY SEARCH while listening to an FM station.

2 Press the PTY-or PTY+until the PTY code you want appears on the display.

- The display gives you the PTY codes described to the right.

3 Press PTY SEARCH again, while the PTY code selected in the previous step is still on the display.

- The center unit searches 15 preset FM stations, stops when it finds the one you have selected, and tunes in that station.

Display	Program Type
NEWS	• News including an announced opinion and report
AFFAIRS	• Several matters including a current incident, documentary, discussion and analysis.
INFO	• Information including weights and measures, returns and forecast, matters interesting the customer, medical information, etc.
SPORT	• Sports
EDUCATE	• Education
DRAMA	• Drama-Radio serial, etc.
CULTURE	• Culture-National or local culture including the religious problem, social science, language, theater, etc.
SCIENCE	• Natural science and technology
VARIED	• Others-Speech, amusing program (quiz, game), interview, comedy and satirical play, etc.
POP M	• Pop music
ROCK M	• Rock music
M.O.R.M	• Current contemporary music considered to be "easy listening."
LIGHT M	• Light classical music- Classical music and instrumental and chorus music
CLASSICS	• Heavy classical music-Orchestra music, symphony, chamber music and opera
OTHER M	• Other music - Jazz, R&B country music
WEATHER	• Weather
FINANCE	• Finance
CHILDREN	• Children's programmes
SOCIAL A	• Social affairs
RELIGION	• Religion
PHONE IN	• Phone in
TRAVEL	• Travel
LEISURE	• Leisure
JAZZ	• Jazz Music
COUNTRY	• Country Music
NATION M	• National Music
OLDIES	• Oldies Music
FOLK M	• Folk Music
DOCUMENT	• Documentary

Sleep Timer Function

You can set the time that the Home Theater will shut itself off.

Press **SLEEP** button.

- "SLEEP" will be displayed. Each time the button is pressed, the preset time changes as follows: 10 → 20 → 30 → 60 → 90 → 120 → 150 → OFF.



To confirm the sleep timer setting, press **SLEEP** button.

- The remaining time before the Home Theater will shut itself off is displayed.
- Pressing the button again changes the sleep time from what you have set earlier.

To cancel the sleep timer, press **SLEEP** button until OFF appears on the display.



Adjusting Display Brightness

You can adjust the brightness of the display on the main unit so it won't interfere with your movie viewing.

Press **DIMMER** button.

- Each time the button is pressed, the brightness changes as follows: DARK → BRIGHT.

Mute Function

This is useful when answering a doorbell or telephone call.

Press **MUTE** button.

- 'MUTE' flash in the display.
- To restore the sound, press the button again.



Operating a TV with the Remote Control



When operating a TV with the remote control

1 Press **TV** button to set the remote to TV mode.

2 Press **POWER** button to turn on the TV.

3 Point the remote control toward the TV.

4 While holding down **POWER**, enter the code corresponding to your brand of TV.

- If the code matches the TV's code, the TV will be turned off.
- If there is more than one code listed for your TV in the table, enter one at a time to determine which code works.

Example: For a Samsung TV

While holding down **POWER**, use the number buttons to enter 00, 15, 16, 17 and 40.

5 Point the remote control toward the TV and press **POWER**. If the TV turns off or on, the setting is complete.

- You can use the TV **POWER**, **VOLUME**, **CHANNEL**, and **Numeric** buttons (0~9).

Note

- The remote control may not work on some brands of TVs. Also, some operations may not be possible depending on your brand of TV.
- If you do not set the remote control with the code for your brand of TV, the remote control will work on a Samsung TV by default.



TV Brand Code List

No.	Brand	Code	No.	Brand	Code
1	Admiral (M.Wards)	56, 57, 58	44	MTC	18
2	A Mark	01, 15	45	NEC	18, 19, 20, 40, 59, 60
3	Anam	01, 02, 03, 04, 05, 06, 07, 08, 09, 10, 11, 12, 13, 14	46	Nikei	03
4	AOC	01, 18, 40, 48	47	Onking	03
5	Bell & Howell (M.Wards)	57, 58, 81	48	Onwa	03
6	Brocsonic	59, 60	49	Panasonic	06, 07, 08, 09, 54, 66, 67, 73, 74
7	Candle	18	50	Penney	18
8	Cetronic	03	51	Philco	03, 15, 17, 18, 48, 54, 59, 62, 69, 90
9	Citizen	03, 18, 25	52	Philips	15, 17, 18, 40, 48, 54, 62, 72
10	Cinema	97	53	Pioneer	63, 66, 80, 91
11	Classic	03	54	Portland	15, 18, 59
12	Concerto	18	55	Proton	40
13	Contec	46	56	Quasar	06, 66, 67
14	Coronado	15	57	Radio Shack	17, 48, 56, 60, 61, 75
15	Craig	03, 05, 61, 82, 83, 84	58	RCA/Proscan	18, 59, 67, 76, 77, 78, 92, 93, 94
16	Croslex	62	59	Realistic	03, 19
17	Crown	03	60	Sampo	40
18	Curtis Mates	59, 61, 63	61	Samsung	00, 15, 16, 17, 40, 43, 46, 47, 48, 49, 59, 60, 98
19	CXC	03	62	Sanyo	19, 61, 65
20	Daewoo	02, 03, 04, 15, 16, 17, 18, 19, 20, 21, 22, 23, 24, 25, 26, 27, 28, 29, 30, 32, 34, 35, 36, 48, 59, 90	63	Scott	03, 40, 60, 61
21	Daytron	40	64	Sears	15, 18, 19
22	Dynasty	03	65	Sharp	15, 57, 64
23	Emerson	03, 15, 40, 46, 59, 61, 64, 82, 83, 84, 85	66	Signature 2000 (M.Wards)	57, 58
24	Fisher	19, 65	67	Sony	50, 51, 52, 53, 55
25	Funai	03	68	Soundesign	03, 40
26	Futuretech	03	69	Spectricon	01
27	General Electric (GE)	06, 40, 56, 59, 66, 67, 68	70	SSS	18
28	Hall Mark	40	71	Sylvania	18, 40, 48, 54, 59, 60, 62
29	Hitachi	15, 18, 50, 59, 69	72	Symphonic	61, 95, 96
30	Inkel	45	73	Tatung	06
31	JC Penny	56, 59, 67, 86	74	Techwood	18
32	JVC	70	75	Teknika	03, 15, 18, 25
33	KTV	59, 61, 87, 88	76	TMK	18, 40
34	KEC	03, 15, 40	77	Toshiba	19, 57, 63, 71
35	KMC	15	78	Vidtech	18
36	LG (Goldstar)	01, 15, 16, 17, 37, 38, 39, 40, 41, 42, 43, 44	79	Videch	59, 60, 69
37	Luxman	18	80	Wards	15, 17, 18, 40, 48, 54, 60, 64
38	LXI (Sears)	19, 54, 56, 59, 60, 62, 63, 65, 71	81	Yamaha	18
39	Magnavox	15, 17, 18, 48, 54, 59, 60, 62, 72, 89	82	York	40
40	Marantz	40, 54	83	Yupiteru	03
41	Matsui	54	84	Zenith	58, 79
42	MGA	18, 40	85	Zonda	01
43	Mitsubishi/MGA	18, 40, 59, 60, 75	86	Dongyang	03, 54

Before Calling for Service

Refer to the chart below when this unit does not function properly. If the problem you are experiencing is not listed below or if the instruction below does not help, turn off the unit, disconnect the power cord, and contact the nearest authorized dealer or Samsung Electronics Service Center.

Symptom	Check/Remedy
Disc tray does not open.	<ul style="list-style-type: none"> • Is the power cord plugged securely into the outlet? • Turn off the power and then turn it back on.
Playback does not start.	<ul style="list-style-type: none"> • Check the region number of the DVD. DVD discs purchased from abroad may not be playable. • CD-ROMs and DVD-ROMs cannot be played on this Home Theater. • Make sure that the rating level is correct.
Playback does not start immediately when the Play/Pause button is pressed.	<ul style="list-style-type: none"> • Are you using a deformed disc or a disc with scratches on the surface? • Wipe the disc clean.
Sound is not produced.	<ul style="list-style-type: none"> • No sound is heard during fast playback, slow playback, and step motion playback. • Are the speakers connected properly? Is the speaker setup correctly customized? • Is the disc severely damaged?
Sound can be heard only from a few speakers and not all six.	<ul style="list-style-type: none"> • When listening to a CD or radio, sound is output to the front speakers (L/R) only. Select "PRO LOGIC II" by pressing  PL II (Dolby Pro Logic II) on the remote control to use all six speakers. • Make sure that the DVD disc is 5.1-CH compatible. • If you set C, SL, and SR to NONE in the speaker mode in the audio setup of the setup screen, no sound is heard from the center speaker and the front left and right speakers. Set C, SL, and SR to SMALL.
Picture does not appear, sound is not produced, or the disc tray opens 2 to 5 seconds later.	<ul style="list-style-type: none"> • Was the Home Theater suddenly moved from a cold place to a warm one? When condensation forms inside the player, remove the disc and let the player stand for 1 or 2 hours with the power on. (You can use the player again after condensation disappears.)
Dolby Digital 5.1 CH Surround Sound is not produced.	<ul style="list-style-type: none"> • Is there "Dolby Digital 5.1 CH" mark on the disc? Dolby Digital 5.1 CH Surround Sound is produced only if the disc is recorded with 5.1 channel sound. • Is the audio language correctly set to DOLBY DIGITAL 5.1-CH in the information display?

Symptom	Check/Remedy
<ul style="list-style-type: none"> • Disc is rotating but no picture is produced. • Picture quality is poor and picture is shaking. 	<ul style="list-style-type: none"> • Is the TV power on? • Are the video cables connected properly? • Is the disc dirty or damaged? • A poorly manufactured disc may not be playable.
The remote control does not work.	<ul style="list-style-type: none"> • Is the remote control being operated within its operation range of angle and distance? • Are the batteries exhausted? • Have you selected the mode(TV/DVD) functions of the remote control (TV or DVD) correctly?
Audio language and subtitles do not work.	<ul style="list-style-type: none"> • Audio language and subtitles will not work for DVDs not containing them. And depending on the disc, they may work differently.
Menu screen does not appear even when the menu function is selected.	<ul style="list-style-type: none"> • Are you using a disc that does not contain menus?
Aspect ratio cannot be changed.	<ul style="list-style-type: none"> • You can play 16:9 DVDs in 16:9 WIDE mode, 4:3 LETTER BOX mode, or 4:3 PAN SCAN mode, but 4:3 DVDs can be seen in 4:3 ratio only. Refer to the DVD disc jacket and then select the appropriate function.
<ul style="list-style-type: none"> • The main unit is not working. (Example: The power goes out or strange noise is heard.) • The Home Theater is not working normally. 	<ul style="list-style-type: none"> • Turn off the power and hold the  button on the main unit for longer than 5 seconds. <p>Using the RESET function will erase all stored settings. Do not use this unless necessary.</p>
The password for rating level has been forgotten.	<ul style="list-style-type: none"> • While "NO DISC" message appears on the display of main unit, hold the main unit's  button for longer than 5 seconds. "INITIALIZE" appears on the display and all settings will return to the default values. • Press the POWER button. <p>Using the RESET function will erase all stored settings. Do not use this unless necessary.</p>
Can't receive radio broadcast.	<ul style="list-style-type: none"> • Is the antenna connected properly? • If the antenna's input signal is weak, install an external FM antenna in an area with good reception.

Cautions on Handling and Storing Discs

Small scratches on the disc may reduce sound and picture quality or cause skipping. Be especially careful not to scratch discs when handling them.

● Handling discs

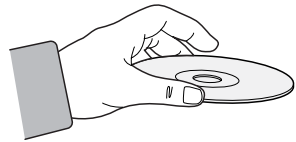

Do not touch the playback side of the disc. Hold the disc by the edges so that fingerprints will not get on the surface. Do not stick paper or tape on the disc.

● Disc Storage

Do not keep in direct sunlight

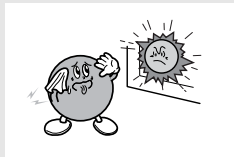

Keep in a cool ventilated area

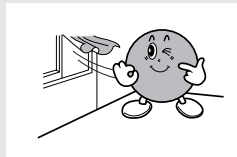

Keep in a clean Protection jacket. Store vertically.

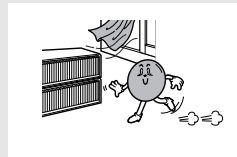

Caution

- Do not allow the discs to become contaminated with dirt.
- Do not load cracked or scratched discs.

● Handling and Storing Discs



When you get fingerprints or dirt on the disc, clean it with a mild detergent diluted in water and wipe with a soft cloth.

- When cleaning, wipe gently from the inside to the outside of the disc.

Note

- Condensation may form if warm air comes into contact with cold parts inside the player. When condensation forms inside the player, the player may not operate correctly. If this occurs, remove the disc and let the player stand for 1 or 2 hours with the power on.

Language Code List

Enter the appropriate code number for the initial settings "Disc Audio", "Disc Subtitle" and/or "Disc Menu" (See page 41).

Code	Language	Code	Language	Code	Language	Code	Language
1027	Afar	1181	Frisian	1334	Latvian, Lettish	1506	Slovenian
1028	Abkhazian	1183	Irish	1345	Malagasy	1507	Samoaan
1032	Afrikaans	1186	Scots Gaelic	1347	Maori	1508	Shona
1039	Amharic	1194	Galician	1349	Macedonian	1509	Somali
1044	Arabic	1196	Guarani	1350	Malayalam	1511	Albanian
1045	Assamese	1203	Gujarati	1352	Mongolian	1512	Serbian
1051	Aymara	1209	Hausa	1353	Moldavian	1513	Siswati
1052	Azerbaijani	1217	Hindi	1356	Marathi	1514	Sesotho
1053	Bashkir	1226	Croatian	1357	Malay	1515	Sundanese
1057	Byelorussian	1229	Hungarian	1358	Maltese	1516	Swedish
1059	Bulgarian	1233	Armenian	1363	Burmese	1517	Swahili
1060	Bihari	1235	Interlingua	1365	Nauru	1521	Tamil
1069	Bislama	1239	Interlingue	1369	Nepali	1525	Tegulu
1066	Bengali; Bangla	1245	Inupiak	1376	Dutch	1527	Tajik
1067	Tibetan	1248	Indonesian	1379	Norwegian	1528	Thai
1070	Breton	1253	Icelandic	1393	Occitan	1529	Tigrinya
1079	Catalan	1254	Italian	1403	(Afan) Oromo	1531	Turkmen
1093	Corsican	1257	Hebrew	1408	Oriya	1532	Tagalog
1097	Czech	1261	Japanese	1417	Punjabi	1534	Setswana
1103	Welsh	1269	Yiddish	1428	Polish	1535	Tonga
1105	Danish	1283	Javanese	1435	Pashto, Pushto	1538	Turkish
1109	German	1287	Georgian	1436	Portuguese	1539	Tsonga
1130	Bhutani	1297	Kazakh	1463	Quechua	1540	Tatar
1142	Greek	1298	Greenlandic	1481	Rhaeto-Romance	1543	Twi
1144	English	1299	Cambodian	1482	Kirundi	1557	Ukrainian
1145	Esperanto	1300	Kannada	1483	Romanian	1564	Urdu
1149	Spanish	1301	Korean	1489	Russian	1572	Uzbek
1150	Estonian	1305	Kashmiri	1491	Kinyarwanda	1581	Vietnamese
1151	Basque	1307	Kurdish	1495	Sanskrit	1587	Volapuk
1157	Persian	1311	Kirghiz	1498	Sindhi	1613	Wolof
1165	Finnish	1313	Latin	1501	Sangro	1632	Xhosa
1166	Fiji	1326	Lingala	1502	Serbo-Croatian	1665	Yoruba
1171	Faeroese	1327	Laothian	1503	Singhalese	1684	Chinese
1174	French	1332	Lithuanian	1505	Slovak	1697	Zulu

USB Host Feature Supported Products

Digital Camera

Product	Company	Type
Finepix-A340	Fuji	Digital Camera
Finepix-F810	Fuji	Digital Camera
Finepix-F610	Fuji	Digital Camera
Finepix-I450	Fuji	Digital Camera
Finepix S7000	Fuji	Digital Camera
Finepix A310	Fuji	Digital Camera
KD-310Z	Konica	Digital Camera
Finecam SL300R	Kyocera	Digital Camera
Finecam SL400R	Kyocera	Digital Camera
Finecam S5R	Kyocera	Digital Camera
Finecam Xt	Kyocera	Digital Camera
Dimage-Z1	Minolta	Digital Camera
Dimage Z1	Minolta	Digital Camera
Dimage X21	Minolta	Digital Camera
Coolpix4200	Nikon	Digital Camera
Coolpix4300	Nikon	Digital Camera
Coolpix 2200	Nikon	Digital Camera
Coolpix 3500	Nikon	Digital Camera
Coolpix 3700	Nikon	Digital Camera
Coolpix 4100	Nikon	Digital Camera
Coolpix 5200	Nikon	Digital Camera
Stylus 410 digital	Olympus	Digital Camera
300-digital	Olympus	Digital Camera
U300	Olympus	Digital Camera
X-350	Olympus	Digital Camera
C-760	Olympus	Digital Camera
C-5060	Olympus	Digital Camera
X1	Olympus	Digital Camera
U-mini	Olympus	Digital Camera
Lumix-FZ20	Panasonic	Digital Camera
DMC-FX7GD	Panasonic	Digital Camera
Lumix LC33	Panasonic	Digital Camera
LUMIX DMC-F1	Panasonic	Digital Camera
Optio-S40	Pentax	Digital Camera
Optio-S50	Pentax	Digital Camera
Optio 33LF	Pentax	Digital Camera
Optio MX	Pentax	Digital Camera
Digimax-420	Samsung	Digital Camera
Digimax-400	Samsung	Digital Camera
Sora PDR-T30	Toshiba	Digital Camera
Coolpix 5900	Nikon	Digital Camera
Coolpix S1	Nikon	Digital Camera
Coolpix 7600	Nikon	Digital Camera
DMC-FX7	Panasonic	Digital Camera
Dimage Xt	Minolta	Digital Camera
AZ-1	Olympus	Digital Camera

USB Flash Disk

Product	Company	Type
Cruzer Micro	Sandisk	USB 2.0 USB Flash Drive 128M
Cruzer Mini	Sandisk	USB 2.0 128M
Cruzer Mini	Sandisk	USB 2.0 256M
SONY Micro Vault	Sony	USB 2.0 64MB
FLEX DRIVE	Serotech	USB 2.0 32MB
AnyDrive	A.L tech	USB 2.0 128MB
XTICK	LG	USB 2.0 128M
Micro Mini	lomega	USB 2.0 128M
iFlash	lmaton	USB 2.0 64M
LG	XTICK(M)	USB 2.0 64M
RiDATA	EZDrive	USB 2.0 64M

MP3 Player

Product	Company	Type
Creative MuVo NX128M	Creative	128 MB MP3 Player
Iriver H320	Iriver	20G HDD MP3 Player
YH-920	Samsung	20G HDD MP3 Player
YP-T7	Samsung	MP3 Player
YP-MT6	Samsung	MP3 Player
YP-T6	Samsung	MP3 Player
YP-53	Samsung	MP3 Player
YP-ST5	Samsung	MP3 Player
YP-T5	Samsung	MP3 Player
YP-60	Samsung	MP3 Player
YP-780	Samsung	MP3 Player
YP-35	Samsung	MP3 Player
YP-55	Samsung	MP3 Player
iAUDIO U2	Cowon	MP3 Player
iAUDIO G3	Cowon	MP3 Player
iAudio M3	Cowon	HDD MP3 Player
SI-M500L	Sharp	256MB MP3 Player
H10	Iriver	MP3 Player
YP-T5 VB	Samsung	MP3 Player
YP-53	Samsung	256MB MP3 Player

Multi Card Reader

Product	Company	Type
UNICORN	Unicorn	USB 2.0 7 IN 1 CARD READER UC-601R
USB 2.0 Card Reader	Billinton(Taiwan)	USB 2.0 Card Reader for SD/MMC/RS-MMC(3-in-1)

USB External HDD

Product	Company	Type
CUTIE	Serotech	POCKET HARD DISK DRIVE
MOMOBAY UX-2	Dvico	USB 2.0

Specifications

GENERAL	Power Consumption	80W
	Weight	3.5Kg
	Dimensions (W x H x D)	430 x 65 x 351.5 mm
	Operating Temperature Range	+5°C~+35°C
FUNCTION	Operating Humidity Range	10% ~ 75%
	Usable Sensitivity	10dB
	S/N Ratio	60dB
OUTPUT	Distortion	0.5%
	Composite Video	1.0Vp-p(75Ω load)
	Scart Jack	Compositive Video : 1.0Vp-p(75Ω load) RGB Signal : 0.714Vp-p(75Ω load)
	Component Video	Y:1.0Vp-p(75Ω load) Pr:0.70Vp-p(75Ω load) Pb:0.70Vp-p(75Ω load)
	HDMI	Impedance: 85~115Ω
AMPLIFIER	Front speaker output	75W x 2(4Ω)
	Center speaker output	80W(4Ω)
	Rear speaker output	75W x 2(4Ω)
	Subwoofer speaker output	120W(3Ω)
	Frequency range	20Hz~20KHz
	S/N Ratio	75dB
	Channel separation	60dB
Input sensitivity	(AUX)400mV	

HT-THQ22

S P E A K E R	Speaker system	5.1ch speaker system			
		Front/Rear speaker	Center speaker	Subwoofer speaker	
	Impedance	4Ω x 5		3Ω	
	Frequency range	140Hz~20KHz		35Hz~160Hz	
	Output sound pressure level	82dB/W/M		85dB/W/M	
	Rated input	75W	80W	120W	
	Maximum input	150W	160W	240W	
	Dimensions (W x H x D)	Front	90 x 1045 x 90 mm		175 x 320 x 381 mm
		Rear	90 x 152 x 90 mm		
		Center	200 x 90 x 92 mm		
Weights	Front/Rear	3Kg/0.4 Kg		5.1Kg	
	Center	0.6Kg			

HT-THQ25

S P E A K E R	Speaker system	5.1ch speaker system			
		Front/Rear speaker	Center speaker	Subwoofer speaker	
	Impedance	4Ω x 5		3Ω	
	Frequency range	140Hz~20KHz		35Hz~160Hz	
	Output sound pressure level	82dB/W/M		85dB/W/M	
	Rated input	75W	80W	120W	
	Maximum input	150W	160W	240W	
	Dimensions (W x H x D)	Front	90 x 1045 x 90 mm		175 x 320 x 381 mm
		Rear	90 x 1045 x 90 mm		
		Center	200 x 90 x 92 mm		
Weights	Front/Rear	3Kg/2.8Kg		5.1Kg	
	Center	0.6Kg			

Free Manuals Download Website

<http://myh66.com>

<http://usermanuals.us>

<http://www.somanuals.com>

<http://www.4manuals.cc>

<http://www.manual-lib.com>

<http://www.404manual.com>

<http://www.luxmanual.com>

<http://aubethermostatmanual.com>

Golf course search by state

<http://golfingnear.com>

Email search by domain

<http://emailbydomain.com>

Auto manuals search

<http://auto.somanuals.com>

TV manuals search

<http://tv.somanuals.com>