



DVD TELEVISION

DS21G5
DW21G5

Owner's Instructions

Before operating the unit,
please read this manual thoroughly,
and retain it for future reference.

FULL FLAT SCREEN
DVD / VIDEO-CD / CD / MP3
ON-SCREEN MENUS
TELETEXT FUNCTION (depending on the model)

ENG

Safety Instructions

- ◆ *Do not install the television in a confined space such as a book case or similar unit. Place on a stable stand or table.*
- ◆ *Do not expose the television to extreme temperature conditions or to extreme humidity conditions.*
- ◆ *Adequate ventilation is essential to prevent failure of electrical components.*
- ◆ *Do not expose the television to direct sunlight and other sources of heat.*
- ◆ *Do not expose the television to any liquids.*
- ◆ *During a storm conditions (especially when there is lightning) unplug the television from the mains socket and aerial.*
- ◆ *Do not step on or twist the power cord.*
- ◆ *Do not overload wall outlets or extension cords as this can result in a risk of fire or electric shock.*
- ◆ *Never put objects of any kind into the television, and do not place a water-containing vessel on the television.*
- ◆ *To prevent damage which may result in fire or shock hazard, do not expose the television to rain or excessive moisture.*
- ◆ *Please use a soft and dry cloth (not containing volatile matter) when you clean the TV.*
- ◆ *If the television is broken, do not try to repair it yourself. Contact qualified service personnel.*
- ◆ *If the remote control is not used for a long period of time, remove the batteries and store it in a cool, dry place.*
- ◆ *Do not drop the remote control.*

Caution

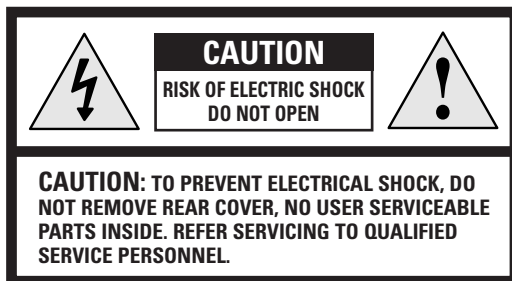

- ☞ *The main voltage is indicated on the rear of the TV set and the frequency is 50 or 60Hz.*

The lightning flash and arrow head within the triangle is a warning sign alerting you of "dangerous voltage" inside the product.

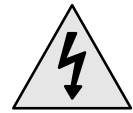

The exclamation point within the triangle is a warning sign alerting you of important instructions accompanying the product.



WARNING: TO PREVENT DAMAGE WHICH MAY RESULT IN FIRE OR SHOCK HAZARD. DO NOT EXPOSE THIS APPLIANCE TO RAIN OR MOISTURE.

Contents

ENG

◆ Foreword	
■ Safety Instructions	2
■ Caution	2
■ Viewing of the Television	4
■ Infrared Remote Control	5
◆ Connecting and Preparing Your Television	
■ Connecting the Aerial or Cable Television Network	6
■ Connecting a Decoder.....	6
■ Connecting to the Audio/Video Input/Outputs	7
■ Connecting to the RCA Input.....	7
■ Connecting to the Audio Output (depending on the model)	7
■ Connecting Headphones.....	8
■ Inserting the Batteries in the Remote Control.....	8
■ Switching Your Television On and Off	9
■ Placing Your Television in Standby Mode	9
■ Becoming Familiar with the Remote Control.....	10
■ Displaying Information on the Screen	11
■ Choosing Your Language	11
◆ Setting the Channels and Using the Television Function	
■ Storing the Channels Automatically	12
■ Storing the Channels Manually (depending on the model).....	13
■ Sorting the Stored Channels	15
■ Assigning Names to Channels (depending on the model)	16
■ Adjusting the Picture (depending on the model).....	17~18
■ Adjusting the Sound	19
■ Selecting the Sound Mode (depending on the model)	20
■ Setting the Time and Switching the TV On/Off Automatically	21
■ Setting the Sleep Timer.....	22
■ Locking the Front Panel	22
■ Using the Melody Function (depending on the model)	23
■ Viewing Pictures from External Sources.....	23
◆ Using the DVD / VIDEO-CD / CD / MP3 Function	
■ Playing a Disc	24
■ Using the Search and Skip Functions.....	26
■ Using the Display Function	27
■ Repeat Play.....	28
■ Programme Play and Random Play	29
■ Using the Disc View Function	30
■ Selecting the Audio Language	31
■ Selecting the Subtitle Language	32
■ Changing the Camera Angle	33
■ Using the Zoom Function (DVD/VCD)	34
■ Using the Bookmark Function	35
■ Using the Setup Menu.....	36
■ Setting Up the Language Features	37~38
■ Setting Up the Parental Control	39
■ Setting Up the Audio Options	40
■ Setting Up the Display Options	41
■ Disc Type and Characteristics.....	42
◆ Using the Teletext Function	
■ Teletext Feature.....	43
■ Displaying the Teletext Screen	44
■ Selecting Display Options	44
■ Selecting a Teletext Page	45
■ Storing Teletext Pages	45
◆ Recommendations for Use	
■ Specifications	46
■ Problems and Solutions	46~47

Viewing of the Television

ENG

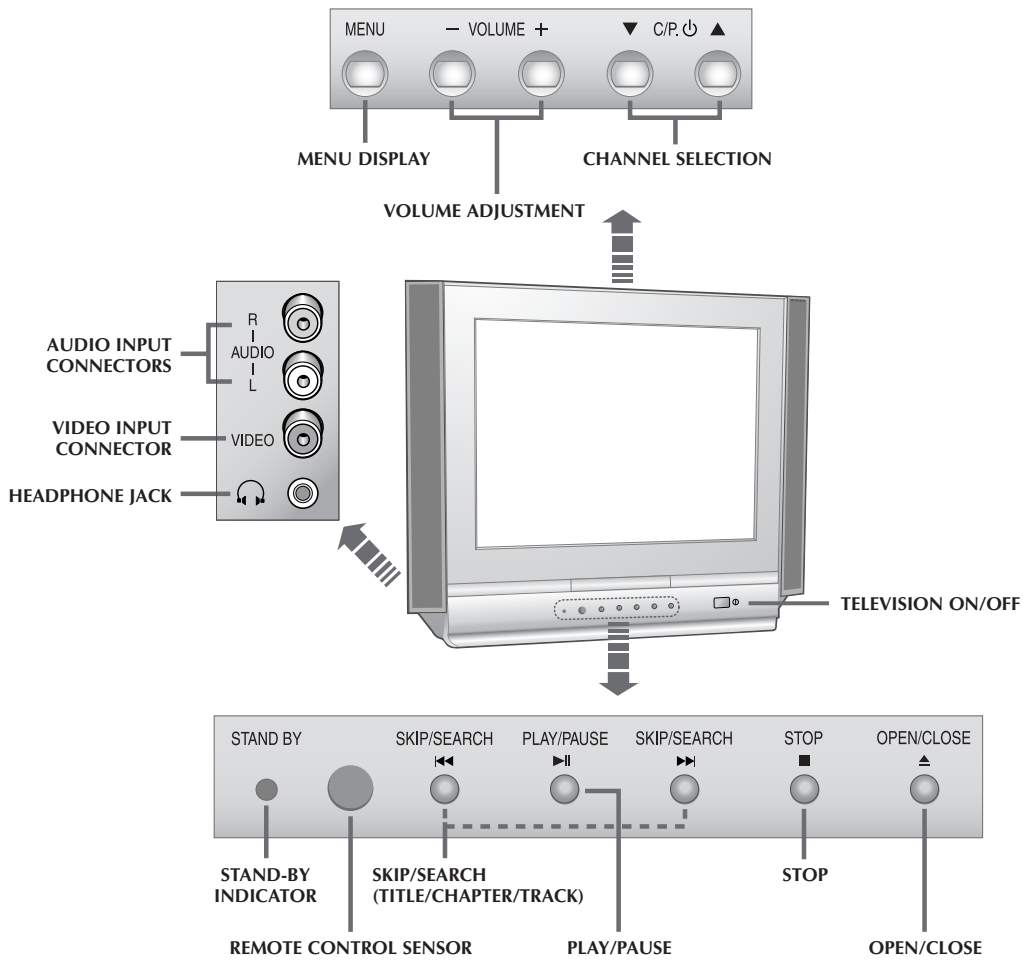

Rear of the TV

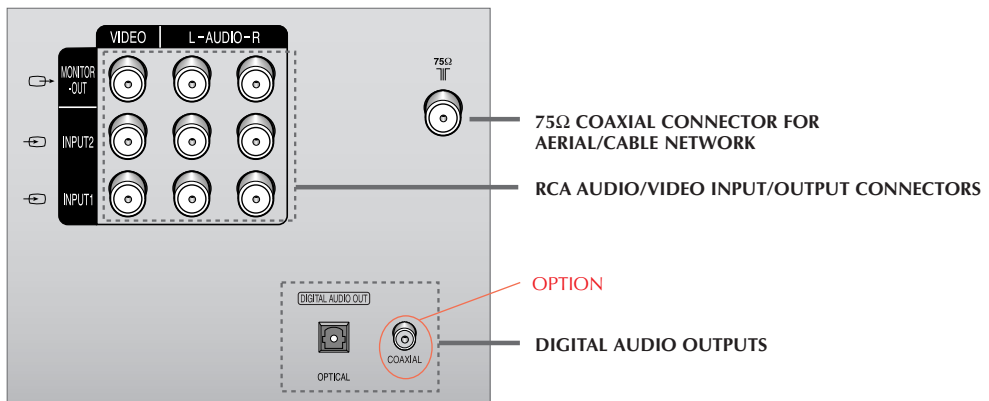

Infrared Remote Control (depending on the model)

ENG

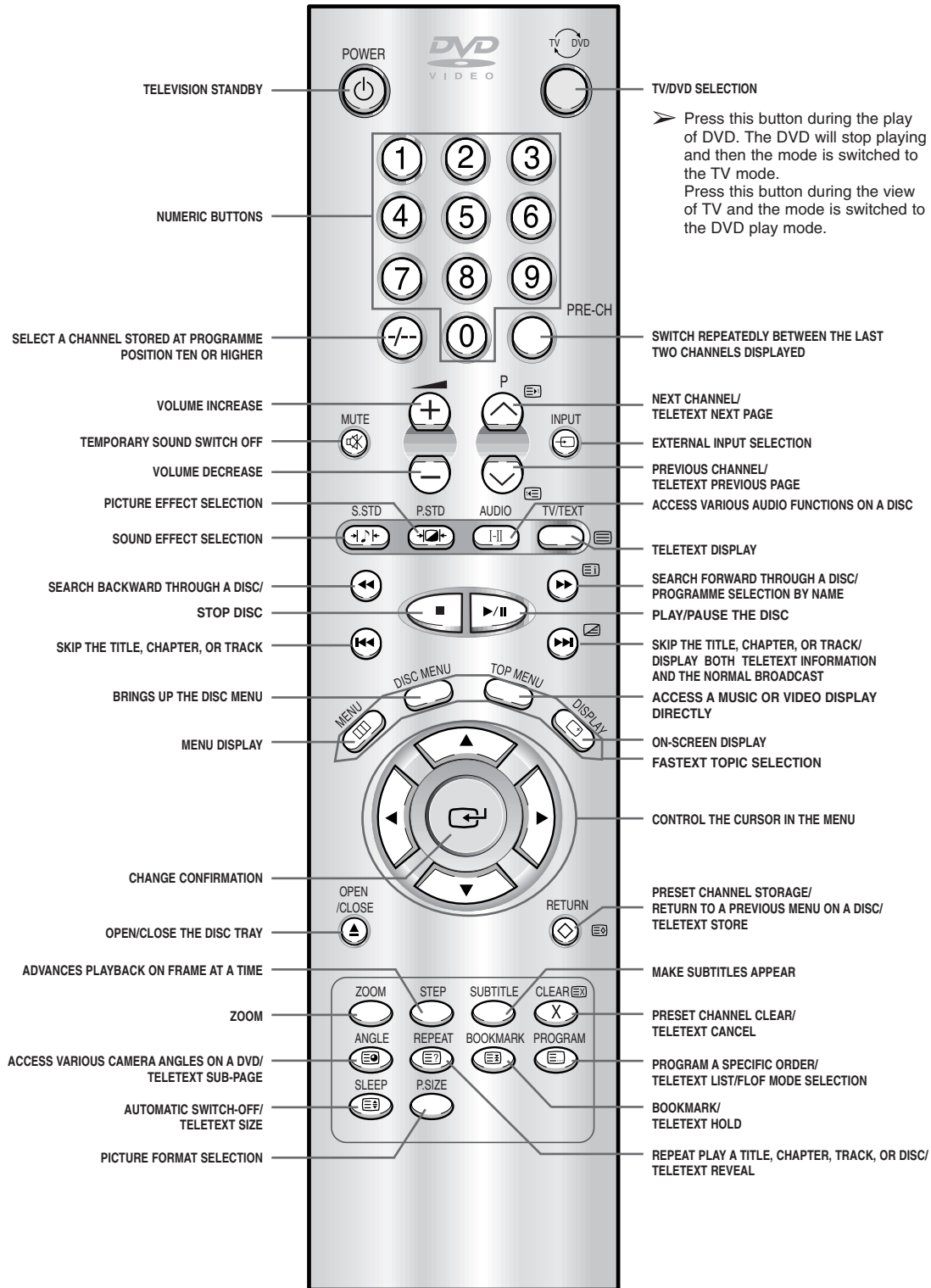

➤ The performance of the remote control may be affected by bright light.

Connecting the Aerial or Cable Television Network

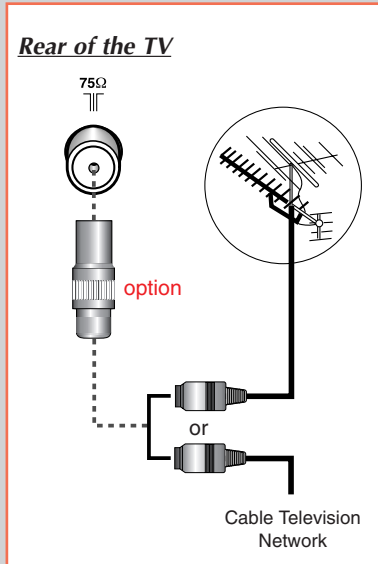

To view television channels correctly, a signal must be received by the set from one of the following sources:

- ◆ An outdoor aerial
- ◆ A cable television network

Connect the aerial or network input cable to the 75Ω coaxial socket on the rear of the television.

Connecting a Decoder

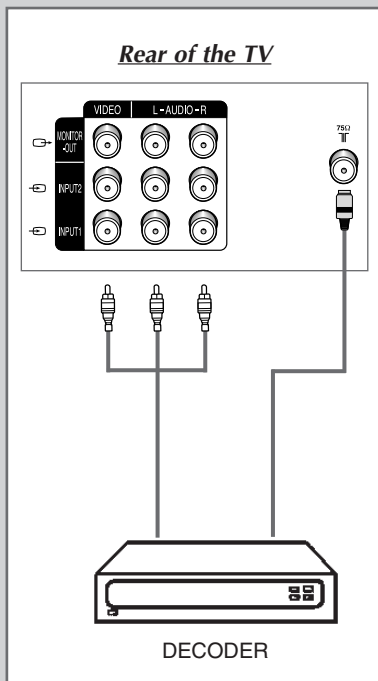

In order to descramble a coded transmission signal, you must connect a decoder to the TV set.

- If you wish to connect both a decoder and a VCR, you should connect the:
- ◆ Decoder to the VCR
 - ◆ VCR to the television

Otherwise, connect the decoder directly to the television.

Using a coaxial cable

Connect a coaxial cable to the:

- ◆ Receiver output socket.
- ◆ Television aerial input socket.

Connecting to the Audio/Video Input/Outputs

- The A/V connectors are used for equipment with an RGB output, such as VCRs, video game devices, video disc players, and camcorders.

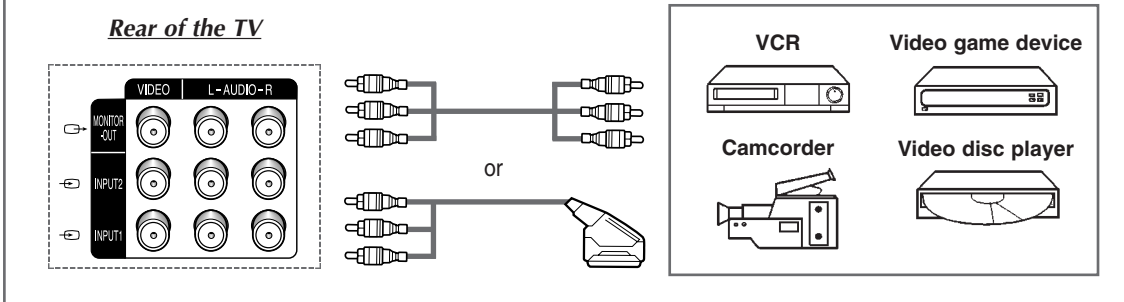

Connecting to the RCA Input

- The RCA connectors are used for equipment, such as VCRs, camcorders, video disc players, and video game devices.

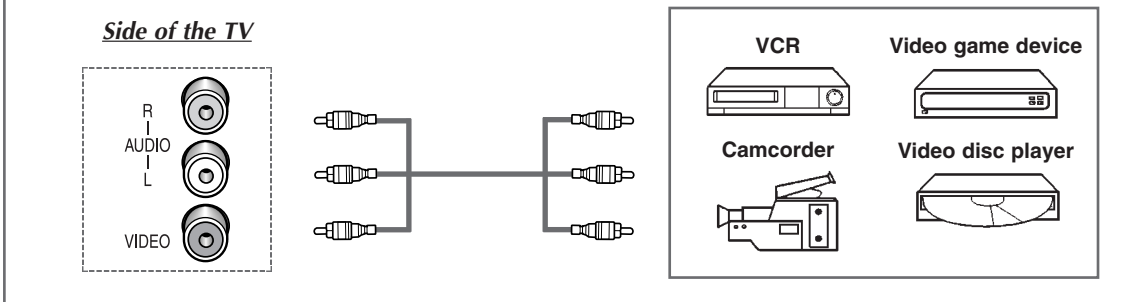

Connecting to the Audio Output (depending on the model)

- The DIGITAL AUDIO OUT connector is used for equipment, such as an audio system (to take full advantage of the Surround sound effect).

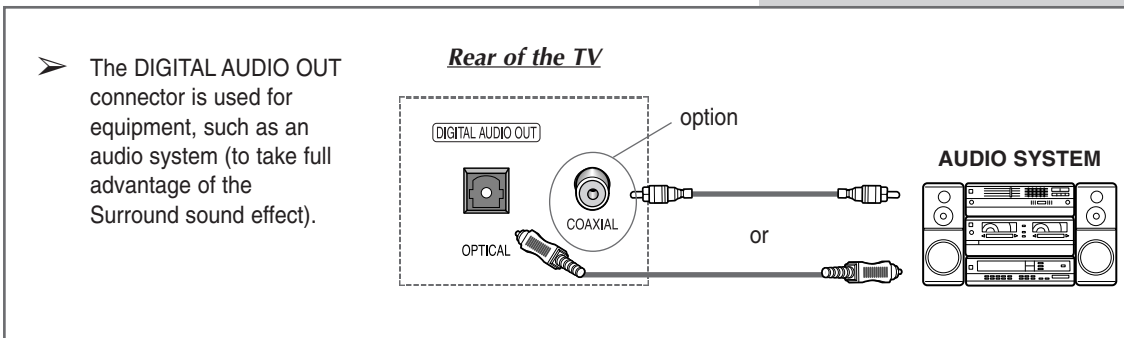

Connecting Headphones

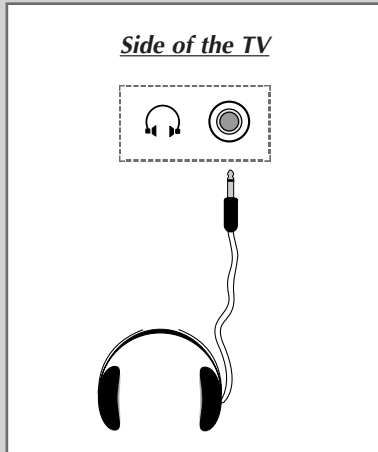

You can connect a set of headphones to your television if you wish to watch a television programme without disturbing the other people in the room.

- 1 Plug a set of headphones into the 3.5 mm mini-jack socket on the television panel.

Result: The sound is heard through the headphones.

- 2 When you wish to hear the sound through the speakers again, simply disconnect the headphones.

➤ Prolonged use of headphones at a high volume may damage your hearing.

Inserting the Batteries in the Remote Control

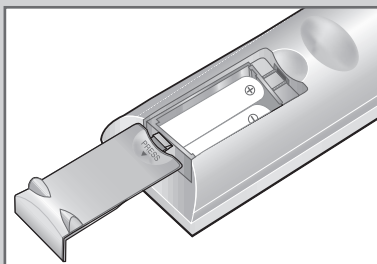
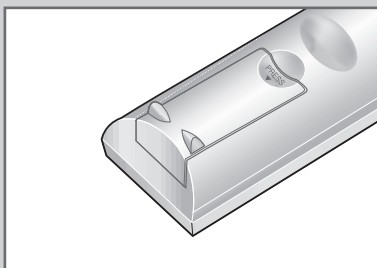

You must insert or replace the batteries in the remote control when you:

- ◆ *Purchase the television*
- ◆ *Find that the remote control is no longer operating correctly*

- 1 Remove the cover on the rear of the remote control by pressing the symbol downwards and then pulling firmly to remove it.
- 2 Insert batteries taking care to respect the polarities:
 - ◆ + on the battery against + on the remote control
 - ◆ - on the battery against - on the remote control
- 3 Replace the cover by aligning it with the base of the remote control and pressing it back into place.

➤ Do not mix battery types, i.e. alkaline and manganese.

Switching Your Television On and Off

The mains lead is attached to the rear of your television.

- 1 Plug the mains lead into an appropriate socket.
- 2 Press the ON/OFF button (⏻) on the front of the television.
Result: The Standby indicator lights up on the front panel.
- 3 Press the **POWER** button (⏻) on the remote control to switch the television on.
Result: The programme that you were watching last is re-selected automatically.
- 4 To switch your television off, press the ON/OFF button (⏻) again.

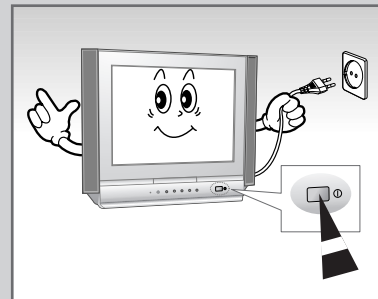

Placing Your Television in Standby Mode

Your television can be placed in Standby mode, in order to reduce:

- ◆ *Power consumption*
- ◆ *Wear of the cathode ray tube*

The Standby mode can be useful when you wish to interrupt viewing temporarily (during a meal, for example).

- 1 Press the **POWER** button (⏻) on the remote control.
Result: The screen is turned off and a red Standby indicator appears on the front of the television.
- 2 To switch the television back on, simply press the **POWER** button (⏻) again or a number button.

- Do not leave your television in Standby mode for long periods of time (when you are away on holiday, for example). Turn your television off by pressing the ON/OFF button (⏻) on the front of the television. It is best to unplug the set from the mains and aerial.



Becoming Familiar with the Remote Control

ENG

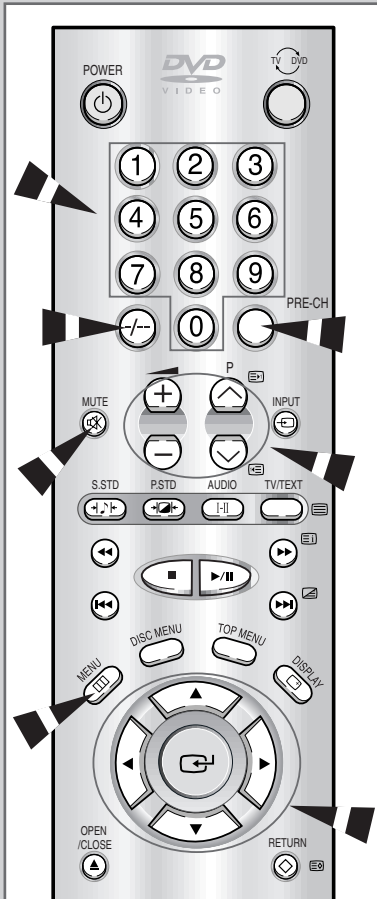

The remote control is used mainly to:

- ◆ Change channels and adjust the volume
- ◆ Set up the television using the on-screen menu system



The following table presents the most frequently used buttons and their functions.

Button	Viewing Function
P	Used to display the next stored channel.
P	Used to display the previous stored channel.
① to ⑨	Used to display the corresponding channels.
PRE-CH	Used to switch repeatedly between the last two channels displayed.
-/-	Used to select a channel stored at programme position ten or higher. ➤ For double digit channels, the second digit must be pushed immediately after the first. Failure to do this will result in a single digit channel being displayed.
+	Used to increase the volume.
-	Used to reduce the volume.
MUTE	Used to switch the sound off temporarily. ➤ When you wish to turn the sound back on, press the this button again or press the volume down/up button (/).

Button	Menu Function
MENU	Used to... ◆ Display the on-screen menu. ◆ Return to the previous menu or normal viewing.
	Used to... ◆ Display a submenu containing selections for the current menu option. ◆ Search forwards/backwards manually for channels. ◆ Increase/reduce a menu option value.
	Used to confirm your choice.

Displaying Information on the Screen

You can display various types of information on the screen to help you use your television.



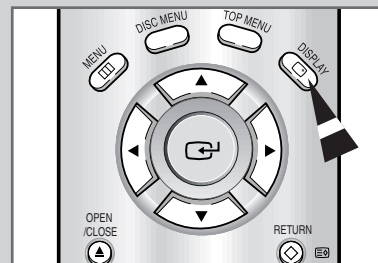



Press the **DISPLAY**  button to display the information. To remove the information from the screen, press the **DISPLAY**  button again.



ENG

Choosing Your Language

When you start using your television for the first time, you must select the language which will be used for displaying menus and indications.

- 1 Press the **MENU**  button.
Result: The main menu is displayed.
- 2 Press the UP/DOWN  button until the **FUNCTION** is selected. Press the LEFT/RIGHT  button.
Result: The options available in the **FUNCTION** menu are displayed with the **LANGUAGE** option is selected.
- 3 Press the LEFT/RIGHT  button again.
Result: The languages available are listed: **ENGLISH - FRANÇAIS - ARABIC**.
- 4 Select the appropriate language by pressing the UP/DOWN  button.
- 5 To return to normal viewing, press the **MENU**  button repeatedly until the menus disappear.

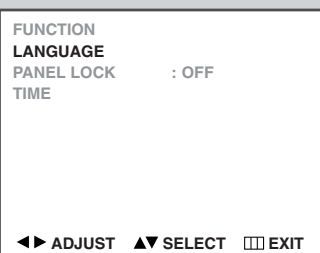
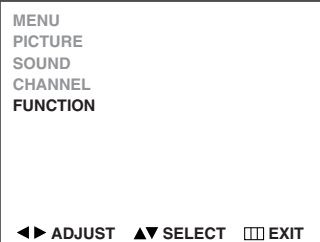

Storing the Channels Automatically

MENU
PICTURE
SOUND
CHANNEL
FUNCTION

◀▶ ADJUST ▲▼ SELECT □□ EXIT

CHANNEL
MANUAL TUNE
AUTO TUNE

◀▶ ADJUST ▲▼ SELECT □□ EXIT

P 1
FREQUENCY : 225.00 MHz

□□ STOP

You can scan for the frequency ranges available to you, (availability depends on your country). Automatically allocated programme numbers may not correspond to actual or desired programme numbers. However you can sort numbers manually and clear any channels you do not wish to watch.

- 1 Press the **MENU** □□ button.

Result: The main menu is displayed.

- 2 Press the UP/DOWN ▲▼ button until the **CHANNEL** is selected. Press the LEFT/RIGHT ◀▶ button.

Result: The options available in the **CHANNEL** menu are displayed.

- 3 Press the UP/DOWN ▲▼ button until the **AUTO TUNE** is selected. Press the LEFT/RIGHT ◀▶ button.

Result: The search will end automatically. Channels are sorted and stored in an order which reflects their position in the frequency range, (with lowest first and highest last). The programme originally selected is then displayed.

- To stop the search before it has finished, press the **MENU** □□ button.

Storing the Channels Manually (depending on the model)

ENG

You can store up to 100 television channels, including those received via cable networks.

When storing channels manually, you can choose:

- ◆ Whether or not to store each of the channels found
- ◆ The programme number by which you wish to identify each stored channel
- ◆ To enter the frequency of the channel to be stored directly, if you know it

- 1 Press the **MENU** button.
Result: The main menu is displayed.
- 2 Press the UP/DOWN button until the **CHANNEL** is selected. Press the LEFT/RIGHT button.
Result: The options available in the **CHANNEL** menu are displayed with the **MANUAL TUNE** is selected.
- 3 Press the LEFT/RIGHT button again.
Result: The options available in the **MANUAL TUNE** menu are displayed.
- 4 If necessary, indicate the broadcasting standard required by pressing the UP/DOWN button until the the **SYSTEM** (Color system) option is selected, followed by pressing the LEFT/RIGHT button repeatedly.
Result: The color standards are displayed in the following order: **AUTO, PAL, SECAM, NTSC**
- 5 Select the **S.SYSTEM** (Sound system) option by pressing the UP/DOWN button, and followed by pressing the LEFT/RIGHT button repeatedly.
Result: The sound standards are displayed in the following order: **B/G, D/K, I, M**

➤ If the picture is not properly set after you select a **SYSTEM** (Color system), you can correct the picture by adjusting **S.SYSTEM** (Sound system).

```

MENU
PICTURE
SOUND
CHANNEL
FUNCTION

◀▶ ADJUST ▲▼ SELECT □□ EXIT
    
```

```

CHANNEL
MANUAL TUNE
AUTO TUNE

◀▶ ADJUST ▲▼ SELECT □□ EXIT
    
```

```

CURRENT PR. : P01
NEW PR.     : P08
SEARCH      : ◀▶
FREQUENCY   : 192.00 MHz
AFT         : ON
SYSTEM    : AUTO
S.SYSTEM    : B/G

◇ : STORE      X: CLEAR    □□ EXIT
◀▶ ADJUST     ▲▼ SELECT
    
```

```

CURRENT PR. : P01
NEW PR.     : P08
SEARCH      : ◀▶
FREQUENCY   : 192.00 MHz
AFT         : ON
SYSTEM      : AUTO
S.SYSTEM  : B/G

◇ : STORE      X: CLEAR    □□ EXIT
◀▶ ADJUST     ▲▼ SELECT
    
```

Storing the Channels Manually (depending on the model)

```

CURRENT PR. : P01
NEW PR.     : P08
SEARCH      : ◀/▶
FREQUENCY : 192.00 MHz
AFT         : ON
SYSTEM      : AUTO
S.SYSTEM    : B/G
  
```

```

◊ : STORE      X: CLEAR  □□ EXIT
◀▶ ADJUST     ▲▼ SELECT
  
```

```

CURRENT PR. : P01
NEW PR.     : P08
SEARCH      : ◀/▶
FREQUENCY : 192.00 MHz
AFT         : ON
SYSTEM      : AUTO
S.SYSTEM    : B/G
  
```

```

◊ : STORE      X: CLEAR  □□ EXIT
◀▶ ADJUST     ▲▼ SELECT
  
```

```

CURRENT PR. : P01
NEW PR.     : P08
SEARCH      : ◀/▶
FREQUENCY    : 192.00 MHz
AFT          : ON
SYSTEM       : AUTO
S.SYSTEM     : B/G
  
```

```

◊ : STORE      X: CLEAR  □□ EXIT
◀▶ ADJUST     ▲▼ SELECT
  
```

- | 6 | If you... | Then... |
|----|---|--|
| | Know the frequency of the channel to be stored | <ul style="list-style-type: none"> ◆ Press the UP/DOWN▲▼ button to select the FREQUENCY option. ◆ Enter the required frequency by pressing the numeric buttons or the LEFT/RIGHT◀▶ button. ◆ Go to Step 7. |
| | Do <u>not</u> know the frequency of the channel to be stored | <ul style="list-style-type: none"> ◆ Press the UP/DOWN▲▼ button to select the SEARCH option. ◆ Press the LEFT/RIGHT◀▶ button to start the search.
 <u>Result:</u> When a channel is found, the searching stops and the channel is displayed on the screen.
 You can then: <ul style="list-style-type: none"> - Continue the search by moving the joystick up or down. - Store the channel; go to Step 7. |
| 7 | When the channel to be stored appears on the screen, select the NEW PR. option by pressing the UP/DOWN▲▼ button. | |
| 8 | Enter the programme number to be assigned to the channel by pressing the numeric buttons or the LEFT/RIGHT◀▶ button. | |
| 9 | Press the memory button (◊) to store the channel. | |
| 10 | If you wish to store other channels, return to Step 6. | |

Sorting the Stored Channels

ENG

The Sort operation allows you to change the programme numbers to previously stored channels or to clear channels that you will never watch. This operation may be necessary after you have stored the channels automatically. You can delete those channels you do not want to keep.

- 1 Press the **MENU** button.
Result: The main menu is displayed.

- 2 Press the UP/DOWN button until the **CHANNEL** is selected. Press the LEFT/RIGHT button.
Result: The options available in the **CHANNEL** menu are displayed with the **MANUAL TUNE** is selected.

- 3 Press the LEFT/RIGHT button again.
Result: The options available in the **MANUAL TUNE** menu are displayed.

4 If you wish to...	Then...
Assign a new number to a preset station	<ul style="list-style-type: none"> ◆ Press the UP/DOWN button to select the NEW PR. option. ◆ Enter the new programme number by pressing the numeric buttons or the LEFT/RIGHT button. ◆ Press the memory button (◇) to store the change.
Clear a preset channel	<ul style="list-style-type: none"> ◆ Press the UP/DOWN button to select the CURRENT PR. option. ◆ Press the CLEAR button (X). <p style="margin-left: 20px;">➤ The programme number can be reused for another channel. To assign a new channel, store a new channel manually.</p>

- 5 If you wish to assign other programmes, repeat Steps 4.

```
CHANNEL
MANUAL TUNE
AUTO TUNE

◀▶ ADJUST ▲▼ SELECT □□ EXIT
```

```
CURRENT PR. : P01
NEW PR.      : P01
SEARCH       : ◀▶
FREQUENCY    : 192.00 MHz
AFT          : ON
SYSTEM       : AUTO
S.SYSTEM     : B/G

◇ : STORE    X: CLEAR  □□ EXIT
◀▶ ADJUST  ▲▼ SELECT
```

```
CURRENT PR. : P01
NEW PR.      : P08
SEARCH       : ◀▶
FREQUENCY    : 192.00 MHz
AFT          : ON
SYSTEM       : AUTO
S.SYSTEM     : B/G

◇ : STORE    X: CLEAR  □□ EXIT
◀▶ ADJUST  ▲▼ SELECT
```

Assigning Names to Channels (depending on the model)

ENG

CHANNEL
MANUAL TUNE
AUTO TUNE

◀▶ ADJUST ▲▼ SELECT □□ EXIT

CURRENT PR. : P01
NEW PR. : P08
NAME : - - - - -
SEARCH : ◀▶
FREQUENCY : 192.00 MHz
AFT : ON
SYSTEM : AUTO
S.SYSTEM : B/G

◇ : STORE X: CLEAR □□ EXIT
◀▶ ADJUST ▲▼ SELECT

Channel names will be assigned automatically when channel information is broadcast. These names can be changed, allowing you to assign new names.

- 1 Press the **MENU**□□ button.
Result: The main menu is displayed.
- 2 Press the **UP/DOWN**▲▼ button until the **CHANNEL** is selected. Press the **LEFT/RIGHT**◀▶ button.
Result: The options available in the **CHANNEL** menu are displayed with the **MANUAL TUNE** is selected.
- 3 Press the **LEFT/RIGHT**◀▶ button again.
Result: The options available in the **MANUAL TUNE** menu are displayed.
- 4 Select the **NAME** by pressing the **LEFT/RIGHT**◀▶ button.
- 5

To...	Then press the...
Select a letter, number or symbol	UP/DOWN▲▼ button.
Move on the next letter	RIGHT▶ button.
Move back the previous letter	LEFT◀ button.

➤ The characters available are:

 - ◆ Letters of the alphabet (A ... Z, a ... z)
 - ◆ Numbers (0 ... 9)
 - ◆ Various special characters
- 6 When you have finished entering the name, press the memory button (◇) to confirm the name.

Adjusting the Picture (depending on the model)

ENG

You can select the type of picture which best corresponds to your viewing requirements.

- 1 Press the **MENU** button.
Result: The main menu is displayed with the **PICTURE** selected.
- 2 Press the **LEFT/RIGHT** button.
Result: The options available in the **PICTURE** menu are displayed.
- 3 Press the **LEFT/RIGHT** button to select the type of picture. The following picture effects are available: **CUSTOM, STANDARD, NATURAL, SPORTS, MILD**
 - You can also select the required picture effect by pressing the **P.STD** (picture standard) button on the remote control.

Several settings are available on your television to enable you to control the quality of the picture.

- 4 Press the **UP/DOWN** button to select the **ADJUST** option. Press the **LEFT/RIGHT** button. The following settings are available: **CONTRAST, BRIGHT, SHARPNESS, COLOR**
- 5 Select one of the options by pressing the **UP/DOWN** button, followed by pressing the **LEFT/RIGHT** button.
Result: The horizontal bar is displayed. Then, press the **LEFT/RIGHT** button to decrease or increase the value displayed.
- 6 When you are satisfied with the settings, press the **MENU** button to return to the **PICTURE** menu.
- 7 Select the **COLOR TONE** option by pressing the **UP/DOWN** button. Press the **LEFT/RIGHT** button to select your preferences. The color tones are available: **NORMAL, WARM1, WARM2, COOL1, COOL2**

```
MENU
PICTURE
SOUND
CHANNEL
FUNCTION

◀▶ ADJUST ▲▼ SELECT □□ EXIT
```

```
PICTURE : CUSTOM
ADJUST
COLOR TONE : NORMAL
AUTO WIDE : OFF
SIZE : WIDE
NR : OFF
TILT : 0

◀▶ ADJUST ▲▼ SELECT □□ EXIT
```

```
ADJUST
CONTRAST 90
BRIGHT 50
SHARPNESS 50
COLOR 50

◀▶ ADJUST ▲▼ SELECT □□ EXIT
```

```
PICTURE : CUSTOM
ADJUST
COLOR TONE : NORMAL
AUTO WIDE : OFF
SIZE : WIDE
NR : OFF
TILT : 0

◀▶ ADJUST ▲▼ SELECT □□ EXIT
```

Adjusting the Picture (depending on the model)

```

PICTURE : CUSTOM
ADJUST
COLOR TONE : NORMAL
AUTO WIDE : OFF
SIZE : WIDE
NR : OFF
TILT : 0

◀▶ ADJUST ▲▼ SELECT □□ EXIT
  
```

```

PICTURE : CUSTOM
ADJUST
COLOR TONE : NORMAL
AUTO WIDE : OFF
SIZE : WIDE
NR : OFF
TILT : 0

◀▶ ADJUST ▲▼ SELECT □□ EXIT
  
```

```

PICTURE : CUSTOM
ADJUST
COLOR TONE : NORMAL
AUTO WIDE : OFF
SIZE : WIDE
NR : OFF
TILT : 0

◀▶ ADJUST ▲▼ SELECT □□ EXIT
  
```

```

PICTURE : CUSTOM
ADJUST
COLOR TONE : NORMAL
AUTO WIDE : OFF
SIZE : WIDE
NR : OFF
TILT : 0

◀▶ ADJUST ▲▼ SELECT □□ EXIT
  
```

☞ depending on the model.

When the Wide signal is received from the broadcasting station, you can watch TV in the Wide mode. Otherwise, you can watch TV in the PANORAMA mode.

- 8 Press the UP/DOWN▲▼ button to select the **AUTO WIDE** option. To activate this feature, set the **AUTO WIDE** option to **ON** by pressing the LEFT/RIGHT◀▶ button.
 - When the **AUTO WIDE** option is selected **ON**, the **SIZE** option disappears and the **P.SIZE** (picture size) button on the remote control does not operate.

You can select the picture format which best corresponds to your viewing requirements.

- 9 Press the UP/DOWN▲▼ button to select the **SIZE** option. Press the LEFT/RIGHT◀▶ button. The following picture formats are available (depending on the model);
 - ◆ **WIDE, PANORAMA, ZOOM1, ZOOM2, 4:3**
 - ◆ **NORMAL, ZOOM, 16:9**
 - You can also select the required picture format by pressing the **P.SIZE** (picture size) button on the remote control.

If the signal received by your television is weak, you can activate the noise reduction feature to help reduce any static and ghosting that may appear on the screen.

- 10 Press the UP/DOWN▲▼ button to select the **NR** option. To activate the noise reduction feature, set the **NR** option to **ON** by pressing the LEFT/RIGHT◀▶ button.

☞ depending on the model.

If you find that the picture received is slightly tilted to one side, you can adjust the tilt setting.

- 11 Press the UP/DOWN▲▼ button to select the **TILT** option. To decrease or increase the value displayed, press the LEFT/RIGHT◀▶ button.

Adjusting the Sound

ENG

You can select the type of special sound effect to be used when watching a given broadcast.

- 1 Press the **MENU** button.
Result: The main menu is displayed.
- 2 Press the **UP/DOWN** button until the **SOUND** is selected. Press the **LEFT/RIGHT** button.
Result: The options available in the **SOUND** menu are displayed.
- 3 Press the **LEFT/RIGHT** button to select the type of sound. The following sound effects are available: **CUSTOM**, **STANDARD**, **MUSIC**, **MOVIE**, **SPEECH**.
➤ You can also select the required sound effect by pressing the **S.STD** (sound standard) button on the remote control.

The following sound settings can be adjusted to suit your personal preferences.

4	To change the...	Then...
◆	BASS	◆ Press the UP/DOWN button to select the required option.
◆	TREBLE	◆ Press the LEFT/RIGHT button. Result: The horizontal bar is displayed.
◆	BALANCE	◆ Press the LEFT/RIGHT button to decrease or increase the value displayed.
◆	VOLUME	
◆	PSEUDO STEREO	◆ Press the UP/DOWN button to select the required option.
◆	VIRTUAL SURROUND	◆ To activate the required feature, set to ON by pressing the LEFT/RIGHT button.
◆	BASS PLUS	
◆	AUTO VOLUME	

- ◆ **PSEUDO STEREO** converts a monaural sound signal into two identical left and right channels.
- ◆ Once the **PSEUDO STEREO** or **VIRTUAL SURROUND** is set to **ON** or **OFF**, the setting applies to the sound effects such as **STANDARD**, **MUSIC**, **MOVIE** and **SPEECH**.
- ◆ Each broadcasting station has its own signal conditions, and so it is not easy for you to adjust the volume every time the channel is changed. **AUTO VOLUME** lets you automatically adjust the volume of the desired channel by lowering the sound output when the modulation signal is high or by raising the sound output when the modulation signal is low.

```

MENU
PICTURE
SOUND
CHANNEL
FUNCTION

◀▶ ADJUST ▲▼ SELECT □□ EXIT
    
```

```

SOUND      : CUSTOM
BASS              50
TREBLE           50
BALANCE          L 50 : R 50
VOLUME          12
PSEUDO STEREO    OFF
VIRTUAL SURROUND OFF
BASS PLUS        OFF
AUTO VOLUME      OFF

◀▶ ADJUST ▲▼ SELECT □□ EXIT
    
```

```

SOUND      : CUSTOM
BASS              50
TREBLE           50
BALANCE          L 50 : R 50
VOLUME          12
PSEUDO STEREO    OFF
VIRTUAL SURROUND OFF
BASS PLUS        OFF
AUTO VOLUME      OFF

◀▶ ADJUST ▲▼ SELECT □□ EXIT
    
```

- These picture and sound settings are maintained:
 - ◆ When you switch the television to standby mode
 - ◆ When you switch the television off using the On/Off button on the television panel
 - ◆ If there is a power failure.

Setting the Time and Switching the TV On/Off Automatically

ENG

You can set the television's clock and the On/Off timers so that the television will switch On/Off automatically.

- 1 Press the **MENU** button.
Result: The main menu is displayed.

- 2 Press the **UP/DOWN** button until the **FUNCTION** is selected. Press the **LEFT/RIGHT** button.
Result: The options available in the **FUNCTION** menu are displayed.

- 3 Press the **UP/DOWN** button until the **TIME** is selected. Press the **LEFT/RIGHT** button.
Result: The current time is displayed.

- 4 Enter the hour and then the minutes by pressing the numeric buttons.
 ➤ When a time is entered, all single digits must be preceded by a zero.
Example: 3:07 p.m.
 Enter 15:07

- 5 Press the **UP/DOWN** button to select the **ON TIMER**. Enter the hour and then the minutes by pressing the numeric buttons.
 ☛ At this time, if you have not set the time, the message **SET THE CLOCK FIRST** is displayed.
Result: The set will be switched on automatically every day at the time requested.

- 6 Press the **UP/DOWN** button to select the **OFF TIMER**. Enter the hour and then the minutes by pressing the numeric buttons.
Result: The set will be switched off automatically every day at the time requested.

➤ *These settings will be re-set when pressing the On/Off button on the television panel.*

```
MENU
PICTURE
SOUND
CHANNEL
FUNCTION

◀▶ ADJUST ▲▼ SELECT □□ EXIT
```

```
FUNCTION
LANGUAGE
PANEL LOCK : OFF
TIME

◀▶ ADJUST ▲▼ SELECT □□ EXIT
```

```
TIME : 15:07
ON TIMER : OFF
OFF TIMER : OFF

☛ ADJUST ▲▼ SELECT □□ EXIT
```

```
TIME : 15:07
ON TIMER : 07:00
OFF TIMER : OFF

☛ ADJUST ▲▼ SELECT □□ EXIT
```

```
TIME : 15:07
ON TIMER : 07:00
OFF TIMER : 23:00

☛ ADJUST ▲▼ SELECT □□ EXIT
```

Setting the Sleep Timer

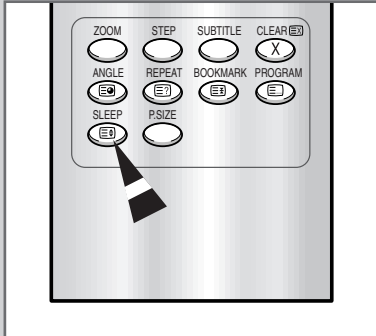

You can select a time period of between 15 and 180 minutes after which the television automatically switches to Standby mode.

- 1 Press the **SLEEP** button on the remote control.

Result:

If the sleep timer is...	The screen displays...
not yet set	⏻ OFF .
already set	The remaining time before the television switches to Standby mode.

- 2 Press the **SLEEP** button repeatedly and cycle through the preset time intervals (15, 30, 45, 60, 90, 120, 150, 180).

Result: The television automatically switches to Standby mode when the timer reaches 0.

- ♦ After setting the sleep timer, you can display and modify the remaining time by pressing the **SLEEP** button again. To switch the sleep timer off, select **OFF**.
- ♦ Your television switches to Standby mode automatically fifteen minutes after the last broadcast has finished on the selected channel.

Locking the Front Panel

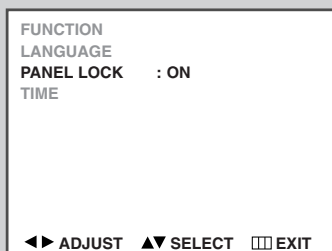
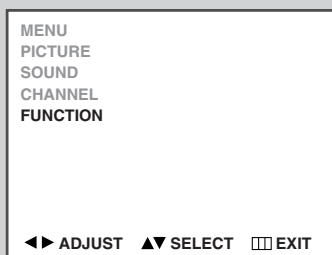

The television panel can be locked to prevent it from being used by young children for example.

- 1 Press the **MENU** button.

Result: The main menu is displayed.

- 2 Press the UP/DOWN button until the **FUNCTION** is selected. Press the LEFT/RIGHT button.

Result: The options available in the **FUNCTION** menu are displayed.

- 3 Press the UP/DOWN button until the **PANEL LOCK** is selected. To activate this feature, set to **ON** by pressing the LEFT/RIGHT button.

Result: The buttons on the television panel no longer have any effect.

Using the Melody Function (depending on the model)

ENG

You can hear clear melody sound when the TV is powered on or off.

- 1 Press the **MENU** button.
Result: The main menu is displayed.
- 2 Press the UP/DOWN button until the **FUNCTION** is selected. Press the LEFT/RIGHT button.
Result: The options available in the **FUNCTION** menu are displayed.
- 3 Press the UP/DOWN button until the **MELODY** is selected. To activate this feature, set to **ON** by pressing the LEFT/RIGHT button.

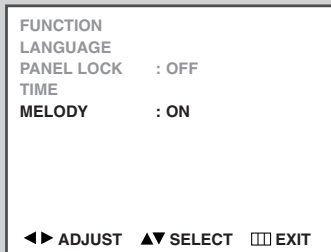
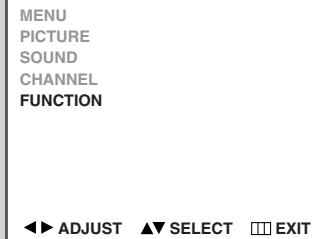

Viewing Pictures from External Sources

Once you have connected up your various audio and video systems, you can view the different sources by selecting the appropriate input.

- 1 Check that all the necessary connections have been made (refer to pages 6 and 7 for further details).
- 2 Switch the television on and if necessary, press the **INPUT** button one or more times until the required input is displayed.
 - Depending on the source selected, the pictures may appear automatically.

- ◆ To watch television programmes again, press the **INPUT** button and select the number of the channel required.
- ◆ To connect different types of video equipment to your television, use the input connectors on the side and rear panels (RCA and SCART respectively). If equipment is plugged into both these connectors, the side connector has priority.



Playing a Disc

ENG

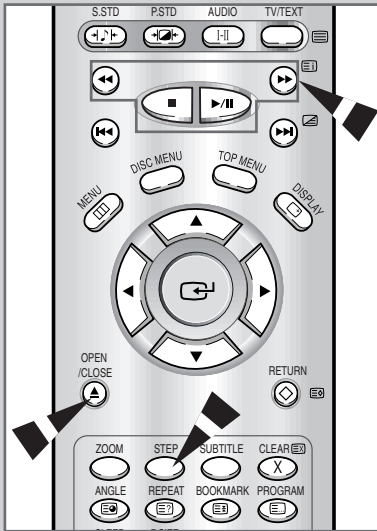

Playback

- 1 Press the **OPEN/CLOSE** button.
- 2 Place a disc gently into the tray with the disc's label facing up.
- 3 Press the **PLAY/PAUSE** ►/|| or **OPEN/CLOSE** button to close the disc tray.

RESUME function

When you stop disc play, the player remembers where you stopped, so when you press the **PLAY/PAUSE** ►/|| again, it will pick up where you left off (unless the disc is removed, the **STOP** ■ button is pressed twice or the set is unplugged.).

- ◆ If the player is left for **5 minutes** in pause mode, it will stop.
- ◆ This ◯ icon indicates an invalid button press.

Stopping Playback

Press the **STOP** ■ button during playback.

Removing Disc

Press the **OPEN/CLOSE** button.

Pausing Playback

Press the **PLAY/PAUSE** ►/|| or **STEP** button on the remote control during playback.

- Screen stops, no sound.
- To resume again, press the **PLAY/PAUSE** ►/|| button once again.

Step Motion Playback (Except CD)

Press the **STEP** button on the remote control during playback.

- Each time the button is pressed, a new frame will appear.
- No sound is heard during STEP mode.
- Press the **PLAY/PAUSE** ►/|| button to resume normal playback (You can only perform step motion playback in the forward direction).

Slow Motion Playback (Except CD)

Press the **FWD SEARCH** (►►) button on the remote control during PAUSE or STEP mode.

- By pressing the **FWD SEARCH** (►►) button, you can select slow motion playback for 1/2, 1/4 or 1/8 of normal speed.
- No sound is heard during slow mode.
- Press the **PLAY/PAUSE** ►/|| button to resume normal playback.
- When playing a **VCD/DVD**, the reverse slow motion playback will not work.

Playing a Disc (MP3)

ENG

- 1 Press the **OPEN/CLOSE** button. Place a disc gently into the tray with the disc's label facing up.

Result: The first song file of the first folder is played.

- 2 Press the **STOP** button, then press the **RETURN** button to display the music folder menu on the right side of the screen. Up to 8 music folders can be displayed at a time. If you have more than 8 folders on a disc, press the **LEFT/RIGHT** button to bring them up on the screen.

- 3 Press the **UP/DOWN** button to select the desired music folder, then press the **ENTER** button.

- 4 Press the **UP/DOWN** button again to select a song file. Press the **ENTER** button to begin playback of the song file.

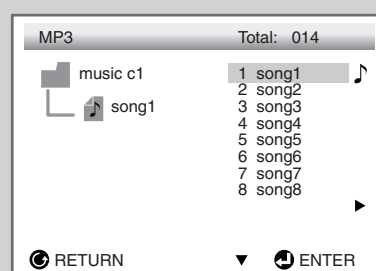
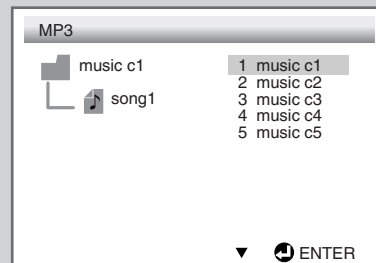

When playing CD-R MP3 discs, please follow the recommendations below:

- ◆ **Your MP3 files should be ISO 9660 or JOLIET format.**
ISO 9660 format and Joliet MP3 files are compatible with Microsoft's DOS and Windows, and with Apple's Mac. These two formats are the most widely used.
- ◆ **When naming your MP3 files do not exceed 8 characters, and place ".mp3" as the file extension.**
General name format of: Title.mp3. When composing your title, make sure that you use 8 characters or less, have no spaces in the name, and avoid the use of special characters including: (.,/, \, =, +).
- ◆ **Use a decompression transfer rate of at least 128 Kbps when recording MP3 files.**
Sound quality with MP3 files basically depends on the rate of compression/decompression you choose. Getting audio CD quality sound requires an analog/digital sampling rate (conversion to MP3 format) of at least 128 Kbps and up to 160 Kbps. However, choosing higher rates, like 192 Kbps or more, only rarely give better sound quality. Conversely, files with sampling rates below 128 Kbps will not be played properly.
- ◆ **Do not try recording copyright protected MP3 files.**
Certain "securized" files are encrypted and code protected to prevent illegal copying. These files are of the following types: Windows Media™ (registered trade mark of Microsoft Inc) and SDMI™ (registered trademark of The SDMI Foundation). You cannot copy such files.
- ◆ **Your DVD player only accepts one level of file directory.**
Consequently you must choose:
 - either to save all your MP3 recording files at the root of the disc;
 - and/or create folders in the directory for each artist or music type (e.g.classical, rock, jazz, etc)
- ◆ **Important:** The above recommendations cannot be taken as a guarantee that the DVD player will play MP3 recordings, or as an assurance of sound quality. You should note that certain technologies and methods for MP3 file recording on CD-Rs prevent optimal playback of these files on your DVD player (degraded sound quality and in some cases, inability of the player to read the files).

Using the Search and Skip Functions

ENG

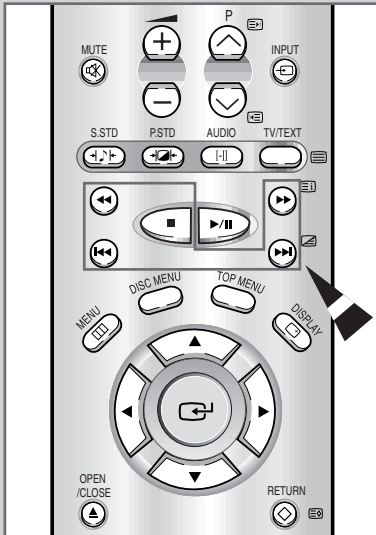

Searching through a Chapter or Track

Press the FWD ►► or REV ◄◄ SEARCH button on the remote control during playback.

- Press the FWD ►► or REV ◄◄ SEARCH button on the remote control and press again to search at a faster speed (2X/4X/8X/16X/32X/128X) on the DVD.
- Press the FWD ►► or REV ◄◄ SEARCH button on the remote control and press again to search at a faster speed on VCD (4X/8X) and CD (2X/4X/8X).
- To return to normal speed playback, press the PLAY/PAUSE ►/|| button.

Skipping Tracks

During playback, press the NEXT SKIP ►► or BACK SKIP ◄◄ button.









- When playing a DVD, if you press the NEXT SKIP ►► button, it moves to next chapter. If you press the BACK SKIP ◄◄ button, it moves to the beginning of the chapter. One more press makes it move to the beginning of the previous chapter.
- When playing a VCD 2.0 in MENU OFF mode, a VCD1.1 or a CD, if you press the NEXT SKIP ►► button, it moves to next track. If you press the BACK SKIP ◄◄ button, it moves to the the beginning of the track. One more press makes it move to the beginning of the previous track.
- If a track exceeds 15 minutes when playing a VCD and you press the NEXT SKIP ►► button, it moves forward 5 minutes. If you press the BACK SKIP ◄◄ button, it moves backward 5 minutes.
- When playing a VCD 2.0 in the MENU MODE or Track View function, if you press the NEXT SKIP ►► button, it moves to the next MENU or the next Track View display. If you press the BACK SKIP ◄◄ button, it moves to the previous MENU or the previous Track View display.

- ◆ When in search mode (4X/8X/16X/32X/128X) on a DVD or high-speed playback on a VCD, no sound will be heard.
- ◆ When 2X SCAN AUDIO is set to ON in the SETUP MENU, no sound will be heard on discs which are recorded with LPCM, DTS or MPEG-2.
- ◆ Depending on the disc, audio may not be heard when a disc is in 2X playback mode.







Using the Display Function

ENG

When Playing a DVD

- 1 During playback, press the **DISPLAY**  button.
Result: Current title, chapter number, elapsed time, audio, subtitle and volume control will be displayed.
- 2 Use the numeric buttons to enter a different title, then press the **ENTER**  button. Use the **LEFT/RIGHT**  or numeric buttons to enter a chapter number, then press the **ENTER**  button.
- 3 To enter the time from which you want to start, use the **UP/DOWN**  button to select, then use the numeric buttons to enter the time. Then press the **ENTER**  button.
- 4 Use the **LEFT/RIGHT**  buttons to change the values of the current audio, subtitle and volume.
- 5 To make the screen disappear, press the **DISPLAY**  button again.

When Playing a CD/VCD

- 1 During playback, press the **DISPLAY**  button.
Result: Current track number, elapsed time and volume control will be displayed.
- 2 Use the **UP/DOWN**  button to select a track. Use the **LEFT/RIGHT**  button or numeric buttons to enter a different track number, then press the **ENTER**  button.
- 3 To enter the time from which you want to start, use the **UP/DOWN**  button to select, then use the numeric buttons to enter the time. Press the **ENTER**  button.
- 4 To change the value of the volume, use the **LEFT/RIGHT**  button.

➤ In VCD 2.0 mode (MENU ON mode), only the volume control will appear on screen.

➤ **What is a Chapter?**

Each Title on a DVD can be divided into chapters (similar to tracks on an audio CD).

◆ **What is a Title?**

A DVD may contain several different titles. For example, if a disc contains four different movies, each might be considered a title.

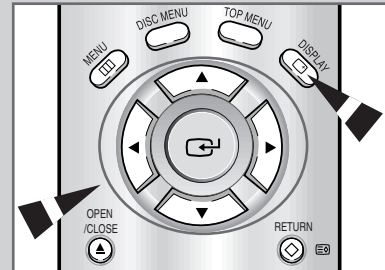

DVD

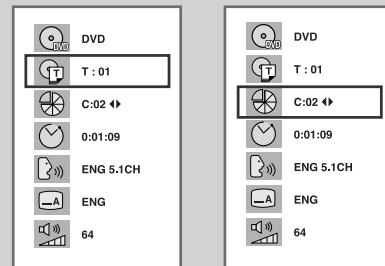

CD

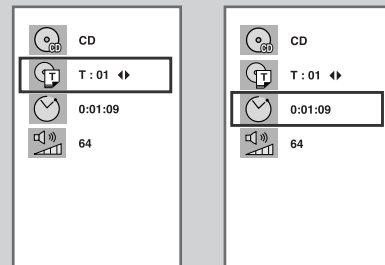

VCD

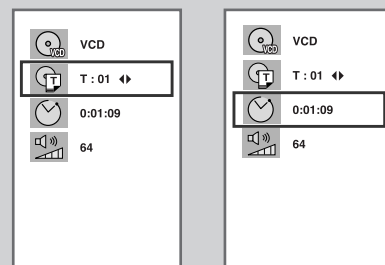

Repeat Play

ENG

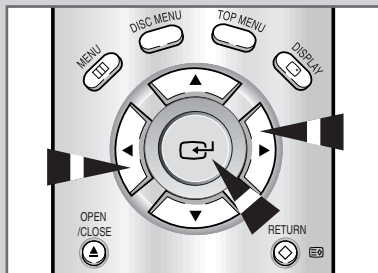
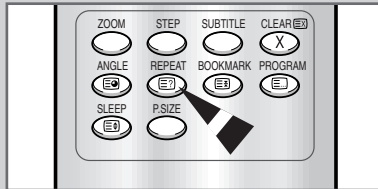

DVD

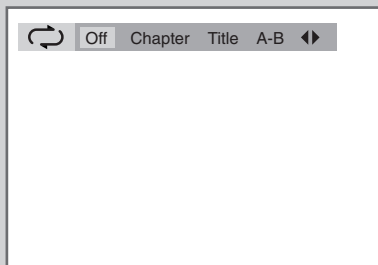

VCD/CD

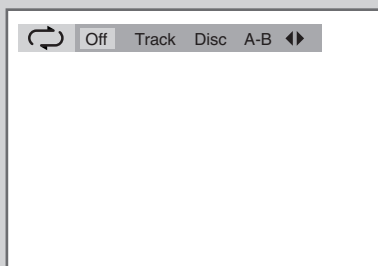

Repeat the current track, chapter, title, a chosen section (A-B), or all of the disc (VCD/CD only).

When playing a DVD

- 1 Press the **REPEAT** button. Repeat screen appears.
- 2 Select Chapter, Title or A-B using the LEFT/RIGHT ◀▶ button.
- 3 **A-B Repeat**
 - 1 Press the **REPEAT** button. Select A-B on screen with the LEFT/RIGHT ◀▶ button.
 - 2 Press the ENTER ↵ button at the point where you want the repeat play to start (A). The B is automatically highlighted.
 - 3 Press the ENTER ↵ button at the point where you want the repeat play to stop (B).
- 4 Press the ENTER ↵ button
- 5 To return to normal playback press the **REPEAT** button again, then press the LEFT/RIGHT ◀▶ button to select Off and press the ENTER ↵ button.

- ◆ DVD repeats playback by chapter or title, CD and VCD repeat playback by disc or track.
- ◆ Depending on the disc, the Repeat function may not work.
- ◆ If the title or track is completed before marking the end (B), the end of title or track becomes B automatically.
- ◆ When in VCD 2.0 mode (MENU ON mode), this function does not work.

Program Play and Random Play

ENG

Program Playback

- 1 Press the **PROGRAM** button.
- 2 Use the LEFT/RIGHT ◀▶ button to select **PROGRAM**. Press the ENTER ↵ button.
- 3 Use the LEFT/RIGHT ◀▶ button to select the first chapter (or track) to add to the program. Press the ENTER ↵ button. The selection numbers appear in the Program Order box.
- 4 Press the PLAY/PAUSE ▶|| button. The disc will be played back in programmed order.

Random Playback

- 1 Press the **PROGRAM** button.
- 2 Use the LEFT/RIGHT ◀▶ button to select **RANDOM**. Press the ENTER ↵ button.
Result: The disc will be played back in random order.

- ◆ Depending on the disc, the Program and Random Playback function may not work.
- ◆ When in VCD 2.0 mode (MENU ON mode), these functions do not work.
- ◆ To resume normal playback, press the **CLEAR (X)** button.

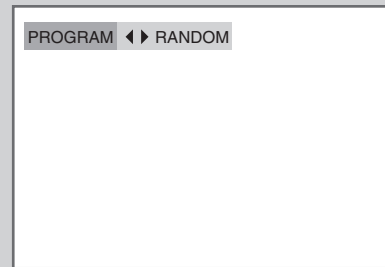
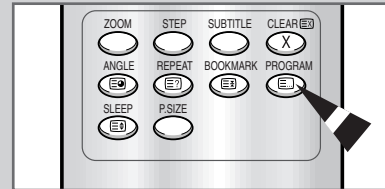

DVD

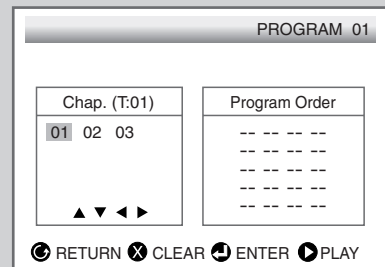

VCD/CD

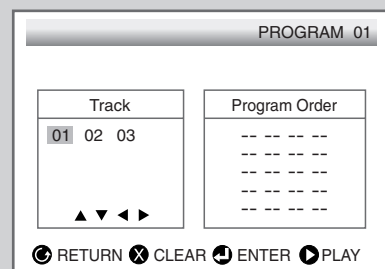

MP3

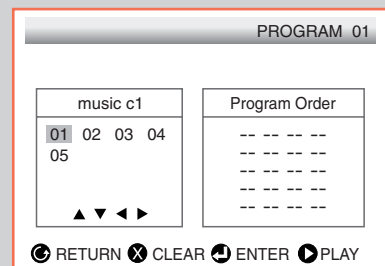

Using the Disc View Function

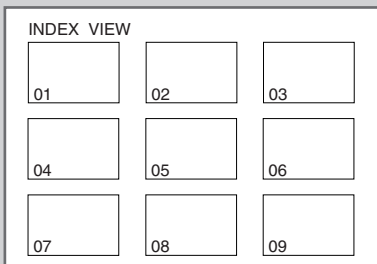
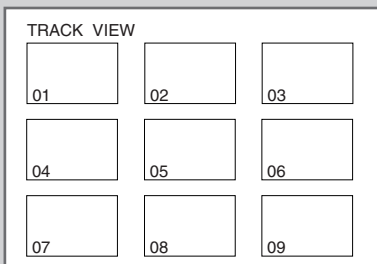
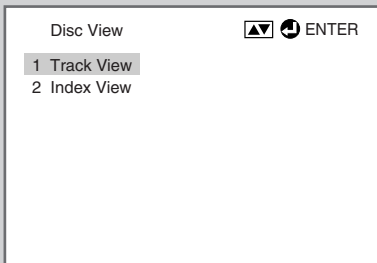
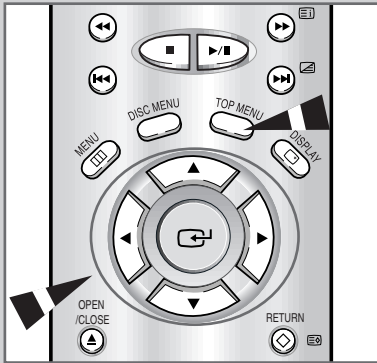

Displays the beginning view of each track and the track number (VCD).

- 1 During playback, press the **TOP MENU** button.
- 2 Press the UP/DOWN ▲▼ button to select **Track View**. Press the ENTER ↵ button.
- 3 Select the desired view by pressing the UP/DOWN ▲▼ or LEFT/RIGHT ◀▶ buttons.
 - Press the **NEXT SKIP** ▶▶ button for the next 9 tracks if the movie has more than 9.
- 4 Press the ENTER ↵ button.

Displays the equally divided 9 views of the current playing track (VCD).

- 1 During playback, press the **TOP MENU** button.
- 2 Press the UP/DOWN ▲▼ button to select **Index View**. Press the ENTER ↵ button.
- 3 Select the desired view by pressing the UP/DOWN ▲▼ or LEFT/RIGHT ◀▶ buttons.
- 4 Press the ENTER ↵ button.

- ◆ When pressing the **TOP MENU** button with a DVD; the disc's **TITLE MENU** function comes up. A disc must have at least two titles for the **TITLE MENU** function to work.
- ◆ When pressing the **TOP MENU** button with a CD; the unit enters the **INTRO** mode. **INTRO** lets you listen to the beginning of each track for about 10 seconds.

Selecting the Audio Language

You can select a desired language quickly and easily with the **AUDIO** button.

Using the AUDIO Button

- 1 Press the **AUDIO** button.
- 2 Use the UP/DOWN ▲▼ button to select the desired language on a DVD.
Result: The audio languages are represented by abbreviations.
- 3 Use the UP/DOWN ▲▼ button to select **Stereo, Right or Left.** (On VCD/CD).

Using the MENU Button (When playing a DVD)

- 1 Press the **MENU** button.
- 2 Use the UP/DOWN ▲▼ button to select **DVDP SETUP**. Use the LEFT/RIGHT ◀▶ button.
Result: The **SETUP MENU** is displayed.
- 3 Use the UP/DOWN ▲▼ button to select **Audio**. Press the ENTER button.
- 4 Use the LEFT/RIGHT ◀▶ button to select **English**. Press the ENTER button.

- ◆ This function depends on what languages are encoded on the disc and may not work with all DVDs.
- ◆ A DVD disc can contain up to 8 audio languages.
- ◆ **How to have the same audio language come up whenever you play back a DVD?**
Refer to "Setting Up the Language Features" on page 37.

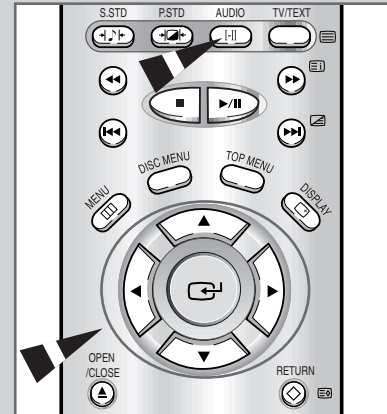

DVD

ENG DOLBY DIGITAL 5.1CH ▼

VCD/CD

Stereo ▲▼

SETUP MENU

- | | |
|-------------------|-----------|
| 1 Player Menu | English |
| 2 Disc Menu | English |
| 3 Audio | English |
| 4 Subtitle | Automatic |
| 5 Parental | Unlocked |
| 6 Audio Options | |
| 7 Display Options | |

RETURN ▲▼ ENTER

AUDIO LANGUAGE

- ▶ 1 English
- 2 Fran ais
- 3 Deutsch
- 4 Espa ol
- 5 Italiano
- 6 Nederlands
- 7 Original
- 8 Others

RETURN ▲▼ ENTER

Selecting the Subtitle Language

ENG

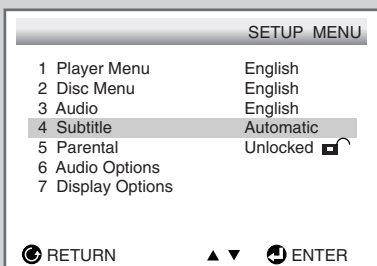
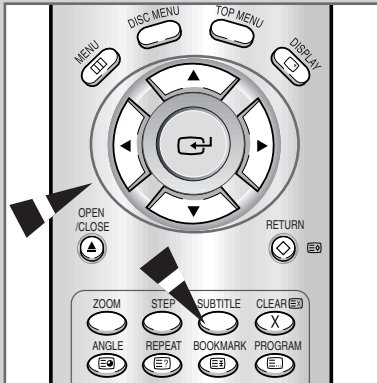

You can select a desired subtitle quickly and easily with the **SUBTITLE** button.

Using the **SUBTITLE** button

- 1 Press the **SUBTITLE** button.
- 2 Use the UP/DOWN ▲▼ button to select the desired subtitle language.
- 3 Use the LEFT/RIGHT ◀▶ button to determine whether or not the subtitle will be displayed.
Result: Initially, the subtitling will not appear on screen. The subtitle languages are represented by abbreviations.

Using the **MENU** button (When playing a DVD)

- 1 Press the **MENU** button.
- 2 Use the UP/DOWN ▲▼ button to select **DVDP SETUP**. Use the LEFT/RIGHT ◀▶ button.
Result: The **SETUP MENU** is displayed.
- 3 Use the UP/DOWN ▲▼ button to select **Subtitle**. Press the **ENTER** button.
- 4 Use the LEFT/RIGHT ◀▶ button to select **English**. Press the **ENTER** button.

- ♦ This function depends on what languages are encoded on the disc and may not work with all DVDs.
- ♦ A DVD disc can contain up to 32 subtitle languages.
- ♦ **How to have the same subtitle language come up whenever you play back a DVD?**
Refer to "Setting Up the Language Features" on page 37.

Changing the Camera Angle

When a DVD contains multiple angles of a particular scene, you can select the Angle function.

Using the **ANGLE** button

Press the ANGLE button to see if an “ANGLE (📷)” mark is present at the upper right hand corner of the screen.

- 1 When an “ANGLE (📷)” mark is shown, press the **ANGLE** button.
Result: The angle select icon will appear at the upper left hand corner of the screen.
- 2 Use the UP/DOWN▲▼ button to select the desired screen angle.
- 3 To turn off the display, press the **ANGLE** button again.

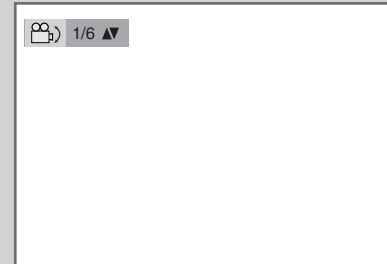
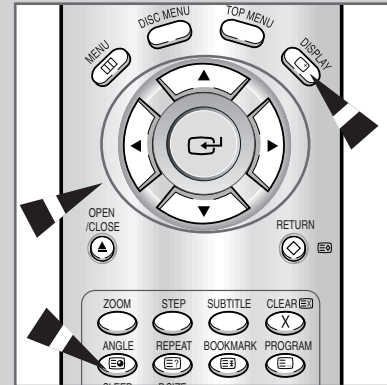

ENG

Using the Zoom Function (DVD/VCD)

ENG

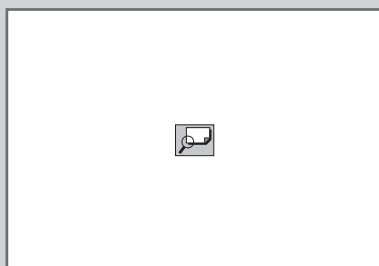
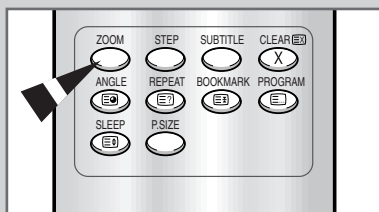

- 1 During playback or pause mode, press the **ZOOM** button on the remote. A square will be displayed on screen.
- 2 Use the UP/DOWN ▲▼ or LEFT/RIGHT ◀▶ button to select the part of the screen you want to zoom.
- 3 Press the ENTER ↵ button.

- ◆ During DVD playback, press the ENTER ↵ button to zoom in 2X/4X/2X in order.
- ◆ During VCD playback, press the ENTER ↵ button to zoom in 2X.

Using the Bookmark Function

ENG

The **Bookmark** function lets you select parts of a DVD or VCD (MENU OFF mode) so that you can quickly find the section at a later time.

Using the Bookmark Function (DVD/VCD)

- 1 During playback, press the **BOOKMARK** button.
Result: A marker will be displayed.
- 2 Use the LEFT/RIGHT ◀▶ button to move to the desired bookmark icon.
- 3 When you reach the scene you want to mark, press the ENTER ↵ button. The icon will change to a number (1, 2, or 3).
- 4 Press the **BOOKMARK** button to turn off the display.

Recalling a Marked Scene

- 1 During playback, press the **BOOKMARK** button.
- 2 Use the LEFT/RIGHT ◀▶ button to select a marked scene.
- 3 Press the PLAY/PAUSE ▶/⏸ button to skip to the marked scene.

Clearing a Bookmark

- 1 During playback, press the **BOOKMARK** button.
- 2 Use the LEFT/RIGHT ◀▶ button to select the bookmark number you want to delete.
- 3 Press the **CLEAR (X)** button to delete a bookmark number. Press the **BOOKMARK** button to turn off display.

- ◆ Up to three scenes may be marked at the same time.
- ◆ When in VCD 2.0 mode (MENU ON mode), this function does not work.
- ◆ Depending on the disc, the Bookmark function may not work.

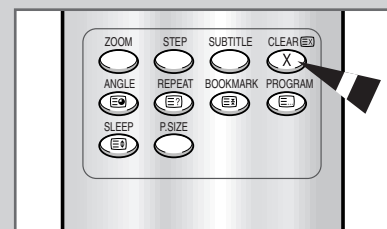
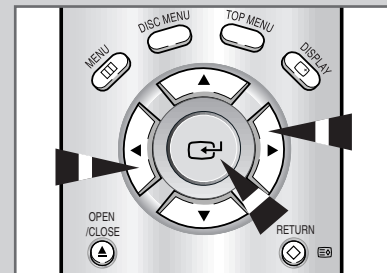
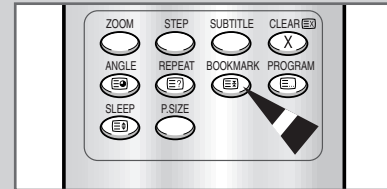

Using the Setup Menu

ENG

MENU
PICTURE
SOUND
CHANNEL
FUNCTION
DVDP SETUP





◀▶ ADJUST ▲▼ SELECT □□ EXIT

SETUP MENU

1 Player Menu	English
2 Disc Menu	English
3 Audio	English
4 Subtitle	Automatic
5 Parental	Unlocked 
6 Audio Options	
7 Display Options	

⏪ RETURN ▲ ▼ ⏩ ENTER

The Setup menu lets you customize your DVD player by allowing you to select various language preferences, set up a parental level, even adjust the player to the type of television screen you have.

- 1 Press the **MENU**  button.
- 2 Use the UP/DOWN  button to select **DVDP SETUP**. Use the LEFT/RIGHT  button.
Result: The **SETUP MENU** is displayed.
- 3 Use the UP/DOWN  button to access the different features.
- 4 Press the ENTER  button to access the sub features.
- 5 To make the setup screen disappear after setting up, press the **RETURN** button.

➤ Depending on the disc, some Setup Menu selections may not work.

Setting Up the Language Features

ENG

If you set the player menu, disc menu, audio and subtitle language in advance, it will come up automatically every time you watch a movie.

Using the Player Menu

Use the Player preference menu to select the language for the player's on-screen displays.

- 1 Press the **MENU** button.
- 2 Use the UP/DOWN ▲▼ button to select **DVDP SETUP**. Use the LEFT/RIGHT ◀▶ button.
Result: The **SETUP MENU** is displayed.
- 3 Use the UP/DOWN ▲▼ button to select **Player Menu**.
- 4 Press the ENTER button.
- 5 Use the UP/DOWN ▲▼ button to select **English**. Press the ENTER button.
- **English** is selected and the screen returns to **SETUP MENU**.

➤ To make the SETUP MENU disappear, press the **RETURN** button.

Using the Disc Menu Language

Use the Menu preference menu to select the language you want a DVD's disc menu to be displayed in.

- 1 Use the UP/DOWN ▲▼ button to select **Disc Menu**.
- 2 Press the ENTER button.
- 3 Use the UP/DOWN ▲▼ button to select **English**.
- Select **Others** if the language you want is not listed.
- 4 Press the ENTER button.
- **English** is selected and the screen returns to **SETUP MENU**.

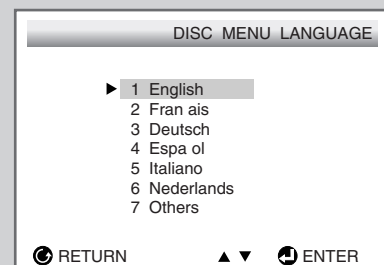
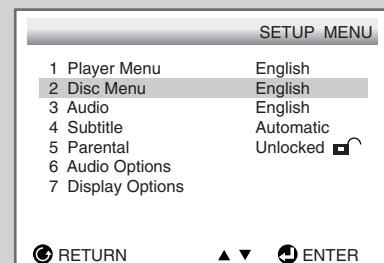
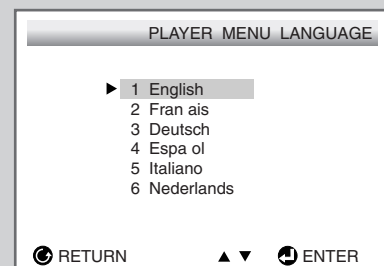
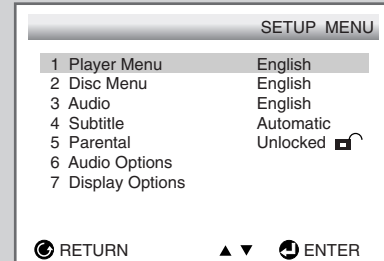

Setting Up the Language Features

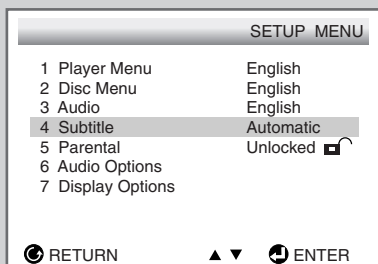
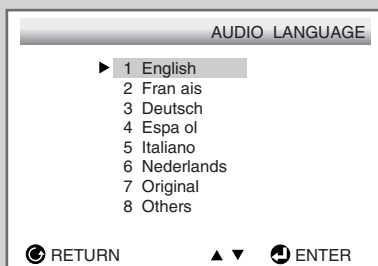
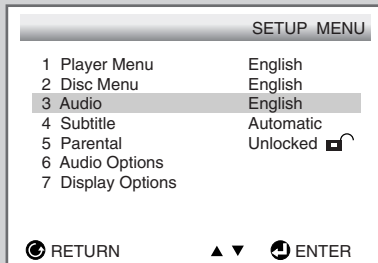

Using the Audio Language

Use the Audio preference menu to select the sound-track language.

- 1 Press the **MENU** button.
- 2 Use the UP/DOWN ▲▼ button to select **DVDP SETUP**. Use the LEFT/RIGHT ◀▶ button.
Result: The **SETUP MENU** is displayed.
- 3 Use the UP/DOWN ▲▼ button to select **Audio**.
- 4 Press the ENTER button.
- 5 Use the UP/DOWN ▲▼ button to select **English**.
 - Select **Original** if you want the default soundtrack language to be the original language the disc is recorded in.
 - Select **Others** if the language you want is not listed.
- 6 Press the ENTER button.
 - **English** is selected and the screen returns to **SETUP MENU**.

Using the Subtitle Language

Use the Subtitle preference menu to select the language the disc's subtitles are to be displayed in.

- 1 Use the UP/DOWN ▲▼ button to select **Subtitle**.
- 2 Press the ENTER button.
- 3 Use the UP/DOWN ▲▼ button to select **English**.
 - Select **Automatic** if you want the subtitle language to be the same as the language selected as the audio preference.
 - Select **Others** if the language you want is not listed. Some discs may not contain the language you select as your initial language; in that case the disc will use its original language setting.
- 4 Press the ENTER button.
 - **English** is selected and the screen returns to **SETUP MENU**.

- ♦ If the selected language is not recorded on the disc, the original pre-recorded language is selected.
- ♦ **How to make the SETUP MENU disappear or return to menu screen during set up?**
Press the **RETURN** button.

Setting Up the Parental Control

The Parental Control function works in conjunction with DVDs that have been assigned a rating - which helps you control the types of DVDs that your family watches. There are up to 8 rating levels on a disc.

- 1 Press the **MENU** button.
- 2 Use the UP/DOWN button to select **DVDP SETUP**. Use the LEFT/RIGHT button.
Result: The **SETUP MENU** is displayed.
- 3 Use the UP/DOWN button to select **Parental**. Press the ENTER button.
Result: The **PARENTAL CONTROL** screen appears.
- 4 Use the LEFT/RIGHT button to select **Yes** if you want to use a password. Press the ENTER button.
Result: The **Enter Password** screen appears.
- 5 Enter your password.
Result: The **Re-enter Password** screen appears to confirm the password.
- 6 Enter your password again.
Result: The **PARENTAL CONTROL** screen appears again.
- 7 **About the Rating Level;**
The **Rating Level** will work only when **Use Password** is set to **Yes**. To unlock the player, use LEFT/RIGHT button to select **No**.
 - Use UP/DOWN button to select **Rating Level**. Press the ENTER button.
 - Use UP/DOWN button to select the level (e.g. Level 6) and press the ENTER button. Discs that contain Level 7 will now not play.
 - To cancel the rating level, use the LEFT/RIGHT button to select **No** in **Use Password**.
- 8 **About the Change Password;**
 - Use the UP/DOWN button to select **Change Password**. Press the ENTER button. Then, the **Enter New Password** screen appears.
 - Enter your new password. Then, the **Re-enter New Password** screen appears to confirm the password.
 - Enter your new password again.

➤ If you have forgotten your password, refer to "Problems and Solutions" on page 47.

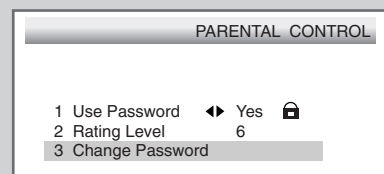
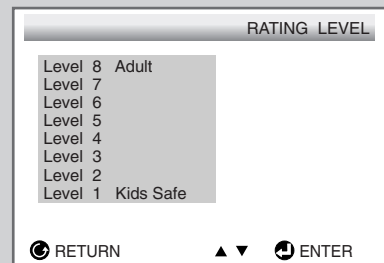
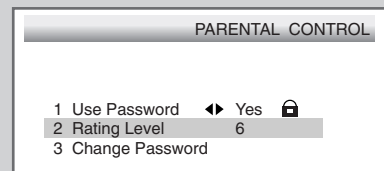
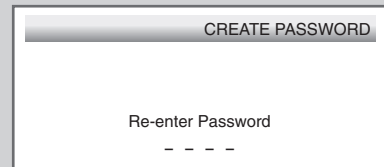
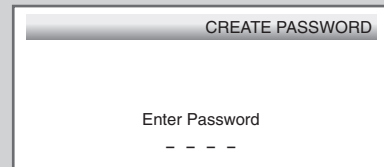
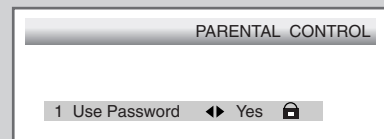
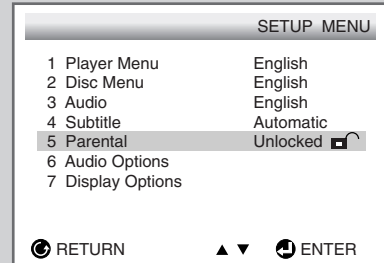

Setting Up the Audio Options

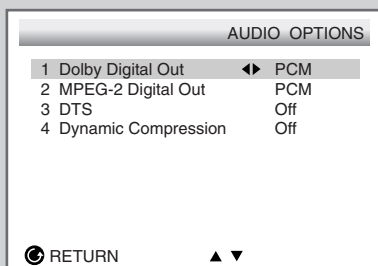
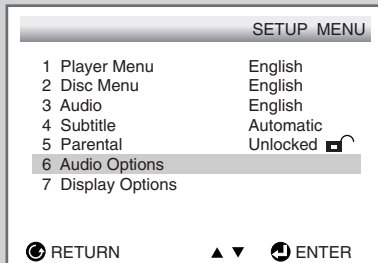

- 1 Press the **MENU** button.
- 2 Use the UP/DOWN **▲▼** button to select **DVDP SETUP**. Use the LEFT/RIGHT **◀▶** button.
Result: The **SETUP MENU** is displayed.
- 3 Use the UP/DOWN **▲▼** button to select **Audio Options**. Press the ENTER **↵** button.
- 4 Use the UP/DOWN **▲▼** button to select the desired item. Then press the LEFT/RIGHT **◀▶** button.

Dolby Digital Out / MPEG-2 Digital Out

PCM : Converts to **PCM(2CH) audio**. Select PCM when using the Analog Audio Outputs.

Bitstream : Converts to Dolby Digital Bitstream - 5.1CH (in case of MPEG-2, **5.1CH or 7.1CH**). Select Bitstream when using the Digital Audio Output.

DTS

On : Outputs DTS Bitstream via digital output only. Select DTS when connecting to a DTS Decoder.

Off : Doesn't output digital signal.

Dynamic Compression

On : To select dynamic compression.

Off : To select the standard range.

- ◆ Manufactured under license from Dolby Laboratories. "Dolby" and the double-D symbol are trademarks of Dolby Laboratories.
- ◆ "DTS" and "DTS Digital Out" are trademarks of Digital Theater Systems, Inc.

Setting Up the Display Options

ENG

- 1 Press the **MENU** button.
- 2 Use the UP/DOWN▲▼ button to select **DVDP SETUP**. Use the LEFT/RIGHT◀▶ button.
Result: The **SETUP MENU** is displayed.
- 3 Use the UP/DOWN▲▼ button to select **Display Options**. Press the ENTER button.
- 4 Use the UP/DOWN▲▼ button to select the desired item. Then press the LEFT/RIGHT◀▶ button.

TV Aspect

Depending on the type of television you have, you may want to adjust the screen setting (aspect ratio).

- 4:3 Letter Box :** Select when you want to see the total 16:9 ratio screen DVD supplies, even though you have a TV with a 4:3 ratio screen. Black bars will appear at the top and bottom of the screen.
- 4:3 Pan-Scan :** Select this for conventional size TVs when you want to see the central portion of the 16:9 screen. (Extreme left and right side of movie picture will be cut off.)
- 16:9 Wide :** You can view the full 16:9 picture on your wide screen TV.

Still Mode

These options will help prevent picture shake in still mode and display small text clearer.

Auto : When selecting **Auto**, **Field/Frame** mode will be automatically converted.

Field : Select this feature when the screen shakes in the **Auto** mode.

Frame : Select this feature when you want to see small letters more clearly in the **Auto** mode.

Screen Messages

Use to turn on-screen messages on or off.

Black Level

Adjusts the brightness of the screen. **(On/Off)**

NTSC Disc Output

When outputting the NTSC Disc to the external device of NTSC system, select **NTSC**. For the PAL system, select **PAL 60Hz**. Otherwise, there may be no color or abnormal color.

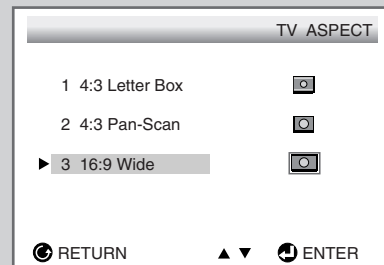
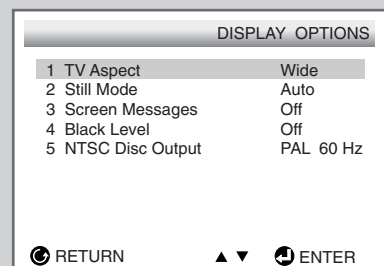
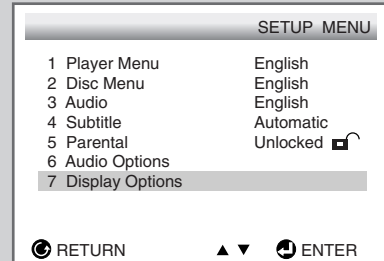

Disc Type and Characteristics

The DVD player is capable of playing the following types of discs with the corresponding logos:

Disc Types (Logos)	Recording Types	Disc Size	Max. Playing Time	Characteristics
DVD 	Audio + Video	5"	Single-sided: 240 min. Double-sided: 480 min.	<ul style="list-style-type: none"> - DVD contains excellent sound and video due to Dolby Digital and MPEG-2 system. - Various screen and audio functions can be easily selected through the on-screen menu.
		3 1/2"	Single-sided: 80 min. Double-sided: 160 min.	
VIDEO-CD 	Audio + Video	5"	74 min.	<ul style="list-style-type: none"> - Video with CD sound, VHS quality and MPEG-1 compression technology.
		3 1/2"	20 min.	
AUDIO-CD 	Audio	5"	74 min.	<ul style="list-style-type: none"> - CD is recorded as a Digital Signal with better audio quality, less distortion and less deterioration of audio quality over time.
		3 1/2"	20 min.	

Disc Markings



Play Region Number

Both the DVD player and the discs are coded by region. These regional codes must match in order for the disc to play. If the codes do not match, the disc will not play.



NTSC NTSC broadcast system in U.S.A, Canada, Korea, Japan, etc.



PAL PAL broadcast system



DIGITAL SOUND Digital Audio disc



DOLBY DIGITAL Dolby Digital disc



DTS DTS disc



STEREO Stereo disc



MP3 MP3

Teletext Feature

ENG

Most television channels provide a written information service via Teletext. They provide such information as:

- ◆ Television programme times
- ◆ News bulletins
- ◆ Weather forecasts
- ◆ Sports results
- ◆ Travel information

This information, which you cannot modify, is divided into numbered pages laid out as follows:

Part	Contents
A	Header information, such as the: <ul style="list-style-type: none">◆ Selected page number◆ Broadcasting channel identity◆ Current page number or search indications◆ Date and time
B	Text.
C	Status information.

- Teletext information is often divided between several pages displayed in sequence. These pages can be accessed in different ways:
- ◆ By entering the page number
 - ◆ By selecting a title in a list
 - ◆ By selecting a coloured heading (FASTEXT system)

You can also store a few pages to be displayed later in sequence. The pages remain available even after the television is switched off and on again.

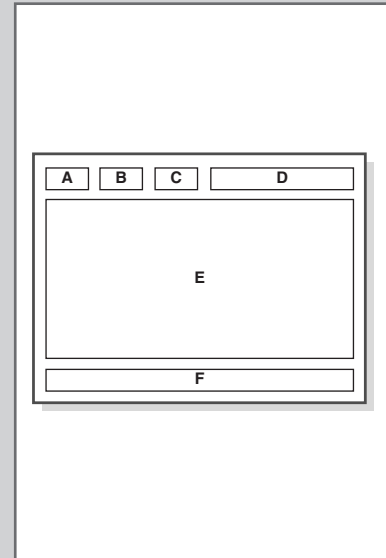

Displaying the Teletext Screen

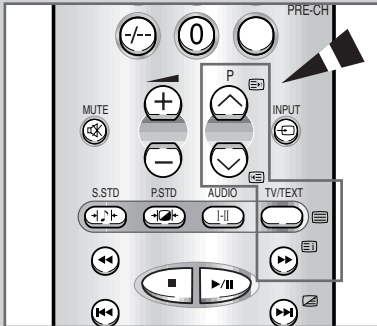

You can display Teletext information at any time on your television screen.

- ☞ For Teletext information to be displayed correctly, channel reception must be good; otherwise:
 - ◆ Information may be missing
 - ◆ Some pages may not be displayed

To activate the Teletext mode and display the contents page, follow the instructions below.

- 1 Select the channel providing the Teletext service, using the **P** or **P** button.
- 2 Press the **TV/TEXT** button to activate the Teletext mode.
Result: The contents page is displayed. It can be redisplayed at any time by pressing the **INDEX** button.
- 3 When you have finished, press the **TV/TEXT** button to return to normal viewing.

Selecting Display Options

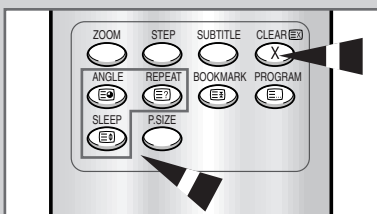
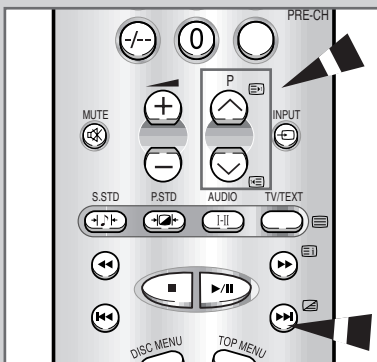

When you have displayed a Teletext page, you can select various options to suit your requirements.



To...	Press the...
Display the next page	.
Display the previous page	.
Display both the Teletext information and the normal broadcast	.
Temporarily hide the Teletext page to view the normal broadcast (press the same button again to recall the same page)	.
Reveal hidden text (answers in questionnaire games, for example)	.
Select a secondary page by entering its number	.
Display in double-height letters the... <ul style="list-style-type: none"> ◆ Upper half of the screen ◆ Lower half of the screen 	. ◆ Once. ◆ Twice.

- To return to the normal display after using the hidden text or double-height letter features, press the same button again.

Selecting a Teletext Page

You can enter the page number directly by pressing the numeric buttons on the remote control.

- 1 Enter the three-digit page number given in the contents, by pressing the corresponding numeric buttons.
Result: The current page number is incremented until the requested page is reached. That page is then displayed.

- 2 If the selected page is linked with several secondary pages, the secondary pages are displayed in turn. To freeze the display on a given page, press the  button. Press the  button again to continue the display.

- 3 If the FASTEXT system is used by the broadcasting company, the different topics covered on a Teletext page are colour-coded and can be selected by pressing the coloured buttons on the remote control. Press the coloured button corresponding to the topic that you wish to select; the available topics are given on the status line.
Result: The page is displayed with other coloured information that can be selected in the same way.

- 4 When you have finished, press the TV/TEXT () button to return to your normal broadcast.

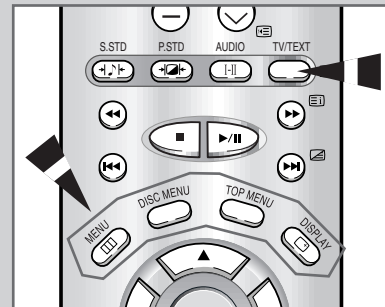
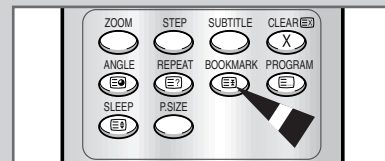

Storing Teletext Pages

Up to four teletext pages can be stored.

- 1 Select the LIST mode.
Result: Four 3-digit numbers are displayed in different colors at the bottom of the screen.

- 2 Press the colored button corresponding to the page that will be replaced.

- 3 Enter the new page number using the numeric buttons.

- 4 Repeat steps 2 and 3 for each page to be stored, using a different colored button each time.

- 5 Press the STORE () button until the corresponding blocks blink.

- The LIST () button is used to switch between:
- ◆ LIST mode,
 - ◆ FLOF mode.

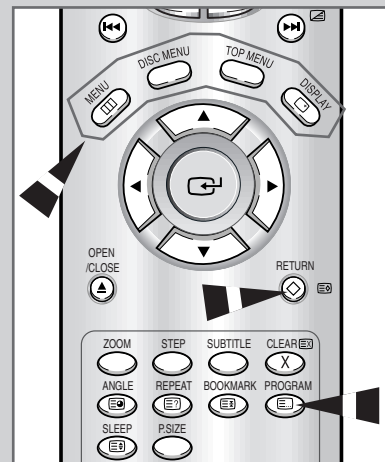

Specifications

General

Power Requirements	100-240V~, 50Hz
Dimensions (W x D x H) / Weight	606 x 513 x 505 mm / 29.5 kg
Operating Temperature Range	+5°C to +35°C
Operating Humidity Range	10% to 75%
Monitor Video Out	PAL

Disc

DVD (DIGITAL VERSATILE DISC)	Reading Speed : 3,49 m/sec. Approx. Play Time (Single Sided, Single Layer Disc): 135 min.
CD : 12 Cm (COMPACT DISC)	Reading Speed : 1,2 to 1,4 m/sec. Maximum Play Time : 74 min.
CD : 8 Cm (COMPACT DISC)	Reading Speed : 1,2 to 1,4 m/sec. Maximum Play Time : 20 min.
VCD : 12 Cm	Reading Speed : 1,2 to 1,4 m/sec. Maximum Play Time : 74 min. (Video + Audio)

Problemes and Solutions

Problemes	Solutions
No sound or picture.	<ul style="list-style-type: none"> ◆ Check that the mains lead has been connected to a wall socket. ◆ Check that you have pressed the ON/OFF button (⏻) and the POWER button (⏻). ◆ Check the picture contrast and brightness settings. ◆ Check the volume.
Normal picture but no sound.	<ul style="list-style-type: none"> ◆ Check the volume. ◆ Check whether the volume MUTE button (⏻) has been pressed on the remote control.
No picture or black and white picture.	<ul style="list-style-type: none"> ◆ Adjust the colour settings. ◆ Check that the broadcast system selected is correct.
Sound and picture interference.	<ul style="list-style-type: none"> ◆ Try to identify the electrical appliance that is affecting the television and move it further away. ◆ Plug your television into a different mains socket.
Blurred or snowy picture, distorted sound.	<ul style="list-style-type: none"> ◆ Check the direction, location and connections of your aerial. This interference is often due to the use of an indoor aerial.
Remote control malfunctions	<ul style="list-style-type: none"> ◆ Replace the remote control batteries. ◆ Clean the upper edge of the remote control (transmission window). ◆ Check the battery terminals.

Problemes and Solutions

ENG

Problemes	Solutions
No operations can be performed with remote.	<ul style="list-style-type: none"> ◆ Check the batteries in the remote. May need replacing. ◆ Operate the remote control at a distance of no more than 20 feet. ◆ Remove batteries and hold down one or more buttons for several minutes to drain the microprocessor inside the remote to reset it. Reinstall batteries and try remote again.
Disc does not play.	<ul style="list-style-type: none"> ◆ Ensure that the disc is installed with the label side facing up. ◆ Check the region number of the DVD.
5.1 channel sound is not being reproduced.	<ul style="list-style-type: none"> ◆ 5.1 channel sound is reproduced only when the following conditions are met. : <ol style="list-style-type: none"> 1) The DVD player is connected with the proper amplifier. 2) The disc is recorded with 5.1 channel sound. <ul style="list-style-type: none"> - Check whether the disc being played has the "Dolby 5.1 ch" mark on the outside. - Check if your audio system is connected and working properly. - In a SETUP Menu, is the Audio Output set to Bitstream?
The  icon appears on screen.	<ul style="list-style-type: none"> ◆ The features or action cannot be completed at this time because : <ol style="list-style-type: none"> 1) The DVD's software restricts it. 2) The DVD's software doesn't support the feature (e.g., angles). 3) The feature is not available at the moment. 4) You've requested a title or chapter number or search time that is out of range.
Disc Menu doesn't appear.	<ul style="list-style-type: none"> ◆ Check if the disc has a Menu.
Playback mode differs from the Setup Menu selection.	<ul style="list-style-type: none"> ◆ Some of the functions selected in the Setup Menu may not work properly if the disc is not encoded with the corresponding function.
The screen ratio can not be changed.	<ul style="list-style-type: none"> ◆ The Screen Ratio is fixed on your DVDs.
No audio.	<ul style="list-style-type: none"> ◆ Make sure you have selected the correct Digital Output in the Audio Options Menu.
Forgot password.	<ul style="list-style-type: none"> ◆ Press power on from a cold start with no disc in the unit. Press the OPEN/CLOSE button or PLAY▶/ button. Press the STOP■ and PLAY▶/ buttons simultaneously on the front panel for three seconds. Select the Parental Mode. The Parental Mode is now unlocked as indicated on the display. Press the UP/DOWN▲▼ button to select Parental. Press the ENTER↵ button and the Create Password display will appear. You can now set your rating level and change your password to a new number.
If you experience other problems.	<ul style="list-style-type: none"> ◆ Go to the contents and find the section of the instruction book that contains the explanations regarding the current problem, and follow the procedure once again. ◆ If the problem still cannot be solved, please contact your nearest authorized service center.

– AFTER SALES SERVICE

- Do not hesitate to contact your retailer or service agent if a change in the performance of your product indicates that a faulty condition may be present.



AA68-02285B-00 (ENG)

Free Manuals Download Website

<http://myh66.com>

<http://usermanuals.us>

<http://www.somanuals.com>

<http://www.4manuals.cc>

<http://www.manual-lib.com>

<http://www.404manual.com>

<http://www.luxmanual.com>

<http://aubethermostatmanual.com>

Golf course search by state

<http://golfingnear.com>

Email search by domain

<http://emailbydomain.com>

Auto manuals search

<http://auto.somanuals.com>

TV manuals search

<http://tv.somanuals.com>