



User manual

NB-NH

The color and the appearance may differ depending on the product, and the specifications are subject to change without prior notice to improve the performance.

BN46-00204B-01

Table Of Contents

BEFORE USING THE PRODUCT	4	Copyright
	4	Icons used in this manual
	4	Symbols for safety precautions
	5	Safety Precautions
	5	Electricity and Safety
	6	Installation and Safety
	8	Operation and Safety
PREPARATIONS	12	Checking the Contents
	12	Removing the Packaging
	13	Checking the Components
	14	Parts
	14	Button
	15	Reverse Side
	16	Right Side View
	17	Installation
	17	Reassembly
	19	Adjusting the Product Height
	20	Anti-theft Lock
USING "PCOIP"	21	What is a "PC over IP"?
	22	Connection to Use "PCoIP"
	22	Before Connecting
	23	Connecting to a Video device
	25	Connecting to a LAN
	25	Connecting a USB Devices
	26	Connecting to Headphones or Speakers
	26	Connecting MIC
	27	Connection Using a Serial Cable
	29	Connecting to a Secondary Monitor
	30	Connecting the Power
	31	Connect to host PC using LAN cable

Table Of Contents

	32	"PCoIP"
	32	On Screen Display (OSD)
	32	Connect Screen
	33	OSD Options Menu
	34	Configuration Window
	44	Diagnostics Window
	48	Information Window
	50	User Settings Window
	57	Password Window
TROUBLESHOOTING GUIDE	59	Requirements Before Contacting Samsung Customer Service Center
	59	Check the following.
SPECIFICATIONS	60	General
	61	Power consumption
APPENDIX	62	Contact SAMSUNG WORLD WIDE
	68	Responsibility for the Pay Service (Cost to Customers)
	68	Not a product defect
	68	A Product damage caused by customer's fault
	68	Others
	69	Correct Disposal
	69	Correct Disposal of This Product (Waste Electrical & Electronic Equipment)
	69	Correct disposal of batteries in this product
INDEX		

Before Using the Product

Copyright

The contents of this manual are subject to change without notice to improve quality.

© 2012 Samsung Electronics

Samsung Electronics owns the copyright for this manual.

Use or reproduction of this manual in parts or entirety without the authorization of Samsung Electronics is prohibited.

The SAMSUNG logos is registered trademarks of Samsung Electronics.

Microsoft and Windows are registered trademarks of Microsoft Corporation.

VESA, DPM and DDC are registered trademarks of the Video Electronics Standards Association.





- An administration fee may be charged if either
 - (a) an engineer is called out at your request and there is no defect in the product (i.e. where you have failed to read this user manual).
 - (b) you bring the unit to a repair centre and there is no defect in the product (i.e. where you have failed to read this user manual).
- The amount of such administration charge will be advised to you before any work or home visit is carried out.

Icons used in this manual



The following images are for reference only. Real-life situations may differ from what is shown in the images.

Symbols for safety precautions

 Warning	A serious or fatal injury may result if instructions are not followed.
 Caution	Personal injury or damage to properties may result if instructions are not followed.
	Activities marked by this symbol are prohibited.
	Instructions marked by this symbol must be followed.

Before Using the Product

Safety Precautions

 The monitor images in this manual are for reference only. Monitor is sold separately.

Electricity and Safety

Warning



Do not use a damaged power cord or plug, or a loose power socket.

- An electric shock or fire may result.



Do not plug many products into the same power socket.

- Otherwise, the socket may overheat and cause a fire.



Do not touch the power plug with wet hands.

- Otherwise, an electric shock may result.

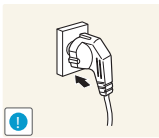

Insert the power plug all the way in so it is not loose.

- An unstable connection may cause a fire.

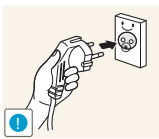

Ensure you connect the power plug to a grounded power socket. (type 1 insulated devices only).

- An electric shock or injury may result.

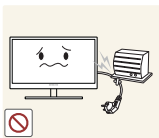

Do not bend or pull the power cord with force. Do not weigh the power cord down with a heavy object.

- A damaged power cord may cause an electric shock or fire.



Do not place the power cord or product near heat sources.

- An electric shock or fire may result.



Remove foreign substances such as dust around the plug pins and power socket with a dry cloth.

- Otherwise, a fire may result.

Before Using the Product

Caution



Do not unplug the power cord when the product is in use.

- The product may become damaged by an electric shock.

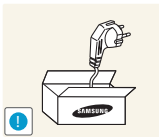

Do not use the power cord for products other than authorized products supplied by Samsung.

- An electric shock or fire may result.

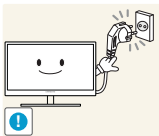

Keep the power socket where the power cord is connected unobstructed.

- If any problem occurs in the product, unplug the power cable to completely cut the power to the product.

Power to the product cannot be completely cut off with the power button.

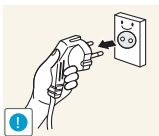

Hold the plug when disconnecting the power cord from the power socket.

- An electric shock or fire may result.

Installation and Safety

Warning



DO NOT PLACE CANDLES, INSECT REPELLANTS OR CIGARETTES ON TOP OF THE PRODUCT. DO NOT INSTALL THE PRODUCT NEAR HEAT SOURCES.

- Otherwise, a fire may result.



Avoid installing the product in a narrow space with bad ventilation, such as a bookshelf or wall closet.

- Otherwise, a fire may result due to an increased internal temperature.

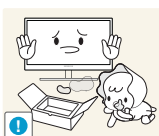

Keep the plastic packaging bag for the product in a place that cannot be reached by children.

- Children may suffocate.

Before Using the Product



Do not install the product on an unstable or vibrating surface (insecure shelf, sloped surface, etc.).

- The product may fall and break or cause a personal injury.
- Using the product in an area with excess vibration may damage the product or cause a fire.



Do not install the product in a vehicle or a place exposed to dust, moisture (water drips, etc.), oil, or smoke.

- An electric shock or fire may result.



Do not expose the product to direct sunlight, heat, or a hot object such as a stove.

- Otherwise, the product lifespan may be reduced, or a fire may result.



Do not install the product within the reach of young children.

- The product may fall and injure children.



Edible oil, such as soybean oil, can damage or deform the product. Do not install the product in a kitchen or near a kitchen counter.

Caution



Take care not to drop the product when moving it.

- Otherwise, product failure or personal injury may result.



When installing the product on a cabinet or shelf, make sure that the bottom edge of the front of the product is not protruding.

- The product may fall and break or cause a personal injury.
- Install the product only on cabinets or shelves of the right size.

Before Using the Product

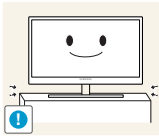

Put down the product carefully.

- The product may fall and break or cause a personal injury.



Installing the product in an unusual place (a place exposed to a lot of fine particles, chemical substances or extreme temperatures, or an airport or train station where the product should operate continuously for an extended period of time) may seriously affect its performance.

- Be sure to consult Samsung Customer Service Center (page 62) before installation if you want to install the product at such a place.

Operation and Safety

Warning



High voltage runs through the product. Do not attempt to disassemble, repair, or modify the product on your own.

- An electric shock or fire may result.
- Contact Samsung Customer Service Center (page 62) for repair.

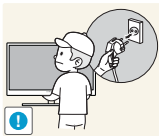

Before moving the product, turn off the power switch and disconnect the power cable and all other connected cables.

- Damage to the cord may result in a fire or electric shock.

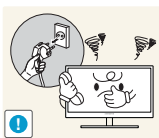

If the product generates a strange noise, a burning smell, or smoke, remove the power cord immediately and contact Samsung Customer Service Center (page 62).

- An electric shock or fire may result.

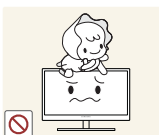

Do not let children hang from the product or climb on top of it.

- The product may fall, and your child may become injured or seriously harmed.

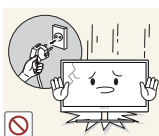

If the product falls or the exterior is damaged, power off the product, remove the power cord, and contact Samsung Customer Service Center (page 62).

- Otherwise, an electric shock or fire may result.



Do not put a heavy object, toy, or sweets on top of the product.

- The product or heavy objects may fall as children try to reach for the toy or sweets resulting in a serious injury.

Before Using the Product

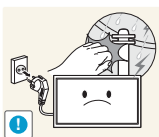

During a lightning or thunderstorm, power off the product and remove the power cable.

- An electric shock or fire may result.



Do not drop objects on the product or apply impact.

- An electric shock or fire may result.



Do not move the product by pulling the power cord or any cable.

- Otherwise, the cable may be damaged and product failure, an electric shock or fire may result.



If a gas leakage is found, do not touch the product or power plug. Also, ventilate the area immediately.

- Sparks can cause an explosion or fire.

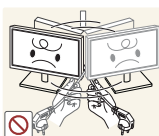

Do not lift or move the product by pulling the power cord or any cable.

- Otherwise, the cable may be damaged and product failure, an electric shock or fire may result.

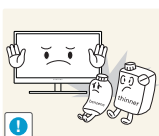

Do not use or keep combustible spray or an inflammable substance near the product.

- An explosion or fire may result.



Ensure the vents are not blocked by tablecloths or curtains.

- Otherwise, a fire may result from an increased internal temperature.

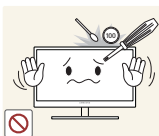

Do not insert a metallic object (a chopstick, coin, hair pin, etc.) or inflammable object (paper, match, etc.) into the vent or ports of the product.

- If water or any foreign substance enters the product, be sure to power off the product, remove the power cord, and contact Samsung Customer Service Center (page 62).
- Product failure, an electric shock or fire may result.

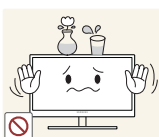

Do not place objects containing liquid (vases, pots, bottles, etc) or metallic objects on top of the product.

- If water or any foreign substance enters the product, be sure to power off the product, remove the power cord, and contact Samsung Customer Service Center (page 62).
- Product failure, an electric shock or fire may result.

Before Using the Product

Caution

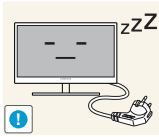

Disconnect the power cord from the power socket if you do not plan on using the product for an extended period of time (vacation, etc.).

- Otherwise, a fire may result from accumulated dust, overheating, an electric shock, or electric leakage.

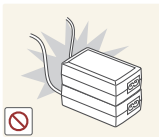

Do not put DC power adapters together.

- Otherwise, a fire may result.

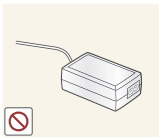

Remove the plastic bag from the DC power adapter before you use it.

- Otherwise, a fire may result.



Do not let water enter the DC power adapter or get the adapter wet.

- An electric shock or fire may result.
- Avoid using the product outdoors where it can be exposed to rain or snow.
- Be careful not to get the DC power adapter wet when you wash the floor.



Do not put the DC power adapter near to any heating apparatus.

- Otherwise, a fire may result.

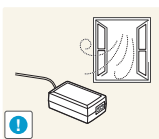

Keep the DC power adapter in a well-ventilated area.



Do not use humidifiers or stoves around the product.

- An electric shock or fire may result.

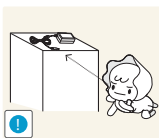

Store the small accessories used with the product out of reach of children.

Before Using the Product

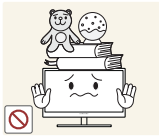

Do not place heavy objects on the product.

- Product failure or personal injury may result.

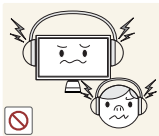

When using headphones or earphones, do not turn the volume too high.

- Having the sound too loud may damage your hearing.

1.1 Checking the Contents

1.1.1 Removing the Packaging

- 1 Open the packaging box. Be careful not to damage the product when you open the packaging with a sharp instrument.

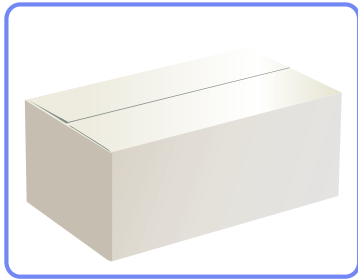

- 2 Remove the styrofoam from the product.

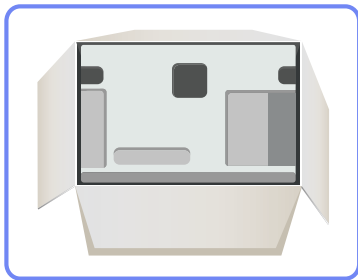

- 3 Check the components and remove the styrofoam and plastic bag.
 - The appearance of actual components may differ from the image shown.
 - This image is for reference only.
- 4 Store the box in a dry area so that it can be used when moving the product in the future.

1.1.2 Checking the Components



- Contact the dealer from whom you purchased the product if any item is missing.
- The appearance of the components and items sold separately may differ from the image shown.

Components

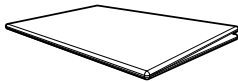

Quick setup guide



Warranty card
(Not available in some locations)

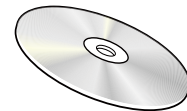

User manual

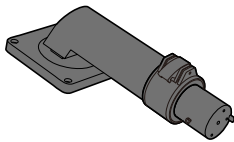

Stand connector

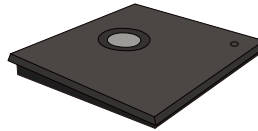

Stand base



Power cable



DC power adapter



- Components may vary depending on the country.
- The stand base supplied with this product contains a circuit board. Care should be taken when handling the base.

Items sold separately



The following items can be purchased at your nearest retailer.

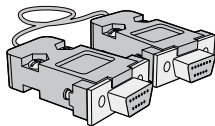

RS-232C cable

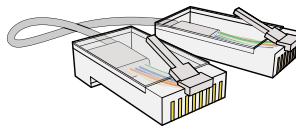

LAN cable

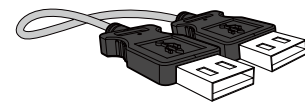

USB cable

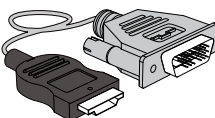

HDMI-DVI cable

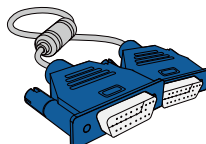

D-SUB cable

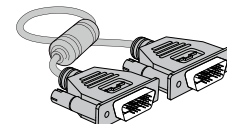

DVI cable

1.2 Parts

1.2.1 Button



The color and shape of parts may differ from what is shown. Specifications are subject to change without notice to improve quality.

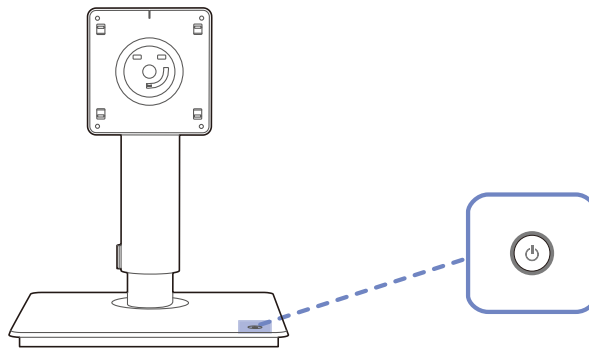





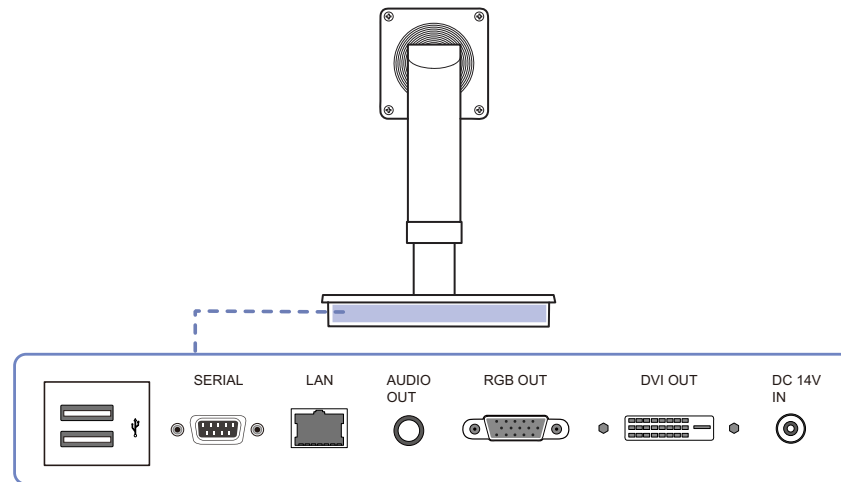

Icon	Description	
	Turn on the power	Press the power button to turn on the product.
	Turn off the power	Press and hold the power button for more than 2 seconds to turn off the product.
	Close a session	Press the power button while connected to the server. The current session will close.

1.2.2 Reverse Side



The color and shape of parts may differ from what is shown. Specifications are subject to change without notice to improve quality.

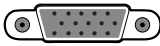





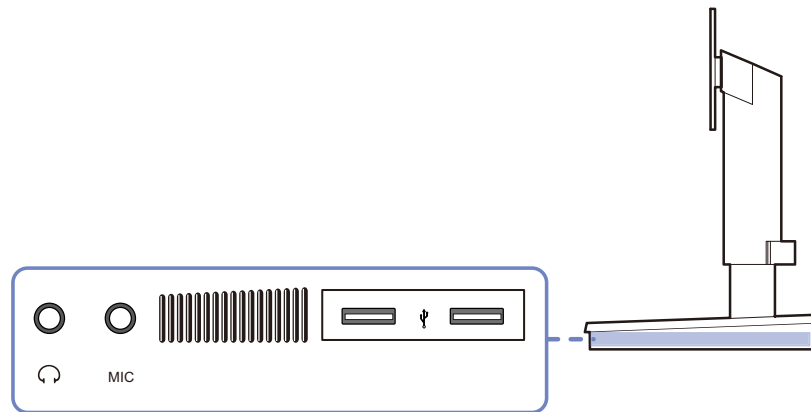

Ports	Description
	Connect to a USB device.
SERIAL 	Device which support RS-232C connection (interface) can be connected.
LAN 	Connect to a network using the LAN cable.
AUDIO OUT 	Connect to an audio output device such as headphones.
RGB OUT 	Connect to the monitor using the D-SUB cable.
DVI OUT 	Connect to the monitor using the DVI cable.
DC 14V IN 	Connect to the DC power adapter.

1.2.3 Right Side View



The color and shape of parts may differ from what is shown. Specifications are subject to change without notice to improve quality.



Ports	Description
 	Connect to an audio output device such as headphones.
 MIC	Connect to a microphone.
	Connect to a USB device.
	Speaker (located on both sides).

1.3 Installation

1.3.1 Reassembly

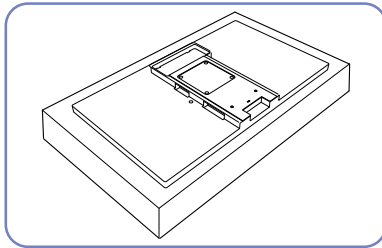

Prepare a monitor that will be connected to the stand. Put a protective cloth or cushion on a flat surface. Next, place the monitor facing down onto the cloth or cushion.

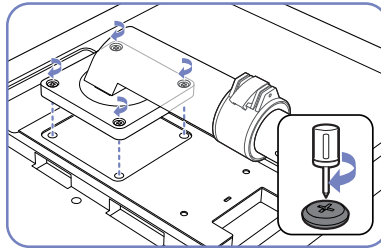

Align the grooves on the monitor to the grooves on the stand connector. Then, fasten with screws.

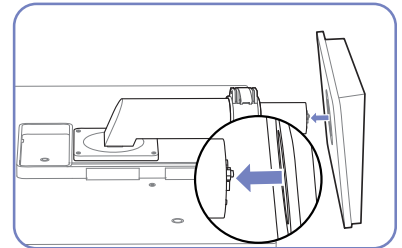

Insert the stand base into the stand in the direction of the arrow.

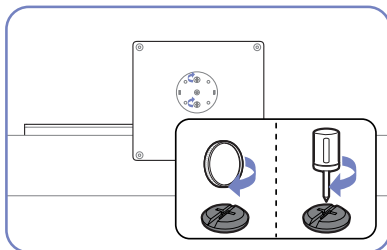

Fasten the screw tightly (using a screwdriver or coin) into the bottom of the stand base.

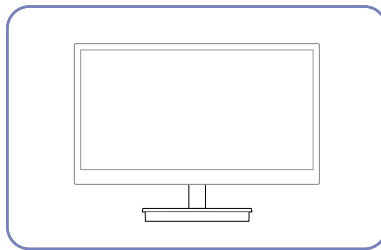

After installing the stand, place the product upright.



- The color and shape of parts may differ from what is shown. Specifications are subject to change without notice to improve quality.
- The monitor images in this manual are for reference only. Monitor is sold separately.
- Using screws longer than the supplied screws may cause internal product damage.
- Do not use a monitor or screw that does not comply with VESA standards. Also, do not use excessive force when attaching the stand to the monitor. The product may get damaged or fall and cause personal injury. Samsung shall not be held liable for any damage or injury caused by using improper screws or attaching the wall-mount kit or desktop stand using excessive force.

Caution

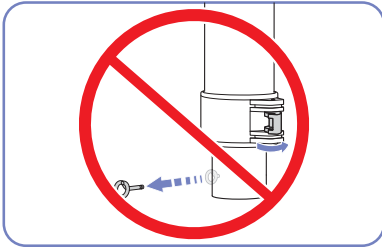

Do not unfasten the lock or remove the fixing pin on the stand before attaching the stand base to the stand.

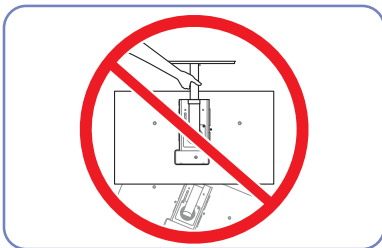

Do not hold the product upside down only by the stand.

1.3.2 Adjusting the Product Height

Adjust the stand height after attaching the stand to the monitor.



The color and shape of parts may differ from what is shown. Specifications are subject to change without notice to improve quality.

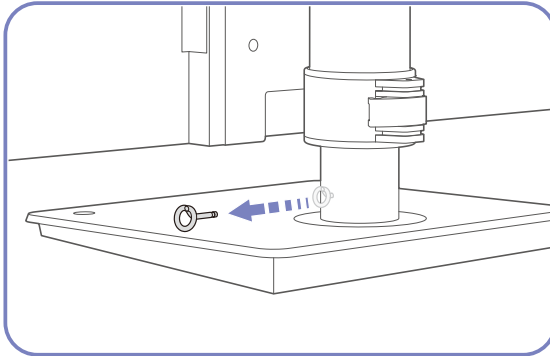

Remove the fixing pin.

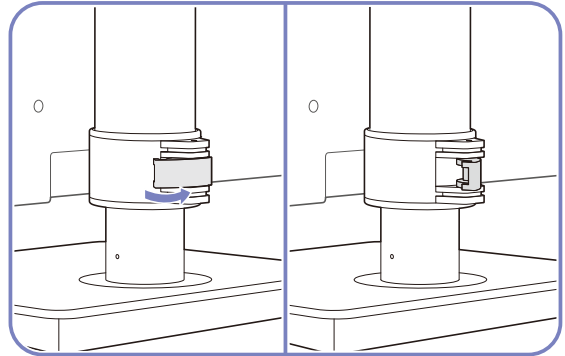

Unfasten the lock (outward direction) fixing the stand height.

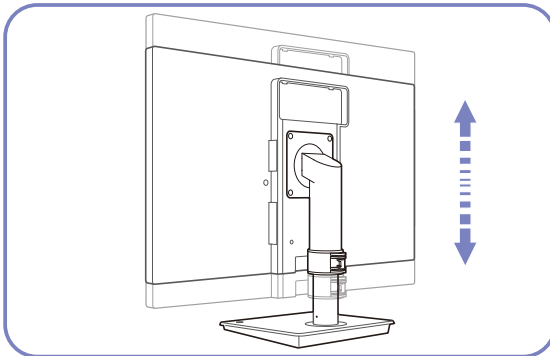

Adjust the stand height as desired.

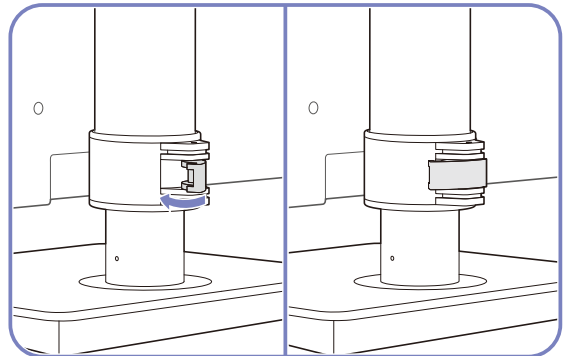

Fasten the lock (inward direction) on the stand.

- Hold the top center of the product and adjust the height carefully.

1.3.3 Anti-theft Lock

An anti-theft lock allows you to use the product securely even in public places. The locking device shape and locking method depend on the manufacturer. Refer to the user guide provided with your anti-theft locking device for details. The lock device is sold separately.

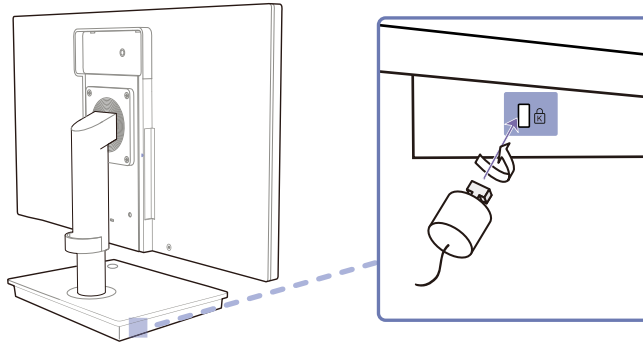

To lock an anti-theft locking device:

- 1 Fix the cable of your anti-theft locking device to a heavy object such as a desk.
- 2 Put one end of the cable through the loop on the other end.
- 3 Insert the locking device into the anti-theft lock slot at the back of the product.
- 4 Lock the locking device.



- An anti-theft locking device can be purchased separately.
- Refer to the user guide provided with your anti-theft locking device for details.
- Anti-theft locking devices can be purchased at electronics retailers or online.
- The monitor images in this manual are for reference only. Monitor is sold separately.

2.1 What is a "PC over IP"?

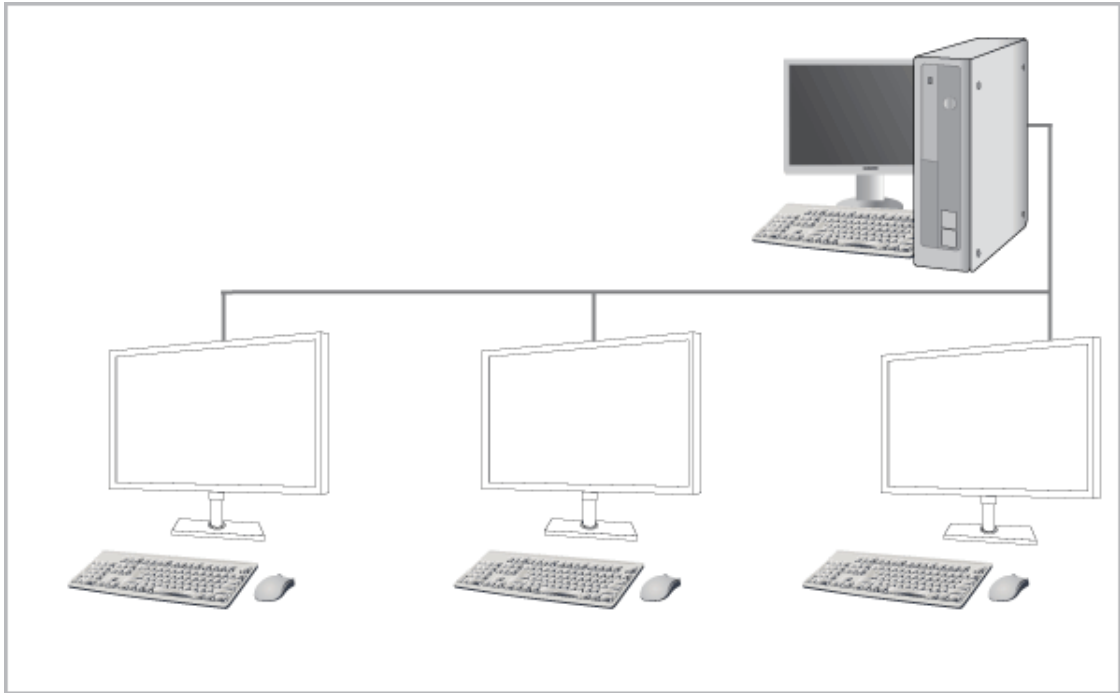

- This monitor can decode and display the screen of the server PC encoded and transmitted through the network (LAN) as well as display the computer screen like a conventional monitor. This monitor shows a far more improved performance than a normal RDP and has been designed to support a resolution of 1920*1080 pixels for high-quality graphic work.
- This monitor enables reinforced security because it is used by connecting it to a server PC and enabling you to access the Internet, create documents and edit figures. In addition, this new-concept monitor enables you to play music, videos and games by connecting an external input source device such as DSC, MP3, external storage device etc. to the USB port.
- This monitor can be utilized for various fields such as video conferencing and co-working by displaying the network display screen on another display device by connecting the device through the DVI OUT(RGB OUT) port.

2.2 Connection to Use "PCoIP"



- Connect the power cable to the monitor independently.
- The port names may vary depending on the monitor.
- For details on how to change the input source for your monitor, refer to monitor user manual.

2.2.1 Before Connecting

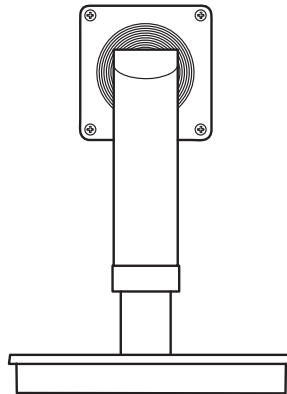

Pre-connection Checkpoints

- Before connecting a source device, read the user manual provided with it. The number and locations of ports can vary depending on the source device.
- Do not connect the power cable until all connections are completed. Connecting the power cable during connection may damage the product.
- Check the types of ports at the back of the product you want to connect.

2.2.2 Connecting to a Video device

- Do not connect the power cable before connecting all other cables.
- Ensure you connect a source device first before connecting the power cable.

2.2.2.1 Connection Using the D-SUB Cable (Analogue Type)

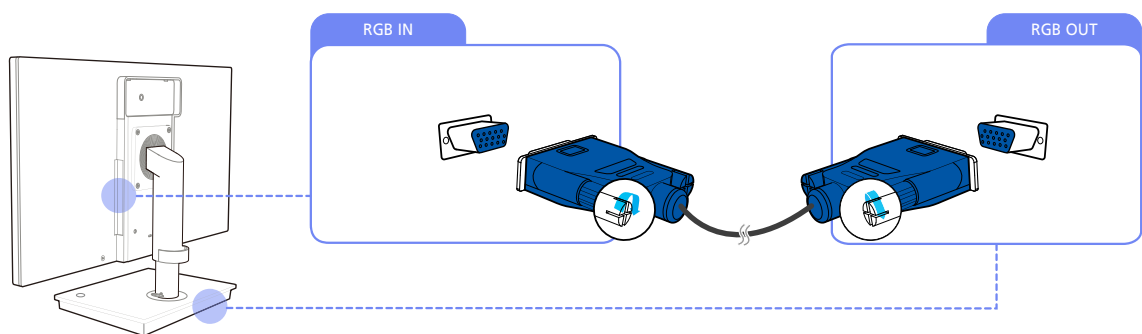

- 1 Connect the D-SUB cable to [RGB IN] on the back of the monitor and [RGB OUT] on the stand base.
- 2 Connect the DC power adapter to the product and a power outlet. Next, turn on the power switch on the stand base.
(For details, refer to "2.2.9 Connecting the Power".)
- 3 Change the input signal into analog, using the source button on the monitor.

2.2.2.2 Connection Using the DVI Cable

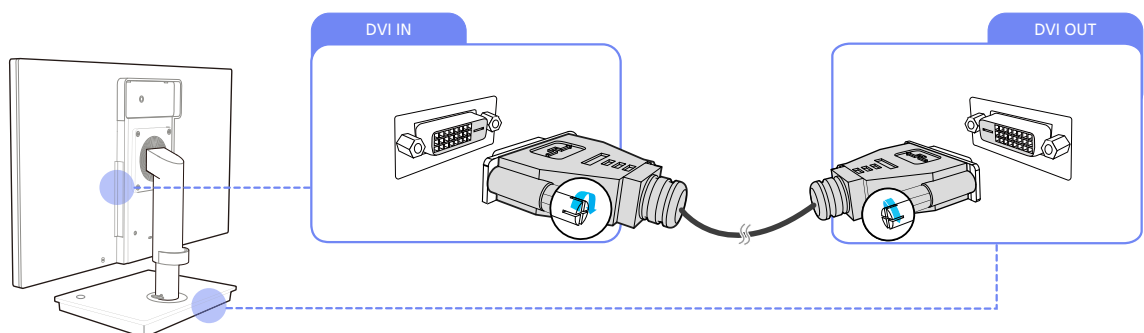

- 1 Connect the DVI cable to [DVI IN] on the back of the monitor and [DVI OUT] on the stand base.
- 2 Connect the DC power adapter to the product and a power outlet. Next, turn on the power switch on the stand base.
(For details, refer to "2.2.9 Connecting the Power".)
- 3 Change the input signal into digital, using the source button on the monitor.

2.2.2.3 Connection Using the HDMI-DVI Cable

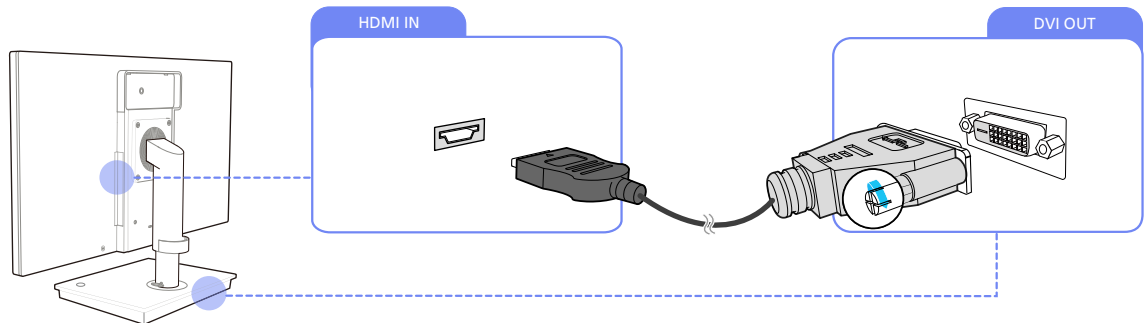

- 1 Connect the HDMI-DVI cable to [HDMI IN] on the back of the monitor and [DVI OUT] on the stand base.
- 2 Connect the DC power adapter to the product and a power outlet. Next, turn on the power switch on the stand base.
(For details, refer to "2.2.9 Connecting the Power".)
- 3 Change the input signal into digital, using the source button on the monitor.

2.2.3 Connecting to a LAN

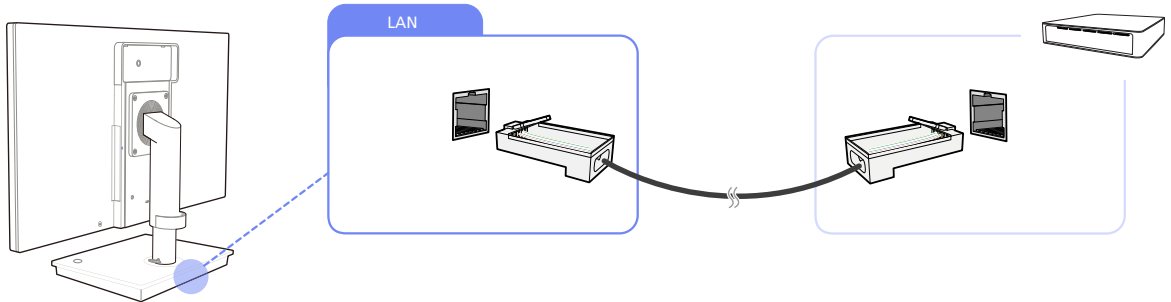

- 1 Connect the LAN cable to [LAN] on the back of the stand base.



It is not supported when the network speed is below or equal to 10Mbps.

2.2.4 Connecting a USB Devices



The [USB] port supports Full-speed USB 1.1.

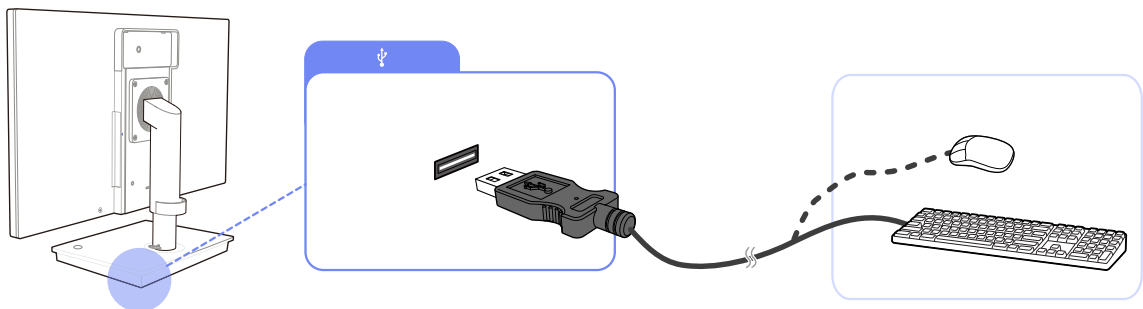

- 1 Connect a USB device (keyboard, mouse, etc.) to [USB] on the back or right side of the stand base.

2.2.5 Connecting to Headphones or Speakers

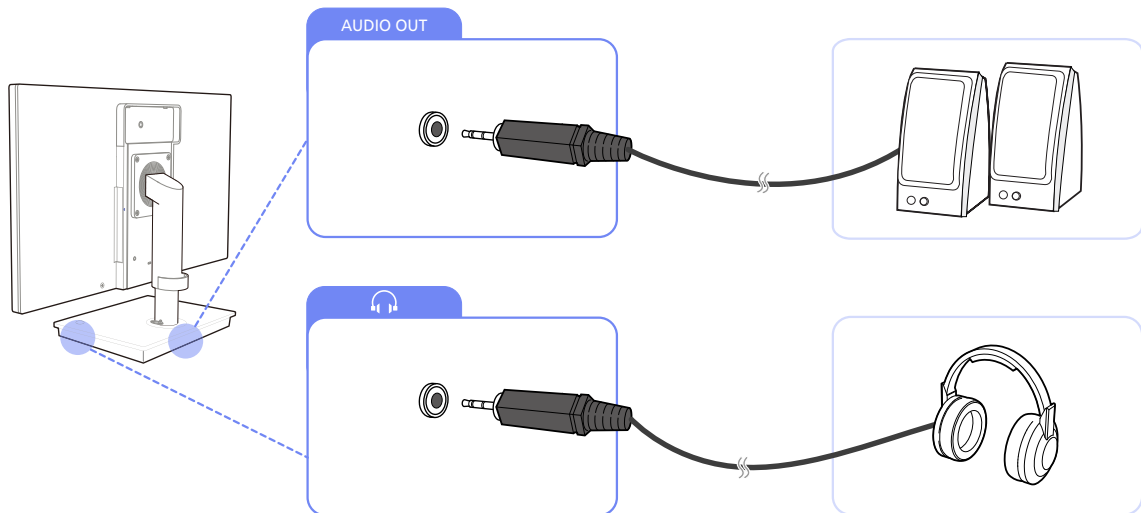

- 1 Connect an audio output device (headphones or speakers) to [AUDIO OUT] on the back or [🎧] on the right side of the stand base.

2.2.6 Connecting MIC

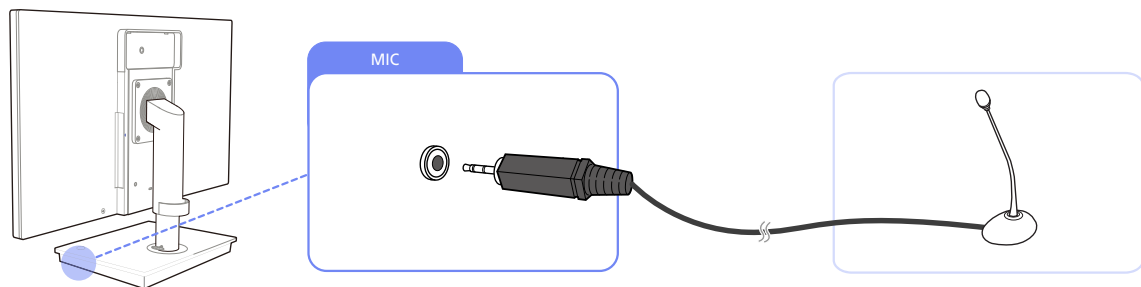

- 1 Connect the microphone to [MIC] on the right side of the stand base.

2.2.7 Connection Using a Serial Cable

2.2.7.1 Connection Using a Serial Cable

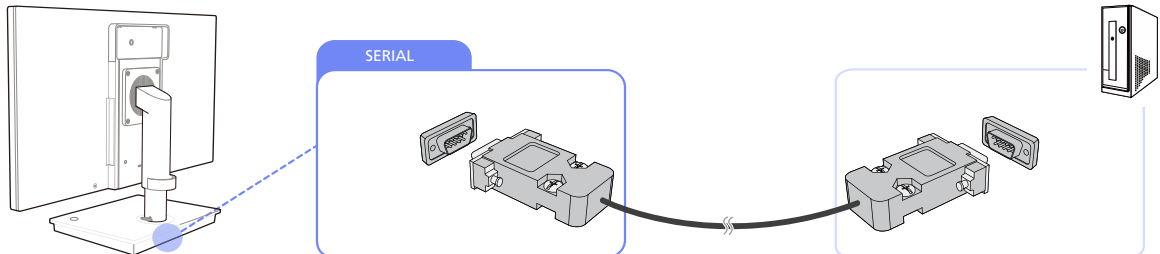

- 1 Connect the RS-232C cable to [SERIAL] on the back of the product and [SERIAL] on the PC.
- 2 Connect the DC power adapter to the product and a power socket. Next, turn on the power switch on the PC.

(For details, refer to "2.2.9 Connecting the Power".)



Device which support RS-232C connection (interface) can be connected.

2.2.7.2 Remote Control (RS232C)

Cable connections

interface	RS232C(9 pin)
pin	TxD(No.2) RxD(No.3) GND(No.5)
Bits rate	9600 bps
Data Bits	8 bit
Parity	None
Stop Bits	1 bit
Flow control	None
Maximum length	15 m (only shielded type)

- Pin assignment

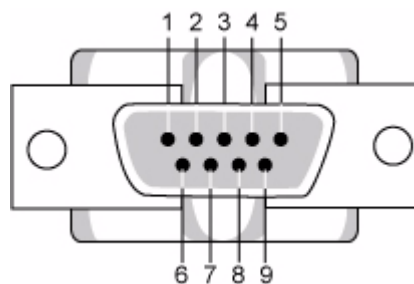

Pin	Signal
1	Data Carrier Detect
2	Received Data
3	Transmitted Data
4	Data Terminal Ready
5	Signal Ground
6	Data Set Ready
7	Request to Send
8	Clear to Send
9	Ring Indicator

- RS232C cable

Connector : 9-pin D-Sub

Cable : Cross (reversed) cable

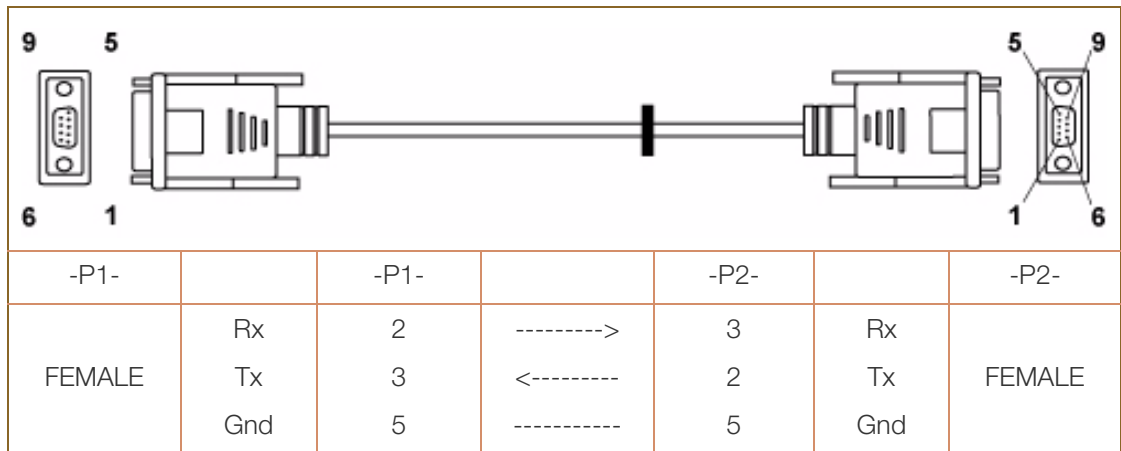

- Connecting method

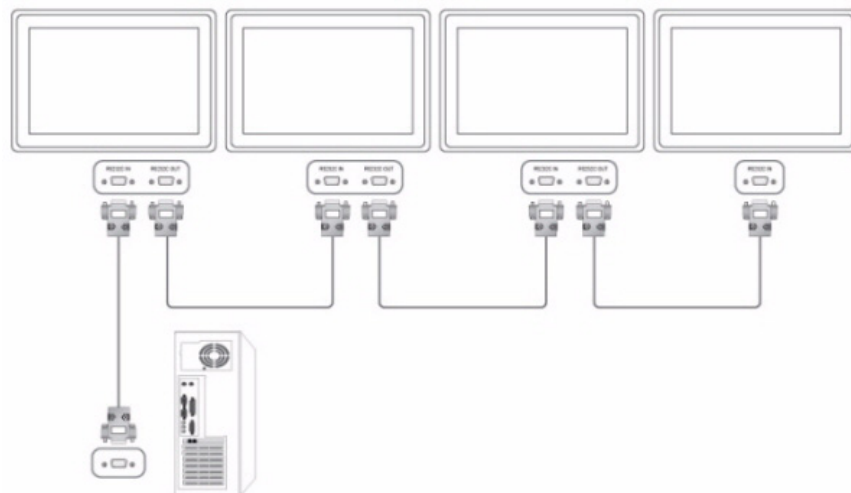

2.2.8 Connecting to a Secondary Monitor

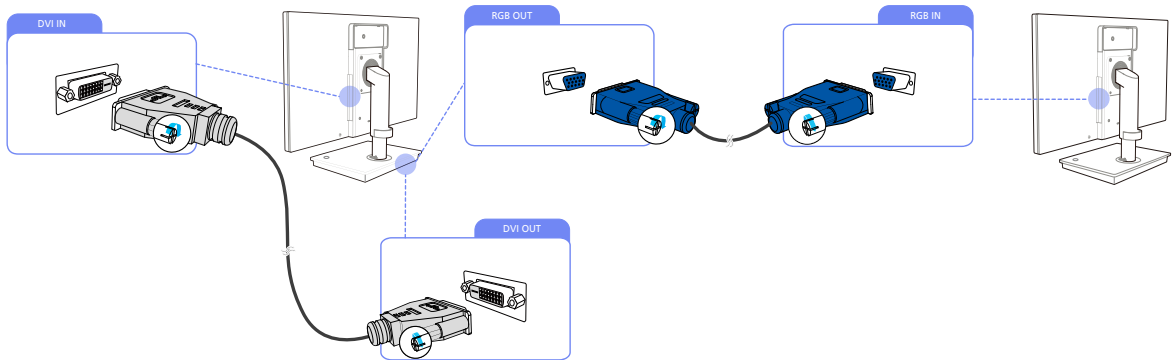

- 1 Connect the DVI cable to [DVI IN] on the back of the product and [DVI OUT] on the stand base.
- 2 Connect the D-SUB cable to [RGB OUT] on the stand base and [RGB IN] on the secondary monitor.
- 3 Connect the DC power adapter to the product and a power outlet. Next, turn on the power switch on the stand base.

(For details, refer to "2.2.9 Connecting the Power".)



- The [DVI OUT] and [RGB OUT] ports can be used when you want to use PCoIP.
- The D-SUB cable can be replaced with the DVI cable and vice versa.

2.2.9 Connecting the Power

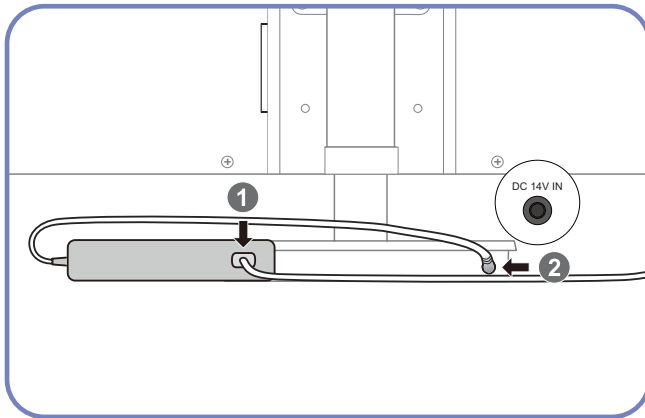

Connect the power cable to the DC power adapter. Next, connect the DC power adapter to [DC 14V IN] on the stand base.

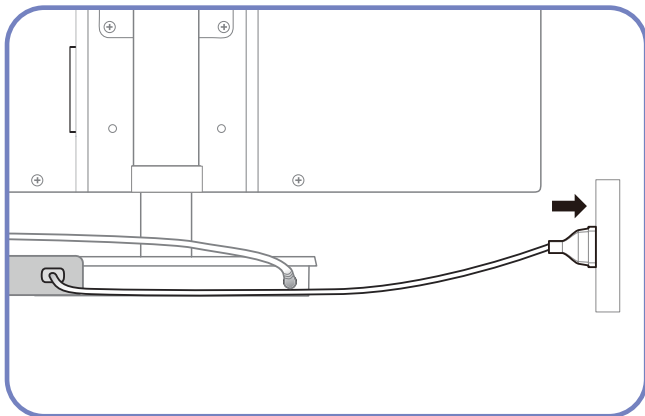

Plug in the power cable to the power socket.



- The color and shape of parts may differ from what is shown. Specifications are subject to change without notice to improve quality.
- The monitor images in this manual are for reference only. Monitor is sold separately.
- For details on how to change the input source for the monitor, refer to the monitor user manual.

2.3 Connect to host PC using LAN cable

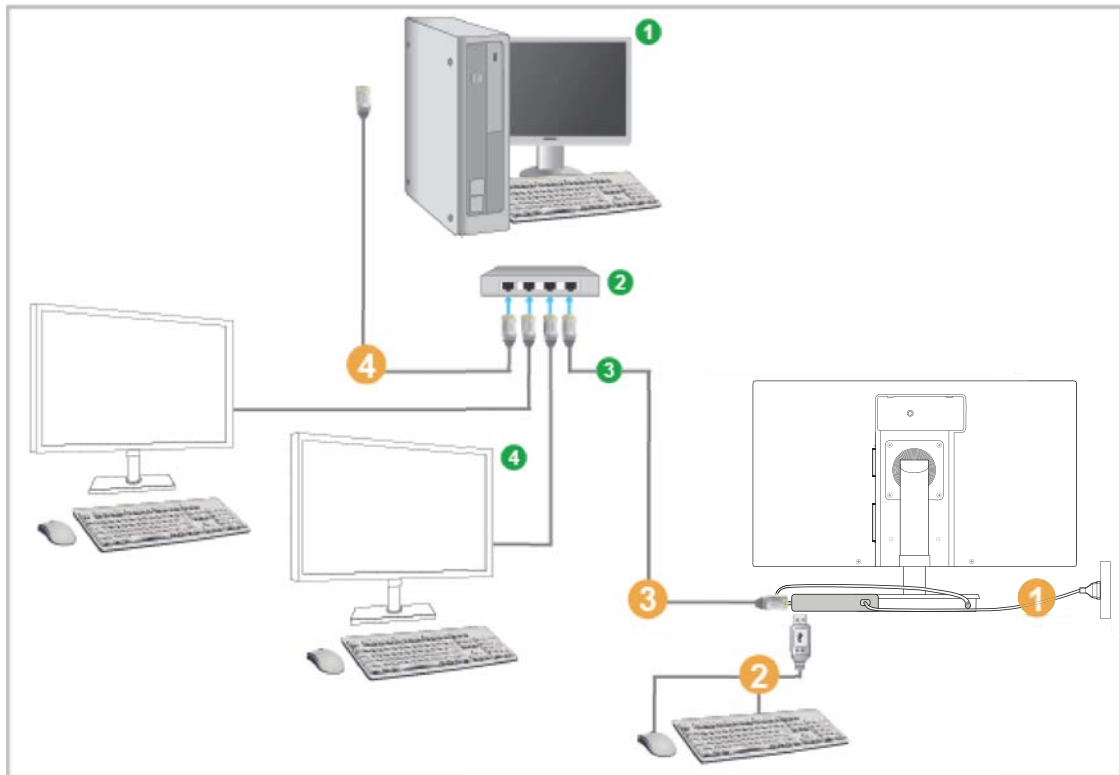

- ① Host PC ② HUB ③ LAN Cable ④ Monitor

- ① Connect the power cable to the monitor and the stand respectively.
- ② Connect the mouse and the keyboard to the USB ports.
- ③ Connect the LAN port on the back of the stand and the hub.
- ④ Connect the hub and the LAN port of the host PC.



The host PC must have an IP address.

After connecting the LAN and setting the IP address, you can view the host PC screen on the monitor.

Use the USB port to connect an external storage device (DSC, MP3, external storage, etc.).

Connecting one Host PC to many client devices is possible only when a virtualization solution such as VMware is installed on the Host PC.

2.4 "PCoIP"

2.4.1 On Screen Display (OSD)

The On Screen Display (OSD) local GUI will appear on the client when the device is powered on and a PCoIP session is not in progress. The OSD lets the user connect to a host device through the **Connect** window.

The **Connect** window allows access to the **Options** page which provides some of the functions provided by the Administrative Web Interface.

To access the **Options** page, click the **Options** menu on the **Connect** window.

2.4.2 Connect Screen

The **Connect** window will appear during startup except when the client is configured for a managed startup or auto-reconnect.

You can change the logo that appears above the **Connect** button by uploading a replacement image through the Administrative Web Interface **Upload** menu.

The **Network** icon at the bottom right of the **Connect** window shows the status of the network connection.

A red X over the network icon means either the network is not properly connected or the connection is still being initialized (i.e., during client boot-up).

Figure 2-1: Network Not Ready (Detail)



Users must wait until the Network Ready icon appears.

Figure 2-2: Network Ready (Detail)



Connect Button

Click the **Connect** button to start a PCoIP session. When the PCoIP connection is pending, the OSD local GUI displays a "Connection Pending" message. When the connection is established, the OSD local GUI will disappear and the session image will appear.

Figure 2-3: OSD Connect Screen (Connecting)



2.4.3 OSD Options Menu

Selecting the **Options** menu will display a list of selections. The OSD **Options** menu contains:

- **Configuration**
This option lets you configure various settings for the device such as network settings, session type, language, and other settings.
- **Diagnostics**
This option helps you troubleshoot the device.
- **Information**
This option lets you view certain details about the device.
- **User Settings**
This option lets the user define certificate checking mode, **Mouse**, **Keyboard**, **Display Topology**, as well as the PCoIP protocol image quality.
- **Password**
This option lets you update the administrative password for the device.



This option is available through the **Management Console** program. Visit www.teradici.com for further details.

Selecting an option will display a settings window.

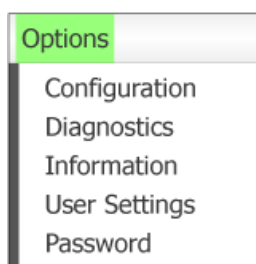
Figure 2-4: OSD **Options** Menu

2.4.4 Configuration Window

The **Configuration** option on the Administrative Web Interface and OSD lets you configure various settings for the device.

The tabs in the **Configuration** window are:

- **Network**
- **Discovery**
- **OSD**
- **IPv6**
- **Session**
- **Display**
- **Label**
- **Language**
- **Reset**

Each tab has the following buttons: **OK**, **Cancel**, and **Apply**. These buttons allow the administrator to accept or cancel the changes made.



The **OSD** configuration options are a subset of the options available in the Administrative Web Interface. To make changes to the configuration settings, you will need an administrator password. You do not need a password to view the **Diagnostic** and **Information** menus. Applicable only when the **Password** item is available.

Network Tab

You can configure the host and client network settings from the **Initial Setup** page or **Network** page. After you update the parameters on this page, click **Apply** to save your changes.



The Network parameters can also be configured using the Administrative Web Interface.

Figure 2-5: **Network** Configuration

- **Enable DHCP**

When **Enable DHCP** is enabled, the device will contact a DHCP server to be assigned an IP address, subnet mask, gateway IP address and DNS servers. When disabled, the device requires these parameters to be set manually.

- **IP Address**

The IP address of the device. If DHCP is disabled, you must set this field to a valid IP address. If DHCP is enabled, you cannot edit this field.

- **Subnet Mask**

The subnet mask of the device. If DHCP is disabled, you must set this field to a valid subnet mask. If DHCP is enabled, you cannot edit this field.



It is possible to configure an illegal IP address/subnet mask combination (e.g., invalid mask) making the device unreachable. Ensure you set the subnet mask properly.

- **Gateway**

The gateway IP address of the device. If DHCP is disabled, this field is required. If DHCP is enabled, you cannot edit this field.

- **Primary DNS Server**

The primary DNS IP address of the device. This field is optional. If the DNS server IP address is configured using the Connection Manager, the address may be set as an FQDN instead of an IP address.

- **Secondary DNS Server**

The secondary DNS IP address of the device. This field is optional. If the DNS server IP address is configured using the Connection Manager, the address may be set as an FQDN instead of an IP address.

- **Domain Name**

The domain name used (e.g., 'domain.local'). This field is optional. This field specifies the host or domain of the client.

- **FQDN**

The Fully Qualified Domain Name for the host or client. The default value is pcoip-host-<MAC> or pcoipportal-<MAC> where <MAC> is the MAC address of the host or client. The domain name is appended if used (e.g., pcoip-host-<MAC>.domain.local). This field is read-only on this page.

- **Ethernet Mode**

Lets you configure the Ethernet mode of the host or client as:

- **Auto**
- **100 Mbps Full-Duplex**
- **10 Mbps Full-Duplex**

When you choose **10 Mbps Full Duplex** or **100 Mbps Full Duplex** and then click **Apply**, a warning message will appear.

"Warning: When Auto-Negotiation is disabled on the PCoIP device, it must also be disabled on the switch. Additionally, the PCoIP device and switch must be configured to use the same speed and duplex parameters. Different parameters may result in a loss of network connectivity. Are you sure you want to continue?"

Click OK to change the parameter.



You should always set the **Ethernet Mode** to **Auto** and only use **10 Mbps Full Duplex** or **100 Mbps Full Duplex** when the other network equipment (i.e., switch) is also configured to operate at **10 Mbps full-duplex** or **100 Mbps full-duplex**. An improperly configured Ethernet Mode may result in the network operating at half-duplex which is not supported by the PCoIP protocol. The session will be severely degraded and eventually dropped.

IPv6 Tab

The **IPv6** page lets you enable IPv6 for PCoIP devices connected to your IPv6 network.



- IPv6 is not currently supported by **VMware View**.
- When you make a change to one of the settings on this page, you must reboot your device for the change to take effect.

Figure 2-6: **IPv6** Configuration

- **Enable IPv6**
Enable this field to enable IPv6 for your PCoIP devices.
- **Link Local Address**
This field is automatically populated.
- **Gateway**
Enter the gateway address.
- **Enable DHCPv6**
Enable this field to set up Dynamic Host Configuration Protocol version 6 (DHCPv6) for your device.
- **Primary DNS**
The primary DNS IP address of the device. If DHCPv6 is enabled, this field is automatically populated by the DHCPv6 server.

- **Secondary DNS**

The secondary DNS IP address of the device. If DHCPv6 is enabled, this field is automatically populated by the DHCPv6 server.

- **Domain Name**

The domain name used (e.g., 'domain.local') for the host or client. If DHCPv6 is enabled, this field is automatically populated by the DHCPv6 server.

- **FQDN**

The fully qualified domain name for the host or client. If DHCPv6 is enabled, this field is automatically populated by the DHCPv6 server.

- **Enable SLAAC**

Enable this field to set up stateless address auto-configuration (SLAAC) for your devices.

- **Enable Manual Address**

Enable this field to set up a manual (static) address for the device.

- **Manual Address**

Enter the IP address for the device.

Label Tab

The **Label** page is available from the host or client. The **Label** page lets you add information for the device.



The Portal Label parameters can also be configured using the Administrative Web Interface.

Figure 2-7: **Label** Configuration

The screenshot shows a 'Configuration' window with a 'Label' tab selected. The window title is 'Configuration' and it has a close button (X). The tabs are: Network, IPv6, Label, Discovery, Session, Language, OSD, Display, Reset. The main content area is titled 'Configure the device identification'. It contains the following fields and text:

- PCoIP Device Name:** A text box containing the value 'pcoip-portal-d0667b8753ba'.
- Note:** When DHCP is enabled the PCoIP Device Name is sent to the DHCP server as the requested hostname.
- PCoIP Device Description:** An empty text box.
- Generic Tag:** An empty text box.

At the bottom of the window, there are three buttons: 'Unlock', 'OK', and 'Cancel'. There is also an 'Apply' button, but it is disabled.

- **PCoIP Device Name**

If the **PCoIP Device Name** allows the administrator to give the Host or Portal a logical name. The default value is pcoip-host-MAC or pcoip-portal-MAC where MAC is the MAC address of the Host or Portal.

- **PCoIP Device Description**

A description and additional information such as the location of the endpoint for the device. The firmware does not use this field. It is provided for administrator use only.

- **Generic Tag**

Generic tag information about the device. The firmware does not use this field. It is provided for administrator use only.

Discovery Tab

Use the settings on the **Discovery Configuration** page to erase the discovery of hosts and clients in your PCoIP system and dramatically reduce the configuration and maintenance effort for complex systems. This discovery mechanism is independent of DNS SRV discovery.



For SLP discovery to work, routers must be configured to forward multicast traffic between subnets. DNS-SRV Discovery is the recommended discovery mechanism because most deployments do not allow this.

Figure 2-8: **Discovery** Configuration

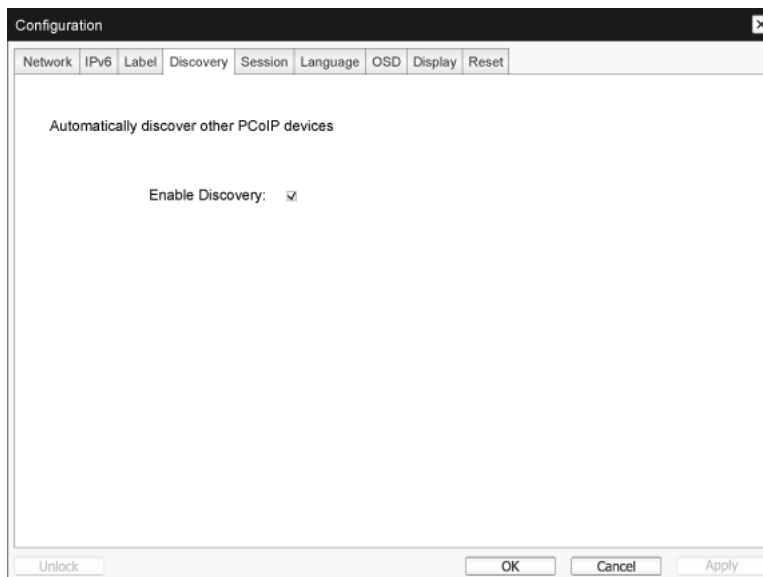

- **Enable Discovery**

If the **Enable Discovery** option is enabled, the device will dynamically discover peer devices using SLP Discovery without requiring prior information on their locations in the network. This can dramatically reduce configuration and maintenance effort for complex systems.



SLP discovery requires routers configured to allow multicast. DNS-SRV Discovery is the recommended method.

Session Tab

The **Session** page lets you configure how the host or client device connects to or accepts connections from peer devices.



The Session parameters can also be configured using the Administrative Web Interface.

Figure 2-9: **Session** Configuration

Configuration

Network IPv6 Label Discovery Session Language OSD Display Reset

Configure the connection to a peer device

Connection Type: Direct to Host

DNS Name or IP Address: 192.168.1.100

Advanced

Unlock OK Cancel Apply

- **Connection Type**

When you select a direct session connection type from the Session page, specific configuration options will appear.

Figure 2-10: **Connection Type** Configuration

Connection Type: Direct to Host

DNS Name or IP Address: Direct to Host

- Direct to Host
- Direct to Host + SLP Host Discovery
- View Connection Server
- View Connection Server + Auto-Logon
- View Connection Server + Kiosk
- View Connection Server + Imprivata OneSign
- Connection Management Interface

- **DNS Name or IP Address**

Enter the IP address or DNS name for the host.



This setting is only available on the client.

- **Advanced**

Refer to the TERADICI Guide at www.teradici.com for further details.

Language Tab

The **Language** page lets you change the user interface language.



- This setting affects the local OSD GUI. It is only available on the client.
- The Language parameters can also be configured using the Administrative Web Interface.

Figure 2-11: **Language** Configuration

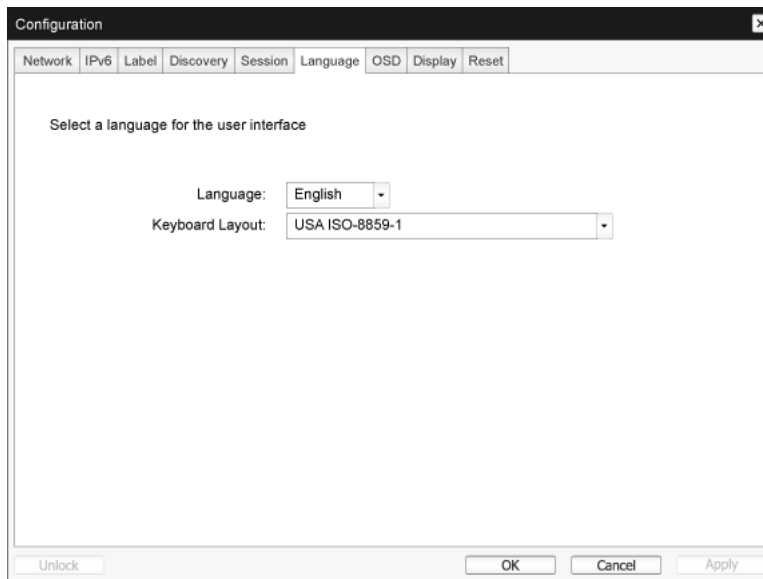

- **Language**
Configure the OSD language. This setting determines the language for OSD only. It does not affect the language setting for the actual user session.
 Supported languages: English, French, German, Greek, Spanish, Italian, Portuguese, Korean, Japanese, Traditional Chinese, Simplified Chinese
- **Keyboard Layout**
Change the layout of the keyboard. When the user starts a session, this setting is controlled through the virtual machine. If the Windows Group Policy Object (GPO) is set to allow the keyboard layout setting, the setting is applied during the session of the user. If the Windows GPO is not set to allow the setting, the setting is not applied.

OSD Tab

The **OSD** page allows the screensaver timeout to be set using the **On Screen Display** parameter.



- The OSD parameters can also be configured using the Administrative Web Interface.
- The **OSD** page is only available on the client. It is unavailable on the host.

Figure 2-12: **OSD** Configuration

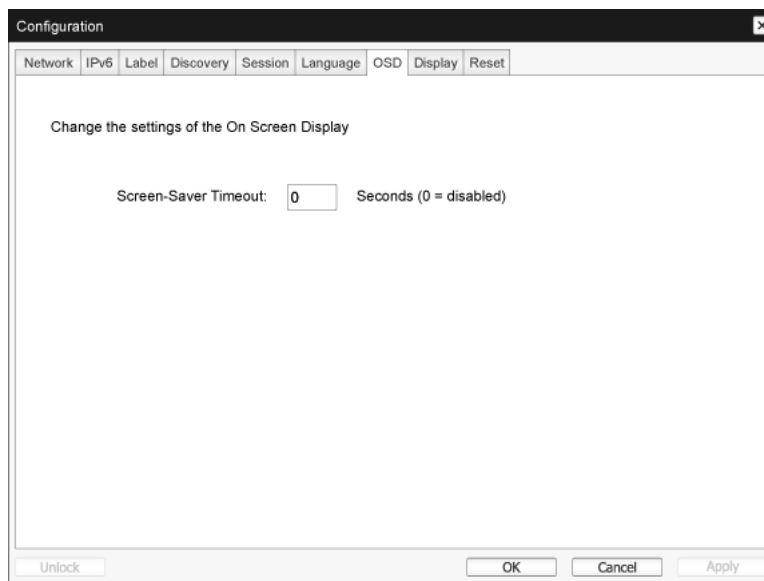

- **Screen-Saver Timeout**

Configure the screensaver timeout before the client sets the attached displays into low-power mode. You can configure the timeout mode in seconds. The maximum timeout value is 9999 seconds. A setting of 0 seconds disables the screensaver.

Display Tab

The **Display** page lets you enable the **Extended Display Identification Data (EDID)** override mode.



This function is only available through the OSD.

Under normal operation, the **GPU** in the host computer queries a monitor attached to the zero client to determine the monitor's capabilities. In some situations, a monitor may be connected to a client in a way that prevents the client from reading the **EDID** information, such as when connecting through certain **KVM** devices. The options in this page configure the client to advertise default **EDID** information to the **GPU**.



Enabling display override forces the default monitor display information to be used which may not be compatible with the connected monitor resulting in a blank monitor. Only enable display override when there is no valid EDID information and monitor display characteristics are known.

Figure 2-13: Display Configuration

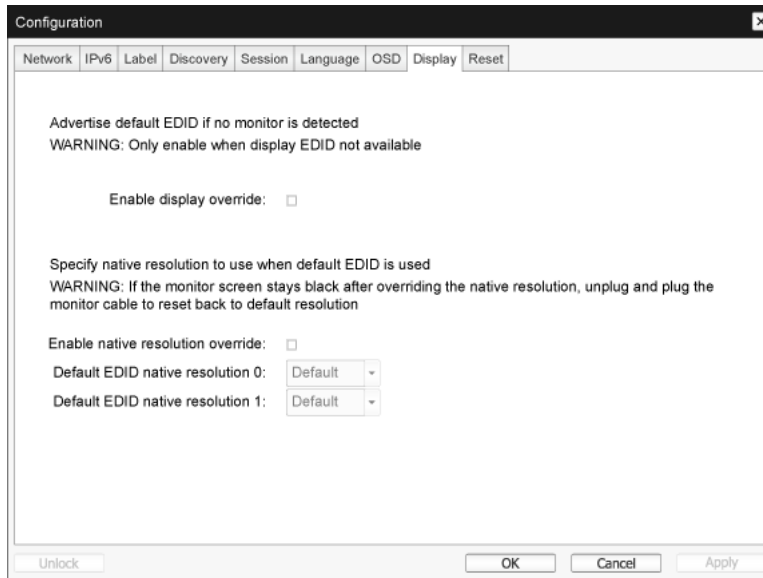

- **Enable display override**

This option is intended for legacy systems. It configures the client to send default **EDID** information to the host when a monitor cannot be detected or is not attached to the client. In versions of Windows prior to Windows 7, once the host had no **EDID** information, it would assume no monitors were attached and would never recheck. This option ensures that the host always has **EDID** information when the client is in session.

The following default resolutions are advertised when this option is enabled:

- 800x600 @60 Hz
- 1024x768 @60 Hz (native resolution advertised)
- 1280x800 @60 Hz
- 1280x960 @60Hz
- 1280x1024 @60 Hz
- 1600x1200 @60 Hz
- 1680x1050 @60 Hz
- 1920x1080 @60 Hz
- 1920x1200 @60 Hz

Reset Tab

The **Reset Parameters** page lets you reset configuration and permissions to factory default values stored in onboard flash memory.



- Reset can also be initiated using the Administrative Web Interface.
- Resetting parameters to factory default values does not revert the firmware or clear the custom OSD logo.

Figure 2-14: **Reset**

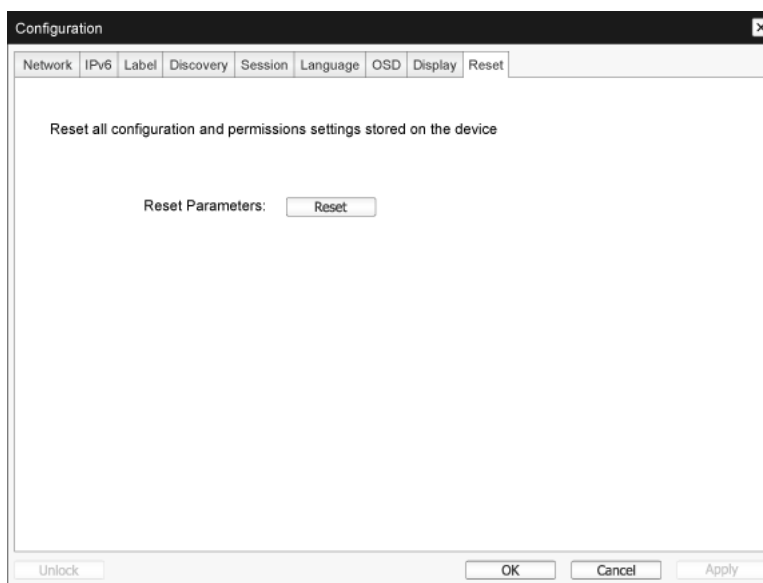

- **Reset Parameters**

When you click this button, a message will appear prompting you for confirmation. This prevents an accidental reset.

2.4.5 Diagnostics Window

The **Diagnostic** menu contains links to pages with run-time information and functions that may be useful for troubleshooting.



The **Diagnostic** options in the OSD are a subset of those available through the Administrative Web Interface.

- **Event Log**
- **Session Statistics**
- **PCoIP Processor**
- **Ping**

Each tab has a **Close** button to close the window.

Event Log Tab

The **Event Log** page lets you view and clear event log messages from the host or client.

The Administrative Web Interface allows you to change the log filter setting on the device which controls the level of detail of the messages in the log. When you set the filter to "terse," the device will log short and concise messages.

The **Event Log** page allows you to enable and define syslog to collect and report events that meet the IETF standard for logging program messages.



The **Event Log** can also be initiated using the administrative web interface.

Figure 2-15: **Event Log**

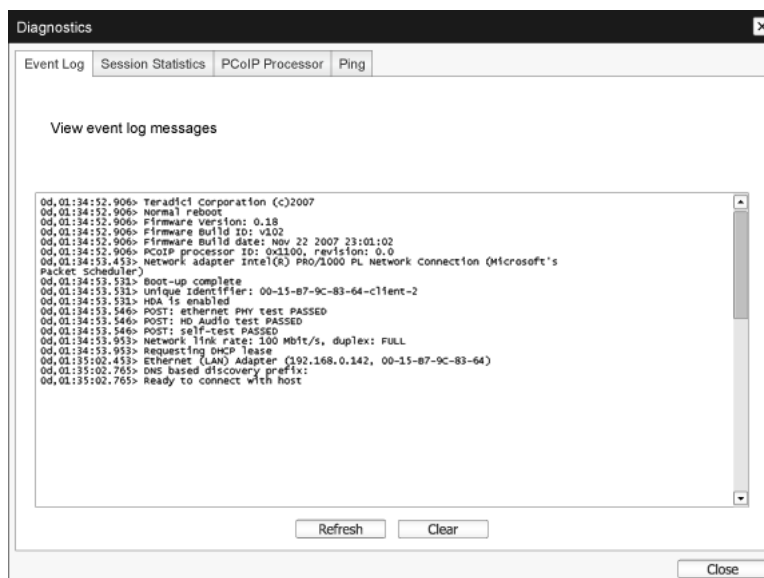

- **View event log message**

The **View event log messages** field displays log messages with time stamp information. There are two buttons available.

- **Refresh**

Selecting the **Refresh** button refreshes the event log messages displayed.

- **Clear**

Click to delete all event log messages stored on the device.

Session Statistics Tab

The **Session Statistics** page lets you view current statistics when a session is active. If a session is not active, you can view the statistics from the last session.



Session Statistics can also be viewed using the administrative web interface.

Figure 2-16: **Session Statistics**

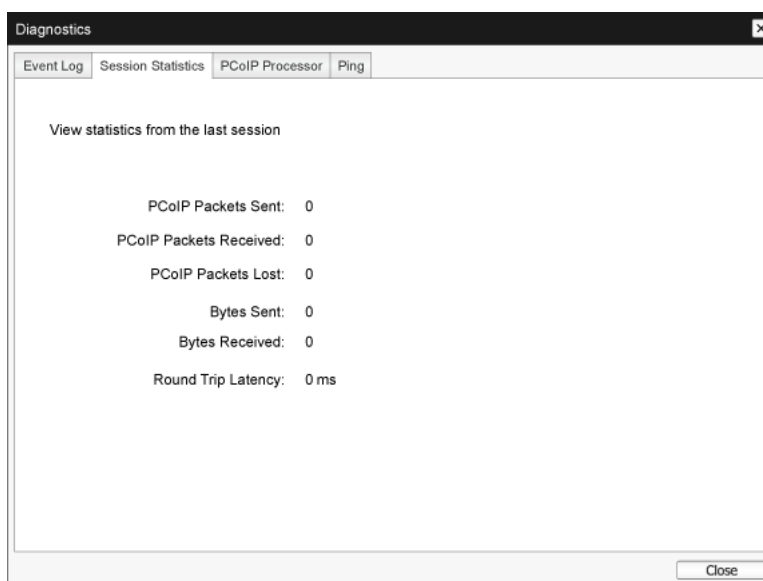

- **PCoIP Packets Statistics**
 - **PCoIP Packets Sent**
The total number of PCoIP packets sent in the current/last session.
 - **PCoIP Packets Received**
The total number of PCoIP packets received in the current/last session.
 - **PCoIP Packets Lost**
The total number of PCoIP packets lost in the current/last session.
- **Bytes Statistics**
 - **Bytes Sent**
The total number of bytes sent in the current/last session.
 - **Bytes Received**
The total number of bytes received in the current/last session.
- **Round Trip Latency**
The minimum, average, and maximum roundtrip PCoIP system (e.g., host to client and then back to host) and network latency in milliseconds (+/- 1 ms).

PCoIP Processor Tab

The **PCoIP Processor** page lets you reset the host or client and view the uptime of the client PCoIP processor since the last boot.



The **PCoIP Processor** Uptime can also be viewed in the administrative web interface.

Figure 2-17: **PCoIP Processor**

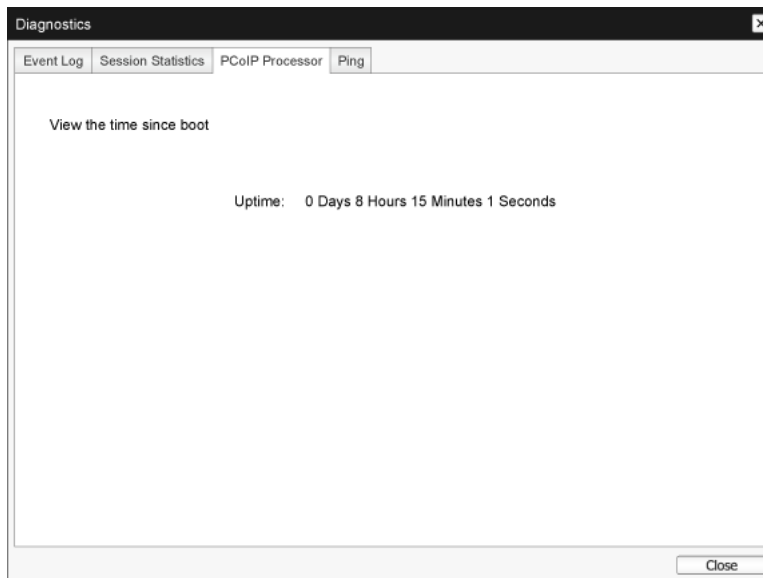

Ping Tab

The **Ping** page allows you to ping a device to see if it is reachable across the IP network. This may help you determine if a host is reachable. As a result of firmware releases 3.2.0 and later forcing the “do not fragment” flag in the ping command, you can use this feature to determine the maximum MTU size.

Figure 2-18: **Ping**

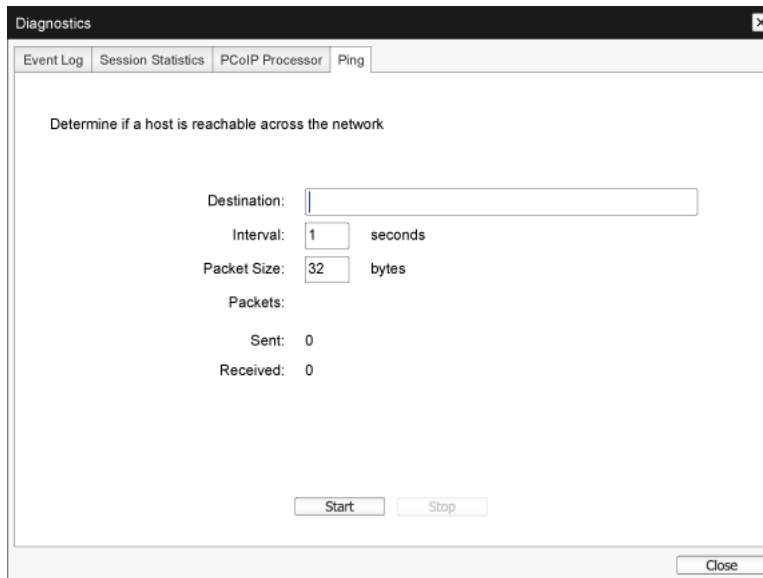

- Ping Settings
 - **Destination**
IP Address or FQDN to ping
 - **Interval**
Interval between ping packets
 - **Packet Size**
Size of the ping packet
- **Packets**
 - **Sent**
Number of ping packets transmitted
 - **Received**
Number of ping packets received

2.4.6 Information Window

The **Information** page lets you see details about the device. The Administrative Web Interface shows version, VPD, and attached device information. The OSD lets you view the device version information.



The **Version** page lets you view the hardware and firmware version details for a device.

Figure 2-19: **Version**

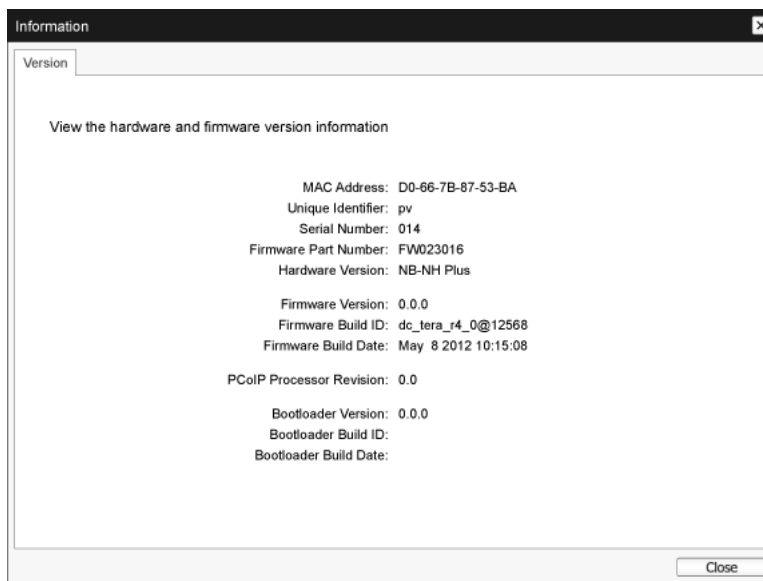

- VPD Information

Vital Product Data (VPD) is information set by the factory to uniquely identify each Portal or Host.

 - **MAC Address**
Host/client unique MAC address
 - **Unique Identifier**
Host/client unique identifier
 - **Serial Number**
Host/client unique serial number
 - **Firmware Part Number**
Part number of the current firmware
 - **Hardware Version**
Host/client hardware version number
- Firmware Information

The **Firmware Information** reflects the current PCoIP firmware details.

 - **Firmware Version**
Version of the current firmware
 - **Firmware Build ID**
Revision code of the current firmware

- **Firmware Build Date**
Build date for the current firmware
- **PCoIP Processor Revision**
The silicon revision of the PCoIP processor. Revision B of the silicon is denoted by a 1.0.
- **Bootloader Information**
The Bootloader information reflects the current PCoIP bootloader details.
 - **Bootloader Version**
Version of the current bootloader
 - **Bootloader Build ID**
Revision code of the current bootloader
 - **Bootloader Build Date**
Build date of the current bootloader

2.4.7 User Settings Window

The **User Settings** page allows you to access tabs to define the Certificate Checking Mode, the mouse and keyboard settings, PCoIP protocol image quality, and display topology.

The tabs in the **User Settings** menu are:

- **VMware View**
- **Mouse**
- **Keyboard**
- **Image**
- **Display Topology**
- **Touch Screen**

VMware View Tab

The **VMware View** page allows configuration for use with a VMware View Connection Server.



- If **VCS Certificate Check Mode Lockout** is enabled from the Administrative Web Interface, users will not be able to modify the settings on this page.
- The VMware View parameters can also be configured using the administrative web interface.

Figure 2-20: **VMware View** Configuration



- **Reject the unverifiable connection**
Configure the client to reject the connection if a trusted and valid certificate is not installed.
- **Warn if the connection may be insecure**
Configure the client to display a warning if an unsigned or expired certificate is encountered. You can also configure the client to display a warning message if the certificate is not self-signed and the zero client trust store is empty.

- **Allow the unverifiable connection**

Configure the client to allow all connections.

Mouse Tab

The **Mouse** page lets you change the mouse cursor speed settings for the OSD sessions.



The OSD mouse cursor speed setting does not affect the mouse cursor settings when a PCoIP session is active unless the **Local Keyboard Host Driver** function is being used. Refer to the "PCoIP Host Software for Windows User Guide (TER0810001)" for more details. This function is only available through the OSD. It is not available in the Administrative Web Interface.

Figure 2-21: **Mouse**

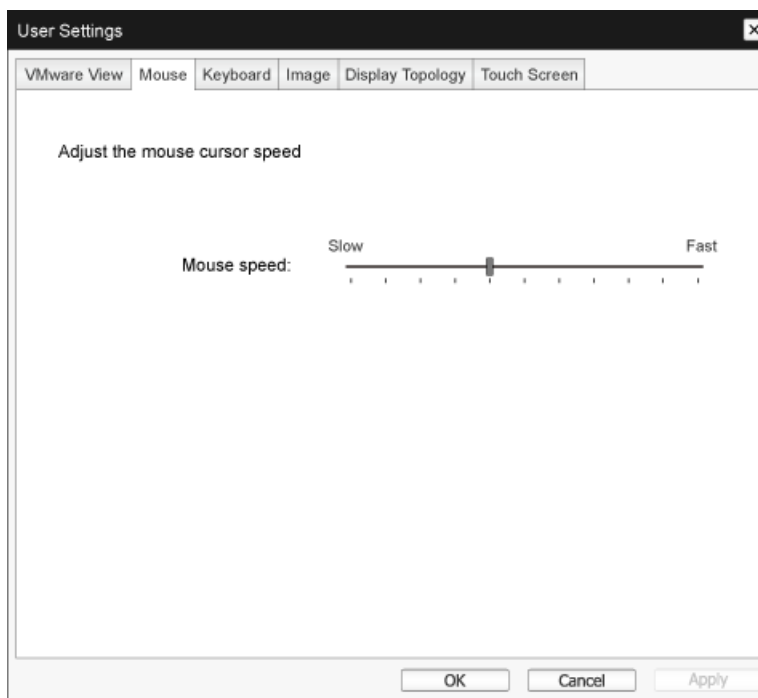

- **Mouse Speed**

Configure the speed of the mouse cursor.



You can also configure the mouse speed through the PCoIP host software. Refer to the "PCoIP Host Software for Windows User Guide (TER0810001)" for more details.

Keyboard Tab

The **Keyboard** page lets you change the keyboard repeat settings for the OSD session.



- The keyboard settings do not affect the keyboard settings when a PCoIP session is active unless the **Local Keyboard Host Driver** function is used. Refer to the "PCoIP Host Software for Windows User Guide (TER0810001)" for more details. This setting is only available through the OSD. It does not appear on the Administration Web Interface.
- You can also configure the keyboard repeat settings through the PCoIP host software. Refer to the "PCoIP Host Software for Windows User Guide (TER0810001)" for more details.

Figure 2-22: **Keyboard**

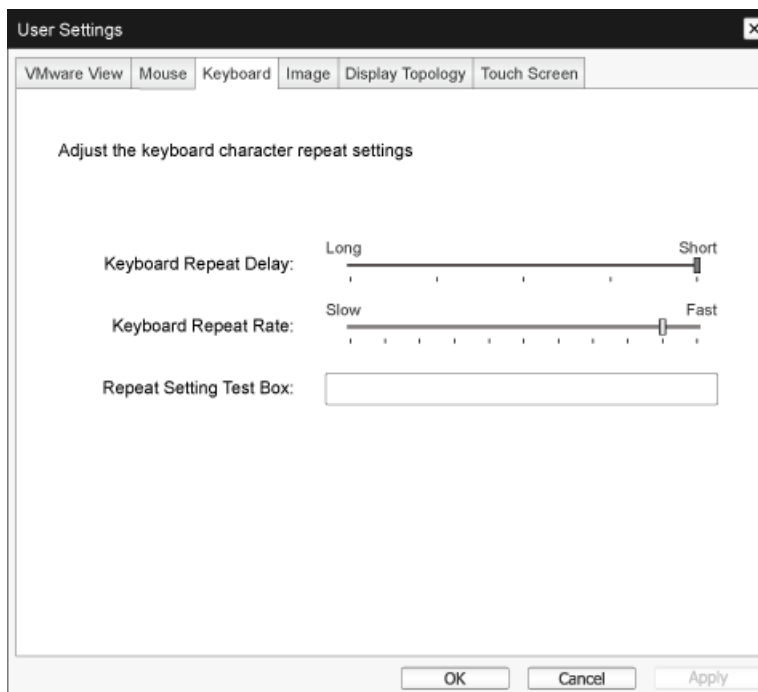

- **Keyboard Repeat Delay**
Lets users configure the client keyboard repeat delay.
- **Keyboard Repeat Rate**
Lets users configure the client keyboard repeat rate.
- **Repeat Settings Test Box**
Lets users test the chosen keyboard settings.

Image

The **Image** page allows you to make changes to the image quality of the PCoIP session. This applies to sessions between PCoIP zero clients and PCoIP host cards in a remote workstation.

To configure the image quality settings for a **VMware View** virtual desktop, adjust the PCoIP session variables. Refer to "VMware View 4 to PCoIP Client WAN Network Guidelines" for more information.



The Image parameters can also be configured using the Administrative Web Interface.

Figure 2-23: **Image**

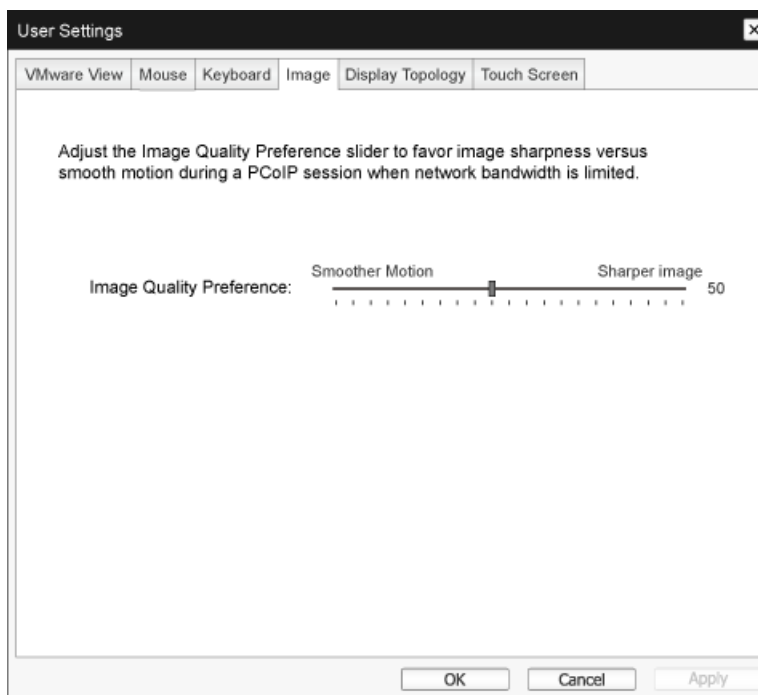

- **Image Quality Preference**

Use the slider to adjust the balance between image sharpness and smooth motion during a PCoIP session when network bandwidth is limited.



This field is also accessible on the host if the PCoIP Host Software is installed. The slider can be found under the **Image** tab of the host software. This setting does not work in PCoIP sessions with **VMware View** virtual desktops running release 5.0 or earlier.

Display Topology

The **Display Topology** page allows users to change the position, rotation, and resolution of a display for a PCoIP session. To apply the **Display Topology** feature to a PCoIP session between a zero client and a Virtual Machine (VM), **VMware View** 4.5 or later is required.

To apply the **Display Topology** feature to a PCoIP session between a zero client and a PCoIP host, you must have the PCoIP host software installed on the host. See the "PCoIP Host Software for Windows User Guide (TER0810001)" for details.



The **Display Topology** tab has no corresponding menu in the Administration Web Interface.

For details about the **Display Topology** feature for a PCoIP session between a host card and a zero client, refer to the "PCoIP Host Software for Windows User Guide (TER0810001)".

Always change the **Display Topology** settings using the **Display Topology** tab on the zero client OSD->Options->User Settings interface. Do not try to change these settings using the Windows Display Settings in a virtual machine when using **VMware View**.

Figure 2-24: **Display Topology**

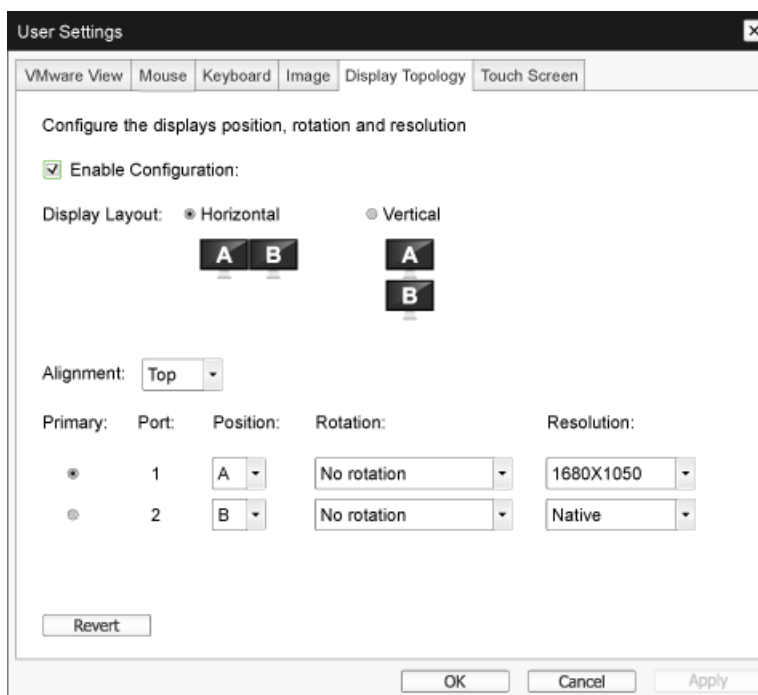

- **Enable Configuration**

The device can be configured with display position, rotation and resolution settings if enabled. The settings are saved when you click **Apply** or **OK** and are applied when the device is reset.

- **Display Layout**

Select whether you want a horizontal or vertical layout for your displays (A and B). This setting should reflect the physical layout of the displays on your desk.

- **Horizontal:** Select to arrange A and B horizontally, with A located to the left of B.
- **Vertical:** Select to arrange A and B vertically, with A located above B.



A maximum of two displays can be enabled at the same time.

- **Alignment**

Select how you want displays A and B aligned when they are different sizes.



This setting affects which area of the screen to use when you move the cursor from one display to the other. The alignment options that appear in the drop-down list depend on whether you have selected a horizontal or vertical display layout.

- **Primary**

Configure which DVI port on the zero client that you want as the primary port.



The display that is connected to the primary port becomes the primary display (i.e., the display that contains the OSD menus before you initiate a PCoIP session and the display that is requested for the Windows taskbar after you initiate the session).

- **Port 1:** Select to configure DVI-1 port on the zero client as the primary port.
- **Port 2:** Select to configure DVI-2 port on the zero client as the primary port.

- **Position**

Specify which display is physically connected to **Port 1** and **Port 2**.

- **Rotation**

Configure the rotation of the display in **Port 1** and **Port 2**:

- No rotation
- 90° clockwise
- 180° rotation
- 90° counter-clockwise

- **Resolution**

The display resolution can be configured for a PCoIP session between a virtual machine or host and a zero client. The zero client detects the supported display resolutions of the monitor and populates them to the drop-down menu. By default, the native resolution of the display is used.

- **Revert**

Resets the configurations on this page to their last saved settings.

Touch Screen

The **Touch Screen** page allows you to configure and calibrate certain settings of an attached **Elo TouchSystems** touch screen display.



The **Touch Screen** page is only available through the OSD. It is not available from the Administrative Web Interface.

Figure 2-25: **Touch Screen**

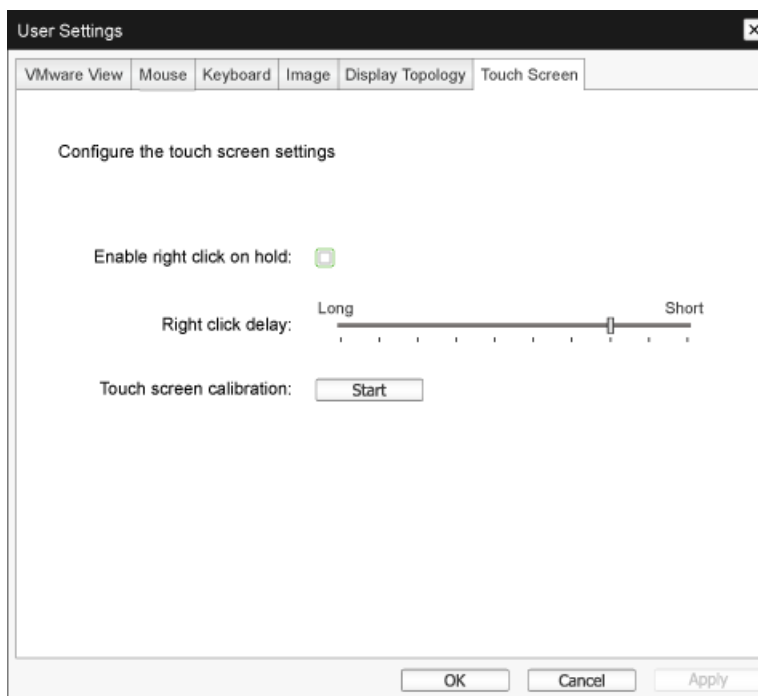

- Enable right click on hold**
 Select this checkbox to allow users to emulate a right-click when they touch the screen and hold it for a few seconds. If disabled, right-click is not supported.
- Right click delay**
 Slide the pointer to a position between Long and Short to determine how long a user must touch and hold the screen to emulate a right-click.
- Touch screen calibration**
 When you first connect the touch screen to the zero client, the calibration program will start. On the touch screen, touch each of the three targets as they appear.
 To test the calibration, run your finger along the monitor and ensure that the cursor follows it. If it is not successful, the calibration program automatically restarts. Once calibrated, the coordinates are stored in flash.
 To manually start the calibration program, from the OSD **Touch Screen** page, click **Start**. Follow the onscreen prompts.

2.4.8 Password Window



This option is available through the **Management Console** program.

The **Password** page lets you update the local administrative password for the device. The password can be a maximum of 20 characters. Some PCoIP devices have password protection disabled by default.

The **Password** page is not available on these devices. You can enable password protection through the PCoIP Management Console for these devices.



- This parameter affects the Administrative Web Interface and the local **OSD** GUI.
- Take care when updating the client password as the client may become unusable if the password is lost.

Figure 2-26: **Change Password**

- **Old Password**
This field must match the current administrative password before you can update the password.
- **New Password**
The new administrative password for both the administrative web interface and the local OSD GUI.
- **Confirm New Password**
This field must match the **New Password** field for the password to be updated.
- **Reset**
If the client password is lost, you can click the **Reset** button to request a response code from the client vendor. The challenge code is sent to the vendor. The vendor qualifies the request and returns a response code if authorized by Teradici.

When the response code is correctly entered, the password of the client is set to an empty value. You must enter a new password.



Contact the client vendor for more information when an authorized password reset is required. This option is not available through the Administrative Web Interface. It is only available through the OSD.

Figure 2-27: Authorized Password Reset



Authorized Password Reset

Contact your hardware vendor to reset a lost password.

Challenge: KPPC G5K6 LURP GURP FA5M B4KK

Response: [] [] [] [] [] []

OK Cancel



Details on how to use PCoIP are subject to change without notice. To view the latest information, visit the Teradici website at <http://www.teradici.com>.

3.1 Requirements Before Contacting Samsung Customer Service Center

3.1.1 Check the following.

Sound issue	
There is no sound.	Check the connection of the audio cable or adjust the volume.
	Check the volume.
The volume is too low.	Adjust the volume.
	If the volume is still low after turning it up to the maximum level, adjust the volume in the audio settings program.

4.1 General

Model Name		NB-NH
Power Supply		This product uses 100 to 240V. Refer to the label at the back of the product as the standard voltage can vary in different countries.
Video Signal		RGB OUT, DVI OUT
Server connector		LAN
Speaker		1 W x 2 (stereo)
Dimensions (W x H x D) / Weight		9.6 X 13.4 X 8.9 inches / 244.0 X 340.0 X 227.0 mm / 2.3 kg / 5.1 lb
Tilt Degree		-3°(±2°) ~ 25°(±2°)
USB		USB 2.0 X 4(Down stream)
Environmental considerations	Operating	Temperature : 50 °F ~ 122 °F (10 °C ~ 50 °C) Humidity : 10 % ~ 90 %, non-condensing
	Storage	Temperature : -4°F ~ 113°F (-20 °C ~ 45 °C) Humidity : 5 % ~ 90 %, non-condensing
VESA (W x H)		100 mm X 100 mm, 75 mm X 75 mm



The above specifications are subject to change without notice to improve quality.



This device is a Class B digital apparatus.

(USA only)

Dispose unwanted electronics through an approved recycler.

To find the nearest recycling location, go to our website:

www.samsung.com/recyclingdirect or call, (877) 278 - 0799

CALIFORNIA USA ONLY (Applicable for networking models only.)

This Perchlorate warning applies only to primary CR(Manganese Dioxide) Lithium coin cells in the product sold or distributed ONLY in California USA

"Perchlorate Material - special handling may apply, See www.dtsc.ca.gov/hazardouswaste/perchlorate."

4.2 Power consumption

PowerSaver	Normal operation mode		Stand by (S3)	Power off (S5) (Power button off)	Power off (Power switch off)
	Typical	Rating			
Power lamp	On		Off	Off	Off
Power Consumption	7.3 W	19.4 W	Less than 1.0 W	Less than 0.8 W	0 W



- The power consumption level can vary in different operating conditions or when settings are changed.
- To reduce the power consumption to 0 watts, turn off the switch on the adapter or disconnect the power cable. Be sure to disconnect the power cable when you will not be using the product for an extended period of time. To reduce the power consumption to 0 watts when the power switch is not available, disconnect the power cable.

Contact SAMSUNG WORLD WIDE



If you have any questions or comments relating to Samsung products, please contact the SAMSUNG customer care center.

NORTH AMERICA		
U.S.A	1-800-SAMSUNG (726-7864)	http://www.samsung.com
CANADA	1-800-SAMSUNG (726-7864)	http://www.samsung.com/ca (English) http://www.samsung.com/ca_fr (French)
MEXICO	01-800-SAMSUNG (726-7864)	http://www.samsung.com

LATIN AMERICA		
ARGENTINE	0800-333-3733	http://www.samsung.com
BOLIVIA	800-10-7260	http://www.samsung.com
BRAZIL	0800-124-421 4004-0000	http://www.samsung.com
CHILE	800-SAMSUNG (726-7864) From mobile 02-482 82 00	http://www.samsung.com
COLOMBIA	01-8000112112	http://www.samsung.com
COSTA RICA	0-800-507-7267	http://www.samsung.com/latin (Spanish) http://www.samsung.com/latin_en (English)
DOMINICA	1-800-751-2676	http://www.samsung.com/latin (Spanish) http://www.samsung.com/latin_en (English)
ECUADOR	1-800-10-7267	http://www.samsung.com/latin (Spanish) http://www.samsung.com/latin_en (English)
EL SALVADOR	800-6225	http://www.samsung.com/latin (Spanish) http://www.samsung.com/latin_en (English)

Appendix

LATIN AMERICA		
GUATEMALA	1-800-299-0013	http://www.samsung.com/latin (Spanish) http://www.samsung.com/latin_en (English)
HONDURAS	800-27919267	http://www.samsung.com/latin (Spanish) http://www.samsung.com/latin_en (English)
JAMAICA	1-800-234-7267	http://www.samsung.com
NICARAGUA	00-1800-5077267	http://www.samsung.com/latin (Spanish) http://www.samsung.com/latin_en (English)
PANAMA	800-7267	http://www.samsung.com/latin (Spanish) http://www.samsung.com/latin_en (English)
PERU	0-800-777-08	http://www.samsung.com
PUERTO RICO	1-800-682-3180	http://www.samsung.com
TRINIDAD & TOBAGO	1-800-SAMSUNG (726-7864)	http://www.samsung.com
VENEZUELA	0-800-100-5303	http://www.samsung.com

EUROPE		
AUSTRIA	0810 - SAMSUNG (7267864, € 0.07/min)	http://www.samsung.com
BELGIUM	02-201-24-18	http://www.samsung.com/be (Dutch) http://www.samsung.com/be_fr (French)
BOSNIA	05 133 1999	http://www.samsung.com
BULGARIA	07001 33 11 , normal tariff	http://www.samsung.com
CROATIA	062 SAMSUNG (062 726 7864)	http://www.samsung.com
CYPRUS	8009 4000 only from landline (+30) 210 6897691 from mobile and land line	http://www.samsung.com

Appendix

EUROPE		
CZECH	800 - SAMSUNG (800-726786)	http://www.samsung.com
	Samsung Electronics Czech and Slovak, s.r.o., Oasis Florenc, Sokolovská 394/17, 180 00, Praha 8	
DENMARK	70 70 19 70	http://www.samsung.com
EIRE	0818 717100	http://www.samsung.com
ESTONIA	800-7267	http://www.samsung.com
FINLAND	09 85635050	http://www.samsung.com
FRANCE	01 48 63 00 00	http://www.samsung.com
GERMANY	0180 5 SAMSUNG bzw. 0180 5 7267864* (*0,14 €/Min. aus dem dt. Festnetz, aus dem Mobilfunk max. 0,42 €/Min.)	http://www.samsung.com
GREECE	80111-SAMSUNG (80111 726 7864) only from land line (+30) 210 6897691 from mobile and land line	http://www.samsung.com
HUNGARY	06-80-SAMSUNG (726-7864)	http://www.samsung.com
ITALIA	800-SAMSUNG (726-7864)	http://www.samsung.com
LATVIA	8000-7267	http://www.samsung.com
LITHUANIA	8-800-77777	http://www.samsung.com
LUXEMBURG	261 03 710	http://www.samsung.com
MACEDONIA	023 207 777	http://www.samsung.com
MONTENEGRO	020 405 888	http://www.samsung.com
NETHERLANDS	0900 - SAMSUNG (0900-7267864) (€ 0,10/Min)	http://www.samsung.com
NORWAY	815 56480	http://www.samsung.com
POLAND	0 801-1SAMSUNG (172-678) +48 22 607-93-33	http://www.samsung.com
PORTUGAL	808 20 - SAMSUNG (808 20 7267)	http://www.samsung.com
RUMANIA	08008 SAMSUNG (08008 726 7864) TOLL FREE No.	http://www.samsung.com
SERBIA	0700 Samsung (0700 726 7864)	http://www.samsung.com
SLOVAKIA	0800 - SAMSUNG (0800-726 786)	http://www.samsung.com
SPAIN	902 - 1 - SAMSUNG (902 172 678)	http://www.samsung.com

Appendix

EUROPE		
SWEDEN	0771 726 7864 (SAMSUNG)	http://www.samsung.com
SWITZERLAND	0848-SAMSUNG (7267864, CHF 0.08/min)	http://www.samsung.com/ch (German) http://www.samsung.com/ch_fr (French)
U.K	0330 SAMSUNG (7267864)	http://www.samsung.com

CIS		
ARMENIA	0-800-05-555	http://www.samsung.com
AZERBAIJAN	088-55-55-555	http://www.samsung.com
BELARUS	810-800-500-55-500	http://www.samsung.com
GEORGIA	0-800-555-555	http://www.samsung.com
KAZAKHSTAN	8-10-800-500-55-500 (GSM: 7799)	http://www.samsung.com
KYRGYZSTAN	00-800-500-55-500	http://www.samsung.com
MOLDOVA	0-800-614-40	http://www.samsung.com
MONGOLIA	+7-800-555-55-55	http://www.samsung.com
RUSSIA	8-800-555-55-55	http://www.samsung.com
TADJIKISTAN	8-10-800-500-55-500	http://www.samsung.com
UKRAINE	0-800-502-000	http://www.samsung.com/ua (Ukrainian) http://www.samsung.com/ua_ru (Russian)
UZBEKISTAN	8-10-800-500-55-500	http://www.samsung.com

ASIA PACIFIC		
AUSTRALIA	1300 362 603	http://www.samsung.com
CHINA	400-810-5858	http://www.samsung.com
HONG KONG	(852) 3698 - 4698	http://www.samsung.com/hk (Chinese) http://www.samsung.com/hk_en (English)

Appendix

ASIA PACIFIC		
INDIA	1800 1100 11 3030 8282 1800 3000 8282 1800 266 8282	http://www.samsung.com
INDONESIA	0800-112-8888 021-5699-7777	http://www.samsung.com
JAPAN	0120-327-527	http://www.samsung.com
MALAYSIA	1800-88-9999	http://www.samsung.com
NEW ZEALAND	0800 SAMSUNG (0800 726 786)	http://www.samsung.com
PHILIPPINES	1-800-10-SAMSUNG (726-7864) for PLDT 1-800-3-SAMSUNG (726-7864) for Digitel 1-800-8-SAMSUNG (726-7864) for Globe 02-5805777	http://www.samsung.com
SINGAPORE	1800-SAMSUNG (726-7864)	http://www.samsung.com
TAIWAN	0800-329-999 0266-026-066	http://www.samsung.com
THAILAND	1800-29-3232 02-689-3232	http://www.samsung.com
VIETNAM	1 800 588 889	http://www.samsung.com

MIDDIE EAST		
BAHRAIN	8000-4726	http://www.samsung.com/ae (English) http://www.samsung.com/ae_ar (Arabic)
EGYPT	08000-726786	http://www.samsung.com
IRAN	021-8255	http://www.samsung.com
JORDAN	800-22273 065777444	http://www.samsung.com
KUWAIT	183-2255	http://www.samsung.com/ae (English) http://www.samsung.com/ae_ar (Arabic)

Appendix

MIDDLE EAST		
MOROCCO	080 100 2255	http://www.samsung.com
OMAN	800-SAMSUNG (726-7864)	http://www.samsung.com/ae (English) http://www.samsung.com/ae_ar (Arabic)
SAUDI ARABIA	9200-21230	http://www.samsung.com/ae (English) http://www.samsung.com/ae_ar (Arabic)
TURKEY	444 77 11	http://www.samsung.com
U.A.E	800-SAMSUNG (726-7864)	http://www.samsung.com

AFRICA		
ANGOLA	91-726-7864	http://www.samsung.com
BOTSWANA	0800-726-000	http://www.samsung.com
CAMEROON	7095- 0077	http://www.samsung.com
COTE D' IVOIRE	8000 0077	http://www.samsung.com
GHANA	0800-10077 0302-200077	http://www.samsung.com
KENYA	0800 724 000	http://www.samsung.com
NAMIBIA	8197267864	http://www.samsung.com
NIGERIA	0800-726-7864	http://www.samsung.com
SENEGAL	800-00-0077	http://www.samsung.com
SOUTH AFRICA	0860-SAMSUNG (726-7864)	http://www.samsung.com
TANZANIA	0685 88 99 00	http://www.samsung.com
UGANDA	0800 300 300	http://www.samsung.com
ZAMBIA	211350370	http://www.samsung.com

Responsibility for the Pay Service (Cost to Customers)



When the service is requested, in spite of in warranty, we may charge you for a visit from a service technician in the following cases.

Not a product defect

Cleaning of the product, Adjustment, Explanation, Re-installation and etc.

- If a service technician gives instructions on how to use product or simply adjusts options without disassembling product.
- If a defect is caused by external environmental factors (Internet, Antenna, Wired Signal, etc.)
- If a product is reinstalled or devices are connected additionally after installing the purchased product for the first time.
- If a product is reinstalled to move to a different spot or to move to a different house.
- If customer requests instructions on how to use because of another company's product.
- If customer requests instructions on how to use the network or another company's program.
- If customer requests software installation and setup for the product.
- If a service technician removes/cleans dusts or foreign materials inside of the product.
- If customer requests an installation additionally after purchasing a product through home-shopping or online.

A Product damage caused by customer's fault

Product damage caused by customer's mishandling or wrong repair

If a product damage is caused by;

- External impact or drop.
- Use of supplies or separately sold product unspecified by Samsung.
- Repair from a person besides an engineer of outsourcing service company or partner of Samsung Electronics Co., Ltd.
- Remodeling or repairing the product by customer.
- Using it with incorrect voltage or non-authorized electrical connections.
- Not following the "cautions" in User Manual.

Others

- If product fails by natural disaster. (lightning, fire, earthquake, flood damage, etc)
- If consumable components are all used up. (Battery, Toner, Fluorescent lights, Head, Vibrator, Lamp, Filter, Ribbon, etc.)



If customer requests a service in case the product has no defect, service fee may be charged. So please read User Manual first.

Correct Disposal

Correct Disposal of This Product (Waste Electrical & Electronic Equipment)



(Applicable in countries with separate collection systems)

This marking on the product, accessories or literature indicates that the product and its electronic accessories (e.g. charger, headset, USB cable) should not be disposed of with other household waste at the end of their working life. To prevent possible harm to the environment or human health from uncontrolled waste disposal, please separate these items from other types of waste and recycle them responsibly to promote the sustainable reuse of material resources.

Household users should contact either the retailer where they purchased this product, or their local government office, for details of where and how they can take these items for environmentally safe recycling.

Business users should contact their supplier and check the terms and conditions of the purchase contract. This product and its electronic accessories should not be mixed with other commercial wastes for disposal.

Correct disposal of batteries in this product



(Applicable in countries with separate collection systems)

The marking on the battery, manual or packaging indicates that the battery in this product should not be disposed of with other household waste. Where marked, the chemical symbols Hg, Cd or Pb indicate that the battery contains mercury, cadmium or lead above the reference levels in EC Directive 2006/66.

The battery incorporated in this product is not user replaceable. For information on its replacement, please contact your service provider. Do not attempt to remove the battery or dispose it in a fire. Do not disassemble, crush, or puncture the battery. If you intend to discard the product, the waste collection site will take the appropriate measures for the recycling and treatment of the product, including the battery.

Index

Symbols

"PCoIP" 32

A

Appendix 62

C

Checking the Contents 12

Connect to the host PC using a LAN cable 31

Connection to Use "PCoIP" 22

Contact SAMSUNG WORLD WIDE 62

Copyright 4

Correct Disposal 69

G

General 60

I

Installation 17

P

Parts 14

S

Safety Precautions 5

W

What is a PC over IP 21

Free Manuals Download Website

<http://myh66.com>

<http://usermanuals.us>

<http://www.somanuals.com>

<http://www.4manuals.cc>

<http://www.manual-lib.com>

<http://www.404manual.com>

<http://www.luxmanual.com>

<http://aubethermostatmanual.com>

Golf course search by state

<http://golfingnear.com>

Email search by domain

<http://emailbydomain.com>

Auto manuals search

<http://auto.somanuals.com>

TV manuals search

<http://tv.somanuals.com>