

**SAMSUNG**

# **GT-P3100** user manual



# Using this manual

Thank you for choosing this Samsung mobile device. This device will provide you with high-quality mobile communication and entertainment based on Samsung's exceptional technology and high standards.

This manual has been specially designed to guide you through the functions and features of your device.

## Read me first

- Before using your device, read the entire manual and all safety instructions to ensure safe and proper use.
- The descriptions in this manual are based on the default settings of your device.
- The images and screenshots used in this manual may differ from the actual product.
- The contents of this manual may differ from the product, or from software provided by service providers or carriers, and are subject to change without prior notice. Access the Samsung website ([www.samsung.com](http://www.samsung.com)) for the latest version of the manual.
- Available features and additional services may vary by device, software, or service provider.
- Formatting and delivery of this manual is based on Android operating systems and may vary depending on the user's operating system.
- Applications on this device may perform differently from comparable computer applications and may not include all functions available in the computer version.
- Applications and their functions may vary by region or hardware specifications. Samsung is not liable for performance issues caused by third-party applications.

- Samsung is not liable for performance issues or incompatibilities caused by edited registry settings or modified operating system software. Attempting to customise the operating system may cause your device or applications to work improperly.
- You can upgrade your device's software by accessing the Samsung website ([www.samsung.com](http://www.samsung.com)).
- Software, audio, wallpapers, and images provided in this device are licensed for limited use between Samsung and their respective owners. Extracting and using these materials for commercial or other purposes is an infringement of copyright laws. Samsung is not liable for such copyright infringement by users.
- Please keep this manual for future reference.

## Instructional icons

Before you start, familiarise yourself with the icons used in this manual:



**Warning**—situations that could cause injury to yourself or others



**Caution**—situations that could cause damage to your device or other equipment



**Note**—notes, usage tips, or additional information



**Refer to**—pages with related information; for example: ► p. 12 (represents “refer to page 12”)



**Followed by**—the order of options or menus you must select to perform a step; for example: In the application list, select **Settings** → **Sound** → **Device ringtone** (represents **Settings**, followed by **Sound**, followed by **Device ringtone**)

# Copyright

Copyright © 2013 Samsung Electronics

This manual is protected under international copyright laws.

No part of this manual may be reproduced, distributed, translated, or transmitted in any form or by any means, electronic or mechanical, including photocopying, recording, or storing in any information storage and retrieval system, without the prior written permission of Samsung Electronics.

# Trademarks

- SAMSUNG and the SAMSUNG logo are registered trademarks of Samsung Electronics.
- The Android logo, Google™, Google Maps™, Google Mail™, YouTube™, Google Play™ Store, Google Latitude™, and Google Talk™ are trademarks of Google, Inc.
- Bluetooth® is a registered trademark of the Bluetooth SIG, Inc. worldwide.
- Windows Media Player® is a registered trademark of the Microsoft Corporation.
- Wi-Fi®, Wi-Fi Protected Setup™, Wi-Fi Direct™, Wi-Fi CERTIFIED™, and the Wi-Fi logo are registered trademarks of the Wi-Fi Alliance.

- DivX<sup>®</sup>, DivX Certified<sup>®</sup> and associated logos are trademarks of Rovi Corporation or its subsidiaries and are used under licence.

**DIVX**<sup>™</sup>  
**HD**

- All other trademarks and copyrights are the property of their respective owners.



**CE 0168** 

## **ABOUT DIVX VIDEO**

DivX<sup>®</sup> is a digital video format created by DivX, LLC, a subsidiary of Rovi Corporation. This is an official DivX Certified<sup>®</sup> device that plays DivX video. Visit [www.divx.com](http://www.divx.com) for more information and software tools to convert your files into DivX videos.

## **ABOUT DIVX VIDEO-ON-DEMAND**

This DivX Certified<sup>®</sup> device must be registered in order to play purchased DivX Video-on-Demand (VOD) movies. To obtain your registration code, locate the DivX VOD section in your device setup menu. Go to [vod.divx.com](http://vod.divx.com) for more information on how to complete your registration.

DivX Certified<sup>®</sup> to play DivX<sup>®</sup> video up to HD 720p, including premium content.

# Contents

<b>Assembling .....</b>	<b>10</b>
Unpack .....	10
Device layout .....	11
Keys .....	13
Insert the SIM or USIM card .....	14
Charge the battery .....	15
Insert a memory card (optional) .....	18
<b>Getting started .....</b>	<b>20</b>
Turn on or off your device .....	20
Use the touch screen .....	21
Lock or unlock the touch screen and the keys .....	24
Get to know the Home screen .....	24
Access applications .....	30
Launch multiple applications .....	32
Customise your device .....	32
Enter text .....	38
<b>Web and GPS-based services.....</b>	<b>40</b>
Internet .....	40
Game Hub .....	43
Maps .....	44
Navigation .....	46
Local .....	47
Play Store .....	48
Readers Hub .....	49

Samsung Apps .....	49
S Suggest .....	49
YouTube .....	50
Voice Search .....	51
<b>Communication .....</b>	<b>52</b>
Calling .....	52
Messages .....	62
Google Mail .....	64
Email .....	66
Talk .....	68
ChatON .....	69
Messenger .....	70
Google+ .....	70
<b>Entertainment.....</b>	<b>71</b>
Camera .....	71
Video Player .....	79
Gallery .....	82
Photo Editor .....	85
Video Editor .....	86
Music Player .....	88
Music Hub .....	92
<b>Personal information .....</b>	<b>93</b>
Contacts .....	93
S Planner .....	96
Memo .....	98

<b>Connectivity .....</b>	<b>99</b>
USB connections .....	99
Wi-Fi .....	101
Wi-Fi Direct .....	104
AllShare Play .....	105
Mobile network sharing .....	108
Bluetooth .....	110
GPS .....	112
VPN connections .....	113
<b>Tools.....</b>	<b>116</b>
Alarm .....	116
Calculator .....	117
Downloads .....	117
Dropbox .....	118
My Files .....	119
Polaris Office .....	120
Google .....	122
SIM Toolkit .....	122
World Clock .....	123
<b>Settings .....</b>	<b>124</b>
Access the setting options .....	124
Wi-Fi .....	124
Bluetooth .....	124
Data usage .....	125
More settings .....	125
Blocking mode .....	127
Sound .....	127
Display .....	128



Storage .....	129
Power saving .....	129
Battery .....	129
Applications manager .....	129
Location services .....	130
Lock screen .....	130
Security .....	131
Language and input .....	132
Cloud .....	134
Back up and reset .....	135
Add account .....	135
Accessory .....	135
Date and time .....	135
Accessibility .....	136
Developer options .....	137
About device .....	139
<b>Troubleshooting .....</b>	<b>140</b>
<b>Index .....</b>	<b>145</b>

# Assembling

## Unpack

Check your product box for the following items:

- Mobile device
- Quick start guide



Use only Samsung-approved software. Pirated or illegal software may cause damage or malfunctions that are not covered by your manufacturer's warranty.



- The items supplied with your device and available accessories may vary depending on your region or service provider.
- You can buy additional accessories from your local Samsung retailer.
- The supplied items are designed only for your device and may not be compatible with other devices.
- Other accessories may not be compatible with your device.

# Device layout

## › Front view

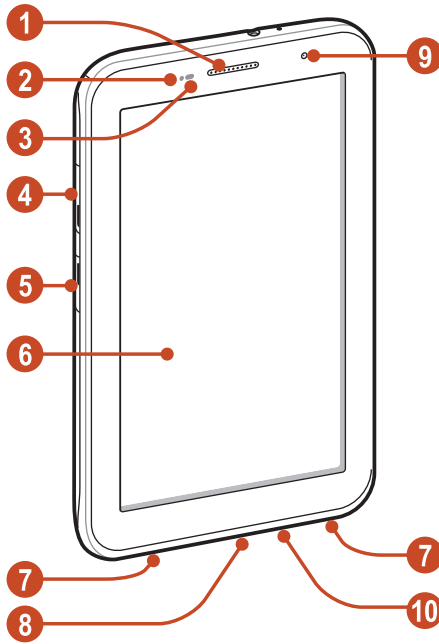

Number	Function
1	Earpiece
2	Light sensor
3	Proximity sensor
4	SIM card slot

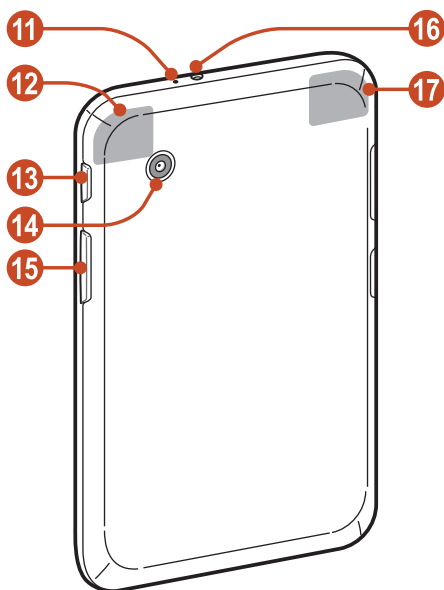

Number	Function
5	Memory card slot
6	Touch screen
7	Speaker
8	Multifunction jack
9	Front camera lens
10	Microphone

## > Rear view



Number	Function
11	Microphone <sup>1</sup>
12	GPS antenna <sup>2</sup>
13	Power/Reset/Lock key
14	Rear camera lens
15	Volume key
16	Headset jack
17	Main antenna

## Keys

Key	Function
 Power/ Reset <sup>3</sup> / Lock	Turn on the device (press and hold); Access the device options (press and hold); Reset the device (press and hold for 8-10 seconds); Turn off and lock the touch screen or turn it on.
 Volume	Adjust the device's volume.

1. Active only when you use the speakerphone feature or record videos.
2. Do not touch or cover the area around the antenna with your hands or other objects while using the GPS functions.
3. If your device experiences fatal errors, hanging, or freezing, you may need to reset the device to regain functionality.

## Insert the SIM or USIM card

When you subscribe to a cellular service, you will receive a Subscriber Identity Module (SIM) card, with subscription details, such as your personal identification number (PIN) and optional services. To use UMTS or HSDPA services, you can purchase a Universal Subscriber Identity Module (USIM) card.

- 1 Open the cover of the SIM card slot.
- 2 Insert the SIM or USIM card with the gold-coloured contacts facing downwards.

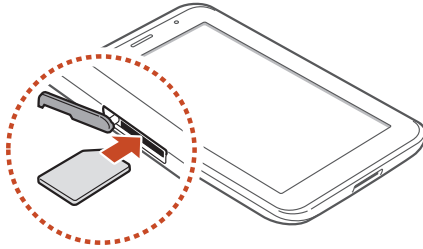

-  Do not insert a memory card into the SIM card slot. If the memory card becomes lodged in the SIM card slot, you must take your device to a Samsung Service Centre to have the memory card removed.
- The SIM card slot of your device is only suited for standard SIM cards. Inserting a microSIM card or a microSIM card with an unauthorised holder may cause damage to the SIM card slot of your device.

- 3 Close the cover of the SIM card slot.

## Charge the battery

Before using the device for the first time or when the battery has been unused for an extended period, you must charge the battery. Charge the battery only with a charger. You cannot charge the battery with a USB cable.

You cannot replace the battery in the device. If you have problems with the battery or need it replaced, take the device to a Samsung Service Centre.



Use only Samsung-approved chargers and cables. Unapproved chargers or cables may cause batteries to explode or damage your device.



- When your battery is low, the device will emit a warning tone and show a low battery message. Recharge your battery to continue using your device.
- If the battery is completely discharged, you cannot turn on the device, even while it is charging. Allow a depleted battery to charge for a few minutes before you try to turn on the device.
- The shape of the USB power adapter may differ depending on your region.

- 1 Connect the USB cable to the USB power adapter and then plug the end of the USB cable into the multifunction jack.

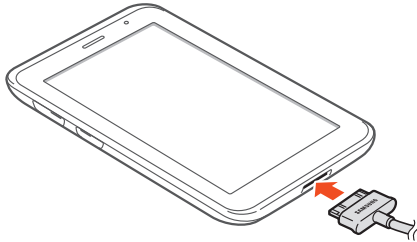

- ⚠ Connecting the USB cable improperly may cause serious damage to the device or USB power adapter. Any damage caused by misuse is not covered by the warranty.

- 2 Plug the USB power adapter into a power outlet.



- If the device receives an unstable power supply while charging, the touch screen may not function. If this happens, unplug the USB cable from the device.
- The device may heat up while charging. This is normal and should not affect your device's lifespan or performance.
- If your device is not charging properly, take your device and the charger to a Samsung Service Centre.



3 When the battery is fully charged, first unplug the USB cable from the device, and then unplug the USB power adapter from the electrical socket.



To save energy, unplug the USB power adapter when not in use. The USB power adapter does not have a power switch, so you must unplug the USB power adapter from the electrical socket when not in use to avoid wasting power. The device should remain close to the electrical socket while charging.

## ▶ Reduce the battery consumption

Your device provides options that help you save battery power. By customising these options and deactivating features in the background, you can use the device longer between charges:

- When you are not using your device, switch to Sleep mode by pressing the Power key.
- Close unnecessary applications with the task manager.
- Deactivate the Bluetooth feature.
- Deactivate the Wi-Fi feature.
- Deactivate auto-syncing of applications.
- Decrease the backlight time.
- Decrease the brightness of the display.

## Insert a memory card (optional)

Your device accepts memory cards with maximum capacities of 32 GB. Depending on the memory card manufacturer and type, some memory cards may not be compatible with your device.

 Samsung uses approved industry standards for memory cards, but some brands may not be fully compatible with your device. Using an incompatible memory card may damage your device or the memory card. It may also corrupt data saved on the memory card.

-  Your device supports only the FAT file structure for memory cards. If you insert a memory card formatted with a different file structure, your device will ask you to reformat the memory card.
- Frequent writing and erasing of data will shorten the lifespan of your memory cards.
- When you insert a memory card into your device, the memory card's file directory will appear in the extSdCard folder.

1 Open the cover of the memory card slot.

2 Insert a memory card with the gold-coloured contacts facing downwards.

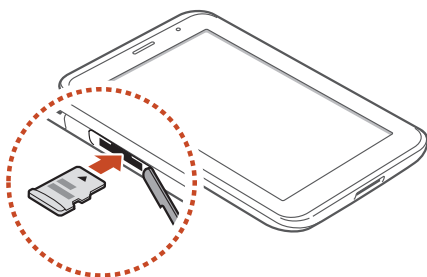

- 3 Push the memory card into the memory card slot until it locks in place.
- 4 Close the cover of the memory card slot.

## › Remove a memory card

Ensure that the device is not currently accessing the memory card.

- 1 In the application list, select **Settings** → **Storage** → **Unmount SD card** → **OK**.
- 2 Open the cover of the memory card slot.
- 3 Push the memory card gently until it disengages from the device.
- 4 Remove the memory card.
- 5 Close the cover of the memory card slot.

 Do not remove a memory card while the device is transferring or accessing information, as this could result in loss of data or damage to the memory card or device.

## › Format a memory card

Formatting your memory card on a computer may cause incompatibilities with your device. Format the memory card only on the device.

In the application list, select **Settings** → **Storage** → **Format SD card** → **Format SD card** → **Erase everything**.

 Before formatting the memory card, remember to make backup copies of all important data. The manufacturer's warranty does not cover loss of data resulting from user actions.

# Getting started

## Turn on or off your device

To turn on your device, press and hold the Power key.



If you are turning on your device for the first time, follow the on-screen instructions to set up your device. You must sign in to Google or create a Google account to use applications that interact with the Google server.

To turn off your device, press and hold the Power key, and then select **Power off** → **OK**.



- Follow all posted warnings and directions from approved personnel in areas where the use of wireless devices is restricted, such as aeroplanes and hospitals.
- To use only your device's non-network features, switch to Flight mode. ► p. 125

## Use the touch screen

Your device's touch screen lets you easily select items or perform functions. Learn basic actions for using the touch screen.



- Do not press the touch screen with your fingertips, or use sharp tools on the touch screen. Doing so may damage the touch screen or cause it to malfunction.
- Do not allow the touch screen to come into contact with other electrical devices. Electrostatic discharges can cause the touch screen to malfunction.
- Do not allow the touch screen to come into contact with liquids. The touch screen may malfunction in humid conditions or when exposed to liquids.
- Leaving the touch screen idle for extended periods may result in afterimages (screen burn-in) or ghosting. Turn off the touch screen when you do not use the device.



- For optimal use of the touch screen, remove the screen protection film before using your device.
- Your touch screen has a layer that detects small electrical charges emitted by the human body. For best performance, tap the touch screen with your fingertip. The touch screen will not react to touches from sharp objects, such as a stylus or pen.

Control your touch screen with the following actions:

### **Tap**

Touch once to select or launch a menu, option, or application.



### **Tap and hold**

Tap an item and hold it for more than 2 seconds.



### **Drag**

Tap an item and move it to a new location.

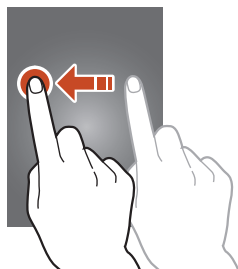

### **Double-tap**

Tap an item twice quickly.



## Flick

Briskly scroll up, down, left, or right to move through lists or screens.



## Pinch

Place two of your fingers far apart, and then pinch them together.



- Your device turns off the touch screen when you do not use it for a specified period. To turn on the screen, press the Power key.
- You can set the length of time that the device waits before turning off the screen. In the application list, select **Settings** → **Display** → **Screen timeout**.

## Lock or unlock the touch screen and the keys

When you do not use the device for a specified period, your device turns off the touch screen and locks the touch screen and the keys automatically to prevent unintended operations. To lock the touch screen and the keys manually, press the Power key.

To unlock them, turn on the screen by pressing the Power key, tap anywhere on the screen, and then drag your finger outside of the large circle.



You can activate the screen lock feature to prevent others from using or accessing your personal data and information saved in your device. ► p. 35

## Get to know the Home screen

From the Home screen, you can view your device's status and access applications.

The Home screen has multiple panels. Scroll left or right to view the panels on the Home screen. You can also select one of the dots at the bottom of the screen to move directly to the corresponding panel.



## › System bar

From the system bar at the bottom of the screen, you can quickly navigate the screen and access applications.

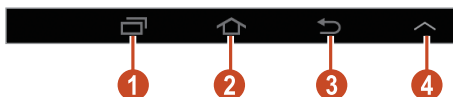



Number	Function
1	Open the list of recent applications.
2	Return to the Home screen; Access the Google search widget or Google Now (tap and hold).
3	Return to the previous screen.
4	Open the mini apps panel.

## Indicator icons



Icons shown on the display may vary depending on your region or service provider.

Icon	Definition
	No signal
	Signal strength
	Connected to GPRS network
	Connected to EDGE network
	Connected to HSDPA network
	Wi-Fi AP connected
	Bluetooth feature activated
	GPS-based services in use
	Call in progress
	Missed call
	Connected to computer
	No SIM or USIM card
	New message
	Alarm activated
	Roaming (outside of service area)

Icon	Definition
	Flight mode activated
	Error occurred or caution required
	Battery power level

## › Use the notifications panel

To open the notifications panel, tap the indicator icons area and drag it downwards. To hide the panel, drag the bottom of the panel upwards.

From the notifications panel, you can view your device's current status and use the following options:

- **Wi-Fi:** Activate or deactivate the Wi-Fi feature. ► p. 101
- **GPS:** Activate or deactivate the GPS feature. ► p. 112
- **Sound:** Activate or deactivate Silent mode. You can mute your device or set it to vibrate in Silent mode.
- **Screen rotation:** Allow or prevent the interface from rotating when you rotate the device.
- **Power saving:** Activate or deactivate Power saving mode.
- **Blocking mode:** Activate or deactivate Blocking mode.
- **Mobile data:** Activate or deactivate the data connection.
- **Bluetooth:** Activate or deactivate the Bluetooth feature. ► p. 110
- **Driving mode:** Activate or deactivate Driving mode.
- **Sync:** Activate or deactivate auto-syncing of applications.



The options available may vary depending on your region or service provider.

## › Move an item on the Home screen

Tap and hold an item, and then drag it to a new location. You can add an item to a new folder or move it to a new panel. Tap and hold the item, and then drag it to **Create folder** or **Create page**.

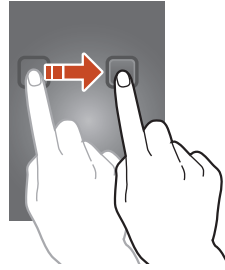

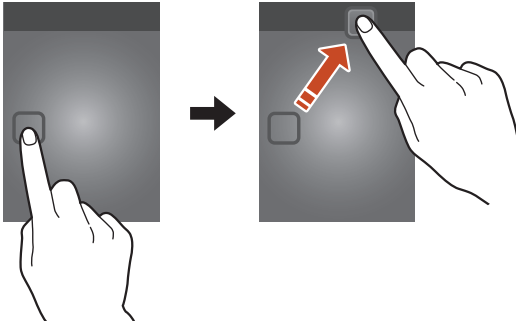

## › Remove an item from the Home screen

Tap and hold an item, and then drag it to the rubbish bin.



## › Add or remove a panel from the Home screen

You can add or remove Home screen panels to organise widgets.

- 1 On the Home screen, place two fingers on the screen and pinch them together to switch to Edit mode.
- 2 Add, remove, or reorganise panels:
  - To remove a panel, tap and hold the panel's thumbnail image, and then drag it to the rubbish bin.
  - To add a new panel, select .
  - To set the main panel of the Home screen, select .
  - To change the order of panels, tap and hold the panel's thumbnail image, and then drag it to a new location.
- 3 Select  to return to the previous screen.

## › Use widgets



Widgets are small applications that provide convenient functions and information on your Home screen.

 The widgets available may vary depending on your region or service provider.

- 1 In the application list, select **Widgets** to open the widget panel.
- 2 Scroll left or right on the widget panel to find a widget.
- 3 Tap and hold a widget to add it to the Home screen.

## Access applications

Launch applications and take full advantage of features on your device. You can reorganise the application list to match your preferences, or download applications from the Internet to enhance your device's functionality.

- 1 On the Home screen, select **Apps** to access the application list.
- 2 Scroll left or right to another screen.  
You can also select one of the dots at the bottom of the screen to move directly to the corresponding screen.
- 3 Select an application.
- 4 Select  to return to the previous screen. Select  to return to the Home screen.



- You can add an application shortcut to the Home screen by tapping and holding an icon in the application list.
- If you rotate the device while using some features, the interface will rotate as well. To prevent the interface from rotating, tap the indicator icons area and drag it downwards to open the notifications panel, and then select **Screen rotation**.

## › Organise applications

You can change the order of applications in the application list or group them into categories.

- 1 In the application list, select  → **Edit**.
- 2 Tap and hold an application icon.

- 3 Organise applications:
  - To move the application, drag it to a new location.
  - To add the application to a new folder, drag it to **Create folder**.
  - To move the application to a new panel, drag it to **Create page**.
  - To uninstall the application, drag it to **Uninstall**.
- 4 Select .

## › Download an application

1 In the application list, select **Play Store** or **Samsung Apps**.

2 Search for an application and download it to the device.

 To install applications that you downloaded from other sources, you must select **Settings** → **Security** → **Unknown sources**.

## › Uninstall an application

1 In the application list, select  → **Uninstall**.

2 Select  on an application icon and then select **OK**.

 You can uninstall only the applications that you have downloaded.

## › Access recently-used applications

1 Select  to view the applications you have accessed recently.



2 Select an application.

## Launch multiple applications

Your device allows you to multitask by running multiple applications at the same time. To launch multiple applications, select  while using an application. Then select another application to launch from the Home screen.

### › Manage applications

You can manage multiple applications with the task manager.

- 1 Select  →  → **Active applications**.  
The task manager launches and shows active applications.
- 2 Control active applications:
  - To switch applications, select one from the list.
  - To close an application, select **End**.
  - To close all active applications, select **End all**.

## Customise your device

Get more from your device by changing settings to match your preferences.

### › Change the display language

- 1 In the application list, select **Settings** → **Language and input** → **Language**.
- 2 Select a language.

### › Turn on or off the touch tones

In the application list, select **Settings** → **Sound** → **Touch sounds**.



## › Adjust the device's volume



- 1 Press the Volume key up or down.
- 2 Select  and drag the sliders to adjust the volume level for each sound.

## › Change your call ringtone

- 1 In the application list, select **Settings** → **Sound** → **Device ringtone**.
- 2 Select a ringtone → **OK**.

## › Switch to Silent mode

To mute or unmute your device, do one of the following:

- Tap the indicator icons area and drag it downwards to open the notifications panel, and then select **Sound**.
- Press and hold the Power key, and then select  or .
- In the application list, select **Phone** → **Keypad**, and then tap and hold .

## › Select a wallpaper for the Home screen

- 1 On the Home screen, tap and hold the empty area.
- 2 Select **Set wallpaper** → **Home screen** → an image folder → an image.

## › Change the display font

- 1 In the application list, select **Settings** → **Display** → **Font style**.
- 2 Select a font.

## › Adjust the brightness of the display

Your device includes a light sensor, which can detect the level of ambient light and adjust the brightness of the display automatically. You can also manually set the brightness of the display.



The brightness of the display will affect how quickly the device consumes battery power.

### Set your device to adjust the brightness automatically

- 1 In the application list, select **Settings** → **Display** → **Brightness**.
- 2 Select the tick box next to **Automatic brightness**.
- 3 Select **OK**.  
The device will increase the brightness in bright surroundings and decrease the brightness in dim surroundings automatically.

### Adjust the brightness manually

- 1 In the application list, select **Settings** → **Display** → **Brightness**.
- 2 Clear the tick box next to **Automatic brightness**.
- 3 Drag the slider to the left or right.
- 4 Select **OK**.

## › Lock your device

You can lock your device by activating the screen lock feature.



- If you forget your password, take your device to a Samsung Service Centre to reset it.
- Samsung is not responsible for the loss of passwords or private information, or other damages caused by illegal software.

## Set a face detection unlock

- 1 In the application list, select **Settings** → **Lock screen** → **Screen lock** → **Face unlock**.
- 2 Select **Next** → **Set it up** → **Continue**.
- 3 Adjust the device to fit your face inside the figure.
- 4 When your face is captured correctly, select **Continue**.
- 5 Complete the setup of the backup PIN or pattern.

## Set an unlock pattern

- 1 In the application list, select **Settings** → **Lock screen** → **Screen lock** → **Pattern**.
- 2 View the on-screen instructions and the example pattern, and then select **Next**.
- 3 Draw a pattern to connect at least 4 dots and select **Continue**.
- 4 Draw the pattern again to confirm and select **Confirm**.
- 5 Complete the setup of the backup PIN.



- If you forget your unlock pattern, you can deactivate the screen lock feature with a backup PIN.

## Set an unlock PIN

- 1 In the application list, select **Settings** → **Lock screen** → **Screen lock** → **PIN**.
- 2 Enter a new PIN and select **Continue**.
- 3 Enter the PIN again and select **OK**.

## Set an unlock password

- 1 In the application list, select **Settings** → **Lock screen** → **Screen lock** → **Password**.
- 2 Enter a new password (alphanumeric) and select **Continue**.
- 3 Enter the password again and select **OK**.

## ▶ Lock your SIM or USIM card

You can lock your device with the PIN that is supplied with your SIM or USIM card. Once the SIM or USIM lock is enabled, you must enter the PIN each time you turn on the device or access applications that require the PIN.

- 1 In the application list, select **Settings** → **Security** → **Set up SIM card lock** → **Lock SIM card**.
- 2 Enter your PIN and select **OK**.



- If you enter an incorrect PIN too many times, your SIM or USIM card will be blocked. You must enter a PIN unlock key (PUK) to unblock the SIM or USIM card.
- If you block your SIM or USIM card by entering an incorrect PUK, take the SIM or USIM card to your service provider to unblock it.

## ➤ Activate the Find my mobile feature

When someone inserts a new SIM or USIM card into your lost or stolen device, the Find my mobile feature will send the contact number to your specified recipients automatically, so that you can locate and recover your device. To use this feature, you must create a Samsung account for controlling the device remotely via the Internet.

- 1 In the application list, select **Settings** → **Security** → **SIM Change Alert**.
- 2 Select **Sign in**.  
To create a Samsung account, select **Create new account**.
- 3 Enter the email address and password for your Samsung account, and then select **Sign in**.
- 4 Drag the slide bar at the top of the screen.
- 5 Add recipients:
  - Select **Create** and enter phone numbers manually, including the country code and the + symbol.
  - Select phone numbers from your contact list by selecting **Contacts**.
- 6 Select **Alert message**.
- 7 Enter the text message that will be sent to the recipients and select **OK**.
- 8 Select **Save**.

## Enter text

You can enter text by speaking words into the microphone or selecting characters on the virtual keypad.



Text entry is not supported in some languages. To enter text, you must change the input language to one of the supported languages.

### › Change the text input method

- 1 From a text field, tap the indicator icons area and drag it downwards to open the notifications panel.
- 2 Select **Choose input method** → a text input method

### › Enter text with the Google voice input feature

- 1 To add input languages for voice recognition, select the language → **Add more languages**.
- 2 Speak your text into the microphone.
- 3 When you are finished, select **Tap to pause**.

### › Enter text with the Samsung keypad

Enter text by selecting alphanumeric keys.

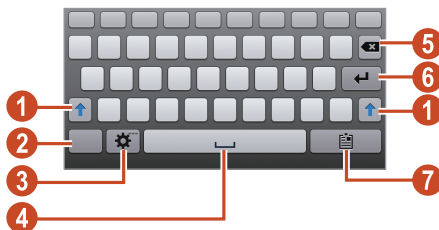

You can also use the following keys:



Number	Function
1	Change the case.
2	Switch text input modes.
3	Access the keypad settings; Enter text by voice (tap and hold).
4	Insert a space.
5	Clear your input.
6	Start a new line.
7	Add an item from the clipboard.

## › Copy and paste text

From a text field, you can copy and paste text to another application.

- 1 Tap and hold a passage of text.
- 2 Drag  or  to select the text to be copied.
- 3 Select **Copy** or **Cut** to add the text to the clipboard.
- 4 In another application, place the cursor at the point where the text will be inserted.
- 5 Select **Paste** to insert the text from the clipboard into the text field.

# Web and GPS-based services



You may incur additional charges for accessing the Internet and downloading media files. For details, contact your service provider.

## Internet

Learn to access and bookmark your favourite webpages.



- This feature may be labelled differently depending on your region or service provider.
- Available icons may vary depending on your region or service provider.

### › Browse a webpage

- 1 In the application list, select **Internet**.
- 2 To access a specific webpage, select the URL field, enter the web address, and then select **Go**.
- 3 Navigate webpages with the following keys:

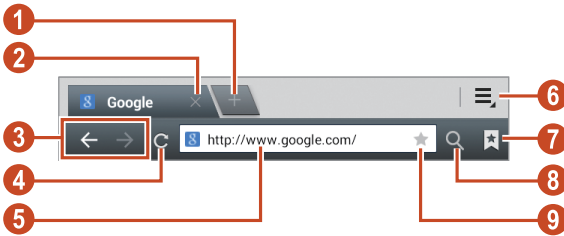











Number	Function
1	Open a new window.
2	Close the current window.



Number	Function
3	Move backwards or forwards to webpages in history.
4	Reload the current webpage. While the device is loading webpages, this icon changes to  .
5	Enter a web address or a keyword.
6	Access web browser options.
7	View your bookmarks, saved pages, and recent Internet history.
8	Activate the URL field.
9	Bookmark the current webpage.

While browsing a webpage, access the following options:

- To zoom in or out, place two fingers on the screen and slowly spread them apart or pinch them together. To return to the original size, double-tap the screen.
- To open a new window, select  → **New tab**.
- To open a new window without saving your browsing data, select  → **New incognito tab**.
- To add a shortcut for the current webpage to the Home screen, select  → **Add shortcut to home**.
- To send a web address to others, select  → **Share page**.
- To search for text on a webpage, select  → **Find on page**.
- To switch to the desktop view, select  → **Desktop view**.
- To save the current webpage for reading offline, select  → **Save for offline reading**. You can view the saved pages by selecting  → **Saved pages**.

- To view your download history, select  → **Downloads**.
- To print the webpage via Wi-Fi or USB, select  → **Print**.  
Your device is compatible only with some Samsung printers.
- To change the browser settings, select  → **Settings**.

## ▶ Search for information by voice



This feature may be unavailable depending on your region or service provider.

- 1 In the application list, select **Internet**.
- 2 Select the URL field.
- 3 Select  and say a keyword into your device's microphone.  
The device searches for webpages related to the keyword.
- 4 Select a search result.

## ▶ Bookmark your favourite webpage

If you know the address of a webpage, you can add a bookmark manually.

- 1 In the application list, select **Internet**.
- 2 Enter a web address or navigate to a webpage.
- 3 Select .
- 4 Enter a name for the bookmark and select **OK**.

## › Download a file from the Internet

When you download files or applications from the Internet, your device saves them to the internal memory.

 Files you download from the Internet can include viruses that will damage your device. To reduce this risk, only download files from sources you trust.

 Some media files include Digital Rights Management to protect copyrights. This protection may prevent you from downloading, copying, modifying, or transferring some files.

- 1 In the application list, select **Internet**.
- 2 Search for a file or application and download it to the device.

## › View your recent history

- 1 In the application list, select **Internet** →  → **History**.
- 2 Select a webpage to access.

## Game Hub

Learn to access and download games.

- 1 In the application list, select **Game Hub**.
- 2 Select a game service.
- 3 Search for and download games from the online store.

 The games available may vary depending on your region or service provider.



# Maps

Learn to use the Google Maps™ mapping service to find your location, search for places, and get directions.











- This feature may be unavailable depending on your region or service provider.
- You must activate location services to find your location and search the map. ► p. 112

## › Search for a location

- 1 In the application list, select **Maps**.  
The map will show your current location.
- 2 Select **Search Maps**.
- 3 Enter a keyword for the location and select .  
To search for a location by voice, select .
- 4 Select the location to view its details.

While viewing the map, use the following options:

- To zoom in or out, place two fingers on the screen and slowly spread them apart or pinch them together.
- To view all of the search results, select **Search Results**.
- To view your current location, select . To switch to the compass view of the map that changes orientation when you move the device, select .
- To get directions to a specific destination, select .



- To add a star to the location, select the balloon with the location name →  → **Add star**.
- To save a map for offline viewing, select  → **Make available offline**. To view the saved map, select  → **My Places** → **OFFLINE**.
- To search for a place nearby, select  → **Local**.
- To add layers of additional information to the map or change the view mode, select  → **Layers**.

## › Share locations using Google Latitude



Learn to share your location with your friends and view their locations with the Google Latitude™ location service.



This feature may be unavailable depending on your region or service provider.

- 1 In the application list, select **Maps**.
- 2 Select  → **Latitude**.  
The device joins Latitude automatically.
- 3 Select  → **Add friends** → an option.
- 4 Select a friend, or enter an email address and select **Add friends**.
- 5 Select **Yes**.  
When your friend accepts your invitation, you can share locations.

## › Get directions to a specific destination

- 1 In the application list, select **Maps**.
- 2 Select .
- 3 Enter the addresses of the starting location and the destination.  
To enter an address from your contact list or starred places, or select a point on the map, select  → an option.
- 4 Select a travel method and select **Go**.  
The route is indicated on the map. Depending on the selected travel method, you may see multiple routes.
- 5 When you are finished, select  → **Clear Map**.

## Navigation

Learn to get spoken directions to your destination.



- Navigation maps, your current location, and other navigational data may differ from actual location information. You should always pay attention to road conditions, traffic, and any other factors that may affect your driving and follow all safety warnings and regulations while driving.
- This feature may be unavailable depending on your region or service provider.

- 1 In the application list, select **Navigation**.
- 2 Enter your destination with the following methods:
  - **Speak destination:** Enter your destination by voice.
  - **Type destination:** Enter your destination with the virtual keypad.
  - **Contacts:** Select your destination from contacts' addresses.
  - **Starred places:** Select your destination from your starred places.
- 3 Install the required software, and then use the navigation features.

## Local

Learn to search for business and attractions.



This feature may be unavailable depending on your region or service provider.

- 1 In the application list, select **Local**.
- 2 If you want to search for businesses or attractions near a specific location, select your location → **Enter an address**.
- 3 Select a category.  
The device searches for places nearby that are related to the category.
- 4 Select a place name to view its details.



You can add more categories by selecting **+** → **Add a search**.

# Play Store

Your device's functionality can be extended by installing additional applications. Play Store provides a quick and easy way to shop for mobile applications.



- This feature may be unavailable depending on your region or service provider.
- Your device will save user files from downloaded applications to the internal memory.

## › Download an application

- 1 In the application list, select **Play Store**.
- 2 Search for an application and download it to the device. When the download is complete, the device will install the application automatically.

## › Uninstall an application

- 1 In the application list, select **Play Store**.
- 2 Select .
- 3 Select an item.
- 4 Select **Uninstall** → **OK**.



## Readers Hub

Learn to access various reading materials.

- 1 In the application list, select **Readers Hub**.
- 2 Select a type of reading material.
- 3 Search for and download reading material from the online store.

## Samsung Apps

Samsung Apps allows you to easily download a wide range of applications and updates for your device. With fully optimised applications from Samsung Apps, your device becomes even smarter. Explore the useful applications on offer and enhance your mobile life.

- 1 In the application list, select **Samsung Apps**.
  - 2 Search for and download applications to the device.
-  • This feature may be unavailable depending on your region or service provider.
  - For details, please visit [www.samsungapps.com](http://www.samsungapps.com) or refer to the Samsung Apps leaflet.

## S Suggest

Find and download the latest applications suggested by Samsung. In the application list, select **S Suggest**.

-  This feature may be unavailable depending on your region or service provider.

# YouTube

Learn to view and upload videos via the YouTube™ video sharing service.



This feature may be unavailable depending on your region or service provider.

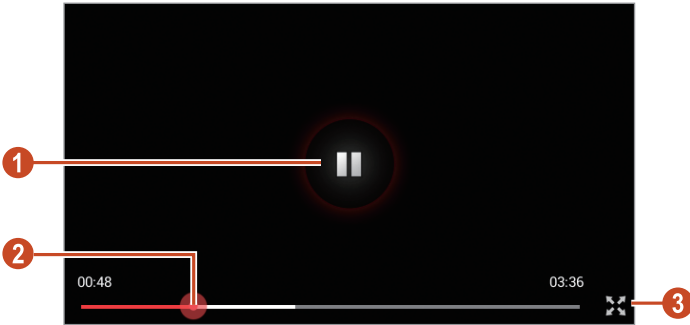

## › Play a video

- 1 In the application list, select **YouTube**.
- 2 Select a video.
- 3 Control playback with the following keys:



Number	Function
1	Pause or resume playback.
2	Scan forwards or backwards in the file by dragging the bar.
3	Play the video on the full screen.

## › Upload a video

- 1 In the application list, select **YouTube**.
- 2 Select your Google account if it is linked to YouTube.  
Alternatively, you can select **Sign in** and set up an account to sign in to YouTube.
- 3 Select  → a category → a video.  
 If you are uploading a video for the first time, select a network type to upload a video.
- 4 Enter the details of the upload and select **Upload**.

## Voice Search

Learn to search the Internet by voice.

-  This feature may be unavailable depending on your region or service provider.

- 1 In the application list, select **Voice Search**.
- 2 Say a keyword into the microphone.  
The device searches for webpages related to the keyword.
- 3 Select a search result.

# Communication

## Calling

Learn to use calling functions, such as making and answering calls, using options available during a call, or customising and using call-related features.



- To prevent accidental inputs, turn on the proximity sensor to lock the touch screen when you hold the device near your face. ► p. 60
- Static electricity discharged from your body or clothing may interfere with the proximity sensor during a call.

### › Make a call

- 1 In the application list, select **Phone** → **Keypad**, and then enter an area code and a phone number.
- 2 Select  to make a voice call.  
To make a video call, select **Video call**.
- 3 Select **End call** to end the call.



- You can save numbers that you call frequently in the contact list. ► p. 93
- To access the call log and redial numbers you have called recently, select **Phone** → **Keypad** → **Logs**.

## › Answer a call

1 During an incoming call, select  and then drag your finger outside of the large circle.

 To mute the ringtone, press the Volume key.

2 Select **End call** to end the call.

## › Reject a call

During an incoming call, select  and then drag your finger outside of the large circle.

To send a message to the caller when you reject a call, drag the reject message bar at the bottom of the screen upwards.

 You can select one of several preset messages or create your own messages. ► p. 59

## › Make an international call

1 In the application list, select **Phone** → **Keypad**, and then tap and hold **0 +** to insert the + character.

2 Enter a complete number (country code, area code, and phone number).

3 Select  to dial the number.

## › Use a headset

Connect a headset to your device to answer and control calls conveniently.

- To answer a call, press the headset button.
- To reject a call, press and hold the headset button.
- To place a call on hold or retrieve a held call, press and hold the headset button.
- To end a call, press the headset button.



## › Use options during a voice call

You can use the following options during a voice call:

- To adjust the voice volume, press the Volume key up or down.
- To place a call on hold, select **Hold**. To retrieve a held call, select **Unhold**.
- To dial a second call, select **Add call**, and then dial a new number.
- To switch between two calls, select **Swap**.
- To answer a second call, select  and then drag your finger outside of the large circle when a call waiting tone sounds. The device prompts you to end or hold the first call. You must subscribe to the call waiting service to use this feature.
- To open the keypad, select **Keypad**.
- To activate the speakerphone feature, select **Speaker**.





In noisy environments, you may have difficulty hearing some calls while using the speakerphone feature. For better audio performance, use the normal phone mode.

- To turn off the microphone so that the other party cannot hear you, select **Mute**.
- To converse with the other party via a Bluetooth headset, select **Headset**.
- To make a multiparty call (conference call), make or answer a second call, and then select **Merge** when connected to the second party. Repeat this to add more parties. You must subscribe to the multiparty call service to use this feature.
- To open the contact list, select  → **Contacts**.
- To create a memo, select  → **Memo**.
- To connect the current party with the party placed on hold, select  → **Transfer**. You will be disconnected from both parties.

## › Use options during a video call

You can use the following options while a video call is in progress:

- To switch between the front and rear camera, select **Switch camera**.
- To open the keypad, select **Keypad**.
- To activate the speakerphone feature, select **Speaker**.
- To turn off the microphone so that the other party cannot hear you, select **Mute**.
- To converse with the other party via a Bluetooth headset, select **Headset**.
- To hide your image from the other party, select  → **Hide me**.
- To select an image to be shown to the other party, select  → **Outgoing image**.

- To capture the other party's image, select **Capture**.
- To record a video of the other party's image, select **Record**.



It is illegal in many areas to record a call without permission. Always ask the other party for permission before recording a call.

## › View and dial a missed call

Your device will show missed calls. To return the call, tap the right bottom of the screen to open the notifications panel, and then select the missed call notification.

## › Set auto rejection

Use auto rejection to reject calls from specified numbers automatically.

- 1 In the application list, select **Phone** → **Keypad** →  → **Call settings** → **Call settings** → **Call rejection**.
- 2 Drag the **Auto reject mode** switch to the right.
- 3 Select **Auto reject mode** → an option.

Option	Function
All numbers	Reject all calls.
Auto reject numbers	Reject calls from phone numbers on the auto reject list.

- 4 Select **Auto reject list**.
- 5 Select .



- 6 Enter a number and select **Save**.  
You can set the criteria for the number.
- 7 To add more numbers, repeat steps 5-6.

## ▶ **Activate Fixed Dialling Number (FDN) mode**

In FDN mode, your device will prevent outgoing calls to any number that is not saved in the FDN list on your SIM or USIM card.

- 1 In the application list, select **Phone** → **Keypad** →  → **Call settings** → **Call settings** → **Additional settings** → **Fixed Dialling Numbers**.
- 2 Select **Enable FDN**.
- 3 Enter the PIN2 supplied with your SIM or USIM card and select **OK**.
- 4 Select **FDN list** and add contacts.

## ▶ **Set call diverting**

Call diverting is a network feature that sends incoming calls to a specified number. You can set this feature separately for several conditions.

- 1 In the application list, select **Phone** → **Keypad** →  → **Call settings** → **Call settings** → **Call forwarding** → a call type.
- 2 Select a condition.
- 3 Enter a number to which calls will be forwarded and select **Enable**.  
Your setting will be sent to the network.

## › Set call barring

Call barring is a network feature that restricts certain types of calling or prevents others from making calls with your device.

- 1 In the application list, select **Phone** → **Keypad** →  → **Call settings** → **Call settings** → **Additional settings** → **Call barring** → a call type.
- 2 Select a call barring option.
- 3 Enter a call barring password and select **OK**.  
Your setting will be sent to the network.

## › Set call waiting

Call waiting is a network feature that alerts you to an incoming call while you are on another call. This feature is available only for voice calls.

In the application list, select **Phone** → **Keypad** →  → **Call settings** → **Call settings** → **Additional settings** → **Call waiting**. Your setting will be sent to the network.

## › View a call or message log

You can view logs of calls and messages that are filtered by type.

- 1 In the application list, select **Phone** → **Keypad** → **Logs**.
- 2 Select  → **View by** → an option.
- 3 Select a log entry to view its details.



From the detail view, you can make a call, send a message to the number, or add the number to the contact list or the auto reject list.

## › Customise call settings

1 In the application list, select **Phone** → **Keypad** →  → **Call settings**.

2 Change the following options:

Option	Function
Call settings → Call rejection	Set to reject calls from specified phone numbers automatically. You can add phone numbers to the auto reject list.
Call settings → Set reject messages	Add or edit the message that will be sent when you reject a call.
Call settings → Ringtones and keypad tones → Device ringtone	Select a ringtone to alert you to incoming calls.
Call settings → Ringtones and keypad tones → Device vibration	Add or select a vibration pattern.
Call settings → Ringtones and keypad tones → Incoming call vibration	Set the device to vibrate and ring to alert you to incoming calls.
Call settings → Ringtones and keypad tones → Keytones	Set the device to sound when you enter numbers on the dialling screen.

Option	Function
Call settings → Call alert	Set the device to alert you to events during a call.
Call settings → The power key ends calls	Set to end a call when you press the Power key.
Call settings → Auto screen off during calls	Set to turn on the proximity sensor during a call.
Call settings → Accessory settings for call → Automatic answering	Set whether or not the device answers calls automatically after a specified period (available only when a headset is connected).
Call settings → Accessory settings for call → Automatic answering timer	Select the length of time that the device waits before answering calls.
Call settings → Accessory settings for call → Outgoing call conditions	Set to allow outgoing calls with a Bluetooth headset, even when your device is locked.
Call settings → Accessory settings for call → Outgoing call type	Select the type of outgoing calls to make you use a Bluetooth headset.
Call settings → Increase volume in pocket	Set the device to intensify the ringtone and vibration when the device is enclosed in places, such as bags or pockets.

Option	Function
Call settings → Call forwarding	Set to send incoming calls to a specified number.
Call settings → Additional settings → Caller ID	Display your caller ID to other parties for outgoing calls.
Call settings → Additional settings → Call barring	Set to restrict calls by call type.
Call settings → Additional settings → Call waiting	Set the device to alert you to incoming calls during a call.
Call settings → Additional settings → Auto redial	Set to automatically redial a call that was not connected or that was cut off.
Call settings → Additional settings → Fixed Dialling Numbers	Activate FDN mode to prevent calls to phone numbers that are not in the FDN list on the SIM or USIM card.
Call settings → Additional settings → Auto area code	Set to insert a prefix (area or country code) automatically before a phone number.
Video call settings → Video call image	Select an alternative image to be shown to the other party.
Video call settings → Own video in received call	Set to show your live image to the other party.
Video call settings → Use call fail options	Set to attempt a voice call when a video call fails to connect.

Option	Function
Voicemail → Voicemail service	Select a voicemail service provider.
Voicemail → Voicemail settings	Enter the voicemail server number. You can obtain this number from your service provider.
Voicemail → Ringtone	Select a ringtone to alert you to new voicemails.
Voicemail → Vibrate	Set the device to vibrate when voicemails are received.
Internet call settings → Accounts	Set up your accounts for IP call services.
Internet call settings → Use Internet calling	Set the device to use IP call services. IP call services are provided only via Wi-Fi.





## Messages

Learn to create and send text (SMS) or multimedia (MMS) messages, and view or manage messages that you have sent or received.





You may incur additional charges for sending or receiving messages while you are outside your home service area. For details, contact your service provider.





## › Send a text message

- 1 In the application list, select **Messaging** → .
- 2 Add recipients:
  - Enter phone numbers manually and separate them with a semicolon or a comma.
  - Select phone numbers from your contact list by selecting .
- 3 Select the text field and enter your message text.  
To insert emoticons, select  → **Insert smiley**.
- 4 To send the message, select .

## › Send a multimedia message

- 1 In the application list, select **Messaging** → .
- 2 Add recipients:
  - Enter phone numbers or email addresses manually and separate them with a semicolon or a comma.
  - Select phone numbers or email addresses from your contact list by selecting .

 When you enter an email address, the device will convert the message to a multimedia message.

- 3 Select the text field and enter your message text.  
To insert emoticons, select  → **Insert smiley**.
- 4 Select  and attach a file.
- 5 Select  → **Add subject** and enter a subject.
- 6 To send the message, select .

## › View a text or multimedia message

- 1 In the application list, select **Messaging**.  
Your messages are grouped by contact as a message thread.
- 2 Select a contact.
- 3 Select a multimedia message to view more details.

## › Listen to a voicemail message

If you have set your device to divert missed calls to the voicemail server, callers may leave voicemail messages when you miss calls.

- 1 In the application list, select **Phone** → **Keypad**, and then tap and hold **1** .
- 2 Follow the instructions from the voicemail server.



You must save the voicemail server number before accessing the voicemail server. Contact your service provider for this number.

## Google Mail



Learn to send or view email messages via the Google Mail™ webmail service.



- This feature may be unavailable depending on your region or service provider.
- This feature may be labelled differently depending on your region or service provider.



## › Send an email message







- 1 In the application list, select **Google Mail** → .
- 2 Select the recipient field and enter an email address.
- 3 Select the subject field and enter a subject.
- 4 Select the text field and enter your email text.
- 5 Select  and attach a file.
- 6 To send the message, select **SEND**.





 If you are offline or outside your service area, the message will be held in the message thread until you are online and inside your service area.

## › View an email message

- 1 In the application list, select **Google Mail**.
- 2 Select  to update the message list.
- 3 Select an email message.

From the message view, use the following options:

- To move to the next or previous message, scroll right or left.
- To reply to the message, select .
- To reply to the message and include all recipients, select .
- To forward the message to others, select .
- To add the message to the favourites list, select .
- To archive the message, select .
- To delete the message, select .
- To add a label to the message, select .

- To mark the message as unread, select .
- To mark the message as unimportant, select  → **Mark as not important.**
- To hide the message, select  → **Mute.** To view hidden messages, select **All mail** from the label list.
- To add the message to the spam list, select  → **Report spam** or **Report phishing.**
- To change the email settings, select  → **Settings.**



The options available may vary depending on the email account or device's orientation.

## Email





Learn to send or view email messages via your personal or company email account.

### › Set up an email account

- 1 In the application list, select **Email.**
- 2 Enter your email address and password.
- 3 Select **Next.** To enter account details manually, select **Manual setup.**
- 4 Follow the on-screen instructions.

When you are finished setting up the email account, email messages will be downloaded to your device. If you have created two or more accounts, you can switch between them. Select an account name at the top of the screen, and then select the account from which you want to retrieve messages.

## › Send an email message







- 1 In the application list, select **Email** → .
- 2 Add recipients:
  - Enter email addresses manually and separate them with a semicolon or a comma.
  - Select email addresses from your contact list by selecting .
- 3 Select the subject field and enter a subject.
- 4 Select the text field and enter your email text.
- 5 Select  and attach a file.
- 6 To send the message, select .







 If you are offline or outside your service area, the message will be held in the message thread until you are online and inside your service area.

## › View an email message

- 1 In the application list, select **Email**.
- 2 Select  to update the message list.
- 3 Select an email message.

From the message view, use the following options:

- To move to the next or previous message, select  or .
- To create a new message, select .
- To reply to the message, select .
- To forward the message to others, select .
- To delete the message, select .
- To mark the message as unread, select  → **Mark as unread**.

- To move the message to another folder, select  → **Move**.
- To save the message to your device, select  → **Save email**. The message will be saved in **My Files** → **sdcard0** → **Saved Email**.
- To print the message via Wi-Fi or USB, select  → **Print**. Your device is compatible only with some Samsung printers.
- To save the email addresses of the recipients to the phonebook as a group of contacts, select  → **Save as group**.
- To change the email settings, select  → **Settings**.
- To save an attachment to your device, select the attachment tab → .



The options available may vary depending on the email account or device's orientation.

## Talk

Learn to send and receive instant messages to friends and family with the Google Talk™ instant messaging service.



This feature may be unavailable depending on your region or service provider.





### › Set your status

- 1 In the application list, select **Talk**.
- 2 Select a Google account.
- 3 Customise your status, image, and message.

## › Add a contact to your friend list

- 1 In the application list, select **Talk** → .
- 2 Enter a friend's email address, and then select **DONE**.  
When your friend accepts the invitation, he or she is added to your friend list.

## › Start a conversation

- 1 In the application list, select **Talk**.
- 2 Select a contact from the friend list.  
The conversation screen opens.
- 3 Enter and send your message.
  - To add more contacts to the conversation, select  → **Add to chat**.
  - To use video chat, select .
  - To use voice chat, select .
- 4 Select  → **End chat** to end the conversation.

## ChatON

Learn to use ChatON to send and receive instant messages from any device that has a mobile phone number.

- 1 In the application list, select **ChatON**.  
 If you are launching this application for the first time, follow the on-screen instructions to complete the account setup.
- 2 Enter and send your message.

## Messenger

Learn to send and receive instant messages from friends and family with the Google+ messenger instant messaging service.

1 In the application list, select **Messenger**.

 If you are launching this application for the first time, follow the on-screen instructions to complete the account setup.

2 Enter and send your message.

## Google+

Learn to access Google's social network service. You can create groups to send and receive instant messages and upload your photos.

1 In the application list, select **Google+**.

 If you are launching this application for the first time, follow the on-screen instructions to complete the account setup.

2 Select a social network feature.

# Entertainment

## Camera

Learn how to take and view photos and videos.





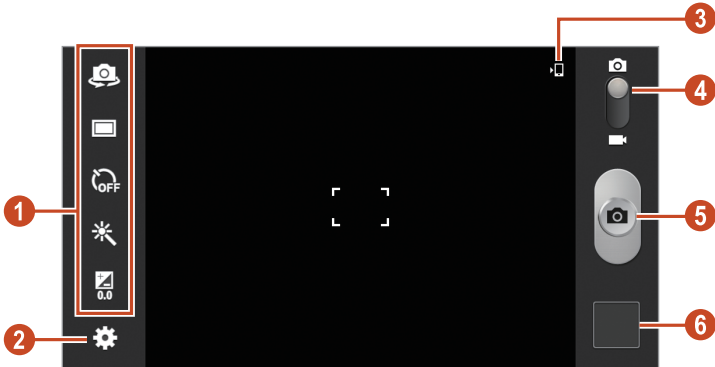

- The camera turns off automatically when you do not use it for a specified period.
- The memory capacity may differ depending on the scene or shooting conditions.

### > Take a photo

- 1 In the application list, select **Camera**.
- 2 Rotate the device to the landscape view.
- 3 Aim the camera lens at the subject and make any necessary adjustments.



Number	Function
1	<p>Use camera shortcuts.</p> <ul style="list-style-type: none"> <li>• : Switch to the front camera to take a photo of yourself.</li> <li>• : Change the shooting mode. <ul style="list-style-type: none"> <li>▶ p. 74</li> </ul> </li> <li>• : Select the length of the delay before the camera takes a photo.</li> <li>• : Apply a special effect.</li> <li>• : Adjust the exposure value to change the brightness.</li> </ul> <p>You can add or remove shortcuts to frequently-used options. ▶ p. 79</p>
2	Change the camera settings.
3	View the storage location.
4	Switch to the camcorder.
5	Take a photo.
6	View photos you have taken.



To zoom in, place two fingers on the screen and slowly spread them apart. To zoom out, pinch them together. You can also zoom in or out with the Volume key. The zoom function may be unavailable when shooting in the highest resolution.

- 4 Select  to take a photo.  
The photo is saved automatically.



After taking a photo, select the image viewer to view it.

- To view more photos, scroll left or right.
- To zoom in or out, place two fingers on the screen and slowly spread them apart or pinch them together. To return to the original size, double-tap the screen.
- To add the photo to the favourites list, select .
- To send the photo to others, select .
- To delete the photo, select .
- To start a slide show, select  → **Slideshow** → **Start slideshow**. Tap the screen to stop the slide show.
- To register the faces in the photo as face tags, select  → **Face tag**. ► p. 83
- To add the photo to the clipboard, select  → **Copy to clipboard**.
- To rotate the photo anti-clockwise, select  → **Rotate left**.
- To rotate the photo clockwise, select  → **Rotate right**.
- To crop a section from the image, select  → **Crop**.
- To edit the photo with the image editor, select  → **Edit**.  
► p. 85
- To set the photo as your wallpaper or a contact image, select  → **Set as**.
- To send the photo to a person whose face is tagged in the photo, select  → **Buddy photo share**.
- To print the photo via Wi-Fi or USB, select  → **Print**. Your device is compatible only with some Samsung printers.
- To change the name of a file, select  → **Rename**.
- To search for devices that have media sharing activated, select  → **Scan for nearby devices**.
- To view photo details, select  → **Details**.

## › Change the shooting mode

You can take photos with various shooting modes. To change the shooting mode, select  → **Shooting mode** → an option.

Option	Function
Panorama	Take panoramic photos.
Share shot	Take a photo and send it to others via Wi-Fi Direct.
Buddy photo share	Set the device to recognise a person's face you have tagged in a photo and send it to that person.
Smile shot	Set the device to recognise people's faces and help you take photos of them when they smile.

## › Customise camera settings

Before taking a photo, select  to access the following options:





Option	Function
Edit shortcuts	Edit shortcuts to frequently-used options.
Self portrait	Take photos of yourself with the front camera.
Shooting mode	Change the shooting mode. ► p. 74
Effects	Apply a special effect.
Scene mode	Change the scene mode.
Exposure value	Adjust the exposure value to change the brightness.

Option	Function
Timer	Select the length of the delay before the camera takes a photo.
Resolution	Select a resolution option.
White balance	Adjust the colour balance according to the lighting conditions.
Metering	Select a type of exposure metering.
Guidelines	Set to view the grid lines on the preview screen.
GPS tag	<p>Set the camera to include location information for your photos.</p>  <ul style="list-style-type: none"> <li>• To improve GPS reception, avoid shooting in locations where the signal may be obstructed, such as between buildings or in low-lying areas, or in poor weather conditions.</li> <li>• Your location may appear on your photos when you upload them to the Internet. To avoid this, deactivate the GPS tag setting.</li> </ul>
Image quality	Select a quality level for your photos.
Storage	Select a memory location for saving captured photos.
Reset	Reset camera settings.

## Record a video

- 1 In the application list, select **Camera**.
- 2 Rotate the device to the landscape view.
- 3 Drag the slider to switch to the camcorder.
- 4 Aim the lens at the subject and make any necessary adjustments.



Number	Function
1	<p>Use camcorder shortcuts.</p> <ul style="list-style-type: none"><li>• : Switch to the front camera to record a video of yourself.</li><li>• : Change the recording mode (for attaching to a message or for saving normally).</li><li>• : Select the length of the delay before the camcorder records a video.</li><li>• : Apply a special effect.</li><li>• : Adjust the exposure value to change the brightness.</li></ul> <p>You can add or remove shortcuts to frequently-used options. ► p. 79</p>

Number	Function
2	Change the camcorder settings.
3	View the storage location.
4	Switch to the camera.
5	Record a video.
6	View videos you have recorded.



To zoom in, place two fingers on the screen and slowly spread them apart. To zoom out, pinch them together. You can also zoom in or out with the Volume key. The zoom function may be unavailable when recording in the highest resolution.

5 Select  to start recording.









6 Select  to stop recording.

The video is saved automatically.



The camcorder may not be able to properly record videos on memory cards with slow transfer speeds.

After recording a video, select the image viewer to view it.

- To view more videos, scroll left or right.
- To play the video, select .
- To add the video to the favourites list, select .
- To send the video to others, select .
- To delete the video, select .
- To start a slide show, select  → **Slideshow** → **Start slideshow**. Tap the screen to stop the slide show.
- To change the name of a file, select  → **Rename**.
- To search for devices that have media sharing activated, select  → **Scan for nearby devices**.
- To view video details, select  → **Details**.

## › Customise camcorder settings

Before recording a video, select  to access the following options:

Option	Function
Edit shortcuts	Edit shortcuts to frequently-used options.
Self recording	Switch to the front camera to record a video of yourself.
Recording mode	Change the recording mode (for attaching to a message or for saving normally).
Effects	Apply a special effect.
Exposure value	Adjust the exposure value to change the brightness.
Timer	Select the length of the delay before the camcorder starts recording a video.
Resolution	Select a resolution option.
White balance	Adjust the colour balance according to the lighting conditions.
Guidelines	Set to view the grid lines on the preview screen.
Video quality	Select a quality level for your videos.
Storage	Select a memory location for saving recorded videos.
Reset	Reset camcorder settings.

## › Edit the shortcut icons

You can add or remove shortcuts to frequently-used options.

- 1 From the preview screen, select  → **Edit shortcuts**.
- 2 Tap and hold an icon from the option list, and then drag it to the shortcut area.  
To remove shortcuts, tap and hold an icon, and then drag it to the option list.
- 3 Tap the screen to return to the preview screen.

## Video Player

Learn to use the video player.



- Some file formats are not supported depending on the device's software.
- If a file size exceeds the memory available, an error may occur when you try to open the file.
- Playback quality may vary by content type.
- Some files may not play properly depending on how they are encoded.

## › Play a video

- 1 In the application list, select **Video Player**.
- 2 Select a video.

### 3 Control playback with the following keys:

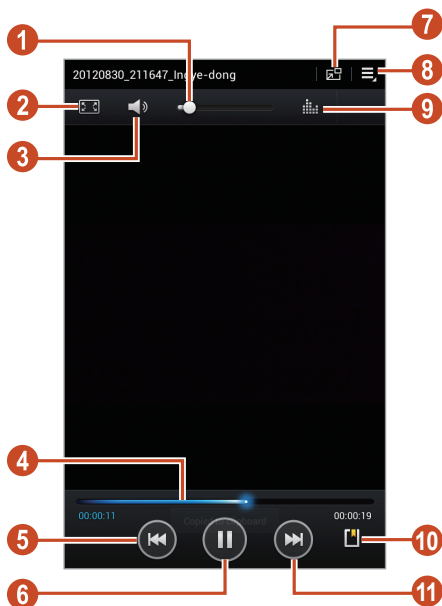

Number	Function
1	Adjust the volume.
2	Change the ratio of the video screen.
3	Mute the sound.
4	Scan forwards or backwards in the file by dragging or tapping the bar.
5	Restart playback; Skip to the previous file (tap within 3 seconds); Scan backwards in the file (tap and hold).
6	Pause playback; Select ▶ to resume playback.



Number	Function
7	Reduce the size of the video screen. To return to the original size, double-tap the video screen.
8	Access video player options.
9	Select a sound effect.
10	Insert a bookmark.
11	Skip to the next file; Scan forwards in the file (tap and hold).

During playback, select  to access the following options:

- To send the video to others, select **Share via**.
- To trim a segment of the video, select **Trim**.
- To listen to audio via a Bluetooth headset, select **Via Bluetooth**. You cannot use this option if you connect a headset to your device's headset jack.
- To edit the video with the video editor, select **Video Maker**.
- To view your bookmarks, select **Bookmarks**. This option appears if you have inserted a bookmark during playback.
- To view video details, select **Details**.
- To set the video player to turn off automatically after a specific period of time, select **Time set for auto video off**.
- To search for devices that have media sharing activated, select **Scan for nearby devices**.
- To change the video player settings, select **Settings**.

# Gallery

Learn to view images and play videos saved in your device.









- Some file formats are not supported depending on the device's software.
- If a file size exceeds the memory available, an error may occur when you try to open the file.
- Playback quality may vary by content type.
- Some files may not play properly depending on how they are encoded.











## › View an image

1 In the application list, select **Gallery**.

2 Select a folder → an image.

While viewing an image, use the following options:

- To view more images, scroll left or right.
- To zoom in or out, place two fingers on the screen and slowly spread them apart or pinch them together. To return to the original size, double-tap the screen.
- To add the image to the favourites list, select .
- To send the image to others, select .
- To delete the image, select .
- To start a slide show, select  → **Slideshow** → **Start slideshow**. Tap the screen to stop the slide show.
- To register the faces in the image as face tags, select  → **Face tag**. ► p. 83
- To add the image to the clipboard, select  → **Copy to clipboard**.

- To rotate the image anti-clockwise, select  → **Rotate left**.
- To rotate the image clockwise, select  → **Rotate right**.
- To crop a section from the image, select  → **Crop**.
- To edit the image with the image editor, select  → **Edit**.  
▶ p. 85
- To set the image as your wallpaper or a contact image, select  → **Set as**.
- To send the image to a person whose face is tagged in the photo, select  → **Buddy photo share**.
- To print the image via Wi-Fi or USB, select  → **Print**. Your device is compatible only with some Samsung printers.
- To change the name of a file, select  → **Rename**.
- To search for devices that have media sharing activated, select  → **Scan for nearby devices**.
- To view image details, select  → **Details**.



The options available may vary depending on the selected folder.

## › Tag a face in an image

Learn to tag faces in your images to make calls, send messages, and upload messages to social networks with the face tag shortcuts.





Face recognition may fail depending on face angle, face size, skin colour, facial expression, light conditions, or accessories the subject is wearing.

- 1 In the application list, select **Gallery**.
- 2 Select an image.

- 3 Select  → **Face tag** → **On**.  
Recognised faces appear in the frame. If faces are not recognised automatically, tap and hold a face area to add a frame manually.
- 4 Select a recognised face → **Add name**.
- 5 Select the person's name from the contact list.  
The contact is linked to the face in the image. When the face tag appears with a name, select the face tag and use the available options.

## ▶ Play a video





- 1 In the application list, select **Gallery**.
- 2 Select a folder → a video (indicated by the  icon).
- 3 Select  to begin playback.
- 4 Control playback with the keys. ▶ p. 79



During playback, select  to access the following options:

- To send the video to others, select **Share via**.
- To trim a segment of the video, select **Trim**.
- To listen to audio via a Bluetooth headset, select **Via Bluetooth**. You cannot use this option if you connect a headset to your device's headset jack.
- To edit the video with the video editor, select **Video Maker**.
- To view your bookmarks, select **Bookmarks**. This option appears if you have inserted a bookmark during playback.
- To view video details, select **Details**.
- To search for devices that have media sharing activated, select **Scan for nearby devices**.
- To change the video player settings, select **Settings**.

## Photo Editor

You can edit images and apply various effects.

- 1 In the application list, select **Photo Editor**.
- 2 Select an image, or select **Select picture** → a folder → an image.  
To take a new photo, select **Take picture**.
- 3 Select **Selection** → **OK**.
- 4 Draw a border around the area you want to select, and then select 
  - To change the type of selection tool, select **Selection**.
  - To edit the selection border, select , , or . If you select **Magnetic** or **Brush**, you can adjust the border size by selecting **Selection size**.
  - To reverse the selection, select **Inverse**.
- 5 Edit the image with the following tools:

Tool	Function
Rotate	Rotate or flip the image.
Resize	Resize the image by dragging the rectangle or selecting <b>100%</b> → an option.
Crop	Crop the image by moving or dragging the rectangle.
Colour	Apply a colour effect.
Effect	Apply a filter effect.
Tools	Use additional tools.
	Undo your last action.
	Redo your last action.

- 6 When you are finished, select .
- 7 Enter a name for the image and select **OK**.

## Video Editor

You can edit videos and apply various effects.

### › Create a video

- 1 In the application list, select **Video Editor**.
- 2 Rotate the device to the landscape view.
- 3 Select a frame theme.
- 4 Select **Add media**.
- 5 Select a category in the left panel and then select images, videos, and audios to make video, and then **Done**.
  - To set the length of time that an image appears, select the thumbnail, and then drag the left or right border of the thumbnail.
  - To delete images or videos, tap and hold an item, and then drag it to the rubbish bin.
  - To rearrange images or videos, tap and hold an item, and then drag it to a new location.
- 6 Select a transition effect icon between images or videos and select an effect.
- 7 When you are finished, select  → **Export**.
- 8 Select a resolution option.
- 9 Enter a name for the video and select **OK**.

## › Trim a segment of a video

- 1 Launch the video editor and open a video file.
- 2 Select the thumbnail.
- 3 Move the start bracket to the point where trimming should begin.
- 4 Move the end bracket to the point where the trimming should end.
- 5 Save the edited video.

## › Split a video

- 1 Launch the video editor and open a video file.
- 2 Select the thumbnail.
- 3 Drag the thumbnail at the bottom of the screen to place the yellow line.
- 4 Select .
- 5 Save the edited video.

## › Apply an effect to a video

- 1 Launch the video editor and open a video file.
- 2 Drag the thumbnail at the bottom of the screen to place the yellow line.
- 3 Select **Effect** → an effect option.
- 4 Save the edited video.

# Music Player

Learn to listen to your favourite music while on the go.



- Some file formats are not supported depending on the device's software.
- If a file size exceeds the memory available, an error may occur when you try to open the file.
- Playback quality may vary by content type.
- Some files may not play properly depending on how they are encoded.

## › Add music files to your device

Start by transferring files to your device or memory card:

- Download from the Internet. ► p. 40
- Download from a computer with Samsung Kies. ► p. 99
- Download from a computer with Windows Media Player. ► p. 100
- Receive via Bluetooth. ► p. 112

## › Play music

- 1 In the application list, select **Music Player**.
- 2 Select a music category → a music file.
- 3 Select the album image to open the music player screen.



#### 4 Control playback with the following keys:



Number	Function
1	Adjust the volume.
2	Set the file as your favourite track.
3	Mute the sound.
4	Scan forwards or backwards in the file by dragging or tapping the bar.
5	Activate Shuffle mode.
6	Restart playback; Skip to the previous file (tap within 2 seconds); Scan backwards in the file (tap and hold).

Number	Function
7	Pause playback; Select  to resume playback.
8	View music details.
9	Open the playlist.
10	Access music options.
11	Select a sound effect.
12	Change the repeat mode.
13	Skip to the next file; Scan forwards in the file (tap and hold).



You can control the music player with a headset. On the Home screen, press and hold the headset button to launch the music player. Then, press the headset button to start or pause playback.

During playback, select  to access the following options:

- To add the music file to a playlist, select **Add to playlist**.
- To listen to music via a Bluetooth headset, select **Via Bluetooth**. You cannot use this option if you connect a headset to your device's headset jack.
- To send the music file to others, select **Share via**.
- To set the music file as your ringtone, select **Set as**.
- To search for devices that have media sharing activated, select **Scan for nearby devices**.
- To change the music player settings, select **Settings**.

## › Create a playlist

- 1 In the application list, select **Music Player**.
- 2 Select  → **New playlist**.
- 3 Enter a title for your new playlist and select **OK**.
- 4 Select a music category.
- 5 Select the files to include and select **Done**.

## › Customise music player settings

- 1 In the application list, select **Music Player**.
- 2 Select  → **Settings**.
- 3 Change the following options:

Option	Function
Advanced → SoundAlive	Select a sound effect.
Advanced → Play speed	Change the playback speed.
Advanced → Lyrics	Set to show song lyrics during playback.
Advanced → Music auto off	Set the music player to turn off automatically after a specific period of time.
Music menu	Select music categories to show in the music library.

## Music Hub

You can access the online music store to search for and buy your favourite songs. You can also add music files to your wish list and play them.



This feature may be unavailable depending on your region or service provider.

- 1 In the application list, select **Music Hub**.
- 2 Search for, preview, or buy your favourite songs.

# Personal information

## Contacts

Learn to create and manage a list of your personal or business contacts. You can save names, phone numbers, email addresses, and more for your contacts.

### › Create a contact

- 1 In the application list, select **Contacts** → **Contacts** → .
- 2 Select a memory location.
- 3 Enter contact information.
- 4 Select **Save** to add the contact to memory.









You can create contacts from the dialling screen by selecting .

### › Find a contact

- 1 In the application list, select **Contacts** → **Contacts**.
- 2 Scroll up or down the contact list.
- 3 Select a contact's name.

From the contact view, use the following options:

- To make a voice call, select .
- To make a video call, select .
- To send a text or multimedia message, select .
- To send an email message, select .
- To set a favourite number, select .
- To edit the contact information, select  → **Edit**.



## › Set a speed dial number

- 1 In the application list, select **Contacts** → **Contacts**.
- 2 Select  → **Speed dial setting**.
- 3 Select a location number → a contact.

 You can call a speed dial number by tapping and holding the location number on the dialling screen.

## › Create your namecard

- 1 In the application list, select **Contacts** → **Contacts**.
- 2 Select your name at the top of the contact list.
- 3 Select  → **Edit**.
- 4 Enter your personal details and select **Save**.

 You can send your namecard to others by selecting  → **Share namecard via**.

## › Create a group of contacts

By creating groups of contacts, you can manage multiple contacts and send a message to an entire group.

- 1 In the application list, select **Contacts** → **Contacts** → **Groups** → .
- 2 Enter a name and customise the settings for the group.
- 3 Add members to the group.
- 4 Select **Save**.

## › Copy a contact

### Copy contacts from the SIM or USIM card to your device

- 1 In the application list, select **Contacts** → **Contacts**.
- 2 Select  → **Import/Export** → **Import from SIM card**.
- 3 Select a memory location.
- 4 Select contacts to copy, and then select **Done**.

### Copy contacts from your device to the SIM or USIM card

- 1 In the application list, select **Contacts** → **Contacts**.
- 2 Select  → **Import/Export** → **Export to SIM card**.
- 3 Select contacts to copy, and then select **Done** → **OK**.

## › Import or export a contact

You can import or export files (in vcf format) to or from your device's USB storage or a memory card.

### Import contact files

- 1 In the application list, select **Contacts** → **Contacts**.
- 2 Select  → **Import/Export** → **Import from SD card** or **Import from USB storage**.
- 3 Select a memory location.
- 4 Select an option for importing a single contact file, multiple contact files, or all contact files, and then select **OK**.
- 5 Select contact files to import, and then select **OK**.

## Export contacts

- 1 In the application list, select **Contacts** → **Contacts**.
- 2 Select  → **Import/Export** → **Export to SD card** or **Export to USB storage**.
- 3 Select **OK** to confirm.

## S Planner

Your device includes a powerful planner to help you organise your schedules more conveniently and effectively. Learn to create and manage events and tasks, and set alarms to remind yourself of important events and tasks.

### › Create an event or task

- 1 In the application list, select **S Planner**.
- 2 Select .
- 3 Select an event type at the top of the screen.
- 4 Enter the details of the event and select **Save**.

### › Change the view mode

- 1 In the application list, select **S Planner**.
- 2 Select a view mode.
  - **Year**: All months in the year
  - **Month**: A full month in one view
  - **Week**: Hourly blocks for one full week



- **Day:** Hourly blocks for one full day
- **List:** A list of all the events and holidays scheduled for a specific period
- **Task:** A list of tasks



You can also change the view mode by placing two fingers on the screen and spreading them apart or pinching them together.

## › View an event or task

1 In the application list, select **S Planner**.

2 Select a date on the calendar.

- To move to a specific day, select  → **Go to** and enter the date.
- To move to today's date, select **Today**.

3 Select an event to view its details.



You can send the event to others by selecting  → **Share via**.

## › Stop an event or task alarm

If you set a reminder for a calendar event or task, an alarm will sound at the specified time.

1 Tap the right bottom of the system bar to open the notifications panel.

2 Select the event notification.

3 Select an event to view more details.

To snooze the event alarm, select **Snooze**.

# Memo

Learn to record important information for viewing at a later date.















## › Create a memo

- 1 In the application list, select **Memo**.
- 2 Select .
- 3 Enter your memo text.
- 4 Select **Done**.

## › View a memo

- 1 In the application list, select **Memo**.
- 2 Select a memo to view its details.

While viewing the memo, use the following options:

- To delete the memo, select   .
- To change the background colour, select   .
- To protect the memo from accidental deletion, select   .
- To print the memo via Wi-Fi or USB, select   . Your device is compatible only with some Samsung printers.
- To send the memo to others, select   .

# Connectivity

## USB connections

Learn to connect your device to a computer with a USB cable.

 Do not disconnect the USB cable from a computer while the device is transferring or accessing data. Doing so may result in data loss or damage to the device.

 For best results, connect the USB cable directly to a USB port on a computer. Data transfers may fail when using a USB hub.

### › Connect with Samsung Kies

Ensure that Samsung Kies is installed on your computer. You can download the program from the Samsung website.

 Samsung Kies will work on both Windows and Macintosh computers.

- 1 Connect your device to a computer with a USB cable. Samsung Kies launches on the computer automatically. If Samsung Kies does not launch, double-click the Samsung Kies icon on the computer.
- 2 Transfer files between your device and the computer. Refer to the Samsung Kies help for more information.

## › Connect with Windows Media Player

Ensure that Windows Media Player is installed on your computer.

- 1 Connect your device to a computer with a USB cable.
- 2 Open Windows Media Player and synchronise music files.

## › Connect as a media device

You can connect your device to a computer and access media files stored on your device.

- 1 Connect your device to a computer with a USB cable.
- 2 Tap the indicator icons area and drag it downwards to open the notifications panel.
- 3 Select **Connected as a media device** → **Media device (MTP)**.
- 4 Transfer files between your device and the computer.

## › Connect as a camera device

You can connect your device to a computer as a camera and access files in your device.



Use this USB connection mode when your computer does not support the media transfer protocol (MTP) or does not have the USB driver for your device installed.

- 1 Connect your device to a computer with a USB cable.
- 2 Tap the indicator icons area and drag it downwards to open the notifications panel.
- 3 Select **Connected as a media device** → **Camera (PTP)**.
- 4 Transfer files between your device and the computer.

## Wi-Fi

Learn to use your device's wireless networking capabilities to activate and connect to any wireless local area network (WLAN) compatible with the IEEE 802.11 standards.

You can connect to the Internet or other network devices anywhere an access point or wireless hotspot is available.



Your device uses a non-harmonised frequency and is intended for use in all European countries. The WLAN can be operated in the EU without restriction indoors, but cannot be operated outdoors.

### › Activate the Wi-Fi feature

In the application list, select **Settings** and then drag the **Wi-Fi** switch to the right.



The Wi-Fi feature running in the background will consume battery power. To preserve battery power, activate the feature only when needed.

### › Find and connect to a Wi-Fi AP

- 1 In the application list, select **Settings** → **Wi-Fi**.  
Your device searches for available Wi-Fi APs automatically.
- 2 Select an AP.
- 3 Enter the password for the AP (if necessary).
- 4 Select **Connect**.

## ➤ Add a Wi-Fi AP manually

- 1 In the application list, select **Settings** → **Wi-Fi** → **Add Wi-Fi network**.
- 2 Enter an SSID for the AP and select a security type.
- 3 Set the security settings according to the security type you selected, and then select **Save**.

## ➤ Connect to a Wi-Fi AP with a protected setup

You can connect to a secured AP with a WPS button or WPS PIN. To use this method, your wireless access point must have a WPS button.

### Connect with a WPS button

- 1 In the application list, select **Settings** → **Wi-Fi**.
- 2 Select  → **WPS push button**.
- 3 Press the WPS button on the AP within 2 minutes.

### Connect with a WPS PIN

- 1 In the application list, select **Settings** → **Wi-Fi**.
- 2 Select  → **WPS PIN entry**.
- 3 On the AP, enter the PIN of your device.

## › Set the static IP settings

- 1 In the application list, select **Settings** → **Wi-Fi**.
- 2 Select an AP → **Show advanced options**.
- 3 Select the **IP settings** drop-down menu.
- 4 Select **Static**.
- 5 Change the IP settings.
- 6 Select **Connect**.

## › Customise Wi-Fi settings

- 1 In the application list, select **Settings** → **Wi-Fi** →  → **Advanced**.
- 2 Change the following options:

Option	Function
Network notification	Set the device to notify you when an open Wi-Fi AP is available.
Keep Wi-Fi on during sleep	Set whether or not to keep the Wi-Fi feature active in Sleep mode.
MAC address	View the MAC address.
IP address	View the IP address.

# Wi-Fi Direct

Learn to use the Wi-Fi Direct feature to connect two devices via Wi-Fi without requiring an AP.

## › Connect your device to another device

- 1 In the application list, select **Settings** → **Wi-Fi** → **Wi-Fi Direct**.
- 2 Select **Scan**.
- 3 Select a device.  
When the owner of the other device accepts the connection, the devices are connected.



You can connect your device to multiple devices and send data by selecting **Multi-connect**.

## › Send data via Wi-Fi

- 1 Select a file or item from an appropriate application.
- 2 Select an option for sending data via Wi-Fi.



The method for selecting an option may vary by data type.

- 3 Search for and select another device.

## › Receive data via Wi-Fi

When you receive data, it is saved to your device automatically. Received data is saved to the ShareViaWifi folder.



# AllShare Play

Learn to use the AllShare Play service that enables you to play contents saved on various devices over the Internet. You can play and send any file on any device to another device or web storage server via AllShare Play.

To use the AllShare Play service, you must sign in to your Google and Samsung accounts, and register two or more devices as file servers. The registration methods may vary depending on the device type. To get more details about using AllShare Play, select  → **Settings** → **Customer support**.



This feature may be unavailable depending on your region or service provider.

## › Send a file

- 1 In the application list, select **AllShare Play**.
- 2 Select a device or web storage that contains media files.
- 3 Select a media category and select the tick box on a file.
- 4 Select .
- 5 Select a device or web storage to save the file.

## › Share a file

- 1 In the application list, select **AllShare Play**.
- 2 Select a device or web storage that contains media files.
- 3 Select a media category and select the tick box on a file.
- 4 Select  and then select a social network site.

## › Play a file on a remote device



- Supported file formats may differ depending on connected devices as a media player.
- Some files may be buffered while playing depending on the network connection.

- 1 In the application list, select **AllShare Play**.
- 2 Select a device or web storage that contains media files.
- 3 Select a media category and select the tick box on a file.
- 4 Select .
- 5 Select a device to use as a media player.
- 6 Control playback with the keys on your device.

## › Use the Group Play feature

You can share screens with multiple other devices that are connected to the same Wi-Fi AP.

- 1 In the application list, select **AllShare Play**.
- 2 Select a media category and select the tick box on a file.
- 3 Select  → **Group Play**.
- 4 Enter a PIN and select **Done**.
- 5 Select **OK** to start Group Play.
- 6 On another device, join Group Play with the PIN.

## › Manage contents on a web storage server

- 1 In the application list, select **AllShare Play**.
- 2 Select a web storage server.
- 3 View and manage your files.

## › Customise AllShare Play settings

- 1 In the application list, select **AllShare Play**.
- 2 Select  → **Settings**.
- 3 Change the following options:

Option	Function
Registered storages	View web storage servers that have been added to AllShare Play.
Registered devices	View or edit devices that have been added to AllShare Play.
Setting up web services	Sign in to social network sites to upload files.
Auto upload photos from mobile	Set to upload photos to the web storage automatically when you sign in.
Video quality settings	Set to optimise the video quality for your device when playing videos saved on a computer.
Lock AllShare Play	Set to lock AllShare Play with the password for your Samsung account.
Language	Select a display language.
About	View AllShare Play information.

# Mobile network sharing

Learn to share your device's mobile network connection with other devices.

## ➤ Share your device's mobile network via Wi-Fi

Learn to use your device as a wireless access point for other devices.



This feature may be unavailable depending on your region or service provider.

- 1 In the application list, select **Settings** → **More settings** → **Tethering and portable hotspot** → **Portable Wi-Fi hotspot**.
- 2 Drag the **Portable Wi-Fi hotspot** switch to the right to activate mobile network sharing via Wi-Fi.
- 3 Select **Configure** to configure network settings to use your device as an AP.

Option	Function
Network SSID	Edit the device name that will be shown to other devices.
Hide my device	Set to prevent other devices from locating your device.
Security	Select a security type.
Password	Enter a password to prevent unapproved access to your mobile network. This option is available only when you set the security option.

Option	Function
Show password	Set to show your password as you enter them.
Show advanced options	Select a broadcast channel.

- 4 Select **Save**.
- 5 On another device, locate your device's name and connect to your mobile network.

 You can restrict mobile network sharing to specified devices. Select **Allowed devices**, create a device list, and then select your device's name to change the sharing mode to **Only allowed devices**.

## ► Share your device's mobile network via USB

Learn to use your device as a wireless modem by making a USB connection with a computer.

- 1 Connect your device to a computer with a USB cable.
- 2 In the application list, select **Settings** → **More settings** → **Tethering and portable hotspot**.
- 3 Select **USB tethering** to activate mobile network sharing via USB.

To stop sharing the network connection, clear the tick box next to **USB tethering**.

 The sharing method may differ depending on the computer's operating system.

## › Share your device's mobile network via Bluetooth

- 1 In the application list, select **Settings** → **More settings** → **Tethering and portable hotspot**
- 2 Select **Bluetooth tethering** to activate the mobile network sharing via Bluetooth.
- 3 On another device, find and pair with your device. Ensure that you have activated the Bluetooth feature and the visibility setting.

## Bluetooth

Learn to exchange data or media files with other devices via Bluetooth.



- Samsung is not responsible for the loss, interception, or misuse of data sent or received via the Bluetooth feature.
- Always ensure that you share and receive data with devices that are trusted and properly secured. If there are obstacles between the devices, the operating distance may be reduced.
- Some devices, especially those that are not tested or approved by the Bluetooth SIG, may be incompatible with your device.
- Do not use the Bluetooth feature for illegal purposes (for example, pirating copies of files or illegally tapping communications for commercial purposes). Samsung is not responsible for the repercussions of illegal use of the Bluetooth feature.

## › Activate the Bluetooth feature

In the application list, select **Settings** and then drag the **Bluetooth** switch to the right.

## › Find and pair with another device

- 1 In the application list, select **Settings** → **Bluetooth** → **Scan**.
- 2 Select a device.
- 3 Select **OK** to match the Bluetooth PIN between two devices. Alternately, enter a Bluetooth PIN and select **OK**. When the owner of the other device accepts the connection or enters the same PIN, pairing is complete. If the pairing is successful, the device will search for available services automatically.



Some devices, especially headsets or hands-free car kits, may have a fixed Bluetooth PIN, such as 0000. If the other device has a PIN, you must enter it.

## › Send data via Bluetooth

- 1 Select a file or item from an appropriate application.
- 2 Select an option for sending data via the Bluetooth feature.



The method for selecting an option may vary by data type.

- 3 Search for and pair with a Bluetooth device.

## › Receive data via Bluetooth

1 In the application list, select **Settings** → **Bluetooth** and then select the tick box next to your device.



To select the length of time that your device will be visible, select  → **Visible time-out**.

2 When prompted, select **OK** to match the Bluetooth PIN or enter the Bluetooth PIN and select **OK** (if necessary).

3 Select **Accept** to confirm that you are willing to receive data.

Received data is saved to the bluetooth folder. If you receive a contact, it is saved to the phonebook automatically.

## GPS

Your device is equipped with a global positioning system (GPS) receiver. Learn to activate location services and use additional GPS functions.

For better reception of GPS signals, avoid using your device in the following conditions:

- Between buildings, in tunnels or underground passages, or inside buildings
- In poor weather
- Around high voltage or electromagnetic fields
- In a vehicle with sun protection film



Do not touch or cover the area around the antenna with your hands or other objects while using the GPS functions.



This feature may be unavailable depending on your region or service provider.



## › Activate location services

You must activate location services to receive location information or search the map.

- 1 In the application list, select **Settings** → **Location services**.
- 2 Change the following options:

Option	Function
Use wireless networks	Set to use Wi-Fi and/or mobile networks to find your location.  You may incur additional charges for using mobile networks.
Use GPS satellites	Set to use GPS satellites to find your location.
Location and Google search	Set the device to use your current location for Google search and other Google services.

## VPN connections

Learn to create virtual private networks (VPNs) and connect to them securely over the Internet.

-  • Your device should already be configured with Internet access. If you have trouble accessing the Internet, you must edit the connections. If you are not sure what information to enter, ask your VPN administrator.
- To use this feature, you must activate the screen lock feature.

## › Set up a VPN profile

- 1 In the application list, select **Settings** → **More settings** → **VPN** → **Add VPN network**.
- 2 Change the following options:

Option	Function
Name	Enter a name for the VPN server.
Type	Select a VPN type.
Server address	Enter the IP address of the VPN server.
L2TP secret	Enter an L2TP secret password.
IPSec identifier	Enter a user name.
IPSec pre-shared key	Enter a pre-shared security key.
IPSec user certificate	Select a user certificate that the VPN server will use to identify you. You can import certificates from the VPN server or download them from the Internet.
IPSec CA certificate	Select a certificate authority (CA) certificate that the VPN server will use to identify you. You can import certificates from the VPN server or download them from the Internet.
IPSec server certificate	Select a server certificate that the VPN server will use to identify you. You can import certificates from the VPN server or download them from the Internet.

Option	Function
PPP encryption (MPPE)	Set to encrypt data before sending it to the VPN server.
Show advanced options	Set to change the advanced network settings.



The options available may vary depending on the VPN type.

3 When you are finished, select **Save**.

## ▶ Connect to a private network

- 1 In the application list, select **Settings** → **More settings** → **VPN**.
- 2 Select a private network.
- 3 Enter the user name and password, and then select **Connect**.

# Tools

## Alarm

Learn to set and control alarms for important events.



### › Set an alarm

1 In the application list, select **Alarm**.

2 Select **+**.



3 Set the details of the alarm.

4 When you are finished, select **Done**.

 To deactivate an alarm, select the clock icon next to the alarm. To delete an alarm, select .

### › Stop an alarm

When the alarm sounds,

- To stop the alarm, select  and then drag your finger outside of the large circle.
- To silence the alarm for the snooze period, select  and then drag your finger outside of the large circle.

## Calculator

Learn to perform calculations with your device.

### › Perform a calculation

- 1 In the application list, select **Calculator**.
  - 2 Use the keys on the screen to perform basic calculations.
-  Rotate the device to the landscape view to use the scientific calculator.

### › View the calculation history

- 1 In the application list, select **Calculator**.
- 2 Perform a calculation.
- 3 Select  to hide the calculator keypad.  
The calculation history appears.

## Downloads

Learn to manage logs of files you have downloaded from the web or email.

- 1 In the application list, select **Downloads**.
- 2 Select a download category.
- 3 To open a downloaded file, select the log.  
To delete a log, select the tick box and select .



# Dropbox

Learn to use the Dropbox cloud storage service to save and share your files with others. When you save files to your Dropbox folder, your device automatically synchronise with the web server and any other computers that have Dropbox installed.

## › Activate Dropbox

- 1 In the application list, select **Dropbox** → **Start**.
- 2 Enter an email address and password, and then select **Log in**.  
If you are a new user, select **New to Dropbox? Create a free account** to create an account.
- 3 Select **Next**.
- 4 Select **Turn on** to automatically upload photos and videos captured by the camera on your device.

## › Upload files to your Dropbox folder

- 1 In the application list, select **Dropbox**.
- 2 Select  →  → **Upload here** → **Photos or videos** or **Other files**.
- 3 Select files.
- 4 Select **Upload**.  
The files in the folder will be added to the web server and your computer at home.

## › View a file

- 1 In the application list, select **Dropbox** → .
- 2 Select a file.

## My Files

Learn to access various types of files saved in your device.

## › Supported file formats



Your device supports the following file formats:

Type	Format
Image	bmp, gif, jpg, png
Video	avi, 3gp/mp4, wmv, flv, mkv, webm
Music	flac, mp3, wma, aac, ogg, amr, wav, mid, xmf, imy
Sound	amr-nb/wb, wav, mid, midi, xmf, mxmf, i-melody (imy), sp-midi, rtttl/rtx, ota
Others	doc, docx, pdf, ppt, pptx, txt, xls, xlsx, htm, html, vcf, vcs, vnt













- Some file formats are not supported depending on the device's software.
- If a file size exceeds the memory available, an error may occur when you try to open the file.

## › View a file

- 1 In the application list, select **My Files**.
- 2 Select a folder.
  - To move up one level in the file directory, select .
  - To return to the Home directory, select .
- 3 Select a file.

From the folder list, access the following options:

- To search for files saved in your device, select .
- To view the files in the thumbnail view, select .
- To create folders for managing files, select .
- To change the file manager settings, select  → **Settings**.
- To sort files or folders, select the **Name** drop-down menu and select an option.
- To send a file to others, select the tick box and select .
- To copy or move the files or folders to another file folder, select the tick boxes and select  or .
- To delete files or folders, select the tick boxes and select .
- To change the name of a file or a folder, select the tick box and select  → **Rename**.
- To view file or folder details, select the tick box and select  → **Details**.

## Polaris Office



Learn to create or view documents with your device.



This feature may be unavailable depending on your region or service provider.









## › Create a document

- 1 In the application list, select **Polaris Office**.
- 2 Select  → a document type.
- 3 Select a template (if necessary).
- 4 Create the document.
- 5 When you are finished, select  → **Save**.
- 6 Enter a name for the document and select a memory location for saving the document, and then select **Save**.

## › Open a document

- 1 In the application list, select **Polaris Office**.
- 2 Select **Browser** → a document file.  
To open a recently-used file, select a file under **Recent documents**.
- 3 View the document.

From the document view, access the following options:

- To zoom in or out, place two fingers on the screen and slowly spread them apart or pinch them together.
- To undo your last action, select .
- To redo your last action, select .
- To add an item to the document, select .
- To open the editing toolbar, select .
- To search for text in a Text document, select .
- To use additional options with the document, select .





The options available may vary depending on the document type.

## › Manage documents online

- 1 In the application list, select **Polaris Office**.
- 2 Select **Clouds** → **Add account** → a cloud service.
- 3 Enter your email address and password to access your account, and then select **OK**.
- 4 View and manage your documents on the server.

## Google

Learn to search for data in your device or information on the Internet.

- 1 In the application list, select **Google**.
- 2 Enter a keyword and select .  
To search for data by voice, select  and say a keyword into your device's microphone.
- 3 Select a search result.

## SIM Toolkit

Use a variety of additional services offered by your service provider. Depending on your SIM or USIM card, this application may be labelled differently. In the application list, select **SIM Toolkit**.

# World Clock

Learn to view the time in another region and set world clocks to appear on your display.

1 In the application list, select **World Clock** → .

2 Enter a city name or select one from the globe.

3 Select .

 To apply summer time to the clock, tap and hold the clock, and then select **DST settings**.

# Settings

## Access the setting options

- 1 In the application list, select **Settings**.
- 2 Select a setting category, and then select an option.

## Wi-Fi

Activate the Wi-Fi feature to connect to a Wi-Fi AP and access the Internet or other network devices.

To use options, select .

- **Advanced:** Customise Wi-Fi settings.
- **WPS push button:** Connect to a secured Wi-Fi AP with a WPS button.
- **WPS PIN entry:** Connect to a secured Wi-Fi AP with a WPS PIN.

## Bluetooth

Activate the Bluetooth feature to exchange information over short distances.

## Data usage

Keep track of your data usage amount, and customise the settings for the limitation.

- **Mobile data:** Set to use data connections on any mobile network.
- **Set mobile data limit:** Set a limit for the mobile data usage.
- **Data usage cycle:** Enter monthly reset date to monitor your data usage.

## More settings

Change the settings to control connections with other devices or networks.

### › Flight mode

Activate Flight mode to disable all wireless functions on your device. You can use only non-network features.

### › Mobile networks

- **Mobile data:** Set to use data connections on any mobile network.
- **Data roaming:** Set to use data connections when you are roaming.
- **Access Point Names:** Select an access point name (APN) for mobile networks. You can add or edit APNs. To reset your APN settings to the factory defaults, select  → **Reset to default.**

- **Network mode:** Select a network type.
- **Network operators:**
  - **Search networks:** Search for and select a network.
  - **Select automatically:** Set the device to select the first available network.

## › Tethering and portable hotspot

- **Portable Wi-Fi hotspot:** Set to use your device as a wireless access point for other devices.
- **USB tethering:** Set to use your device as a wireless modem by making a USB connection with a computer.
- **Bluetooth tethering:** Activate the Bluetooth tethering feature to share your mobile network with computers via Bluetooth.
- **Help:** View information about using the tethering features.

## › VPN

Set up and manage virtual private networks (VPNs).

## › Nearby devices

- **File sharing:** Activate media sharing to allow other DLNA certified devices to access media files on your device.
- **Shared contents:** Set to share your contents with other devices.
- **Device name:** Enter a media server name for your device.

- **Allowed devices list:** View the list of devices that can access your device.
- **Not-allowed devices list:** View the list of devices that are blocked from accessing your device.
- **Download to:** Select a memory location for saving downloaded media files.
- **Upload from other devices:** Set to accept uploads from other device.

## › Kies via Wi-Fi

Connect your device to Samsung Kies via Wi-Fi.

## Blocking mode

Select which notifications will be blocked or set to allow notifications for calls from specified contacts in Blocking mode.

## Sound

Change the settings for various sounds on your device.

- **Volume:** Adjust the volume for various sounds on your device.
- **Device ringtone:** Select a ringtone to alert you to incoming calls.
- **Device vibration:** Add or select a vibration pattern.

- **Default notifications:** Select a ringtone to alert you to events.
- **Sound and vibration:** Set the device to vibrate and play a ringtone to alert you to incoming calls.
- **Keytones:** Set the device to sound when you enter numbers on the dialling screen.
- **Touch sounds:** Set the device to sound when you select an application or option.
- **Screen lock sound:** Set the device to sound when you lock or unlock the touch screen.

## Display

Change the settings to control the display and backlight on your device.

- **Wallpaper:**
  - **Home screen:** Select a background image for the Home screen.
  - **Lock screen:** Select a background image for the locked screen.
  - **Home and lock screens:** Select a background image for the Home screen and the locked screen.
- **Brightness:** Adjust the brightness of the display.
- **Screen timeout:** Select the length of time that the device waits before turning off the display backlight.
- **Smart stay:** Set to prevent the display backlight from turning off while you are looking at the display.
- **Font style:** Change the font type for the display text.
- **Font size:** Change the font size for creating or showing items in applications.
- **Battery percentage:** Set to view the remaining battery life.



## Storage

View memory information for your device and memory card. You can also format the memory card.

 Formatting a memory card will permanently delete all data from the memory location.

 The actual available capacity of the internal memory is less than the specified capacity because the operating system and default applications occupy part of the memory.

## Power saving

Activate Power saving mode and change the settings for Power saving mode.

- **CPU power saving:** Set the device to limit some system resource usage.
- **Screen power saving:** Set the device to decrease the brightness of the display.
- **Learn about power saving:** View information for saving battery power.

## Battery

View the amount of battery power consumed by your device.

## Applications manager

View and manage the applications on your device.

## Location services

Change the settings for location services.

- **Use wireless networks:** Set to use Wi-Fi and/or mobile networks for finding your location.
- **Use GPS satellites:** Set to use GPS satellites for finding your location.
- **Location and Google search:** Set the device to use your current location for Google search and other Google services.

## Lock screen

Change the settings for securing your device.

- **Screen lock:** Activate the screen lock feature.
- **Lock screen options:**



The settings are applied only when you set the swipe lock option.

- **Shortcuts:** Set to show and edit application shortcuts on the locked screen.



This feature may be unavailable depending on your region or service provider.

- **Information ticker:** Set to show news or stock information on the locked screen.



This feature may be unavailable depending on your region or service provider.

- **Clock:** Set to show the clock on the locked screen.
- **Dual clock:** Set to show the dual clock on the locked screen.

- **Weather:** Set to show the weather information and change the settings for the weather display.
- **Help text:** Set to show the help text on the locked screen.
- **Owner information:** Enter your information that is shown on the locked screen.

## Security

Change the settings for securing your device.

- **Encrypt device:** Set a password to encrypt data saved on the device. You must enter the password each time you turn on the device.



Charge the battery before enabling this setting because it may take more than an hour to encrypt your data.

- **Encrypt external SD card:**
  - **Encrypt:** Set to encrypt files when you save them to a memory card.
  - **Full encryption:** Set to encrypt all files on a memory card.
  - **Exclude multimedia files:** Set to encrypt all files on a memory card, except for media files.



If you reset your device to the factory defaults with this setting enabled, the device will not be able to read your encrypted files. Disable this setting before resetting the device.

- **Remote controls:** Set to allow remote control of your device via the Internet when your device is lost or stolen.
- **SIM Change Alert:** Activate the Find my mobile feature.
- **Find my mobile web page:** Access the SamsungDive website ([www.samsungdive.com](http://www.samsungdive.com)). You can track and control your lost or stolen device on the SamsungDive website.

- **Set up SIM card lock:**
  - **Lock SIM card:** Set to lock the SIM or USIM card. To use your device with the SIM or USIM card, you must enter the PIN.
  - **Change SIM PIN:** Change the PIN supplied with the SIM or USIM card.
- **Make passwords visible:** Set to show your passwords as you enter them.
- **Device administrators:** View the administrators you have approved for your device. You can allow device administrators to apply new policies to your device.
- **Unknown sources:** Set to download applications from any source. If you do not select this option, you can download applications only from Play Store.
- **Trusted credentials:** Set to use certificates and credentials to ensure the secure use of applications.
- **Install from device storage:** Install encrypted certificates that are saved on a memory card.
- **Clear credentials:** Delete credentials from the device and reset the password.

## Language and input

Change the settings for languages and text input.

### › Language

Select a display language.

### › Default

Select a text input method.

## › Google voice typing

Activate the Google voice input feature to enter text by voice. To change the voice input settings, select .

- **Choose input languages:** Select input languages for Google voice recognition.
- **Block offensive words:** Set to prevent the device from recognising offensive words in voice inputs.
- **Download offline speech recognition:** Download and install language data for offline voice input.

## › Samsung keyboard

To change the Samsung keypad settings, select .

- **Input language:** Select input languages to use with the keypad.
- **Predictive text:** Activate XT9 mode to predict words based on your input and show word suggestions.
- **Continuous input:** Set to enter text by sweeping on the keypad.
- **Advanced:**
  - **Auto capitalisation:** Set to capitalise the first letter of a sentence automatically.
  - **Auto-punctuate:** Set the device to insert a full stop when you double-tap the space bar.
  - **Character preview:** Set the device to show a preview image of each letter you tap.
  - **Key-tap sound:** Set the device to sound when you tap a key.
- **Tutorial:** View the tutorial for using the Samsung keypad.
- **Reset settings:** Reset the Samsung keypad settings to the factory defaults.

## › Voice search

- **Language:** Select a language for Google voice recognition.
- **Speech output:** Set the device to provide voice feedback to alert you to the current action.
- **Block offensive words:** Set to hide offensive words from voice search results.
- **Download offline speech recognition:** Download and install language data for offline voice input.

## › Text-to-speech output

- **Preferred TTS engine:** Select a speech synthesis engine. To change the settings for speech synthesis engines, select .
- **Speech rate:** Select a speed for the TTS feature.
- **Listen to an example:** Listen to the spoken text for an example.
- **Driving mode:** Activate Driving mode to provide audible notifications for event details.

## › Pointer speed

Adjust the pointer speed for the mouse or trackpad connected to your device.

## Cloud

Change settings for synchronising data or files with your Samsung account.

## Back up and reset

Change the settings for managing settings and data.

- **Back up my data:** Set to back up your settings and application data to the Google server.
- **Backup account:** Set up or edit your Google backup account.
- **Automatic restore:** Set to restore your settings and application data when you must reinstall an application.
- **Factory data reset:** Reset your settings to the factory defaults and delete all your data.

## Add account

Add your email or SNS accounts.

## Accessory

**Dock sound:** Set the device to play a sound when your device is connected to or removed from a desktop dock.

## Date and time

Change the settings to control how time and date appears on your device.



If the battery remains fully discharged or removed from the device, the time and date will be reset.

- **Automatic date and time:** Set to receive time information from the network and update the time and date automatically.
- **Set date:** Set the current date manually.
- **Set time:** Set the current time manually.
- **Automatic time zone:** Set to receive time zone information from the network when you move across time zones.
- **Select time zone:** Select a time zone.
- **Use 24-hour format:** Set to show the time in 24-hour format or 12-hour format.
- **Select date format:** Select a date format.

## Accessibility

Accessibility services are special features for those with physical challenges. Change the settings to improve accessibility to the device's interface and features.

- **Auto-rotate screen:** Set the interface to rotate automatically when you rotate the device.
- **Screen timeout:** Select the length of time that the device waits before turning off the display backlight.
- **Speak passwords:** Set the device to read aloud passwords you enter on websites with TalkBack.
- **The power key ends calls:** Set to end a call when you press the Power key.
- **Accessibility shortcut:** Add a shortcut to accessibility settings that appears when you press and hold the Power key.



- **TalkBack:** Activate TalkBack, which provides voice feedback.
- **Font size:** Change the font size in the calendar, email, phonebook, and memo applications.
- **Text-to-speech output:**
  - **Preferred TTS engine:** Select a speech synthesis engine. To change the settings for speech synthesis engines, select .
  - **Speech rate:** Select a speed for the TTS feature.
  - **Listen to an example:** Listen to the spoken text for an example.
  - **Driving mode:** Activate Driving mode to provide audible notifications for event details.
- **Enhance web accessibility:** Set applications to install web scripts to make their web content more accessible.
- **Mono audio:** Enable mono sound when you listen to audio with one earbud.
- **Turn off all sounds:** Mute all device sounds.
- **Tap and hold delay:** Set the recognition time for tapping and holding the screen.

## Developer options

Activate and change the settings for application development.

- **Desktop backup password:** Set a password to secure your backup data.
- **Stay awake:** Set the screen to remain on while you are charging the battery.

- **Protect SD card:** Set to request a confirmation when reading data from a memory card.
- **USB debugging:** Activate USB debugging mode to connect your device to a computer with a USB cable.
- **Allow mock locations:** Allow mock locations and service information to be sent to a Location Manager service for testing.
- **Select debug app:** Select applications to debug and prevent errors when you pause debugging.
- **Wait for debugger:** Set to prevent the selected application from loading until the debugger is ready.
- **Show touches:** Set to show the pointer when you touch the screen.
- **Show pointer location:** Set to show the coordinates and traces of the pointer when you touch the screen.
- **Show layout boundaries:** Set to show boundaries.
- **Show GPU view updates:** Set to flash areas of the screen when they are updated with the GPU.
- **Show screen updates:** Set to flash areas of the screen when they are updated.
- **Window animation scale:** Select a speed for opening and closing pop-up windows.
- **Transition animation scale:** Select a speed for switching between screens.
- **Animator duration scale:** Select how long pop-up windows will be shown.
- **Disable hardware overlays:** Set to hide hardware overlays.
- **Force GPU rendering:** Set to use 2D hardware acceleration to improve graphic performance.

- **Strict mode:** Set the device to flash the screen when applications perform long operations.
- **Show CPU usage:** Set to list all active processes.
- **Profile GPU rendering:** Set to check the time of GPU rendering time.
- **Enable traces:** Set to capture traces of application and system performance.
- **Do not keep activities:** Set to end a running application when you launch a new application.
- **Limit background processes:** Set to limit the number of processes that can run in the background.
- **Show all ANRs:** Set the device to alert you to unresponsive applications that are running in the background.

## About device

View information about your device, such as model number and version.



You can download and install firmware update with the firmware over-the-air (FOTA) service. To check for firmware updates, select **Software update** → **Update**.

# Troubleshooting

When you turn on your device or while you are using the device, it prompts you to enter one of the following codes:

Code	Try this to solve the problem:
Password	When the device lock feature is enabled, you must enter the password you set for the device.
PIN	When using the device for the first time or when the PIN requirement is enabled, you must enter the PIN supplied with the SIM or USIM card. You can disable this feature by using <b>Lock SIM card</b> .
PUK	Your SIM or USIM card is blocked, usually as a result of entering your PIN incorrectly several times. You must enter the PUK supplied by your service provider.
PIN2	When you access a menu requiring the PIN2, you must enter the PIN2 supplied with the SIM or USIM card. For details, contact your service provider.

## Your device displays network or service error messages

- When you are in areas with weak signals or poor reception, you may lose reception. Move to another area and try again.
- You cannot access some options without a subscription. Contact your service provider for more details.

## The touch screen responds slowly or improperly

If your device has a touch screen and the touch screen is not responding properly, try the following:

- Remove any protective covers from the touch screen. Protective covers may prevent the device from recognising your inputs and are not recommended for touch screen devices.
- Ensure that your hands are clean and dry when tapping the touch screen.
- Restart your device to clear any temporary software bugs.
- Ensure that your device's software is upgraded to the latest version.
- If the touch screen is scratched or damaged, take your device to a Samsung Service Centre.

## Your device freezes or has fatal errors

If your device freezes or hangs, you may need to close applications or reset the device to regain functionality. If your device is still responsive and an application is frozen, close the application with the task manager. If your device is frozen and unresponsive, press and hold the Power key for 8-10 seconds.

If this problem persists, perform a factory data reset. In the application list, select **Settings** → **Back up and reset** → **Factory data reset** → **Reset device** → **Erase everything**.

## Calls are being dropped

When you are in areas with weak signals or poor reception, you may lose your connection to the network. Move to another area and try again.

## Outgoing calls are not connected

- Ensure that you have pressed the Dial key.
- Ensure that you have accessed the correct cellular network.
- Ensure that you have not set call barring for the phone number you are dialling.

## Incoming calls are not connected

- Ensure that your device is turned on.
- Ensure that you have accessed the correct cellular network.
- Ensure that you have not set call barring for the incoming phone number.

## Others cannot hear you speaking on a call

- Ensure that you are not covering the built-in microphone.
- Ensure that the microphone is close to your mouth.
- If using a headset, ensure that it is properly connected.

## Audio quality is poor

- Ensure that you are not blocking the device's internal antenna.
- When you are in areas with weak signals or poor reception, you may lose reception. Move to another area and try again.

## When dialling from contacts, the call is not connected

- Ensure that the correct number is stored in the contact list.
- Re-enter and save the number, if necessary.
- Ensure that you have not set call barring for the contact's phone number.

## **The device beeps and the battery icon is empty**

Your battery is low. Recharge the battery to continue using the device.

## **The battery does not charge properly or the device turns off**

If the battery will no longer charge completely, you need to replace it with a new battery. Take your device to your local Samsung Service Centre.

## **Your device is hot if touched**

When you use applications that require more power or use applications on your device for an extended period of time, your device may feel hot. This is normal and should not affect your device's lifespan or performance.

## **Error messages appear when launching the camera**

Your device must have sufficient memory and battery power available to operate the camera application. If you receive error messages when launching the camera, try the following:

- Charge the battery.
- Free some memory by transferring files to a computer or deleting files from your device.
- Restart the device. If you are still having trouble with the camera application after trying these tips, contact a Samsung Service Centre.

## Error messages appear when opening music files

Some music files may not play on your device for a number of reasons. If you receive error messages when opening music files on your device, try the following:

- Free some memory by transferring files to a computer or deleting files from your device.
- Ensure that the music file is not Digital Rights Management (DRM)-protected. If the file is DRM-protected, ensure that you have the appropriate licence or key to play the file.
- Ensure that your device supports the file type.

## Another Bluetooth device is not located

- Ensure that the Bluetooth feature is activated on your device.
- Ensure that the Bluetooth feature is activated on the device you wish to connect to, if necessary.
- Ensure that your device and the other Bluetooth device are within the maximum Bluetooth range (10 m).

If the tips above do not solve the problem, contact a Samsung Service Centre.

## A connection is not established when you connect the device to a computer

- Ensure that the USB cable you are using is compatible with your device.
- Ensure that you have the proper drivers installed and updated on your computer.
- If you are a Windows XP user, ensure that you have Windows XP Service Pack 3 or higher installed on your computer.
- Ensure that you have Samsung Kies 2.0 or Windows Media Player 10 or higher installed on your computer.



# Index

alarms 116

AllShare Play 105

applications

closing 32

downloading 31

launching 30

multitasking 32

organising 30

uninstalling 31

auto rejection 56

battery

charging 15

Bluetooth 110

calculator 117

calendar

creating events 96

viewing events 97

calls

barring 58

forwarding 57

making 52

making international  
calls 53

making multiparty calls  
(conference calls) 55

rejecting 53

speed dialling 94

using in-call options 54, 55

viewing logs 58

waiting 58

camera

changing camcorder  
settings 78

changing camera  
settings 74

recording videos 76

taking photos 71

connectivity

AllShare Play 105

Bluetooth 110

GPS connections 112

mobile network

sharing 108

USB connections 99

VPN connections 113

Wi-Fi 101

contacts

copying/moving 95

creating 93

creating groups 94

finding 93

importing/exporting 95

setting speed dial 94

device lock 35

display

brightness 34

font style 33

language 32

settings 128

wallpaper 33

FDN mode 57

file manager 119

- find my mobile 37
- flight mode 20
- gallery 82
- Google+ 70
- Google Latitude 45
- Google Mail 64
- Google Maps 44
- Google Messenger 70
- Google Talk 68
- home screen
  - adding panels 29
  - moving items 28
  - removing items 28
  - removing panels 29
  - using the notifications panel 27
  - using widgets 29
- indicator icons 26
- Internet 40
- key functions 13
- maps
  - getting directions 46
  - searching for locations 44
  - searching for places nearby 47
  - sharing locations 45
  - using the navigation 46
- memory card
  - formatting 19
  - inserting 18
  - removing 19
- memos
  - creating 98
  - viewing 98
- messages
  - accessing voicemail 64
  - sending email 67
  - sending Google Mail 65
  - sending multimedia 63
  - sending text 63
  - viewing email 67
  - viewing Google Mail 65
  - viewing logs 58
  - viewing multimedia 64
  - viewing text 64
- multiparty calls (conference calls) 55
- music player 88
- photo editor 85
- photos
  - editing 85
  - taking 71
  - viewing 82
- Play Store 48
- Polaris Office 120
- power saving 17, 129
- Samsung Apps 49
- settings 124
- silent mode 33
- SIM/USIM card
  - inserting 14
  - locking 36

- sound
  - call ringtone 33
  - device volume 33
  - settings 127
  - touch tone 32
- task manager 32
- tethering
  - via Bluetooth 110
  - via USB 109
  - via Wi-Fi 108
- text input
  - copy and paste 39
  - with Google voice input 38
  - with Samsung keypad 38
- touch screen
  - locking/unlocking 24
  - using 21
- touch tone 32
- unpack 10
- USB connections
  - as camera device 100
  - as media device 100
  - as wireless modem 109
  - with Samsung Kies 99
  - with Windows Media Player 100
- video editor 86
- video player 79
- videos
  - playing 79,84
  - recording 76
  - uploading to YouTube 51
- VPN connections 113
- web browser 40
- Wi-Fi 101
- world clock 123
- YouTube 50

Some contents in this manual may differ from your device depending on the software of the device or your service provider.

### **To install Samsung Kies (PC Sync) Kies**

1. Download the latest version of Samsung Kies from the Samsung website ([www.samsung.com/kies](http://www.samsung.com/kies)) and install it on your computer.
2. Connect your device to a computer with a USB cable.  
Refer to the Samsung Kies help for more information.

## Free Manuals Download Website

<http://myh66.com>

<http://usermanuals.us>

<http://www.somanuals.com>

<http://www.4manuals.cc>

<http://www.manual-lib.com>

<http://www.404manual.com>

<http://www.luxmanual.com>

<http://aubethermostatmanual.com>

Golf course search by state

<http://golfingnear.com>

Email search by domain

<http://emailbydomain.com>

Auto manuals search

<http://auto.somanuals.com>

TV manuals search

<http://tv.somanuals.com>