

SAMSUNG

VIDEO

CASSETTE RECORDER

SV-665B

SV-662B

SV-661B

SV-262B

SV-265B

SV-661I

SV-261B

SV-261I

Instruction Manual

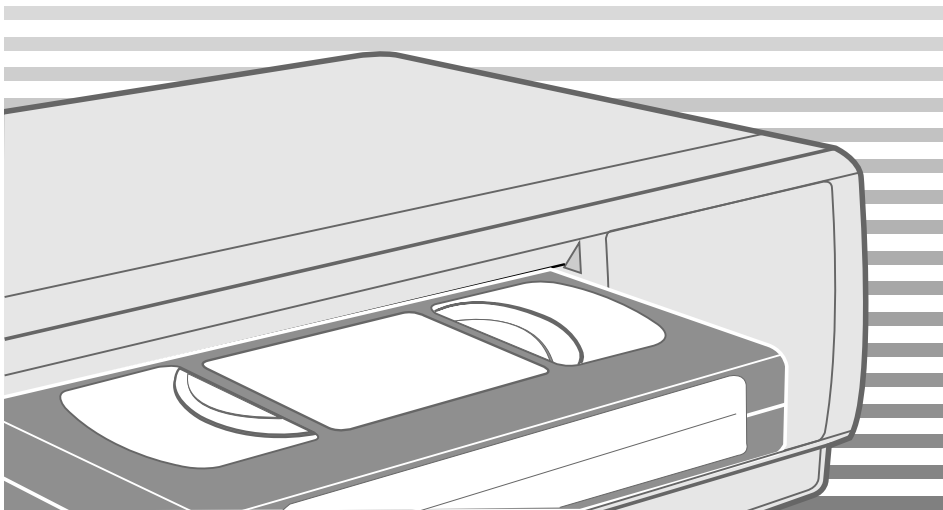

www.samsungvcr.com



Safety Precautions



CAUTION
RISK OF ELECTRIC SHOCK
DO NOT OPEN



CAUTION. TO REDUCE THE RISK OF ELECTRIC SHOCK, DO NOT REMOVE REAR COVER. NO USER SERVICEABLE PARTS INSIDE. REFER TO QUALIFIED SERVICE PERSONNEL.

IMPORTANT NOTE

The mains lead on this equipment is supplied with a moulded plug incorporating a fuse. The value of the fuse is indicated on the pin face of the plug. If it requires replacing, a fuse approved to BS1362 of the same rating must be used.

Never use the plug with the fuse cover omitted if the cover is detachable. If a replacement fuse cover is required, it must be of the same colour as the pin face of the plug. Replacement covers are available from your dealer.

If the fitted plug is not suitable for the power points in your house or the cable is not long enough to reach a power point, you should obtain a suitable safety approved extension lead or consult your dealer for assistance.

However, if there is no alternative to cutting off the plug, remove the fuse and then safely dispose of the plug. Do not connect the plug to a mains socket, as there is a risk of shock hazard from the bared flexible cord.

IMPORTANT

The wires in the mains lead are coloured in accordance with the following code: -

BLUE = NEUTRAL BROWN = LIVE

As these colours may not correspond with the coloured markings identifying the terminals in your plug, proceed as follows: -

The wire coloured BLUE must be connected to the terminal marked with the letter N or coloured BLUE or BLACK. The wire coloured BROWN must be connected to the terminal marked with the letter L or coloured BROWN or RED.

WARNING: DO NOT CONNECT EITHER WIRE TO THE EARTH TERMINAL WHICH IS MARKED WITH THE LETTER E OR BY THE EARTH SYMBOL \perp , OR COLOURED GREEN OR GREEN AND YELLOW.

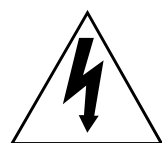

DANGER

This symbol is intended to alert you to the presence of dangerous voltage within the product.



CAUTION

This symbol is intended to alert you to the presence of important instructions accompanying the product.

About this manual

Thank you for purchasing a Samsung Video Cassette Recorder (VCR). Your Owner's Instructions contain much valuable information on setting up and using your VCR. Please take the time to read them as they will help you take full advantage of your VCR's features.

The instructions in this manual are for models, SV-665B, SV-661B, SV-265B, SV-261B, SV-662B, SV-262B, SV-661I and SV-261I. Before you start reading this manual please check your model number. It is displayed on the rear of the VCR.

- ★(SV-665B): Exceptions only for a certain model, for example SV-665B.
- Gray shaded areas marked with a star indicate instructions that are only relevant to one model.

Features Chart





Feature \ Model	SV-665B	SV-661B SV-662B	SV-265B	SV-261B SV-262B	SV-661I	SV-261I
VIDEOPLUS+ Recording	●		●			
AV2 IN socket	●	●			●	
Format 16:9	●	●			●	
Child Door Lock	●	●	●	●	●	●
IPC (Intelligent Picture Control)	●	●	●	●	●	●
Timer Programming	●	●	●	●	●	●
Auto Clock Setting	●	●	●	●	●	●
Changing recording speed (SP/LP)	●	●	●	●	●	●
Hi-Fi & NICAM	●	●			●	
Connecting an RCA Audio/Video cable	●	●			●	
Using the TV Buttons On the Remote Control	●					



- ◆ FOREWORD
 - Safety Instructions 6
- ◆ VCR OVERVIEWS
 - Front View of the VCR 7
 - Rear View of the VCR 8
 - Infrared Remote Control 9
 - Display Indicators 10
 - Accessories 10
- ◆ CONNECTING YOUR VIDEO CASSETTE RECORDER
 - Deciding How to Connect Your VCR 11
 - Connecting Your VCR to the TV using the Coaxial Cable and SCART cable 12
 - Connecting Your VCR to the Satellite receiver or Other Equipment 13
 - Connecting the Audio Output Cable (SV-665B/SV-661B/SV-662B/SV-661I) 14
 - Plug & Auto Set Up 14
 - Tuning Your Television for the VCR 15
- ◆ SETTING UP YOUR VIDEO CASSETTE RECORDER
 - Inserting Batteries in the Remote Control 16
 - Setting the Date and Time 16
 - Displaying/Hiding On-Screen Information 17
 - Setting the VCR Output Channel 17
 - Presetting the Stations Automatically 18
 - Presetting the Stations Manually 19
 - Clearing a Preset Station 20
 - Changing the Preset Station Table 21
- ◆ RECORDING TELEVISION BROADCASTS
 - Selecting the Cassette Type 22
 - Selecting the Recording Speed 22
 - NICAM (SV-665B/SV-661B/SV-662B/SV-661I Only) 23
 - Protecting a Recorded Cassette 24
 - Recording a Programme Immediately 24
 - Recording a Programme with Automatic Stop 25
 - Using the VIDEOPLUS+ Feature (SV-665B/SV-265B Only) 26
 - Modifying VIDEOPLUS+ Programming (SV-665B/SV-265B Only) 27
 - Using the Timer Programming Feature 28
 - Checking a Preset Recording 29
 - Cancelling a Preset Recording 29
- ◆ PLAYING BACK
 - Playing a Cassette 30
 - Adjusting Picture Alignment Automatically (SV-661B/SV-662B/SV-661I/SV-265B/SV-261B/SV-262B/SV-261I Only) 30
 - Adjusting Picture Alignment Manually 30
 - Intelligent Picture Control 31
 - Intelligent Picture Control (SV-661B/SV-662B/SV-661I/SV-265B/SV-261B/SV-262B/SV-261I Only) 31
 - Format 16:9 (Wide Screen) (SV-665B/SV-661B/SV-662B/SV-661I Only) ... 32
 - Selecting the Colour Mode 32
 - Selecting the Audio Output Mode (SV-665B/SV-661B/SV-662B/SV-661I Only) 33
 - Selecting the Audio Mute Mode (SV-265B/SV-261B/SV-262B/SV-261I Only) 33

- ◆ SEARCHING FOR A SEQUENCE
 - Playing a Cassette in Slow Motion (SV-665B/SV-661B/SV-662B/SV-661I Only) ... 34
 - Playing a Sequence Frame by Frame 35
 - Picture Search, Fast Forward/Rewind 35
 - Searching for a Specific Sequence 36
 - Auto Repeat Play 37
 - Interval Repeat Play 37
- ◆ EASY OPERATION
 - VIDEOPLUS+ EXTEND (SV-665B/SV-265B Only) 38
 - Using the Tape Counter 38
- ◆ ADVANCED RECORDING FEATURES
 - Connecting an RCA Audio/Video Input cable (SV-665B/SV-661B/SV-662B/SV-661I Only) 39
 - Using the Assemble Edit Function 40
 - Recording from Another VCR or Camcorder 40
- ◆ OTHER FUNCTIONS AND USEFUL RECOMMENDATIONS
 - Using the TV Buttons on the Remote Control (SV-665B Only) 41
 - Auto Power Off 42
 - Child Door Lock System (SV-665B/SV-661B/SV-662B/SV-661I/SV-265B/SV-261B/SV-262B/SV-261I Only) 42
 - ECO Mode-Reducing Standby power consumption 42
 - Technical Specifications 43
- ◆ SOLVING PROBLEMS
 - Problems and Solutions 44
 - Service Centers List 45

Symbols

				
Press/push	Hold down	Important	Note	Option
① = Step number				

Safety Instructions

The following illustrations represent precautions.



The lightning bolt is a warning sign alerting you to dangerous voltage inside the product. DO NOT OPEN THE VCR. Refer to service personnel.

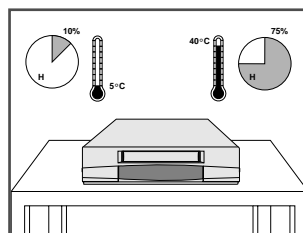

Do NOT expose the VCR to extreme temperature conditions (below 5°C and above 40°C) or to extreme humidity conditions (less than 10% and more than 75%).

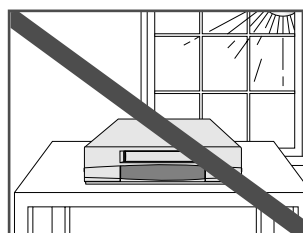

Do NOT expose the VCR to direct sunlight.

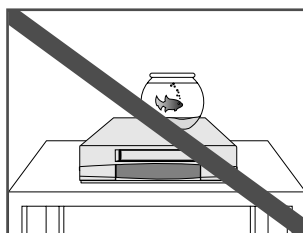

Do NOT expose the VCR to any liquids.

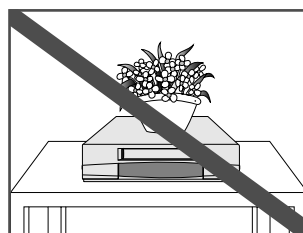

Do NOT place any objects on the VCR or remote control.

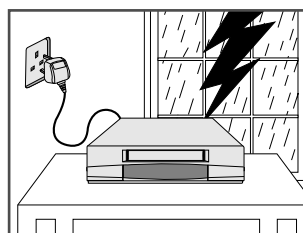

During a storm and/or lightning, unplug the VCR from the mains socket and aerial.

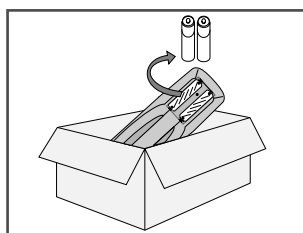

If the remote control is not used for a long period of time, remove the batteries and store it in a cool, dry place.

THIS DEVICE IS NOT FOR USE IN INDUSTRIAL ENVIRONMENTS

Front View of the VCR

(SV-665B/SV-661B/SV-661I)

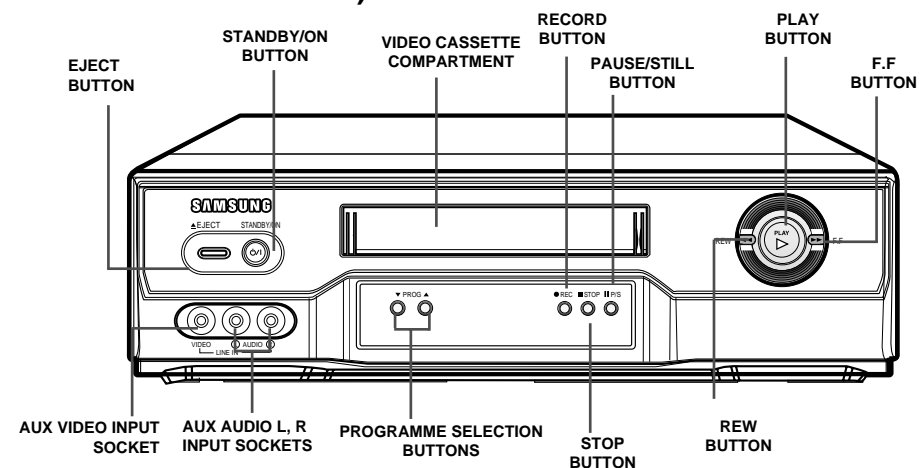

(SV-265B/SV-261B/SV-261I)

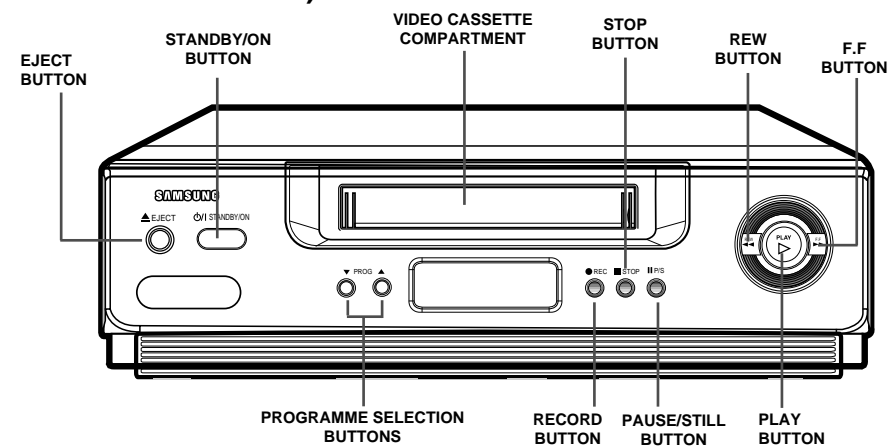

Rear View of the VCR

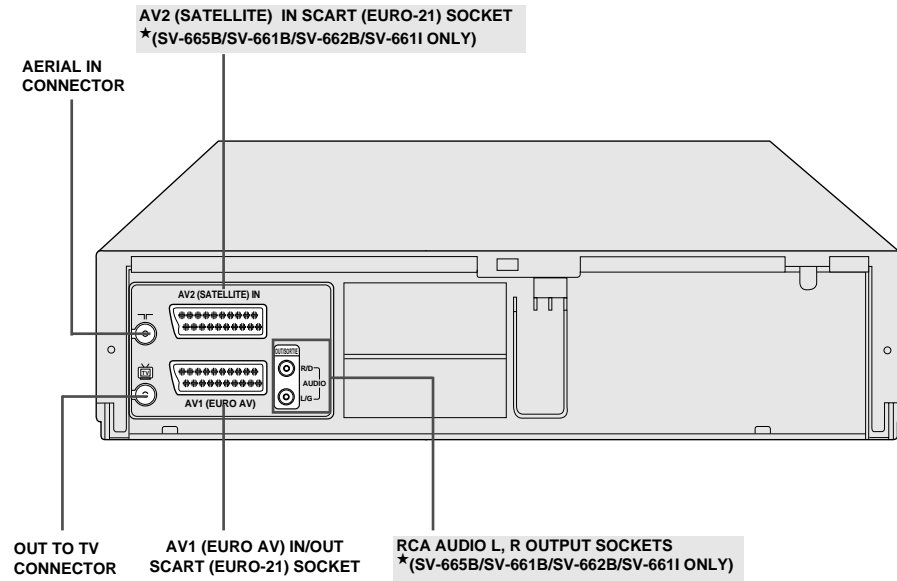

Infrared Remote Control

(SV-665B)

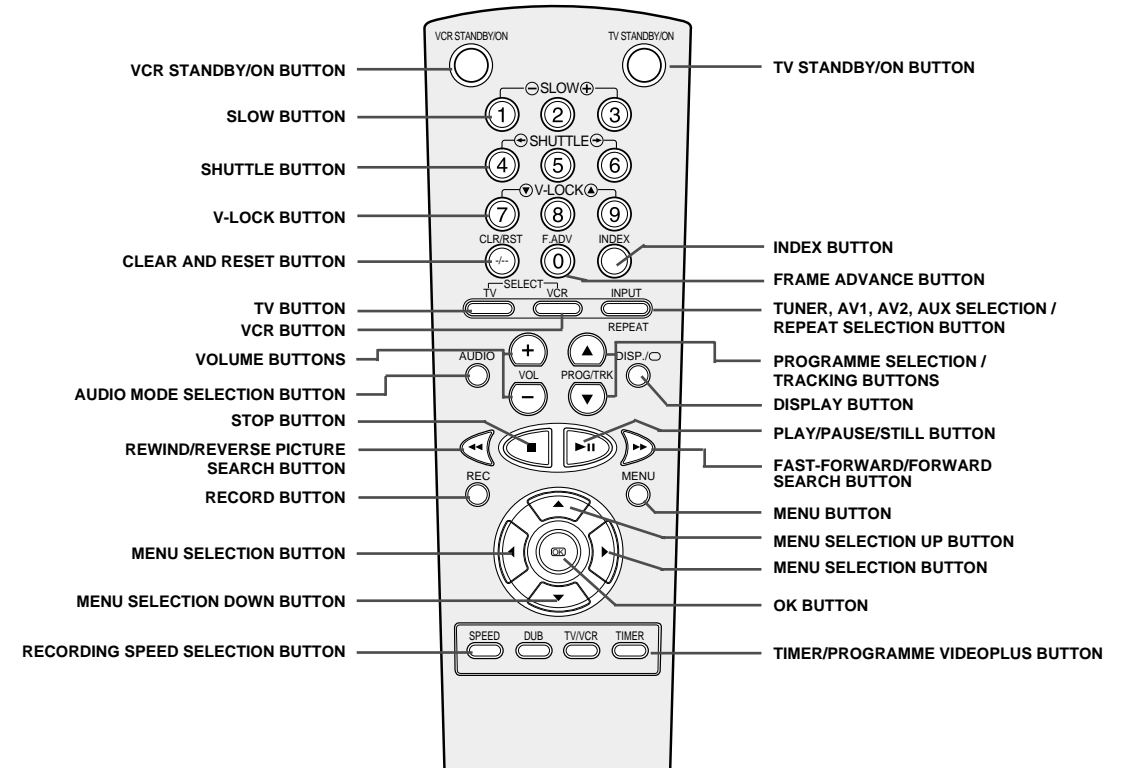

(SV-661B/SV-265B/SV-261B
SV-662B/SV-262B/SV-661I
SV-261I)

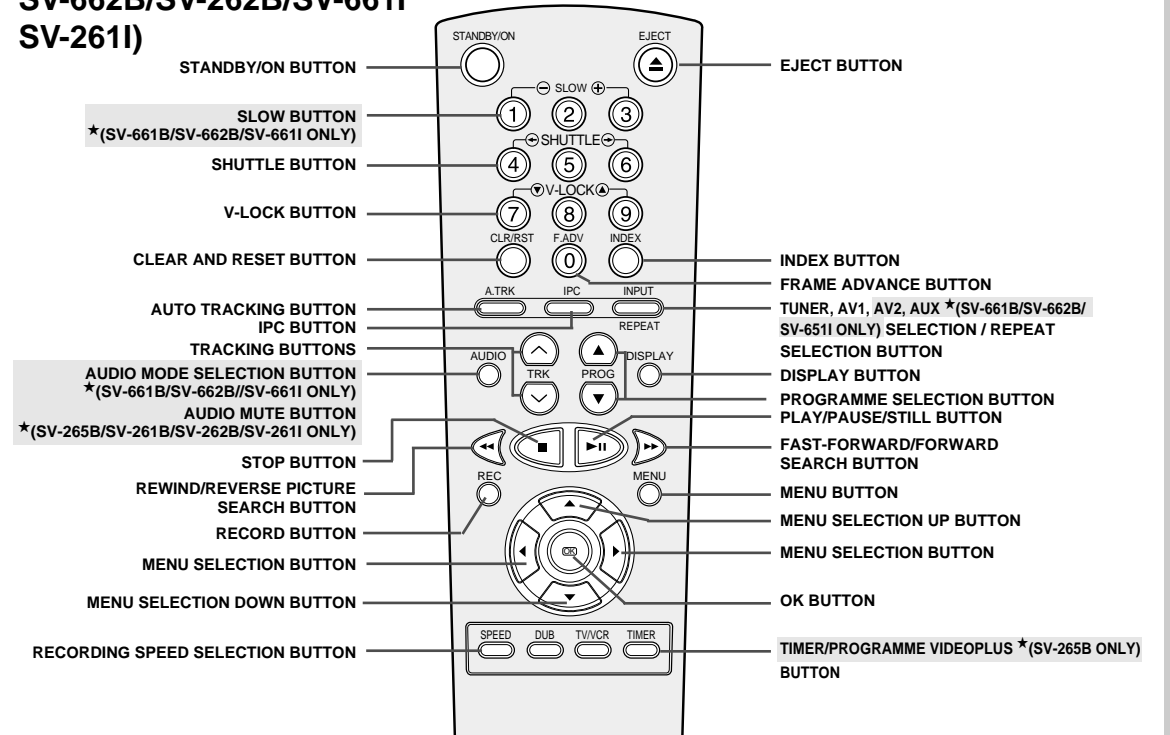

Display Indicators

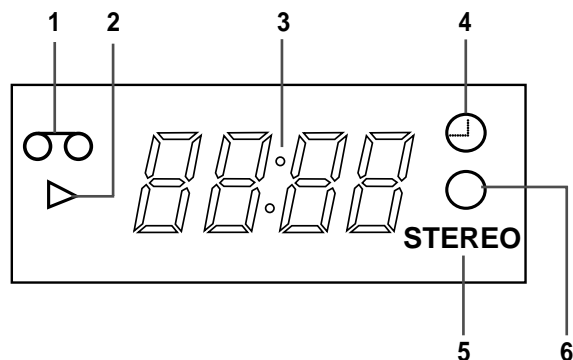

- 1 Cassette loaded indicator
- 2 PLAY indicator
- 3 Multi-function display
- 4 Timer indicator
- 5 STEREO indicator
★(SV-665B/SV-661B/SV-662B/SV-661I ONLY)
- 6 Rec indicator

Accessories

You have just purchased a SAMSUNG Video Cassette Recorder (VCR). Together with your VCR, you will find the following accessories in the box.

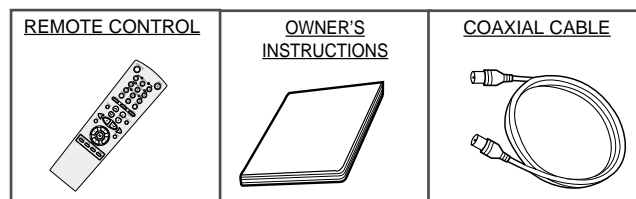













Deciding How to Connect Your VCR

You must take into account various factors when connecting audio or video systems:

- ◆ Types of connectors available on your systems
- ◆ Systems connected permanently to the VCR (satellite receiver for example) or temporarily (camcorder for example)

Your VCR is equipped with the following connectors.

Connector	Location	Type	Direction	Recommended Use
AV1 (EURO AV)	Rear 	SCART	In/Out 	◆ Television ◆ Satellite receiver ◆ Other VCR
OUT TO TV	Rear 	75 Ω coaxial	Out 	◆ Television
IN FROM ANT.	Rear 	75 Ω coaxial	In 	◆ Aerial ◆ Cable television network ◆ Satellite receiver
AV2 (SATELLITE)	Rear 	SCART	In 	◆ Satellite receiver ◆ Other VCR
★(SV-665B/SV-661B/SV-662B/SV-661I Only)				
AUX	Front 	Audio/Video RCA	In 	◆ Audio Hi-Fi system ◆ Camcorder
★(SV-665B/SV-661B/SV-662B/SV-661I Only)				
Audio output	Rear 	Audio RCA	Out 	◆ Audio Hi-Fi system
★(SV-665B/SV-661B/SV-662B/SV-661I Only)				



Whenever you connect an audio or video system to your VCR, ensure that all elements are switched off.

Refer to the documentation supplied with your equipment for detailed connection instructions and associated safety precautions.

Connecting Your VCR to the TV using the Coaxial Cable and SCART cable

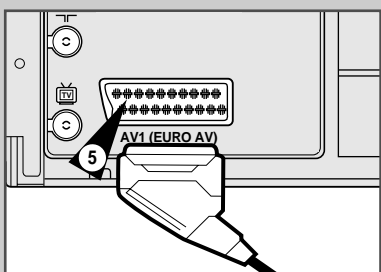
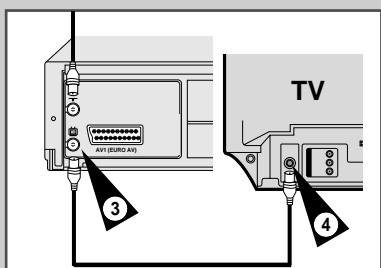
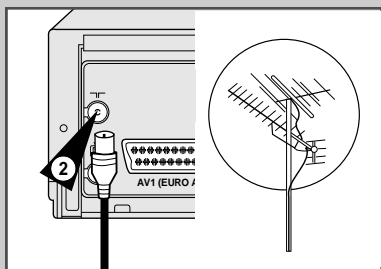

To receive television programmes a signal must be received from one of the following sources:

- ◆ An outdoor aerial
- ◆ An indoor aerial
- ◆ A cable television network
- ◆ A satellite receiver

Make sure that both the television and the VCR are switched off before connecting the cables.

- 1 Remove the aerial or network input cable from the television.
- 2 Connect this cable to the 75Ω coaxial socket marked Γ on the rear of your VCR.
- 3 Plug the coaxial cable supplied into the  socket on your VCR.
- 4 Plug the other end of the coaxial cable into the connector previously used for the aerial on the television.
- 5 Connect one end of the scart cable to the AV1 (EURO AV) socket on the rear of the VCR. You must connect your VCR to the television via the scart cable.
- 6 Plug the other end into the appropriate connector on the television.

Connecting Your VCR to the Satellite receiver or Other Equipment

You can connect your VCR to a Satellite receiver or other VCR using the SCART cable if the appropriate outputs are available on the equipment chosen. The following illustrations give a few examples of the connection possibilities.

1. AV2(SATELLITE): By means of 21-pin Scart Cable *(SV-665B/SV-661B/SV-662B/SV-661I Only)

Plug the SCART Cable with satellite receiver or other equipment into the AV2(SATELLITE) socket on the rear of the VCR.

After making this connection, select the source by pressing the INPUT button for the AV2 input sources.

2. By means of RF Coaxial Cable

After making this connection, you must preset the station received through the satellite tuner.

RF output channel of the satellite receiver should be adjusted away from channel 60, which is used by the VCR, e.g. re-adjust to channel 65.

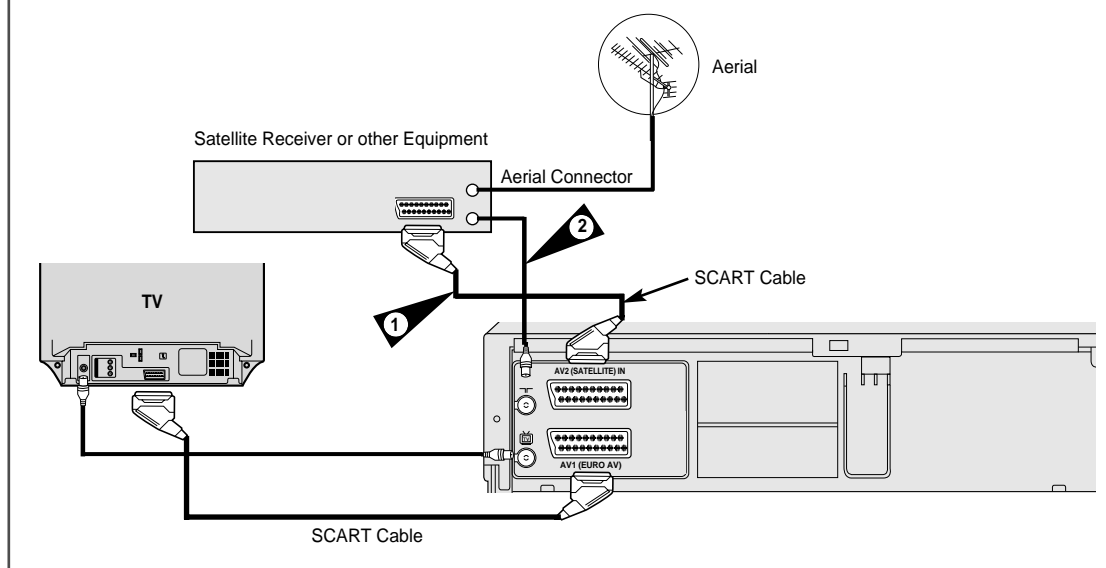

Connecting the Audio Output Cable ★(SV-665B/SV-661B/SV-662B/SV-661I Only)

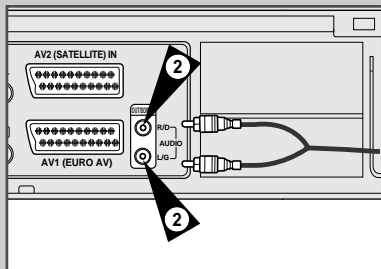
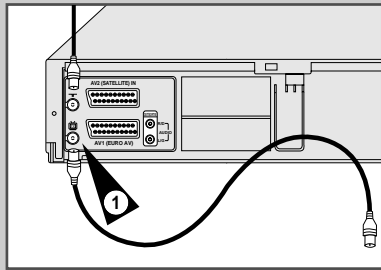

You can connect your VCR to a Hi-Fi system.

Example: You wish to take advantage of the quality of your Hi-Fi stereo system when watching a programme or recording via your VCR.

- ◆ Regardless of the type of connection chosen, you must always connect the coaxial cable supplied. Otherwise, no picture will be visible on the screen when the VCR is switched off.
- ◆ Make sure that both the television and the VCR are switched off before connecting the cables.

- 1 Connect the coaxial cable or SCART as indicated on page 12.
- 2 Plug the audio output cable into the audio connectors on the rear of your VCR.
 - Respect the colour coding of the left and right channels.
- 3 Plug the other end of the audio cable into the appropriate input connectors on your Hi-Fi stereo system.

Plug & Auto Set Up

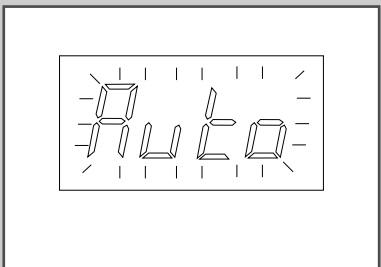
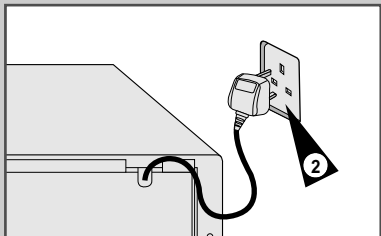
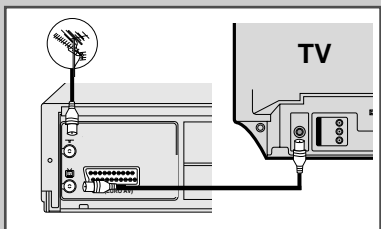

Your VCR will automatically set itself up when it is plugged into the mains for the first time. TV stations will be stored in memory. The process takes a few minutes. Your VCR will then be ready for use.

- 1 Connect the coaxial cable as indicated on page 12. (Connecting Your VCR to the TV Using the Coaxial Cable)
- 2 Plug the VCR into the mains.

Result: A message appears.
- 3 Press OK button to start the auto scanning
 - ◆ The number of stations automatically stored by the VCR depends on the number of stations that it has found.
 - ◆ The process will finish after a few minutes.
- 4 The current time and date are displayed automatically. Check the date and time.

if it is :

 - ◆ Correct, Press MENU button twice to exit the menu.
 - ◆ incorrect, see page 16.

➤ Auto preset can be performed by pressing ■ (STOP) on the VCR continuously for 5 seconds or more with no tape inserted.

✎ Function for "Plug & Auto Set Up" is fixed already. So if you want to change this fixed one, you can change it by Presetting the Stations Automatically in OSD " Auto Set Up" menu. (see page 18)

Tuning Your Television for the VCR

You must tune your television for the VCR only if you are not using a Scart cable

➤ To view pictures from your VCR when a Scart cable is used, the television must be set to the audio/video mode (AV).

- 1 Switch on the television.
- 2 Switch on the VCR by pressing STANDBY/ON on the front of the VCR or VCR STANDBY/ON (STANDBY/ON) on the remote control.
- 3 Select a programme position on the television to be reserved for use with your VCR.
- 4 Insert the video cassette in the VCR. Check that the VCR starts reading the cassette; if not, press ►|| button.
- 5 Start a scan on your television or set the television to UHF channel 60.
- 6 Fine tune the television until the pictures and sound are obtained clearly.
- 7 If you cannot find the pictures and sound, or there is interference from nearby channels, it may be necessary to change the setting of the VCR output channel (see Setting the VCR Output Channel on page 17 and Problems and Solutions on page 49).
- 8 When the picture and sound are perfectly clear, store this channel at the desired programme position on the television.

Result: That programme is now reserved for use with your VCR.

★(SV-665B)

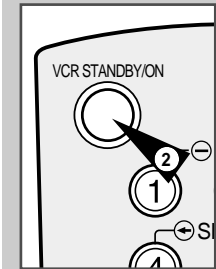

★(SV-661B/SV-662B/SV-661I/ SV-265B/SV-261B/SV-262B/SV-261I)

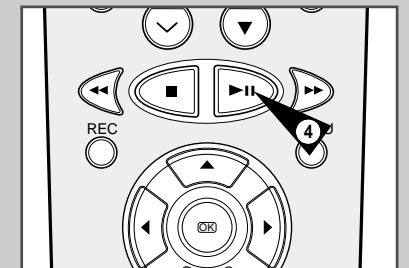
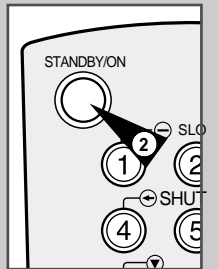

Inserting Batteries in the Remote Control

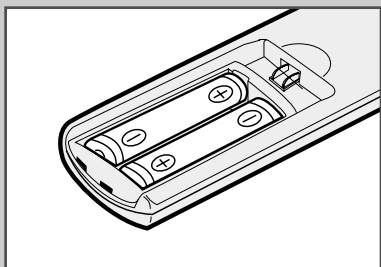
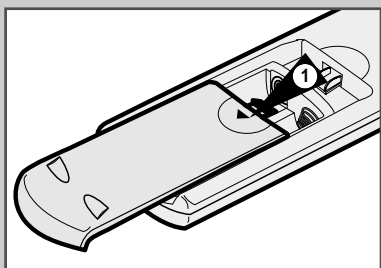

You must insert or replace the batteries in the remote control when you:

- ◆ Purchase the video cassette recorder
- ◆ Find that the remote control is no longer working correctly

- 1 Push the tab in the direction of the arrow to release the battery compartment cover on the rear of the remote control.
- 2 Insert two AA, R6 or equivalent batteries, taking care to respect the polarities:
 - ◆ + on the battery with + on the remote control
 - ◆ - on the battery with - on the remote control
- 3 Replace the cover by aligning it with the base of the remote control and pushing it back into place.

➤ Do not mix different battery types (manganese and alkaline for example).

Setting the Date and Time

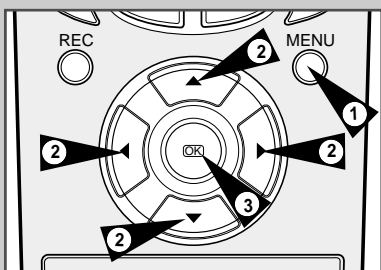

Your VCR contains a 24-hour clock and calendar used to:

- ◆ Automatically stop programme recording
- ◆ Preset your VCR to record a programme automatically

You must set the date and time when:

- ◆ You purchase the video cassette recorder

- ◆ The time and date are set automatically from the broadcast signal. If the signal is weak or ghosting occurs, the time and date may not be set automatically. In this case, they should be set manually.
- ◆ Do not forget to reset the time when you change clocks from winter to summer time and vice versa.

- 1 Press MENU on the remote control.
Result: The programming menu is displayed.
- 2 Press the corresponding ▲, ▼ or ◀, ▶ buttons to select the **CLOCK SET** option.
- 3 Press the OK button to select this option.
Result: The **CLOCK SET** menu is displayed.
- 4 Press ◀ or ▶ to select the hour, minutes, day, month and year.
Result: The option selected flashes.
- 5 Press the ▲ or ▼ buttons to increase or decrease the value.
Result: The day of the week is displayed automatically.
 - You can hold the ▲ or ▼ buttons down to scroll more quickly through the values.
- 6 On completion, press MENU twice to exit the menu.

Displaying/Hiding On-Screen Information

Your VCR displays most information both on the VCR and the television.

You can choose to display or hide this information on the television screen (except for the Index, Programming MENU and VIDEOPLUS+ functions ★(SV-665B/SV-265B only), which cannot be hidden).

- 1 Press MENU on the remote control.
Result: The programming menu is displayed.
- 2 Press the corresponding ▲, ▼ or ◀, ▶ buttons to select the **USER SET** option.
- 3 Press the OK button to select this option.
Result: The **USER SET** menu is displayed.
- 4 Press the corresponding ▲ or ▼ buttons, until the **OSD** option is selected.
- 5

To...	Press ◀ or ▶, until...
Display on-screen information	ON is displayed.
Hide on-screen information	OFF is displayed.
- 6 On completion, press MENU twice to exit the menu.

★(SV-665B/SV-661B/SV-662B/SV-661I)

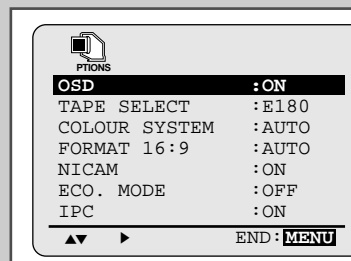

★(SV-265B/SV-261B/SV-262B/SV-261I)

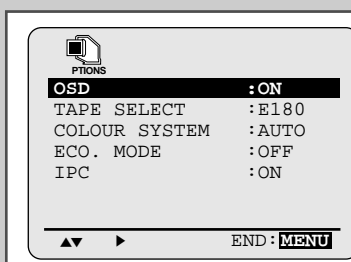

Setting the VCR Output Channel

Your VCR output channel may need to be changed if the pictures suffer from interference or if your TV cannot find the pictures. Also, you can change the VCR output channel to adjust the frequency in which information is displayed on the screen.

- 1 Press MENU on the remote control.
Result: The programming menu is displayed.
- 2 Press the corresponding ▲, ▼ or ◀, ▶ buttons to select the **INSTALLATION** option.
- 3 Press the OK button to select this option.
Result: The **INSTALLATION** menu is displayed.
- 4 Press the corresponding ▲ or ▼ buttons, until the **VCR OUTPUT CH** option is selected.
- 5 Select the required output channel (CH21~CH69) by pressing the ◀ or ▶ buttons.
- 6 On completion, press MENU twice to exit the menu. Then tune your television again (see page 15).

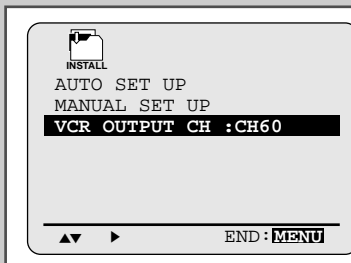

Presetting the Stations Automatically

 You do not need to preset the stations if you have already set them automatically (see Plug & Auto Set Up on page 14).

Your VCR contains a built-in tuner used to receive television broadcasts.

You must preset the stations received through the tuner. This can be done:

- ◆ Plug & Auto Set up (see page 14)
- ◆ Automatically
- ◆ Manually (see page 19)

You can store up to 80 stations.

- 1 Press the MENU button on the remote control.
Result: The programming menu is displayed.
- 2 Press the corresponding ▲, ▼ or ◀, ▶ buttons to select the **INSTALLATION** option.
- 3 Press the OK button to select this option.
Result: The **INSTALLATION** menu is displayed.
- 4 Press the corresponding ▲ or ▼ buttons, until the **AUTO SET UP** option is selected. And then press the ▶ button to select this option.
Result: A message appears, indicating that any channels already preset on your VCR will be deleted.
- 5 Press OK to start the auto scanning.
Result:
 - ◆ The **PLEASE WAIT** indication flashes on the television screen.
 - ◆ The first frequency band is scanned and the first station found is displayed and stored.
 - ◆ The VCR then searches for the second station and so on.
 - ◆ When the automatic scanning procedure has finished, the VCR switches automatically to programme 1.
- 6 If you wish to cancel the auto scanning before the end, press the MENU button three times to exit the menu.

-
- ◆ The time and date are set automatically from the broadcast signal. If the signal is weak or ghosting occurs, the time and date may not be set automatically. In this case, they should be set manually (see page 16).
 - ◆ Once the auto scanning procedure has finished, some stations may have been stored more than once; select the stations with the best reception and delete the ones no longer required (see page 20).

Presetting the Stations Manually

 You do not need to preset the stations manually if you have already set them automatically.

- 1 Press the MENU button on the remote control.
Result: The programming menu is displayed.
- 2 Press the corresponding ▲, ▼ or ◀, ▶ buttons to select the **INSTALLATION** option.
- 3 Press the OK button to select this option.
Result: The **INSTALLATION** menu is displayed.
- 4 Press the corresponding ▲ or ▼ buttons, until the **MANUAL SET UP** option is selected.
- 5 Press the ▶ button to select a **MANUAL SET UP** option.
Result: The **TV STATION TABLE** menu is displayed.
- 6 Press the ▲ or ▼ buttons to select a programme number as required.
- 7 Press the ▶ button to preset the station.
Result: The **MANUAL TUNING** menu is displayed.
- 8 Press the ◀ or ▶ buttons to start scanning.
Result: The frequency band is scanned and the first station found is displayed.
- 9 Press the ▲ or ▼ buttons until the **NAME** is selected.
The station name is set automatically from the broadcast signal.
- 10 To change the programme's name, press the ▶ button.
Result: The first letter of the name flashes.
- 11

To...	Then...
Select a character in the name	Press the ▲ or ▼ button until the required character is displayed (letters, numbers or "-" character).
Move to the next or previous character	Press the ▶ or ◀ buttons respectively.
- 12

If you...	Then...
Wish to store the station displayed	<ul style="list-style-type: none"> ◆ Press the corresponding ▲ or ▼ buttons, until the MFT is selected. ◆ Press the ◀ or ▶ buttons to adjust the picture, if necessary. ◆ Press OK to store the station
Do <u>not</u> wish to store the station displayed	<ul style="list-style-type: none"> ◆ Press the corresponding ▲ or ▼ buttons, until the CH is selected. ◆ Press the ◀ or ▶ buttons to go on scanning the frequency band and display the next station ◆ Go back to the beginning of Step 12
- 13 Repeat this procedure from Step 6 onwards, until all the required stations have been stored.
- 14 On completion, press the MENU button three times to exit the menu.

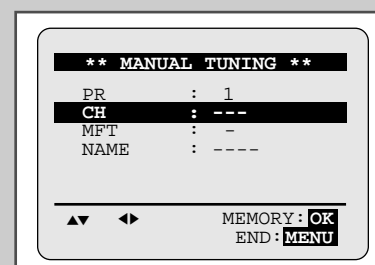
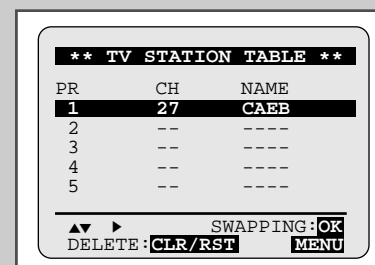
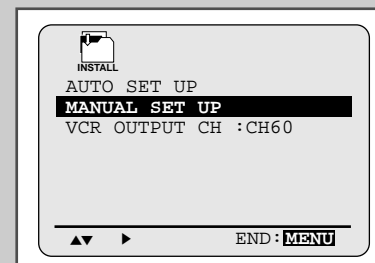
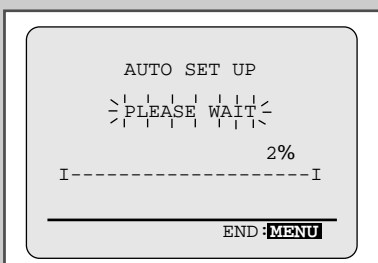
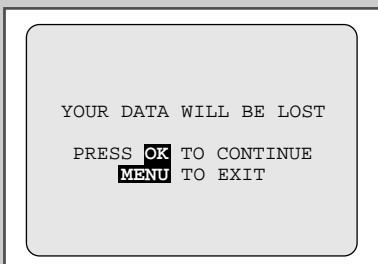
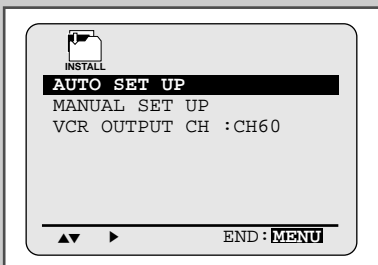
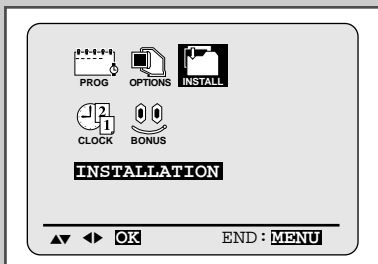

Clearing a Preset Station

If you have stored a TV station:

- ◆ That you do not require
- ◆ At the wrong programme position

you can cancel it.

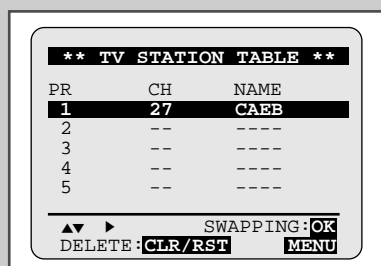
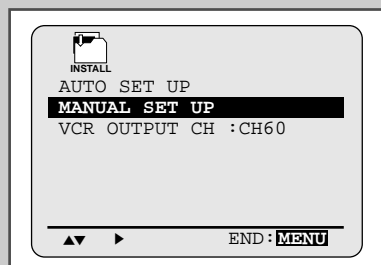
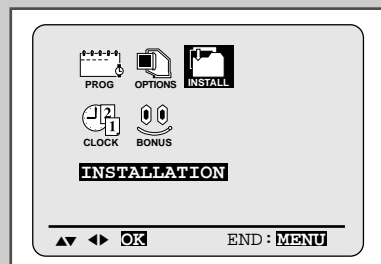

- 1 Press the MENU button on the remote control.
- 2 Press the corresponding ▲, ▼ or ◀, ▶ buttons to select the **INSTALLATION** option.
- 3 Press the OK button to select this option.
Result: The **INSTALLATION** menu is displayed.
- 4 Press the corresponding ▲ or ▼ buttons, until the **MANUAL SET UP** option is selected.
- 5 Press the ▶ button to select this option.
Result: The **TV STATION TABLE** menu is displayed.
- 6 Press the corresponding ▲ or ▼ buttons, until the required preset TV station (PR) is selected.
- 7 Press the CLR/RST button.
- 8 Repeat the same procedure from Step 6 onwards until all the required stations have been cleared.
- 9 On completion, press the MENU button three times to exit the menu.

Changing the Preset Station Table

You can rearrange the Station Table and give different programme numbers to the stations listed according to your own preferences.

- 1 Press the MENU button on the remote control.
- 2 Press the corresponding ▲, ▼ or ◀, ▶ buttons to select the **INSTALLATION** option.
- 3 Press the OK button to select this option.
Result: The **INSTALLATION** menu is displayed.
- 4 Press the ▲ or ▼ buttons to select **MANUAL SET UP** option. And then press the ▶ button to select this option.
Result: The **TV STATION TABLE** menu is displayed.
- 5 Press the corresponding ▲ or ▼ buttons, until the required preset TV programme is selected.
Result: The selected station is displayed at the same time on the television screen.
- 6 To change the programme number assigned to a station press the OK button on the remote control. (For example, To move a TV station in programme 1 to programme 3)
- 7 Press the ▲ or ▼ buttons to select required position. And then press OK again to swap the position.
- 8 You can modify this station by repeating the same procedure from Step 5 onwards.
- 9 On completion, press the MENU button three times to exit the menu.

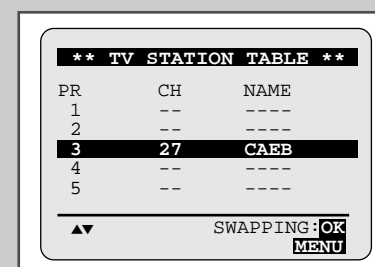
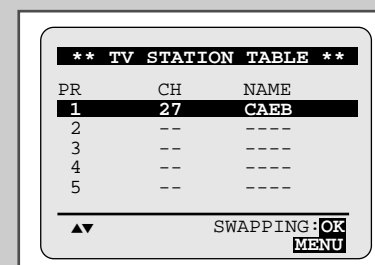
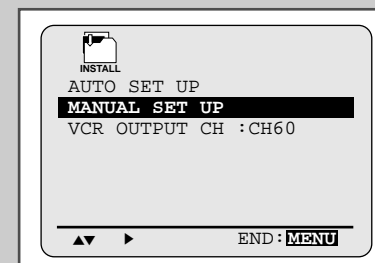

Selecting the Cassette Type

★(SV-665B/SV-661B/SV-662B/SV-661I)

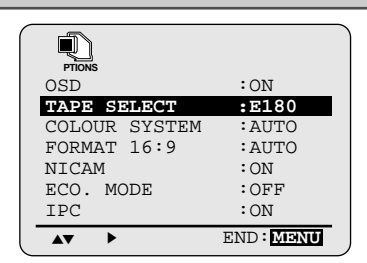

★(SV-265B/SV-261B/SV-262B/SV-261I)

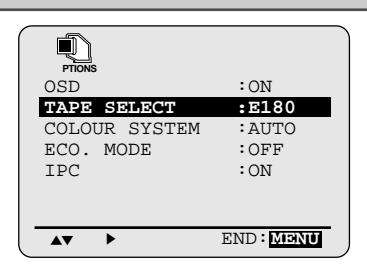

If you wish to use the tape counter to display the time remaining on a cassette, you must indicate the type of cassette inserted.

- 1 Press MENU on the remote control.
Result: The programming menu is displayed.
- 2 Press the corresponding ▲, ▼ or ◀, ▶ buttons to select the **USER SET** option.
- 3 Press the OK button to select this option.
- 4 Press the corresponding ▲ or ▼ buttons, until the **TAPE SELECT** option is selected.
- 5 Press the ◀ or ▶ buttons as many times as required, until the correct cassette length is displayed.

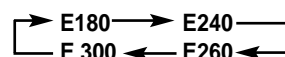

- 6 Press MENU twice to exit the menu.

Selecting the Recording Speed

Type	Recording Time (in SP)
E-180	180 mins. or 3 hours
E-240	240 mins. or 4 hours
E-260	260 mins. or 4 hours and 20 mins.
E-300	300 mins. or 5 hours

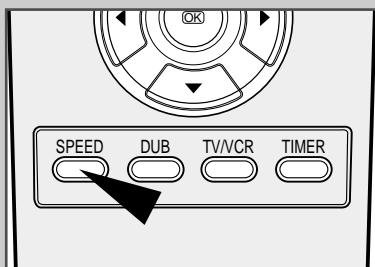

You can record a cassette at two different speeds:

- ◆ SP (Standard Play)
- ◆ LP (Long Play)

In Long Play modes:

- ◆ Each cassette lasts twice as long
- ◆ The recording is of a slightly lower quality

To record a cassette... Press the SPEED button on the remote control, until...

In standard play mode **SP** is displayed.
In long play mode **LP** is displayed.

NICAM ★(SV-665B/SV-661B/SV-662B/SV-661I Only)

NICAM programmes are divided into 3 types. NICAM Stereo, NICAM Mono and Bilingual (transmission in another language). NICAM programmes are always accompanied by a standard mono sound broadcast and you can select the desired sound. Please refer to page 33.

- 1 Press MENU on the remote control.
Result: The programming menu is displayed.
- 2 Press the corresponding ▲, ▼ or ◀, ▶ buttons to select the **USER SET** option.
- 3 Press the OK button to select this option.
Result: The **USER SET** menu is displayed.
- 4 Press the corresponding ▲ or ▼ buttons, until the **NICAM** option is selected.
- 5 **To... Press ◀ or ▶, until...**

Mono mode	OFF is displayed. OFF: Only set at this position to record the standard mono sound during a NICAM broadcast if the stereo sound is distorted due to inferior reception conditions.
NICAM mode	ON is displayed. ON: Normally set at this position.
- 6 On completion, press MENU twice to exit the menu.

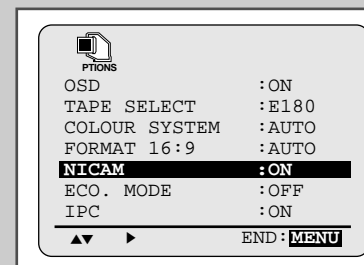

Protecting a Recorded Cassette

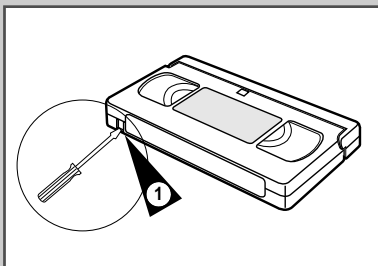

Video cassettes have a safety tab to prevent accidental erasure. When this tab has been removed, you cannot record on the tape.

- 1 If you wish to protect a cassette, break off the tab using a small screwdriver.
- 2 To re-record over a protected cassette (safety tab broken), cover the hole with adhesive tape.

Recording a Programme Immediately

★(SV-665B)
★(SV-661B/SV-662B/
SV-661I/SV-265B/
SV-261B/SV-262B/
SV-261I)

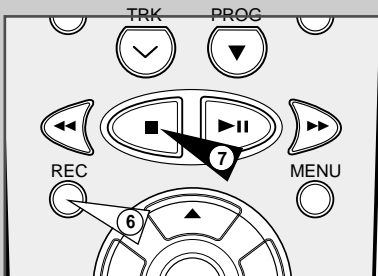
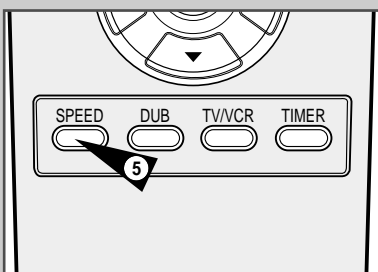
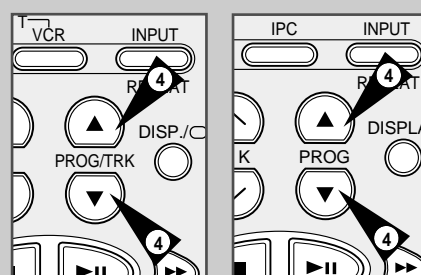

Before recording a programme, you must have preset the corresponding station (unless you are recording via an external video source). If you have not done so, refer to pages 18 and 19.

- 1 Switch on the television.
- 2 To monitor the programme being recorded, select the television channel reserved for use with your VCR (or the AV input if used).
- 3 Insert the cassette on which the programme is to be recorded, with the window visible and the safety tab intact or the opening covered with adhesive tape.
Result: The VCR is switched on automatically.
- 4 Select:
 - ◆ The station to be recorded using the PROG/TRK (▲ or ▼) / PROG (▲ or ▼) buttons
 - ◆ The AV1, AV2 or AUX ★(SV-665B/SV-661B/SV-662B/SV-661I only) source using the INPUT button for a satellite tuner or external video source**Result:** The station number is displayed and the programme can be seen on the television.
- 5 Select the recording speed by pressing the SPEED button as many times as required (see page 22).
- 6 Hold REC down for a while to start recording.
Result: The record indicator appears on the television and VCR display. An index is recorded on the tape (see page 36).
- 7 To stop recording, press ■ once.

-
- ◆ If your VCR ejects the cassette when you start recording, check to make sure that the cassette's safety tab is intact or that the opening (created by a broken safety tab) is covered with adhesive tape.
 - ◆ If you reach the end of the tape while recording, the cassette rewinds automatically.

Recording a Programme with Automatic Stop

This function enables you to record up to nine hours (LP) of programmes.

Your VCR stops automatically after the requested length of time.

- 1 Switch on the television.
- 2 To monitor the programme being recorded, select the television channel reserved for use with your VCR (or the AV input if used).
- 3 Insert the cassette on which the programme is to be recorded, with the window visible and the safety tab intact or the opening covered with adhesive tape.
Result: The VCR is switched on automatically.
- 4 Select:
 - ◆ The station to be recorded using the PROG/TRK (▲ or ▼) / PROG (▲ or ▼) buttons
 - ◆ The AV1, AV2 or AUX ★(SV-665B/SV-661B/SV-662B/SV-651I only) source using the INPUT button for a satellite tuner or external video source**Result:** The channel number is displayed and the programme can be seen on the television.
- 5 Select the recording speed by pressing the SPEED button as many times as required (see page 22).
- 6 Hold the REC button down for a while to start recording.
Result: The record indicator appears on the television screen and VCR display. An index is recorded on the tape (see page 36).
- 7 Press the REC button several times to increase the recording time in:
 - ◆ 30-minute intervals up to four hours
 - ◆ 1-hour intervals up to nine hours (LP)**Result:** The length is displayed on the television displays. The selected programme is recorded for the length of time requested. At the end of that time, the VCR stops recording automatically.
- 8 If you wish to cancel the recording before the end, press VCR STANDBY/ON (STANDBY/ON).

- ☞ If the end of the tape is reached while recording:
- ◆ The recording stops
 - ◆ The VCR automatically turns off

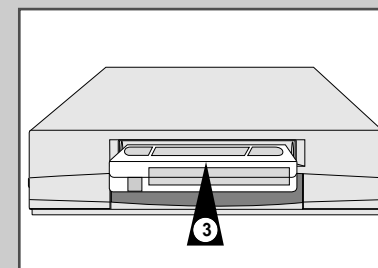

★(SV-661B/SV-662B/
SV-661I/SV-265B/
SV-261B/SV-262B/
SV-261I)

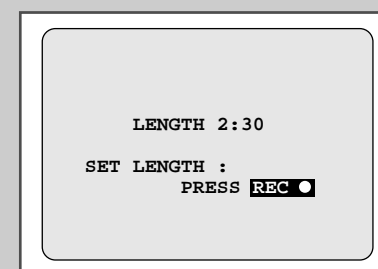
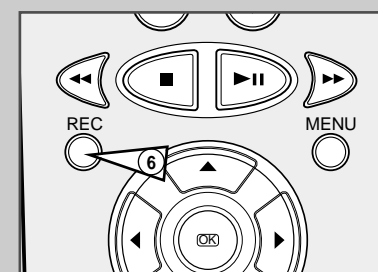
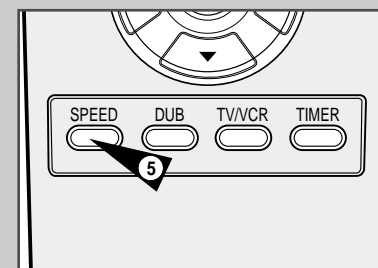
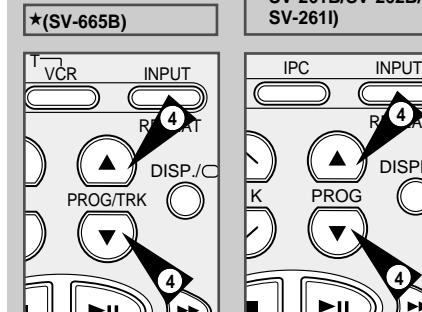

Using the VIDEOPLUS+ Feature ★(SV-665B/SV-265B Only)

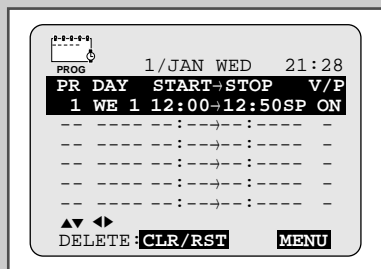
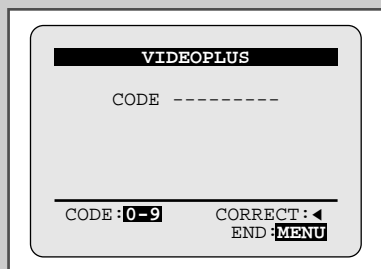
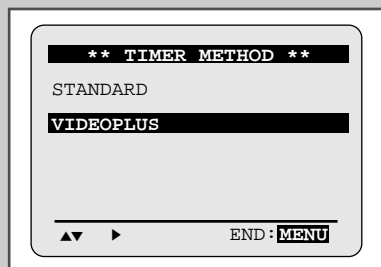
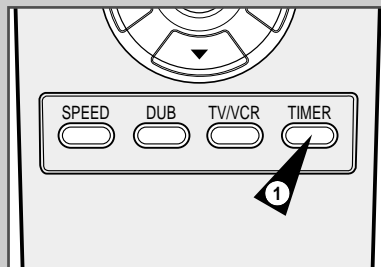

★(SV-665B) ★(SV-265B)

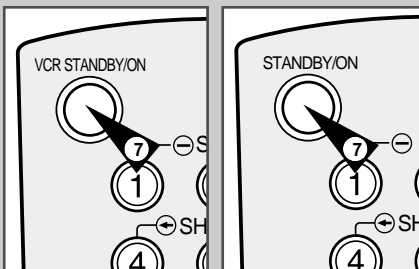

Before presetting your VCR:

- ◆ Switch on both the television and your VCR
- ◆ Check that the date and time are correct
- ◆ Insert the cassette on which the programme is to be recorded (safety tab intact)

Up to six programmes can be preset.

- 1 Press the **TIMER** button.
Result: The **TIMER METHOD** is displayed.
- 2 Press the corresponding **▲** or **▼** buttons, until the **VIDEOPUS+** option is selected.
- 3 Press the **▶** button to select **VIDEOPUS+**.
Result: A message is displayed to allow you to enter the VIDEOPLUS+ code.

 - ☞ If all six programmes have been set, the message **TIMER IS FULL** is displayed. Refer to page 29 if you wish to cancel a preset recording.
- 4 Press the numeric buttons to enter the code opposite the programme that you wish to record in your television magazine.

 - If you wish to correct the VIDEOPLUS+ code that you are entering:
 - ◆ Press the **◀** button until the digit to be corrected is cleared
 - ◆ Enter the correct digit
- 5 Press the **MENU** button.
Result: The information concerning the programme is displayed.

 - ☞ When using the VIDEOPLUS+ function for the first time with stored stations, the programme number flashes. This one time, you must enter the station number manually by pressing the **▲** or **▼** buttons. Refer to the following page if:
 - ◆ The programme number or times flash
 - ◆ You wish to modify the programme
- 6 If the programme and times are correct, press the **MENU** button.
- 7 Press the **VCR STANDBY/ON (STANDBY/ON)** button to activate the timer.
- 8 Refer to page 29 if you wish to:
 - ◆ Check that your VCR has been programmed correctly
 - ◆ Cancel a preset recording

☞ The numbers next to each TV programme listing are VIDEOPLUS+ code numbers, which allow you to programme your videorecorder instantly with the remote control. Tap in the VIDEOPLUS+ code for the programme you wish to record.

™ VIDEOPLUS+ is a trademark of Gemstar Development Corporation. The VIDEOPLUS+ system is manufactured under licence from Gemstar Development Corporation.

Modifying VIDEOPLUS+ Programming ★(V-665B/SV-265B Only)

If you wish to correct the programme displayed or modify certain elements, such as the recording speed, you can do so before you press **MENU** a second time to confirm.

If you wish to...	Then...
Select an input source other than the tuner (AV1, AV2 or AUX ★(SV-665B only))	<ul style="list-style-type: none"> ◆ Press the ◀ or ▶ buttons, until the PR selection flashes. ◆ Press the INPUT button one or more times to change the input source selection. Result: The programme number is replaced by: <ul style="list-style-type: none"> • The AV1, AV2 or AUX ★(SV-665B only) source using the INPUT button for a satellite tuner or external video source ➤ The input source must be selected before changing any other value.
Record a programme every day (Monday to Sunday) at the same time	<ul style="list-style-type: none"> ◆ Press the ◀ or ▶ buttons, until the DAY selection flashes. ◆ Press the ▲ or ▼ buttons, until the DLY (Daily) value is displayed.
Record a programme every week on the same day and at the same time	<ul style="list-style-type: none"> ◆ Press the ◀ or ▶ buttons, until the DAY selection flashes. ◆ Press the ▲ or ▼ buttons, until the W- (Week) value is displayed, followed by the required day. Example: W-SA (Weekly Saturday)
Extend the recording time	<ul style="list-style-type: none"> ◆ Press the ◀ or ▶ buttons, until the STOP selection flashes. ◆ Press the ▲ or ▼ buttons to increase or decrease the stop time.
Select the recording speed	<ul style="list-style-type: none"> ◆ Press the ◀ or ▶ buttons, until the recording speed selection flashes. ◆ Press the ▲ or ▼ buttons until the correct indication is displayed: <ul style="list-style-type: none"> • AUTO (Auto Tape Speed Select) : see page 28 • SP (Standard Play) • LP (Long Play)
Select the PDC recording	<ul style="list-style-type: none"> ◆ Press the ◀ or ▶ buttons, until the V/P selection flashes. ◆ Press the ▲ or ▼ buttons until the "ON" indication is displayed. ☞ Do not select PDC unless you are sure the programme you wish to record is broadcast with PDC. If you do set PDC ON (by selecting "ON" in the right - hand column on the screen), then you must set up the start-time EXACTLY according to the published TV schedule. Otherwise the timer recording won't take place.

Using the Timer Programming Feature

★(SV-665B/SV-265B)

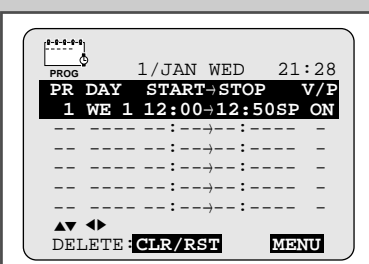
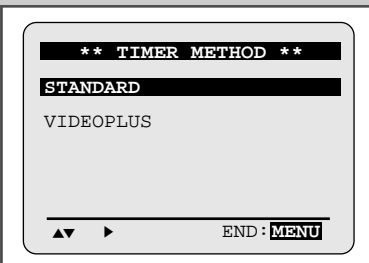

★(SV-661B/SV-662B/
SV-661I/SV-265B/
SV-261B/SV-262B/
SV-261I)

★(SV-665B)

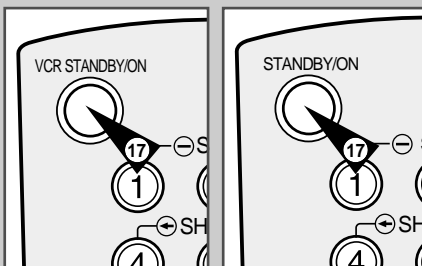

The Timer Programming feature allows you to preset the VCR to record a programme up to one month before that programme is to be broadcast. Up to six programmes can be preset.

➔ Before presetting a recording, check that the date and time are correct.

- 1 - Insert the cassette. Press the **TIMER** button. Press the **▲** or **▼** buttons to select the **STANDARD** option and then press the **▶** button or,
 - ◆ Press **MENU** on the remote control.
 - Result: The programming menu is displayed.
 - ◆ Press the **OK** button to select **TIMER PROGRAMMING** option.
 - Result: The **TIMER PROGRAMMING** menu is displayed.
- 2 Press **▶** to select the input source.
- 3 Select the required station by pressing the **▲**, **▼** buttons or **INPUT** to select the **AV1**, **AV2** or **AUX** ★(SV-665B/SV-661B/SV-662B/SV-661I only) input sources.
- 4 Press **▶** to select the recording day.
- 5 Select the required day by pressing the **▲** or **▼** buttons.
- 6 Press **▶** to select the recording start time.
- 7 Select the required hour value by pressing the **▲** or **▼** buttons.
- 8 Press **▶** to select the minutes.
- 9 Select the required minute value by pressing the **▲** or **▼** buttons.
- 10 Press **▶** to select the recording end time.
- 11 Select the required recording end time by pressing the **▲** or **▼** buttons, following the same procedure as when selecting the recording start time.
- 12 Press **▶** to select the recording speed.
- 13 Press the **▲** or **▼** buttons to select the **SP** (Standard Play), **LP** (Long Play), **AUTO** (Auto Tape Speed Select) recording speeds.
- 14 Press **▶** to select the PDC recording mode.
- 15 Press the **▲** or **▼** buttons to toggle between the PDC mode (marked **ON**) and the non-PDC mode (marked **-**).
- 16 When you have finished, press the **MENU** button.
- 17 Press the **VCR STANDBY/ON** (**STANDBY/ON**) button to activate the timer.

Result: Before starting recording, the VCR compares the timer duration with the remaining time on the cassette.

➤ Auto Tape Speed Select. The VCR's "Auto Tape Speed Select" function compares the duration of the timer recording to the actual recording time remaining on the tape loaded. If there is insufficient tape to complete a timer recording in **AUTO** mode, the VCR automatically switches to **LP** mode to record the whole programme.

Checking a Preset Recording

You can check your preset recordings:

- ◆ When you have finished presetting the VCR
- ◆ If you have forgotten which programmes will be recorded

- 1 - Insert the cassette. Press the **TIMER** button. Press the **▲** or **▼** buttons to select the **STANDARD** option and then press the **▶** button or,
 - ◆ Press **MENU** on the remote control.
 - Result: The programming menu is displayed.
 - ◆ Press the **OK** button to select **TIMER PROGRAMMING** option.
 - Result: The **TIMER PROGRAMMING** menu is displayed.
- 2 Press the **▲** or **▼** buttons to select the required programme.
- 3 Press the **◀** or **▶** buttons to select and change any values as required. For more details, refer to the previous page.
- 4 On completion, press **MENU** twice.

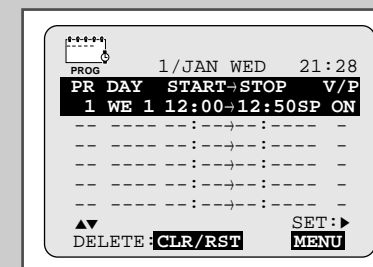

Cancelling a Preset Recording

You can cancel any programmes that are:

- ◆ Incorrect
- ◆ No longer required

- 1 - Insert the cassette. Press the **TIMER** button. Press the **▲** or **▼** buttons to select the **STANDARD** option and then press the **▶** button or,
 - ◆ Press **MENU** on the remote control.
 - Result: The programming menu is displayed.
 - ◆ Press the **OK** button to select **TIMER PROGRAMMING** option.
 - Result: The **TIMER PROGRAMMING** menu is displayed.
- 2 Select the programme to be cancelled by pressing the **▲** or **▼** buttons.
- 3 Press the **CLR/RST** button to cancel the selected programme.

Result: All the recording information is deleted and the broadcast will not be recorded.
- 4 On completion, press **MENU** twice.

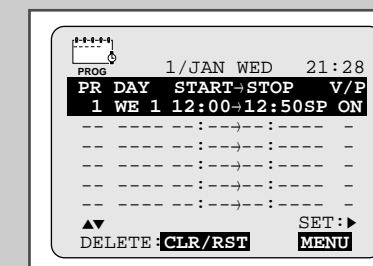

★(SV-665B)

★(SV-661B/SV-662B/
SV-661I/SV-265B/
SV-261B/SV-262B/
SV-261I)

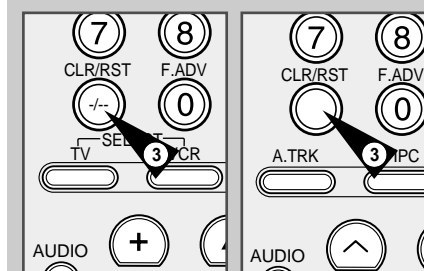

Playing a Cassette

This function allows you to play back any pre-recorded cassette.

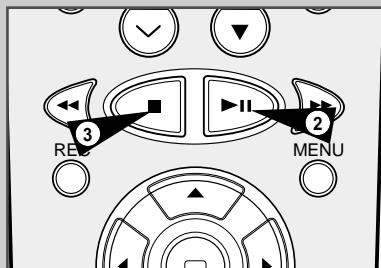

- Switch on both the television and your VCR.
 - Insert the video cassette to be played. If the safety tab on the cassette is intact, press **▶II**. Otherwise, the cassette is played automatically.
 - When a cassette is loaded, the tape position is optimized automatically to reduce disturbance (Digital Auto Tracking). When playing a cassette, if the end of the tape is reached, the cassette is rewind automatically. NTSC tapes can be played back but cannot be recorded with this VCR.
- | To... | Then press... |
|--------------------|---------------|
| Stop the playback | ■ (STOP). |
| Eject the cassette | ▲ (EJECT). |

Adjusting Picture Alignment Automatically ★(SV-661B/SV-662B/SV-661I/SV-265B/SV-261B/SV-262B/SV-261I Only)

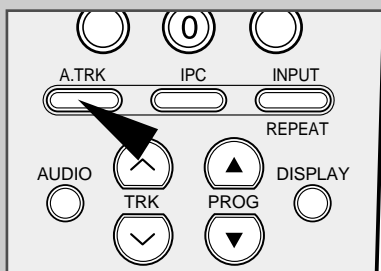

The Picture Alignment feature enables you to optimize the tape position automatically to obtain the best possible picture.

When noise bars or streaks appear during playback, adjust picture alignment by pressing the A.TRK button.

- Result:**
- ◆ The tracking bar appears.
 - ◆ The picture is automatically adjusted.
 - ◆ The tracking bar disappears when digital auto tracking has been completed.

Adjusting Picture Alignment Manually

★(SV-661B/SV-662B/SV-661I/SV-265B/SV-261B/SV-262B/SV-261I)

★(SV-665B)

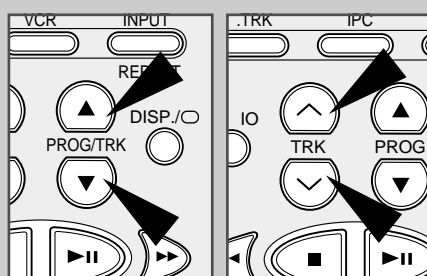

The Picture Adjustment feature allows you to adjust the alignment manually to obtain the best possible picture.

When noise bars or streaks appear during playback, adjust alignment manually by pressing the PROG/TRK (▲ or ▼) / TRK (∧ or ∨) buttons until the picture is clear and stable.

- Result:**
- ◆ The tracking bar appears.
 - ◆ The image is adjusted.
 - ◆ The tracking bar disappears when you release the button.

Intelligent Picture Control

The Intelligent Picture Control Feature allows you to adjust the sharpness of the image automatically, according to your own preferences.

- During playback, press the MENU button on the remote control.

Result: The programming menu is displayed.
- Press the corresponding ▲, ▼ or ◀, ▶ buttons to select the **USER SET** option.
- Press the OK button to select this option.

Result: The **USER SET** menu is displayed.
- Press the corresponding ▲ or ▼ buttons, until the **IPC** option is selected.
- Press the ▶ button to select the IPC (intelligent picture control) option.
 - When intelligent picture control mode is **ON**, the sharpness of the image is adjusted automatically.
- To adjust the sharpness manually, select Intelligent Picture Control mode **OFF**.
- Press the ◀ or ▶ buttons until the picture is displayed according to your preferences.
 - If you do not press a button within ten seconds, the **PICTURE** menu disappears automatically.
- On completion, press the MENU button again.

★(SV-665B/SV-661B/SV-662B/SV-661I)

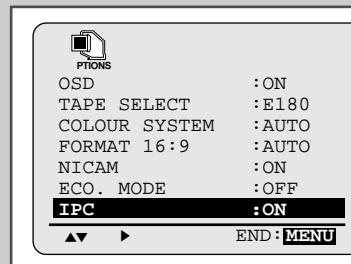

★(SV-265B/SV-261B/SV-262B/SV-261I)

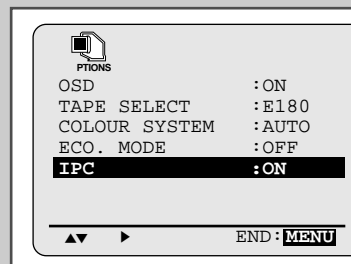

Intelligent Picture Control ★(SV-661B/SV-662B/SV-661I/SV-265B/SV-261B/SV-262B/SV-261I Only)

- During playback, press the IPC button.

Result: The **PICTURE** menu is displayed.
- Press the ▼ button to turn the IPC (Intelligent Picture Control) option **ON** and **OFF**.
 - When Intelligent Picture Control mode is **ON**, the sharpness of the image is adjusted automatically.
- To adjust the sharpness manually, press the ▼ button to turn the IPC mode **OFF**.
 - ◆ The horizontal picture adjusting appears.
- Press the ◀ or ▶ buttons until the picture is displayed according to your preferences.
 - If you do not press a button within ten seconds, the **PICTURE** menu disappears automatically.
- On completion, press the IPC button again.

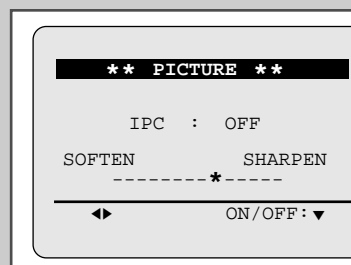
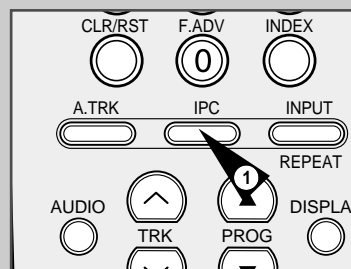

Format 16:9 (Wide Screen) ★(SV-665B/SV-661B/SV-662B/SV-661I Only)

Your VCR can automatically play Wide Screen format prerecorded tapes. It can also record Wide Screen format programmes received from sources such as a satellite receiver.

➔ Connect equipment compatible with Wide Screen to the VCR using the 21 pin SCART cable.

- Press MENU on the remote control.
Result: The programming menu is displayed.
- Press the corresponding ▲, ▼ or ◀, ▶ buttons to select the **USER SET** option.
- Press the OK button to select this option.
Result: The **USER SET** menu is displayed.
- Press the corresponding ▲ or ▼ buttons, until the **FORMAT 16:9** option is selected.
- Press the ▶ button to select **AUTO** → **ON** → **OFF**.

AUTO	Set when you use a wide TV. The VCR automatically detects if programmes being played back or recorded are in normal or Wide Screen format.
ON	The VCR always plays back and records in 16:9 Wide Screen format. Set if the VCR cannot detect Wide Screen TV programmes with "AUTO" set.
OFF	Set if you do not use a Wide Screen TV.

- On completion, press MENU twice to exit the menu.

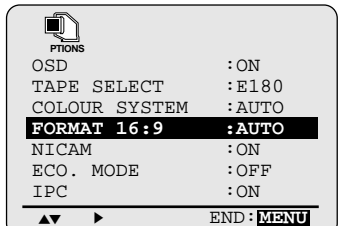
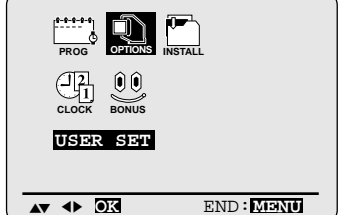

Selecting the Colour Mode

Before recording or playing back a cassette, you can select the required system standard.

Otherwise, the system automatically selects the reception standard when you select AUTO.

- When playing back a cassette, the standard is automatically selected by the VCR.
- ◆ When you playback an NTSC-recorded tape on this VCR make a setting on the colour system according to your TV. If your TV is a PAL system only TV, set NTPB. If your TV is Multi System TV (NTSC 4.43 compatible), set NT4.43 and you can record NT4.43.

- Press MENU on the remote control.
Result: The programming menu is displayed.
- Press the corresponding ▲, ▼ or ◀, ▶ buttons to select the **USER SET** option.
- Press the OK button to select this option.
Result: The **USER SET** menu is displayed.
- Press the corresponding ▲ or ▼ buttons, until the **COLOUR SYSTEM** option is selected.
- Press the ▶ button to select **AUTO** → **PAL** → **B/W**.

AUTO	When playing back a cassette, the system standard is automatically selected by the VCR.
B/W	Black and White

- On completion, press MENU twice to exit the menu.

Selecting the Audio Output Mode ★(SV-665B/SV-661B/SV-662B/SV-661I Only)

When monitoring a TV programme or playing back a Hi-Fi recorded video tape, press the AUDIO button to select a desired sound output. As the AUDIO button is pressed, the sound output and the indicator change as below:

Sound type	Stereo sound	Bilingual sound	Standard sound broadcast
OSD display			
	Heard in stereo. (left channel and right channel)	Channel I (MAIN) heard from the left speaker, channel II (SUB) heard from the right speaker.	Heard in monaural.
	Left channel heard from both the left and right speakers.	Channel I (MAIN) heard from both the left and the right speakers.	Heard in monaural.
	Right channel heard from both the left and right speakers.	Channel II-(SUB) heard from both the left and the right speakers.	Heard in monaural.
MIX	Sound mixed the left and right channels, and the normal audio track.		
MONO	Heard in monaural.	Channel I (MAIN) heard from both the left and the right speakers.	Heard in monaural.

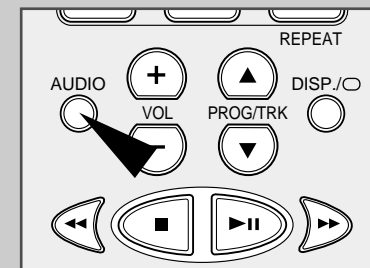

Selecting the Audio Mute Mode ★(SV-265B/SV-261B/SV-262B/SV-261I Only)

You can select the Audio Mute mode.

To select the audio mute mode on and off, simply press the AUDIO button on the remote control.

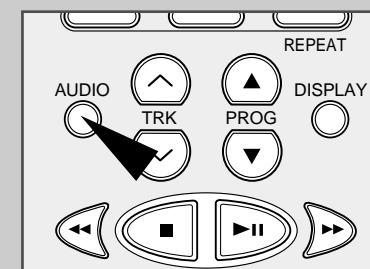

Playing a Cassette in Slow Motion ★(SV-665B/ SV-661B/SV-662B/SV-661I Only)

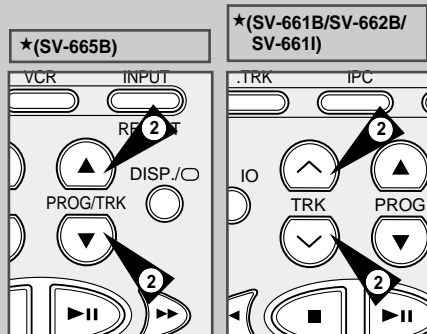
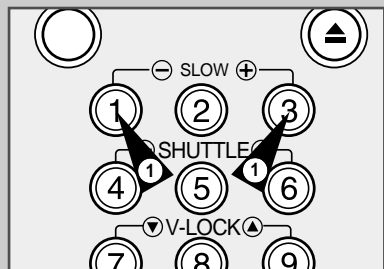

You can play a cassette in slow motion.

- No sound is heard when playing back a cassette in slow motion.

- 1 Press:
 - ◆ ▶|| to start playing the cassette
 - ◆ SLOW (⊖ ⊕) as many times as required to decrease or increase the speed respectively
 - ◆ To return to the normal speed, press the ▶|| button twice.
- 2 When playing back in slow motion, picture interference may occur. Press the PROG/TRK (▲ or ▼) / TRK (⤴ or ⤵) buttons to minimize this effect.

- ☞ When you have been using the Slow Motion function for more than about five minutes, the VCR will automatically play to protect the:
 - ◆ Cassette
 - ◆ Video heads

Playing a Sequence Frame by Frame

You can:

- ◆ Stop the cassette at a given frame (image)
- ◆ Advance one frame at a time
- No sound is heard when playing back frame by frame.

- 1 Press:
 - ◆ ▶|| to start playing the cassette
 - ◆ ▶|| to stop the tape at a given frame
 - ◆ F.ADV (Ⓜ) to advance frame by frame
- 2 To return to normal playback, press ▶||.

- ☞ When you have been using the Frame-by-Frame function for more than about five minutes, the VCR will automatically play to protect the cassette and video heads.
- Vertical stability: When playing back frame by frame, interference may be seen on the screen. Press the V-LOCK (Ⓜ) buttons to minimize this effect.

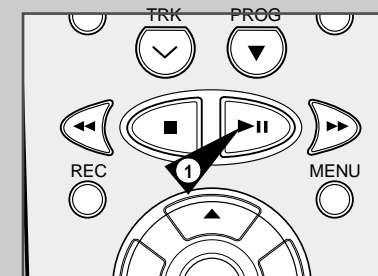

Picture Search, Fast Forward/Rewind

Picture Search enables you to Fast Forward or Rewind and look for a particular part of a tape.

- 1 Press PLAY, the VCR will enter normal play mode. While in play, press and release the ►► (or ◀◀) button. The VCR will search at 5 times the normal playback speed.
- 2 To return to normal playback mode, press the ▶|| button.
- 3 If you press and HOLD down the ►► (or ◀◀) button the VCR will search at 9 times the normal speed. Releasing the ►► button will return the VCR to search at 5 times the normal speed. To return to normal playback mode, press the ▶|| button.
- 4 Whilst in Picture Search mode, if you press the ►► button again, the VCR will enter normal Fast Forward mode.
- 5 Likewise, whilst in Picture Search ◀◀ mode, if you press the ◀◀ button again, the VCR will enter normal Rewind mode.
- 6 If, when Rewinding (◀◀) or Fast Forwarding (►►), you press the ◀◀ (or ►►) button, the VCR will enter the Picture Search mode.

Searching for a Specific Sequence

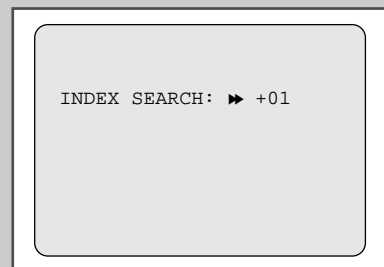
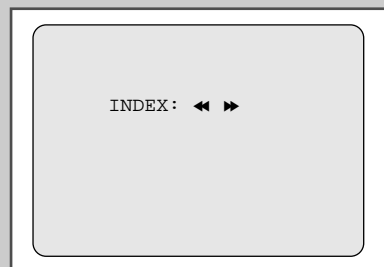

Each time you record a cassette on this VCR, an "index" is automatically marked on the tape when recording starts.

The Search function allows you to fast-forward or rewind to a specific index and start playback from that point. Depending on the direction selected, the indexes are numbered as follows:

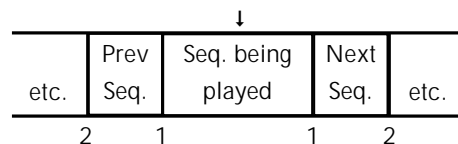

➤ This VCR uses a standard indexing system (VISS). As a result, it will recognize any indexes marked by other VCRs using the same system and vice versa.

INTRO SCAN

- 1 To search for a specific index, press INDEX.
- 2 Press the << or >> buttons depending on the direction where your desired programme is located.
- 3 When an Index mark is found the VCR will playback the tape for 5 seconds, after which it will continue searching for the next Index mark.
- 4 If you want to watch the tape from a particular Index, simply press >||.

Index Skip Search:

This feature will enable you to fast forward/rewind to a specific point on a tape: E.g. if you have recorded 3 different programmes on a tape and you have rewound the tape to the beginning, by using this feature you can go directly to the start of programme 2 simply by pressing the INDEX button.

- 1 Press the INDEX to start the Index search.
- 2 Press the << or >> buttons twice more. This will take you directly to the start of the desired programme is located.
- 3 These Index searches can be made forwards: (press >>) or backwards: (press <<).
- 4 To cancel an Index search simply press the >|| or ■ button.

Auto Repeat Play

You can set repeat play to repeat the tape continuously from beginning to end.

- 1 Press MENU on the remote control.
Result: The programming menu is displayed.
- 2 Press the corresponding ▲, ▼ or ◀, ▶ buttons to select the **EASY OPERATION** option.
- 3 Press the OK button to select this option.
Result: The **EASY OPERATION** menu is displayed.
- 4 Press the corresponding ▲ or ▼ buttons, until the **REPEAT PLAY** option is selected.
- 5

To...	Press ◀ or ▶, until...
Repeat play	ON is displayed.
Do not wish to repeat play	OFF is displayed.
- 6 On completion, press MENU twice to exit the menu.

★(SV-665B/SV-265B)

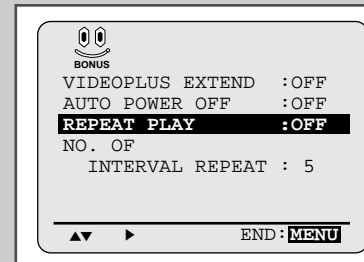

★(SV-661B/SV-662B/SV-661I/SV-261B/SV-262B/SV-261I)

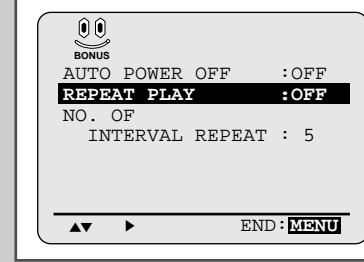

Interval Repeat Play

You can set Interval Repeat Play so that the cassette is repeated a number of times according to a specified set interval.

- 1 Press MENU on the remote control.
Result: The programming menu is displayed.
- 2 Press the corresponding ▲, ▼ or ◀, ▶ buttons to select the **EASY OPERATION** option.
- 3 Press the OK button to select this option.
Result: The **EASY OPERATION** menu is displayed.
- 4 Press the corresponding ▲ or ▼ buttons, until the **NO. OF INTERVAL REPEAT** option is selected.
- 5

To...	Press ▶, until...
Interval Repeat Play	5, 10, 15 is displayed. (choose an interval repeat of 5, 10 or 15 times)
Cancel Interval Repeat Play	OFF is displayed.
- 6 On completion, press MENU twice to exit the menu.
- 7 To select Interval Repeat Play during playback, press the INPUT/REPEAT button at the desired start point.
Result: "INTERVAL REPEAT SETTING" is displayed. Press the INPUT/REPEAT button one more time at the desired end point.
Result: The tape is automatically rewound to the start point. "INTERVAL REPEAT" is displayed.



★(SV-665B/SV-265B)

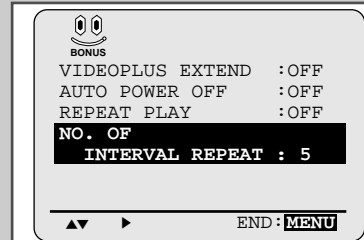

★(SV-661B/SV-662B/SV-661I/SV-261B/SV-262B/SV-261I)

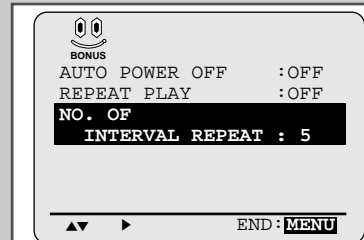

VIDEOPLUS+ EXTEND ★(SV-665B/SV-265B Only)

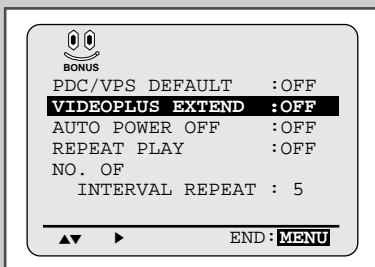

To prevent delays or over-runs the VCR has a function called Videoplus EXTEND allowing you to extend the recording time by up to 60 minutes.

➤ Only use if PDC is not available or set to OFF.

- 1 Press the MENU button on the remote control.
- 2 Press the corresponding ▲, ▼ or ◀, ▶ buttons to select the **EASY OPERATION** option.
- 3 Press the OK button to select this option.
Result: The **EASY OPERATION** menu is displayed.
- 4 Press the corresponding ▲ or ▼ buttons, until the **VIDEOPLUS EXTEND** option is selected.
- 5 Press ◀ or ▶ buttons to set the Videoplus EXTEND time by increments of 10 minutes.
- 6 To turn off, press ◀ or ▶ buttons repeatedly until **OFF** shows.

Using the Tape Counter

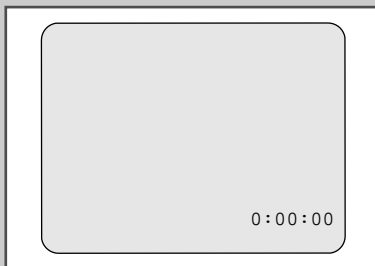

The tape counter:

- ◆ Indicates the elapsed time in the play and record modes (hours, minutes and seconds)
- ◆ Is reset when a cassette is inserted in the VCR
- ◆ Allows you to find the beginning of a sequence easily

➤ If the remaining time is to be calculated correctly, you must indicate the type of cassette being used.

- 1 Insert a cassette in your VCR.
- 2 To set the tape counter to zero at the beginning of a sequence:
 - ◆ Press DISP./O or DISPLAY twice to display the counter
 - ◆ Press CLR/RST when you want to set the tape counter to zero
- 3 When you are ready,
 - ◆ Start playback or Recording.
 - ◆ Press the ■ button.
 - ◆ To fast-forward or rewind to the sequence at which the counter was set to zero, press ◀◀ or ▶▶.

➤ Some VCR information, such as the counter, can be displayed on the television screen (unless you have deactivated the OSD mode; refer to page 17).

Press DISP./O or DISPLAY:

- ◆ Once to display the current function, programme number, recording speed, date, time and counter
- ◆ Twice to display the counter only
- ◆ Three times to display the time remaining on the cassette
- ◆ Four times to clear the display

Connecting an RCA Audio/Video Input Cable ★(SV-665B/SV-661B/SV-662B/SV-661I Only)

You can connect other audio/video equipment to your VCR using audio/video cables if the appropriate outputs are available on the equipment chosen.

Examples: ◆ You wish to copy a video cassette with the help of a second VCR (see page 40).
◆ You wish to play back and/or copy pictures taken with a camcorder (see page 40).

➤ Regardless of the type of connection chosen, you must always connect the coaxial cable supplied. Otherwise, no picture will be visible on the screen when the VCR is switched off.
◆ Make sure that both the television and the VCR are switched off before connecting the cables.

- 1 Connect one end of the RCA audio/video cable into the VIDEO INPUT socket on the front of the VCR.
- 2 Plug the other end of the audio/video cable into the appropriate output connector on the other system (VCR or camcorder).
- 3 Connect one end of the RCA audio cable supplied into the AUDIO INPUT sockets on the front of the VCR.
 - Take care to respect the colour coding of the left and right channels.
- 4 Plug the other end of the audio cable into the appropriate output connectors on the other system (VCR, camcorder or Hi-Fi sound system).

★(SV-665B/SV-661B/SV-662B/SV-661I)

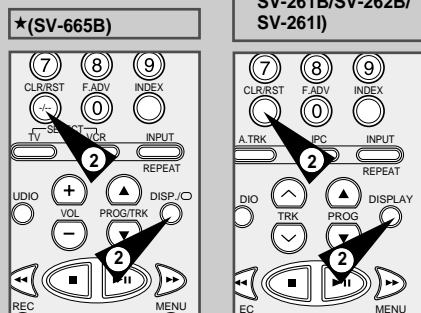
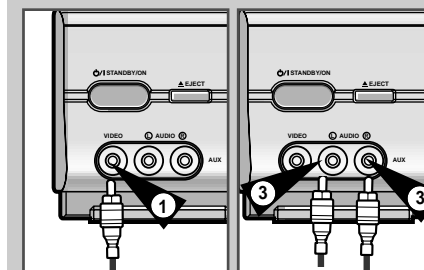

Using the Assemble Edit Function

This function allows you to start a new recording at a specific position on the cassette while maintaining a very smooth scene change.

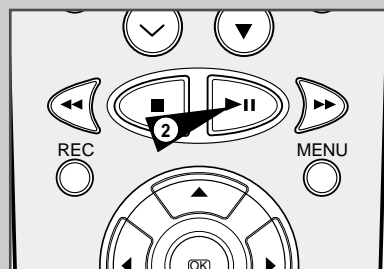

- 1 Insert the cassette to be edited in your VCR.
- 2 Press the ►|| button to start playback.
- 3 When you reach the position from which you wish to start the new recording, press the ►|| button.
- 4 Press the F.ADV (F.ADV) button again as often as necessary to advance frame by frame, until the exact recording position is located.
- 5 While the VCR is in still mode, hold the REC button down for a while to activate the Assemble Edit function.
Result: Record symbol flashes in the display.
- 6 Select the source from which you wish to record by pressing:
 - ◆ The PROG/TRK (▲ or ▼) / PROG (▲ or ▼) buttons for television channels
 - ◆ The INPUT button for the AV1, AV2 or AUX* (SV-665B/SV-661B/SV-662B/SV-661I only) input sources
- 7 Press the ►|| button to start recording.
- 8 When you have finished recording, press ■.

Recording from Another VCR or Camcorder

You can copy a cassette to your VCR from another video source, such as another VCR or a camcorder.

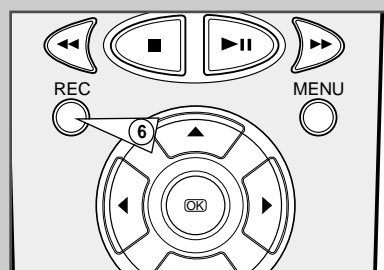
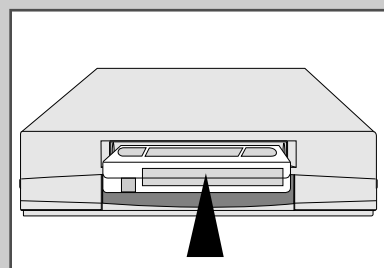

It is an infringement of copyright laws to copy prerecorded cassettes or to re-record them in any form without the permission of the owners of the corresponding copyright.

- 1 Connect the VCR, from which the cassette is to be copied, to the appropriate SCART audio and video input connectors on the rear of your VCR.
You can also use a RCA audio and video cable to connect the AUX input on the front of your VCR. *(SV-665B/SV-661B/SV-662B/SV-661I only)
- 2 Insert a blank cassette in your VCR.
- 3 Insert the pre-recorded cassette in the other video source (VCR or camcorder).
- 4 Press the INPUT button to select the appropriate input on your VCR:
 - ◆ AV1 or AV2 *(SV-665B/SV-661B/SV-662B/SV-661I only) for the SCART input
 - ◆ AUX for the RCA input *(SV-665B/SV-661B/SV-662B/SV-661I only)
- 5 Start playing back the cassette to be copied.
- 6 Hold REC down for a while to start recording on your VCR.
- 7 When you have finished recording, press ■ on both VCRs.

If you wish to view the cassette being copied:

- ◆ Your VCR must be connected as usual to the television (see page 12 for further details)

Using the TV Buttons on the Remote Control *(V-665B Only)

Your VCR remote control will work with Samsung televisions and compatible brands.

To determine whether your television is compatible, follow the instructions below.

- 1 Switch your television on.
- 2 Point the remote control towards the television.
- 3 Hold down the TV button and enter the two-figure code corresponding to the brand of your television, by pressing the appropriate numeric buttons.

Brand	Codes	Brand	Codes
SAMSUNG	01 to 06	PHILIPS	02, 20, 22
AKAI	09, 23	SABA	13, 14, 22 to 24
GRUNDIG	09, 17, 21	SONY	15, 16
LOEWE	02	THOMSON	13, 14, 24
PANASONIC	08, 23 to 27	TOSHIBA	07, 16 to 19, 21

Result: If your television is compatible with the remote control, it is switched off. It is now programmed to operate with the remote control.

➤ If several codes are indicated for your television brand, try each one in turn until you find one that works.

When you change the batteries in the remote control, you must reprogramme the code, following the same procedure.

You can then control the television using the following buttons.

Button	Function
TV STANDBY/ON ①	Used to switch the television on and off.
TV or VCR ②	Used to switch between the TV and VCR modes. Only the VOL (+ or -) and TV STANDBY/ON buttons are operational in VCR mode.
-/- ③	Used to enter a two-figure programme number. Example: For programme 12, press -/- followed by numeric buttons 1 and 2.
INPUT ④	Used to select an external source.
VOL + or - ⑤	Used to adjust the volume of the television.
PROG/TRK (▲ or ▼) ⑥	Used to select the required programme.
DISP./O ⑦	Used to switch between an external source and the television tuner.

➤ The various functions will not necessarily work on all televisions. If you encounter problems, operate the television directly.

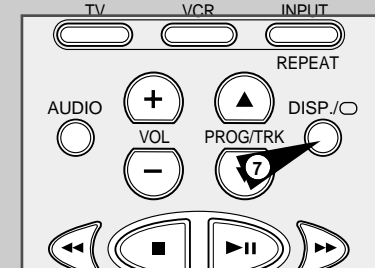
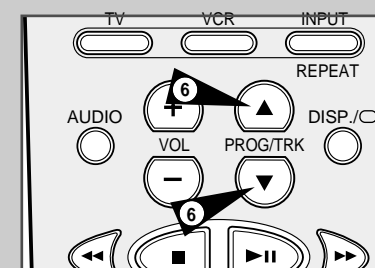
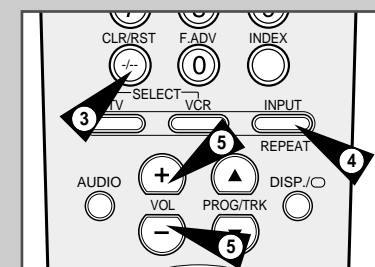
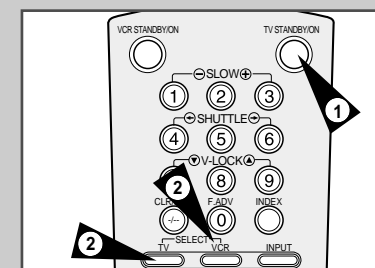

Auto Power Off

★(SV-665B/SV-265B)

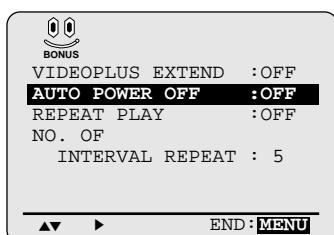

★(SV-661B/SV-662B/SV-661B/SV-261B/SV-262B/SV-261I)

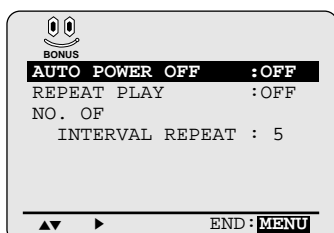

The Auto Power Off feature automatically turns off your VCR if no signal is received and you do not press any button for the selected time.

- 1 Press MENU on the remote control.
Result: The programming menu is displayed.
- 2 Press the corresponding ▲, ▼ or ◀, ▶ buttons to select the **EASY OPERATION** option.
- 3 Press the OK button to select this option.
Result: The **EASY OPERATION** menu is displayed.
- 4 Press the corresponding ▲ or ▼ buttons, until the **AUTO POWER OFF** option is selected.
- 5 Press the ▶ button, until you select the time of Auto Power off interval.
- 6 On completion, press MENU twice to exit the menu.

Child Door Lock System ★(SV-665B/SV-661B/SV-662B/SV-661I/SV-265B/SV-261B/SV-262B/SV-261I)

With this mechanism you can prevent children from harming themselves or the VCR. It stops fingers and small articles from entering your VCR.

ECO Mode-Reducing Standby power consumption

★(SV-665B/SV-661B/SV-662B/SV-661I)

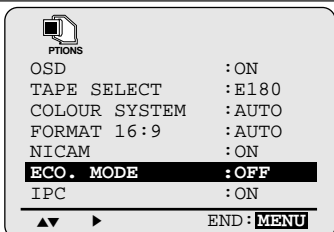

★(SV-265B/SV-261B/SV-262B/SV-261I)

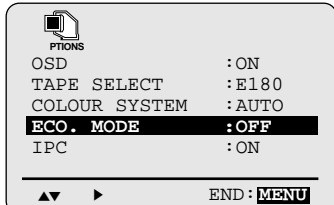

Low Power Mode reduces the Standby power consumption of the VCR when in Standby mode. Useful, for example, when you are away from the house on holiday. It saves actually turning the VCR off.

- 1 Press MENU on the remote control.
Result: The programming menu is displayed.
- 2 Press the corresponding ▲, ▼ or ◀, ▶ buttons to select the **USER SET** option.
- 3 Press the OK button to select this option.
Result: The **USER SET** menu is displayed.
- 4 Press the corresponding ▲ or ▼ buttons, until the **ECO. MODE** is selected.
- 5 Press the ▶ button to turn LOW(3Watts) mode on. Now, when the VCR is standby mode the front display panel will shut off. Even the clock disappears. By pressing the VCR STANDBY/ON (STANDBY/ON) button again the display panel will reappear.
- 6 On completion, press MENU twice to exit the menu.

Technical Specifications

Design and specifications are subject to change without notice.

MODEL	SV-665B/SV-661B SV-662B/SV-661I	SV-265B/SV-261B/SV-262B/SV-261I
Format Heads	VHS PAL standard Video: 4 rotary heads Hi-Fi audio: 2 rotary heads	VHS PAL standard Video: 2 rotary heads
Receiving channel	Audio/Control: 1 stationary head Erase: 1 full track erase head UHF (SV-665B/SV-661B/SV-662B) VHF-I, VHF-III, UHF, (SV-661I) Interband/Hyperband STANDARD I	Audio/Control: 1 stationary head Erase: 1 full track erase head UHF (SV-265B/SV-261B/SV-262B) VHF-I, VHF-III, UHF, (SV-261I) Interband/Hyperband STANDARD I
Television system Luminance Colour system	FM azimuth recording PAL/NT4.43: Down converted subcarrier phase shifted direct recording NTSC PB on PAL TV	FM azimuth recording PAL/NT4.43: Down converted subcarrier phase shifted direct recording NTSC PB on PAL TV
Tape speed	SP 23.39 mm/sec LP 11.69 mm/sec	SP 23.39 mm/sec LP 11.69 mm/sec
Recording/playback time	SP 3 hours (E-180 Tape) LP 6 hours (E-180 Tape)	SP 3 hours (E-180 Tape) LP 6 hours (E-180 Tape)
REW time	About 60 sec in REW with E-180	About 60 sec in REW with E-180
VIDEO Input Output Signal-to-noise ratio Horizontal resolution	0.5 to 2.0 Vp-p; 75 ohm unbalanced 1.0 ± 0.2 Vp-p; 75 ohm unbalanced Better than 43 dB (SP) More than 240 lines	0.5 to 2.0 Vp-p; 75 ohm unbalanced 1.0 ± 0.2 Vp-p; 75 ohm unbalanced Better than 43 dB (SP) More than 240 lines
AUDIO Input Output Wow and flutter (WTD) Signal-to-noise ratio Frequency response	-8 dBm, 47 Kohm unbalanced -8 ± 3 dBm, 1 Kohm unbalanced 0.4% max (SP) 68 dB min (IHF A filter) 20Hz - 20kHz	-8 dBm, 47 Kohm unbalanced -8 ± 3 dBm, 1 Kohm unbalanced 0.4% max (SP) 42 dB min (IHF A filter) 100Hz - 8kHz
Power requirement Power consumption Operation temperature Operation humidity Weight Dimensions (WxHxD)	220-240V~, 50 Hz Approx. 17 watts 41°F-104°F (5°C-40°C) 10%-75% 2.8 Kg (net) 360 x 94 x 240 mm	220-240V~, 50 Hz Approx. 15 watts 41°F-104°F (5°C-40°C) 10%-75% 2.8 Kg (net) 360 x 94 x 240 mm

Problems and Solutions

Before contacting the Samsung after-sales service, perform the following simple checks.

Problem	Explanation/Solution
No power	<ul style="list-style-type: none"> ◆ Check that the power plug is connected to a wall outlet. ◆ Have you pressed the VCR STANDBY/ON (STANDBY/ON) button?
You cannot insert a video cassette	<ul style="list-style-type: none"> ◆ A video cassette can only be inserted with the window side up and the safety tab facing you.
The television programme was not recorded	<ul style="list-style-type: none"> ◆ Check the VCR aerial connections. ◆ Is the VCR tuner properly set? ◆ Check if the safety tab is intact on the cassette.
Timer recording was unsuccessful	<ul style="list-style-type: none"> ◆ Was the VCR STANDBY/ON (STANDBY/ON) button pressed to activate the timer? ◆ Re-check the recording start/stop time settings. ◆ If there was a power failure or interruption during timer recording, the recording will have been cancelled.
No playback picture or the picture is distorted	<ul style="list-style-type: none"> ◆ Check to see if you are using a prerecorded tape.
You cannot see normal broadcasts	<ul style="list-style-type: none"> ◆ Check the TUNER/EXTERNAL setting. It should be on TUNER. ◆ Check the TV/VCR aerial connections.
Noise bars or streaks on playback	<ul style="list-style-type: none"> ◆ Press the PROG/TRK (▲ or ▼) / TRK (↖ or ↗) buttons to minimize this effect.
When the ► button is pressed during playback, the still picture has severe "noise bars" streaks	<ul style="list-style-type: none"> ◆ A still picture may have "noise bars", depending on the condition of the tape. Press the PROG/TRK (▲ or ▼) / TRK (↖ or ↗) buttons during SLOW motion to minimize this effect.
Video Head Cleaning	<ul style="list-style-type: none"> ◆ If poor pictures appear on a variety of cassettes, the video heads may need cleaning. This is not a common problem and unless it appears, the heads should not be cleaned. When cleaning the video heads, read all instructions provided with the head cleaning cassette. Incorrect head cleaning can permanently damage the video heads.
If when tuning in your TV to the VCR test pattern your TV does not find the test pattern or the pattern when found suffers from interference, it may be due to the VCR output channel clashing with the normal TV transmissions in your area. To prevent this you will need to change the VCR output channel in the following way	<ol style="list-style-type: none"> 1. Remove the aerial input plug from the socket marked (aerial symbol) on the rear of the VCR. 2. Carry out the instructions "Tuning Your Television for the VCR" (see page 15). 3. Carry out the instructions "Setting the VCR output Channel" (see page 17), move the channel number several channels down from the original setting. (example: from 60 to 57). 4. Replace the aerial plug into the socket marked (aerial symbol) on the rear of the VCR. 5. Re-tune your TV to the VCR again by following instructions "Tuning Your Television for the VCR" (page 15). 6. If the problem still exists repeat steps 1 to 5 moving several more channels away from the original setting.

If you are unable to solve the problem after reading the above instructions, note:

- ◆ The model and serial number on the rear of your VCR
- ◆ The warranty information
- ◆ A clear description of the problem

Then contact your nearest SAMSUNG after-sales service.

SAMSUNG ELECTRONICS (UK) LTD AUTHORISED SERVICE CENTERS

In the event of warranty service being required, please contact your retailer first. If they cannot provide service, please contact your nearest service centre listed below. Service facilities are return to base, however some agents may provide an in-home service (there may be a cost for call out). Please refer to your warranty card or retailer for terms and conditions of the warranty.

AVON BRISTOL GOGGLEBOX TV TEL: 01275 838083	ESSEX WICKFORD CENTRAL SERVICE TEL: 01268 766333	LONDON WILLESDEN ATLANTIC ELECTRIC TEL: 0181 451 6155	WEST MIDLANDS DUDLEY J S STOREY ELECTRICAL TEL: 01384 455608 WALSALL BEAVER ELECTRONICS TEL: 01922 725554 WARLEY MERRIVALE TV SVCS TEL: 0121 544 6273/6350
BERKSHIRE READING A & W SOUND & VISION TEL: 01734 872000 MAIDENHEAD J F ASSOCIATES TEL: 01628 25709 WARGRAVE J F ASSOCIATES TEL: 01734 401525	MID GLAMORGAN BRIDGEND BRIDGEND SERVICE TEL: 01656 663463	MANCHESTER ASHTON UNDER LYNE VIDEOTECH UK TEL: 0161 308 4092 NORTHENDEN G H SUMNER LTD TEL: 0161 998 2705	WILTSHIRE SWINDON COLORITE TV LTD TEL: 01793 641038
CAMBRIDGESHIRE DRY DRAYTON DRAYTON ELECTRONICS TEL: 01954 211330 PETERBOROUGH DEEPIING TV SVCS TEL: 01778 343831	GLOUCESTERSHIRE TREWESBURY SWITCH ELECTRONICS TEL: 01684 850063 WESTON-SUB-EDGE PROFESSIONAL ELECTRONIC TEL: 01386 841773	MERSEYSIDE ELLESMERE PORT H & H VIDEO & TV TEL: 0151 357 1011 LIVERPOOL P & A AUDIO VIDEO LTD TEL: 0151 924 7287	WORCESTERSHIRE WORCESTER THE HI FI CAR RADIO REPAIR TEL: 01905 26623
CHESHIRE CHESTER H & H VIDEO & TV TEL: 01244 379579 WARRINGTON W L ELECTRONICS TEL: 01925 764387	HAMPSHIRE FAREHAM SOUND & VISION TEL: 01329 286551 FARNBOROUGH ICTV TEL: 01252 510118 PORTSMOUTH ICTV TEL: 01705 653654 SOUTHAMPTON OLYMPIC TV & AUDIO TEL: 01703 703401	MIDDLESEX HAYES A & A REPAIRS TEL: 0181 561 2900/4104	SOUTH YORKSHIRE SHEFFIELD GRAPHIC ELECTRONIC SVCS TEL: 0114 256 2791 BARNSELEY ALTRA TEL: 01226 207434
CORNWALL BUDE H B H WOOLACOTTS TEL: 01288 352269 LAUNCESTON H B H WOOLACOTTS TEL: 01566 772096 NEWQUAY GREENBANK ELECTRONICS TEL: 01637 880576 WADEBRIDGE H B H WOOLACOTTS TEL: 01208 816155	HEREFORD HEREFORD J P MICRO SVCS TEL: 01432 356353	NORFOLK AYLESHAM CORTONS ELECTRICAL TEL: 01263 733391 WATTON JULIAN HORN TEL: 01953 881440	NORTH YORKSHIRE YORK DBS SERVICE CENTRE TEL: 01904 789789
CUMBRIA BARROW IN FURNESS KENNETH GARDNER TEL: 01229 821202 SEARLE AUDIO TEL: 01229 839692 PENRITH CANNAN & BROWN TEL: 01768 864829	HERTFORDSHIRE BALDOCK TECHNICAL REPAIR SVC TEL: 01462 491144 MARKYATE TELETECH SVCS TEL: 01582 841862	NORTHAMPTONSHIRE KETTERING INTEGRATED SVCS TEL: 01536 516475	WEST YORKSHIRE BRADFORD GRAPHICK ELECTRON TEL: 01274 862267 HUDDERSFIELD GRAPHIC ELECTRONICS TEL: 01484 451045 ILKLEY R BEAUMONT TEL: 01943 607021
DEVON HOLSWORTHY H B H WOOLACOTTS TEL: 01409 253280 NEWTON ABBOT TELLI-SCOPE ELECTRONICS TEL: 01626 63907 PLYMOUTH ARGYLE TV & VIDEO TEL: 01752 779933 CTV ELECTRONICS TEL: 01752 350950	HERTFORDSHIRE GOOLE HEADLAND ELECTRCRS TEL: 01977 661223	OXFORDSHIRE BANBURY HITECH TEL: 01295 267415 BOTLEY SPECTRUM ELECTRON TEL: 01865 250199	CHANNEL ISLANDS GUERNSEY TELESKILL LTD TEL: 01481 56508 JERSEY ALTERNATIVE ELECT TEL: 01534 68277 ISLE OF WIGHT AUDIO VISION SVCS TEL: 01983 752023
DORSET BOURNEMOUTH M & G ELECTRONICS TEL: 01202 523771	NORTH HUMBERISDE HEADLAND ELECTRCRS TEL: 01977 661223	SHROPSHIRE TELFORD W OWEN TEL: 01952 613818	NORTHERN IRELAND CO ARMAGH CRAIGAVON TV SVCS TEL: 0762 326119/322505
DURHAM DURHAM LEE TECH SVCS TEL: 0191 371 1300 DARLINGTON GAZE ELECTRONICS TEL: 01325 482344	SOUTH HUMBERSIDE GRIMSBY RAYNERS SUPERSTORE TEL: 01472 358766	SOMERSET TAUNTON ARMTECH ELECTRONICS TEL: 01823 279401 YEOVIL M J THOMAS TEL: 01935 477255	EIRE CO CORK TVAE REPAIRS TEL: 00353 21 273457
DYFED CARMARTHEN ADVANCE CONSUMER TEL: 01267 236143 ST CLEARS BEN EVANS & SON TEL: 01994 231015	KENT CANTERBURY BARRETT'S OF CANTERBURY TEL: 01227 766582 DARTFORD BUDGET REPAIR CENTRE TEL: 01322 227668 MAIDSTONE AVERY ELECTRONICS TEL: 01622 682138	STAFFORDSHIRE STOKE ON TRENT TELEFAULTS (S.O.T.) LTD TEL: 01782 813757	GRAMPIANS FRASERBURGH RODGERS ELECTRICAL TEL: 01346 518540
	LANCASHIRE BLACKPOOL KENNETH GARDNER TEL: 01253 824047 LANCASTER KENNETH GARDNER TEL: 01524 64468 ROCHDALE CTV SERVICES TEL: 01706 654983	SUFFOLK IPSWICH GGN LTD TEL: 01473 744300	HIGHLANDS ULLAPOOL R & R ELECTRONICS TEL: 01854 612608
	LEICESTERSHIRE LEICESTER SOUNT & VISION CENTRE TEL: 01162 730444	SURREY WALLINGTON SERVICECARE TEL: 0181 669 1145 HORLEY D K AUDIO VISUAL SVCS TEL: 01293 786459	LOTHIAN EDINBURGH RETEC AUDIO & VISUAL TEL: 0131 478 7779
	LINCOLNSHIRE BRANSTON STUART WALLACE TEL: 01522 791496	EAST SUSSEX SEAFORD CLEARVIEW RENTAL & RELAY TEL: 01323 898989 EASTBOURNE STARTEC SVCS TEL: 01323 412012	STRATHCLYDE GLASGOW DSC ELECTRONICS TEL: 0141 941 3711
	LONDON HIGH HOLBORN BERRYS OF HOLBORN TEL: 0171 405 1157	TYNE & WEAR NEWCASTLE UPON TYNE M SINGH RADIO & TV TEL: 0191 226 0446	TAYSIDE DUNDEE ANCRUM ELECTRONICS TEL: 01382 454511
ESSEX BRAINTREE GWYNNE TV & ELECTRICAL TEL: 01376 322567	LONDON ARMSTRONG SERVICES TEL: 0181 523 0023/0051 WEST EALING BABBER ELECTRONICS TEL: 0181 579 6315	WEST MIDLANDS COVENTRY D & J HENRY TEL: 01203 431393	



ELECTRONICS

WARRANTY CARD

GUARANTEE

GARANZIA

GARANTI

GARANTÍA

GARANTIE

GARANTIA

ΕΓΓΥΗΣΗ

TAKUU

SAMSUNG EUROPEAN BLOC WARRANTY

MODEL NAME
 Modelinaam, Nombre de modelo, Nombre del modelo, Nome de modelo, Modellbezeichnung, Modelnaam,
 Nom du modèle, Il nome di modello, Montevio proi-ovntoi, Asiakkaan puh.nro, Modelinamen, Modell

SERIAL NO.
 Seriennummer, No. de serie, Número serial, Seriennummer, Serie nummer, Numéro de série,
 Il numero di matricola, Atrqmovi katasteuthvi, Malli, Seriennummer., Serien

DATE OF PURCHASE
 Kõbeid, Kõbsadato, Fecha de compra, Data de compra, Kaufdatum, Datum van aankoop, Date d'achat,
 La data d'acquisto, Hmeromnivva agoravi agorasthv, Asiakkaan osote, Salgsdato, Inkõpsdatum

CUSTOMER'S NAME
 Kundesnavn, Kundenavn, Nombre de cliente, Nombre del cliente, Nome de cliente, Name des Kunden,
 Naam van klant, Nom du client, il nome del cliente, Onomatepwnvno tou agopasthv, Saitjanro, Kundens navn, Kundens namn

CUSTOMER'S TEL. NO.
 Kundesadress, Kundelelofonnummer, No. de Tel. de client, No. de Tel del cliente, Número de telefono de cliente,
 Telefonnummer des Kunden, Telefon nummer van klant, Numéro de téléphone du client, il numero de telefono del client ,
 Atrqmovi thlefvwvou tou agorasthv, Myjjan puh.nro, Kundens telefonnr, Kundens telefonnr.

CUSTOMER'S ADDRESS
 Kundeadress, Kundeadresse, Dirección de client, Dirección del cliente, Endereço de cliente, Adresse des Kunden,
 Adres van klant, adresse du client, L'indirizzo del cliente, Dieuvqunsh tou agopasthv, Ostõpõivõ, Kundens adresse,
 Customer's address

DEALER'S NAME
 Handelsnavn, Forhandler, Nombre de negociante, Nombre del vendedor, Nome de vendedor, Name des Händlers,
 Naam van handelaar, Nom du marchand, il nome del commerciante, Onoma tou katasthvmato, Jalleemyjjan, Forhandler,
 Aterforsaljare

DEALER'S TEL. NO.
 Handelsstelesonnummer, Forhandlertelefonnummer, No. de Tel. de negociante, No. de Tel. del vendedor,
 Número de telefono de vendedor, Telefonnummer des Handlers, Telefon nummer van handelaar, Numéro tél.phone du
 marchand, il numero di telefono del commerciante, Atrqmovi thlefvwvou tou katasthvmato, Myjjan osote, Forhandlerens
 tel.nr., Handlarenens telefonnr.

DEALER'S ADDRESS
 Handelsadress, Forhandleradresse, Dirección de negociante, Dirección del vendedor, Endereço de vendedor,
 Adresse des Händlers, Adres van handelaar, Adresse du marchand, Dieuvqunsh tou katasthvmato, Asiakkaan nimi,
 Forhandlerens adresse, Handlarenens adress

DEALER'S STAMP & SIGNATURE

CAUTION

Please ensure the form above is completed at the time of purchase and present it to the dealer to quality for guarantee service, otherwise your guarantee may be affected.

CUSTOMER'S SIGNATURE



UNITED KINGDOM



REPUBLIC OF IRELAND

This Samsung product is warranted for the period of twelve (12) months from the original date of purchase, against defective materials and workmanship. In the event that warranty service is required, you should return the product to the retailer from whom it was purchased.

However, Samsung Authorised Dealers and Authorised Service Centres in other EC Countries will comply with the warranty on the terms issued to purchasers in the country concerned. In case of difficulty, details of our Authorised Service Centres are available from:

**Samsung Electronics (U.K.) Ltd.,
Euro Service Centre, Stafford Park 12,
TELFORD, Shropshire TF3 3BJ,
Tel: 0870) 2420303, Fax: 01952) 297617**

WARRANTY CONDITIONS

1. The warranty is only valid if, when warranty service is required, the warranty card is fully and properly completed and is presented with the original invoice or sales slip or confirmation, and the serial number on the product has not been defaced.
2. Samsung's obligations are limited to the repair or, at its discretion, replacement of the product or the defective part.
3. Warranty repairs must be carried out by Authorised Samsung Dealers or Authorised Service Centres. No re-imbursment will be made for repairs carried out by non Samsung Dealers and, any such repair work and damage to the products caused by such repair work will not be covered by this warranty.

4. This product is not considered to be defective in materials nor workmanship by reason that it requires adaptation in order to conform to national or local technical or safety standards in force in any Country other than the one for which the product was originally designed and manufactured. This warranty will not cover, and no re-imbursment will be made for such adaptation nor any damage which may result.

5. This warranty covers none of the following:

- a) Periodic check ups, maintenance and repair or replacement of parts due to normal wear and tear.
- b) Cost relating to transport, removal or installation of the product.
- c) Misuse, including the failure to use this product for its normal purposes or incorrect installation.
- d) Damage caused by Lightning, Water, Fire, Acts of God, War, Public Disturbances, incorrect mains voltage, improper ventilation or any other cause beyond the control of Samsung.

6. This warranty is valid for any person who legally acquired possession of the product during the warranty period.

7. The consumers statutory rights in any applicable national legislation whether against the retailer arising from the purchase contract or otherwise are not affected by this warranty. Unless there is national legislation to the contrary, the rights under this warranty are the consumers sole rights and Samsung, its subsidiaries and distributors shall not be liable for indirect or consequential loss or any damage to records, compact discs, videos or audio taper or any other related equipment or material.

SAMSUNG ELECTRONICS (U.K.) LTD.

THIS APPLIANCE IS DISTRIBUTED BY

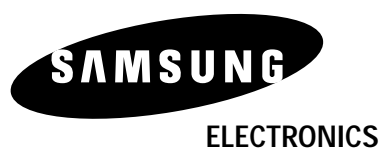

Free Manuals Download Website

<http://myh66.com>

<http://usermanuals.us>

<http://www.somanuals.com>

<http://www.4manuals.cc>

<http://www.manual-lib.com>

<http://www.404manual.com>

<http://www.luxmanual.com>

<http://aubethermostatmanual.com>

Golf course search by state

<http://golfingnear.com>

Email search by domain

<http://emailbydomain.com>

Auto manuals search

<http://auto.somanuals.com>

TV manuals search

<http://tv.somanuals.com>