

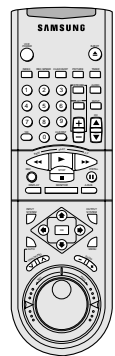

# WORLDWIDE VIDEO CASSETTE RECORDER SV-7000W

## Owner's Instructions

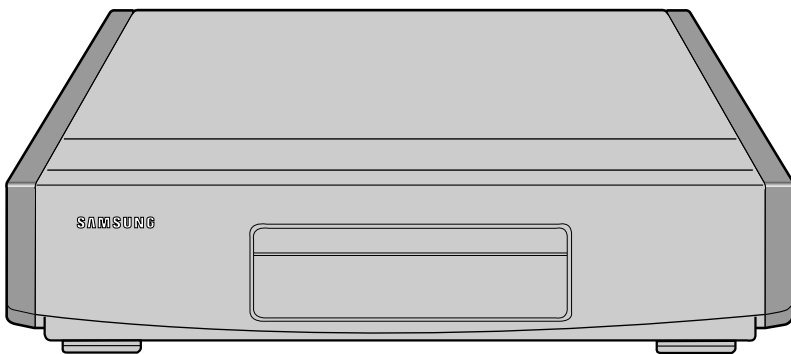

## IMPORTANT SAFETY INSTRUCTIONS

To ensure proper warranty, please return your registration card within two weeks. Record the serial number from the back of the VCR and the date of purchase in the space below. Keep your purchase receipt with this manual for easy reference.

Model Number \_\_\_\_\_  
Serial Number \_\_\_\_\_  
Date Purchased \_\_\_\_\_  
Dealer \_\_\_\_\_

### IMPORTANT SAFETY INSTRUCTIONS

#### CAUTION

RISK OF ELECTRIC SHOCK  
DO NOT OPEN

CAUTION: TO REDUCE THE RISK OF ELECTRIC SHOCK, DO NOT REMOVE COVER (OR BACK). NO USER SERVICEABLE PARTS INSIDE. REFER SERVICING TO QUALIFIED SERVICE PERSONNEL.



This symbol indicates high voltage is present inside. It is dangerous to make any kind of contact with any inside part of this product.



This symbol alerts you that important literature concerning operation and maintenance has been included with this product.

**Note to CATV system installer:** This reminder is provided to call CATV system installer's attention to Article 820-40 of the National Electrical Code (Section 54 of Canadian Electrical Code, Part I), that provides guidelines for proper grounding and, in particular, specifies that the cable ground shall be connected to the grounding system of the building as close to the point of cable entry as practical.

**Caution:** FCC regulations state that any unauthorized changes or modifications to this equipment may void the user's authority to operate it.

**Caution:** To prevent electric shock, match wide blade of plug to wide slot, fully insert.

**Attention:** pour éviter les chocs électriques, introduire la lame la plus large de la fiche dans la borne correspondante de la prise et pousser jusqu'au fond.

**Important:** One Federal Court has held that unauthorized recording of copyrighted TV programs is an infringement of U.S. copyright laws.

Certain Canadian programs may be copyrighted and any unauthorized recording in whole or in part may be a violation of these rights.

**To prevent damage which may result in fire or electric shock hazard, do not expose this appliance to rain or moisture.**

1. **Read Instructions**-All the safety and operating instructions should be read before the product is operated.
2. **Retain Instructions**-The safety and operating instructions should be retained for future reference.
3. **Heed Warnings**-All warnings on the product and in the operating instructions should be adhered to.
4. **Follow Instructions**-All operating and use instructions should be followed.

# IMPORTANT SAFETY INSTRUCTIONS

5. **Cleaning**-Unplug this product from the wall outlet before cleaning. Do not use liquid cleaners or aerosol cleaners. Use a damp cloth for cleaning.
6. **Attachments**-Do not use attachments not recommended by the product manufacturer as they may cause hazards.
7. **Water and Moisture**-Do not use this product near water-for example near a bath tub, wash bowl, kitchen sink, or laundry tub; in a wet basement; or near a swimming pool; and the like.
8. **Accessories**-Do not place this product on an unstable cart, stand, tripod, bracket, or table. The product may fall, causing serious injury to a child or adult, and serious damage to the product. Use only with a cart, stand, tripod, bracket, or table recommended by the manufacturer or sold with the product. Any mounting of the product should follow the manufacturer's instructions and should use a mounting accessory recommended by the manufacturer.
9. **Cart Usage**-A product and cart combination should be moved with care. Quick stops, excessive force, and uneven surfaces may cause the product and cart combination to overturn.
10. **Ventilation**-Slots and openings in the cabinet are provided for ventilation and to ensure reliable operation of the product and to protect it from overheating. These openings must not be blocked or covered. The openings should never be blocked by placing the product on a bed, sofa, rug, or other similar surface. This product should not be placed in a built-in installation such as a bookcase or rack unless proper ventilation is provided or the manufacturer's instructions have been adhered to.
11. **Power Sources**-This product should be operated only from the type of power source indicated on the marking label. If you are not sure of the type of power supplied to your home, consult your product dealer or local power company.
12. **Grounding or Polarization**-This product may be equipped with a polarized alternating-current line plug (a plug having one blade wider than the other). This plug will fit into the power outlet only one way. This is a safety feature. If you are unable to insert the plug fully into the outlet, try reversing the plug. If the plug should still fail to fit, contact your electrician to replace your obsolete outlet. Do not defeat the safety purpose of the polarized plug.
13. **Power-Cord Protection**-Power-supply cords should be routed so that they are not likely to be walked on or pinched by items placed upon or against them, paying particular attention to cords at plugs, convenience receptacles, and the point where they exit from the product.
14. **Outdoor Antenna Grounding**-If an outside antenna or cable system is connected to the product, be sure the antenna or cable system is grounded so as to provide some protection against voltage surges and built-up static charges. Section 810 of the National Electrical Code, ANSI/NFPA 70 provides information with regard to proper grounding of the mast and supporting structure, grounding of the lead-in wire to an antenna discharge unit, size of grounding conductors, location of antenna-discharge unit, connection to grounding electrodes, and requirements for the grounding electrode.
15. **Lightning**-For added protection for this product during a lightning storm or when it is left unattended and unused for long periods of time, unplug it from the wall outlet and disconnect the antenna or cable system. This will prevent damage to the product due to lightning and power-line surges.
16. **Power Lines**-An outside antenna system should not be located in the vicinity of overhead power lines or other electric light or power circuits, or where it can fall into such power lines or circuits. When installing an outside antenna system, extreme care should be taken to keep from touching such power lines or circuits as contact with them might be fatal.
17. **Overloading**-Do not overload wall outlets, extension cords, or integral convenience receptacles as this can result in a risk of fire or electric shock.

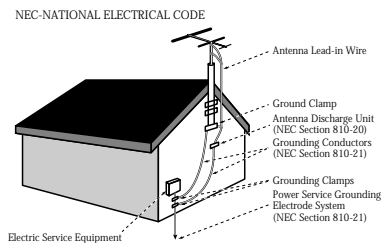

- 
18. **Object and Liquid Entry**-Never push objects of any kind into this product through openings as they may touch dangerous voltage points or short-out parts that could result in a fire or electric shock. Never spill liquid of any kind on the product.
  19. **Servicing**-Do not attempt to service this product yourself as opening or removing covers may expose you to dangerous voltage or other hazards. Refer all servicing to qualified service personnel.
  20. **Damage Requiring Service**-Unplug this product from the wall outlet and refer servicing to qualified service personnel under the following conditions:
    - a When the power-supply cord or plug is damaged.
    - b If liquid has been spilled or objects have fallen into the product.
    - c If the product has been exposed to rain or water.
    - d If the product does not operate normally by following the operating instructions. Adjust only those controls that are covered by the operating instructions as an improper adjustment of other controls may result in damage and will often require extensive work by a qualified technician to restore the product to its normal operation.
    - e If the product has been dropped or damaged in any way.
    - f When the product exhibits a distinct change in performance-this indicates a need for service.
  21. **Replacement Parts**-When replacement parts are required, be sure the service technician has used replacement parts specified by the manufacturer or that have the same characteristics as the original part. Unauthorized substitutions may result in fire, electric shock, or other hazards.
  22. **Safety check**-Upon completion of any service or repairs to this product, ask the service technician to perform safety checks to determine that the product is in proper operating condition.
  23. **Heat**-The product should be situated away from heat sources such as radiators, heat registers, stoves, or other products (including amplifiers) that produce heat.

# Quick Reference Guide

## To record a Program now

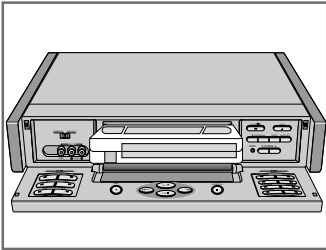

Insert the cassette.

## To record a Program and let it stop automatically

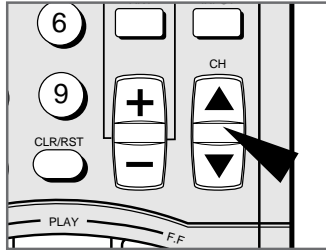

Insert the cassette.  
Select the channel by pressing the CH buttons (▲ or ▼) on the remote control.

## To record a Program when you're away

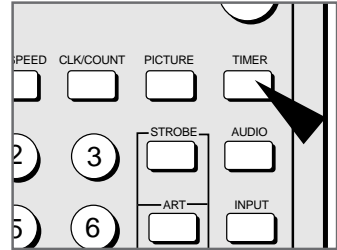

Insert the cassette.  
Press the TIMER button on the remote control.

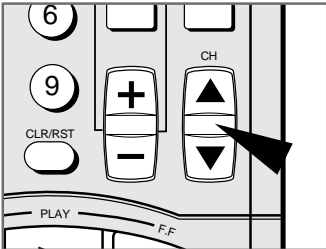

Select the channel by pressing the CH buttons (▲ or ▼) on the remote control.

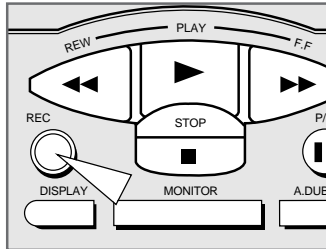

Press REC for at least one second to start recording.

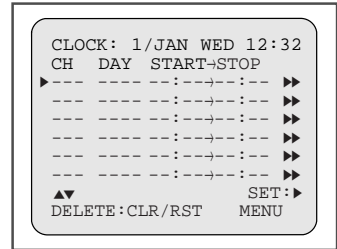

Enter the Timer program data.  
Then press the MENU button.

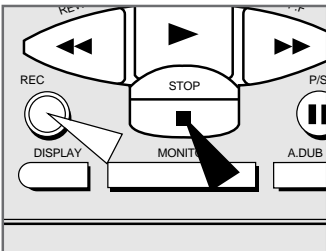

Press REC for at least one second to start recording.  
When you have finished recording, press STOP (■).

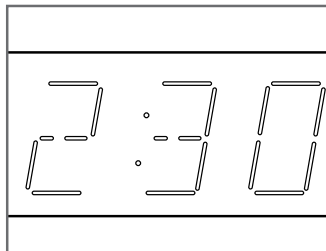

Press REC several times until the required recording time is displayed.

Result: Recording stops automatically at the end of the required time.

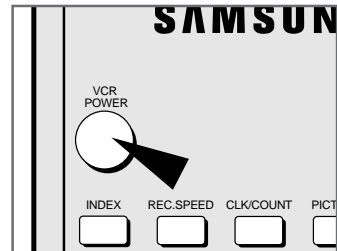

Press VCR POWER to turn off the VCR and to activate the timer.

# Contents

◆ FOREWORD	
■ Safety Instructions .....	4
■ Getting Started .....	5
◆ VCR OVERVIEWS	
■ Front View of the VCR .....	6
■ Rear View of the VCR .....	6
■ Display Indicators .....	7
■ Infrared Remote Control .....	7
◆ CONNECTING YOUR VIDEO CASSETTE RECORDER	
■ Worldwide VCR Background .....	8
■ Worldwide TV Color System .....	8
■ Multi-System VCR vs Worldwide VCR .....	9
■ System Conversion with the Worldwide VCR .....	10
■ Tape Conversion with the Worldwide VCR .....	11
■ Deciding How to Connect Your VCR .....	13
■ Connecting Your VCR to the TV .....	14
◆ SETTING UP YOUR VIDEO CASSETTE RECORDER	
■ Inserting the Batteries in the Remote Control .....	15
■ Initial Setup .....	15
■ User Set1 Setting .....	16
■ User Set2 Setting .....	16
■ Setting the Date and Time .....	17
■ To turn On-Screen Information on/off .....	17
■ Setting the VCR RF out System .....	18
■ Setting the RF OUT CHANNEL .....	19
■ Presetting the Stations Automatically .....	20
■ Presetting the Stations Manually .....	21
◆ RECORDING TELEVISION BROADCASTS	
■ Selecting the Cassette Type .....	22
■ Selecting the Recording Speed .....	22
■ Protecting a Recorded Cassette .....	22
■ Recording a Program .....	23
■ Stopping a Recording Temporarily .....	23
■ Recording a Program with Automatic Stop .....	24
■ Using the Timer Programming Feature .....	25
■ VCR Plus+ Recording (AMERICA only) .....	26
■ VCR Plus+ Set up (AMERICA only) .....	27
■ Checking a Preset Recording .....	28
■ Cancelling a Preset Recording .....	28
◆ PLAYING BACK	
■ Playing a Cassette .....	29
■ Selecting the PLAY SYSTEM Mode .....	29
■ Receiving Stereo Broadcasts .....	30
■ Receiving SAP Broadcasts .....	30
■ SQPB (Super VHS Quasi PlayBack) .....	31
■ Adjusting Picture Alignment Manually .....	31
■ Adjusting Picture Sharpness .....	32
■ Selecting the Audio Output Mode .....	32

- ◆ **REWINDING AND FAST-FORWARDING**
  - Rewinding and Fast-forwarding a Cassette..... 33
  - Playing a Cassette in Slow Motion ..... 33
  - Playing a Sequence Frame by Frame ..... 34
  - Playing a Sequence at Variable Speeds ..... 34
- ◆ **SPECIAL FUNCTION**
  - STROBE..... 35
  - ART ..... 35
  - MONITOR..... 35
- ◆ **SEARCHING FOR A SEQUENCE**
  - Searching for a Specific Sequence ..... 36
  - Using the Tape Counter ..... 37
- ◆ **ADVANCED RECORDING FEATURES**
  - Using the Assemble Edit Function..... 38
  - Connecting Other Equipment to Your VCR ..... 39
  - Recording from Another VCR or Camcorder..... 40
  - TV System Conversion..... 41
  - Playback Conversion..... 41
  - Conversion Recording..... 42
  - Hi-Fi Audio System..... 43
  - Audio Dubbing a Pre-recorded Cassette..... 44
  - Recording an FM Simulcast Program..... 45
- ◆ **OTHER FUNCTIONS AND USEFUL RECOMMENDATIONS**
  - Locking Your VCR ..... 46
  - Resetting Your VCR ..... 46
  - Technical Specifications ..... 47
- ◆ **SOLVING PROBLEMS**
  - Troubleshooting Guide ..... 48
- ◆ **GLOSSARY**
  - Glossary of Terms ..... 49
- ◆ **WORLD BROADCAST SYSTEMS**.....50
- ◆ **INTERNATIONAL SERVICE NETWORK** ..... 51

## Symbols



**Press/push**



**Hold down**



**Important**



**Note**

① = Step number

# Safety Instructions

GB

The following illustrations represent the precautions to be taken when using this video cassette recorder.



The lightning flash with the arrowhead in the triangle is a warning sign alerting you to dangerous voltage inside the product.

DO NOT OPEN THE VCR.

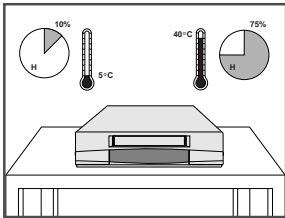

Do NOT expose the VCR to extreme temperature conditions (below 5°C(41°F) and above 40°C(104°F) or to extreme humidity conditions (less than 10% and more than 75%).

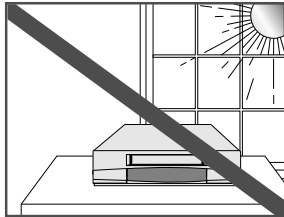

Do NOT expose the VCR to direct sunlight.

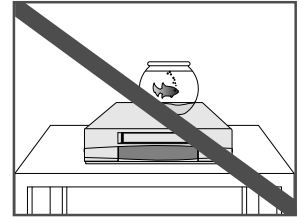

Do NOT expose the VCR to any liquids.

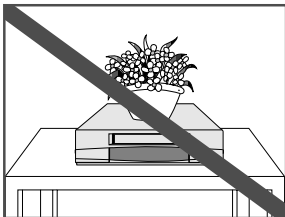

Do NOT place any objects on the VCR or remote control.

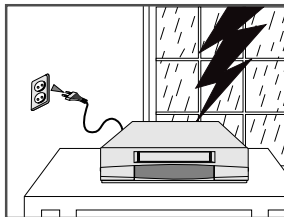

During a storm and/or lightning, unplug the VCR from the AC outlet and antenna.

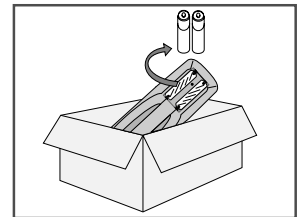





If the remote control is not used for a long period of time, remove the batteries and store it in a cool, dry place.

THIS UNIT IS NOT FOR USE IN INDUSTRIAL ENVIRONMENTS.

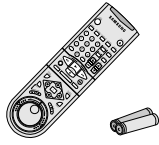

# Getting Started

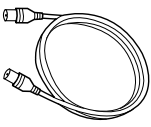
Thank you for purchasing a SAMSUNG Video Cassette Recorder (VCR).  
Together with your VCR, you will find the following accessories in the box.

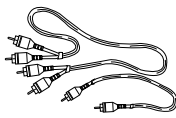
		(EUROPE...)	(AMERICA...)		
<b>REMOTE CONTROL</b> (AC59-00010D) <b>BATTERIES "AAA"</b> (AC43-12002H)	<b>OWNER'S INSTRUCTIONS</b> (AC68-00575A)	<b>COAXIAL CABLE</b> (AC39-42001L)	<b>COAXIAL CABLE</b> (AC39-42001J) <b>RF ADAPTORS</b> (M:3705-001095 F:3705-001096)	<b>RCA CABLE(AUDIO)</b> (AC39-42001U) <b>RCA CABLE (VIDEO)</b> (AC39-22017Z)	
					

Your Owner's Instructions contain much valuable information on setting up and using your VCR. Please take the time to read them as they will help you take full advantage of the VCR's features.

The manual is organized as follows:

- ◆ A series of step-by-step procedures for each function available forms the main body of the manual.
- ◆ You can consult the glossary on page 49, to obtain an explanation of the main technical terms used throughout this manual.
- ◆ On pages 6 and 7, you will find illustrations of the VCR (front and rear), the display and the remote control unit to help you find the buttons and understand the symbols displayed.

## Preparing Your Video Cassette Recorder

Before being able to play and record video cassettes, you must prepare and connect your VCR.

- ◆ Insert batteries in the remote control.
- ◆ Connect your VCR to the television.
- ◆ Set the date and time used to display information on the television screen.
- ◆ Preset the stations.

All these operations are essential, so you must follow the step-by-step instructions carefully.

## Front View of the VCR

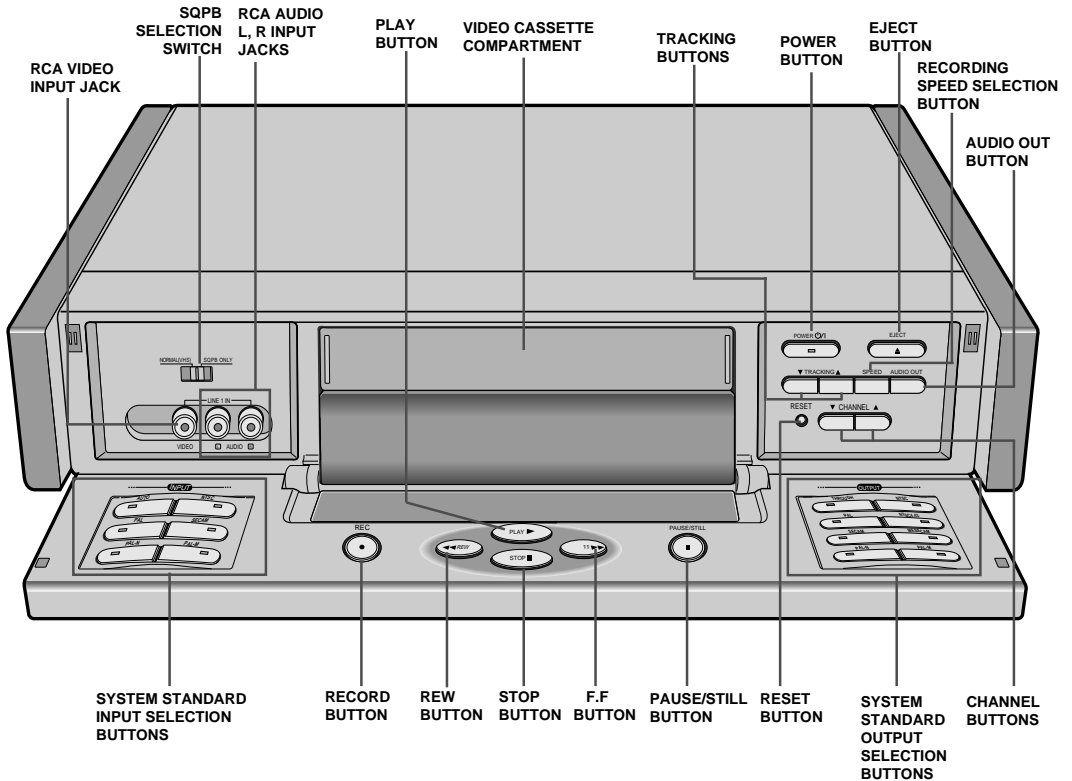

## Rear View of the VCR

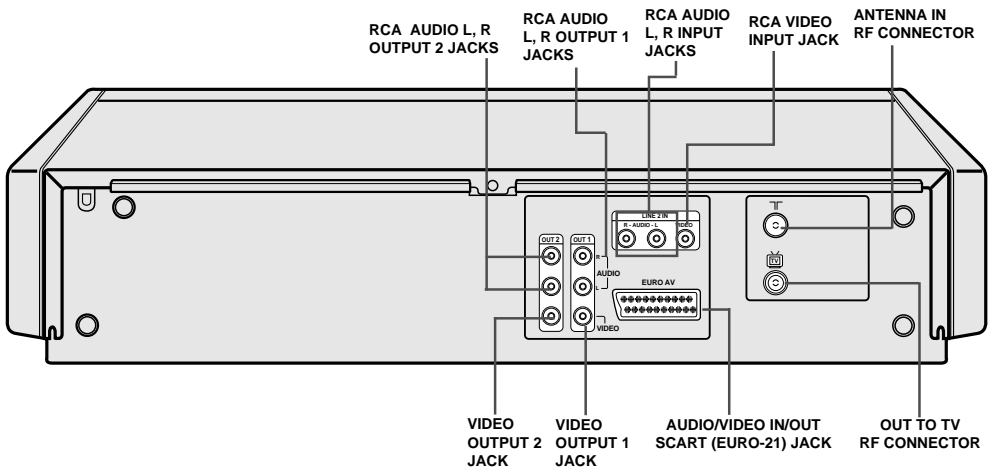

# Display Indicators

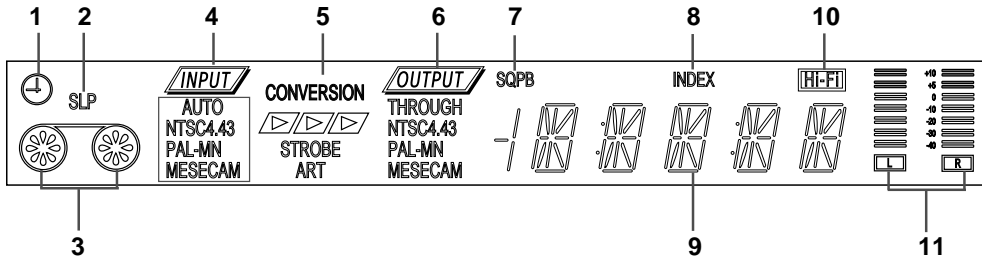

- |   |                           |   |                         |    |                        |
|---|---------------------------|---|-------------------------|----|------------------------|
| 1 | Timer indicator           | 5 | Conversion indicator    | 9  | Multi-function display |
| 2 | Recording speed indicator | 6 | Output select indicator | 10 | Hi-Fi indicator        |
| 3 | Cassette in/out indicator | 7 | SQPB Indicator          | 11 | Audio Level meter      |
| 4 | Input select indicator    | 8 | INDEX Indicator         |    |                        |

# Infrared Remote Control

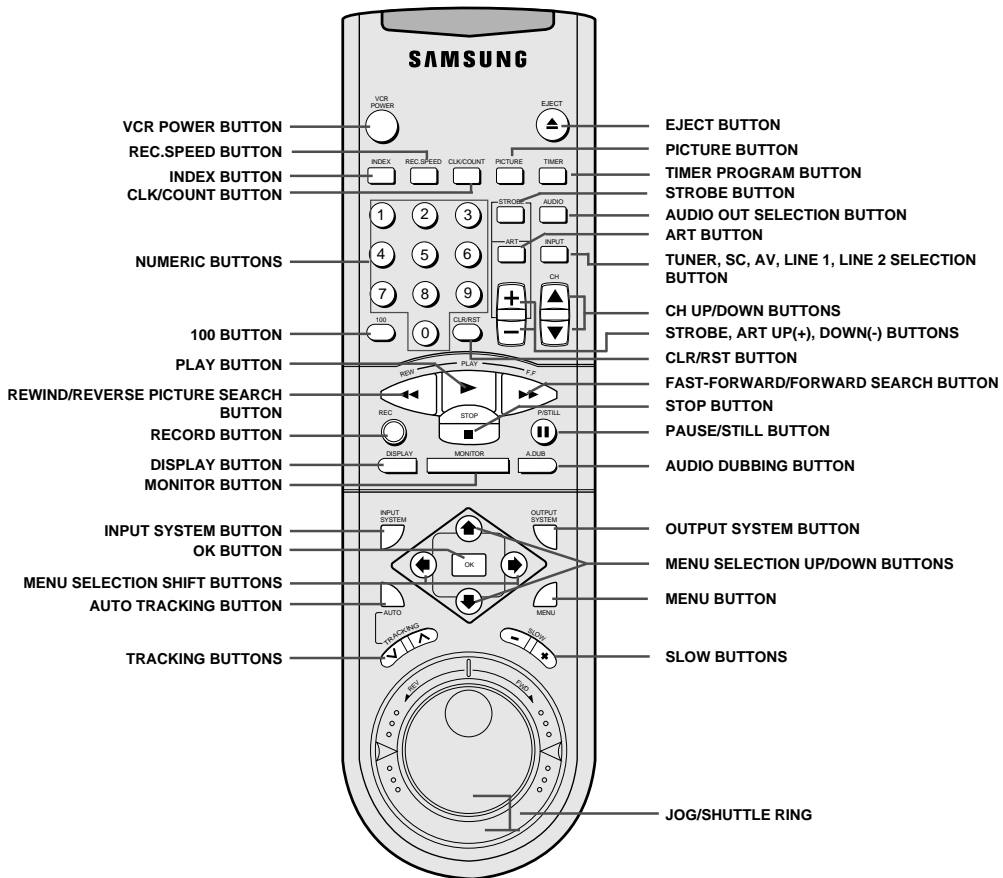

# Worldwide VCR Background

## “Worldwide Communication through VCR”

Today, the Video Recorder is a major media and communication tool, used for both business and home entertainment. Furthermore, the emergence of the camcorder has extended the versatility of video, enabling home video making.

Video communication is increasingly becoming a global medium, but different TV broadcasting systems around the world hinder the worldwide exchange of video tapes.

The Samsung SV-7000W overcomes the incompatibility of different TV broadcasting systems through sophisticated digital technology, allowing any standard VHS tape to be played on any TV, anywhere in the world (with free voltage).

# Worldwide TV Color System

Many countries have different TV signal formats, with no exchangeability between them. This makes it impossible to play back or record tapes with different signal formats. This worldwide common VCR overcomes this problem by converting the signal format of any tape into the format you desire.

## Comparison of TV color systems

	NTSC	NTSC4.43	PAL-M	PAL	PAL-N	SECAM	MESECAM
Number of scanning lines	525			625			
Field frequency	60Hz			50Hz			
Line frequency	15.734kHz			15.625kHz			
Color signal modulation system	Sub carrier suppression quadrature modulation					FM modulation	
Color signal frequency	3.579545 MHz	4.433619 MHz	3.575611 MHz	4.433619 MHz	3.582056 MHz	DB 4.25MHz DR 4.40625MHz	
Burst signal	Fixed phase		Inverted by 1 H			DR.DB alternation	



### Classification of TV color systems by country

- ◆ NTSC : Korea, U.S., Canada, Japan, Taiwan, and Philippines
- ◆ PAL : United Kingdom, Germany, Western Europe, China, and Singapore
- ◆ SECAM : France, Eastern Europe, and CIS
- ◆ PAL-M : Brazil
- ◆ PAL-N : Argentina (The tape is the same as that of PAL)
- ◆ NTSC4.43 : Pseudo NTSC signal which is made to use NTSC tape in the Middle East (The tape is the same as that of NTSC3.58)
- ◆ MESECAM : The name of a tape which uses the SECAM signal recording method. The output signal during playback is SECAM signal.



Worldwide Broadcasting system is B/G, I, D/K, M, N, L.

## Multi-System VCR vs Worldwide VCR

The Worldwide VCR is similar to the Multi-System VCR in that it will play back tapes recorded in any TV Broadcasting System. However, there are a few key differences:

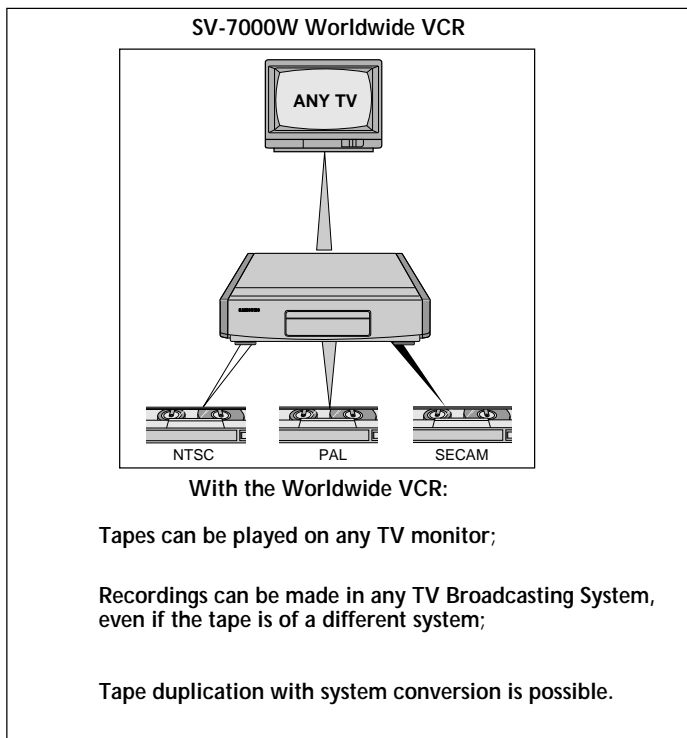
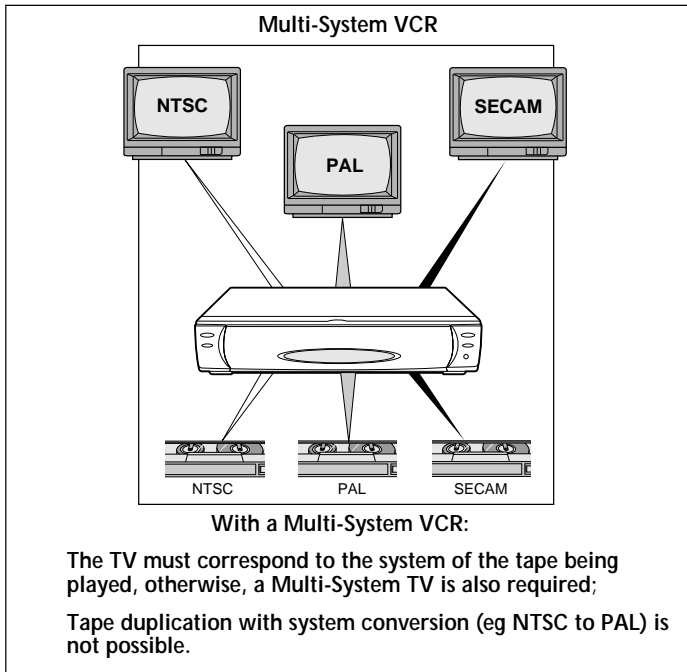

# System Conversion with the Worldwide VCR

GB

System conversion is the most complex digital process undertaken by the Worldwide VCR, converting the "input" into a different "output", eg from NTSC to PAL, or from PAL to SECAM.

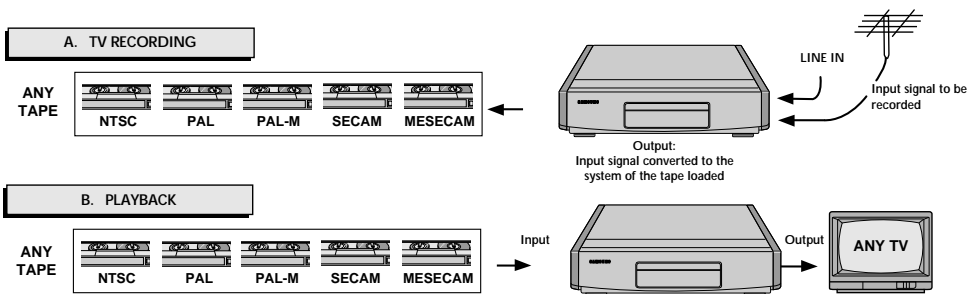
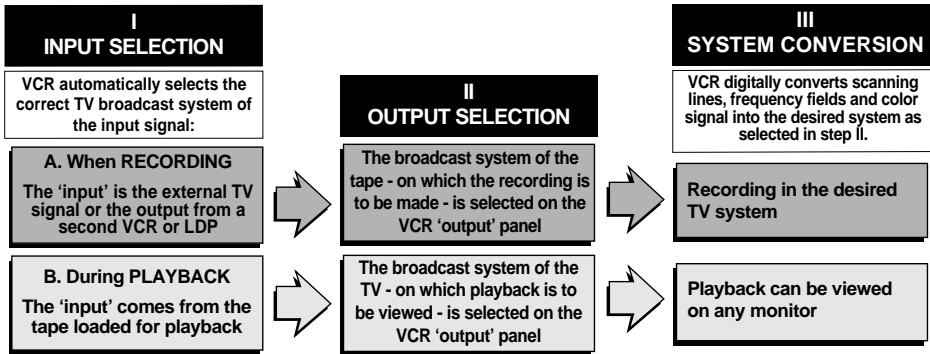
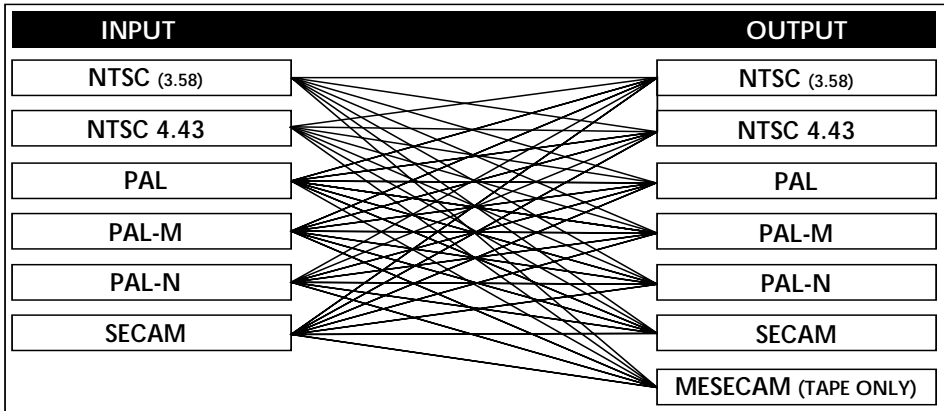
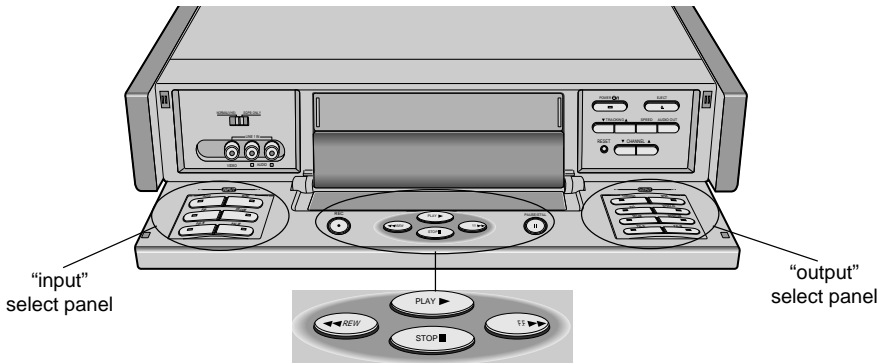

# Tape Conversion with the Worldwide VCR

One of the most useful functions of the Worldwide VCR is the combination of tape duplication and system conversion, more simply known as "Tape Conversion". This allows the user to copy, for example, a SECAM tape and simultaneously convert it to PAL or NTSC. This is particularly useful for duplicating home video camcorder recordings and sending them to friends or relatives abroad.

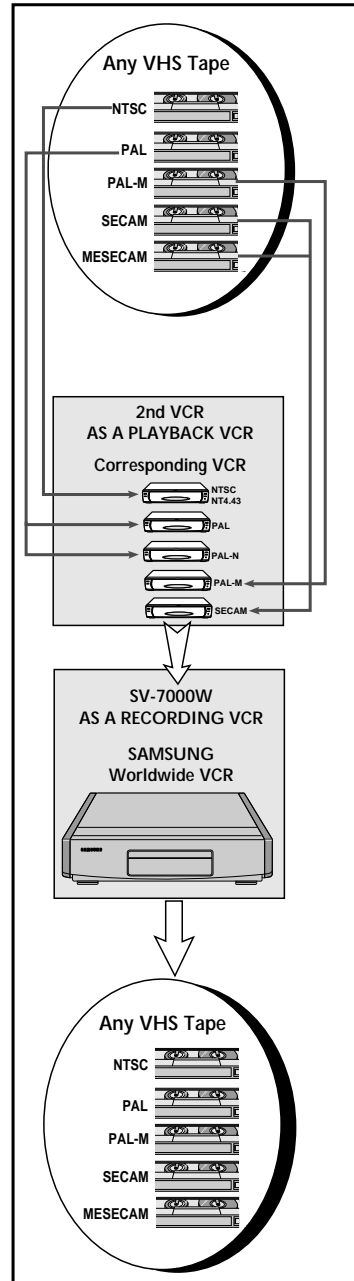
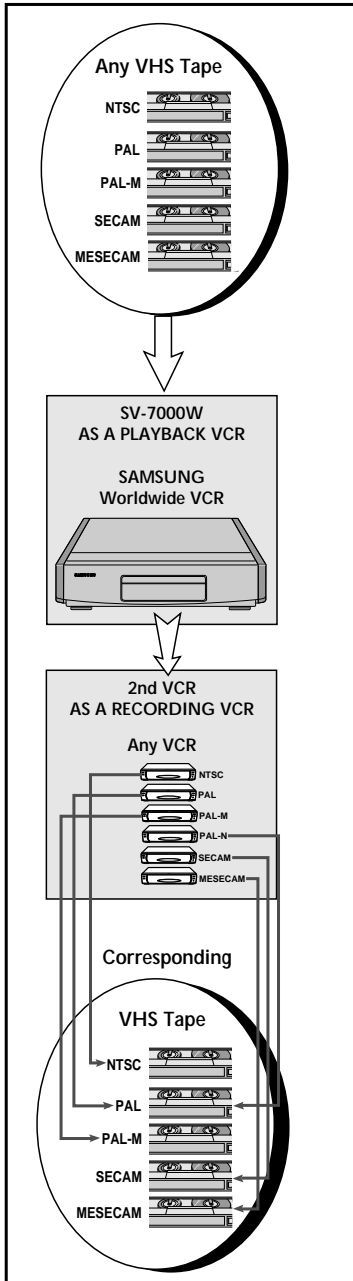

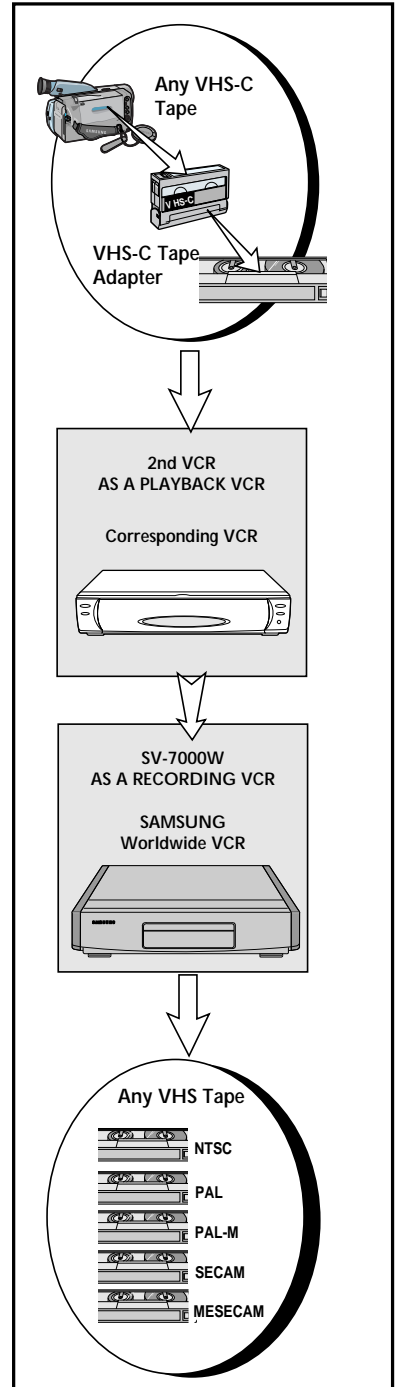
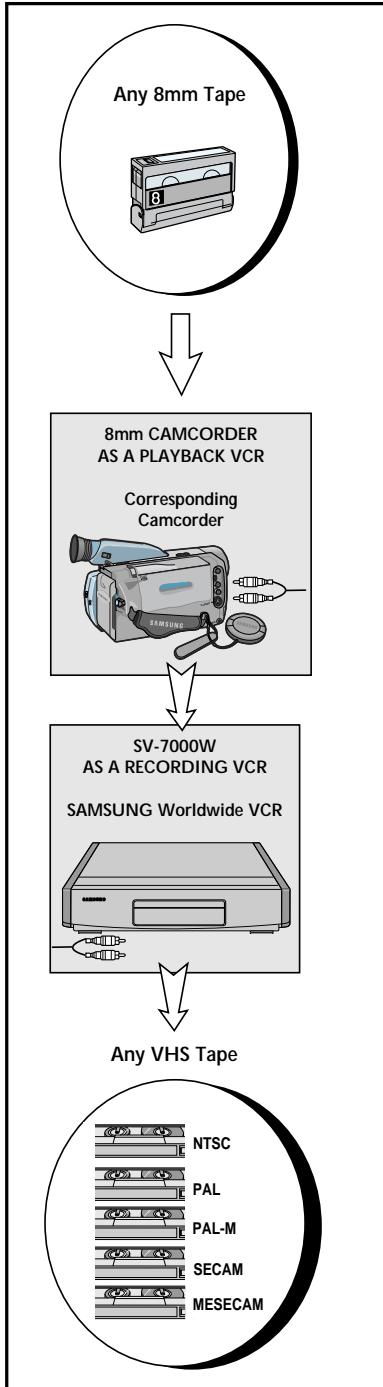









# Deciding How to Connect Your VCR

You must take into account various factors when deciding how to connect your various audio and/or video systems.

- ◆ Types of connectors available on your systems.
- ◆ Systems connected permanently to the VCR (satellite receiver for example) or from time to time (camcorder for example).

Your VCR is equipped with the following connectors.

Connector	Location	Type	Direction	Recommended Use
AV	Rear 	SCART	In/Out ↔	◆ Television
LINE	Rear 	Audio/Video RCA	Out →	◆ Television ◆ Other VCR
LINE 1	Front 	Audio/Video RCA	In ←	◆ Audio system ◆ Camcorder ◆ Other VCR
LINE 2	Rear 	Audio/Video RCA	In ←	◆ Audio system ◆ Camcorder ◆ Satellite receiver ◆ Other VCR
OUT TO TV	Rear 	75 Ω coaxial	Out →	◆ Television
IN FROM ANT.	Rear 	75 Ω coaxial	In ←	◆ Antenna ◆ Cable television network



Whenever you connect an audio or video system to your VCR, ensure that all units are switched off.

Refer to the documentation supplied with your equipment for detailed connection instructions and associated safety precautions.

## Connecting Your VCR to the TV

GB

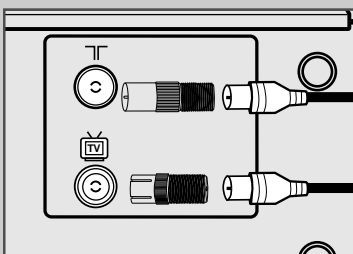
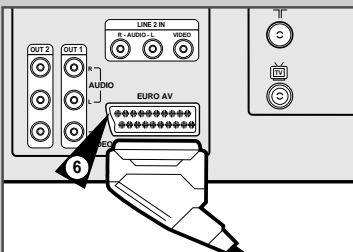
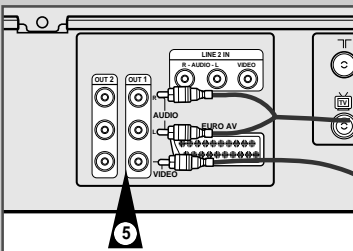
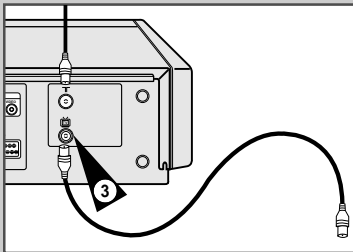
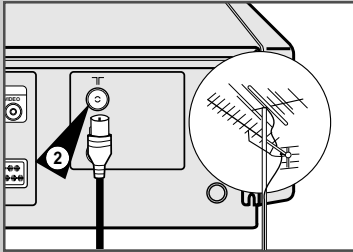

To receive television programs from an over-the-air or cable television network, a signal must be received from one of the following sources.

- ◆ An outdoor antenna.
- ◆ An indoor antenna.
- ◆ A cable television system.



Make sure that both the television and the VCR are switched off before connecting the cables.

- 1 Remove the 75Ω coaxial cable from the television.
- 2 Connect this cable to the 75Ω coaxial socket marked  $\square$  on the rear of your VCR.
- 3 Plug the coaxial cable supplied into the  socket on your VCR.
- 4 Plug the other end of the coaxial cable into the connector previously used for the antenna on the television.
- 5 Connect one end of the RCA cable supplied to the output jacks (OUT1 or OUT2) on the rear of the VCR.
  - Respect the color coding of the Audio and Video In/Out cable.
- 6 Connect one end of the SCART cable to the EURO AV socket on the rear of the VCR.
- 7 Plug the other end (of the RCA cable or SCART cable) into the appropriate connector on the television.

- ◆ Regardless of the type of connection chosen, you must always connect the coaxial cable supplied. Otherwise, no picture will be visible on the screen when the VCR is switched off.

### \* NOTICE:

Use the supplied RF adaptors as needed when making RF connections.  
[NTSC/PAL-M Region]

## Inserting the Batteries in the Remote Control

You must insert or replace the batteries in the remote control when you:

- ◆ purchase the video cassette recorder ; or
- ◆ find that the remote control is no longer working correctly.

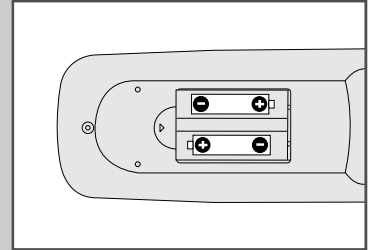
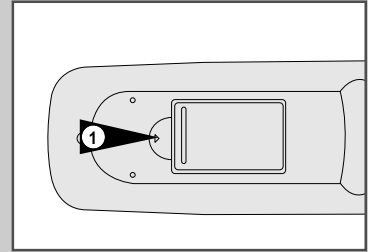

- 1 Push the tab in the direction of the arrow to release the battery compartment cover on the rear of the remote control.
- 2 Insert two AAA or equivalent batteries (supplied), taking care to respect the polarities.
  - ◆ + on the battery with + on the remote control.
  - ◆ - on the battery with - on the remote control.
- 3 Replace the cover by aligning it with the base of the remote control and pushing it back into place.

## Initial Setup

The VCR automatically displays the initial setup MENU when the VCR is plugged into the AC outlet for first time.

- 1 Plug the VCR into the AC outlet.  
Result: The LANGUAGE SET is displayed.
- 2 Press the  $\blacktriangle$ ,  $\blacktriangledown$  and OK button to select your favorite language.  
Result: The COUNTRY SET is displayed.
- 3 Press the  $\blacktriangle$ ,  $\blacktriangledown$ ,  $\blacktriangleright$  button to select your country region.  
Result: The country list is displayed.
- 4 Press the  $\blacktriangle$ ,  $\blacktriangledown$ ,  $\blacktriangleright$  and OK button to select your country.
  - If your country does not appear in the country list, then select OTHERS.

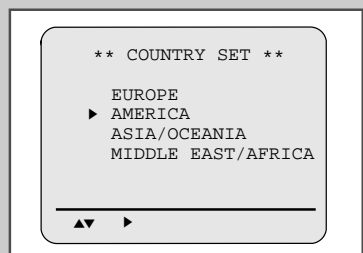
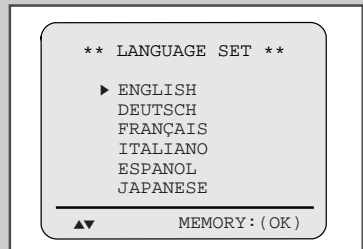

## USER SET1 Setting

GB

```

** M E N U **

TIMER PROGRAMMING
▶ USER SET
  INSTALLATION
  LANGUAGE SET
  CLOCK SET
-----
▲▼ ▶ END: (MENU)
    
```

```

** USER SET1 **

▶ TAPE SELECT :E180/
               T120
  CLOCK TYPE  :12H
  PLAY SYSTEM :AUTO
  OSD         :ON
  USER SET2
-----
▲▼ ▶ END: (MENU)
    
```

The user set is initially set at the factory. If you want to make any changes to the USER SET, please follow the instructions below.

- 1 Press MENU on the remote control.  
Result: The programming menu is displayed.
- 2 Press the **▲**, **▼**, **▶** button to select user set.  
Result: The **USER SET1** is displayed.
- 3 Press **▲**, **▼**, **▶** to select the USER SET1 item.
- 4 Check below to change the item.

### \* USER SET1

ITEM	USAGE	COMMENT
TAPE SELECT	tape length select	Select the recording tape type for remaining time.
CLOCK TYPE	12H/24H mode	Select your favorite clock type.
PLAY SYSTEM	play tape system selection	The VCR automatically selects the play system. If an auto detection error occurs, then select the play system manually.
OSD	OSD display on/off	Initial setting is on.
USER SET2	USER SET2 select	Select to go to USER SET2 page.

## USER SET2 Setting

```

** M E N U **

TIMER PROGRAMMING
▶ USER SET
  INSTALLATION
  LANGUAGE SET
  CLOCK SET
-----
▲▼ ▶ END: (MENU)
    
```

```

** USER SET1 **

TAPE SELECT :E180/
             T120
  CLOCK TYPE :12H
  PLAY SYSTEM :AUTO
  OSD       :ON
  ▶ USER SET2
-----
▲▼ ▶ END: (MENU)
    
```

```

** USER SET2 **

▶ SAP           :OFF
  COLOR        :ON
  BLUE SCREEN  :ON
  USER SET1
-----
▲▼ ▶ END: (MENU)
    
```

- 1 Press MENU on the remote control.  
Result: The programming menu is displayed.
- 2 Press the **▲**, **▼**, **▶** button to select user set.  
Result: The **USER SET1** is displayed.
- 3 Press **▲**, **▼**, **▶** to select the **USER SET2**.
- 4 Press **▲**, **▼**, **▶** to select the **USER SET2** menu item.
- 5 Check below to change the item.

### \* USER SET2

ITEM	USAGE	COMMENT
SAP	SAP on/off	Initial mode is SAP OFF.
COLOR	COLOR or B/W select	Initial mode is on. Color off mode is B/W. If color distortion occurs in the play or conversion mode, then select color off mode.
BLUE SCREEN	BLUE SCREEN on/off	Initial is blue screen on. If any problem occurs with the blue screen, then select blue screen off.
USER SET1	USER SET1 select	Select to go to USER SET1 page.

# Setting the Date and Time

Your VCR contains a 12H/24H clock and calendar used to:

- ◆ preset your VCR to record a program automatically.

You must set the date and time when:

- ◆ you purchase the video cassette recorder; or
- ◆ the power supply remains off for more than 6 hours.



- ◆ Do not forget to reset the time when you change clocks from standard to daylight savings time and vice versa.

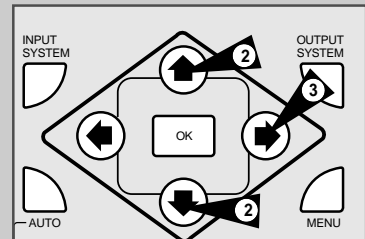
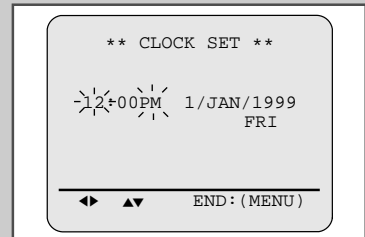
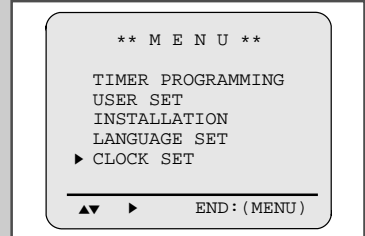
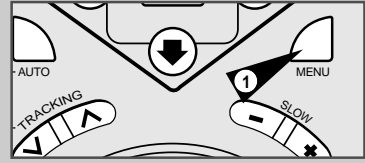

- 1 Press MENU on the remote control.  
Result: The programming menu is displayed.
- 2 Press the or button, until the cursor is placed in front of the **CLOCK SET** option.
- 3 Press the button to select this option.  
Result: The **CLOCK SET** menu is displayed.
- 4 Press or to select the hour, minutes, day, month and year.  
Result: The option selected flashes.
- 5 Press the or button to increase or decrease the value.  
Result: The day of the week is displayed automatically.  
➤ You can hold the or button down to scroll more quickly through the values.
- 6 On completion, press MENU twice to exit the menu.

# To turn On-Screen Information on/off

Your VCR displays most information both on the VCR and television.

You can choose to display or not to display this information on the television screen (except for the Index, Timer Programming function, Picture, which cannot be turned off).

- 1 Press MENU on the remote control.  
Result: The programming menu is displayed.
- 2 Press the corresponding or button, until the cursor is placed in front of the **USER SET** option.
- 3 Press the button to select this option.  
Result: The **USER SET1** menu is displayed.
- 4 Press the corresponding or button, until the cursor is placed in front of the **OSD** option.
- 5 **To:** **Press or , until:**  
display on-screen information **ON** is displayed.  
turn on-screen information off **OFF** is displayed.
- 6 After completion, press MENU twice to exit the menu.

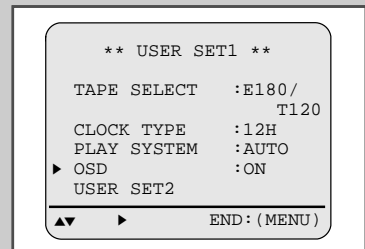
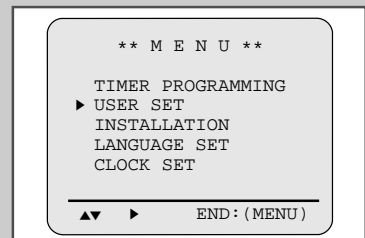

## Setting the VCR RF out System

GB

The VCR RF out system and channel is used to connect the SV-7000W to a TV with RF coaxial jacks.

The RF out system is automatically set by country selection (See page 15).

➤ If your selection of the country set is U.S.A., the RF out system is automatically set to U.S.A-M system.

If after making your country selection, you have picture distortion or no sound, you must set the RF out system and channel manually. Change the RF out system according to the table below.

TV Broadcast system	RF out system	NATION
M	M	U.S.A, CANADA, KOREA, JAPAN, BRAZIL,--
N	M	URUGUAY, ARGENTINA,--
L	L	FRANCE,--
B/G	G	GERMAN, ITALY, SPAIN,--
I	I	U.K, HONGKONG,--
D/K	K	CHINA, CIS, --

➤ If you want to know the broadcast system of your specific country, see the World Broadcast Systems (page 50).

\*\* INSTALLATION \*\*

COUNTRY  
ANT. /CATV:ANTENNA  
AUTO SET UP  
▶ MANUAL SET UP

▲▼ ▶ END : (MENU)

\*\* MANUAL SET UP \*\*

GUIDE CH SET UP  
CH ADD/DELETE  
▶ RF OUT M/G/I/K :M  
RF OUT CH 14-69:OFF  
116-125

▲▼ ▶ (END:MENU)

- Press the MENU button on the remote control.  
Result: The programming menu is displayed.
- Press the ◀ or ▶ buttons to select installation.  
Result: The INSTALLATION menu is displayed.
- Press the ◀ or ▶ buttons to select MANUAL SET UP.  
Result: The MANUAL SET UP menu is displayed.
- Press the ◀ button until the cursor is placed in front of RF OUT system.
- Press the ▶ or ◀ buttons to change the RF OUT system.  
Result: The RF OUT system is changed.

## Setting the RF OUT CHANNEL

*The initial setting of the RF OUT channel is off.  
In order to view signals from the RF out connector on your TV, you must set the RF OUT channel on the VCR to match the TV channel.*

- 1 Press MENU on the remote control.  
Result: The programming menu is displayed.
- 2 Press the  $\blacktriangleleft$  or  $\blacktriangleright$  buttons to select installation.  
Result: The installation **MENU** is displayed.
- 3 Press the  $\blacktriangleleft$  or  $\blacktriangleright$  buttons to select **MANUAL SET UP**.  
Result: The **MANUAL SET UP** menu is displayed.
- 4 Press the  $\blacktriangledown$  button until the cursor is placed in front of **RF OUT CHANNEL**.
- 5 Press the  $\blacktriangleright$  or  $\blacktriangleleft$  buttons to change the RF OUT CHANNEL.  
Result: The **RF OUT CH** is changed.

$\blacktriangleright$  Your VCR RF out channel may need to be changed if there is no picture or the picture suffers from interference.

For better picture and sound quality, connect your VCR to the TV using the RCA cable (if the appropriate RCA input is available on your TV).

\*\* INSTALLATION \*\*

COUNTRY  
ANT./CATV:ANTENNA  
AUTO SET UP  
 $\blacktriangleright$  MANUAL SET UP

$\blacktriangleleft$   $\blacktriangleright$  END:(MENU)

\*\* MANUAL SET UP \*\*

GUIDE CH SET UP  
CH ADD/DELETE  
RF OUT M/G/I/K :M  
 $\blacktriangleright$  RF OUT CH 14-69:OFF  
116-125

$\blacktriangleleft$   $\blacktriangleright$  END:(MENU)

## Presetting the Stations Automatically

GB

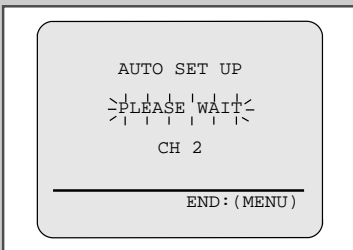
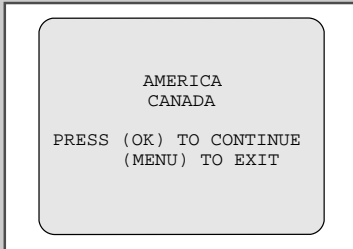
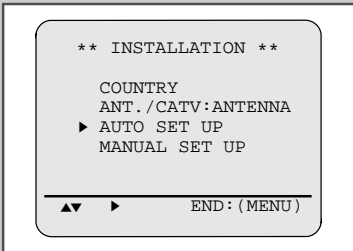
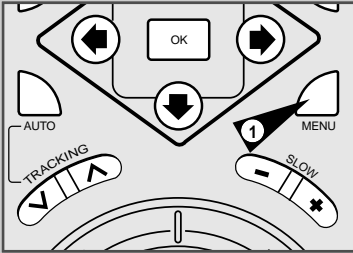

Your VCR contains a built-in tuner used to receive television broadcasts. It can also receive cable television broadcasts.

You must preset the stations received through the tuner. This can be done:

- ◆ automatically ; or
- ◆ manually (see page 21).

- 1 Press the MENU button on the remote control.  
Result: The programming menu is displayed and the cursor is automatically placed in front of the **AUTO SET UP** option.
- 2 Press the ★ button to select **AUTO SET UP**.
- 3 Press OK to start the Auto scanning.  
Result: The **AUTO** indication flashes on the VCR display.  
➤ The number of channels automatically stored by the VCR depends on the number of channels that have been found (reception conditions, etc).
- 4 To exit **AUTO TUNING**, press the MENU button.

➤ Once the Auto scanning procedure has finished, some channels may have been stored more than once. Select the channels with the best reception and delete the ones no longer required. (see page 21.)



# Presetting the Stations Manually

Your VCR contains a built-in tuner used to receive television broadcasts. It can also receive cable television broadcasts.

You must preset the stations received through the tuner. This can be done:

- ◆ automatically (see page 20) ; or
- ◆ manually.

- 1 Press the MENU button on the remote control.  
Result: The programming menu is displayed.
- 2 Press the corresponding ▲ or ▼ buttons, until the cursor is placed in front of the **INSTALLATION** option.
- 3 Press the ► button to select this option.  
Result: The **INSTALLATION** menu is displayed.
- 4 Press the corresponding ▲ or ▼ buttons, until the cursor is placed in front of the **MANUAL SET UP** option.
- 5 Press the corresponding ▲ or ▼ buttons, until the cursor is placed in front of the **CH ADD/DELETE** option.
- 6 Press the ◀ or ▶ button to select channel that you want to memorize or delete.

**If you:**

wish to store the displayed channel ◆ press OK buttons to memorize current channel.

wish to delete the channel displayed ◆ press CLR/RST button to delete current channel.

- 7 Press OK button to memorize.  
Result: The selected channel is memorized.
- 8 Press CLR/RST button to delete.  
Result: The selected channel is deleted.

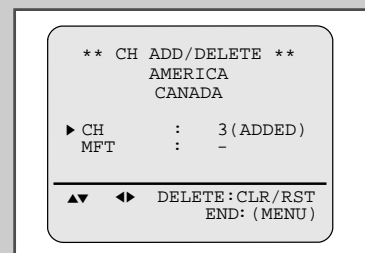
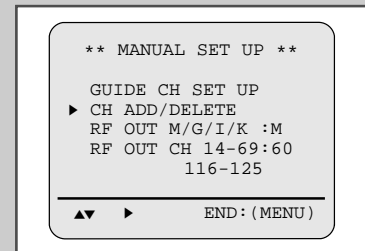
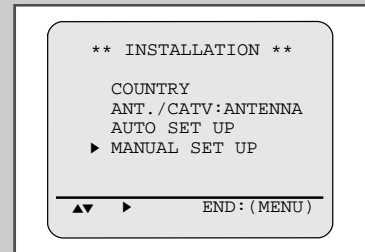
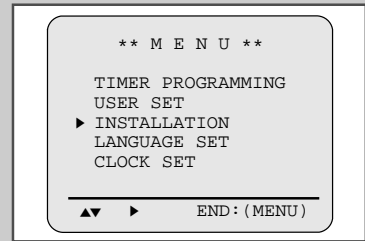

## Selecting the Cassette Type

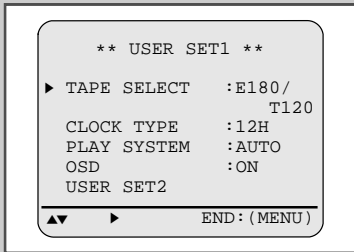

If you wish to use the tape counter to display the time remaining on a cassette, you must indicate the type of cassette inserted.

- 1 Press MENU on the remote control.  
**Result:** The programming menu is displayed.
- 2 Press the  $\blacktriangle$  or  $\blacktriangledown$  button, until the cursor is placed in front of the **USER SET** option.
- 3 Press the  $\blacktriangleright$  button to select this option.  
**Result:** The cursor is set to the **TAPE SELECT** option.
- 4 Press the  $\blacktriangleleft$  or  $\blacktriangleright$  button as many times as required, until the correct cassette length is displayed.

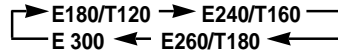

- 5 Press MENU twice to exit the menu.

## Selecting the Recording Speed

Type	Recording Time	
	PAL/SECAM	NTSC
E-180/T120	180 mins	120 mins
E-240/T160	240 mins	160 mins
E-260/T180	260 mins	180 mins
E-300	300 mins	

You can record a cassette at two different speeds:

PAL/SECAM/MESECAM	NTSC/PAL-M
◆ SP (Standard Play)	◆ SP (Standard Play)
◆ LP (Long Play)	◆ SLP (Super Long Play)

In Long Play or Super Long Play modes:

- ◆ the recording is of a slightly lower quality.

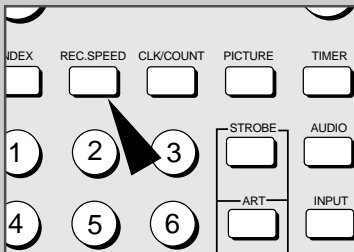

To record a cassette: Press the REC.SPEED button on the remote control, until:

- |                         |                                      |
|-------------------------|--------------------------------------|
| in standard play mode   | SP is displayed.                     |
| in long play mode       | LP is displayed (PAL/SECAM/MESECAM). |
| in super long play mode | SLP is displayed (NTSC/PAL-M).       |

## Protecting a Recorded Cassette

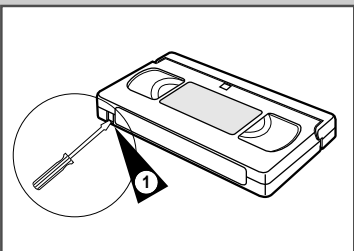

Video cassettes have a safety tab to prevent accidental erasure. When this tab has been removed, you cannot record on the tape.

- 1 If you wish to protect a cassette, break off the tab using a small screwdriver.
- 2 To re-record over a protected cassette (safety tab broken), cover the hole with adhesive tape.

## Recording a Program

Before recording a program, you must have preset the corresponding channel (unless you are recording via an external video source). If you have not done so, refer to pages 20 and 21.

- 1 Switch on the television.
- 2 To monitor the program being recorded, select the television AV input.
- 3 Insert the cassette on which the program is to be recorded.  
**Result:** The VCR is switched on automatically.
- 4 Select:
  - ◆ the selected channel to be recorded using the CH (▲ or ▼) buttons;
  - or
  - ◆ the AV source using the INPUT button for a satellite tuner or external video source.**Result:** The channel number is displayed and the program can be seen on the television.
- 5 Select the recording speed by pressing the REC.SPEED button as many times as required (see page 22).
- 6 Press the REC button for at least one second to start recording.  
**Result:** The record indicator appears on the television and VCR display. An index is recorded on the tape (see page 36).
- 7 To stop recording, press STOP (■) once.

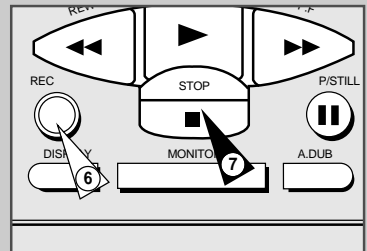
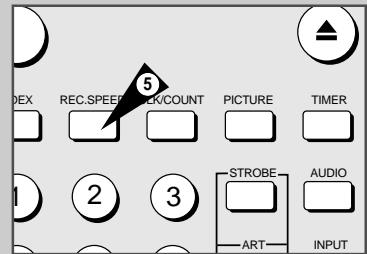
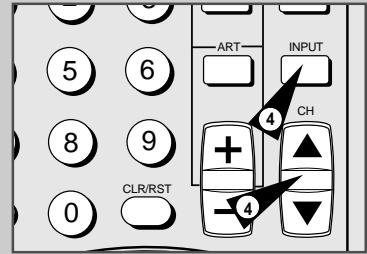

- ◆ If the cassette is ejected when you start recording, check that the safety tab is intact or the opening is covered with adhesive tape.
- ◆ If you reach the end of the tape while recording, the cassette rewinds automatically.

## Stopping a Recording Temporarily

You can stop recording temporarily (pause mode), to avoid recording commercials or to change channels for example.

To:	press:
stop recording temporarily	P/STILL (  ).
start recording again	P/STILL (  ) or REC.

- ☞ If the VCR is left in pause mode for more than ten minutes, recording will be stopped automatically to protect the heads and the cassette.

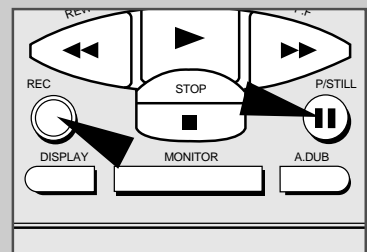

## Recording a Program with Automatic Stop

GB

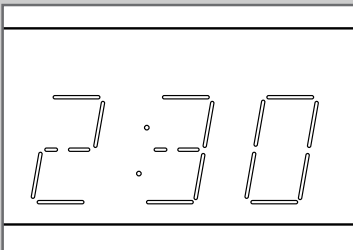
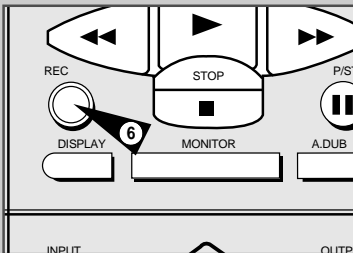
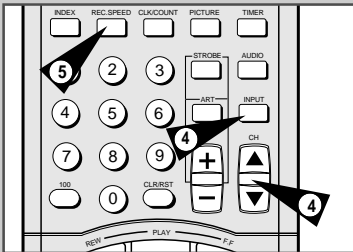
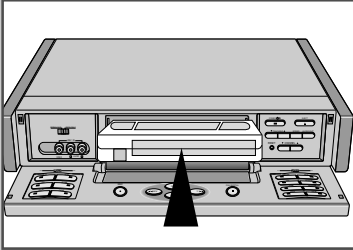

*This function enables you to record up to nine hours of programs. Your VCR stops automatically after the preset length of time.*

- 1 Switch on the television.
- 2 Select the AV input on the television for use with your VCR.
- 3 Insert the cassette on which the program is to be recorded.  
Result: The VCR is switched on automatically.
- 4 Select:
  - ◆ the station to be recorded using the CH (▲ or ▼) buttons ;  
or
  - ◆ the AV source using the INPUT button for a satellite tuner or external video sourceResult: The channel number is displayed and the program can be seen on the television.
- 5 Select the recording speed by pressing the REC.SPEED button as many times as required (see page 22).
- 6 Press the REC button for at least one second to start recording.  
Result: The record indicator appears on the television screen and VCR display. An index is recorded on the tape (see page 36).
- 7 Press the REC button several times to increase the recording time in:
  - ◆ 30-minute intervals up to four hours ; or
  - ◆ 1-hour intervals up to nine hours.Result: The length is displayed on the VCR and television displays. The selected program is recorded for the length of time requested. At the end of that time, the VCR stops recording automatically.
- 8 If you wish to cancel the recording before the end, press POWER.



- If the end of the tape is reached while recording:
- ◆ the recording stops ; and
  - ◆ the VCR automatically turns off.

# Using the Timer Programming Feature

The Timer Programming feature enables you to preset the VCR to record a program up to one month before it is to be broadcast. Up to six programs can be preset.

 Before presetting a recording, check that the date and time are correct. If not, refer to page 17. If the clock has not been set, the Date/Time Setting function is activated automatically.

- 1 Insert the cassette and press the TIMER button.  
Result: The Timer selection is displayed.

---

- 2 Press  $\blacktriangleright$  to select the standard timer.

---

- 3 Select the required channel by pressing the  $\blacktriangleleft$  or  $\blacktriangleright$  buttons or INPUT to select the SC, AV, L1 or L2 input sources.

---

- 4 Press  $\blacktriangleright$  to select the recording day.

---

- 5 Select the required day by pressing the  $\blacktriangleleft$  or  $\blacktriangleright$  buttons.
  - $\blacktriangleright$  DLY (daily program).
  - W-SU, W-MO, ..., W-SA (weekly program).

---

- 6 Press  $\blacktriangleright$  to select the recording start time.

---

- 7 Select the required hour value by pressing the  $\blacktriangleleft$  or  $\blacktriangleright$  buttons.

---

- 8 Press  $\blacktriangleright$  to select the minutes.

---

- 9 Select the required minute value by pressing the  $\blacktriangleleft$  or  $\blacktriangleright$  buttons.

---

- 10 Press  $\blacktriangleright$  to select the recording stop time.

---

- 11 Select the required recording stop time by pressing the  $\blacktriangleleft$  or  $\blacktriangleright$  buttons, following the same procedure as when selecting the recording start time.

---

- 12 Press  $\blacktriangleright$  to select the REC SYSTEM.

---

- 13 Select the required recording system value by pressing the  $\blacktriangleleft$  or  $\blacktriangleright$  buttons. Offset value is THROUGH.

---

- 14 Press  $\blacktriangleright$  to select the recording speed.

---

- 15 Select the required recording speed value by pressing the  $\blacktriangleleft$  or  $\blacktriangleright$  buttons. Offset value is SP.
 

Result: If you select AUTO mode, the VCR compares the timer duration with the remaining time on the cassette. If the tape is not long enough, the speed automatically changes from SP to LP/SLP.

---

- 16 When you have finished, press the MENU button.  
Result: **SET** is displayed, indicating that the VCR has been programmed.

---

- 17 Press the VCR POWER button to activate the timer.

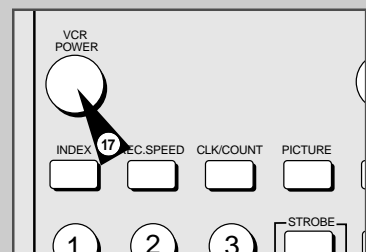
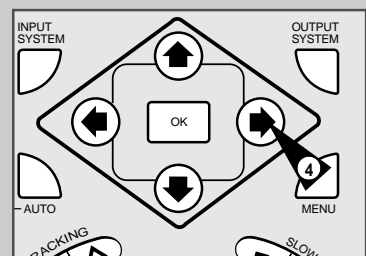
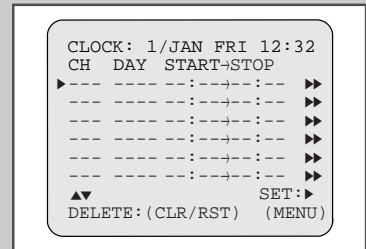
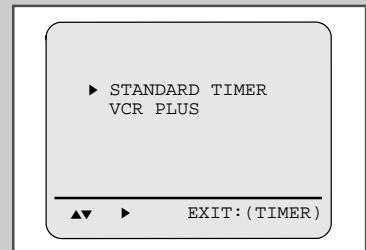
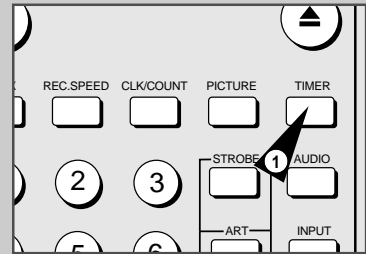

## VCR Plus+ Recording (AMERICA Only)

GB

```
STANDARD TIMER
▶ VCR PLUS

-----
▲▼ ▶ EXIT: (TIMER)
```

```
VCR PLUS

CODE -----

-----
CODE: 0-9   CORRECT: ◀
            END: (MENU)
```

```
VCR PLUS

CODE 12345---

-----
CODE: 0-9   CORRECT: ◀
COMPLETE: OK END: (MENU)
```

```
CLOCK: 10/JUL SAT 4:21P
CH DAY START → STOP
▶ 16 FR16 7:30P→ 8:00P ▶▶
-----:-- →:-- ▶▶
-----:-- →:-- ▶▶
-----:-- →:-- ▶▶
-----:-- →:-- ▶▶
-----:-- →:-- ▶▶
-----:-- →:-- ▶▶
▲▼ SET: ▶
DELETE: (CLR/RST) (MENU)
```

*VCR Plus+ selects programs to be recorded with a Plus Code number, usually found in most of the program listings. Before using VCR Plus+, you must set up your Guide Channel. Set clock first (page 17).*

- 1 To enter a Plus Code, press the TIMER button. Press the ◀ and ▶ buttons to select "VCR Plus".
- 2 Locate the program's Plus Code in a local TV program guide. Press up to eight number buttons to set the Plus Code. Use ◀ to correct any mistakes.
- 3 Press OK to save the code. The channel number appears on the left side. The start and end recording times, recording date and speed also appear.
- 4 Press MENU to finish. Check whether there is enough time left on the video tape to record the program.
- 5 To stop a Timer Recording, press the VCR POWER button. When using a cable decoder box, make sure the decoder box is on.

# VCR Plus+ Set up (AMERICA Only)

With VCR Plus+, each channel is assigned a VCR Plus+ guide number, which can be found in most TV program guides. If your VCR comes with VCR Plus+, you can use this system when recording. Before using VCR Plus+, set the channel and VCR Plus+ numbers to match.

\* VCR Plus+ is trademark of Gemstar Development Corporation.  
Be sure to select the correct signal source (Antenna/Cable TV depending on your hook-up) before performing Guide Channel Setup.

- 1 Press MENU for the Main Menu. Press  $\blacktriangledown$  and  $\blacktriangleright$  to select "INSTALLATION". Press  $\blacktriangledown$  and  $\blacktriangleright$  to select "MANUAL SET UP".
- 2 Press  $\blacktriangleright$  to select "GUIDE CH SET UP".
- 3 VCR Plus+ Guide channel numbers appear on the top row. Receiving channels are on the bottom. Press  $\blacktriangleleft$  or  $\blacktriangleright$  to select a VCR Plus+ Guide channel number.
- 4 Press  $\blacktriangleleft$  or  $\blacktriangleright$  for the correct receiving channel number.  
**For example :** If receiving channel 23 corresponds to the VCR Plus+ Guide channel 45, press  $\blacktriangleright$  and  $\blacktriangleleft$  until 45 appears in the top row of numbers with the downward pointing arrow directly below.  
Press the  $\blacktriangleright$  and  $\blacktriangleleft$  until 23 appears on the bottom row.  
The channel number that changes is always the receiving channel rather than the VCR Plus+ Guide channel.
- 5 Press  $\blacktriangleleft$  or  $\blacktriangleright$  to select the next VCR Plus+ Guide channel number. Enter all the receiving channel numbers and press MENU to finish.

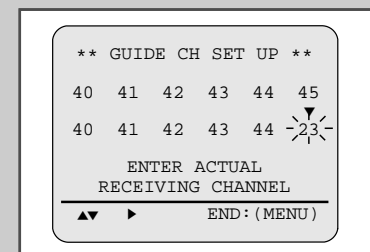
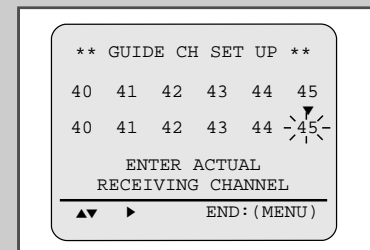
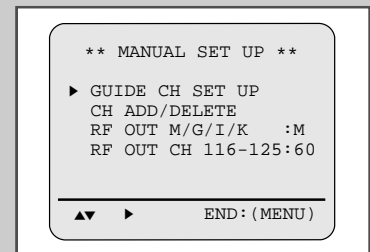
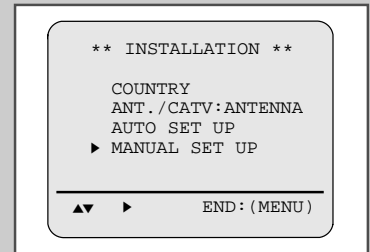

## Checking a Preset Recording

GB

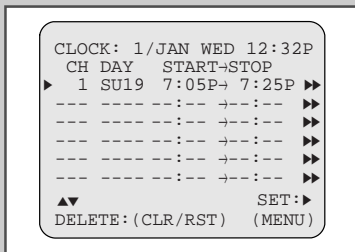
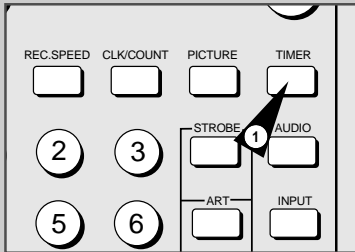

You can check your preset recordings:

- ◆ when you have finished presetting the VCR ; or
- ◆ if you have forgotten which programs will be recorded.

- 1 Press the TIMER button and select STANDARD TIMER.  
Result: The preset programs are displayed.
- 2 Press the  $\blacktriangle$  or  $\blacktriangledown$  button to select the required program.
- 3 Press the  $\blacktriangleright$  button to select the CH.
- 4 Press the  $\blacktriangle$  or  $\blacktriangleright$  button to select and change any value as required.
- 5 On completion, press MENU twice.

## Cancelling a Preset Recording

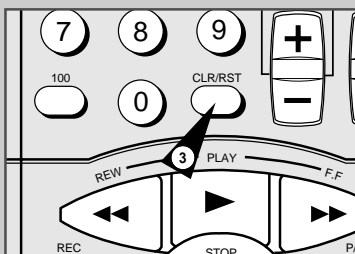
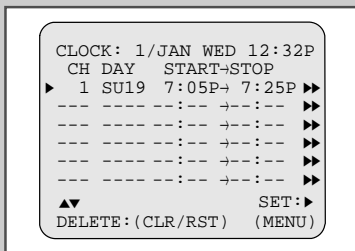

You can cancel any program that is:

- ◆ incorrect; or
- ◆ no longer required.

- 1 Press the TIMER button and select STANDARD TIMER.  
Result: The preset programs are displayed.
- 2 Select the program to be cancelled by pressing the  $\blacktriangle$  or  $\blacktriangledown$  button.
- 3 Press the CLR/RST button to cancel the selected program.  
Result: All the recording information is deleted and the broadcast will not be recorded.
- 4 On completion, press MENU twice.



## Playing a Cassette

This function enables you to play back any pre-recorded cassette.

- 1 Switch on both the television and your VCR.
  - 2 Select the television AV or AUX input.
  - 3 Insert the video cassette to be played. If the safety tab on the cassette is intact, press PLAY (▶). Otherwise, the cassette is played automatically.
    - When a cassette is loaded, the tape position is optimized automatically to reduce disturbance (Digital Auto Tracking). When playing a cassette, if the end of the tape is reached, the cassette is rewound automatically.
- |          |                    |               |  |
|----------|--------------------|---------------|--|
| <b>4</b> | <b>To:</b>         | <b>press:</b> |  |
|          | stop the playback  | STOP (■).     |  |
|          | eject the cassette | EJECT (▲).    |  |

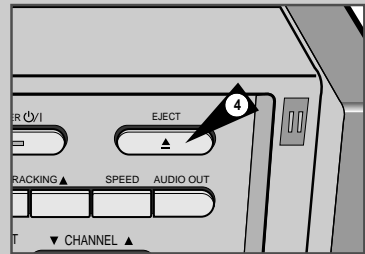
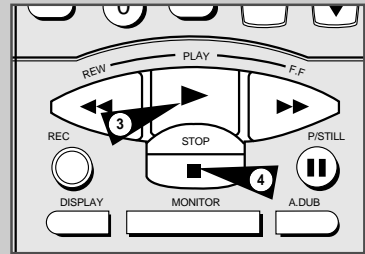

## Selecting the PLAY SYSTEM Mode

You can choose the **PLAY SYSTEM** if your system does not match the **SV-7000W VCR**.

This function only needs to be used when there is no color or picture during playback.

- 1 Press MENU on the remote control.  
Result: The programming menu is displayed.
- 2 Press the corresponding ▲ or ▼ button, until the cursor is placed in front of the **USER SET** option.
- 3 Press the ▶ button to select this option.  
Result: The **USER SET1** menu is displayed.
- 4 Press the corresponding ▲ or ▼ button, until the cursor is placed in front of the **PLAY SYSTEM** option.
- 5 Press ◀ or ▶ button until you select the appropriate system.
  - Case1 : NTSC or PAL-M Tape Playback  
 AUTO → NTSC → PAL-M  
 ↑
  - Case2 : PAL, SECAM, MESECAM Tape Playback  
 AUTO → PAL → SECAM → MESECAM  
 ↑
- 6 On completion, press MENU twice to exit the menu.

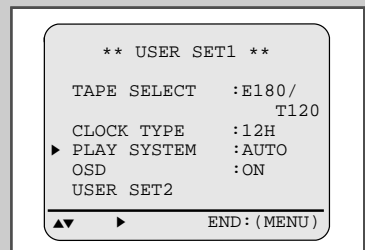
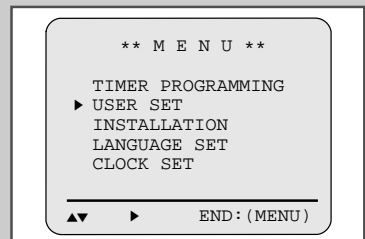

If you encounter a system error or the picture has no color when in AUTO mode, select the play system manually.

## Receiving Stereo Broadcasts

GB

STEREO 13

L, R (stereo) → L → R → MONO



*The VCR can receive and record stereo broadcasts.*

*It can also be set to record the secondary audio program (SAP) of any broadcast with second language audio.*

*The VCR records the same audio on both the Hi-Fi linear tracks on the tape.*

- 1 Press AUDIO button on the remote control to select stereo. You can also select left, right or mono.
- 2 When the stereo sound is poor, press the AUDIO button to select mono for sound without noise.

## Receiving SAP Broadcasts

\*\* USER SET2 \*\*

▶ SAP	:OFF
COLOR	:ON
BLUE SCREEN	:ON
USER SET1	

▲▼ ▶ END: (MENU)

SAP 6

1:23:28

MAIN → SAP → MONO



- 1 Press MENU on the remote control and select user set.
- 2 Press the ◀ and ▶ buttons to select **USER SET2**.
- 3 Press the ◀ and ▶ buttons to set **SAP** to **ON**.
- 4 Press menu key twice to exit MENU.
- 5 To select SAP, press the AUDIO button on the remote control until "SAP" is displayed on the screen. "SAP" will be displayed on the TV screen when a SAP broadcast is received.
- 6 Press the REC button at least one second for SAP recording.  
\* When main is displayed, stereo is selected.

## SQPB (Super VHS Quasi PlayBack)

*This function is for playback of Super VHS format tapes only, not for recording.*

- 1 Insert the Super-VHS format cassette.
- 2 Set the SQPB selection switch to SQPB.
- 3 Press the PLAY (▶) button to play.  
Result: SQPB indicator illuminates.



If the SQPB selection switch is set to the normal playback position, the video output will be distorted.

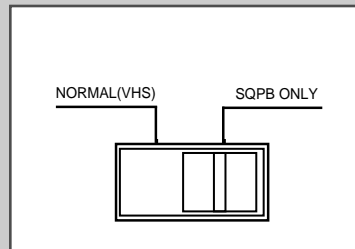

## Adjusting Picture Alignment Manually

*The Fine Adjustment feature enables you to adjust the alignment manually to obtain the best possible picture.*

When noise bars or streaks appear during playback, adjust alignment manually by pressing the TRACKING (∧ or ∨) buttons until the picture is clear and stable.

- Result:**
- ◆ The tracking bar appears.
  - ◆ The image is adjusted.
  - ◆ The tracking bar disappears when you release the button.

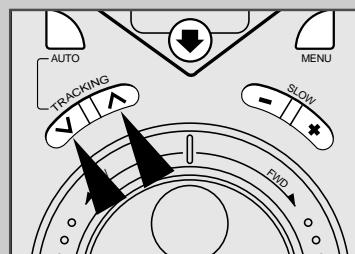

## Adjusting Picture Sharpness

GB

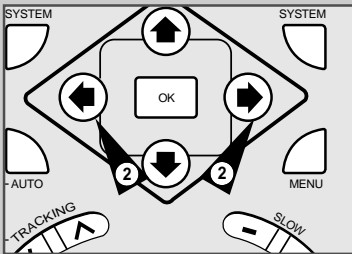
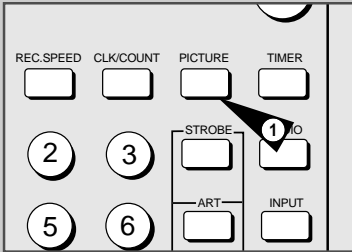

*The Picture Sharpness feature enables you to adjust the sharpness of the image according to your own preferences.*

- 1 During playback, press the PICTURE button.  
**Result:** The picture bar appears.
- 2 Press the ◀ and ▶ buttons until the picture is adjusted to your liking.  
➤ If you do not press a button within six seconds, the picture bar automatically disappears.
- 3 On completion, press the PICTURE button again.

## Selecting the Audio Output Mode

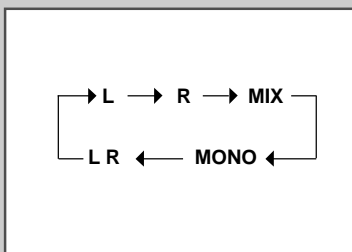
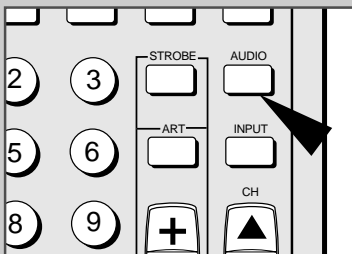

*You can select the mode in which the sound is reproduced on the LINE and AV outputs. The following options are available.*

Option	Description
L	Used to listen to the sound on the left Hi-Fi channel.
R	Used to listen to the sound on the right Hi-Fi channel.
MIX	Used to listen to the mixed sound of the Hi-Fi and linear audio. (For example, you can play back Hi-Fi audio sound while at the same time listening to narration dubbed onto the normal audio track. See pages 43 and 44 for further details of the Audio Dubbing feature.)
MONO	Used to listen to the sound on the linear mono channel.
L R	Used to listen to Hi-Fi stereo sound on the left and right channels. ➤ When playing back tapes recorded in Hi-Fi, the sound switches to Hi-Fi after five seconds of Mono.

To select the sound mode, simply press the AUDIO button on the remote control until the required option is displayed.

## Rewinding and Fast-forwarding a Cassette

You can:

- ◆ *rewind or fast-forward a cassette without seeing the picture on the television.*
- ◆ *search for a given sequence forwards or backwards on the tape.*

To:	press:
rewind the tape without viewing the picture	REW (◀◀) when the cassette is stopped.
rewind the tape while viewing the picture	REW (◀◀) when the cassette is playing (Reverse Search function).
switch from reverse search to playback again	REW (◀◀) while rewinding the tape with the picture displayed.
fast-forward the tape without viewing the picture	F.F (▶▶) when the cassette is stopped.
fast-forward the tape while viewing the picture	F.F (▶▶) when the cassette is playing (Forward Search function).
switch from forward search to playback again	F.F (▶▶) while fast-forwarding the tape with the picture displayed.

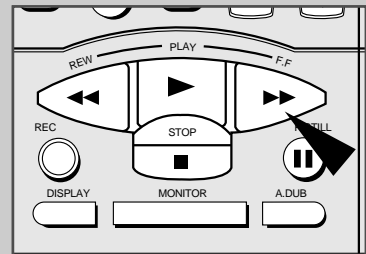
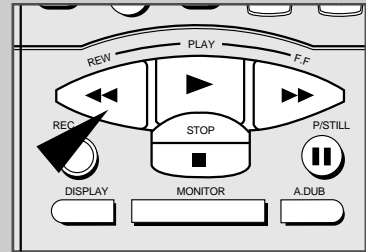

- The cassette is rewound automatically when the end of the tape is reached.  
If you press POWER while a cassette is being rewound, the VCR switches off automatically when the beginning of the cassette is reached.

## Playing a Cassette in Slow Motion

You can play a cassette in slow motion.

- No sound is heard when playing back a cassette in slow motion.

- 1 Press:
  - ◆ PLAY (▶) to start playing the cassette ;
  - ◆ SLOW (+ or -) to start slow mode play ;
  - ◆ SLOW (+ or -) as many times as required to decrease or increase the speed respectively ; and
  - ◆ PLAY (▶) to return to normal speed.
- 2 When playing back in slow motion, picture interference may occur. Press the TRACKING (↖ or ↗) buttons to minimize this effect.

- ☞ If the slow motion function is used for more than five minutes, the VCR will automatically play to protect the:
  - ◆ cassette ; and
  - ◆ video heads.

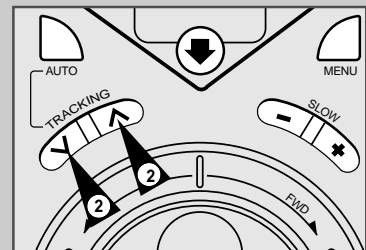
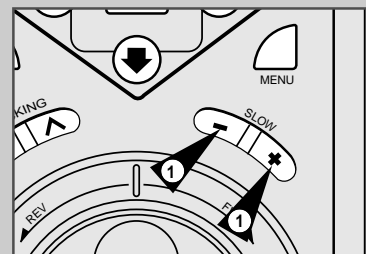

## Playing a Sequence Frame by Frame

GB

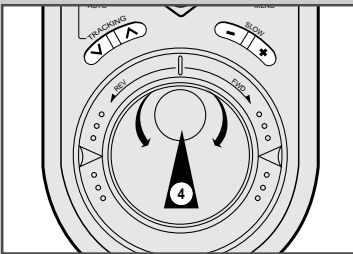
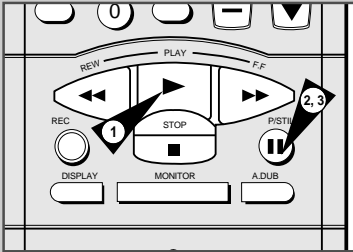

You can:

- ◆ stop the cassette at a given frame (image) ; and
- ◆ advance one frame at a time.

➤ No sound is heard when playing back frame by frame.

- 1 Press the PLAY (▶) button to start playing the cassette.
- 2 Press the P/Still button (||) to stop the tape at a given frame.
- 3 Press the P/Still button (||) again to advance forward frame by frame.
- 4 Instead of Step 3 you can also turn the JOG to the left or right to advance frame by frame backward or forward.
- 5 To return to normal playback, press the PLAY (▶) button.



If the Frame-by-Frame function is used for more than five minutes (except for JOG function), the VCR will automatically play to protect the cassette and video heads.

## Playing a Sequence at Variable Speeds

You can vary the playback speed using the Shuttle function (up to nine times the normal speed).

**Example:** You wish to analyze an athlete's technique, movement by movement.

The Shuttle function is available on the remote control.

➤ No sound is heard when playing a sequence at variable speeds.

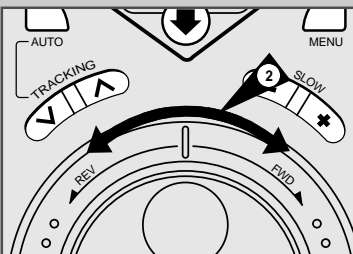

- 1 Press the PLAY (▶) button to start playing the cassette.
- 2 Turn the SHUTTLE RING to the left or right to vary the playback speed.
- 3 Each time you turn the shuttle ring, the speed will change as shown in the following illustration.

(SP on All Systems)

REVERSE X9	REVERSE X7	REVERSE X3	REVERSE PLAY	REVERSE SLOW (1/5)	REVERSE SLOW (1/10)	STILL	SLOW (1/5)	SLOW (1/10)	PLAY	PLAY X2	PLAY X7	PLAY X9
------------	------------	------------	--------------	--------------------	---------------------	-------	------------	-------------	------	---------	---------	---------

(LP on PAL/SECAM/MESECAM/PAL-N)

REVERSE X15	REVERSE X9	REVERSE X5	REVERSE PLAY	REVERSE SLOW (1/5)	REVERSE SLOW (1/10)	STILL	SLOW (1/5)	SLOW (1/10)	PLAY	PLAY X2	PLAY X9	PLAY X15
-------------	------------	------------	--------------	--------------------	---------------------	-------	------------	-------------	------	---------	---------	----------

(SLP on NTSC/PAL-M)

REVERSE X15	REVERSE X9	REVERSE X7	REVERSE PLAY	REVERSE SLOW (1/5)	REVERSE SLOW (1/10)	STILL	SLOW (1/5)	SLOW (1/10)	PLAY	PLAY X2	PLAY X9	PLAY X15
-------------	------------	------------	--------------	--------------------	---------------------	-------	------------	-------------	------	---------	---------	----------



When you activate Variable Speed play, there will be no color in some modes. This is normal operation. Modes with no color are shown below.

- ◆ No color modes : • Variable Speed play of LP recordings on any system.
- X2 and Still/Slow play of SLP recordings in PAL-M mode.



If the picture is noisy or distorted during X2 play or other variable speed play, adjust the tracking manually for a cleaner picture.

## STROBE

You can see still images in succession.

- 1 Press the STROBE button during playback.  
Result: "STROBE" is displayed on the screen.  
A Discrete image is displayed on screen similar to SLOW mode.
- 2 Press the +/- to vary the speed of STROBE mode.
- 3 To exit the STROBE mode, press the STROBE button.

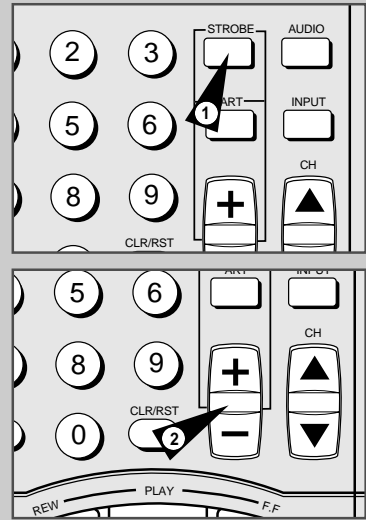

## ART

When in the ART mode, the picture contrast is changed to resemble artwork.

- 1 Press the ART button during PLAY or STROBE mode.  
Result: The contrast of the image is changed.
- 2 Press the +/- buttons to vary the contrast of ART mode.
- 3 To exit the ART mode, press the ART button.

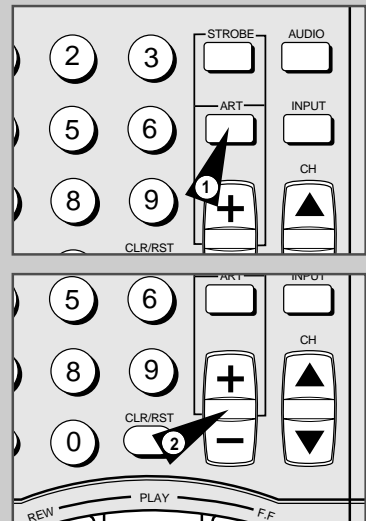

## MONITOR

You can see the original input signal during a conversion recording.

- 1 Press the MONITOR button during conversion.  
Result: ♦ Original input signal is displayed on screen.
- 2 Press the MONITOR button again.  
Result: ♦ The converted output signal is displayed on screen.

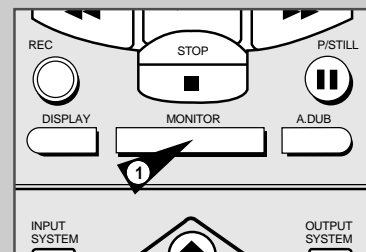

## Searching for a Specific Sequence

GB

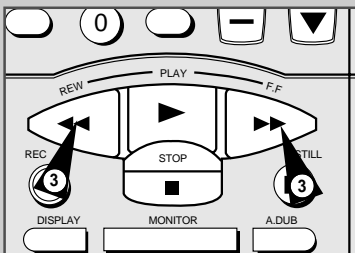
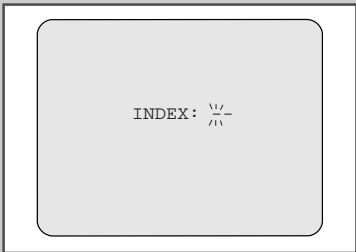
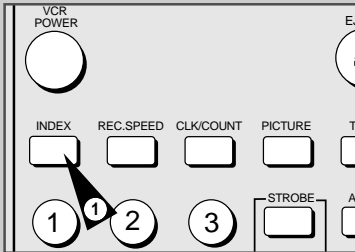

Each time you record a cassette on this VCR, an "index" is automatically marked on the tape when recording starts.

The Search function enables you to fast-forward or rewind to a specific index and start playback from that point. Depending on the direction selected, the indexes are numbered as follows.

		↓		
etc.	Prev Seq.	Seq. being played	Next Seq.	etc.
	2	1	1	2

➤ This VCR uses a standard indexing system (VISS). As a result, it will recognize any indexes marked by other VCRs using the same system and vice versa.

- 1 To search for a specific index, press INDEX.
- 2 Enter the number of the index to be found using the numeric buttons.
  - When entering a single-digit number, do not forget to precede it with a zero.  
Example: 02.

Result: The index number is displayed.
- 3 Select the direction in which the VCR is to search:
  - ◆ REW (◀◀) to search backwards ; or
  - ◆ F.F (▶▶) to search forwards.

Result: When the index is found, cassette playback starts.



# Using the Tape Counter

## The tape counter:

- ◆ indicates the elapsed time in the play and record modes (hours, minutes and seconds) ;
- ◆ is reset when a cassette is inserted in the VCR ; and
- ◆ enables you to find the beginning of a sequence easily.



To enable the remaining time to be calculated correctly, you must indicate the type of cassette being used. See page 22.

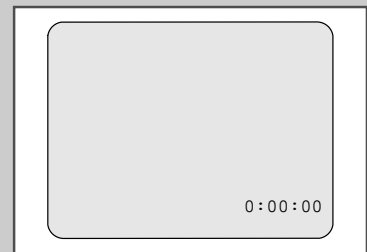
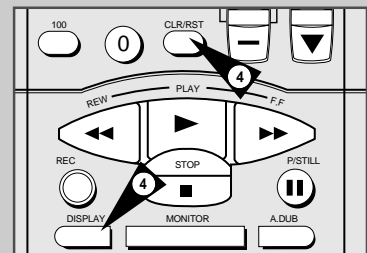
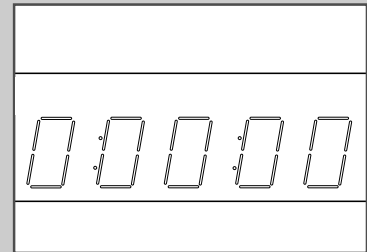
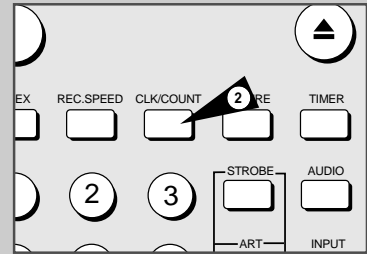

- 1 Insert a cassette in your VCR.
- 2 Press CLK/COUNT twice.  
**Result:** The tape counter is displayed:  
0:00:00.  
➤ The tape counter does not necessarily start from zero at the beginning of the tape.
- 3 Select the required operation (play, record, fast-forward, rewind).  
**Result:** The tape counter indicates how long the cassette has been running.
- 4 To set the tape counter to zero at the beginning of a sequence:
  - ◆ press DISPLAY twice to display the counter ; and
  - ◆ press CLR/RST when you want to set the tape counter to zero.
- 5 To fast-forward or rewind to the sequence at which the counter was set to zero, simply press REW (◀◀) or F.F (▶▶).  
**Result:** The VCR stops automatically when the counter reaches zero.



Some VCR information, such as the counter, can be displayed on the television screen (unless you have deactivated the OSD mode; refer to page 17).

Press DISPLAY:

- ◆ once to display the current function, program number, recording speed, date, time and counter ;
- ◆ twice to display the counter only ;
- ◆ three times to display the time remaining on the cassette ; and
- ◆ four times to clear the display.

## Using the Assemble Edit Function

GB

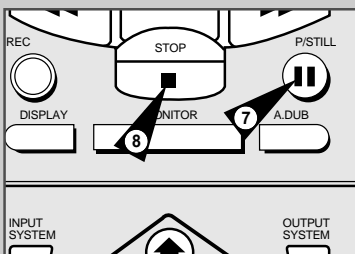
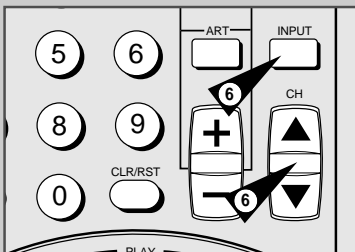
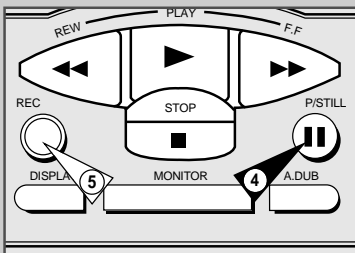
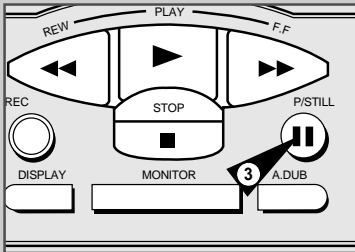
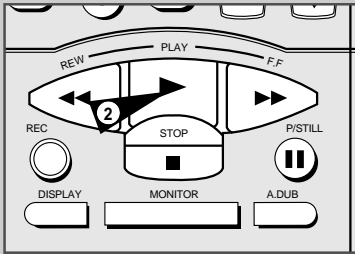

*This function enables you to start a new recording at a specific position on the cassette while maintaining a very smooth scene change.*

- 1 Insert the cassette to be edited in your VCR.
- 2 Press the PLAY button (▶) to start playback.
- 3 When you reach the position from which you wish to start the new recording, press the P/STILL button (⏸).
- 4 Press the P/STILL button (⏸) again as often as necessary to advance frame by frame, until the exact recording position is located.
- 5 While the VCR is in still mode, press the REC button at least one second to activate the Assemble Edit function.  
**Result:** The Record symbol (Ⓞ) flashes on the display.
- 6 Select the source from which you wish to record by pressing:
  - ◆ the CH (▲ or ▼) buttons for television channels ; or
  - ◆ the INPUT button for the SC, AV, L1 or L2 input sources.Perform necessary hookups and activate source. Refer to page 39.
- 7 Press the P/STILL button (⏸) to start recording.
- 8 When you have finished recording, press STOP (■).

# Connecting Other Equipment to Your VCR

You can connect other audio and/or video equipment to your VCR in different ways. The following illustrations give a few examples of the connection possibilities.

- The LINE 1 input connectors on the front of the VCR are used to input signals from equipment such as camcorders, VCRs or stereo sound systems.

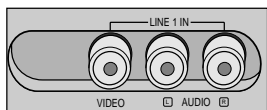

FRONT OF THE VCR

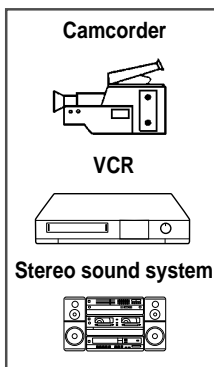
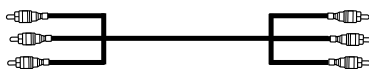

- The RCA output connectors (OUT1 or OUT2) on the rear of the VCR are used to output signals to equipment such as a stereo sound system.

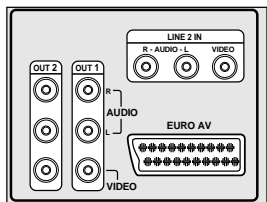

REAR OF THE VCR

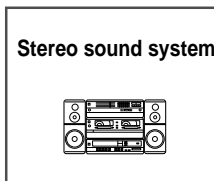
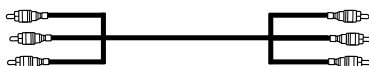

- The EURO AV connector on the rear of the VCR is used for equipment with a SCART input/output such as a satellite tuner or VCR.

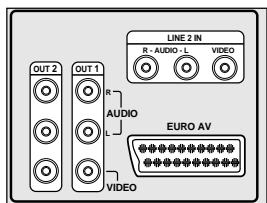

REAR OF THE VCR

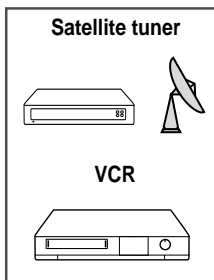
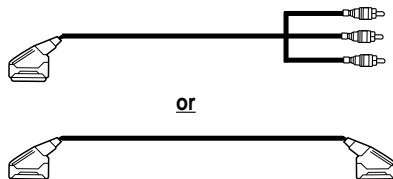

## Recording from Another VCR or Camcorder

GB

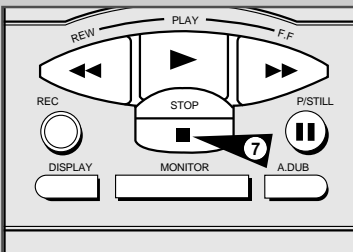
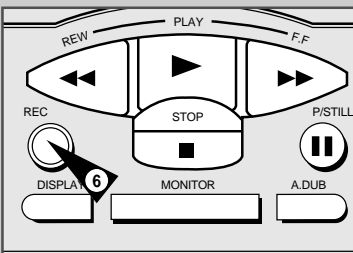
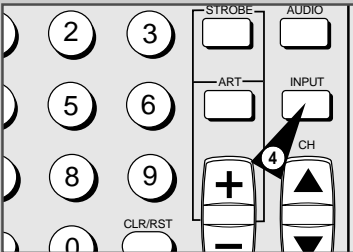
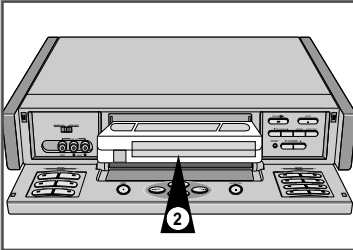

*You can copy a cassette on your Samsung VCR from another video source such as another VCR or a camcorder.*



It is an infringement of copyright laws to copy prerecorded cassettes or to re-record them in any form without the permission of the owners of the corresponding copyright.

- 1 Connect the VCR from which the cassette is to be copied to the appropriate RCA audio and video input connectors on the front of your Samsung VCR, as indicated on page 39.
  - If the other video source does not supply stereo sound, connect only the left audio input (L).  
You can also use a SCART cable to connect to the EURO AV on the rear of your VCR.
- 2 Insert a blank cassette in your VCR.
- 3 Insert the pre-recorded cassette in the other video source (VCR or camcorder).
- 4 Press the INPUT button to select the appropriate input on your VCR:
  - ◆ LINE 1 or LINE 2 ; or
  - ◆ AV for the EURO AV.
- 5 Start playing back the cassette to be copied.
- 6 Press the REC button for at least one second to start recording on your VCR.
- 7 When you have finished recording, press STOP (■) on both VCRs.
  - If you wish to view the cassette being copied:
    - ◆ the VCR must be connected to your television (see page 14 for further details) ; and
    - ◆ you must select the television AUX input.

## TV System Conversion

You can convert the input signal into the desired TV system.

- 1 Connect the RCA audio/video cable into the LINE 1 IN jacks on the front of the VCR.
- 2 Press the AUTO button on the VCR to select the input signal. (Initial mode is AUTO)
  - ◆ When the Auto mode is selected, the input signal is automatically identified.
  - ◆ When the input signal is not automatically identified, select the corresponding input system manually.
- 3 If you wish to convert the NTSC TV system into the PAL system, press the AUTO or NTSC input button on the VCR.  
Result: The display panel shows the NTSC input signal and the NTSC output signal.
  - ◆ If the input signal does not correspond to the input button on the VCR, an abnormal signal is outputted.
- 4 Press the PAL output system button on the VCR.  
Result: The display panel shows the NTSC input signal and the PAL output signal, and the NTSC signal is converted into the PAL signal for output.

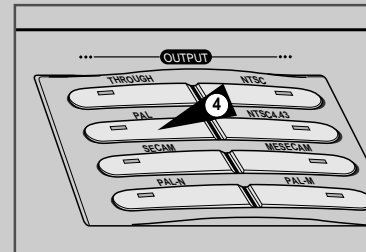
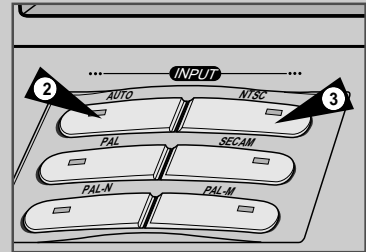
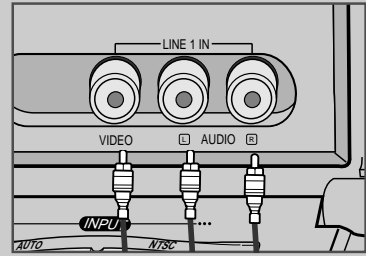

## Playback Conversion

You can perform playback conversion of the signal recorded on the tape into the appropriate format for the country.

- 1 If you wish to convert a PAL system tape into the NTSC system for playback, then press the NTSC output button on the VCR.  
Result: The display panel shows NTSC output signal.
- 2 Insert the video tape into the VCR.
  - ◆  is shown on the display panel.
  - ◆ A video tape without the record protect (safety) tab intact will play back automatically.
- 3 Press the PLAY (▶) button.  
Result: The TV system recorded on the tape is automatically read, and the PAL signal is converted into the NTSC signal for playback.

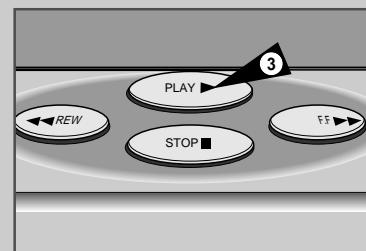
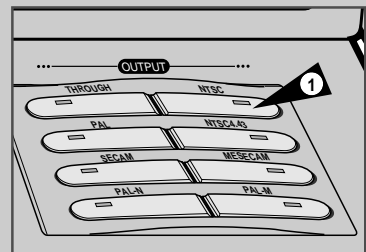

## Conversion Recording

GB

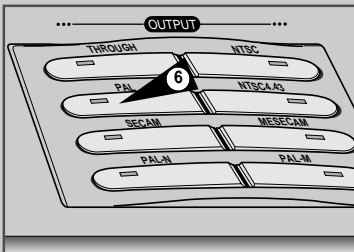
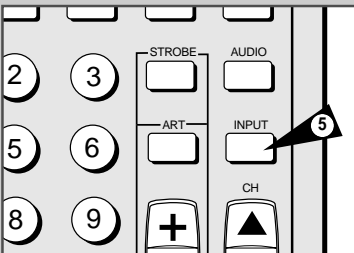
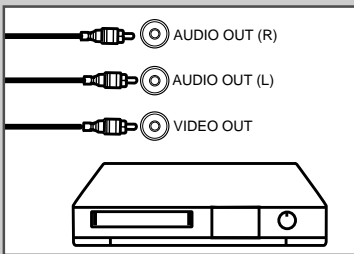
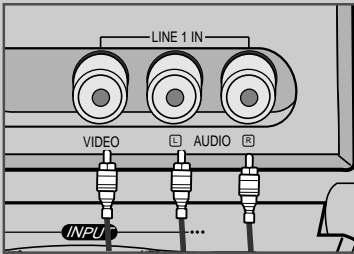

*You can convert the signal recorded on a tape to another format on a second tape.*

- 1 Connect the RCA Audio/Video cable to the input on the front of the Samsung VCR (SV-7000W)
- 2 Insert the tape to record.
- 3 Connect the other end of the RCA Audio/Video cable to the output connectors of another VCR (see page 39).
- 4 If you wish to convert from a tape recorded on NTSC to a PAL recorded tape, insert the NTSC tape into the other VCR.
- 5 Press the INPUT button on the remote control to select the L1 input.  
Result: The display panel shows L1.
- 6 Press the PAL output system button on the front panel to select the PAL system.  
Result: The display panel shows PAL.
- 7 Press the PLAY button of the other VCR.
- 8 Press the REC button of the Samsung VCR for at least one second.  
Result:  appears on the display panel, and recording begins.

➤ Follow these steps to perform conversion recording to other formats.

## Hi-Fi and linear audio

To provide true Hi-Fi audio sound with video entertainment and, at the same time, compatibility with regular VHS tapes, your VCR employs a newly-developed audio recording system.

Hi-Fi audio signals (2-channel) are recorded deep into the tape's magnetic coating and the video signal is recorded on top of the audio signals in a shallower layer. At the same time, another audio head records linear audio signals (monaural) onto the normal audio track. With the Audio Dubbing function, it is possible to erase the old monaural soundtrack and record a new one.

## Tape pattern recorded with your VCR

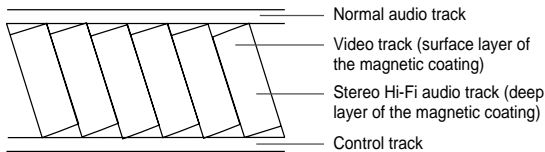

Hi-Fi audio recording and reproduction are available only from the Hi-Fi audio track, while the normal audio track provides normal audio.

The Hi-Fi and normal soundtracks are recorded simultaneously and audio dubbing is applicable only to the normal audio track.

## Recording options according to the setting of the INPUT button

INPUT button \ Track	Video track	Normal audio track (mono)	Hi-Fi audio track (2-channel)
TUNER (CH 10)	TV picture (from built-in tuner)	TV sound (from built-in tuner)	
SIMULCAST (SC)	TV picture (from built-in tuner)	Audio signal from audio input connector (Line I)	
LINE 1 (L1) LINE 2 (L2)	Video signal from video input connector	Audio signal from audio input connector	
EURO AV (AV)	Video signal from audio/video connector	Audio signal from audio/video connector	

## Audio Dubbing a Pre-recorded Cassette

GB

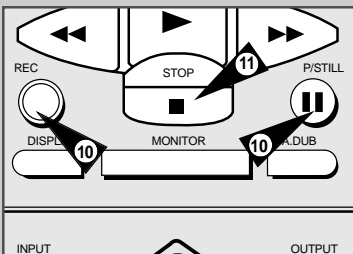
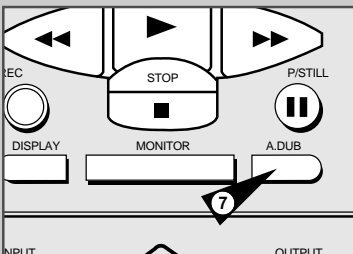
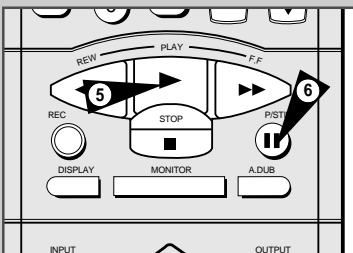
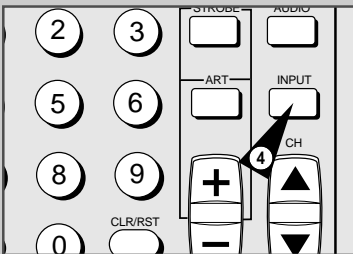
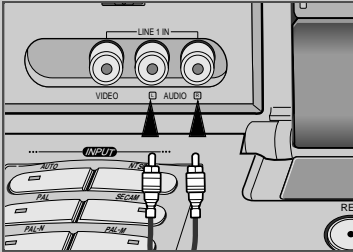

With the Audio Dubbing function, you erase the previously recorded sound and replace it with a new soundtrack from:

- ◆ a CD player ;
- ◆ a microphone connected to a sound system ; or
- ◆ a cassette player.

**Note:**

Audio dubbing is applicable only to the linear audio track .

- 1 Connect an RCA audio cable to the appropriate output on your sound system (CD/cassette player for example).
- 2 Connect the other end of the RCA audio cable to the audio input connectors (L+R) on the front of your VCR.
- 3 Insert the pre-recorded video cassette on which the audio track is to be replaced.
- 4 Select the LINE 1 input by pressing INPUT until LI is displayed.
- 5 Locate the point on the cassette at which you wish to start dubbing.
- 6 Press P/STILL (||).
- 7 Press A.DUB.  
Result: Your VCR is now in the Audio Dubbing Pause mode.
- 8 On the sound system, locate the point on the CD or cassette at which you wish to start playback.  
Example: The track that you wish to record on the cassette.
- 9 Press the pause button on your sound system.
- 10 When you are ready:  
◆ start playback on the sound system ; and  
◆ press REC or P/STILL (||) on the remote control.  
Result: The soundtrack is replaced on the pre-recorded video cassette.
- 11 When you have finished recording, press STOP (■).



# Recording an FM Simulcast Program

The FM Simulcast feature enables you to record:

- ◆ the picture received on the VCR's tuner ;  
*and*
- ◆ the sound received from an external source via the LINE 1 RCA input connectors on the front of the VCR.

**Example:** You wish to record a concert transmitted simultaneously on television and radio to take advantage of FM stereo sound.

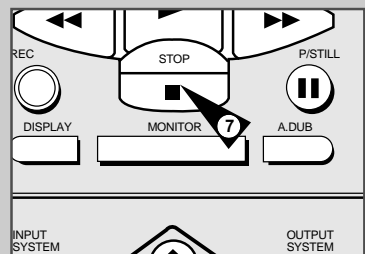
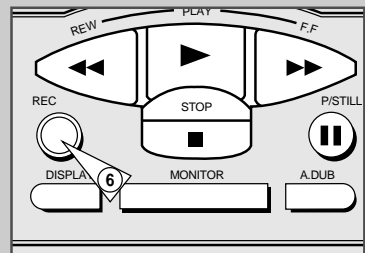
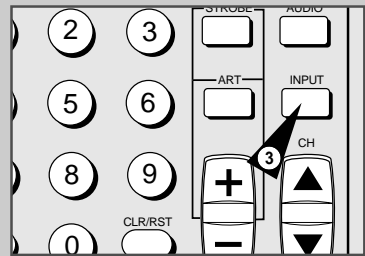
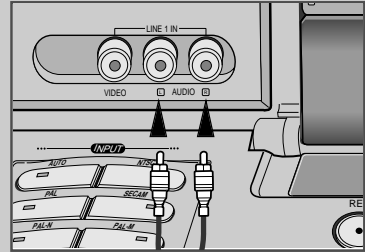

- 1 Connect an RCA audio cable to the appropriate output on your sound system (radio for example).
- 2 Connect the other end of the RCA audio cable to the audio input connectors (L+R) on the front of your VCR.
- 3 Select the SC Simulcast mode by pressing INPUT one or more times until SC is displayed.
- 4 Select the television program by using the CH Up/Down buttons.
- 5 Tune the sound system to the appropriate radio station.
- 6 Press the REC button for at least one second when the broadcast starts.  
**Result:** The sound received on the LINE 1 input is recorded with the pictures received on the tuner.
- 7 When you have finished recording, press STOP (■).

- If you wish to view the pictures being recorded:
- ◆ your VCR must be connected to the television (see page 14 for further details)

## Locking Your VCR

GB

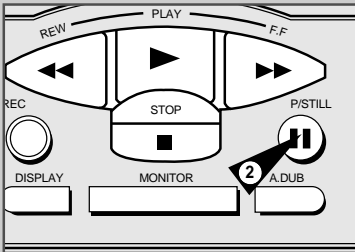
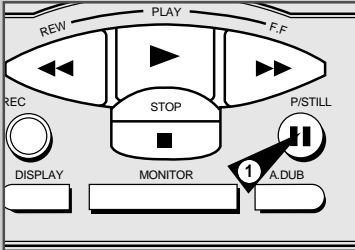

*The playback functions on your VCR can be locked to prevent the VCR from being used by young children.*

*You can still watch television programs via the VCR but you cannot insert or play a cassette.*

- 1 To lock the VCR, hold down the P/STILL (||) button for approximately five seconds.

**Result:** The lock indicator (**LOCK**) is displayed.

➤ If a cassette is in the VCR when you lock it, the cassette will be ejected.

- 2 To unlock the VCR, hold down the P/STILL (||) button again for approximately five seconds.

**Result:** The lock indicator (**LOCK**) is no longer displayed.

## Resetting Your VCR

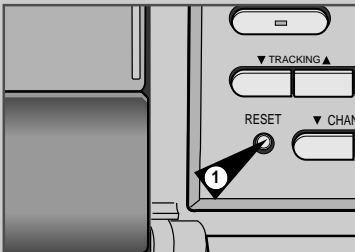

*If you find that your VCR is not operating correctly, or no indications appear in the display, you can reset it.*

- 1 Press the RESET button on the front panel with a pen or pencil, to reset the VCR.

**Result:** All preset data will be erased and will need to be reprogrammed.

- 2 If the problem is not solved after you have reset the VCR, refer to page 48 for a list of simple checks to be performed before contacting an authorized service center.

# Technical Specifications

Recording system	Rotary head azimuth recording, luminance signal FM recording system.	
	Chrominance signal down converted phase shift recording system (NTSC, PAL, PAL-M).	
	Chrominance signal down converted direct recording system (MESECAM).	
	Chrominance signal 1/4 frequency countdown direct recording system (SECAM).	
Color system	NTSC, NTSC4.43, PAL, PAL-M, PAL-N, SECAM	
Tuning system	B/G, D/K, I, M, N, L	
RF out	M/G/I/K/L UHF 14-69, 116-125(M-System only)	
Tape recording/playback	NTSC, PAL, PAL-M, SECAM, MESECAM	
Tape speed	NTSC	33.35mm/sec (standard recording : SP)
	PAL-M	11.12mm/sec (three times recording : SLP)
	PAL	23.39mm/sec (standard recording : SP)
	MESECAM SECAM	11.69mm/sec (double speed recording : LP)
Tape format	VHS type video tape, S-VHS type video tape (Play back only)	
Recording time	Maximum 8 hours (with a T-160 or E-240 tape)	
Rewinding time	Within 100 Seconds (high speed rewinding, T-120 or E-180 tape)	
Video input	1.0Vp-p (unbalanced) 75 Ω	
Video output	1.0Vp-p (unbalanced) 75 Ω	
Video S/N	Above 43dB (standard recording)	
Resolution	Above 220 (standard recording NTSC), 240 (standard recording PAL)	
Audio input	-8dBm, 47 Kohm unbalanced	
Audio output	-8 ± 3 dBm, 1 Kohm unbalanced	
Audio S/N	Above 39dB (Mono), 68dB (Hi-Fi)	
Audio frequency characteristics	20Hz-20kHz	
Rated voltage	100V~240V AC	
Rated frequency	50/60Hz	
Power consumption	APP. 24 watts on recording; 8 watts off	
Operating ambient temperature	41°F-104°F (5°C - 40°C)	
Installation conditions	Operation position : Horizontal, Relative humidity : Below 80%	
Outside dimensions	Width 465mm(18.3in) x Length 310mm(12.2in) x Height 98mm(3.86in)	
Weight	4.8Kg(10.6 lbs)	

# Troubleshooting Guide

*Before contacting Samsung authorized service center, perform the following simple checks.*

<b>Problem</b>	<b>Explanation/Solution</b>
No power.	<ul style="list-style-type: none"> <li>◆ Check that the power plug is connected to a wall outlet.</li> <li>◆ Have you pressed the VCR POWER button?</li> </ul>
You cannot insert a video cassette.	<ul style="list-style-type: none"> <li>◆ A video cassette can only be inserted with the window side up and the safety tab facing you.</li> <li>◆ Check that the VCR has not been safety-locked (<b>LOCK</b> displayed). If so, hold P/STILL (<b>  </b>) down for at least five seconds to release it.</li> </ul>
The television program was not recorded.	<ul style="list-style-type: none"> <li>◆ Check the VCR/antenna connections.</li> <li>◆ Is the VCR tuner properly set?</li> <li>◆ Check if the safety tab is intact on the cassette.</li> </ul>
Timer recording was unsuccessful.	<ul style="list-style-type: none"> <li>◆ Was the VCR POWER button pressed to activate the timer?</li> <li>◆ Re-check the recording start/stop time settings.</li> <li>◆ If there was a power failure or interruption during timer recording, the recording will have been cancelled.</li> <li>◆ Check that the channel number selected with the Timer Program code is correct.</li> </ul>
No playback picture or the picture is distorted.	<ul style="list-style-type: none"> <li>◆ Press the TRACKING buttons ( ^ or v ).</li> <li>◆ Check to see if you are using a pre-recorded tape.</li> <li>◆ Check the playback system in the USER SET Menu.</li> <li>◆ Check the position of the SQPB selection switch on the Front Panel. (See page 31)</li> </ul>
You cannot see normal broadcasts.	<ul style="list-style-type: none"> <li>◆ Check that the source selected using the INPUT button is the VCR's tuner.</li> <li>◆ Check the TV-VCR/antenna connections.</li> </ul>
Noise bar or streaks on playback.	<ul style="list-style-type: none"> <li>◆ Press the TRACKING buttons ( ^ or v ) to minimize this effect.</li> </ul>
No operation when the: <ul style="list-style-type: none"> <li>• REW button is pressed ; or</li> <li>• F.F button is pressed.</li> </ul>	<ul style="list-style-type: none"> <li>◆ Check that tape is not already fully wound.</li> </ul>
When the P/STILL ( <b>  </b> ) button is pressed during playback, the still picture has severe "noise bar" streaks.	<ul style="list-style-type: none"> <li>◆ A still picture may have "noise bars", depending on the condition of the tape. Press the TRACKING buttons ( ^ or v ) to minimize this effect.</li> </ul>
Incorrect operations or no display.	<ul style="list-style-type: none"> <li>◆ Use a pencil to press the RESET button and re-initialize the VCR. All preset data is lost.</li> </ul>

*If you are unable to solve the problem after reading the above instructions, note:*

- ◆ *the model and serial number on the rear of your VCR ;*
- ◆ *the warranty information ; and*
- ◆ *a clear description of the problem.*

*Then contact your nearest SAMSUNG authorized service center.*

## Glossary of Terms

*To help you understand the main technical terms used in this booklet and take full advantage of the features on your VCR, here are a few definitions.*

---

<b>Tuner</b>	Element in the VCR used to decode the signals received via the antenna or cable TV. A tuner can only receive one broadcast at a time but you can use the tuner in your VCR to record one program while watching a different program via the tuner in your television. To receive a broadcast, the tuner must be set to the frequency of the appropriate channel.
<b>Station or Channel</b>	Frequency assigned to a given broadcasting company to enable them to transmit a series of broadcasts or programs.
<b>Program</b>	Number assigned to a given channel on the tuner in the VCR to help you select it more easily. Broadcast transmitted on a given channel.
<b>Cable TV</b>	Coaxial cable network transmitting broadcasts on a subscription basis. The cable is connected to the same input as an antenna.
<b>Broadcasting standard or Color standard</b>	Standard used to code pictures and sound. Different standards are used in different countries. In the United Kingdom for example, the PAL I standard is used.

---

# World Broadcast Systems

SYSTEM ITEM	NTSC	PAL					SECAM			
		B/G	D/K	N	M	I	B/G	D/K	I	L
<b>Country</b>	Bahamas	Afghanistan	China	Argentina	Brazil	Angola	Egypt	Bulgaria	Gambia	France
	Barbados	Albania, Algeria	Korea (North)	Paraguay		Botswana	Iran	CIS (USSR)		
	Bermuda	Australia		Uruguay		Hong Kong	Iraq	Congo		
	Cambodia	Austria, Azores		Bolivia		South Africa	Lebanon	Czech Republic		
	Canada	Bahrain				Zanzibar	Lesotho	Burkina Faso		
	Chile	Bangladesh					Libya	Burundi		
	Colombia	Brunei, Cameroon					Mauritania	Djibouti		
	Costa Rica	Canary Islands					Saudi-Arabia	French Guiana		
	Cuba	Cape Verde					Tunisia	Gabor		
	Dominican	Cyprus, Denmark						Guadeloupe		
	Ecuador	Fiji, Finland						Guinea		
	El Salvador	Germany, Grana						Guinea-Bissau		
	Greenland	Iceland, India						Guiana		
	Guam	Indonesia, Israel						Hungary		
	Guatemala	Italy, Jordan						Ivory Coast		
	Haiti	Konya, Kuwait						Madagascar		
	Honduras	Laos						Martinique		
	Jamaica	Liechtenstein						Mongolia		
	Japan	Madeira						Poland		
	Korea(South)	Majorca Islands						Reunion		
	Mexico	Malaysia, Malawi						Rumania		
	Micronesia	Mozambique						Slovakia		
	Myanmar	Netherlands,						Tahiti		
	Nicaragua	New Zealand						Togo		
	Panama	Nigeria, Norway						Zaire		
	Peru	Oman						New Caledonia		
	Philippines	Pakistan, Palestine						Niger		
	Puerto Rico	Papua New Guinea						Rwanda		
	Samoa	Portugal, Qatar						Senegal		
	(America)	Sierra Leone								
	Surinam	Singapore, Spain								
	Taiwan	Sri Lanka								
	Trinidad&	Sudan, Swaziland								
	Tobago	Sweden, Switzerland								
	U.S.A	Thailand, Turkey								
	Venezuela	Uganda, Yemen								
	Virgin Islands	United Arab Emirates								
	Vietnam	Zambia, Zimbabwe								

# International Service Network

---

## ● Head Office (Korea)

Tel : 82-331-200-5570  
Web site : <http://www.samsungelectronics.com>

---

## ● North & Latin America

### U.S.A (United States America)

Tel : 973-691-6200/1-800-Samsung  
Web site : <http://www.sosimple.com>

### Canada

Tel : 905-819-5031/1-800-Samsung  
Web site : <http://www.samsungcanada.com>

### Mexico

Tel : 52-5-686-0800  
Web site : <http://www.samsung-latin-america.com>

### Panama

Tel : 507-210-1133  
Web site : <http://www.samsung-latin-america.com>

### Brazil

Tel : 55-11-541-8500  
Web site : <http://www.samsung-latin-america.com>

### Argentina

Tel : 541-308-4777  
Web site : <http://www.samsung.com.ar>

### Colombia

Tel : 57-1-633-4410  
Web site : <http://www.samsung-colombia.com>

### Chile

Tel : 56-2-232-7000  
Web site : <http://www.samsung-latin-america.com>

### Peru

Tel : 51-1-4-4011121  
Web site : <http://www.samsung-latin-america.com>

---

## ● Middle East & Africa

### Dubai

Tel : 971-4-837-700

### Saudi Arabia

Tel : 966-2-651-2111

### Kuwait

Tel : 965-470-6612

### South Africa

Tel : 27-11-463-5678  
Web site : <http://www.samsung.co.za>

---

## ● Europe

### U.K (United Kingdom)

Tel : 44-1952-292-262  
Web site : <http://www.samsungelectronics.co.uk>

### France

Tel : 33-10-4938-6569  
Web site : <http://www.samsung.fr>

### Germany

Tel : 49-6196-66-1900  
Web site : <http://www.samsung.de>

### Italy

Tel : 39-2-9214-1815

### Portugal

Tel : 35-1-414-8112

### Spain

Tel : 34-3-261-6701

### Sweden

Tel : 468-5910-96630  
Web site : <http://www.samsung.se>

### Netherlands

Tel : 3170-307-2910  
Web site : <http://www.samsung.nl>

### Hungary

Tel : 36-1-188-7925

### CIS (Russia)

Tel : 1-502-224-5210 (Moscow)  
Tel : 380-44-227-8330 (Ukraine)

---

## ● Asia & Oceania

### Singapore

Tel : 65-568-7500

### Japan

Tel : 81-3-5564-0360  
Web site : <http://www.samsung.co.jp>

### India

Tel : 91-11-643-7391  
Web site : <http://www.samsungindia.com>

### China

Tel : 86-10-6460-6504

### Australia

Tel : 61-2-9898-5745  
Web site : <http://www.samsung.co.au>





## Free Manuals Download Website

<http://myh66.com>

<http://usermanuals.us>

<http://www.somanuals.com>

<http://www.4manuals.cc>

<http://www.manual-lib.com>

<http://www.404manual.com>

<http://www.luxmanual.com>

<http://aubethermostatmanual.com>

Golf course search by state

<http://golfingnear.com>

Email search by domain

<http://emailbydomain.com>

Auto manuals search

<http://auto.somanuals.com>

TV manuals search

<http://tv.somanuals.com>