

# FEATURES

## 1 Reciprocating “mini agitator” imitates hand wash action:

- ◆ With strong power for heavy clothes and soft touch for delicate items, the mini agitator moves up and down to remove dirt just like hand washing.



## 2 Twin filter nets collect lint and residue: OPTION

- ◆ Two large, wide filter nets catch lint and other larger particles that can accumulate on certain fabrics.

## 3 Water cascades pound the wash: OPTION

- ◆ Powerful waterfalls injected from two ports above the wash bowl pound and push down floating garments to produce a more effective overall wash action.



## 4 Detergent box and fabric softener dispenser:

- ◆ The detergent box evenly dispenses the washing detergent during the wash cycle to improve detergent dilution and reduce residue build-up. This feature also prevents bleaching damage to clothes from undiluted detergent when using the delay start cycle.
- ◆ The convenient fabric softener dispenser adds the softener automatically.

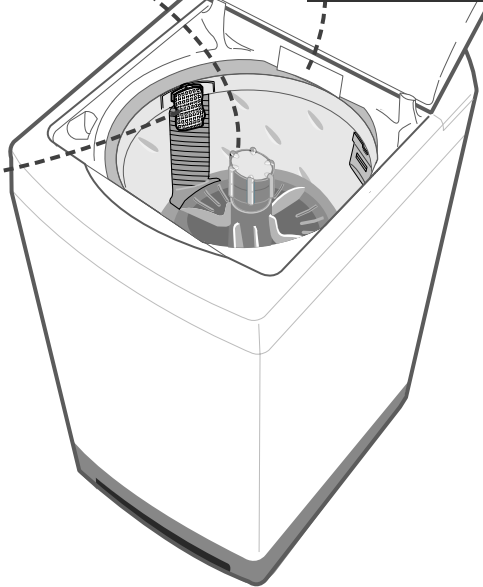

# DESCRIPTION OF PARTS

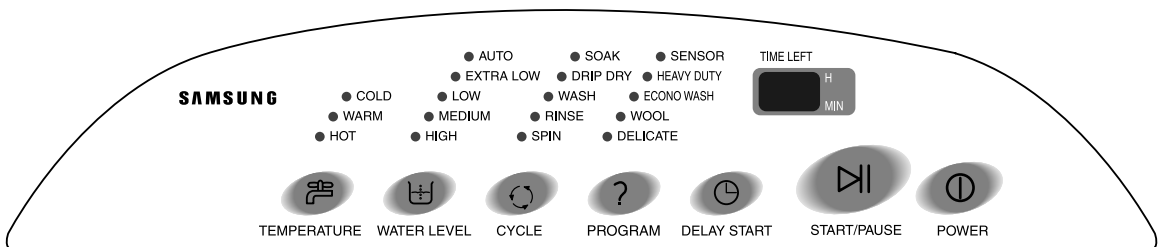
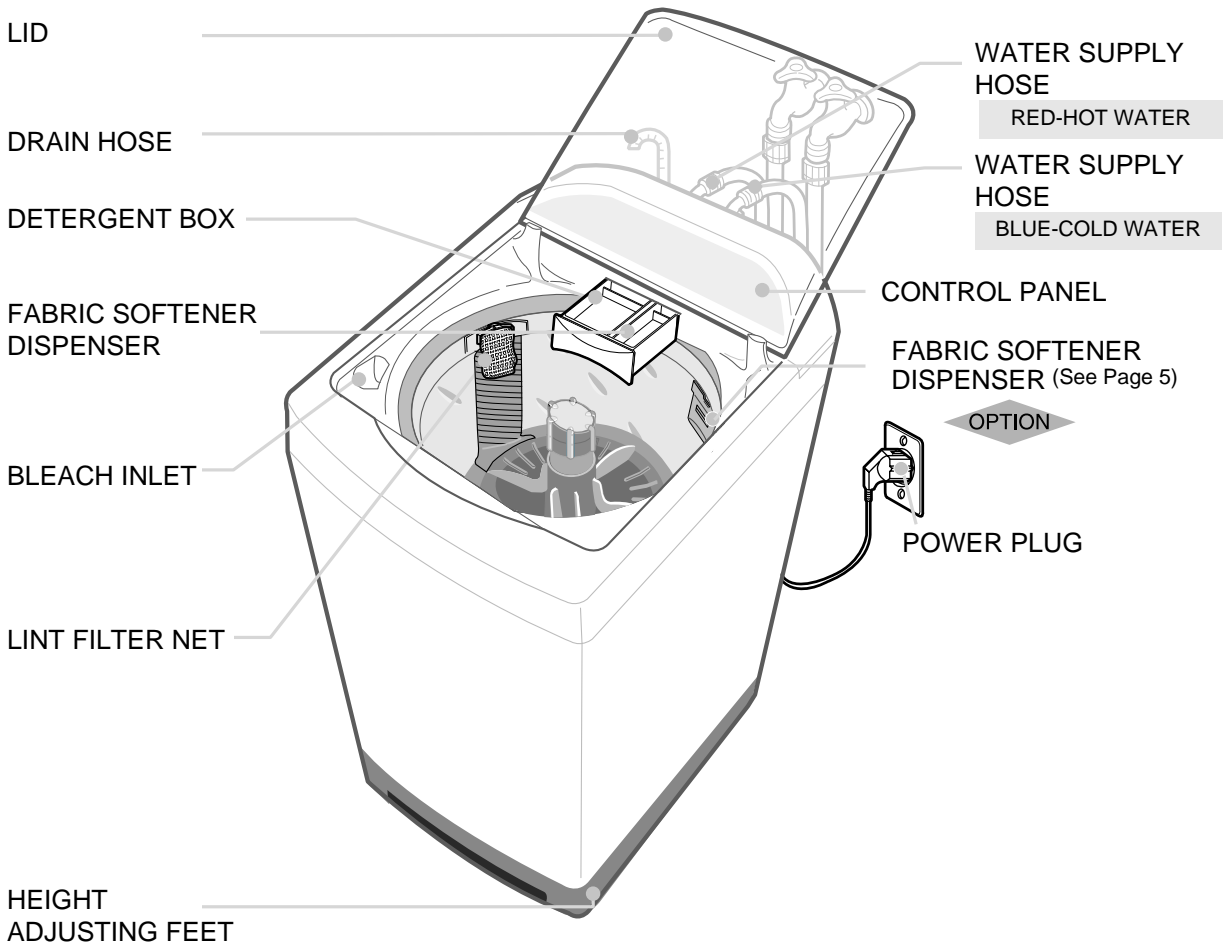

CONTROL PANEL

# SAFETY INSTRUCTIONS

## WARNING!

To reduce the risk of fire, electric shock, or injury to persons when using your appliance, take care to adhere to the following precautions.

- **Where an unearthed power cord is not fitted, be sure that the washer is grounded.**

To avoid electrical shock use metal piping for the ground connection.

Take care not to ground the washer to gas pipes or telephone cables due to the danger of explosion from lightning strikes.

- **During spinning, don't put your hand in the spin basket.**

Because the spin basket is rotating at the high speed, rotating parts may injure your hand.



- **Openings must not be obstructed by carpeting when the washing machine is installed on a carpeted floor.**
- **Turn off water taps when the washer is not in use to avoid water pressure damage to the pump.**
- **To minimize the possibility of electric shock, unplug this appliance from the power supply or disconnect the washer at the household distribution panel by removing the fuse or switching off the circuit breaker before attempting any maintenance or cleaning.**
- **The appliance is not intended for use by young children or infirm persons without supervision.**
- **Young children should be supervised to ensure that they do not play with the appliance.**
- **If the power supply cord is damaged, it must be replaced by the manufacturer or its service agent or a similiary qualified person in order to avoid a hazard.**

- **Place clothes evenly into the washer as unevenly distributed laundry may cause excessive out-of-balance noise and vibration.**

- **Maximum hot water supply temperature 60 degrees.**

- **Before washing, check all pockets.**  
If nails or pins remain in pockets, they may damage the washer or clothes.

- **Don't press the control panel with a sharp object.**  
Panel damaged or malfunction may occur.

*If the control panel for this washer is damaged, it must be replaced by a repair shop appointed by the manufacturer, as special purpose tools are required.*

- **Do not operate this appliance if it is damaged, malfunctioning, partially disassembled, or has missing or broken parts, including a damaged cord or plug.**
- **Do not store or use gasoline or other flammable vapors and liquids in the vicinity of this or any other appliance.**
- **The instructions for use shall specify the maximum mass or dry cloth in kg, for which the appliance is designed.**
- **If the appliance is supplied from a cord extension set or electrical portable outlet device the cord extension set or electrical portable outlet device should be positioned so it is not subject to splashing or ingress of moisture.**

# INSTALLATION & MAINTENANCE

## ENVIRONMENT

### Leave some space.

Maintain at least 10cm between the washer and the wall.

### Place the washer on a sturdy flat surface.

If the washer is placed on an uneven or weak surface, noise and vibration can occur (allowable slope is 1 degree)

### Never install the washer in a very steamy environment or where it might be open to the rain.

Excessive moisture may cause an electrical shock hazard.

### Avoid direct sunlight or heaters.

As plastic and electrical components are affected by direct heat, never place the washer near furnaces, boilers, etc. Do not place under direct sunlight.

## In case of pump-drained washer

- Take out the cap-hose and connect the outlet-hose.
- Be sure to join tightly the drain hose into the drain-outlet on the left side of the machine.
- Install the drain hose in the position of about 70~80cm above the ground.

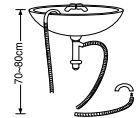
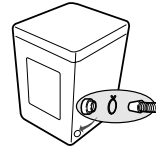
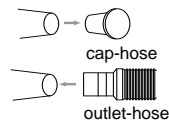

## HOW TO CONNECT WATER SUPPLY HOSE

Check the type of tap fitting which is in your laundry and then see appropriate instruction below:

### A tap of ordinary type is desirable



ORDINARY TAP



SQUARE TAP



ROTATING TAP

### In case of square tap

- Take out the internal part of the connector and join it in the following way.



Internal part

1. Remove the adaptor from the water supply hose.

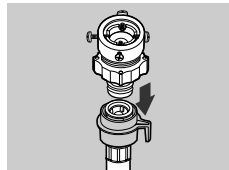

4. Connect the water supply hose to the adaptor. Pull down the part (c) of the water supply hose. When you release part (c) the hose is automatically connects to the adaptor making a 'click' sound.

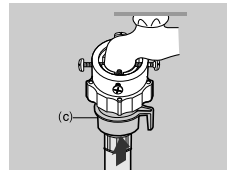

2. First, using a "+" type screw driver, loosen the four screws on the adaptor. Next, take the adaptor and turn part (b) following the arrow for gap about 5mm between them.

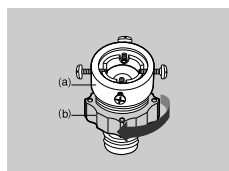

5. Connect the other end of the water supply hose to the inlet water valve at the top of the washer. Screw the hose clockwise all the way in.

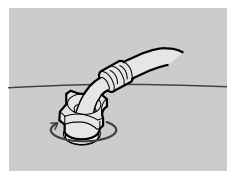

3. Connect adaptor to the water tap by tightening the screws firmly. Then, turn part (b) following the arrow and put (a) and (b) together.

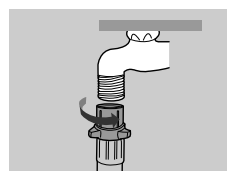
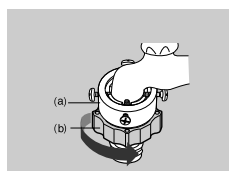

6. If the water tap is a screw type, assemble a water supply hose that fits to the tap as shown.

## CLEANING THE FILTER NET

If the filter net is clogged after washing, lift up the net. Remove the collected lint and rinse the filter net.



## HOW TO ADD THE DETERGENT

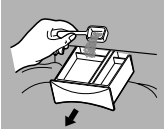

1. Open the detergent box by pulling in the direction of the arrow as shown in the figure.
2. Add the amount of detergent for one washing evenly in the box so that the detergent does not overflow the box.

## HOW TO ADD THE FABRIC SOFTENER

- When a proper amount of fabric softener is stored in the box, it is automatically added in at the final rinse cycle.
- \* In case the hot water only is connected, this function will not be operated.

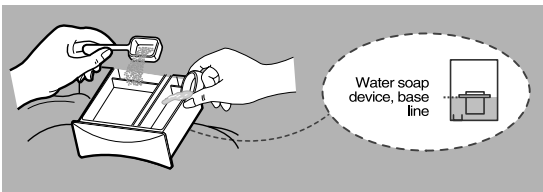

- \* When too much softener is stored above the base line, it may not be operated properly.

## OPTION

### Only For models with polypropylene(plastic) wash bowl

- When the manufacturer's recommended amount per load of fabric softener is stored in the softener inlet, it will be automatically dispensed during the final rinse cycle.
- \* Before operating the washing machine, make sure that any water remaining in softener dispenser from a previous load is removed.



## CLEANING THE FILTER (pump drained washer)

1. Place a rag under washer filter not to wet the floor.
2. Turn the filter-cap to the left.
3. Take out the filter and remove any sludge.
4. Reassemble in reverse order.

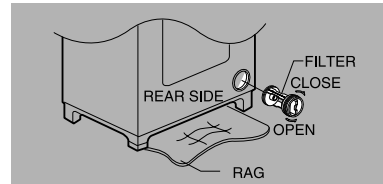

## LEVELLING

1. Pull down the adjusting handles of the adjusting feet which are located at the right and left of the front side.
2. Adjust the height of the machine upwards or downwards.
3. When the adjustment is finished, push back the handles to fix the adjusting feet.

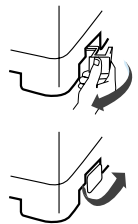

## NOTE

Do not kick or step on the adjusting handles.



### SEE IF THE MACHINE IS PLACED LEVEL BY CHECKING THE POSITION OF THE WASHING TUB.

- Open the lid of the machine, pour water into the tub up to the level just below the pulsator, and adjust the legs so that the pulsator is positioned at the center of the water as shown in the figure.
- Place the machine more than 10cm away from the wall.

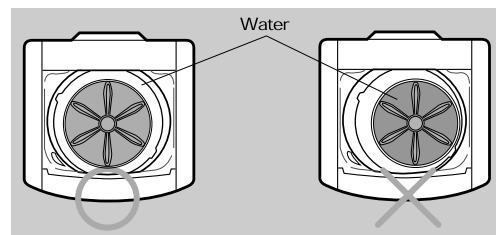

## WARNING! NOTE THE FOLLOWING PRECAUTIONS TO PREVENT ELECTRICITY LEAKAGE AND THE POSSIBILITY OF ELECTRIC SHOCK.

Earthing is necessary to prevent leakage or electric shocks caused by the electric currents leaked from the machine.

### How to earth an outlet with earthing terminals when an earthed power load is not fitted.

Outlet with earthing terminals:

- Even when the internal wires of the earthing terminals are joined, connect the earthing conductor (green) of the machine to the tap.

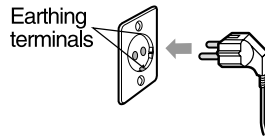

### When using an extension cord and a boosting transformer:

- Make sure that the earthing conductor is connected.

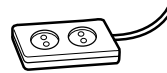

### Never make an earthing to

- The telephone line, lightning rod, or gas pipe as it is extremely dangerous in case of lightning strikes.

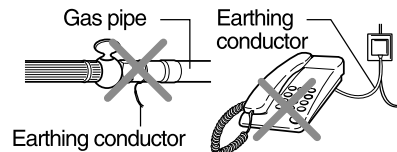

## TO DO A CLEAN WASHING

- Press the POWER button.
- Pour a little detergent into case-detergent.
- Turn on water supply to the washing machine.
- Choose the SOAK in CYCLE button and the HIGH in WATER LEVEL button.
- Press the START/PAUSE button.

# WASHING INSTRUCTION

## PROCEDURE

### 1. Sort the laundry into separate wash loads.

Each load of washing should contain clothing which needs the same washing conditions. For example, you should not wash delicate clothes with very dirty work clothes.

### 2. Load the laundry into washing.

Before load, check all pockets, and close zippers, hooks and eyes.

### 3. Add the detergent. (see page 5)

### 4. Add the fabric softener. (see page 5)

### 5. Close the lid.

### 6. Press power button.

### 7. Choose the wash program & optional cycle. (see page 7~8)

If you choose "SENSOR" program you don't need to select water level.

Water level is set automatically at "SENSOR" program.

Press the START/PAUSE button.

### 8. Select the water level.

Before choosing the water level, remember following things.

When you choose SENSOR, HEAVY-DUTY, ECONO-WASH, DELICATE program, water level is selected "AUTO" automatically, but if you want to choose water level manually you can select. HIGH, MEDIUM, LOW, EXTRA LOW

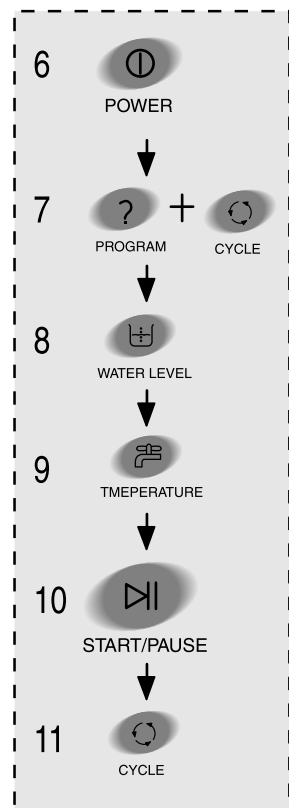

## 9. Select the water temperature.

Before choosing the water temperature remember the following:

1) You can choose HOT, WARM, COLD on all programs except for delicate program.

HOT is hot wash and cold rinse.

WARM is warm wash and cold rinse.

COLD is cold wash and cold rinse.

2) When you choose delicate program, water temperature is selected automatically for warm wash and warm rinse.

## 10. Close the lid and press the START/PAUSE button.

## 11. Do you want extra rinse?

For extra rinses press the cycle key 1 to 5 times (depending on the number of extra rinses required).

You can select up to 5 extra rinses or return to a single rinse by pressing the cycle key.

The time left display will show the number of rinses selected.

Note that the extra rinse program is not available when pause is selected or during the spin cycle.

## WASH PROGRAM

	SENSOR	HEAVY DUTY	ECONO WASH	WOOL	DELICATE
<b>Wash Time</b>	18 min	20 min	5 min	6 min	6 min
<b>Wash Action</b>	Normal	Normal	Normal	Gentle	Gentle
<b>Wash Temp.</b>	HOT WARM COLD	HOT WARM COLD	HOT WARM COLD	WARM COLD	WARM COLD
<b>Deep Rinse</b>	COLD	COLD	COLD	WARM COLD	WARM COLD
<b>Spin Time</b>	6 min	6 min	3 min	1 min	1 min
<b>Total Time (High Water level)</b>	56 min	59 min	40 min	36 min	37 min

# WASHING PROGRAM

### SENSOR Program

- The best washing program is chosen automatically
- Load size and water level is determined automatically
- \* **Unplug the power cord after washing.**

### HEAVY DUTY Program

- This program is suitable for heavily soiled laundry
- Load size and water level are determined automatically or you can choose the water level you want
- \* **Unplug the power cord after washing.**

### ECONO Wash Program

- Saving your time and energy
- This program is suitable for lightly soiled laundry
- Load size and water level are determined automatically or you can choose the water level you want
- \* **Unplug the power cord after washing.**

### WOOL Program

- This program is suitable for woollen clothes
- Only high and medium water levels are available
- \* **Unplug the power cord after washing.**

### DELICATE Program

- Washing action is very gentle, so this program is suitable for delicate clothes like lingerie.
- Load size and water level are determined automatically or you can choose the water level you want
- \* **Unplug the power cord after washing.**

# OPTIONAL CYCLE

## WASH ONLY

- When you choose this cycle, only wash cycle is operated.
- Pressing optional cycle key during washing changes the wash time in two minute intervals.
- The wash time can be changed to between 3 and 25 minutes.
- Load size and water level is determined automatically.  
\* **Unplug the power cord after washing.**

## RINSE ONLY

- When you choose this function, only rinse cycle is operated.
- Pressing function key during rinsing changes the number of rinses. Up to 5 rinses can be optionally selected.  
\* **Unplug the power cord after washing.**

## SOAK

- The laundry is soaked in water so that heavy dirt can be eliminated sufficiently.
- You can choose soak cycle after choosing wash program.
- When you select soak function, 5 minute cycle (1 min. washing then 4 min. pause) continue for 30 minutes before main wash program.
- Load size and water level is determined automatically.  
\* **Unplug the power cord after washing.**

## DRIP DRY

- This function allows you to take drip clothes out of the washing machine while they are still wet before the final spin.
- You can choose drip dry cycle after choosing main wash program.
- When you select drip dry the cycle is finished before final spin.  
\* **Unplug the power cord after washing.**

## SPIN ONLY

- When you choose this cycle, only spin cycle is operated.
- Pressing cycle key during spinning only cycle changes the spin dry time.  
The spin dry time can be changed to between 1 and 7 minutes.  
\* **Unplug the power cord after washing.**

## RINSE AND SPIN ONLY

- When you choose this cycle, only rinse & spin cycle are operated without wash cycle.
- Pressing cycle key during operation changes the number of rinse (see above).  
You cannot change the spin dry time using this function.  
\* **Unplug the power cord after washing.**

## DELAY START

- This function allows you to delay the start of your chosen wash program for 3, 4, ... 18 hours.
- By pressing the delay start key you can select delayed period for 3, 4, ... 17, 18 hours, and your washing machine will finish the selected wash program after the delayed period.

# TROUBLESHOOTING

## Washing machine won't work

- Is the water tap opened?
- Is the washer plugged in?
- Is the power cut off?
- Is the fuse all right?
- Is there enough water?



## Spinning does not work

- Is the laundry spread out evenly in the washer?
- Is the washer set on a sturdy flat surface?
- Is the lid closed?

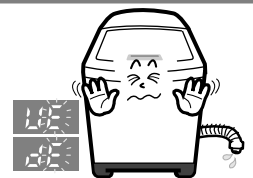

## Water does not drain

- Is the drain hose down? (No pump)
- Is the drain hose frozen?
- Is the drain hose clogged?
- If the water does not drain in 15 minutes, a buzzer will sound, and the remaining time indicator will show "E"**



## Water is not supplied

- Is the water tap opened?
- Is the water cut off?
- Is the water supply hose or hose connection clogged?
- Is the water tap frozen?
- If water is not supplied in 60 minutes, a buzzer will sound, and the remaining time indicator will shown "7E".**



## While lid is opening, the washing machine won't work

- Make sure to close the lid while washing machine is operating.

## Water supply does not stop

- Close the water tap.
- Disconnect the power supply cord.
- Call Samsung or service centre.

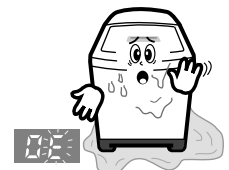



**IF YOU NEED HELP WITH YOUR NEW  
SAMSUNG WASHING MACHINE**

Contact your nearest Samsung office or Samsung authorised service centre for technical assistance.

## SPECIFICATION

	SW65ASP2	SW55APP2
<b>Bowl</b>	Stainless Steel	PP
<b>Power input(Watts)</b>	450	
<b>Load capacity(kg)</b>	6.5	5.5
<b>Size (WxDxH)(mm)</b>	600X660X1010	
<b>Net Weight (kg)</b>	48	
<b>Water Consumption(liters)</b>	150(high)	
<b>Water Pressure(min-max)</b>	50~780KPa	

CODE NO : DC68-00967A

# SAMSUNG

## Owner's Instructions

SW65ASP2/SW55APP2

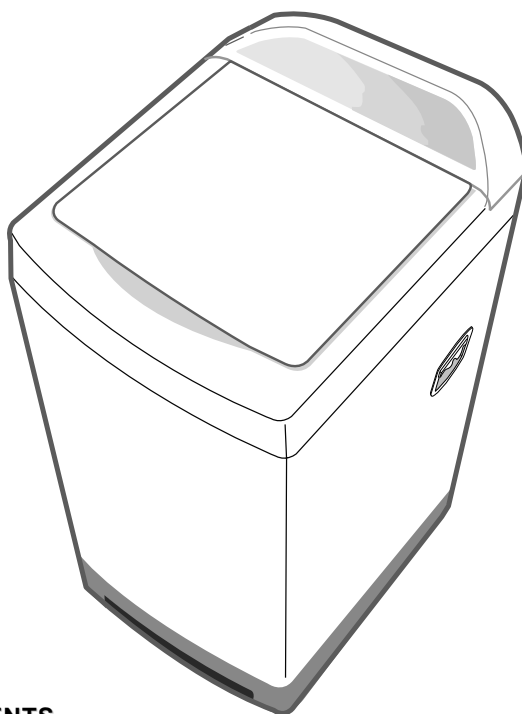

	<b>Page</b>
<b>CONTENTS</b>	
<b>FEATURES</b> .....	1
<b>DESCRIPTION OF PARTS</b> .....	2
<b>SAFETY INSTRUCTIONS</b> .....	3
<b>INSTALLATION &amp; MAINTENANCE</b> .....	4
Environment .....	4
Connecting the drain hose .....	4
In case of pump-drained washer .....	4
How to connect water supply hose .....	4
Cleaning the filter net .....	5
How to add the detergent .....	5
How to add the fabric softener .....	5
Cleaning the sump filter.....	5
Levelling .....	5
Precautions.....	6
<b>WASHING INSTRUCTIONS</b> .....	6
Procedure .....	6
Wash programs .....	7
<b>WASHING PROGRAM DETAILS</b> .....	7
<b>OPTIONAL CYCLES</b> .....	8
<b>TROUBLESHOOTING</b> .....	8
<b>SPECIFICATIONS</b>	

## Free Manuals Download Website

<http://myh66.com>

<http://usermanuals.us>

<http://www.somanuals.com>

<http://www.4manuals.cc>

<http://www.manual-lib.com>

<http://www.404manual.com>

<http://www.luxmanual.com>

<http://aubethermostatmanual.com>

Golf course search by state

<http://golfingnear.com>

Email search by domain

<http://emailbydomain.com>

Auto manuals search

<http://auto.somanuals.com>

TV manuals search

<http://tv.somanuals.com>