

# SANGEAN

## ATS-818ACS



# CONTENTS

---

Features .....	2
Control Locations .....	3
Choosing a Power Supply .....	5
Preliminary Settings .....	7
Tuning Modes .....	12
Clock Radio Operation .....	21
Special Tuning Techniques and Controls .....	23
Using Your Cassette Recorder .....	26
Special SSB/CW Reception Techniques .....	29
Care and Maintenance .....	34
Specifications .....	36

# FEATURES

---

**Continuous Tuning** allows continuous reception of all stations and bands.

**Fast response, Three Color LCD** indicates station frequency in large easy-to-read numbers, including dual time, memory location, signal strength and battery life.

**Direct Access Keypad** permits instant tuning of any desired frequency from 87.5 to 108MHz on the FM band and from 150 to 29,999 KHz on the AM band.

**Fifty-Four Memory Pre-sets** offer instant access to your favorite stations on LW, MW, FM and SW.

**AC/DC Power Supplies** for use virtually anywhere in the world.

**Special Tuning Controls** further improve radio reception.

**Dual Time Setting** allows you to pre-set your local time and UTC World Time, or any two time zones with instant recall.

**Scanning Circuit** permits you to check various frequencies on a certain bandwidth and lock on to it at random.

**Cancel Button** allows you to instantly change incorrect information keyed into the microprocessor.

**Band Select Buttons** offer instant selection of any desired frequency bandwidth on SW.

**Tuning Speed Select Switch** permits you to tune stations at either a fast or slow speed.

**Adjustable Sleep Timer** allows you to fall asleep to music or other programming

**Standby Mode** turns on the radio automatically at a pre-set time either by buzzer or radio program.

**Stereo Headphone Jack** permits reception of FM multiplex stereo broadcasts.

**Folding Stand** allows you to position the radio either vertically or at an angle while maintaining stability.

**BFO Control** (beat Frequency Oscillator) allows reception of SSB (Single Side Band) and CW (Continuous Wave Morse Code) transmissions.

**Standby Recording** function provides recording at pre-programmed time.

**Sensitive Built-in Microphone** provides recording anywhere without an extra microphone.

**Fully Auto Stop** on tape playing, fast-forwarding and rewinding.

# CONTROL LOCATIONS

1. Display Light Button
2. Radio Power on/off Button.
3. Sleep Timer.
4. Time Set.
5. Dual Time Set
6. Manual Tuning/Auto Scan Button
7. Band Selector.
8. Frequency Select Button.
9. Standby Button.
10. BFO on/off Selector
11. FM Stereo/Mono Mode Selector.
12. AM Wide/Narrow Mode Selector.
13. Alarm By Radio/Buzzer Selector.
14. BFO Pitch
15. RF Gain Control
16. Tone Control
17. Cancel Button
18. Enter Command Button
19. Memory Entry Button
20. Numeric & Bandwidth Button
21. Meter Select Button
22. LCD Display
23. Tape Recording LED Indicator
24. Tape Playing LED Indicator
25. Cassette Tape Compartment
26. Tape Recording Button
27. Tape Playing Button
28. Tape Rewinding Button
29. Tape Fast Forward Button
30. Stop/Eject Button.
31. Pause Button
32. Telescopic Antenna
33. Carrying Handle
34. Rotary Tuning Knob.
35. Tuning Speed Control
36. Lock Switch
37. Volume Control
38. CrO<sub>2</sub>/Normal/Tape Select Switch
39. Timer Recording on/off Switch
40. Beat Cut Switch
41. AM External Antenna jack
42. Stereo Headphone Jack.
43. DC Input Jack/6 volts
44. Folding Stand
45. Battery Compartment.

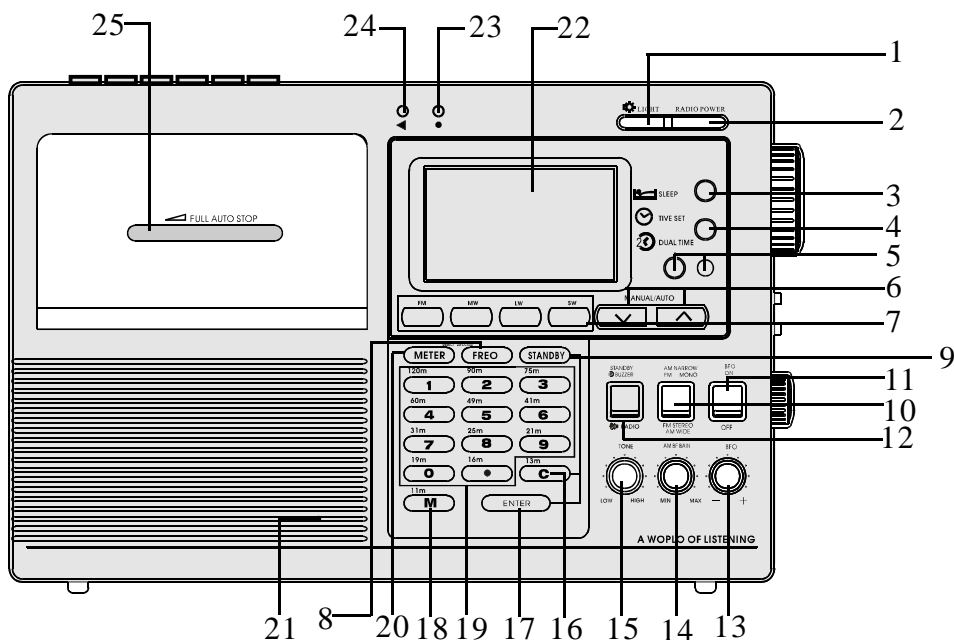

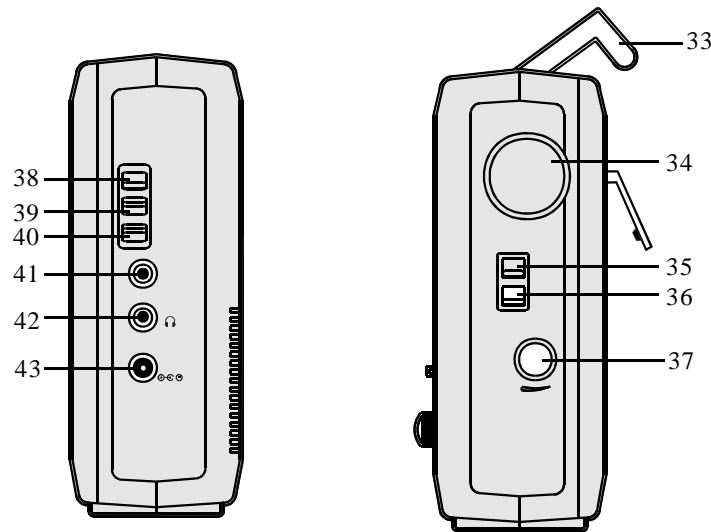
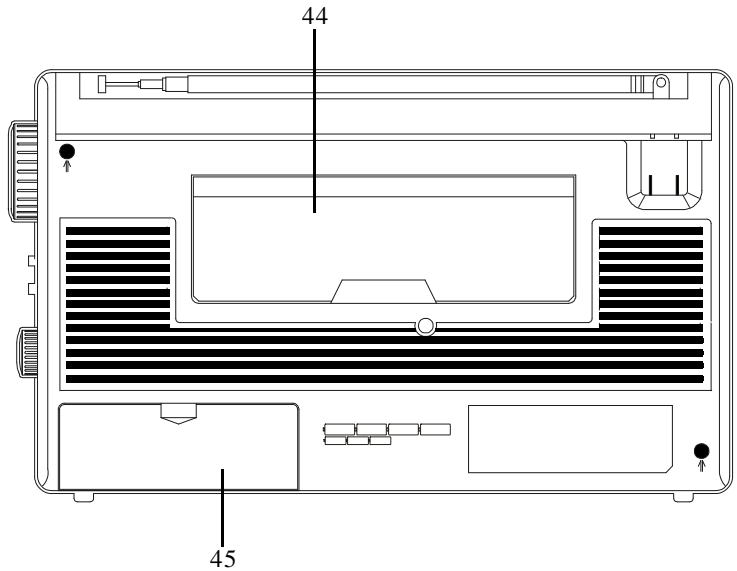
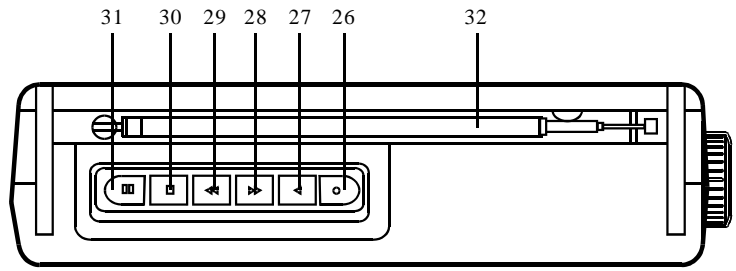

# CHOOSING A POWER SUPPLY

You can operate the receiver using:

- 4 Alkaline "D" size Batteries
- Household AC [With optional AC Adaptor]
- 12 Volt DC Automobile Battery [With optional DC adaptor]

## USING BATTERIES

1. Press latch marked "OPEN" on battery compartment cover in the direction of the arrow and lift off cover.

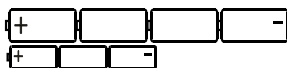
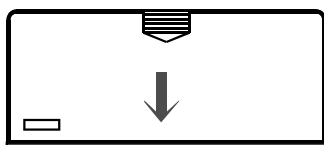

2. Insert 3 "AA" batteries in the "Back-up" compartment and 4 "D" size batteries in the "Radio" compartment. Be sure to position them as illustrated on the back of the radio, and on top of the "lift-out" ribbons for easy removal.
3. Replace the battery compartment cover and press down until you hear it snap closed.

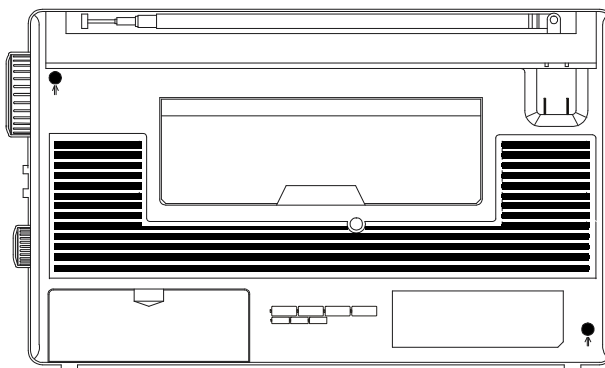

## NOTE

Whenever the radio is turned off, the battery indicator will flash for about five seconds to show battery condition.

If the indicator falls below #2, the 4MAIN "D" size batteries should be replaced.

When the "MAIN" batteries become exhausted, the micro-processor will automatically be powered by the "BACK-UP" batteries.

When the display on the micro-processor begins to fade, replace the 3 "AA" batteries in the "BACK-UP" circuit. During battery replacement make sure the Lock Switch (26) is in the locked position (☉). This will prevent any memory presets from being lost during the battery replacement. Battery replacement should be completed within 2 minutes.

---

## USING HOUSE CURRENT [AC]

The receiver may be powered by AC current using the AC adaptor (not included). Insert the small barrel shaped plug into the jack on the side of the radio marked "DC IN 6V" . Plug the other end of the adaptor into a standard household outlet. Whenever AC is used, the batteries are automatically disconnected.

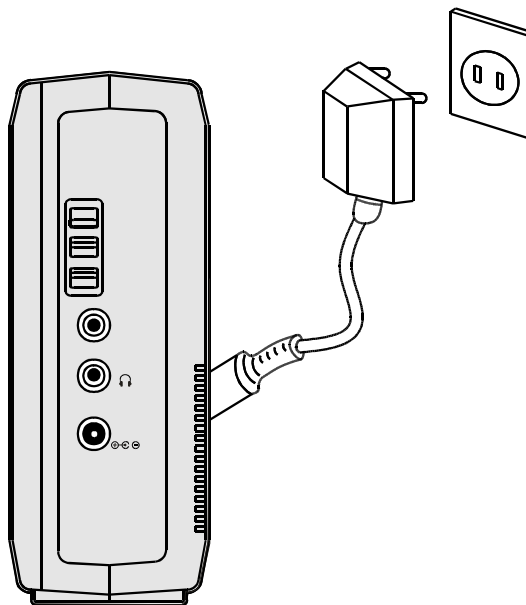

# PRELIMINARY SETTINGS

## SETTING THE CLOCK

The time is displayed in the 24 hour mode since most shortwave stations operate according to UTC. This is the standard that is used throughout the world.

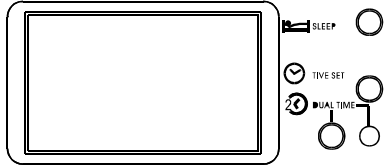
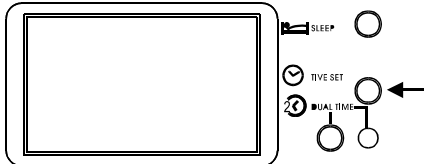
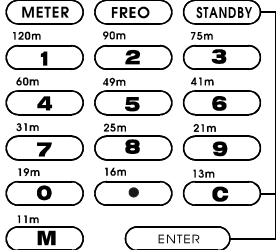
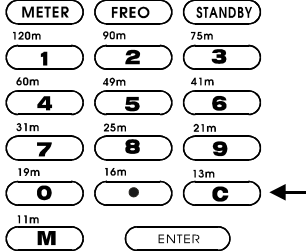
<p>The clock will start when 3 AA size batteries are installed. The display shows 0:00</p>	
<p>1. Press "TIME SET" . "0:00" . disappears &amp; for 12 seconds TIME SET flashes.</p>	
<p>2. While FLASHING set the correct time by pressing the numbered buttons. As you press the corresponding button the number shows up on the LCD display.</p>	
<p>3. If you press the wrong number, press the "C" [CANCEL] button which deletes one number at a time. Repeat step #2 again.</p> <p><b>NOTE</b> Time can only be adjusted when TIME SET is in flashing mode.</p>	



4. Now press button marked "ENTER".  
Display shows hours and minutes.

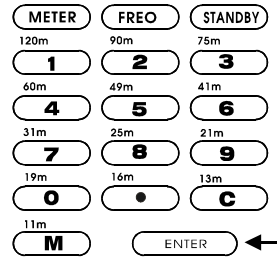

## SETTING DUALTIME

A second time zone can be programmed into this unit such as your home time if you are travelling, or UTC World Time for instant access to short-wave broadcasts or the local time where ever you may be.

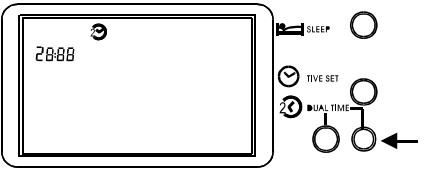
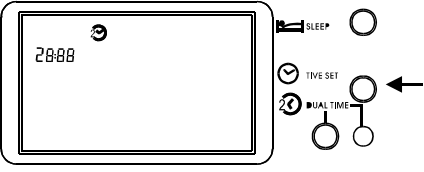
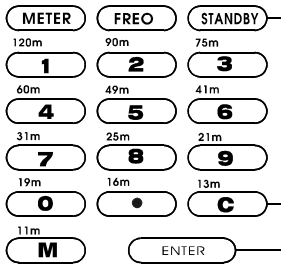
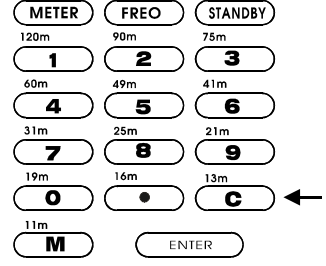
<p>1. Press right side "DUAL TIME" button then the display will show the secondary TIME and 20 appears.</p>	
<p>2. Press "TIME SET" button. Clock time will disappear &amp; "TIME SET" will flash for 12 seconds.</p>	
<p>3. While "FLASHING" set the correct time by pressing the numbered buttons. As you press the corresponding button the number shows up on the LCD display.</p>	
<p>4. If you press the wrong number, press the "C" [CANCEL] button which deletes one number at a time. Repeat step # 3 again.</p>	

5. Now press button marked "ENTER",  
Display shows hours and minutes.

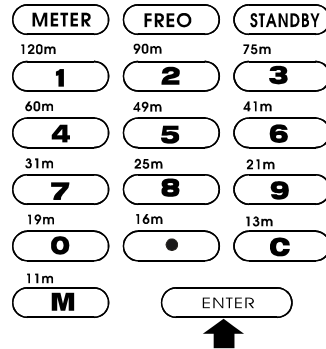

6. By pressing the right side "DUAL TIME" button now, the LCD display will once again show the clock time.

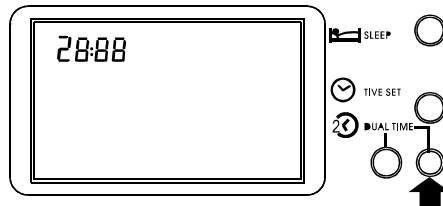

7. To verify "DUAL TIME", press the left side 'DUAL TIME' button to display your "OTHER" time zone. When you release the button the clock will show your current local time.

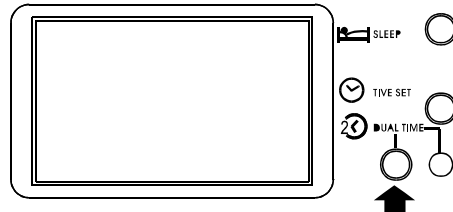

## BAND SELECTION

There are four band selector buttons located just beneath the LCD display.

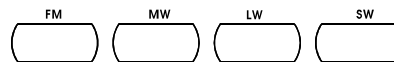

BAND	FRIQUENCY RANGE	FROGRAM TYPE
FM	87.5~108 MHz	Standard FM
LW	150~519 kHz	Longwave
MW	520~1710 kHz	StandardAM
SW	1.711~29.999 MHz	SW/13 Sub-Bands

1. Turn radio on by pressing "POWER{ button. Display will show last band and frequency selected.

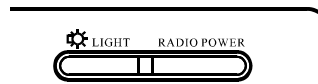

2. By pressing any one of the four band selector buttons the display shows the band selected and a random frequency within that band.

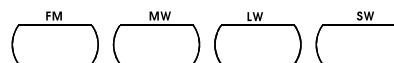

### NOTE

When you select SW you only have to press the button marked "METET", and then any one of the numbered buttons depending upon what band you want to listen to. The display will show the band you selected and a random frequency within that band.

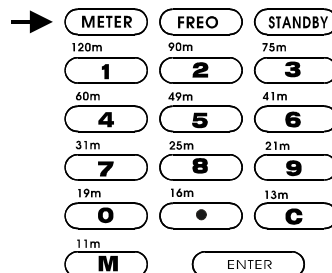

# TUNING MODE

## ADJUSTING THE ANTENNA

Locate the band you want to listen to in the following chart and adjust the antenna as indicated

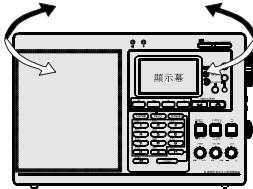
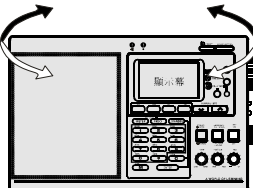
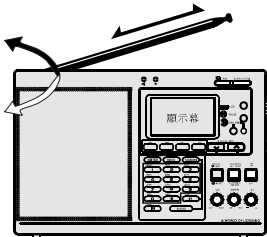
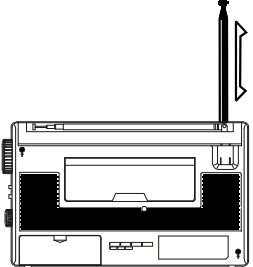
BAND	FREQUENCY RANGE	ANTENNA TYPES	ILLUSTRATION
MW	520-1710 kHz	INTERNAL Rotate radio for best reception	
LW	150- 519 kHz	INTERNAL Rotate radio for best reception	
FM	87.5- 108 MHz	TELESCOPIC Extend antenna all the way & rotate it for best reception	
SW	1.711-29.999 MHz	TELESCOPIC Extend antenna all the way for best reception & <b>do not rotate</b>	

You may select any frequency using four different tuning methods:

- Direct Tuning
- Manual Tuning
- Scan Tuning
- Memory Tuning

## DIRECT TUNING

You may "KEY IN" a specific band (120m, 49m, 16m) by pressing the appropriate button. The exact station is then selected by pressing the buttons corresponding to the station frequency.

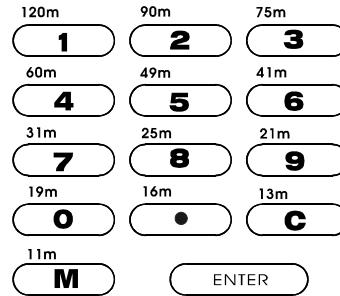

**Example :** To tune 100.70 MHz on the FM band, follow this procedure:

1. Press the POWER button to turn on the radio.

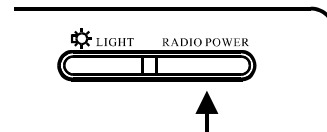

2. Press the button marked, FREQ ("Frequency")



3. Press the corresponding buttons, marked [1], [0], [0], [.] , [7], [0]. That exact frequency will now show up in the display.

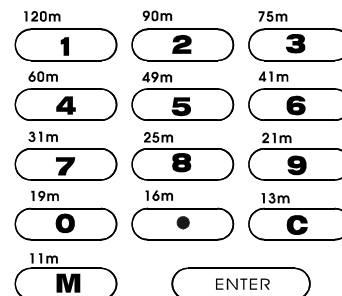

4. Press the button marked "ENTER" within twelve seconds. The frequency and band will now show up in the display. The SIGNAL STRENGTH will also show.

**NOTE:** Be sure to press the decimal point [.] in 100.70 MHz, otherwise the display will show "SW", [10.070 MHz] automatically.

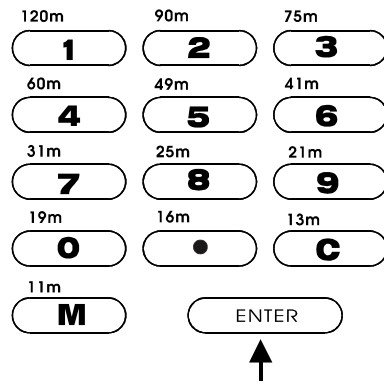

5. Extend the antenna all the way and rotate for best FM reception.

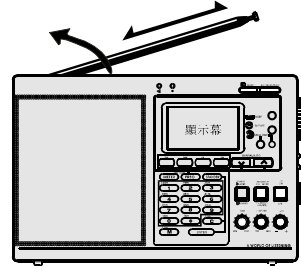

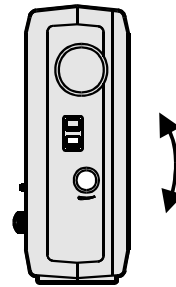

6. Adjust the VOLUME and TONE controls for the desired sound.

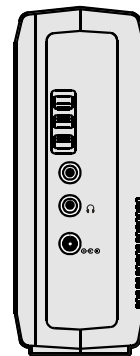

7. When selecting a stereo FM station, make sure the FM mode switch is in the STEREO position.

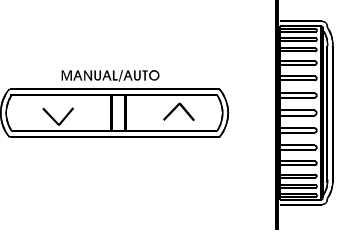

# MANUAL TUNING

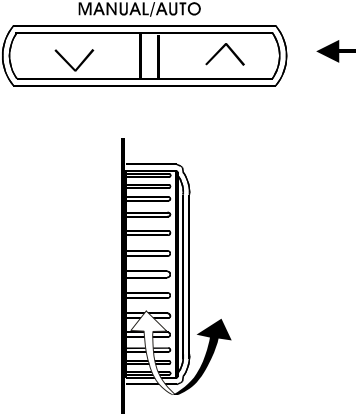
<p>To select a station you do not know the frequency of, use the MANUAL TUNING [V] button or the ROTARY TUNING control on the side of the radio.</p>	 <p>The diagram shows a rectangular button with a downward-pointing chevron on the left, a vertical bar in the center, and an upward-pointing chevron on the right. Above the button is the text 'MANUAL/AUTO'. To the right of the button is a vertical rotary knob with horizontal ridges.</p>
<p>1. Press the POWER button to turn on radio.</p>	 <p>The diagram shows a horizontal button with a gear icon on the left, the text 'LIGHT' in the middle, and 'RADIO POWER' on the right. A line extends from the right side of the button, curving upwards.</p>
<p>2. Select a band.</p>	 <p>The diagram shows four rounded rectangular buttons labeled 'FM', 'MW', 'LW', and 'SW' from left to right.</p>
<p>3. Press repeatedly the [Δ] or [V] buttons to reach a desired frequency. Press and hold the [Δ] or [V] buttons for at least a half second or more to change frequencies rapidly.</p> <p>OR Rotate the TUNING knob until the desired frequency or station is tuned in using the SIGNAL STRENGTH INDICATOR in the display for the best reception.</p>	 <p>The diagram shows the 'MANUAL/AUTO' button with a downward-pointing chevron on the left, a vertical bar in the center, and an upward-pointing chevron on the right. A black arrow points to the right towards the button. Below the button is the rotary tuning knob with a curved arrow indicating it should be rotated.</p>



## NOTE

When you repeatedly press the [Δ] or [V] buttons, the frequencies change in increments of :

FM: 50 kHz (or 100 kHz)

LW: 9 kHz

MW: 9 kHz or 10 kHz

SW: 5 kHz

Turning the ROTARY TUNING Knob with the TUNING SPEED CONTROL set on FAST will change each band as follows:

FM: 100 kHz

LW: 9 kHz

MW: 9 kHz/10 kHz

SW: 5 kHz

When set on SLOW, the frequencies change as follows:

FM: 50 kHz

LW: 1 kHz

MW: 1 kHz

SW: 1 kHz

With the TUNING SPEED CONTROL set on LOCK, ROTARY TUNING will not function.

4. Adjust the VOLUME and TONE controls as you like.

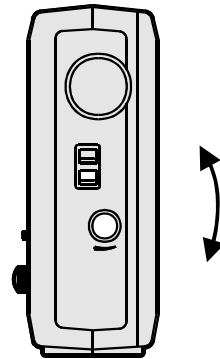

## SCAN TUNING

Use scan tuning to quickly locate a station or to monitor several stations within a specific band.

1. Turn on radio by pressing POWER button.

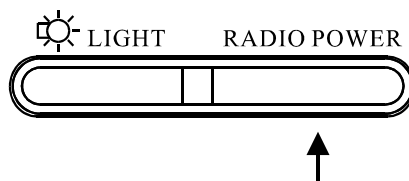

2. Select a band.

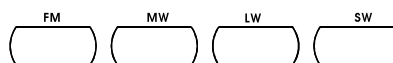

3. Adjust antenna or radio position depending on selected band.

AM

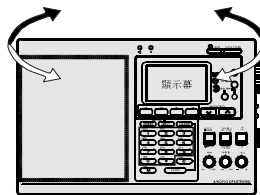

FM

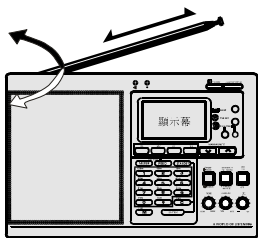

SW

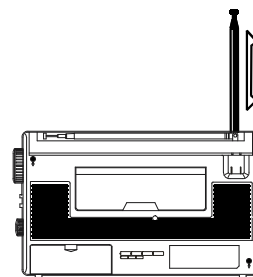

4. Press and hold the [∧] or [∨] buttons for at least a half second or more and the radio will scan all the frequencies in that band, and will stop automatically each time it lands on an active station. Signal strength is recorded on the SIGNAL STRENGTH INDICATOR.

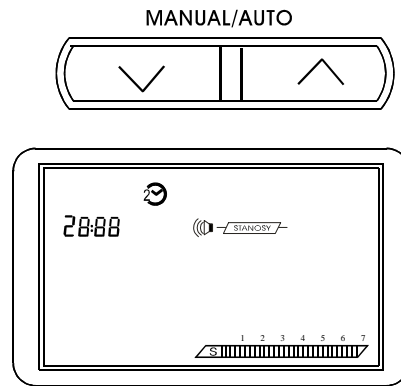

5. Press and hold the [∧] or [∨] buttons again to resume scanning. When you reach the upper or lower limits of the band, the scanning starts all over again as long as the button is depressed once more.

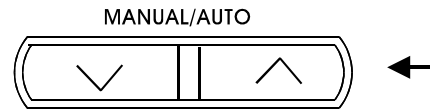

6. Adjust the VOLUME and TONE controls as you like.

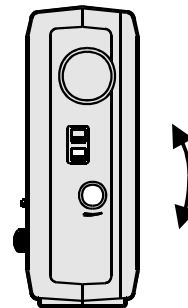

# MEMORY TUNING

You may store up to eighteen different frequencies on the SW/FM bands and up to nine different frequencies on each of LW/MW bands for instant selection of your favorite stations.

## Storing a Frequency

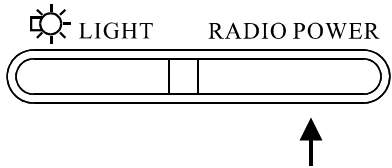
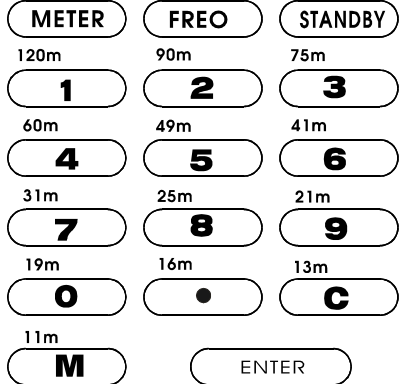
<p>1. Press POWER button to turn on radio .</p>	
<p>2. Turn to any frequency using any of the previously mentioned tuning methods.</p>	
<p>3. Press the button marked "M" for MEMORY it will start flashing in the display for 15 seconds during which time press any of the buttons marked 1-9 on the keyboard and your station will be stored in that memory position. For the SW/FM bands frequencies press 1-9 and then 01-09 for each 18 memory positions on FM and SWbands. The display will show the memory position the station is now stored in. <b>You may store your stations in any sequence you want. You do not have to start with #1</b></p>	

## RECALLING A FREQUENCY

1. Press POWER button to turn on radio.

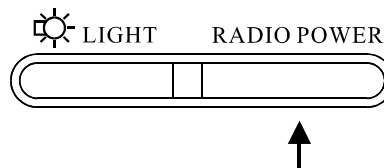

2. Select a band in which a station is stored that you want to recall.

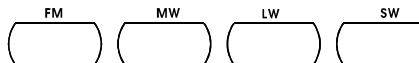

3. Press any of the NUMBERED buttons for a desired station and the radio will instantly tune to it and display that frequency and the MEMORY position number. **If you want to change to another stored station, just press any other numbered button for access.**

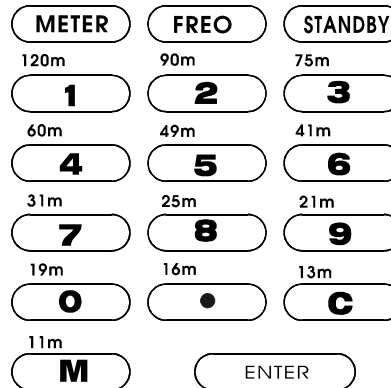

# CLOCK RADIO OPERATION

With this receiver you can fall asleep to your favorite station by pressing the SLEEP button, or wake you to the morning, news, or an alarm buzzer. **Make the following settings with the POWER off!!**

## Setting the Alarm

1. Press STANDBY button so display shows 0:00. STANDBY will flash for 15 seconds.

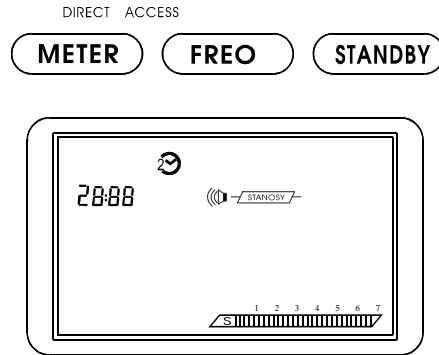

2. Press the numbered buttons to activate turn-on time using 24 hour time, in hours and minutes. For example, to set the radio to turn on at 1:30 PM each day, press the buttons until the display shows 13:30. **If the wrong number was keyed-in, delete it by pressing the CANCEL button marked "C". One time for each number. Then press the correct number for the time you want.**

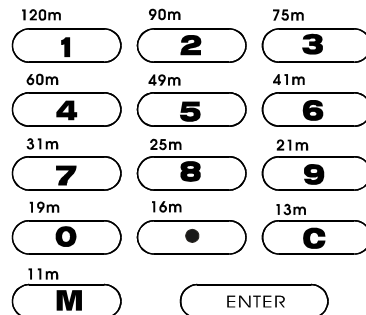

3. When you reach your desired turn-on time, press ENTER, STANDBY stops flashing, your turn-on time is locked in. For 2 to 3 seconds, the clock returns to the current time automatically.

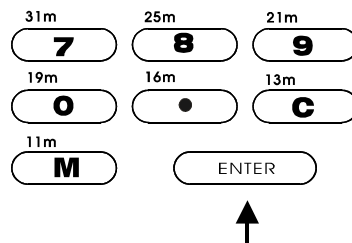

4. To verify, press **STANDBY** button again. Press **STANDBY** once more and the clock returns to the current time.



5. You may select radio or buzzer alarm to wake you by setting **STANDBY:BUZZER/RADIO** selector switch.

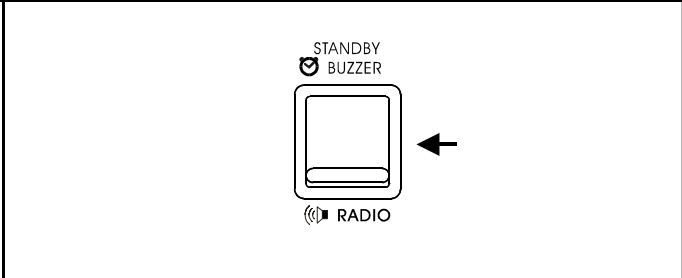

6. To cancel the **ALARM** time, press **STANDBY** and "**C**" [**CANCEL**] button.

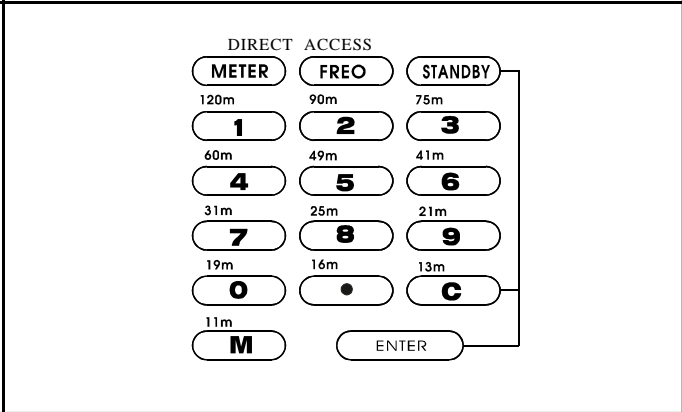

## Setting the Sleep Timer

1. The sleep timer allows the user to set the auto-shut off in 30 or 15 minutes decrements from 90 minutes to 15 minutes.

To set auto-shut off, press **SLEEP** button 3, LCD will show  frequency read-out, 60(auto shut off Time) and the icon.

Press **SLEEP** button to change the required auto-shut off time, release the button when shut off time desired is reached.

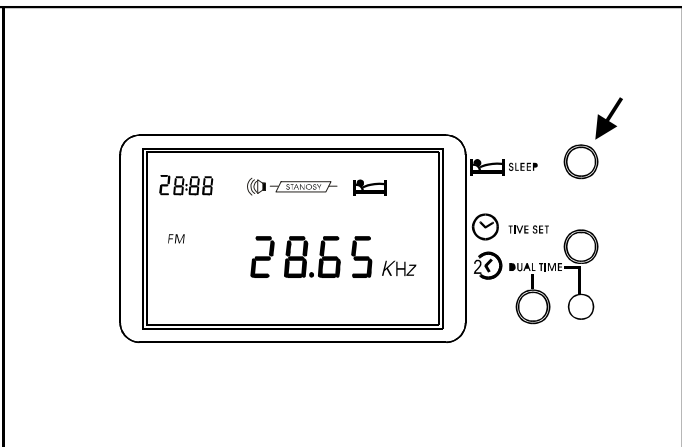

2. To turn off the radio before it automatically turns itself off, press the **POWER** button.

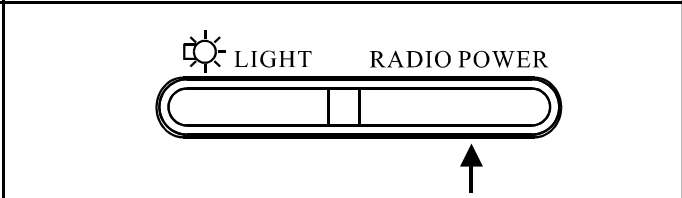

# SPECIAL TUNING TECHNIQUES AND CONTROLS

In addition to the standard tuning operations described previously, use the following controls for special operations.

## RF GAIN CONTROL

This control adjusts the receiver's Sensitivity. For LW, MW SW reception rotate the control to the MAX position, this provides the maximum sensitivity. when you listen to the MW, standard aM band, or LW band through external antenna, rotate the control only as far as needed to obtain a good signal. If you turn the knob further you might hear a distorted signal. For weak stations, rotate the control to the MAX position.

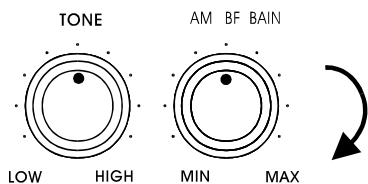

If you encounter interference, adjust the control in both directions until you obtain the best compromise between your station and the interference.

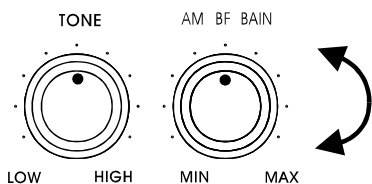

## AM NARROW/WIDE SELECTIVITY SWITCH

Some stations transmit their signal so that very little space exists between their airspace and the station next to them on the band. If, while tuning, you encounter interference, caused by the signal from an adjacent station, press the button for the band you are listening to and select the NARROW position. The interference is reduced or muted.

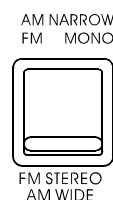

For full reception, leave the switch in the WIDE position.

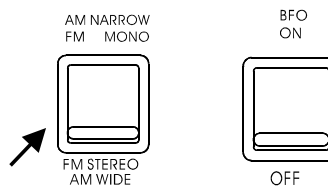

If you plan to listen to Morse code, referred to as CW (continuous wave), set the BFO switch to ON position. If you encounter too much noise as you tune, set the AM NARROW/WIDE switch to NARROW position.

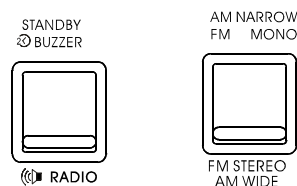



---

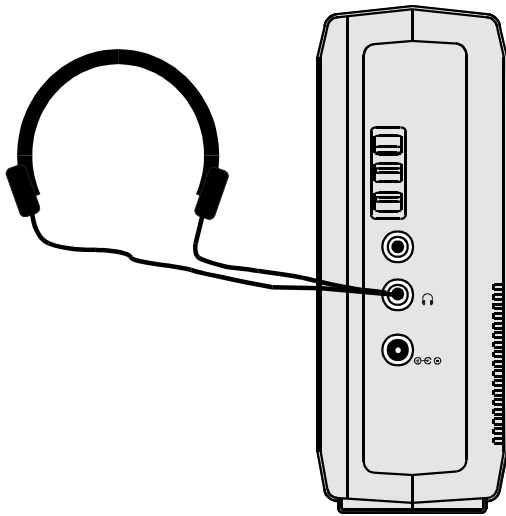

## HEADPHONE USE

While not a control, you may consider using HEADPHONES to obtain the best audio clarity when listening to SW. Since many SW stations broadcast only marginal signals, using HEADPHONES will enable you to distinguish between the signal and the noise usually encountered at night. Be sure that the HEADPHONES terminate in a 1/8 inch plug, which is inserted into the HEADPHONE jack located on the left side of the radio, marked with symbol . When the HEADPHONES are plugged in, the speaker is muted.



Because the radio is capable of receiving FM multiplex stereo, Stereo HEADPHONES Should be used. When listening to stereo FM, be sure that the FM: STEREO/MONO switch is set to the STEREO position.

## LOCK SWITCH USE

Using the LOCK Switch prevents unauthorized operation of the radio and will also prevent the station you are listening to from being changed. When the LOCK switch is moved to its up  position, the POWER button and TUNING controls are completely disabled. If the radio is on when the LOCK switch is moved to its up  position, you will not be able to turn it off. If the radio is off, with the LOCK Switch in its up  position, you will not be able to turn it on. This will also prevent it from being turned on by accident, when packed in a attache case. To release the LOCK Switch, simply move the switch down.

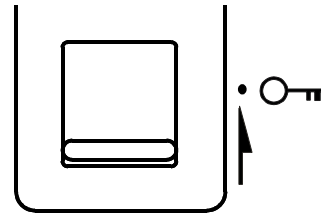

---

## EXTERNAL ANTENNA USE

To obtain optimum performance from this unit, especially when listening to SW/SSB/CW an external antenna should be used, if at all possible. The antenna is connected to the EXTERNALANTENNAADAPTER and then plugged into the EXTERNALANTENNA jack located on the left side of the radio.

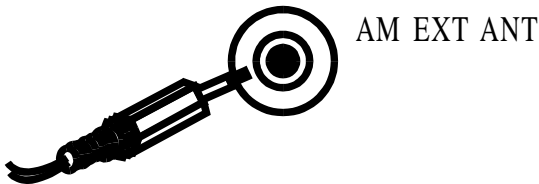

## MW STEP SELECTOR SWITCH

Located in battery compartment of the unit, is a switch marked, 9K/10K. This switch selects the incremental frequency STEPS for the MWband, depending upon your geographic location. In the USA, 10K STEPS are used, so the switch should be set to its 10K Position. In other parts of the world where they use 9K STEPS, move the switch to the 9K Position.

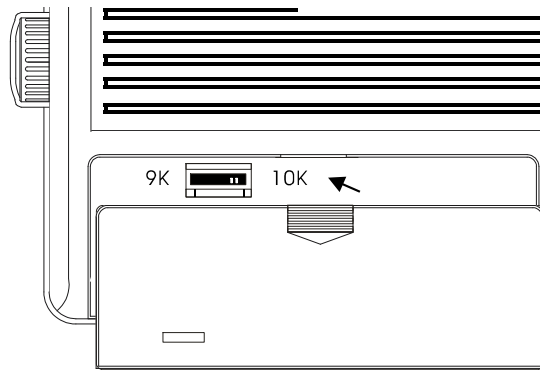

# Using Your Cassette Recorder

The Sangean Cassette Recorder built in to your Sangean Model ATS-818ACS is a top quality, precision cassette recorder providing a number of features to further enhance your use and enjoyment of your Sangean radio .Your Recorder can:

A: Allow you to play your favorite cassettes.

B: Allow you to record using the built-in microphone.

C: Allow you to record any program from AM (MW, LW or SW) FM.

D: Allow you to record any program from AM (MW, LW or SW)/FM at any preprogrammed time

## To Play a Cassette Tape

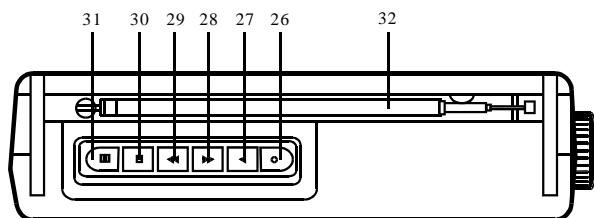

1. Press STOP/EJECT [30] to open the cassette door.
2. Insert a cassette with the full reel on the right, the side to be played facing you and the exposed tape pointing upward.
3. Close the cassette compartment door.
4. Press PLAY [27].
5. Adjust the Volume Control [32] to your desired listening level.

## Using Fast-Forward (FF) and Rewind.

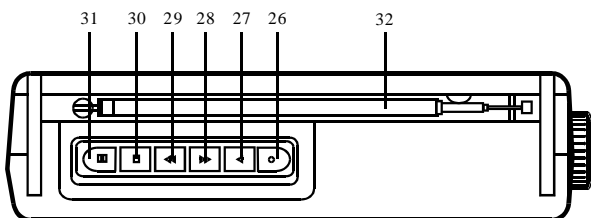

1. To Fast-Forward the tape, press FAST-FORWARD [29].
  2. Press STOP/EJECT [30] to stop Fast-Forward.
  3. To Rewind rapidly press REWIND [28].
  4. Press STOP/EJECT to stop the rewind motion.
- Caution:** In either Fast-Forward or Rewind, always press the STOP/EJECT [30] before changing tape motion. Do not switch from Fast-Forward to Rewind without pressing the STOP/EJECT button between the two operations. If you let the tape come to the end in either Fast-Forward or Rewind the tape will automatically stop.

## To Record with the Built-in Microphone

Your cassette recorder has a built-in condenser microphone [21] on the front of the cabinet. To record with the built-in microphone follow the following steps:

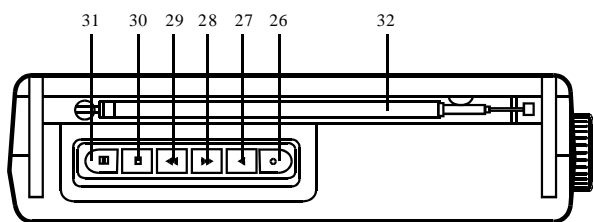

1. Select CrO2/NORMAL Tape Selection Switch [38]

2. Press RECORD [26] and PLAY [27] buttons simultaneously. RECORD will remain in the locked position and the RECORD LED [23] will illuminate indicating recording is in progress.

**Note:** The tape will stop automatically when it comes to the end of a side. At this point the RECORD button and the PLAY button will disengage and the recording will be terminated.

3. To listen to your recording it will be necessary to Rewind the tape, Stop the tape, and then press the PLAY button [27].

## To Record from the Radio

To record the current tuned program follow these steps:

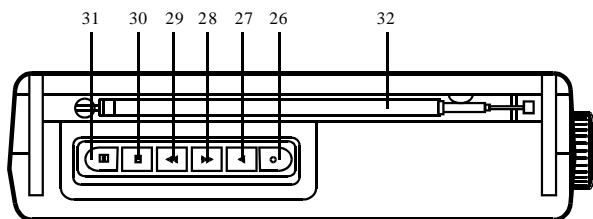

1. Install blank tape and select CrO2/NORMAL Tape Selection Switch [38].

2. To reduce interference when recording AM (MW, LW or SW) switch BEAT CUT Switch [40] to on position.

3. To listen to recording, rewind tape and press PLAY [27].

**Note:** The volume and balance controls have no effect during recording. They only effect the play operation. The recording level is set automatically by the alc (Automatic Level Control) circuit.

## To Record from the Radio using the Program Feature

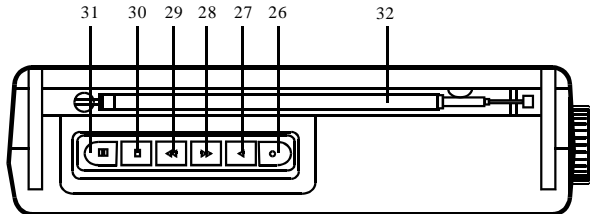

1. Turn on radio and tune to the desired station.
2. Turn off the radio, push STANDBY button [9] and set time for required start of recording.
3. Switch Standby Buzzer /Radio Switch [12] to the Radio position.
4. Switch Timer Recording On/Off Switch [39] to On position.
5. Select CrO<sub>2</sub>/NORMAL Tape Selection Switch [38].
6. Push RECORD [26] Play [27] Buttons simultaneously.

**Note:** The recording will continue until the cassette tape reaches the end of a side and it will then cease automatically and disengage the tape.

# SPECIAL SSB/CW RECEPTION TECHNIQUES

Many stations transmit unmodulated telegraph transmissions in the shortwave band. To receive these special Morse code characters, the radio uses a special circuit a *beat-frequency* oscillator, to modify the transmitted signal so that you can hear it. this particular type of telegraph transmission is called *continuous wave*(CW) transmission .

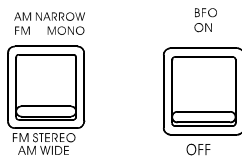

Many stations transmit voice signals with a suppressed carrier in the *single side band*. (SSB), part of the radio transmission spectrum that lies to the side of the primary frequency signal. Many amateurs who operate transmit below 10 Mhz generally use the *lower side band* (LSB). Above 10 MHz, they usually use the *upper side band* (USB). Commercial utility stations generally use the USB. A carrier has to be added to make these signals audible.

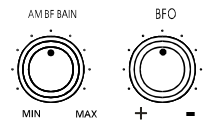

## TO RECEIVE CW

<p>1. Turn on the radio</p>	
<p>2. Extend the antenna fully straight up</p>	
<p>3. Set the BFO switch to ON.</p>	

4. Rotate the BFO PITCH control to the midpoint

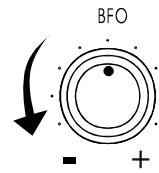

5. Rotate the RF GAIN control to the MAX position.

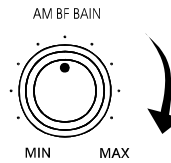

6. Press the SW band button to select the SW band.

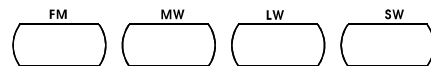

7. Tune in the CW station using the tuning knob, or enter the frequency using the direct access buttons.

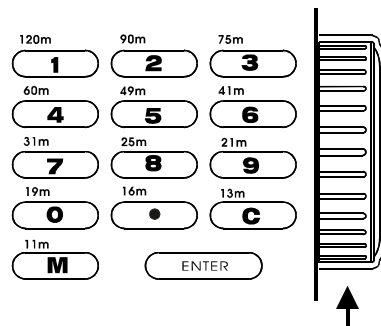

8. Adjust the CW tone using the BFO PITCH control.

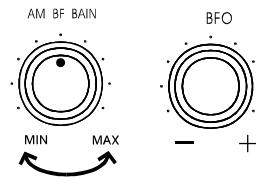

9. Reduce strong signals by using the RF GAIN control. This also reduces interference and noise.

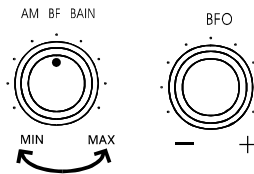

## TO RECEIVE SSB VOICE

1. Turn on the radio.

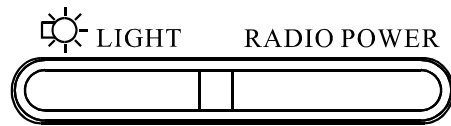

2. Extend the antenna fully, in a straight up position.

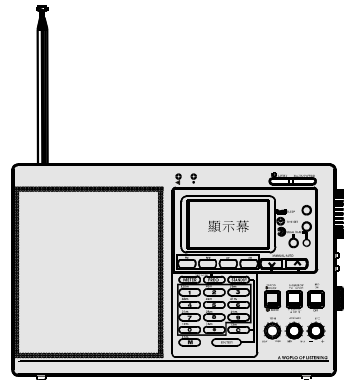

3. Set the BFO switch to the ON position.

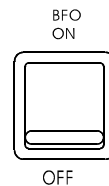

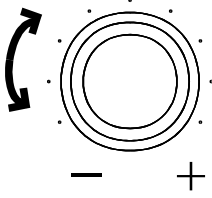
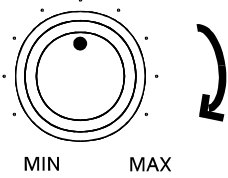
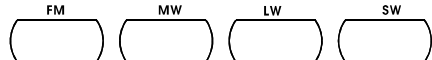
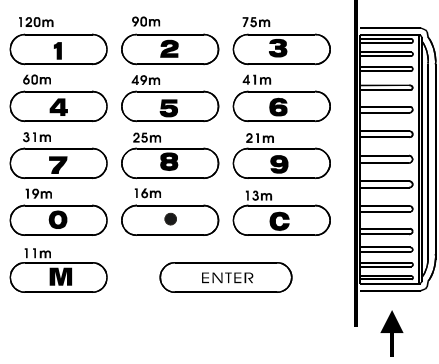

<p>4. Rotate the BFO PITCH control to the midpoint.</p>	<p style="text-align: center;">BFO</p> 
<p>5. Rotate the RF GAIN control to the MAX position.</p>	<p style="text-align: center;">AM BF BAIN</p> 
<p>6. Press the SW button to select the SW band.</p>	
<p>7. Tune in the SSB station using the tuning knob, or enter the frequency using the direct access buttons.</p>	

8. Rotate the BFO PITCH control to adjust the signal quality.

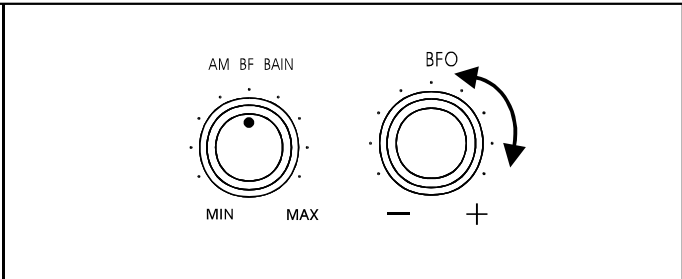

9. Rotate the RF CAIN control to dampen strong signals. This can improve signal clarity as well.

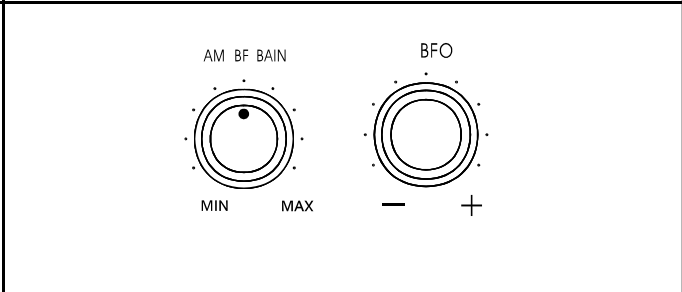



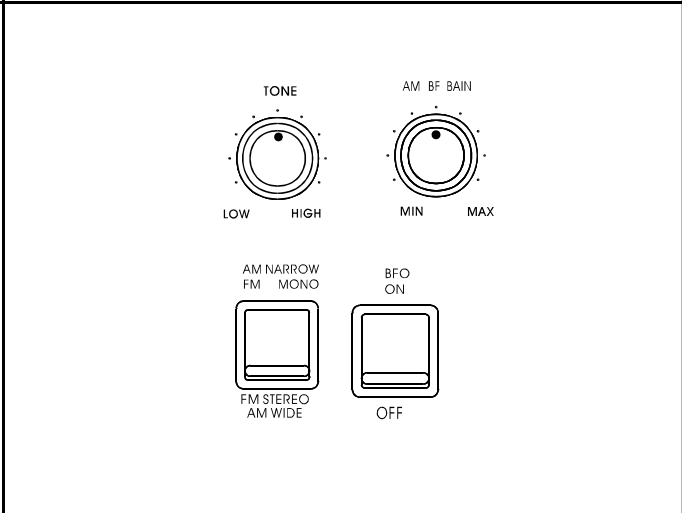

**Note :** Before choosing another band, set the RF GAIN control to MAX, and move the BFO switch to the OFF position.





# CARE AND MAINTENANCE

---

This receiver is an example of superior design and craftsmanship. The following suggestions will help you care for the receiver so that you can enjoy it for years.

<p>Keep the product dry .If it does get wet, wipe it dry immediately. Liquids might contain minerals that can corrode the electronic circuits.</p>	
<p>Use and store the product only in normal Temperature environments. High temperatures can shorten the life of electronic devices, damage batteries, and distort or melt plastic parts.</p>	
<p>Handle the product gently and carefully. Dropping it can damage circuit boards and cases and can cause the product to work improperly.</p>	
<p>Keep the product away from dust and dirt, Which can cause premature wear of parts.</p>	

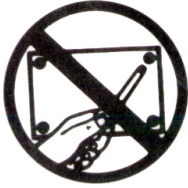
<p>Wipe the product with a dampened cloth occasionally to keep it looking new. Do not use harsh chemicals, cleaning solvents, or strong detergents to clean to product.</p>	 A circular icon with a diagonal slash through it. Inside the circle, there is a spray nozzle emitting a cloud of particles, representing a warning against using harsh chemicals for cleaning.
<p>Use only fresh batteries of the recommended size and type. Always remove old or weak batteries .They can leak chemicals that destroy electronic circuits.</p>	 A circular icon with a diagonal slash through it. Inside the circle, there are several old, leaking batteries, representing a warning against using old or weak batteries.
<p>Modifying or tampering with the product's internal components can cause a malfunction and might invalidate the product's warranty.</p>	 A circular icon with a diagonal slash through it. Inside the circle, there is a diagram of a circuit board with various components and wires, representing a warning against tampering with internal components.

# SPECIFICATIONS

---

Semi conductors: 1 LSI . 12 IC  
8 FET. 65 Transistors  
60 Diodes.  
2 LEDS.

Circuit:

FM :Heterodyne  
AM( LW ,MW, SW ) Double-conversion heterodyne

Frequency range:

FM : 87.5-108 MHz  
LW : 150-519 kHz  
MW : 520-1710 kHz  
SW 1.711-29.999 MHz

in which divided into 13 shortwave bands

120M	2.300-	2.495	MHz
90M	3.200-	3.400	MHz
75M	3.900-	4.000	MHz
60M	4.750-	5.060	MHz
49M	5.900-	6.200	MHz
41M	7.100-	7.350	MHz
31M	9.400-	9.990	MHz
25M	11.600-	12.100	MHz
21M	13.570-	13.870	MHz
19M	15.100-	15.800	MHz
16M	17.480-	17.900	MHz
13M	21.450-	21.750	Mhz
11M	25.600-	26.100	MHz

Antennas:

LW/M W built- in Ferrite bar Antenna  
SW Telescopic Antenna or external Antenna(not included)  
FM Telescopic Antenna

Output:

Nominal 800 mW at 10% T.H.D.

Jacks:

1.DC jack for external power(6V)  
2.Headphone jack -3.5 Ø for mini stereo headphones  
3.A M Ext .Ant. jack.

Recording System:

AC bias.

Erasing System:

Magnetic Erasing

Tape Speed:

4.76cm/ sec 3%

---

<b>Wow &amp; Flutter:</b>	0.35% W/RMS.
<b>Frequency Response:</b>	125-8000 Hz.
<b>Signal to Noise Ratio:</b>	35dB.
<b>Power sources:</b>	DC: 4 each D size batteries 3 each AA size batteries AC: 6 volt DC (optional adapter negative center)
<b>Dimension:</b>	296(L) x 192(H) x 68(T)mm
<b>Weight:</b>	2000g without batteries
<b>Accessories:</b>	Adaptor (except for certain areas like United Kingdom, New Zealand, Australia, South Africa, etc.)

## Free Manuals Download Website

<http://myh66.com>

<http://usermanuals.us>

<http://www.somanuals.com>

<http://www.4manuals.cc>

<http://www.manual-lib.com>

<http://www.404manual.com>

<http://www.luxmanual.com>

<http://aubethermostatmanual.com>

Golf course search by state

<http://golfingnear.com>

Email search by domain

<http://emailbydomain.com>

Auto manuals search

<http://auto.somanuals.com>

TV manuals search

<http://tv.somanuals.com>