

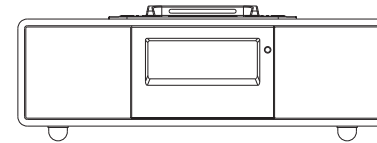

WR-5



GB

Rersion 1





“Made for iPod” means that an electronic accessory has been designed to connect specifically to iPod, and has been certified by the developer to meet Apple performance standards. Apple is not responsible for the operation of this device or its compliance with safety and regulatory standards.

Please note that the use of this accessory with iPod may affect wireless performance.

iPod, iPod classic, iPod nano, iPod shuffle, and iPod touch are trademarks of Apple inc., registered in the U.S. and other countries.



Table of contents

| | |
|--|-------|
| <i>Important safety instructions</i> | 3-4 |
| <i>Introduction</i> | 5 |
| <i>Controls</i> | 6-10 |
| <i>Remote control functions</i> | 11 |
| <i>Using the radio for the first time</i> | 12 |
| <i>Operating your radio – AM/FM</i> | 13-14 |
| <i>Setting up the tuning step increment</i> | 15 |
| <i>Display modes – FM</i> | 16 |
| <i>FM Stereo (auto) / mono</i> | 17 |
| <i>Presetting stations / Recalling a preset station in AM/FM modes</i> | 18 |
| <i>iPod docking</i> | 19-22 |
| <i>Setting the time format / date format</i> | 23-24 |
| <i>Setting the clock time</i> | 25-26 |
| <i>Setting the alarm clock</i> | 27-28 |
| <i>When the alarm sounds / Cancelling alarms / Snooze</i> | 29-30 |
| <i>Sleep timer</i> | 31 |
| <i>Time zone setting / Daylight saving time</i> | 32 |
| <i>Display & Audio setup</i> | 33-37 |
| <i>Specifications</i> | 38 |

GB

Important Safety Instructions

1. Read and understand all safety and operating instructions before the radio is operated.
2. Retain instruction: The safety and operating instructions should be retained for future reference.
3. Heed warnings. All warnings on the appliance and operating instructions should be followed.
4. Follow all operations and use instructions.
5. Water and moisture: The appliance should not be used near water. Do not use near a bathtub, washbowl, laundry tub, kitchen sink, wet basement, swimming pool, etc.
6. Unplug the radio from the AC power outlet before cleaning. Use only a damp cloth for cleaning the exterior of the radio.
7. Do not place the radio on an unstable cart, stand, bracket or table. The radio may fall, causing serious personal injury and damage to the radio.
8. Ventilation: This radio should be situated so that its location or position does not interfere with its proper ventilation. For example, the radio should not be used on a bed, sofa, rug or other soft surfaces that may block the ventilation openings. It should not be placed in a built-in situation like a cabinet that may reduce air flow through the ventilation openings.
9. Power sources; The radio should be operated only from the type of power source indicated on the marking label. If you are not sure of the type of power supply to your home, consult your radio dealer or power company.
10. Mains adaptor: The mains adaptor should be positioned so it is not walked on, pinched, or items placed on top of it. Pay particular attention to wires at plugs, convenience receptacles, and the point where they exit from the unit. Unplug the mains adaptor by gripping the adaptor, not the wire. Operate the radio using only the current type of power source indicated. If you are not sure of the type of power source supply to your home, consult your dealer or local power company.
11. Do not overload wall outlets or extension cords. This can result in a risk of fire or electrical shock. Never insert objects of any kind into the radio through opening. The objects may touch dangerous voltage points or short out parts. This could cause a fire or electrical shock.
12. If the radio is left unattended and unused for long periods of time, unplug it from the wall outlet. This will prevent damage caused by lightning or power line surges.
13. If the radio is left unattended and unused for a long period of time, remove the batteries. The batteries may leak and damage furniture or your radio. (US version only)



GB

14. Do not attempt to service the receiver yourself. Removing the cover may expose you to dangerous voltage, and will void the warranty. Refer all servicing to authorized service personnel.
15. Never push objects of any kind into this radio through opening as they may touch dangerous voltage points or short-out parts that could result in a fire or electric shock. Never spill liquid of any kind into the product.
16. Apparatus shall not be exposed to dripping or splashing and no objects filled with liquids, shall be placed on the apparatus.
17. For outdoors use, to avoid electric shock, use battery only during a raining day or the weather is wet.
18. The power plug should be close to the radio, and easy to be approached that during the emergency, to disconnect the power from the radio, just unplug the power plug from the AC power slot.





Introduction

The Sangean WR-5 AM/FM-RDS/iPod Dock Wooden Table-top Receiver provides the following range of features:

- Ⓞ Radio for AM and FM (with RDS) broadcasts.
- Ⓞ 12 radio station presets (6 for AM, 6 for FM).
- Ⓞ Large LCD display with adjustable backlight.
- Ⓞ Two alarm timers with snooze feature to wake you to either buzzer, radio alarm, or iPod.
- Ⓞ Adjustable sleep timer which can be set to turn the clock radio off after between 15 and 120 minutes.
- Ⓞ A 3.5mm stereo Auxiliary Input socket for playing audio from MP3 players, iPod devices or other audio equipment.
- Ⓞ iPod cradle plays and charges iPods.
- Ⓞ Equipped with tone control (bass/treble) and loudness compensation.
- Ⓞ Passive reflex tube and 3D expandable surround design speakers to enhance the sound performance.
- Ⓞ Remote control allows you to access all features of WR-5 and operate iPod more easily.

Controls

GB

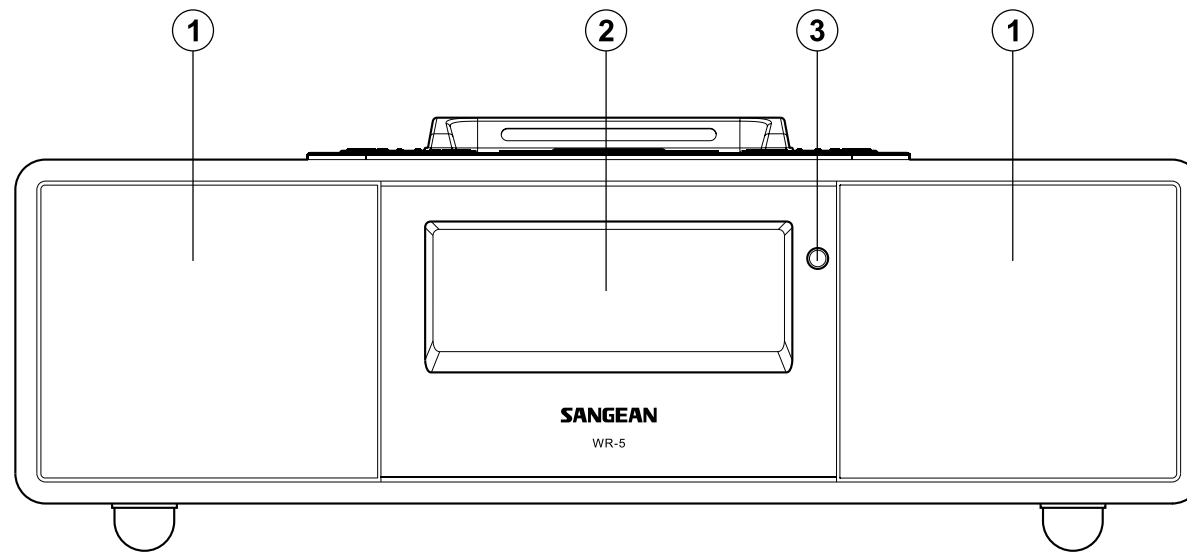

1. Speakers
2. LCD display

3. Remote control sensor

Controls

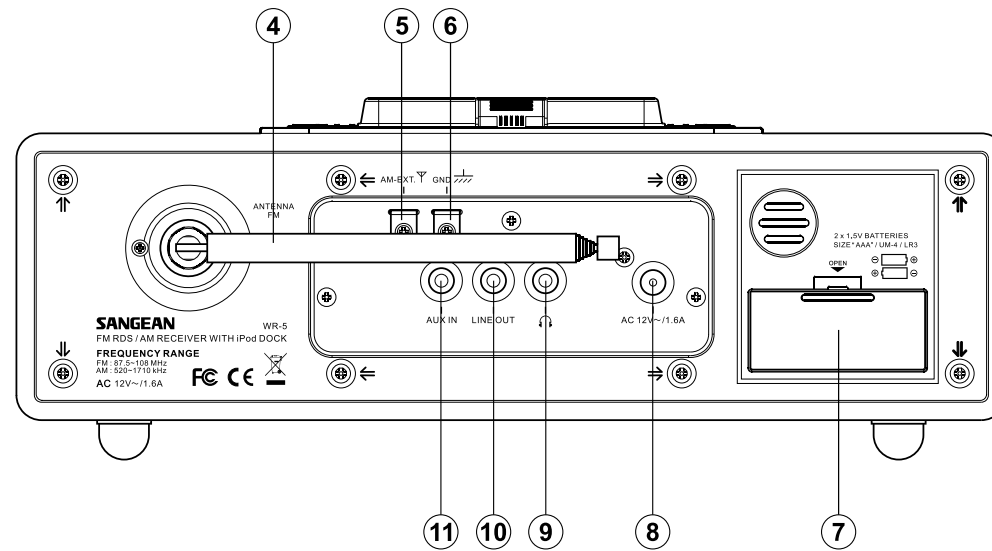

- | | |
|---------------------------------|---------------------|
| 4. FM telescopic antenna | 8. AC in |
| 5. AM external antenna terminal | 9. Headphone jack |
| 6. Ground terminal | 10. Line out socket |
| 7. Battery compartment | 11. Aux in socket |

Controls

GB

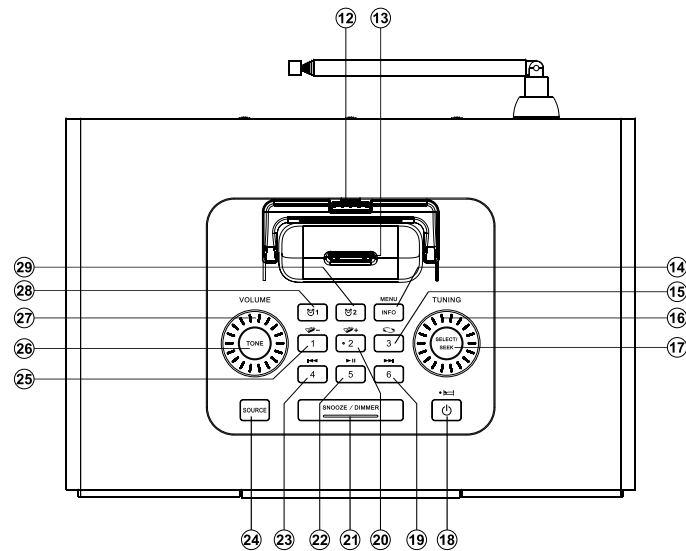

- | | |
|----------------------------------|-----------------------------|
| 12. iPod Universal Dock adjuster | 21. Snooze / dimmer |
| 13. iPod Dock connector | 22. Preset 5 / Play / pause |
| 14. Info / menu button | 23. Preset 4 / Back Forward |
| 15. Preset 3 / Repeat button | 24. Source |
| 16. Tuning control | 25. Preset 1 / Folder Down |
| 17. Seek / Select button | 26. Tone button |
| 18. Standby / Sleep timer | 27. Volume control |
| 19. Preset 6 / Fast Forward | 28. Alarm 1 |
| 20. Preset 2 / Folder Up | 29. Alarm 2 |

Display icons

- A. Battery capacity indicator
- B. PM indicator
- C. Time display
- D. Sleep timer icon
- E. Alarm 1 icon
- F. Alarm 2 icon
- G. Frequency / information for station display
- H. RDS icon

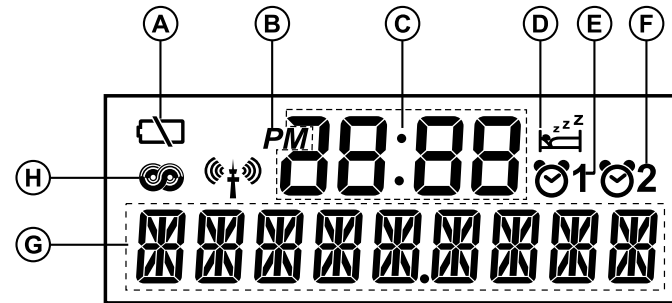

Remote control

- a. Back forward
- b. Repeat one / all
- c. Tuning up
- d. Folder up / preset up
- e. Folder down / preset down
- f. Tuning down
- g. Mute
- h. Snooze / dimmer
- i. Tone
- j. Volume down
- k. Volume up
- l. Repeat random
- m. Select
- n. Fast forward
- o. Play / pause
- p. Source
- q. Menu
- r. Standby / Sleep timer

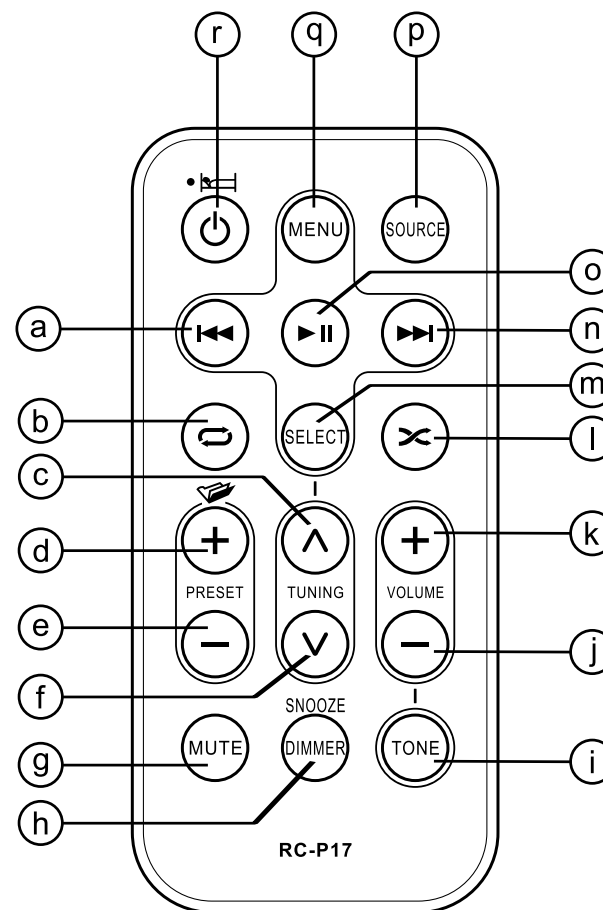

GB

Remote control functions

Many functions of the WR-5 tabletop receiver can be operated using the remote control. Some operations require a longer press of the button. In this case simply keep your finger held on the remote control button for 2-3 seconds until the display on the radio shows that the command has been accepted.

Before the first operation: please remove the small transparent foil from the battery holder to activate the battery.

Remote control battery replacement

1. Open the battery holder by pulling the holder out in direction shown.
2. Remove battery from holder.
3. Replace battery (CR2025 or equivalent) ensuring that the positive side of the battery faces you with holder positioned as shown.
4. Replace the battery holder.

IMPORTANT:

The batteries should not be exposed to excessive heat such as sunshine, fire or the like. After use, disposable batteries should if possible be taken to a suitable recycling center. On no account should batteries be disposed of by incineration.

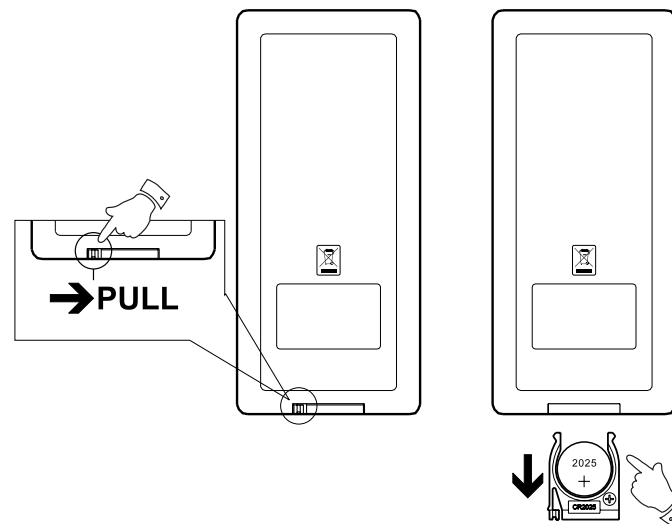



Using the radio for the first time

Using the AC power adaptor

The AC power adaptor required for this unit should be 12 volts AC at 1.6A.

Insert the adaptor plug into the AC socket on the rear of the radio. Plug the adaptor into a standard mains socket outlet.

The AC adaptor should be disconnected from the main supply when not in use.

Backup battery operation (for US version only)

1. Remove the battery cover on the bottom of the unit.
2. Insert two UM-4 (AAA size) batteries into the spaces in the compartment.
3. Take care to ensure all batteries are inserted with correct polarity as shown inside the compartment. Replace the battery cover.
4. When the low battery capacity indicator shows on the display please replace the batteries immediately.
5. When the radio is used as clock radio or as an alarm, please always keep the batteries inserted.

Getting started with external accessories

You may use an optional AM Radio Antenna as external antenna if satisfactory reception cannot be obtained. Connect the optional AM radio antenna to the AM external antenna terminal and ground terminal located on the rear panel. See figure 5, 6.

GB



Operating your radio – Search tuning AM/FM

1. Press the Standby button to switch on your radio.
2. Press the Source button as needed until the AM or FM band is selected.
3. Press and release the Seek / Select button to carry out an auto-tune. Your radio will scan up the AM/FM band from the currently displayed frequency and will stop scanning automatically when it finds a station of sufficient strength.
4. After a few seconds the display will update. The display will show the frequency of the signal found.
5. To find other station, press and release the Seek / Select button as before.
6. When the end of the waveband is reached your radio will recommence tuning from the opposite end of the waveband.
7. Use the Volume control to adjust the sound level as required.
8. To switch off your radio press the Standby button.

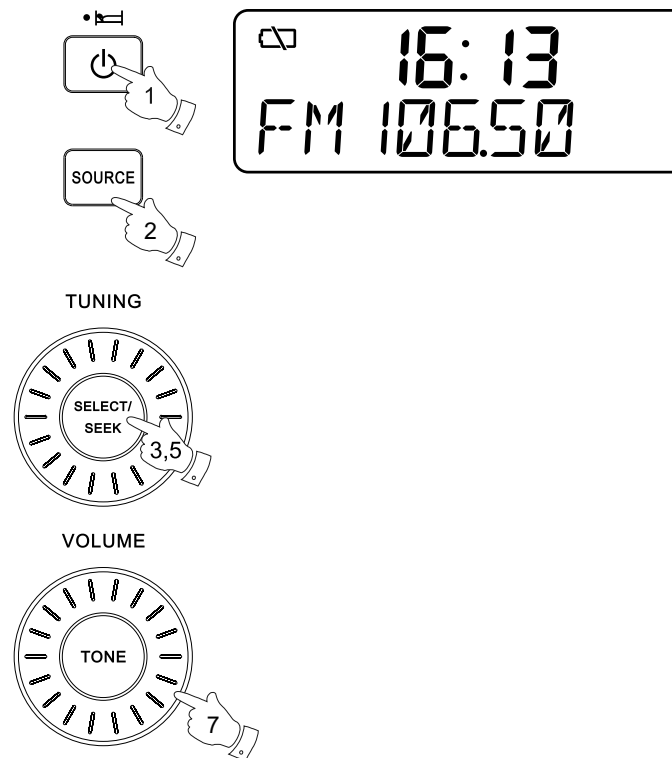

Manual tuning – AM/FM

1. Press the Standby button to switch on your radio.
2. Press and release the Source button to select AM or FM radio mode.
3. Rotate the Tuning control to tune to a station. The FM frequency will change in steps of 100kHz/50kHz and AM frequency will change in steps of 10kHz/9kHz.
4. When the end of the waveband is reached your radio will recommence tuning from the opposite end of the waveband.
5. Use the Volume control to adjust the sound level as required.

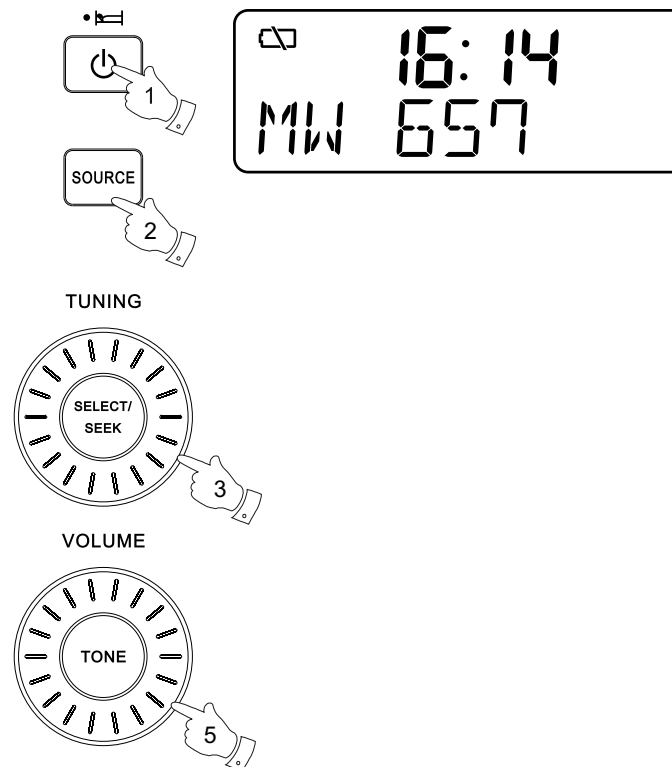

GB

Setting up the tuning step increment

1. Press and hold the Info/menu button to enter the menu setting.
2. Rotate the Tuning control until FM 50/100MHz or AM 9/10kHz appears on the display, and press and release the Seek / Select button to enter the step increment setting.
3. Rotate the Tuning control to select either 100kHz/200kHz (US version) or 50kHz/100kHz (European version) for FM radio, and 9kHz/10kHz for AM radio. Then press and release the Seek / Select button to confirm the setting.
4. Press and release the Info/menu button and the LCD will revert to the normal display.

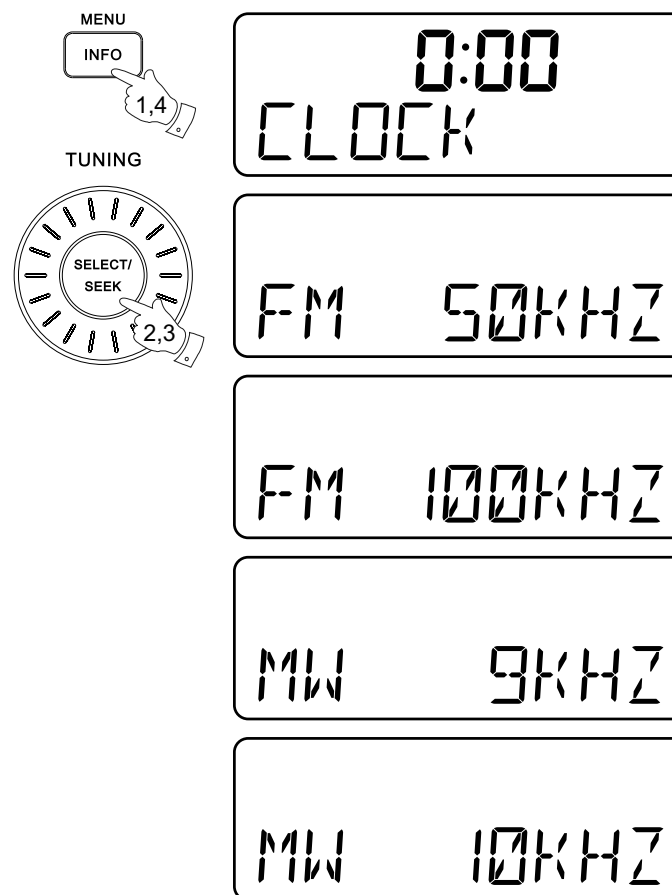



Display modes – FM

GB

Your radio has a range of display options for FM radio mode.

1. Repeatedly press and release the Info/menu button to view the RDS information of the station you are listening to.

- | | |
|---------------|--|
| Station name | Displays the name of the station being listened to. |
| a. | |
| Program type | Displays the type of station being listened to such as Pop, Classic, News, etc. |
| b. | |
| Radio text | Displays radio text messages such as new items etc. |
| c. | |
| Stereo / Mono | Displays the radio broadcasting is in Stereo or Mono mode. |
| d. | |
| Year / Day | Displays the year and day of the week according to the date setting of your radio. |
| e. | |
| Date / Day | Displays the date and day of the week according to the date setting of your radio. |
| f. | |
| Frequency | Displays the frequency of the FM for the station listened to. |
| g. | |

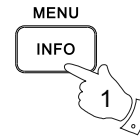

FM stereo (auto) / mono

If the FM radio station being listened to has a weak signal some hiss may be audible. It is possible to reduce this hiss by forcing the radio to play the station in mono rather than stereo.

1. Press the Source button as needed to select the FM radio mode display and tune to the required FM station as previously described.
2. Press and hold the Info/menu button to enter the menu setting.
3. Rotate the Tuning control until the FM Stereo / mono setting shows on the display. If the setting is Auto press the Seek / Select button to switch to Mono mode to reduce the hiss.
4. To return to Auto (stereo) mode press and release the Seek / Select button to alter the setting, so that the radio will switch back to Auto mode.

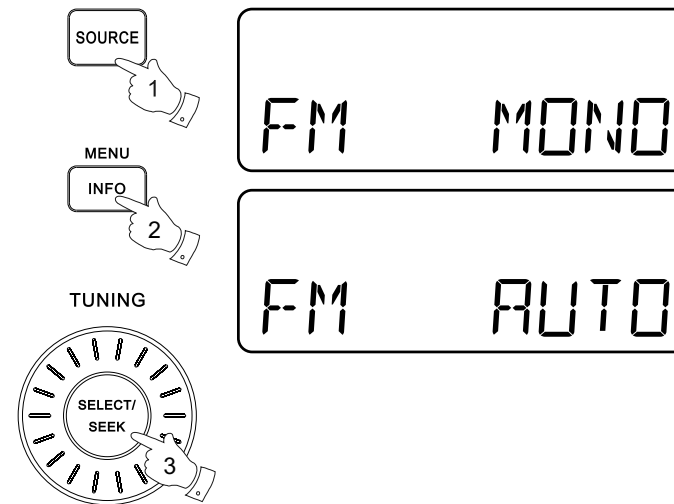

Presetting stations in AM/FM mode

GB

There are 6 preset stations each for AM and FM radio. They are used in the same way for each waveband.

1. Press the Standby button to switch on your radio.
2. Press the Source button to select the desired waveband. Tune to the required radio station as previously described.
3. Press and hold the required Preset button (1 to 6) until the display shows "P3" for example after the frequency. The station will be stored using the preset number. Repeat this procedure for the remaining presets as you wish.
4. Preset stations which have already been stored may be overwritten by following the above procedure if required.

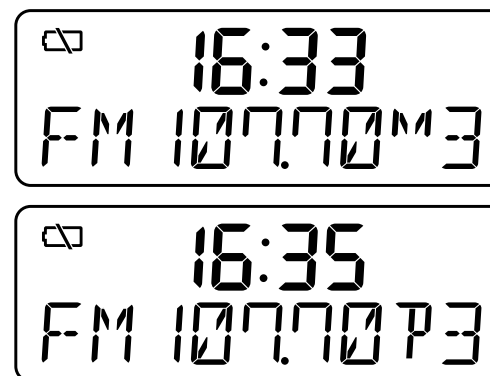
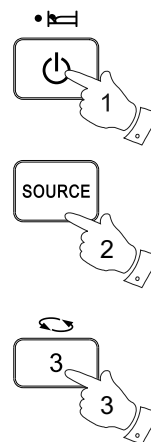

Recalling a preset in AM/FM mode

1. Press the Standby button to switch on your radio.
2. Select the required waveband by pressing the Source button.
3. Momentarily press the required Preset button to cause your radio to tune to one of the stations stored in the preset memory.

Note:

**the remote control can only recall preset stations.
Presetting stations can't be operated by remote control.**

iPod docking

Your radio has an iPod docking facility which allows you to play digital audio files and soundtracks held on your iPod directly.

Your radio uses the iPod Universal Dock adjuster developed for use with iPods. Recent models of iPod are supplied with Universal Dock Adapter inserts which ensure correct alignment of the iPod with the electrical connector.

Important:

The radio does not support iPod 3rd generation (build 2003-2004). To avoid possible damage to your iPod, do not use your iPod with the product without the correct adapter fitted to the radio.

Docking your iPod by dock adjuster

This unit comes with the iPod dock adjuster. iPod adaptors are not supplied.

1. Press and turn the iPod dock adjuster dial to move slide door backward until end.
2. Carefully place your iPod onto the cradle.
3. Turn the iPod dock adjuster dial to move slide door forwards until holding your iPod.

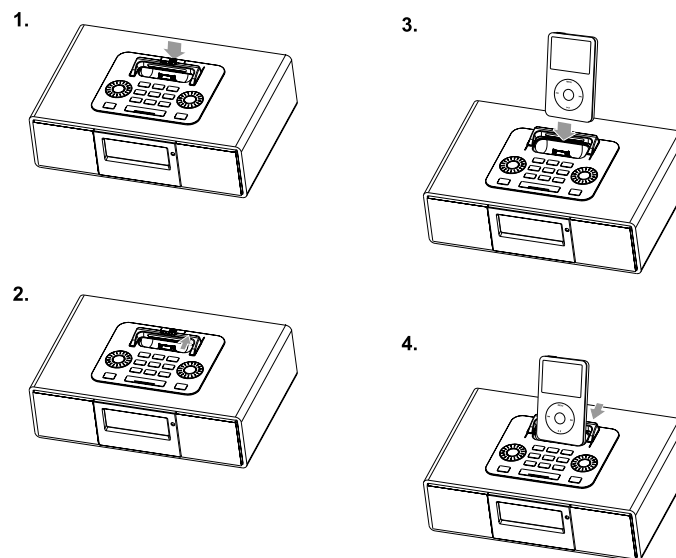

Charging your iPod

1. Place the iPod onto the Universal Dock Adjuster into the iPod docking compartment. Press the STANDBY button to switch on your radio.
2. Press SOURCE button until "iPod" shows on the display. Your radio is able to recharge your iPod's internal battery when the source is Aux In, iPod or Standby mode. Your iPod won't be charged under AM and FM mode.

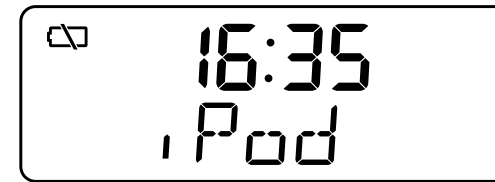
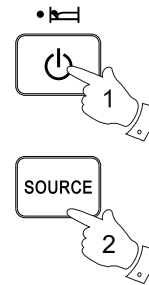

GB

Navigating your iPod

To navigate your iPod menus to make selections or to change settings, you should use your iPod controls. The radio controls can be used for Menu / Select, Previous / Next, Fast Rewind / Fast Forward and Play / Pause functions.

1. Use the Menu button to navigate to higher level menus on your iPod.
2. Rotate the Tuning control as required to move up or down a menu screen on your iPod.
3. Press the Seek / Select button to choose the highlighted on screen menu item. If this item is a lower level menu item, you may then navigate further using the Tuning/Seek/Select control.

Playing an audio file / repeat playing files on your iPod

1. When you have found the required item, use the Tuning/Seek/Select control on the radio to start the iPod playing.
2. Adjust the volume to the required setting using the Volume control on your radio.
3. To pause playback press the Play/Pause button. To resume playback press the Play/Pause button again.
4. iPods do not have a Stop button (they use the Pause function). To play an alternative selection, use the iPod menus to make the selection using the Play/Pause button to stop playing the current item if needed.
5. If it was previously playing, your iPod will switch on and continue playing from where it was previously stopped.
6. To select the various repeating modes, press and release the Repeat button (Preset 3) to repeat one/all/folder or repeat random.

Search function

1. Press and release either the Fast-Forward or Back-forward button to start playing the next or previous track.
2. While the iPod is playing, press and hold the Fast-Forward or Back-forward buttons to move through the current file or track, and then release the button when the desired point in the file or track is reached.

Your WR-5 works with the following models of iPod:

GB



iPod classic
120GB 160GB (2009)



iPod
4th generation
40GB



iPod nano
5th generation (video camera)
8GB 16GB



iPod mini
4GB 6GB



iPod
4th generation
(color display)
20GB 30GB



iPod
5th generation
(video)
60GB 80GB



iPod touch
1st generation
8GB 16GB 32GB



iPod nano
1st generation
1GB 2GB 4GB



iPod nano
2nd generation
(aluminum)
2GB 4GB 8GB



iPod touch
2nd generation
8GB 16GB 32GB



iPod nano
3rd generation
(video)
4GB 8GB



iPod nano
4th generation (video)
8GB 16GB



iPod touch
3rd generation
32GB 64GB

Clock and Alarms

Setting the time format

The clock display used in stand-by mode and on the playing mode screens can be set to 12 or 24 hour format. The selected format is then also used when setting the alarms.

1. Press and hold the Info/menu button to enter the menu setting.
2. Rotate the Tuning control until CLOCK 12H/24H appears on the display, then press and release the Seek / Select button to enter the setting and the setting of time format begins to flash.
3. Rotate the Tuning control to select either 12 or 24 hour format. Press and release the Seek / Select button to confirm your choice of clock format. The display will then revert to the previous menu.
4. Press and release the Info/menu button and the LCD will revert to the normal display.

If the 12 hour clock format is chosen, the radio will then use the 12 hour clock for the setting of alarms with a PM indicator.

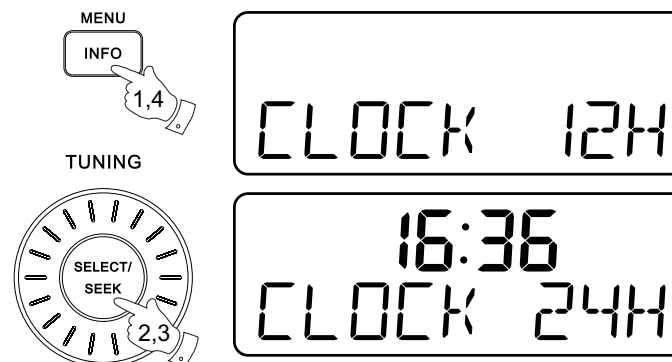

Setting the date format

1. Press and hold the Info/menu button to access the menu setting.
2. Rotate the Tuning control until date format ex. "Jan-xx-2010" shows on the display. Press and release the Seek / Select button to enter the date format setting.
3. Rotate the Tuning control to select the required date format. Press and release the Seek / Select button to confirm your choice of date format. The display will then revert to the previous menu.
4. Press and release the Info/menu button and the LCD will revert to normal display.

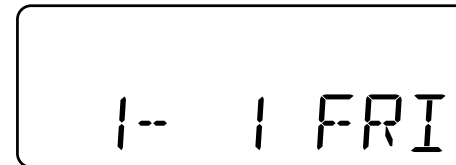

GB

Setting the clock time manually

1. Press the Standby button to switch on your radio.
2. Press and hold the Info/menu button.
3. Rotate the Tuning control until a clock symbol appears on the left side display, then press and release the Seek / Select button to enter the setting. Rotate the Tuning control until MANUAL appears on the display, then press and release the Seek / Select button to select the setting.
4. Rotate the Tuning control until CLOCK appears on the display. Press and release the Seek / Select button to enter the setting.
5. The hour setting on the display will begin flashing. Rotate the Tuning control to select the desired hour, and press and release the Seek / Select button to confirm the setting. Then rotate the Tuning control to select the desired minute, and press and release the Seek / Select button to confirm the setting.
6. Rotate the Tuning control until DATE appears on the display. Press and release the Seek / Select button to enter the setting.
7. The year setting will begin to flash. Rotate the Tuning control to select the desired year, and press and release the Seek / Select button to confirm the setting. Then rotate the Tuning control to select the desired month, and press and release the Seek / Select button to confirm the setting. Then rotate the Tuning control to select the desired date. Press and release the Seek / Select button to confirm the setting and the radio will beep once.
8. Press and release the Info/menu button to leave the current setting, and the radio will revert to normal display.

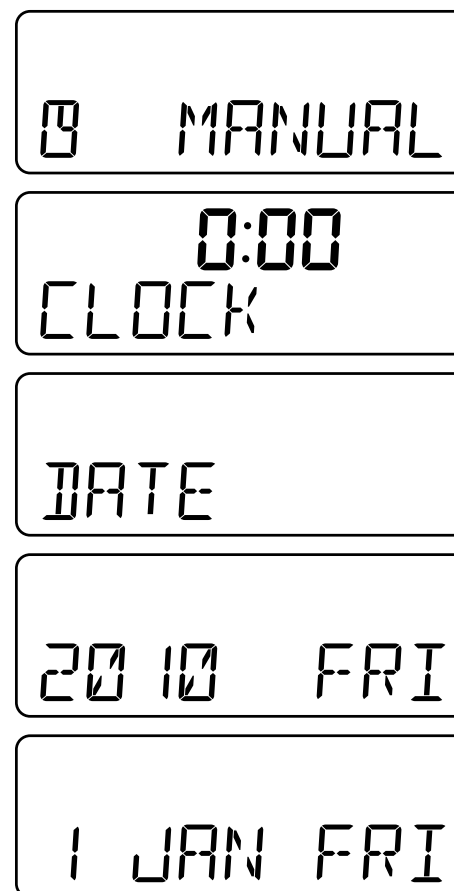
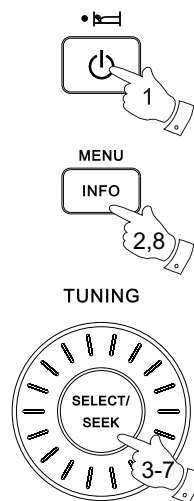

Setting the clock time using RDS CT

1. When tuning to a station transmitting RDS data, press and hold the Info/menu button.
2. Rotate the Tuning control until a clock symbol appears on the display. Press and release the Seek / Select button to enter the setting.
3. Rotate the Tuning control until RDS CT appears on the display. Press and release the Seek / Select button to confirm the setting. The clock time of the radio will set up automatically according to the RDS data received. When the action is completed, the RDS icon will appear on the LCD display indicating the radio time is RDS clock time. The radio clock time will be valid for 5 days each time the radio time is synchronized with RDS CT.
4. Press and release the Info/menu button and the LCD will revert to the normal display.

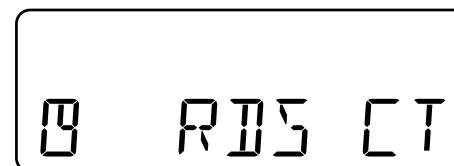
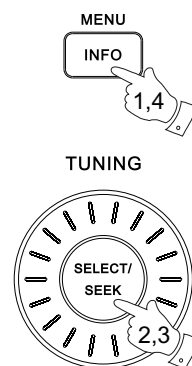

GB

Setting the alarm clock

Your WR-5 has two alarms which can each be set to wake you to AM/FM radio, buzzer alarm or iPod. The alarms may be set while the unit is in standby mode or while playing.

1. Before setting an alarm ensure that the clock time is set. Press and hold the Alarm 1 button to enter the alarm 1 setting.
2. The hour setting of alarm 1 will begin to flash. Rotate the Tuning control to select the required alarm hour, and press and release the Seek / Select button to confirm the setting. Rotate the Tuning control to select the required alarm minute, and press and release the Seek / Select button to confirm the setting.
3. Then the display will show the frequency options for the alarm.
The alarm options are as follows:
ONCE – the alarm will sound once
DAILY – the alarm will sound everyday
WEEKDAY – the alarm will sound only on weekdays
WEEKEND – the alarm will sound only at weekends
Press and release the Seek / Select button to confirm the setting.

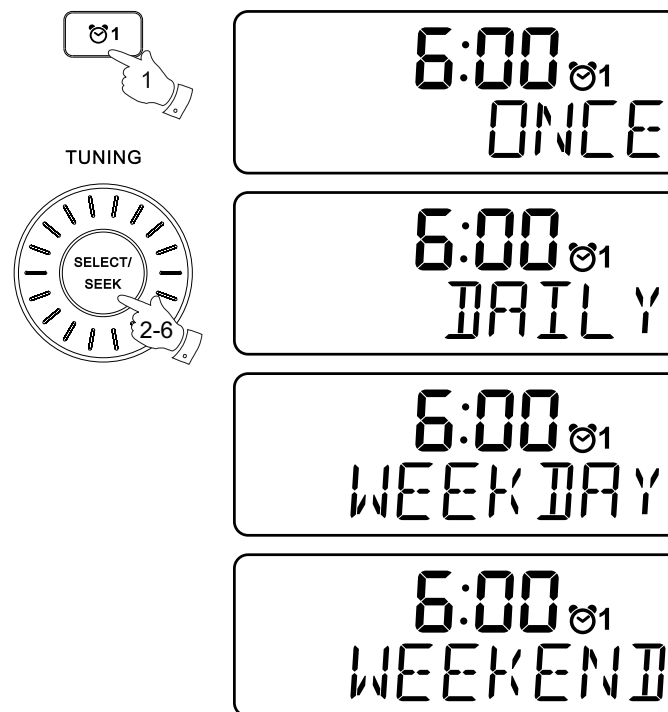

4. Rotate the Tuning control to choose the required alarm type, and then press and release the Seek / Select button to confirm the setting. The alarm can be set to buzzer, iPod, FM or AM. When radio mode is selected, the radio frequency and the preset number on the display will begin to flash. Rotate the Tuning control to adjust the required radio frequency or the required preset number for the radio alarm, then press and release the Seek / Select button to confirm the setting.

Note:

If the alarm type selected is iPod but your iPod is not docked when the alarm is sounding, the buzzer alarm will be used instead.

5. Rotate the Tuning control to choose the required sound level for the alarm. Press and release the Seek / Select button to confirm the setting.
6. The alarm has now been set. Press and release the Seek / Select button again, and the radio will revert to normal display. Active alarms are shown using alarm indicator on the display.

GB

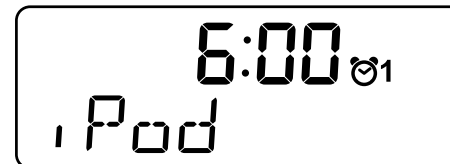
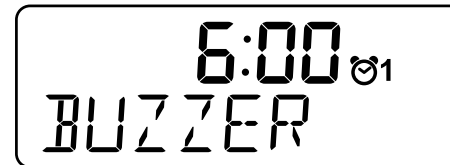
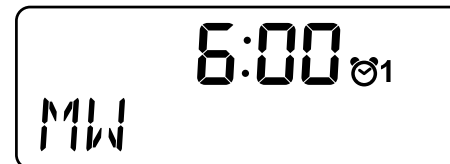

When the alarm sounds

To cancel a sounding alarm, press and hold the Alarm 1 or Alarm 2 button until the alarm indicator on the display disappears.

When the buzzer alarm activates, the alarm will start softly and gradually increase in level. It will sound for 1 minute and silence for 1 minute in repetition for 60 minutes unless cancelled. The radio will sound non-stop at the selected time for up to 60 minutes for other alarm types.

Disabling / cancelling alarms

To disable an active alarm, either press and release the Standby button, or press and hold the according alarm button to cancel the alarm.

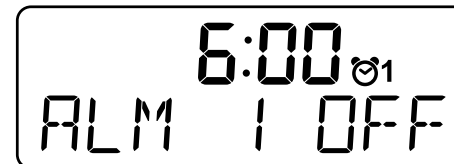

Snooze

1. When the alarm sounds, press any button other than the Standby button will silence the alarm for 5 minutes. "SNOOZE" will appear on the display.
2. To adjust the silence time for the snooze timer, press and hold the Info/menu button to enter the menu setting.
3. Rotate the Tuning control until "SNOOZE 5" appears on the display, then press and release the Seek / Select button to enter the setting. Rotate the Tuning control to adjust the silence time from 5, 10, 15 and 20 minutes for the snooze timer.
4. To cancel the snooze timer while the alarm is suspended, press and release the Standby button.

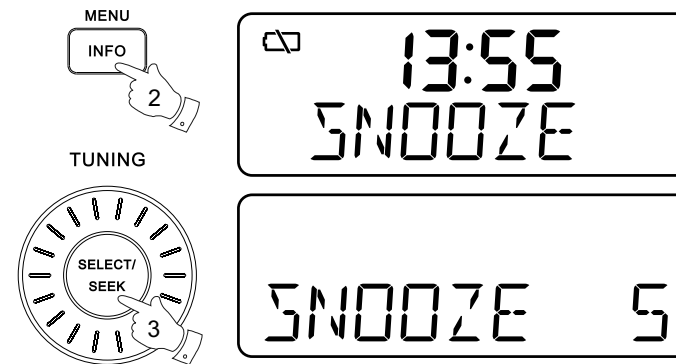

GB

Sleep timer

Your radio can be set to turn off automatically after a preset time has elapsed. The Sleep Timer setting can be adjusted between 15, 30, 45, 60, 90 and 120 minutes.

1. Press and hold the Standby button to enter the Sleep Timer setting. "SLEEP XX" will show on the display.
2. Keep pressing the Standby button and the Sleep Timer options will start switching on the display. Stop until the required Sleep Timer setting appears on the display. The setting will be saved and the LCD will return to normal display.
3. Your radio will switch off automatically after the preset Sleep Timer has elapsed. The Sleep Timer icon will show on the display indicating an active Sleep Timer.
4. To cancel the Sleep Timer function before the preset time has elapsed, simply press and release the Standby button to turn the unit off manually.

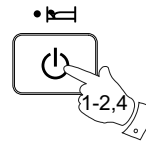

Time zone setting

Your WR-5 can set up the time zone for its radio clock time.

1. Press and hold the Info/menu button to enter the menu setting.
2. Rotate the Tuning control until TIME ZONE appears on the display. Press and release the Seek / Select button to enter the setting.
3. Rotate the Tuning control to choose the Time zone setting for your area, then press and release the Seek / Select button to confirm the setting.
4. Press and release the Info/menu button and the LCD will revert to the normal display.

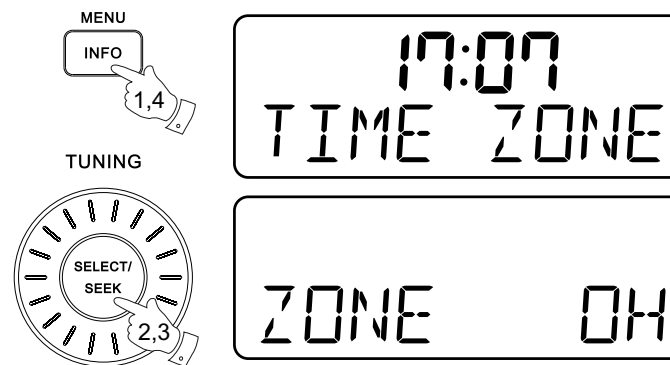

Daylight Saving Time

1. Press and hold the Info/menu button to enter the menu setting.
2. Rotate the Tuning control until "DST OFF" appears on the display. Press and release the Seek / Select button to enter the setting.
3. Rotate the Tuning control to choose +1H to set the clock 1 hour faster, and press and release the Seek / Select button to confirm the setting.
4. To set the clock back from D.S.T., choose OFF and then press and release the Seek / Select button.

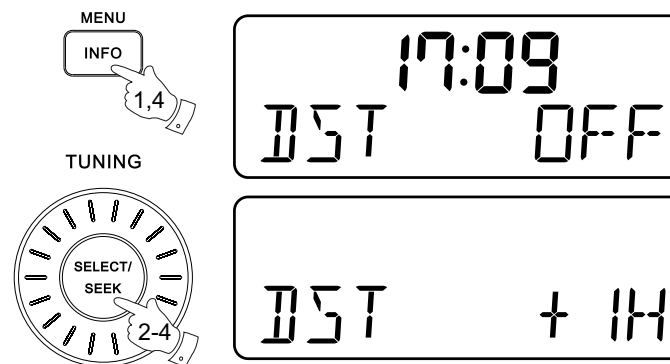

Display & Audio setup

Dimmer control

The brightness of the display may be adjusted. If you use the unit in the bedroom, you may prefer a higher brightness level than the standard setting.

1. Press and release the Snooze/Dimmer button repeatedly to adjust the brightness level of the LCD display. The backlight level will change with 8 different illumination levels so that you can see the effect of the change.
2. Stop when the desired backlight level is selected.

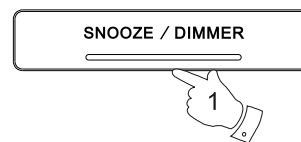

Tone control

You can adjust the bass and treble of the sound of your WR-5 to enhance the tone while listening.

1. First ensure your radio is switched on. Press and release the Tone control to enter the tone control setting.
2. The bass value will appear on the display. Rotate the Volume control to adjust between -5~+5, and press and release the Tone control to confirm the setting.
3. Then the treble value will appear on the display. Rotate the Volume control to adjust between -5~+5, and press and release the Tone control to confirm the setting.

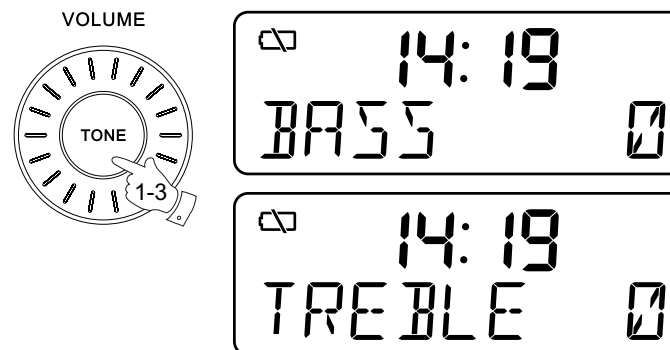

Loudness

GB

You can get compensation on lower and higher frequency for your WR-5 by adjusting the Loudness function.

1. Press and hold the Info/menu button to enter the menu setting.
2. Rotate the Tuning control until LOUD ON/OFF appears on the display. Press and release the Seek / Select button to enter the setting.
3. Rotate the Tuning control to choose ON to turn on the Loudness function, then press and release the Seek / Select button to confirm the setting.
4. To turn off the Loudness function, select OFF and press and release the Seek / Select button to confirm the setting.

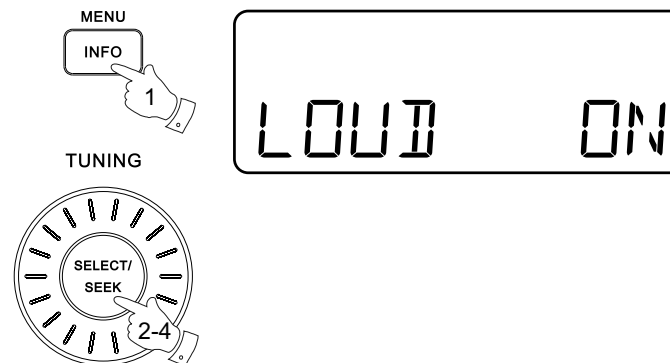

3D surround sound expander

Your WR-5 allows you to get more spaciousness in the sound performance with the 3D surround expander function.

1. Press and hold the Info/menu button to enter the menu setting.
2. Rotate the Tuning control until 3D ON/OFF appears on the display. Press and release the Seek / Select button to enter the setting.
3. Rotate the Tuning control to choose ON to turn on the 3D surround expander function, then press and release the Seek / Select button to confirm the setting.
4. To turn off the 3D expander function, select OFF and press and release the Seek / Select button to confirm the setting.

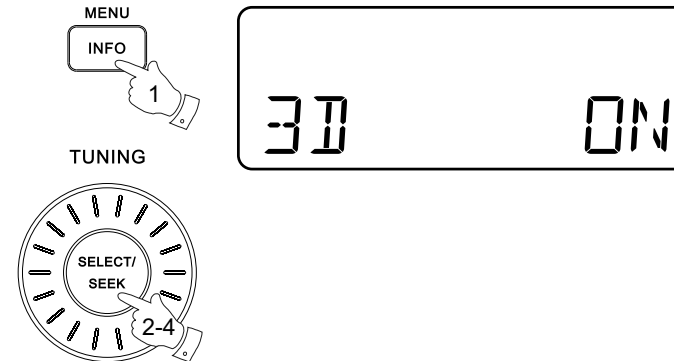

Auxiliary input socket

GB

A 3.5mm stereo Auxiliary Input socket is provided on the rear of your radio to permit an audio signal to be fed into the unit from an external audio device such as iPod, MP3 or CD player.

1. Repeatedly press and release the SOURCE button until AUX IN is displayed.
2. Connect an external audio source (for example, iPod, MP3 or CD player) to the Auxiliary Input socket.
3. Adjust the volume setting on your iPod, MP3 or CD player to ensure an adequate signal level from the player, and then use the Volume control on the radio as needed for comfortable listening.

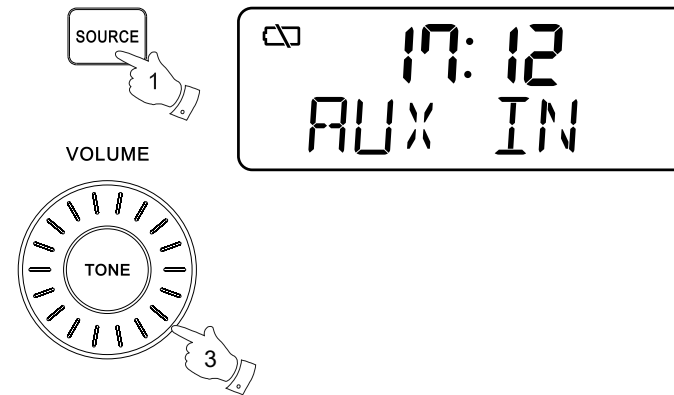

Headphone socket

A 3.5mm stereo Headphone Socket is provided on the rear of your radio for use with headphones. Inserting a plug automatically mutes the internal loudspeaker.

IMPORTANT:

Excessive sound pressure from earphones and headphones can cause hearing loss.

Line out socket

The radio can be used as a separate tuner by connecting the input to Hi-Fi system, or using this input to make recording in stereo from audio program.

Software version

The software display cannot be altered and is just for your reference.

1. Press and hold the Info/menu button to enter the menu setting.
2. Rotate the Tuning control until VER 1.XX appears on the display to view the software version of your radio.

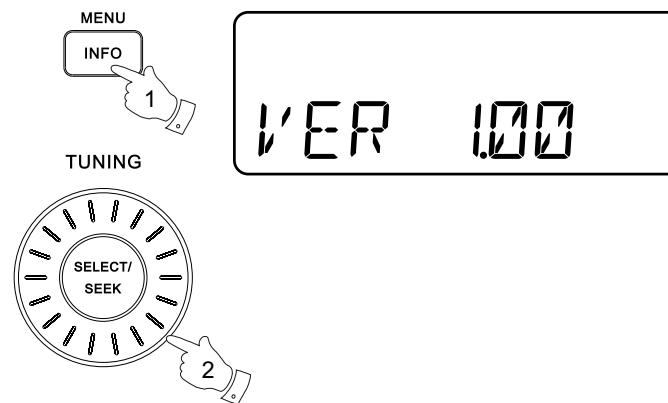

Note:

Most of the remote control operation of WR-5 is the same with operation on the radio, except some functions like the following:

1. Mute function: press the mute button on the remote control, and the receiver will be muted and MUTE will appear on the display. To disable the mute function, press the mute button again.
⊖
2. Repeat function: press the ⊖ button while the radio is playing your iPod to choose from repeating one file, repeating all files or turning off repeat function. Press the ⊕ button to choose random repeat mode.



Specifications

Power Requirements

Mains AC 12V~/1.6A

Frequency Range

FM: 87.5 – 108 MHz

AM: 520 – 1710 kHz (US version)

522 – 1629 kHz (European version)

Back-up Battery

2 x 1.5V Size "AAA" / UM-4 / LR3

Circuit Features

Loudspeaker 2.25" 6 ohm x 2 full range

Output Power: 5W+5W

Headphone socket 3.5mm dia stereo

Auxiliary socket 3.5mm dia stereo

Line out socket 3.5mm dia stereo

Aerial System: FM telescopic antenna

GB



If at any time in the future you should need to dispose of this product please note that: Waste electrical products should not be disposed of with household waste. Please recycle where facilities exist. Check with your Local Authority or retailer for recycling advice. (Waste Electrical and Electronic Equipment Directive)

Free Manuals Download Website

<http://myh66.com>

<http://usermanuals.us>

<http://www.somanuals.com>

<http://www.4manuals.cc>

<http://www.manual-lib.com>

<http://www.404manual.com>

<http://www.luxmanual.com>

<http://aubethermostatmanual.com>

Golf course search by state

<http://golfingnear.com>

Email search by domain

<http://emailbydomain.com>

Auto manuals search

<http://auto.somanuals.com>

TV manuals search

<http://tv.somanuals.com>