

SANGEAN

SANGEAN

ATS-808A



FEATURES

- **Continuous Tuning** permits reception of more stations than ever before without any break on LW, MW or SW bands.
- **Fast response, Three Color LCD** indicates station frequency in large easy-to-read numbers, including dual time, Memory location, signal strength and battery life.
- **Direct Access Keypad** permits instant tuning of any desired frequency from 87.5 to 108MHz on the FM band and from 150 to 29,999 KHz on the AM band.
- **Fifty-Four Memory Pre-sets** offer instant access to your favorite stations on LW, MW, FM and SW.
- **Supplemental Tuning Controls** allow for maximum clarity of the selected frequency.
- **Dual Time Setting** allows you to pre-set your local time and UTC WORLD Time, or any two time zones with instant recall.
- **Scanning Circuit** permits you to check various frequencies on a certain bandwidth and lock on to it at random.
- **Cancel Button** allows you to instantly change incorrect information keyed into the microprocessor.
- **Band Select Buttons** offer instant selection of any desired frequency bandwidth on SW.
- **Tuning Speed Selector Switch** permits you to tune stations at either a fast or slow speed.
- **Adjustable Sleep Timer** allows you to fall asleep to music or other programming.
- **Standby Mode** turns on the radio automatically at a pre-set time either by buzzer or radio program.
- **Stereo Headphone Jack** permits reception of FM multiplex stereo broadcasts.
- **Folding Stand** allows you to position the radio either vertically or at an angle while maintaining stability.

CONTROL LOCATIONS

1. Telescopic antenna
2. Sleep Timer
3. Time Set
4. Dual Time Button
5. Dual Time Set
6. LCD Display
7. Power On/Off Button
8. Rotary Tuning Knob
9. Manual Tuning/Auto
10. Standby Button
11. Frequency Select Button
12. Meter Select Button
13. Band Selectors
14. Numeric & Bandwidth Buttons
15. Cancel Button
16. Enter Command Button
17. Memory Entry Button
18. External Antenna Jack
19. DX/Local Switch [AM Sensitivity]
20. FM Stereo/Mono Mode Selector
21. Stereo Headphone Jack
22. DC input Jack/6 Volts

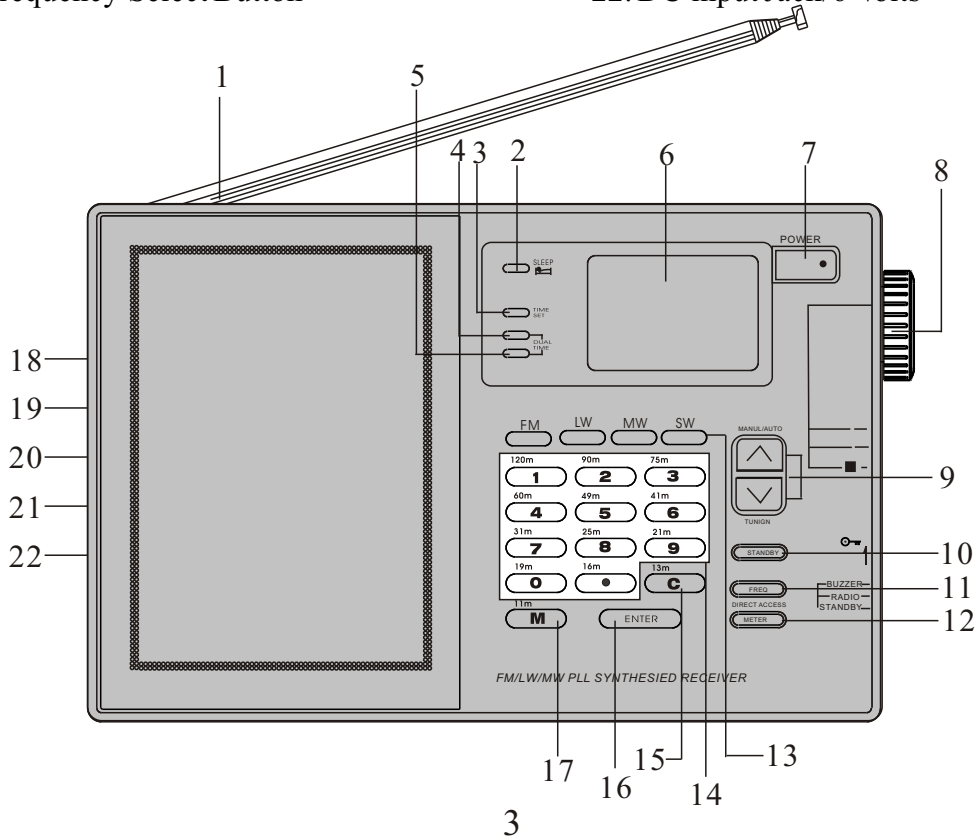

- 23. 9KHz/10KHz Step Switch
- 24. High/Low Tone Switch
- 25. Volume Control
- 26. Tuning Speed Control
- 27. Lock Switch
- 28. Alarm Set Selector

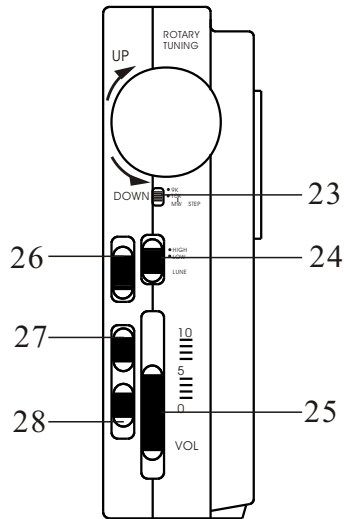

- 29. Folding Stand
- 30. Back-up Battery Compartment
- 31. Main Radio Battery Compartment

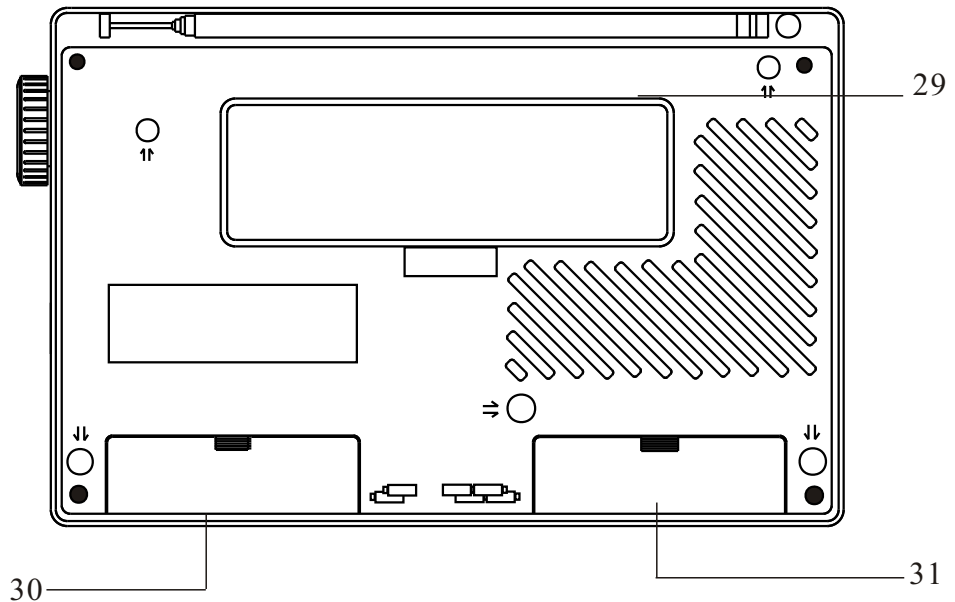

CHOOSING A POWER SUPPLY

You can operate the receiver using:

- Six Alkaline AA Batteries.
- Household AC [With optional AC adaptor]
- 12 Volt DC Automobile Battery [With optional DC adaptor]

USING BATTERIES

1. Press latch marked "OPEN" on both battery compartment covers in the direction of the arrow and lift off cover.
2. Insert 4 "AA" batteries in the "Radio" compartment and 2 "AA" batteries in the "Back-up" compartment. Be sure to position them as illustrated on the back of the radio, and on top of the "lift-out" ribbons for easy removal.
3. Replace both battery compartment covers over their respective compartments and press down until you hear it snap closed.

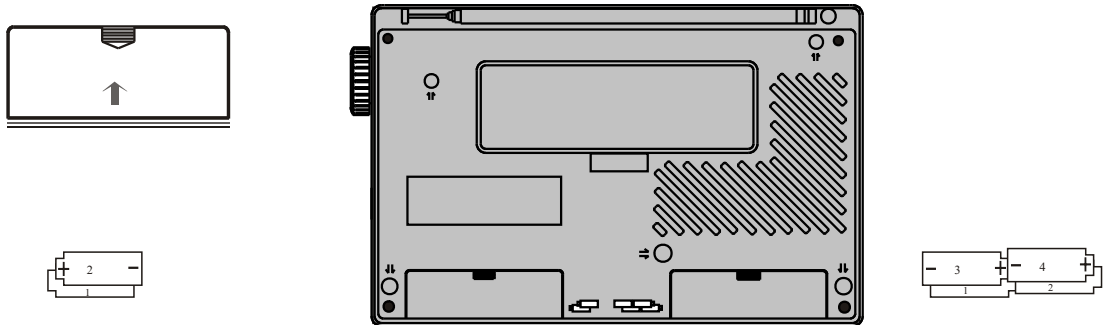

NOTE

Whenever the radio is turned off, the battery indicator will flash for about five seconds to show battery condition.

If the indicator falls below #2, the 4 "MAIN" AA" batteries should be replaced.

When the "MAIN" batteries become exhausted, the micro-processor will automatically be powered by the "BACK-UP" batteries.

When the display on the micro-processor begins to fade, replace the 2 "AA" batteries in the "BACK -UP" circuit. Before you replace these batteries, be sure to install the 4 "AA" batteries in the "MAIN" circuit to prevent total memory loss.

USING HOUSE CURRENT [AC]

The receive may be power by AC current using the AC adaptor (not included). Insert the small barrel shaped plug into the jack on the side of the radio marked “DC IN 6V” .Plug the other end of the adaptor into a standard household outlet. Whenever AC is used, the batteries are automatically disconnected.

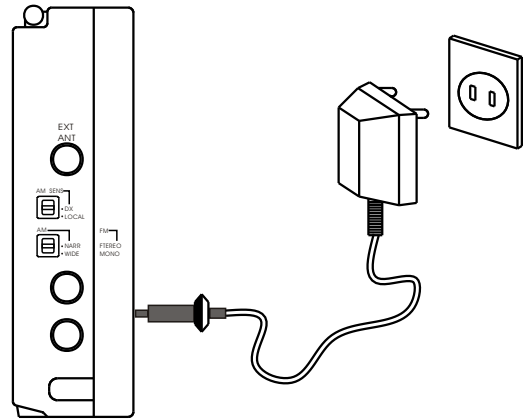

PRELIMINARY SETTINGS

SETTING THE CLOCK

The time is displayed in the 24 hour mode since most shortwave stations operate according to Greenwich Mean Time. This is the standard that is used throughout the world.

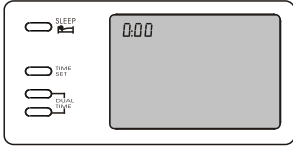
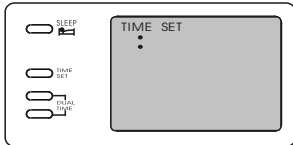
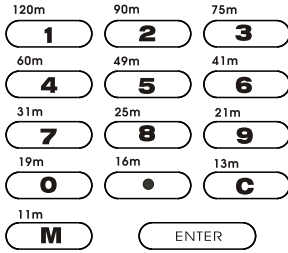
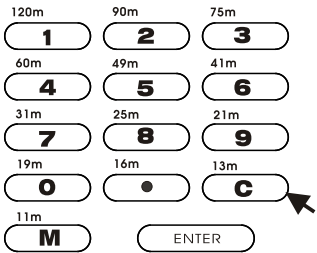
<p>The clock will start when 4 AA batteries are installed. The display shows "0:00"</p>	
<p>1. Press "TIME SET". "0:00" disappears & for 12 seconds "TIME SET" flashes.</p>	
<p>2. While "FLASHING" set the correct time by pressing the numbered buttons. As you press the corresponding button the number shows up on the LCD display</p>	
<p>3. If you press the wrong number, press the "C" [CANCEL] button which deletes one number at a time. Repeat step #2 again.</p> <p>NOTE Time can only be adjusted when "TIME SET" is in flashing mode.</p>	

4. Now press button marked "ENTER" .

Display shows hours and minutes.

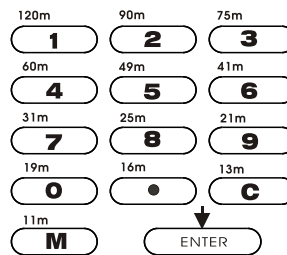

SETTING DUAL TIME

A second time zone can be programmed into this unit such as your home time if you are traveling, or Greenwich Mean Time for instant access to short-wave broadcasts or the local time where ever you may be.

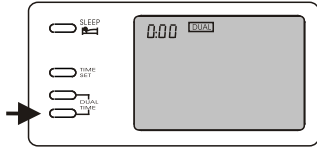
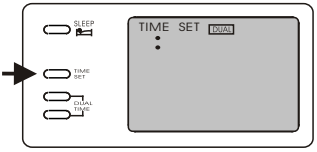
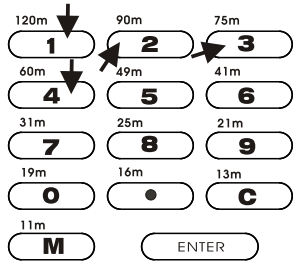
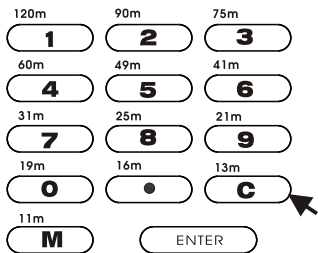
<p>1. Press lower "DUAL TIME" button and the display will show "DUAL".</p>	
<p>2. Press "TIME SET" button. Clock time will disappear & "TIME SET" will flash for 12 seconds.</p>	
<p>3. While "FLASHING" set the correct time by pressing the numbered buttons. As you press the corresponding button the number shows up on the LCD display.</p>	
<p>4. If you press the wrong number, press the "C" [CANCEL] button which deletes one number at a time. Repeat step #3 again.</p>	

5. Now press button marked "ENTER",
Display shows hours and minutes.

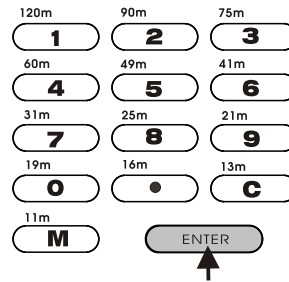

6. By pressing the lower "DUAL TIME"
button now, the LCD display will once
again show the clock time.

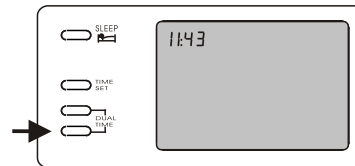

7. To verify "DUAL TIME", press the upper
"DUAL TIME" button to display your
"OTHER" time zone. When you release
the button the clock will show your
current local time.

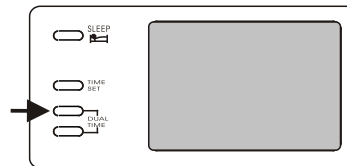

BAND SELECTION

There are four band selector buttons located just beneath the LCD display.

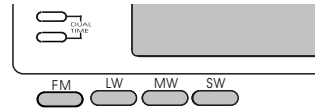

BAND	FREQUENCY RANGE	PROGRAM TYPE
FM	87.5~108 Mhz	Standard FM
LW	150~519 KHz	Longwave
MW	520~1710 KHz	Standard AM
SW	1.711~29.999 Mhz	SW/13 Sub-Bands

1. Turn radio on by pressing "POWER" button. Display will show last band and frequency selected.

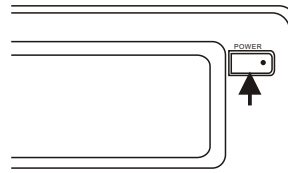

2. By pressing any one of the four band selector buttons the display shows the band selected and a random frequency within that band.



NOTE

When you select SW you only have to press the button marked "METER", and then any one of the numbered buttons depending upon what band you want to listen to. The display will show the band you selected and a random frequency within that band.

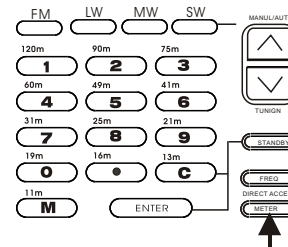

TUNING MODE

ADJUSTING THE ANTENNA

Locate the band you want to listen to in the following chart and adjust the antenna as indicated.

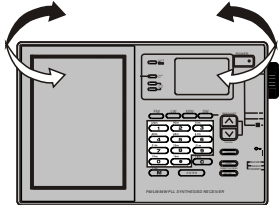
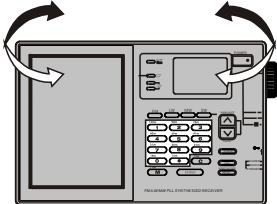
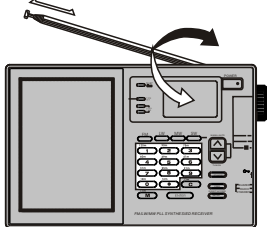
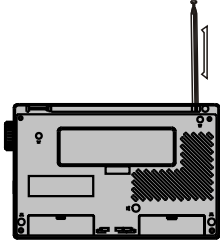
BAND	FREQUENCY RANGE	ANTENNA TYPES	ILLUSTRATION
MW	520-1710 KHz	INTERNAL Rotate radio for best reception	
LW	150-519 KHz	INTERNAL Rotate radio for best reception	
FM	87.5-108 Mhz	TELESCOPIC Extend antenna all the way & rotate it for best reception	
SW	1.711e~29.999 Mhz	TELESCOPIC Extend antenna all the way for best reception & do not rotate	

You may select any frequency using four different turning methods:

- **Direct turning**
- **Manual Tuning**
- **Scan Turning**
- **Memory Tuning**

DIRECT TUNING

You may "KEY IN" a specific band (120m, 49m, 16m) by pressing the appropriate button. The exact station is then selected by pressing the buttons corresponding to the station frequency.

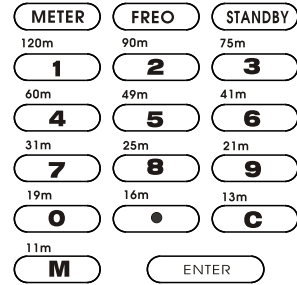

Example: To tune 100.70 Mhz on the FM band, follow this procedure:

1. Press the POWER button to turn on the radio.

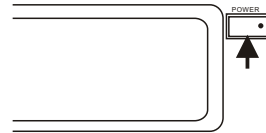

2. Press the button marked, FREQ ("Frequency")

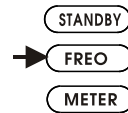

3. Press the corresponding buttons, marked [1], [0], [0], [•], [7], [0]. That exact frequency will now show up in the display.

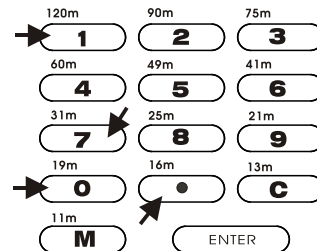

4. Press the button marked “ENTER” within twelve seconds. The frequency and band will now show up in the display. The SIGNAL STRENGTH will also show.

NOTE: Be sure to press the decimal point [•] in 100.70MHz, otherwise the display will show “SW” , [10.070 MHz] automatically.

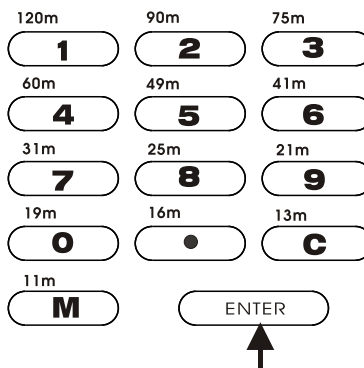

5. Extend the antenna all the way and rotate for best FM reception.

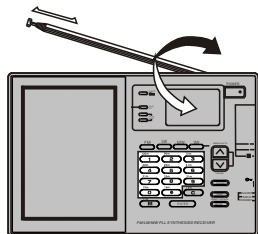

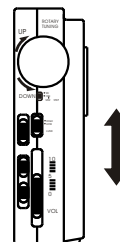

6. Adjust the VOLUME and TONE controls for the desired sound.

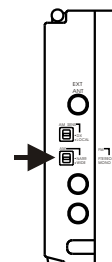

7. When selecting a stereo FM station make sure the FM mode switch is in the STEREO position.

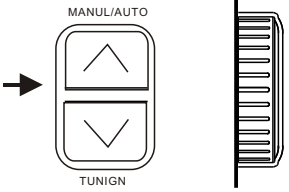
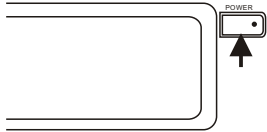

MANUAL TUNING

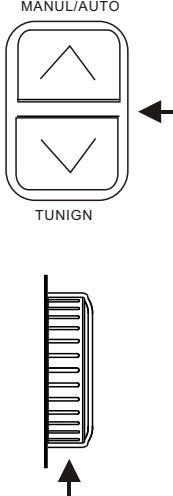
<p>To select a station you do not know the frequency of, use the MANUAL TUNING [Δ] [∇] buttons or the ROTARY TUNING control on the side of the radio.</p>	
<p>1. Press the POWER button to turn on radio.</p>	
<p>2. Select a band.</p>	
<p>3. Press repeatedly the [Δ] or [∇] buttons to reach a desired frequency. Press and hold the [Δ] or [∇] buttons for at least a half second or more to change frequencies rapidly.</p> <p>OR Rotate the TUNING knob until the desired frequency or station is tuned in using the SIGNAL STRENGTH INDICATOR in the display for the best reception.</p>	

NOTE

When you repeatedly press the [Δ] or [V] buttons, the frequencies change in increments of:

FM : 50 KHz (or 100 KHz)

LW : 9 KHz

MW : 9 KHz or 10 KHz

SW : 5 KHz

Turning the ROTARY TUNING knob with the TUNING SPEED CONTROL set on FAST will change each band as follows:

FM : 100 KHz

LW : 9 KHz

MW : 9 KHz/10 KHz

SW : 5 KHz

When set on slow, the frequencies change as follows:

FM : 50 KHz

LW : 1 KHz

MW : 1 KHz

SW : 1 KHz

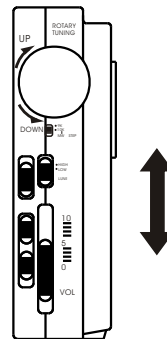

With the TUNING SPEED CONTROL set on LOCK, ROTARY TUNING will not function.

4. Adjust the VOLUME and TONE controls as you like.

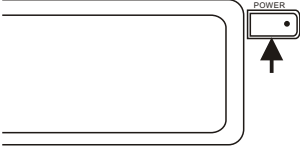

SCAN TUNING

Use scan tuning to quickly locate a station or to monitor several stations within a specific band.

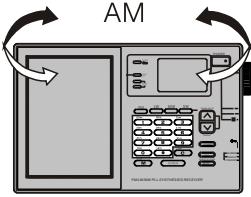
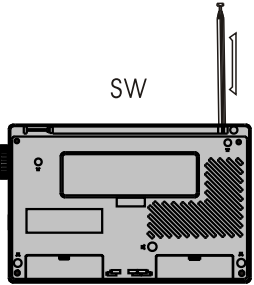
<p>1. Turn on radio by pressing POWER button.</p>		
<p>2. Select a band.</p>		
<p>3. Adjust antenna or radio position depending on selected band.</p>	 <p>AM</p>	 <p>SW</p>

4. Press and hold the (Λ) or (V) buttons for at least a half second or more and the radio will scan all the frequencies in that band, and will stop automatically each time it lands on an active station. Signal strength is recorded on the SIGNAL STRENGTH INDICATOR.

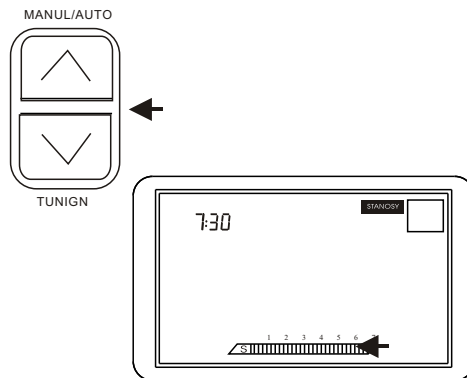

5. Press and hold the (Λ) or (V) buttons again to resume scanning. When you reach the upper or lower limits of the band, the scanning starts all over again as long as the button is depressed once more.

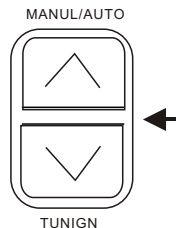

6. Adjust the VOLUME and TONE controls as you like.

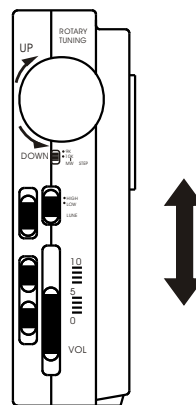

MEMORY TUNING

You may store up to eighteen different frequencies on the SW/FM bands and up to nine different frequencies on each of the other bands for instant selection of your favorite stations.

Storing a Frequency

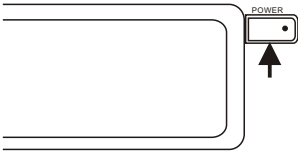
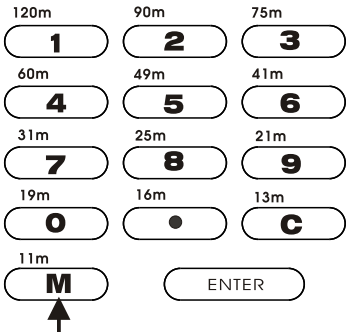
<p>1. Press POWER button to turn on radio</p>	
<p>2. Turn to any frequency using any of the previously mentioned tuning methods.</p>	
<p>3. Press the button marked "M" for MEMORY it will start flashing in the display for 15 seconds during which time press any of the buttons marked 1 - 9 on the keyboard and your station will be stored in that memory position. For the SW/FM bands frequencies press 1-9 and then 01-09 for a total of 18 memory positions. The display will show the memory position the station is now stored in. You may store your stations in any sequence you want. You do not have to start with #1.</p>	

RECALLING A FREQUENCY

1. Press POWER button to turn on radio.

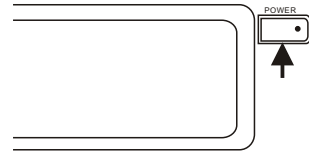

2. Select a band in which a station is stored that you want to recall.



3. Press any of the NUMBERED buttons for a desired station and the radio will instantly tune to it and display that frequency and the MEMORY position number. **If you want to change to another stored station, just press any other numbered button for access.**

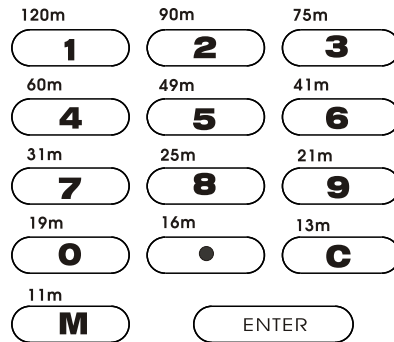

CLOCK RADIO OPERATION

With this receiver you can fall asleep to your favorite station by pressing the SLEEP button, or wake you to the morning news, or an alarm buzzer. **Make the following settings with the POWER off!**

Setting the Alarm

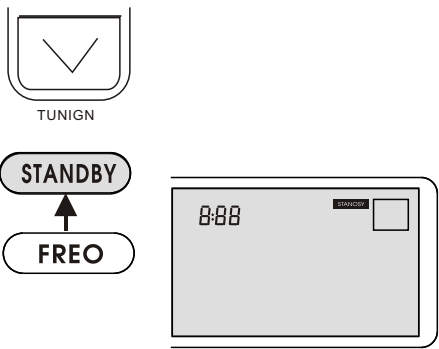
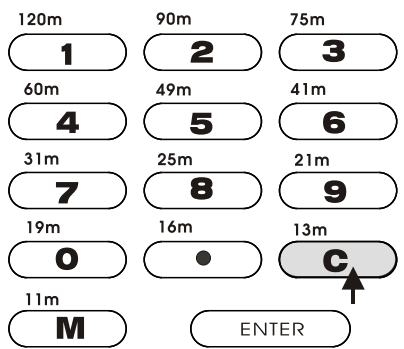
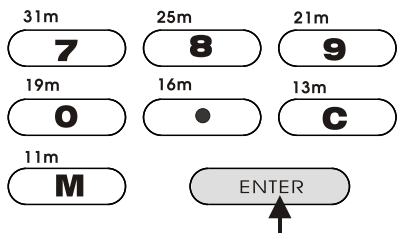
<p>1. Press STANDBY button so display shows 0:00. STANDBY will flash for 15 seconds.</p>	 <p>TUNIGN</p> <p>STANDBY</p> <p>FREO</p> <p>8:88</p>
<p>2. Press the numbered buttons to activate turn-on time using 24 hour time, in hours and minutes. For example, to set the radio to turn on at 1:30 PM each day, press the buttons until the display shows 13:30. If the wrong number was keyed-in, delete it by pressing the CANCEL button marked "C". One time for each number. Then press the correct number for the time you want.</p>	 <p>120m 90m 75m</p> <p>1 2 3</p> <p>60m 49m 41m</p> <p>4 5 6</p> <p>31m 25m 21m</p> <p>7 8 9</p> <p>19m 16m 13m</p> <p>0 • C</p> <p>11m M ENTER</p>
<p>3. When you reach your desired turn-on time, press ENTER, STANDBY stops flashing, your turn-on time is locked in. For 2 to 3 seconds, the clock returns to the current time automatically.</p>	 <p>31m 25m 21m</p> <p>7 8 9</p> <p>19m 16m 13m</p> <p>0 • C</p> <p>11m M ENTER</p>

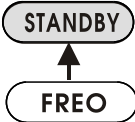
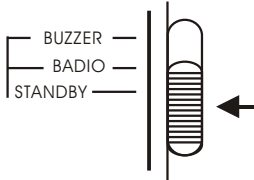
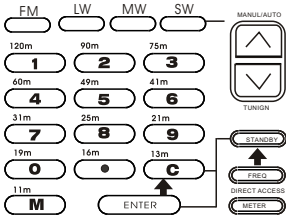
<p>4. To verify STANDBY button again. Press STANDBY once more and the clock returns to the current time.</p>	
<p>5. You may select radio or buzzer alarm to wake you by setting STANDBY: BUZZER/RADIO selector switch on the side of the radio.</p>	
<p>6. To cancel the ALARM time, press STANDBY and "C" [CANCEL] button.</p>	

Setting the sleep Timer

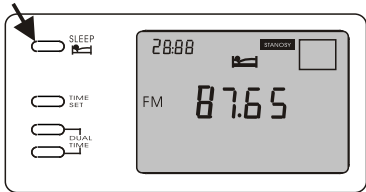
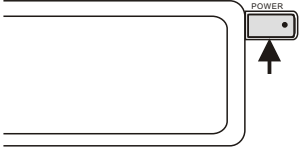
<p>1. The sleep timer allows the user to set the auto-shut off in 30 or 15 minutes decrements from 90 minutes to 15 minutes.</p> <p>To set auto-shut off, press SLEEP button 2, LCD will show frequency read-out, 60 (auto-shut off time) and the icon.</p> <p>Press SLEEP button to change the required auto-shut off time, release the button when shut of time desired is reached.</p>	
<p>2. TO turn off the radio before it automatically turns itself off, press the POWER button.</p>	

MISCELLANEOUS CONTROLS

In addition to standard tuning methods described previously, use the following controls for special operations.

AM SENSITIVITY: DISTANCE/LOCAL SELECTIVITY SWITCH

This switch adjusts the receiver's sensitivity. When you listen to a strong station and the signal is slightly distorted, set the switch to the LOCAL position for best reception. For normal or weak stations, set the switch to the DX position for maximum sensitivity.

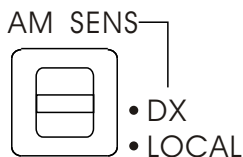

AM: NARROW/WIDE SELECTIVITY SWITCH

To reduce interference from adjacent stations, set this switch to the NARROW position and the interference will be suppressed. For maximum selectivity, leave the switch in the WIDE position.

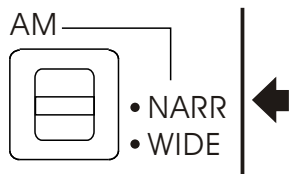

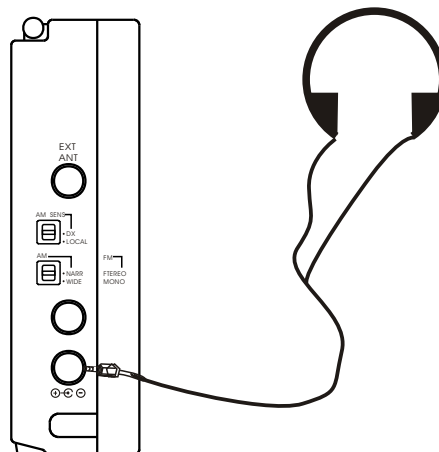

HEADPHONE USE

While not a control, you may consider using HEADPHONES to obtain the best audio clarity when listening to SW. Since many SW stations broadcast only marginal signals, using HEADPHONES will enable you to distinguish between the signal and the noise usually encountered at night. Be sure that the HEADPHONES terminate in a 1/8 inch plug, which is inserted into the HEADPHONE jack located on the left side of the radio, marked with the symbol . When the HEADPHONES are plugged in, the speaker is muted.



Because the radio is capable of receiving FM multiplex stereo, the HEADPHONES should be stereo capable so that your listening enjoyment will be enhanced. When listening to stereo FM, be sure that the FM: STEREO/MONO switch is set to the STEREO position. This switch is located on the left-hand side of the radio, just above the HEADPHONE jack.

LOCK SWITCH USE

Using the LOCK switch prevents unauthorized operation of the radio and will also prevent the station you are listening to from being changed. When the LOCK switch is moved to its up  position, the POWER button and TUNING controls are completely disabled. If the radio is on when the LOCK switch is moved to its up  position, you will not be able to turn it off. If the radio is off, with the LOCK switch in its up  position, you will not be able to turn it on. This will also prevent it from being turned on by accident, when packed in a suitcase or attache case. To release the LOCK switch, simply move the switch down.

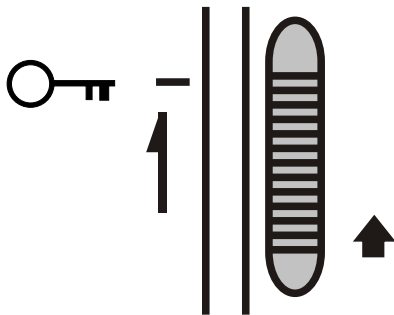

EXTERNAL ANTENNA USE

To obtain optimum performance from this unit, especially when listening to SW an external antenna should be used to the EXTERNAL ANTENNA ADAPTER and then plugged into the EXTERNAL ANTENNA jack located on the left side of the radio.

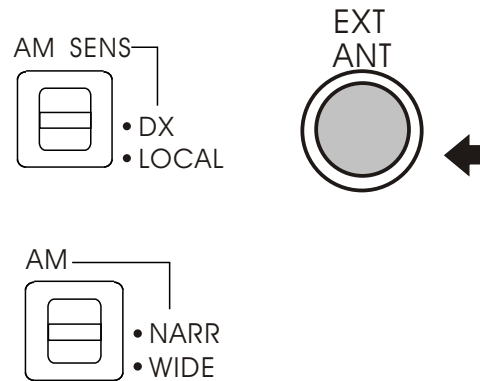



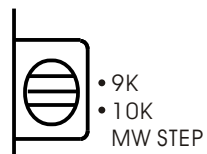

MW STEP SELECTOR SWITCH

Located on the right side of the unit, just beneath the ROTARY TUNING knob is a switch marked, MW STEP: 9K/10K. This switch selects the incremental frequency STEPS for the MW band, depending upon your geographic location. In the USA, 10K STEPS are used, so the switch should be set to its lowest position. In other parts of the world where they use 9K STEPS, move the switch to the uppermost position.



CARE AND MAINTENANCE

This receiver is an example of superior design and craftsmanship. The following suggestions will help you care for the receiver so that you can enjoy it for years.

<p>Keep the product dry. If it does get wet, wipe it dry immediately. Liquids might contain minerals that can corrode the electronic circuits.</p>	
<p>Use and store the product only in normal temperature environments. High temperatures can shorten the life of electronic devices, damage batteries, and distort or melt plastic parts.</p>	
<p>Handle the product gently and carefully. Dropping it can damage circuit boards and cases and can cause the product to work improperly.</p>	
<p>Keep the product away from dust and dirt, which can cause premature wear of parts.</p>	

Wipe the product with a dampened cloth occasionally to keep it looking new. Do not use harsh chemicals, cleaning solvents, or strong detergents to clean to product.



Use only fresh batteries of the recommended size and type. Always remove old or weak batteries. They can leak chemicals that destroy electronic circuits.



Modifying or tampering with the product's internal components can cause a malfunction and might invalidate the product's warranty.

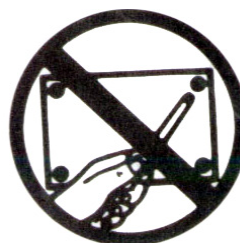

SPECIFICATIONS

Semi conductors: 1 LSI, 9 IC,
8FET. 42 Transistors
41 Diodes.

Circuit:

FM : Heterodyne
AM (LW, MW, SW) Double-conversion heterodyne

Frequency range:

FM: 87.5-108 MHz
LW: 150-519 Khz
MW: 520-1710 KHz
SW: 1.711~29.999 Mhz

in which divided into 13 shortwave bands

120M 2.300 - 2.495 MHz

90M 3.200 - 3.400 MHz

75M 3.900 - 4.000 MHz

60M 4.750 - 5.060 MHz

49M 5.900 - 6.200 MHz

41M 7.100 - 7.350 MHz

31M 9.400 - 9.990 MHz

25M 11.600 - 12.100 MHz

21M 13.570 - 13.870 MHz

19M 15.100 - 15.800 MHz

16M 17.480 - 17.900 MHz

13M 21.450 - 21.750 Mhz

11M 25.600 - 26.100 MHz

Antennas:

LW/MW built-in Ferrite bar Antenna
SW Telescopic Antenna or External Antenna (not included)
FM Telescopic Antenna

Output: Nominal 440 mW at 10% T.H.D.

Jacks:

1. DC jack for external power (6V)
2. Headphone jack - 3.5 \emptyset for mini stereo headphones
3. AM Ext. Ant. Jack.

-
- Power sources:**
1. For Power when not playing radio
UM 3 (AA size) battery x 2pcs
for memory/clock back-up (3V)
 2. For Power to play radio:
 1. UM 3 (AA size) battery 4pcs
 2. AC adaptor 6V/300 mA center negative

Dimension: 196(L) x 125(H) x 36(T) mm

Weight: 600 g

Accessories: Stereo earphones, Carrying pouch.

STATION LOG

For those of you who would like to log your favorite stations, a convenient card is provided with your receiver which is simply inserted under the folding stand on the back of the radio. Please see illustration for complete detail.

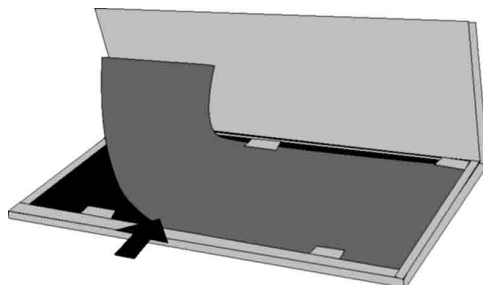

Free Manuals Download Website

<http://myh66.com>

<http://usermanuals.us>

<http://www.somanuals.com>

<http://www.4manuals.cc>

<http://www.manual-lib.com>

<http://www.404manual.com>

<http://www.luxmanual.com>

<http://aubethermostatmanual.com>

Golf course search by state

<http://golfingnear.com>

Email search by domain

<http://emailbydomain.com>

Auto manuals search

<http://auto.somanuals.com>

TV manuals search

<http://tv.somanuals.com>