

Optimum Reliability in Motion Control

SANDEX- α Alpha Series

SERVO DRIVE TYPE OPERATION AND MAINTENANCE MANUAL

ALPHA SERVO DRIVE INDEX

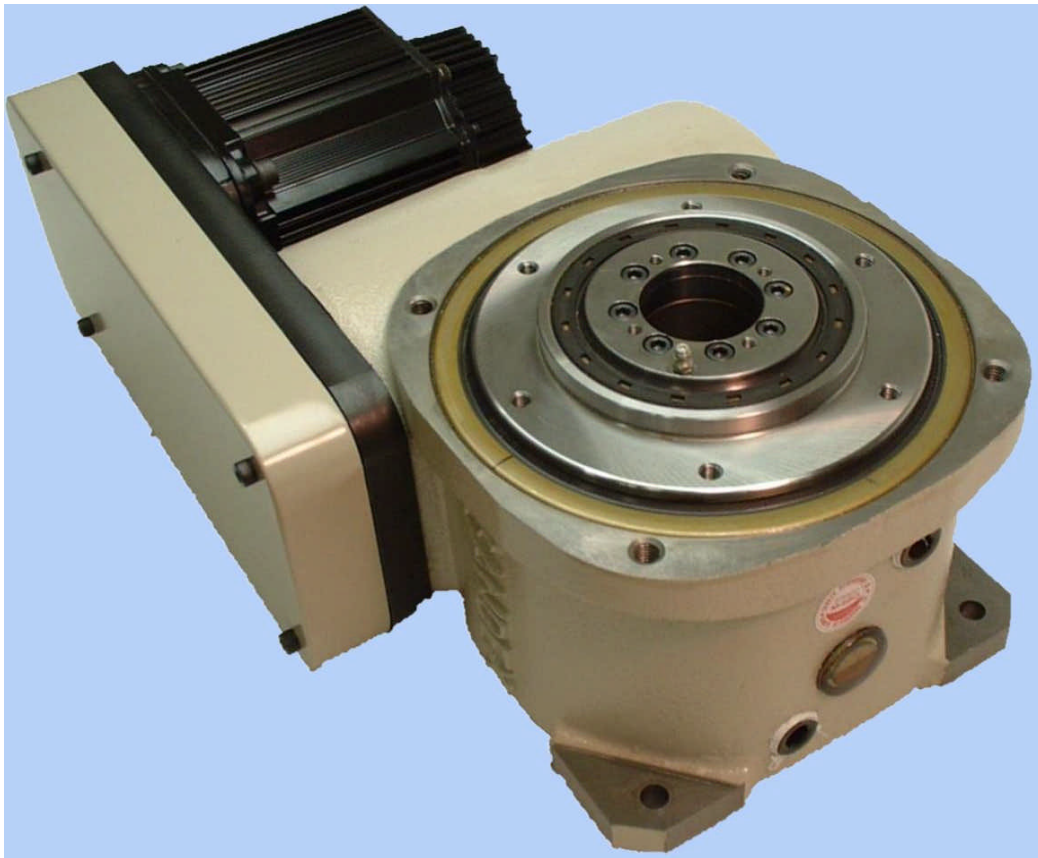

11AR



Preface

Thank you for purchasing a SANDEX product. These instructions cover installation procedures, linkage procedures, and maintenance precautions to be followed to ensure maximum performance from this product. Please read these instructions carefully before installing or trial operating of this product. After unpacking, make sure the product delivered fits your ordering specifications.

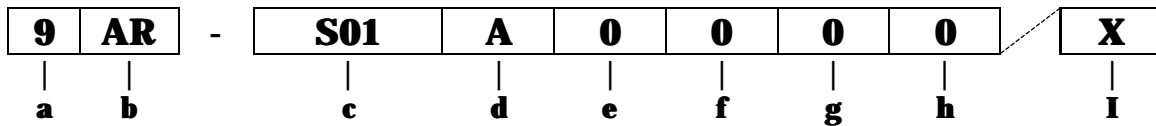

a: Size

Shaft to shaft distance

Availability: 7=70mm, 9=90mm, 11=110mm, and 15=150mm

b: Model

AR=Alpha series Roller drive type

c: Roller Drive

Type of roller drives

Availability:

S01=Roller gear ratio; 1/12, Mounting position; 1

S02=Roller gear ratio; 1/12, Mounting position; 2

S05=Roller gear ratio; 1/12, Mounting position; 5

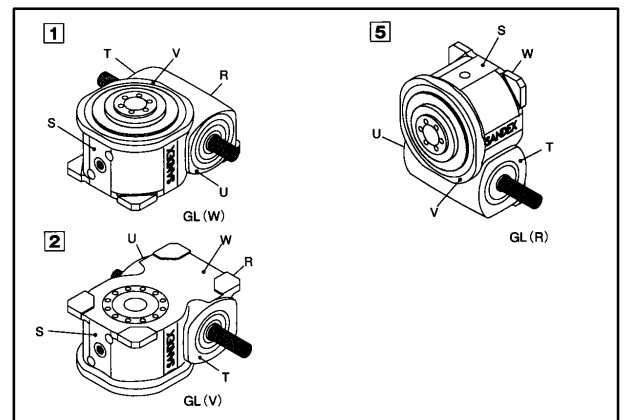

April 2002

d: Motor & Bracket

Type of Motor & Bracket

Availability:

A=Standard (Pulley ratio; 7&9AR=1/3, 11&15AR=1/2)

e: Motor Driver

Type of Motor Driver

Availability:

- 0=Single phase 200 to 230VAC for 7AR & 9AR
- 1=Three phase 200 to 230VAC for 11AR & 15AR
- 2=Three phase 380 to 480VAC for 11AR & 15AR

f: Controller

Type of controller

Availability:

0=Standard

x=Special requirements

g: Cable

Type of cables

Availability:

0=3 meters length, w/o conduit

1=5 meters length, w/o conduit

2=10 meters length, w/o conduit

3=15 meters length, w/o conduit

4=3 meters length, w/ conduit

5=5 meters length, w/ conduit

6=10 meters length, w/ conduit

7=15 meters length, w/ conduit

Y=Connectors Only

h: Control Software

Type of control software

Availability:

0=Standard

x=Special requirements

I: Special Instructions



Include the symbol in case of special orders











No symbols= Standard

Safety Precautions

Symbols to ensure the safe and proper use of the Variax

The following symbols are used in this manual where safety precautions must be observed. Read and understand the meanings of these symbols to ensure the safe and proper use of Variax. Failure to obey these precautions can cause machine problems, accidents, or other unexpected behavior.

 Warning	Indicates a potentially hazardous situation, which may result in death or serious injury.
 Caution	Indicates a potentially hazardous situation, which may result in minor or moderate personal injury or damage to the equipment.

Meaning of symbols	
	<p>In general, this symbol alerts you to an action or operation that you must not do.</p> <div style="display: flex; justify-content: space-around; align-items: center;"> <div style="text-align: center;">  General prohibition </div> <div style="text-align: center;">  Do Not Touch </div> </div>
	<p>In general, this symbol alerts you to the possibility of damage to you or your equipment.</p> <div style="display: flex; justify-content: space-around; align-items: center;"> <div style="text-align: center;">  General Warning </div> <div style="text-align: center;">  Electrical Hazard </div> <div style="text-align: center;">  Pinch Point </div> <div style="text-align: center;">  High Temperature </div> </div>
	<p>This symbol alerts you to actions that are reserved for qualified service personnel only</p> <div style="display: flex; justify-content: space-around; align-items: center;"> <div style="text-align: center;">  Mandatory Action </div> <div style="text-align: center;">  Electrical Grounding </div> </div>

Contents

PREFACE

SAFETY PRECAUTIONS

SAFETY PRECAUTIONS

SYMBOLS TO ENSURE THE SAFE AND PROPER USE OF THE VARIAX

1. OPERATING THEORY

2. HANDLING YOUR SANDEX

2.1 IDENTIFYING ALPHA SERVO LAYOUT

3. TRANSPORTATION AND ENVIRONMENT

3.1 SHIPPING CONDITION

3.2 TEMPERATURES

3.3 MOISTURE

3.4 DUST

4. INSTALLATION

4.1 CASING MAIN BODY

4.2 DRIVER

4.2.1 STORAGE CONDITIONS

4.2.2 INSTALLATION SITE

4.2.3 ORIENTATION

4.2.4 WIRING THREE PHASE 200VAC

4.2.5 WIRING THREE PHASE 400VAC

4.3 CONTROLLER

4.3.1 MOUNTING THE MP940

4.3.2 CONNECTION OF PERIPHERAL DEVICES

4.4 WIRING

4.4.1 I/O CIRCUITS

4.4.2 CONTROLLER I/O CONNECTIONS

5.OPERATION

5.1 SETTING ENCODER ZERO POSITION

5.2 SETTING ZERO POSITION (STARTING POSITION)

5.3 I/O TIMING CHART WHILE IN JOG MODE

5.4 I/O TIMING CHART WHILE IN AUTOMATIC MODE

5.5 INDEXING TIME VS. STOPS CHART

3

3

6

7

7

8

8

8

8

8

10

10

10

10

11

11

12

13

14

14

15

16

17

18

19

19

19

20

21

22

5.6 DATA SWITCH SETTINGS	22
6. HANDLING PROCEDURES FOR THE OUTPUT SHAFT	23
6.1 TABLE TYPE OUTPUT	23
7. LUBRICATION	24
4.5 PURPOSE OF LUBRICATION	24
7.2 OIL SELECTION PRECAUTIONS	24
7.3 LUBRICATING OIL VISCOSITY'S	25
7.4 RECOMMENDED LUBRICATING OIL	25
8. FILLING AND REPLACING LUBRICATING OIL	26
8.1 REFILLING LUBRICATING OILS	26
8.2 OIL REPLACEMENT SCHEDULE	26
9. LUBRICATION GREASES	27
9.1 SUPPLYING LUBRICATING GREASE	27
10. REPAIRS AND MAINTENANCE	28
10.1 YASKAWA DRIVER AND CONTROLLER DISPLAY CODES	29
10.2 TROUBLESHOOTING PROCEDURES (1)	31
10.3 TROUBLESHOOTING PROCEDURES (2)	32

1. *Operating theory*

SANDEX units operate based on the following principal. A globoidal cam is mounted onto the input shaft. This cam interlocks with the turret portion of the output shaft. The turret has cam followers along its perimeter, which are in contact with the tapered ribs on the cam. This contact or pressure is called the preload. Turning the input shaft rolls the cam followers along the rib surfaces thereby rotating the turret according to the curve of the cam. The turret is motionless when the ribs are parallel with the edges of the cam although the cam followers stay in motion.

Two of three cam followers are always kept pressed against the tapered ribs to ensure an accurate transmission of rotation. Any backlash or movement between the tapered rib surfaces and cam followers can cause vibrations, noise, and also damage the cam and cam follower surfaces. Backlash can be completely eliminated by rotating the eccentric flange that holds the input shaft, and minimizing the distance between the input and output shaft.

Explanation of terms used with indexing equipment

TERM	DEFINITION
Number of stops	The number of stops determined by the customer's programming. A predetermined number of stops have been programmed into the controller (1-16) CW or CCW.
Index angle	The index angle is dependant on the number of stops.
Dynamic Torque output rating(Top)	The maximum torque that can be applied on the output shaft during indexing phases. Directly related to machine life.

2. Handling your SANDEX

Over 90% of the mechanical failures reported with roller gear cam equipment comes from careless or improper handling. Improper handling not only reduces the life of your SANDEX unit, it can also affect the performance of both the SANDEX unit and your machine.

2.1 Identifying Alpha Servo layout

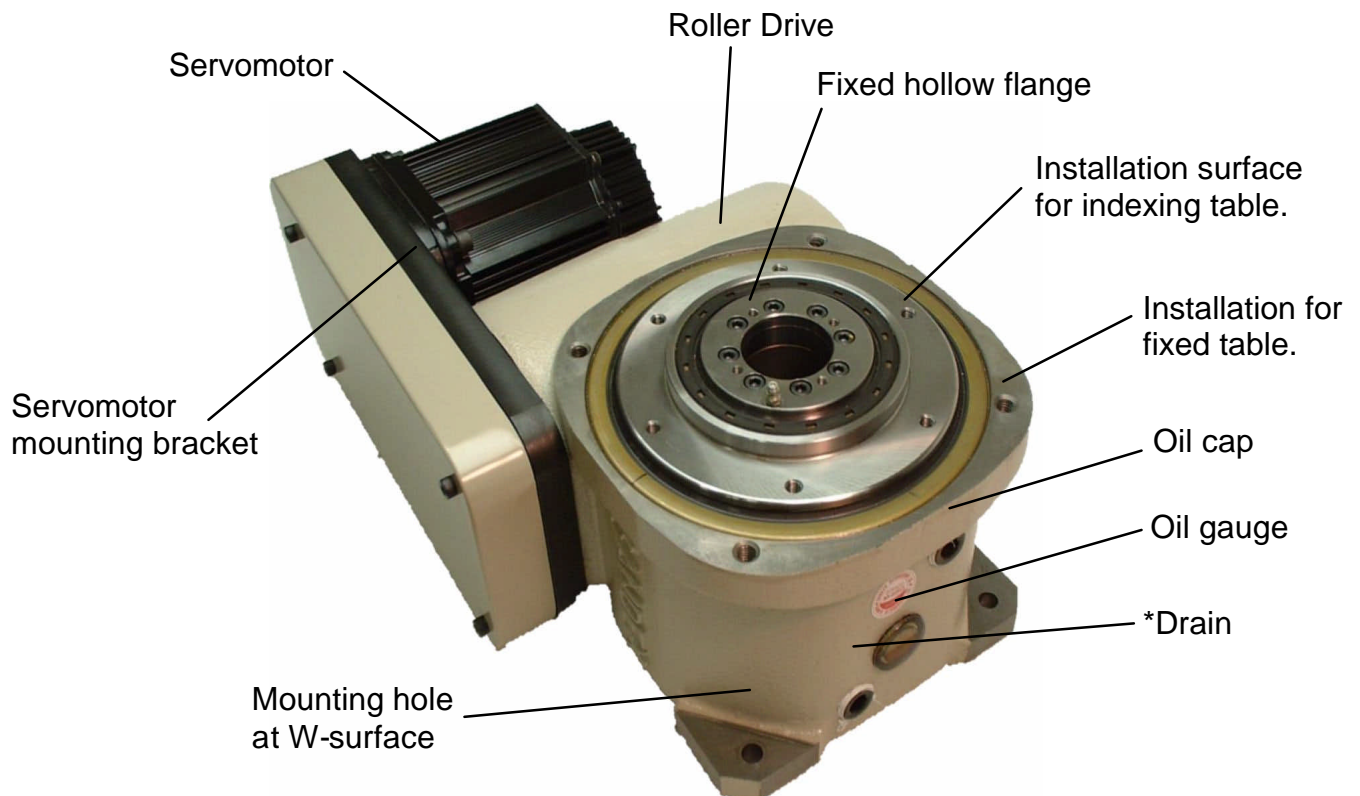

2.2 Handling your Alpha Servo

- (1) Torsion and deflection within the rotation transmission system
- (2) Frictional torque within the rotation transmission system
- (3) Frequent load change
- (4) Usage under rust stimulant conditions such as water, acid, or alkali
- (5) Usage in dusty areas
- (6) Electrical currents
- (7) Improper maintenance and repairs
- (8) Mounting areas with insufficient rigidity

3. Transportation and Environment

3.1 Shipping condition

- (1) All SANDEX products are thoroughly inspected after the final assembly. Only those products that pass this inspection are shipped.
- (2) Before shipped, each SANDEX unit is filled with lubrication oil in accordance to the customer's operating speed and environment.
- (3) A rust preventative solution is applied to the input /output shafts, key, and mounting surface. Vinyl tape is also used extensively to protect your SANDEX unit from scratches while transporting.

Remove the rust preventative solution with a light oil or thinner. Be careful not to let the light oil or thinner contact the oil seal. Never use thinner on or near the plastic sight gauge. This may cause severe clouding of the material.

3.2 Temperatures

- (1) For use between -20 to 0 degrees Celsius, (-4 to 32°F) use a lubricating oil with a lower viscosity than the recommended oil. This is because the dynamic viscosity of the lubricating oil rises in low temperatures and may not allow proper speed acceleration.
- (2) For use between 40 to 70 degrees Celsius, (104 to 158°F) use lubricating oil with a higher viscosity than the recommended oil. This is because the dynamic viscosity of the lubricating oil lowers in higher temperatures and reduce the life of the equipment.
- (3) For use between 70 to 100 degrees Celsius, (158 to 212°F) replace the oil seal and O-ring with a heat resistant synthetic rubber.

3.3 Moisture

Rust may occur in storage or if the main machine is washed with water. Water does not have to come directly into contact with the unit to cause rust. Moisture, condensation, and other sources of humidity can also cause rust.

To use under these conditions, the mounting surfaces and shafts of the unit must be painted, or otherwise rust proofed. Applying mineral oil or grease to the mounting surfaces has a rust preventative effect and should always be practiced.

In addition, if the unit is directly subject to water, the sealing devices on the input and output must be changed to a waterproof construction.

3.4 Dust

SANDEX units are generally built resistant to dust. This is because the roller gear cam mechanism is enclosed within its own housing, and then sealed off at the input and output with an oil seal. However, depending on the amount of dust or other foreign particles, the

Transportation and environment

oil seal may wear and thereby cause oil leaks. This is particularly evident when chemicals are used. Chemicals can also cause and or accelerate rust and corrosion. When using your SANDEX unit in dusty areas, you should consider using protective covers made from stainless steel or plastic.

If the location for your SANDEX unit is very dusty, the air outlet in the oil fill port may become an entrance into the housing. Placing an air filter over this port should prevent dust from entering the housing. Electrical currents

If electricity passes through the SANDEX unit, minute dimples can occur on the cam followers and roller gear cam, as well as on the rolling surfaces and members of the bearings.

“ Electrolytic corrosion” is where electrical sparks actually melt away the surfaces of the rolling members. Electrolytic corrosion is a current-based effect. Therefore, it can occur under less than one volt of electrical power.

If your SANDEX unit may be subject to electrical currents, make sure to insulate it. Electrolytic corrosion, if allowed to persist, will increase the amount of vibration and noise, and eventually render your SANDEX unit useless. Always insulate the table and unit from welding applications or other automated machinery that use large amounts of electrical current.

When linking the motor with the input system, consider using rubber couplings instead of metal types. Rubber provides more insulation. Other measures that can prevent electrolytic corrosion include using V-belts and timing belts.

4. Installation

Another crucial factor to the performance of your SANDEX unit is the operating environment. Make an early review of the location for your SANDEX unit and take any corrective actions necessary.

4.1 Casing main body

- (1) Always use the lifting bolt holes provided on the housing of your SANDEX unit. Do not lift the unit using the input or output shafts as this can affect the precision of the equipment, or worse, affect the life of the machine.
- (2) Each SANDEX unit has oil fill, drain and sight gauge ports. The unit should be mounted for easy maintenance access to these ports.
- (3) To ensure that your SANDEX unit is mounted accurately in the best possible position, make sure the housing, shaft dimensions, and mounting holes comply with drawing specifications. Also check the mounting area for perpendicularity and flatness. If the mounting surface has any scratches, burrs, debris, or paint, use an oilstone or emery paper to remove it. Next, clean the mounting surface and apply a light coat of grease or mineral oil to prevent rust and scratches. You may now mount your SANDEX unit. Never install the unit in a position not specified for your particular product.
- (4) Align your peripheral equipment with the input and output shafts on the SANDEX unit to ensure the best possible mounting position.

Apply Loctite 242 or equivalent screw locking solution to the mounting bolts, and tighten to the specified torque with a torque wrench. (Tightening torque: DIN 8.8)

- (5) The foundation for your SANDEX unit must be rigid enough to withstand vibrations from other machines. The foundation is crucial to the precision and life of your SANDEX unit. To ensure maximum performance mounts your SANDEX unit on a foundation that is smooth, flat, hard, and free from vibration.

The standard operating temperature range for SANDEX units is between 0 to 40 degrees Celsius (32 to 104°F). For usage outside of this range, follow the tips below.

4.2 Driver

The SGDH servo amplifiers are base-mounted. Incorrect installation will cause problems. Follow the installation instructions below.

4.2.1 Storage Conditions

Store the servo amplifier within the following temperature range, as long as it is stored with the power cable disconnected. -20 to 85°C (-4 to 185°F)

4.2.2 Installation Site

The following precautions apply to the installation site

Situation	Installation Precaution
Installation in a Control Panel	Design the control panel size, unit layout, and cooling method so the temperature around the servo amplifier does not exceed 55°C (131°F).
Installation Near a Heating Unit	Minimize heat radiated from the heating unit as well as any temperature rise caused by natural convection so the temperature around the servo amplifier does not exceed 55°C (131°F).
Installation Near a Source of Vibration	Install a vibration isolator beneath the servo amplifier to avoid subjecting it to vibration.
Installation at a Site Exposed to Corrosive Gas	Corrosive gas does not have an immediate effect on the servo amplifier, but will eventually cause electronic components and contactor-related devices to malfunction. Take appropriate action to avoid corrosive gas.
Other Situations	Do not install the servo amplifier in hot and humid locations or locations subject to excessive dust or iron powder in the air.

4.2.3 Orientation

Install the servo amplifier perpendicular to the wall as shown in the figure. The servo amplifier must be oriented this way because it is designed to be cooled by natural convection or by a cooling fan. Secure the servo amplifier using the mounting holes. The number of holes varies (from two to four) with the frame size of the servo amplifier.

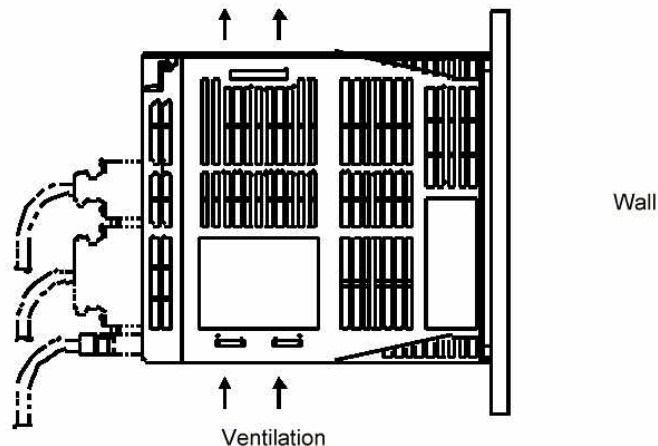

4.2.4 Wiring Three Phase 200VAC

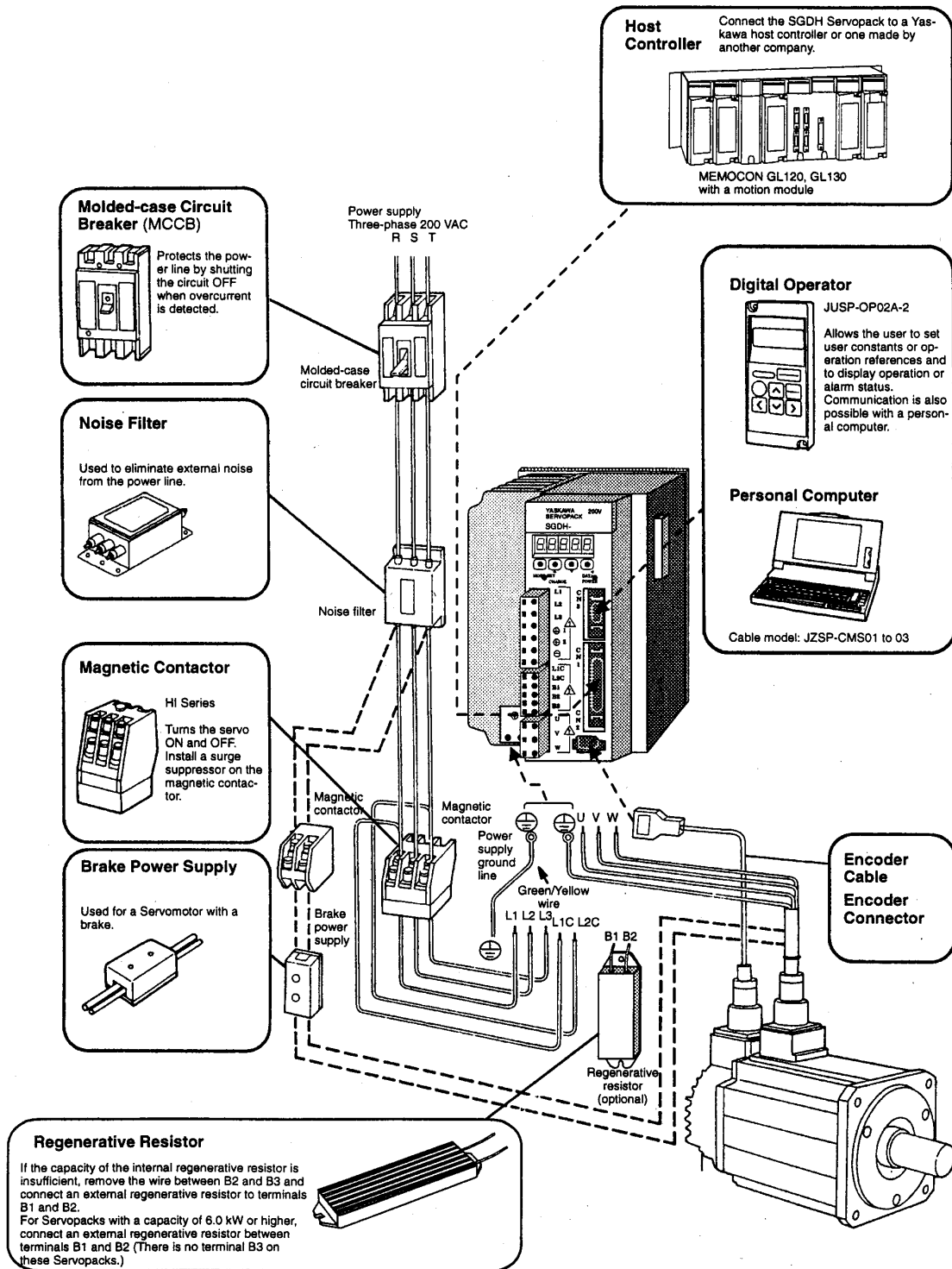

4.2.5 Wiring Three Phase 400VAC

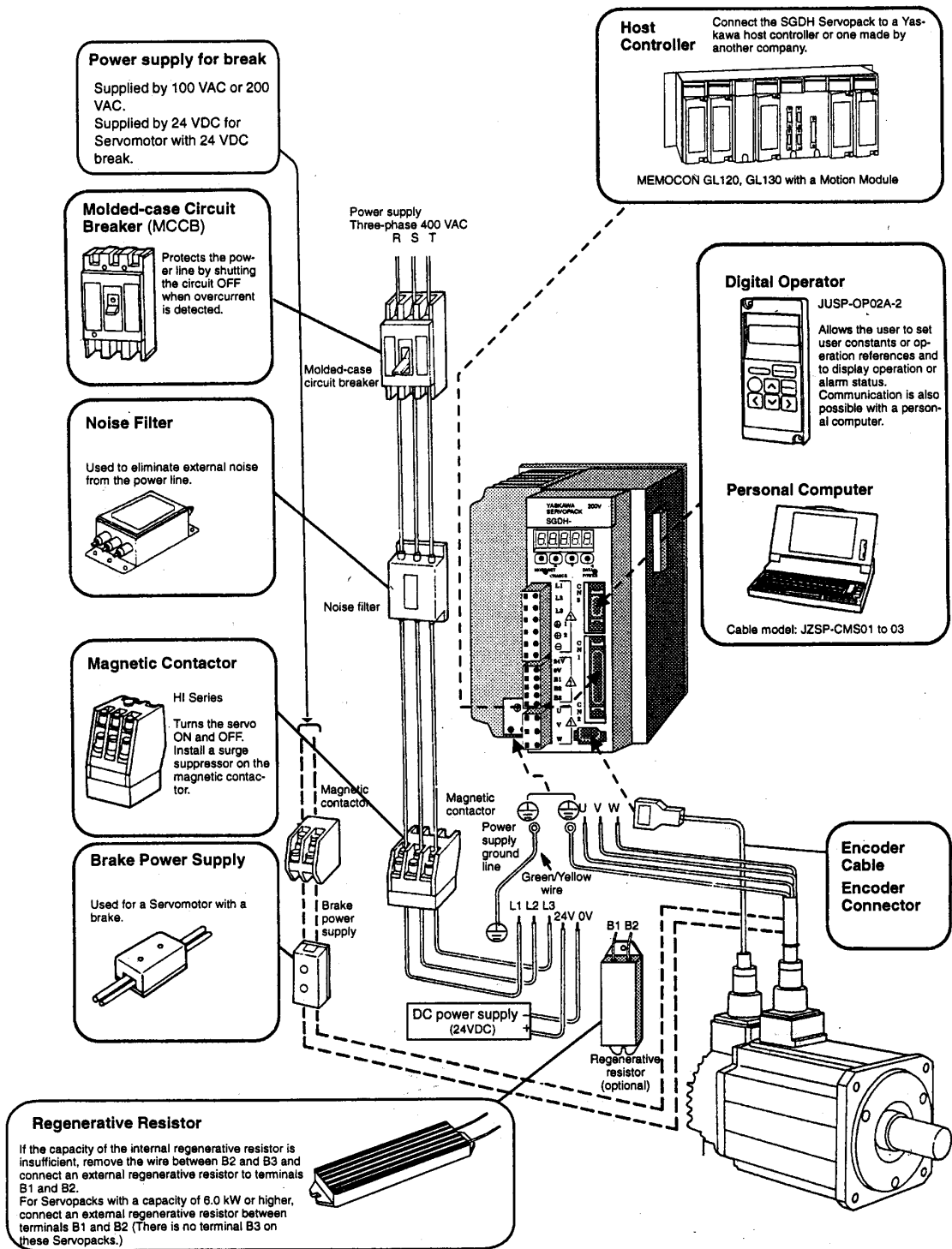

4.3 Controller

4.3.1 Mounting the MP940

1. Insert the two mounting tabs on the bottom of the MP940 into the mounting holes on the lower right side of the SGDH.

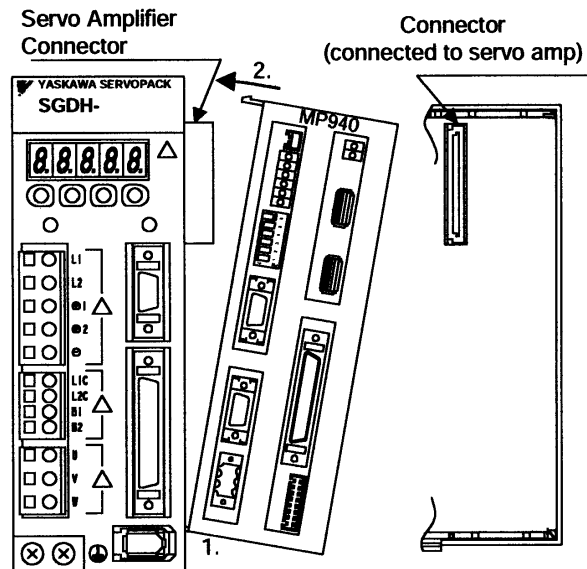

2. Pressing in the direction of the arrows, insert the mounting tabs on the top of the MP940 into the mounting holes on the top right side of the SGDH.
3. Insert the MP940 module fixing spring into the hole on the top of the SGDH.

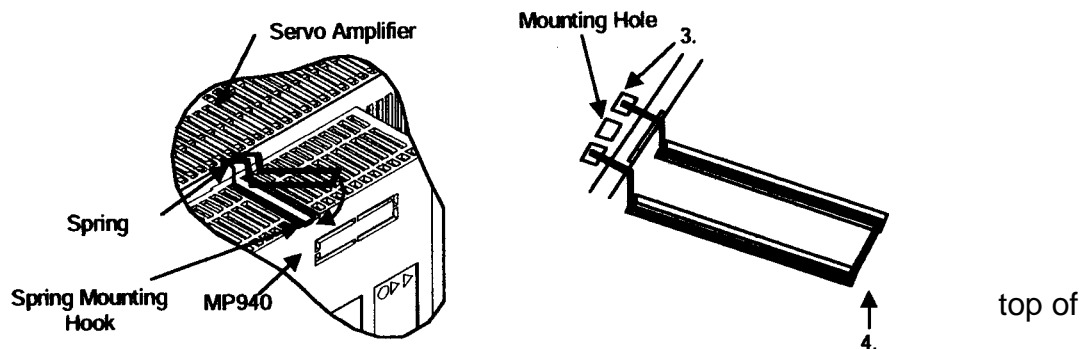

5. Mount the bottom spring in the same manner as in step 4. Refer to the following diagrams when mounting the MP940 to a servo amplifier. There are two kinds of mounting springs; they differ in shape according to the servo amplifier capacity.

4.3.2 Connection of Peripheral Devices

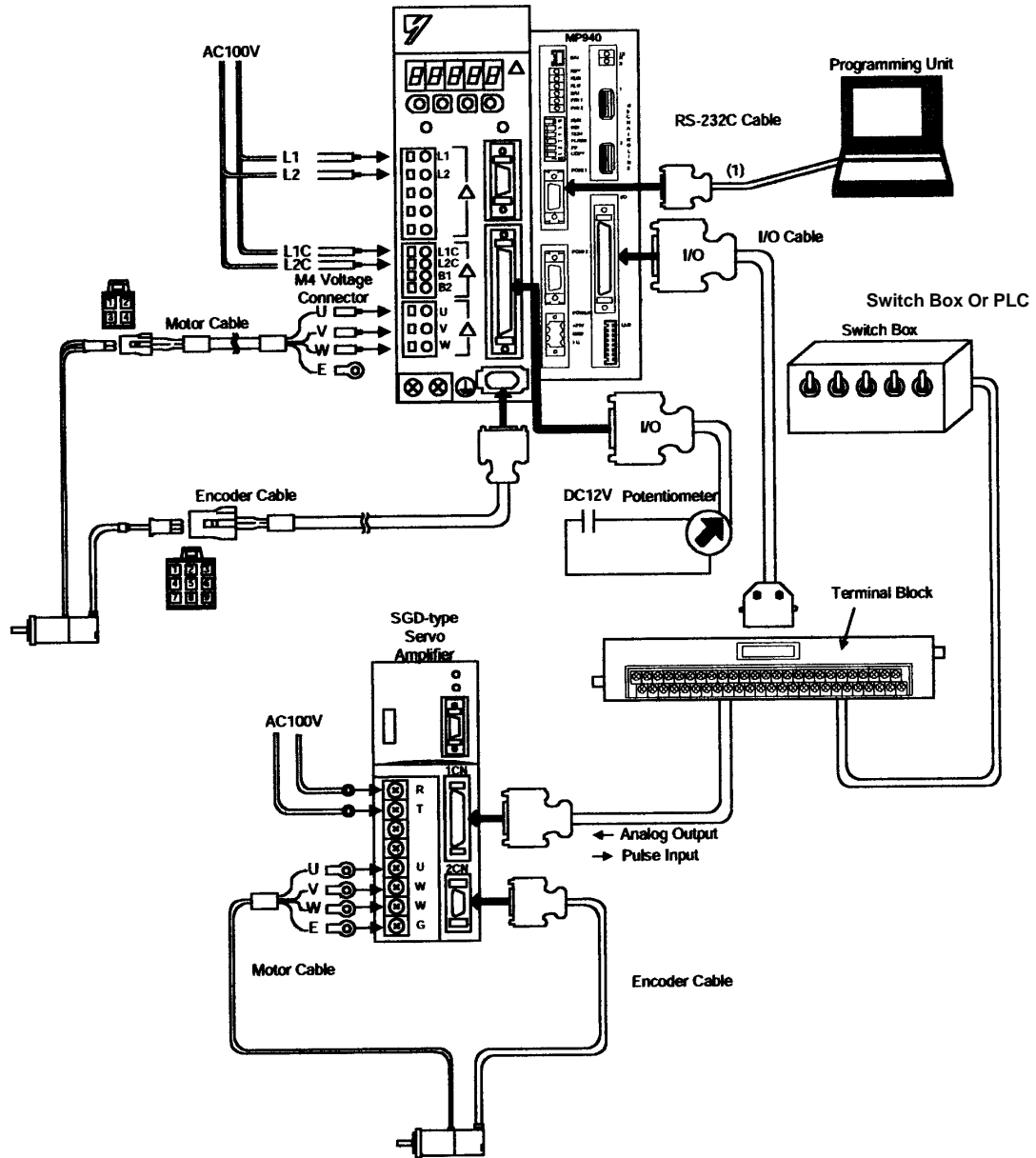

Motor power, and encoder are standard cables that are supplied by Sankyo America Inc. The I/O connections are made by one of two options (see 4.4.2). The source power cables will be supplied by the customer.

4.4 Wiring

1.) Power Supply Connector Cable

Supplies DC +24V 400mA power supply to the MP940 module. The connectors use a screw-mount terminal block BL3, 5/3F-AU (Weidmuller, Inc.).

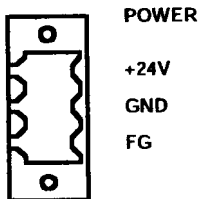

Pin#	Signal Name	Name
3	+24V	+24VDC input
2	GND	0V
1	FG	Frame ground

2.) Input Cable Preparing Procedure

Use a twisted pair with a wire size of AWG#24 to AWG#20 when connecting the 24VDC power supply and MP940 Module power supply connector.

4.4.1 I/O Circuits

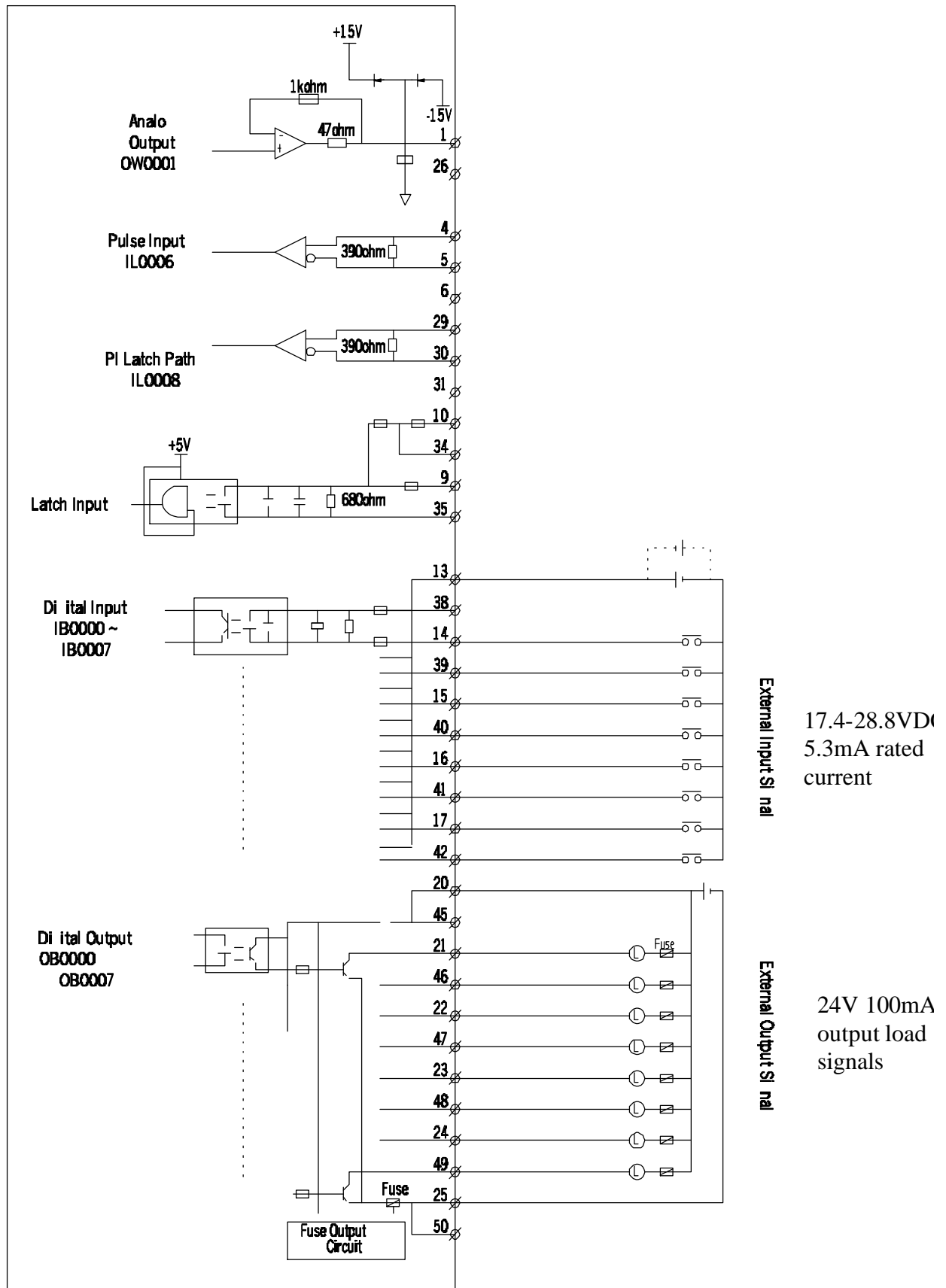

4.4.2 Controller I/O connections

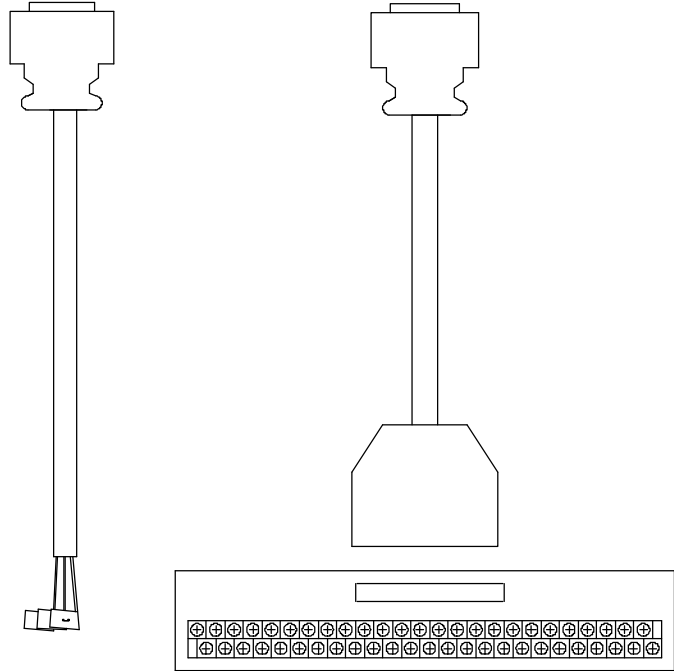
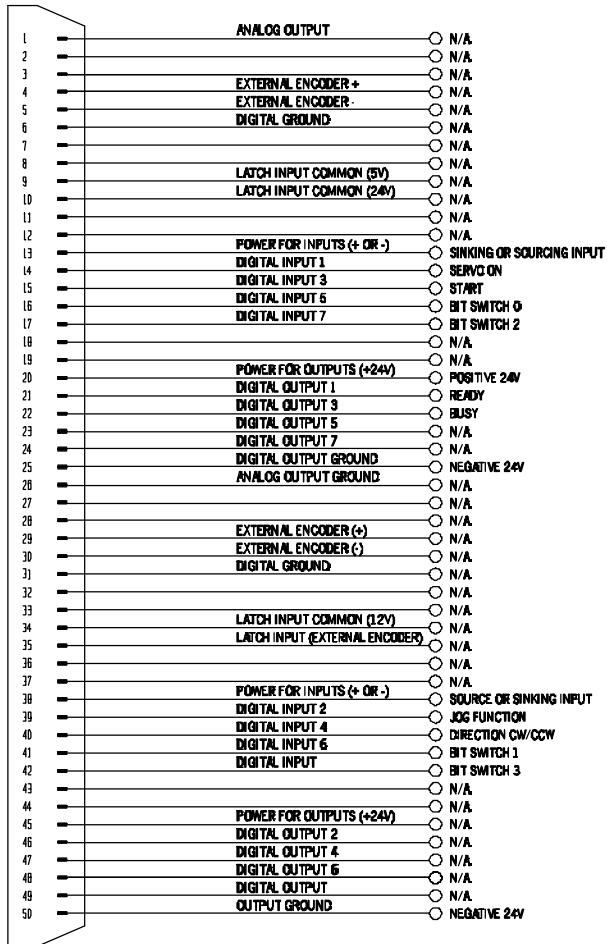

The pigtail cable, and the cable with terminal block are available options for your connection

Note: N/A connections are not needed for the Alpha Servo application.

5. Operation

Generally, automated machinery using SANDEX units are complicated in design. This is based on the large number of linkage involved. Such machinery generally uses the cams and linkages for obtaining overlapped movements. However, one will almost always encounter interference problems if he operates the equipment prematurely. To avoid this type of problem, the input drive should be test turned by hand, as each component is mounted.

5.1 Setting encoder zero position

- Press the DSPL/SET key to select the auxiliary function mode.

F	n	0	0	0
---	---	---	---	---
- Select the user constant Fn008. Press the or cursor key to select the digit to set, and then press the or cursor key to change the number.

F	n	0	0	8
---	---	---	---	---
- Press the DATA/ENTER key for the following display to appear.

P	G	L	C	1
---	---	---	---	---
- Using the cursor key change this

P	G	L	C	1
---	---	---	---	---

 value to
- When the display reads "PGCL5" press the DISPL/SET key then the display will flash "done" for one second then return to "PGCL5".

	d	o	n	e
--	---	---	---	---
- Reset the 24VDC power to finish the absolute encoder's setup operation.

5.2 Setting zero position (starting position)

The Sankyo Alpha series index drive is equipped with a servomotor as part of our standard package. Manual adjustment for positioning and timing purposes of the indexing drive can easily be accomplished by using the jog feature. After entering jog mode and locating zero position (starting point) exit jog mode. Once the jog mode has been exited the zero position will be established. Once this method has been completed please do not enter the jog mode unless you wish to reset the zero position.

5.3 I/O timing chart while in jog mode

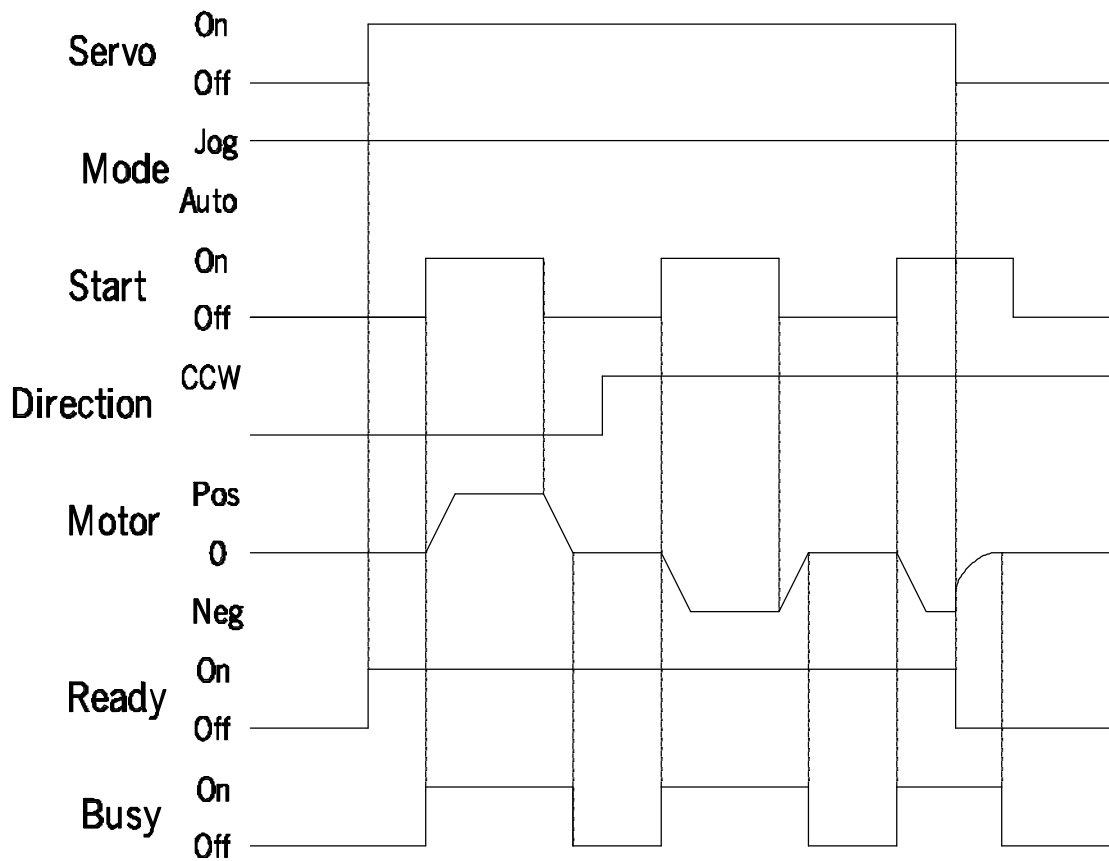

A) Input Signals

- 1) **Servo ON:** This signal will activate the driver and await user commands. If there are no errors the ready output signal will also be activated.
- 2) **Auto/Jog:** This signal will cause the controller to go into jog mode and await a start signal.
- 3) **Start:** While in jog mode this signal will start the rotation of the motor's output shaft. When this signal is not present the motor will stop rotating.
- 4) **CW/CCW:** This signal will cause the servomotor to jog in a counterclockwise (CCW) direction. When this signal is not activated the motor will jog in a clockwise (CW) direction.

B) Output Signals

- 1) **Ready:** This signal will be activated when there are no errors, and the drive is on.
- 2) **Alarm:** This signal will be activated whenever there is an alarm present in the drive.
- 3) **Busy:** This signal will be activated whenever the drive senses movement of the motor.

5.4 I/O timing chart while in automatic mode

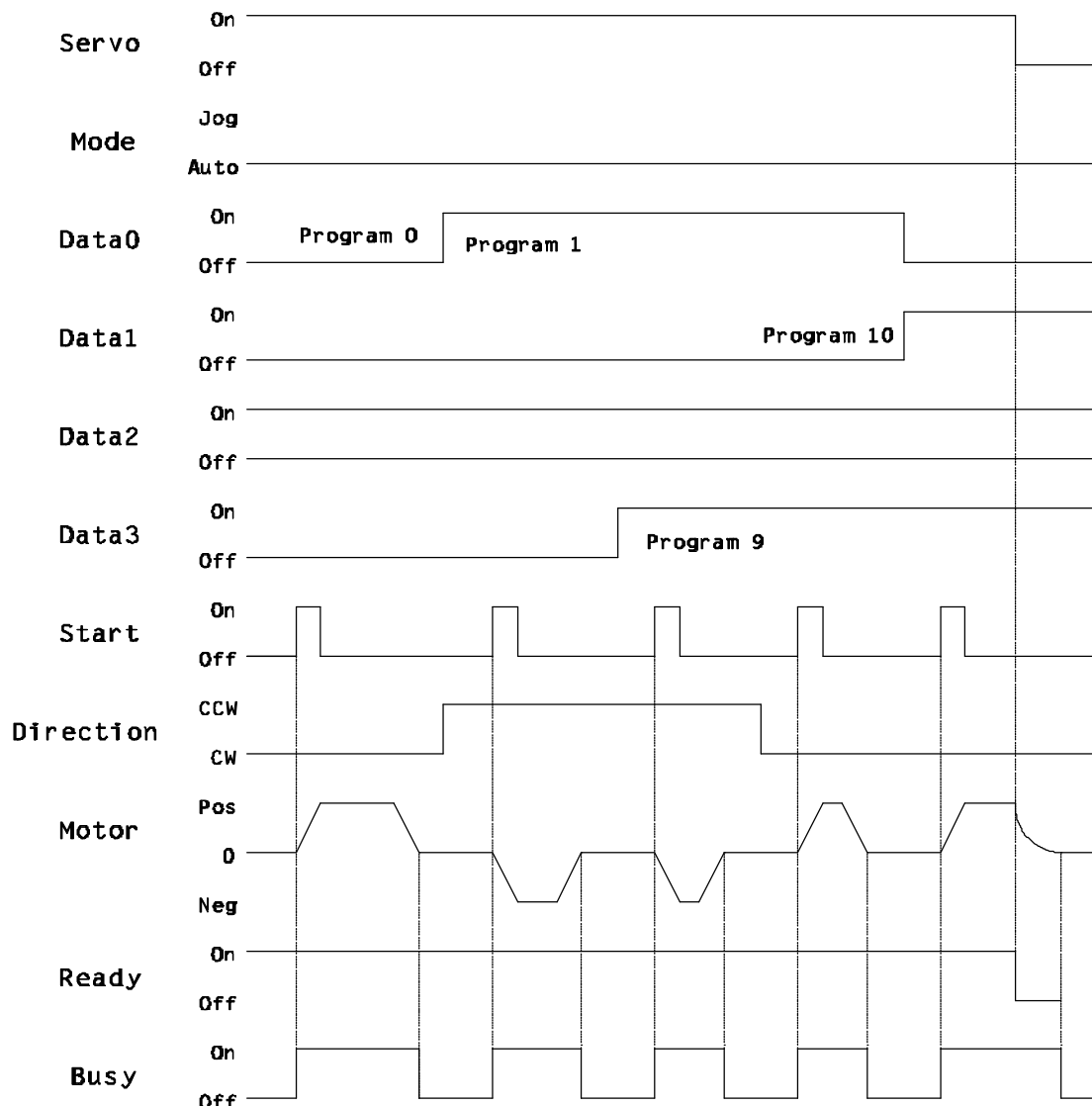

C) Input Signals

- 1) **Servo ON:** This signal will activate the driver and await user commands. If there are no errors the ready output signal will also be activated.
- 2) **Auto/Jog:** This signal is not activated causing the controller to begin auto mode and await a start signal.
- 3) **Start:** While in auto mode this signal will start the preprogrammed motion that was written by Sankyo America. Each of these units will be programmed in accordance with the customer's specifications.
- 4) **CW/CCW:** This signal will cause the servomotor to execute the preprogrammed motion in a counterclockwise (CCW) direction. When this signal is not activated the motion will rotate in a clockwise (CW) direction.

5.5 Indexing time vs. stops chart

Index time- # Stops chart

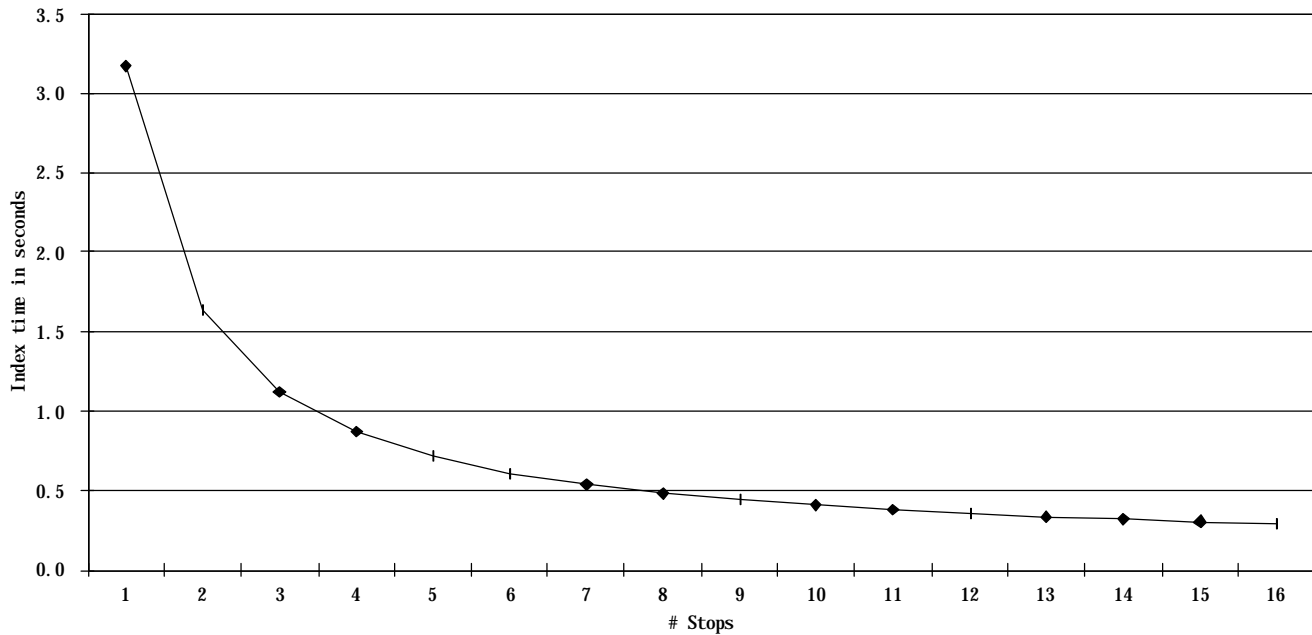

5.6 Data switch settings

Program#	Data				Stops	Index Angle [degree]	Index time [sec]
	3 bit	2 bit	1bit	0bit			
0					1	360	3.172
1				On	2	180	1.636
2			On		3	120	1.124
3			On	On	4	90	0.868
4		On			5	72	0.714
5		On		On	6	60	0.612
6		On	On		7	51.42857	0.539
7		On	On	On	8	45	0.484
8	On				9	40	0.441
9	On			On	10	36	0.407
10	On		On		11	32.72727	0.379
11	On		On	On	12	30	0.356
12	On	On			13	27.69230	0.336
13	On	On		On	14	25.71428	0.319
14	On	On	On		15	24	0.305
15	On	On	On	On	16	22.5	0.292

6. Handling procedures for the output shaft

The output shaft on an indexing drive is subject to momentous torque during starting and stopping. Therefore, the shaft must be torsionally rigid. To maintain positioning accuracy, the output shaft must have minimal run out. The run out on a standard SANDEX is within 0.02 mm (.0008).

Note

The SANDEX is designed to show accuracy as it stops. When aligning shafts, do so after repeated indexing and make sure the shaft is in a dwell.

There are different handling methods for various configurations of the final turret. The following indexing drive handling procedures also apply for roller drives and oscillating drives.

6.1 Table type output

- (1) Table type output sections have a broader mounting surface than flange type output. Tables can be mounted easily and accurately.
- (2) To accurately position work stations on the table, enlarge the hole in the center of the table from 0.1 to 0.2 mm (.004 .008). Align the table. Then, tighten the bolts and drive locating pins into place. Our recommendation of size of bolts and tighten torque is as following.

	Mounting bolts		Recommended knock pin	
	Size	Tighten torque	Place	Hole depth
7AR	6-M6	13.5 N m	P.C.D. 85	12 mm
9AR	6-M6	13.5 N m	P.C.D. 120	12 mm
11AR	6-M8	34 N m	P.C.D. 150	16 mm
15AR	6-M10	67.5 N m	P.C.D. 210	20 mm

- (3) The center of output shaft has a fixed flange with a hole in it. This fixed flange is suitable for directly mounting fixed tables. A hole can be drilled in the mounting base in line with the center of the output shaft for concealing wiring and plumbing.

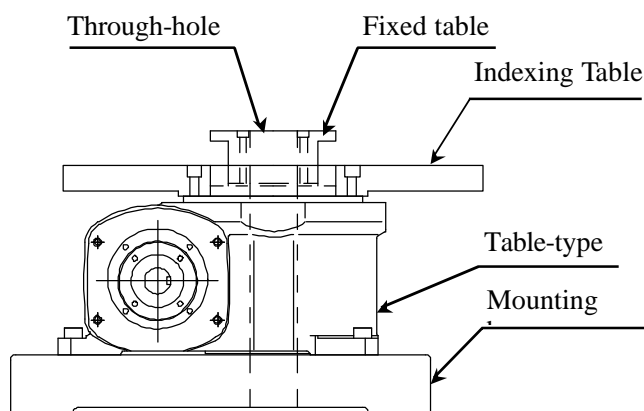

7. Lubrication

Lubrication is an effective and vital means for maintaining the life of your SANDEX unit. Lubrication can minimize wear by reducing friction between rolling members, removing friction heat, and preventing rust on rolling surface. The statistical life of the SANDEX unit is based on rolling fatigue. However, these statistics are valid only when wear, vibration, and mechanical seizure are kept at a minimum.

Improper lubrication over any of these areas can cause frictional wear in a very short time.

On the other hand, proper lubrication using incorrect grades of lubricating oils, such as low viscosity oil, can cause temperature rises and lower the dynamic viscosity of the lubricant. This means that the minimum dynamic viscosity necessary for forming an oil film cannot be obtained, thereby allowing the two surfaces to directly come into contact and cause frictional wear.

It is vitally important that proper lubrication procedures be implemented according to actual operating conditions.

4.5 Purpose of lubrication

- (a) To prevent friction between pure slipping members.
- (b) To prevent abrasion by forming an oil film between two surfaces, thereby inhibiting direct contact between both surfaces.
- (c) To extend the fatigue life of the material by introducing boundary based on oil film formation, thereby relieving Hertz stress.
- (d) To prevent local temperature rises by transmitting and removing friction heat.
- (e) To prevent dirt and other foreign particles from entering the housing.
- (f) To prevent rust by using the oil film to keep the surface from direct exposure to the atmosphere.

7.2 Oil selection precautions

- (1) Lubrication is a vital factor to ensure maximum performance from your unit. The selection of lubricating oils is equally important. Improperly selected oils can lower the precision of the unit, and reduce its operating life. When selecting an oil, always give full consideration to actual operating conditions.
- (2) When selecting oils, choose good quality gear oil with pressure additives, a strong oil coating quality, rust inhibiting properties, and steady oxidation. (A pressure additive is a specially formulated chemical composition that improves lubrication performance.)
- (3) Never mix oils of different manufacturers even if they are used for the same purpose. This is because each manufacturer may use pressure additives with different compositions.

- (4) Viscosities differ according to the operating speed and size of the indexing drive involved. Choose the proper viscosity from the following table.
- (5) The viscosity you choose should also meet the ambient temperature requirements of your SANDEX unit. The following table gives the viscosity for a standard temperature range from 0 to 40 degrees Celsius(32 – 104°F). Consult Sankyo for usage outside of this range.

7.3 Lubricating oil viscosity's

INPUT SHAFT ROTATING SPEED (rpm)	0~20	20~100	100~200	200~300	300~400	400~600	600~
VISCOSITY (cSt/40°)	680	460	320	220	220	150	150

Note

If your operating speed falls between two viscosity grades, use the higher viscosity grade.

7.4 Recommended lubricating oil

VISCOSITY (cSt/40°)	LUBRICATING OIL LEVELS		
	Esso Standard Oil	Shell Oil	Mobil Oil
>680	Spartan EP680	Shell Omala Oil 680	Mobil Gear 636
680~460	Spartan EP480	Shell Omala Oil 460	Mobil Gear 636-633
460~320	Spartan EP320	Shell Omala Oil 320	Mobil Gear 632
320~220	Spartan EP220	Shell Omala Oil 220	Mobil Gear 630
220~150	Spartan EP150	Shell Omala Oil 150	Mobil Gear 629
150~68	Spartan EP68	Shell Omala Oil 68	Mobil Gear 626

8. *Filling and replacing lubricating oil*

Lubrication is a crucial factor for maintaining the operating life of your SANDEX unit.

These units feature a high level of precision, and a resistance to friction. However, improper lubrication can reduce the life of the unit. When filling the unit with oil, make sure to prevent foreign particles such as drilling chips, dust, or water from entering the unit.

Before filling with new oil, clean the area around the oil filling port. Also, always use clean fresh oil.

8.1 Refilling lubricating oils

- (1) To add lubricating oil, remove the oil fill plug. (On standard drives, this plug is a hexagonal PT plug and has a small air-bleeding hole in it.) Allow sufficient time for the oil to settle in the housing for an accurate filling.
- (2) On standard SANDEX units, the oil fill level and drain plugs are designed so not to protrude from the mounting plane. However, operation at high speeds may cause oil to spurt from the air-bleeding hole in the plug. Also, it may be difficult to refill and drain oil if a table is mounted on the output shaft.

8.2 Oil replacement schedule

First time	After 1000 hours of operation
Thereafter	Every 3000 hours of operation

Note

For use under the above hours, replace once every year.

9. Lubrication greases

SANDEX units use an oil bath lubricating system. In certain mounting positions, the bearings sit above the oil level. In this case, a sealed lubricating device is installed exclusively for the bearings and grease nipples are attached wherever grease must be reapplied. Note, your SANDEX has already been greased prior to initial operation. Apply grease every 2000 to 4000 hours of operation.

9.1 Supplying lubricating grease

- (1) If the mounting position of the Alpha index output flange is horizontal, parallel to the ground, grease needs to be applied to the bearing by the grease fitting supplied on the output stationary flange.

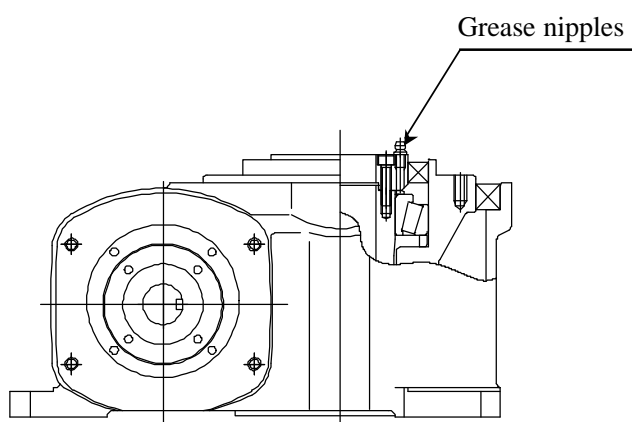

- (2) Supply 5 to 30 g per shot according to the SANDEX model you are using. Old grease will fall into the oil basin and will be drained when the lubricating oil is replaced.

Recommended lubricating greases

MAKER	LUBRICATING GREASE LABELS
Esso Standard Oil	Beacon 2, Q2 ; Lystan 2, EP2
Shell Oil	Alvania 2, EP2
Mobil Oil	Mobilax Grease 2, EP2

10. Repairs and maintenance

One of the advantages of the SANDEX unit is that it is easy to handle. However, improper use can affect the life and performance of your SANDEX unit. The following items explain basic repair and maintenance procedures.

- (1) Periodically, check for backlash in the input and / or output systems. Backlash that goes unnoticed may develop even further over the years. Check for red rust as this indicates the occurrence of fretting corrosion. Re-tighten any locations where red rust appears.
- (2) Running your SANDEX unit without oil will cause internal damages. Note, overfilling can be the cause of abnormal temperature rises and oil leaks.
- (3) Replace lubricating oils every 3000 operating hours. Note, for operating hours less than this, replace the oil once every year.
- (4) **Supply lubricating grease every 2000 to 4000 operating hours. For 23AD, supply a shot of 20 to 30 g. For smaller models, supply approximately 5 to 10 g.**
- (5) **The Sigma II driver is supplied with a Toshiba, ER3 V, 3.6V, 1000mAH battery. The driver is also equipped with a battery light. This light should be checked as a general maintenance item, and when illuminated the battery will need replaced.**

10.1 Yaskawa Driver and Controllerdisplay codes

Display Value	Description	
A.-	Normal Operation	If any of these errors occur please contact: Sankyo America Inc. (937) 498-4901
A.02	Parameter Breakdown	
A.03	Main Circuit Encoder Error	
A.04	Parameter Setting Error	
A.05	Servomotor and Amplifier Combination Error	
A.10	Overcurrent or Hat Sink Overheated	
A.30	Regeneration Error Detected	
A.32	Regenerative Overload	
A.40	Overvoltage	
A.41	Undervoltage	
A.51	Overspeed	
A.71	Overload: High Load	
A.72	Overload: Low Load	
A.73	Dynamic Break Overload	
A.74	Overload of Surge Current Limit Resistor	
A.7A	Heat Sink Overheated	
A.81	Absolute Encoder Backup Error	
A.82	Encoder Checksum Error	
A.83	Absolute Encoder Battery Error	
A.84	Absolute Encoder Data Error	
A.85	Absolute Encoder Overspeed	
A.86	Encoder Overheated	
A.b1	Reference Speed Input Read Error	
A.b2	Reference Torque Input Read Error	
A.Bf	System Alarm	
A.C1	Servo Overrun Detected	
A.C8	Absolute Encoder Clear Error and Multiturn Limit Setting Error	
A.C9	Encoder Communications Error	
A.CA	Encoder Parameter Error	

A.Cb	Encoder Echoback Error	If any of these errors occur please contact: Sankyo America Inc. (937) 498-4901
A.CC	Multiturn Limit Disagreement	
A.d0	Position Error Pulse Overflow	
A.F1	Power Line Open Phase	
CPF00	Digital Operator Transmission Error	
CPF01	Digital Operator Transmission Error	
A.91	Overload Warning	
A.92	Regenerative Overload Warning	
A.E?	Option Board Error	

10.2 Troubleshooting procedures (1)

	NATURE OF PROBLEM	ASSUMED CAUSE	CORRECTION
BACKLASH IN OUTPUT SHAFT			
	Small amount along perimeter of cam	Insufficient preload between cam and cam follower	Adjust eccentric flange on input shaft
	Large amount on certain part(s) of cam	Cam flaking	Replace cams, reduce load on output shaft
	Large amount on certain part(s) of turret	Cam follower flaking	Replace turret, reduce load on output shaft
	Large amount at one place on turret	Crack in outer diameter of cam follower	Replace turret, attach torque limiter on output shaft
	Large amount at one place on turret	Damaged cam follower	Replace turret, attach torque limiter to output shaft
	Changes every index	Eccentric wear on outer diameter of cam follower	Replace turret, increase oil viscosity by one grade
PLAY IN OUTPUT SHAFT			
	Play in thrust direction only	Loose output flange	Apply loctite to screw threads and re-tighten
	Play in thrust and radial directions	Worn bearings	Check sealing device and lubrication
	Play in thrust and radial directions	Loose tightening nut	Tighten nut, review load in thrust direction
	Play in thrust and radial directions	Creep wear on shaft	Enlarge tightening length, review ambient temperatures
PLAY IN INPUT SHAFT			
	Play in thrust direction only	Insufficient preload on bearings	Tighten flange on inside of eccentric flange
	Play in thrust and radial directions	Bearing has gap in thrust direction	Tighten flange on inside of eccentric flange
	Play in thrust and radial directions	Worn bearings	Improve lubrication sealing device
	Play in thrust and radial directions	Creep wear on shaft	Enlarge tightening length, review ambient temperatures
NOISE			
	Loud noises, continuous	Noise from lip section of oil seal	Supply lubricant, replace sealing device
	Loud continuous noise caused by vibration.	Noise from entire unit	Check Servo Tuning section in Yaskawa Drive manual, or contact Sankyo America for assistance.
	Loud noises, intermittent	Roughly machined cam track surface	Correct cam, increase viscosity of lubricating oil
	Loud noise, intermittent	Rotating components touch each other	Check mounted component
	Low noise, continuous	Worn input shaft bearings	Replace bearings, check lubrication
	Low noise, intermittent	Cam flaking	Replace cams, reduce load on output shaft
	Low noise, intermittent	Cam follower flaking	Replace turret, reduce load on output shaft
	Low noise, Intermittent	Loose rotating components	Check tightening section of mounted components

10.3 Troubleshooting procedures (2)

	NATURE OF PROBLEM	ASSUMED CAUSE	CORRECTION
VIBRATION			
	Output rotating section	Backlash, torsion, deflection in input system	Check input drive system
	Output rotating section	Loose linkage in input system	Change linkage elements, tighten bolts
	Output rotating section	Rotation lag in input system	Change rotation transmission component
	Output rotating section	Insufficient motor power	Increase motor power rating
	Output rotating section	Clutch brake timing	Adjust timing cam
	Output rotating section	Cam flaking	Replace cam, reduce load on output shaft
	Input rotating section	Rotating components are physically unbalanced	Balance components
	Input rotating section	Rotating components are eccentric	Align centers
	Residual vibration	Insufficient torsional rigidity in output system	Increase rigidity of output system
	Residual vibration	Momentum in output system is too intense	Select a larger indexing drive model
	Overall	Frame deformity	Increase rigidity of mounting base
TEMPERATURE RISE			
	Entire housing	Heat caused by agitation	Check lubrication oil level and viscosity
	Bearing burnout	Rotating speed too high	Adjust eccentric flange
	Cam, cam follower burnout	Too much preload	Check lubrication
	Bearing burnout	Insufficient lubrication	Check lubrication
OIL LEAKAGE			
	Input/output shaft	Broken sealing device	Replace sealing device, install dust cover
	Flange surface	Broken O-ring	Replace parts
	Oil plug	Lubricating oil splashes	Change oil plug part number
	Mounting hole surface	Starting hole for tapping goes all the way through	Apply sealant to mounting
BROKEN SHAFT			
	Input shaft	Damage due to material fatigue	Reduce overhanging load
	Output shaft	Shock load	Install torque limiter on output shaft
	Key shaft	Fretting corrosion	Change friction linkage
	Rust	Ambicent conditions	Apply rust inhibitor or paint surface



10655 State Route 47, P.O. Box 4338

Sidney, Ohio 45365-4338

Telephone: (937) 498-4901

Fax: (937) 498-9403

E-mail: sales@sankyoamerica.com

Web Site: <http://www.sankyoamerica.com>

Free Manuals Download Website

<http://myh66.com>

<http://usermanuals.us>

<http://www.somanuals.com>

<http://www.4manuals.cc>

<http://www.manual-lib.com>

<http://www.404manual.com>

<http://www.luxmanual.com>

<http://aubethermostatmanual.com>

Golf course search by state

<http://golfingnear.com>

Email search by domain

<http://emailbydomain.com>

Auto manuals search

<http://auto.somanuals.com>

TV manuals search

<http://tv.somanuals.com>