

40" CLASS LCD HDTV
HDTV ACL CATÉGORIE 40 PO

HDLCD4060

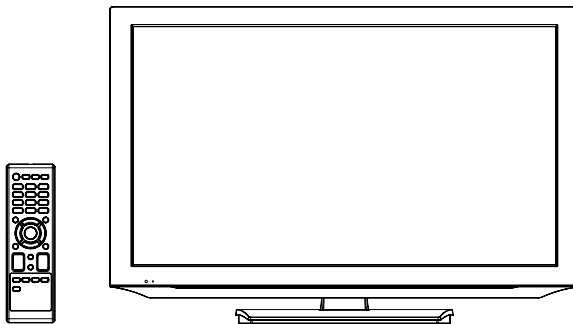

**ATTENTION
ATTENTION**

If you purchase a universal remote control from your local retailer, please contact the remote manufacturer for the required programming code.
Si vous utilisez avec cet appareil une télécommande universelle (autre que celle vendue avec ce téléviseur), consultez la documentation accompagnant la télécommande universelle afin de connaître le code numérique correspondant au téléviseur.

**AIR/CABLE MODE SELECTION
SÉLECTION DU MODE AIR/CABLE**

When shipped from the factory, the Signal Type option is set to the "Cable" (Cable Television) mode. If not using Cable TV, set this menu option to the "Air" position.
Lorsque l'appareil sort de l'usine, l'option Signal Type est en mode « Cable » (câblodistribution). Si vous n'utilisez pas la câblodistribution, sélectionnez l'option « Air ».

**IF CONTACT WITH CUSTOMER SERVICE IS REQUIRED
PLEASE HAVE THE MODEL NUMBER READY PRIOR TO THE CALL.
SI VOUS DEVEZ COMMUNIQUER AVEC LE SERVICE CLIENTÈLE, PRENEZ NOTE
DU NUMÉRO DE MODÈLE AVANT D'APPELER.**

**CUSTOMER SERVICE - 1-800-289-0980
SERVICE/SERVICE CLIENTÈLE: 1-800-289-0980**

**ORION WEBSITE
SITE WEB ORION**

FOR INFORMATION ON OUR OTHER PRODUCTS, TO ORDER ACCESSORIES ONLINE,
OR FOR RECYCLING INFORMATION, PLEASE VISIT OUR WEBSITE AT
POUR OBTENIR DES INFORMATIONS SUR NOS AUTRES PRODUITS, POUR COMMANDER DES ACCESSOIRES,
OU LE RECYCLAGE, VEUILLEZ VISITER NOTRE SITE WEB:

www.sansuiproducts.com

Before operating the unit, please read this manual thoroughly.
Avant de faire fonctionner l'appareil, veuillez lire le présent guide attentivement.
Download from www.Sonmanuals.com. All Manuals Search And Download.

ENGLISH

	CAUTION RISK OF ELECTRIC SHOCK DO NOT OPEN	
CAUTION: TO REDUCE THE RISK OF ELECTRIC SHOCK, DO NOT REMOVE COVER (OR BACK). NO USER-SERVICEABLE PARTS INSIDE. REFER SERVICING TO QUALIFIED SERVICE PERSONNEL.		



The lightning flash with arrowhead symbol, within an equilateral triangle is intended to alert the user to the presence of uninsulated dangerous voltage within the product's enclosure that may be of sufficient magnitude to constitute a risk of electric shock.



The exclamation point within an equilateral triangle is intended to alert the user to the presence of important operating and maintenance (servicing) instructions in the literature accompanying the appliance.

WARNING: TO PREVENT FIRE OR SHOCK HAZARD, DO NOT EXPOSE THIS APPLIANCE TO RAIN OR MOISTURE.
TO PREVENT THE SPREAD OF FIRE, KEEP CANDLES OR OPEN FLAMES AWAY FROM THIS PRODUCT AT TIMES.

CAUTION: TO PREVENT ELECTRIC SHOCK. DO NOT USE THIS POLARIZED PLUG WITH AN EXTENSION CORD, RECEPTACLE OR OTHER OUTLET UNLESS THE BLADES CAN BE FULLY INSERTED TO PREVENT BLADE EXPOSURE.

WARNING: This equipment has been tested and found to comply with the limits for a Class B digital device, pursuant to Part 15 of the FCC Rules. These limits are designed to provide reasonable protection against harmful interference in a residential installation. This equipment generates, uses and can radiate radio frequency energy and, if not installed and used in accordance with the instructions, may cause harmful interference to radio communications. However, there is no guarantee that interference will not occur in a particular installation. If this equipment does cause harmful interference to radio or television reception, which can be determined by turning the equipment off and on, the user is encouraged to try to correct the interference by one or more of the following measures:

- Reorient or relocate the receiving antenna.
- Increase the separation between the equipment and receiver.
- Connect the equipment into an outlet on a circuit different from that to which the receiver is connected.
- Consult the dealer or an experienced radio/TV technician for help.

CAUTION: Changes or modifications not expressly approved by the party responsible for compliance with the FCC Rules could void the user's authority to operate this equipment.

The lamp(s) within this product contain mercury. Disposal should be in compliance with local, state or federal laws.

Location of the required marking

The rating sheet and the safety caution are on the rear of the unit.

FCC Declaration of Conformity Compliance Statement (Part 15):

The Sansui HDLCD4060, LCD HDTV combination complies with Part 15 of the FCC rules.

Operation is subject to the following two conditions: (1) this device may not cause harmful interference, and (2) this device must accept any interference received, including interference that may cause undesired operation.

The party responsible for compliance to these rules is: ORION AMERICA, INC.

1105 SOUTH MAIN STREET PRINCETON, INDIANA 47670, U.S.A
Ph: 1-800-289-0980

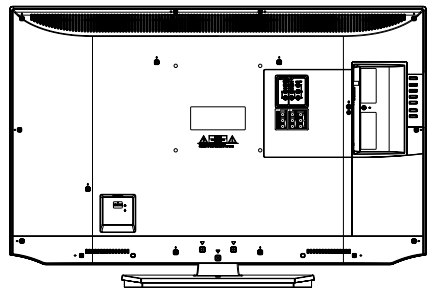

Record the model number and serial number.

Model number _____ Serial number _____

IMPORTANT SAFETY INSTRUCTIONS

- 1) Read these instructions.
- 2) Keep these instructions.
- 3) Heed all warnings.
- 4) Follow all instructions.
- 5) Do not use this apparatus near water.
- 6) Clean only with dry cloth.
- 7) Do not block any ventilation openings. Install in accordance with the manufacturer's instructions.
- 8) Do not install near any heat sources such as radiators, heat registers, stoves, or other apparatus (including amplifiers) that produce heat.
- 9) Do not defeat the safety purpose of the polarized or grounding-type plug. A polarized plug has two blades with one wider than the other. A grounding type plug has two blades and a third grounding prong. The wide blade or the third prong are provided for your safety. If the provided plug does not fit into your outlet, consult an electrician for replacement of the obsolete outlet.
- 10) Protect the power cord from being walked on or pinched particularly at plugs, convenience receptacles, and the point where they exit from the apparatus.
- 11) Only use attachments/accessories specified by the manufacturer.
- 12) Use only with cart, stand, tripod, bracket, or table specified by the manufacturer, or sold with the apparatus. When a cart is used, use caution when moving the cart/apparatus combination to avoid injury from tip-over.
- 13) Unplug this apparatus during lightning storms or when unused for long periods of time.
- 14) Refer all servicing to qualified service personnel. Servicing is required when the apparatus has been damaged in any way, such as power-supply cord or plug is damaged, liquid has been spilled or objects have fallen into the apparatus, the apparatus has been exposed to rain or moisture, does not operate normally, or has been dropped.
- 15) Apparatus should not be exposed to dripping or splashing, and objects filled with liquids, such as vases, should not be placed on the apparatus.
- 16) An outside antenna system should not be located in the vicinity of overhead power lines or other electric light or power circuits, or where it can fall into such power lines or circuits. When installing an outside antenna system, extreme care should be taken to keep from touching such power lines or circuits, as contact with them might be fatal.
- 17) Do not overload wall outlets and extension cords, as this can result in a risk of fire or electric shock.
- 18) Do not push objects through any openings in this unit, as they may touch dangerous voltage points or short out parts that could result in fire or electric shock. Never spill or spray any type of liquid into the unit.
- 19) If an outside antenna or cable system is connected to the unit, be sure the antenna or cable system is grounded to provide some protection against voltage surges and built-up static charges. Section 810 of the National Electrical Code, ANSI/NFPA 70, provides information with respect to proper grounding of the mast and supporting structure, grounding of the lead-in wire to an antenna discharge unit, size of grounding conductors, location of antenna discharge unit, connection to grounding electrodes, and requirements for the grounding electrode.



EXAMPLE OF ANTENNA GROUNDING AS PER THE NATIONAL ELECTRICAL CODE

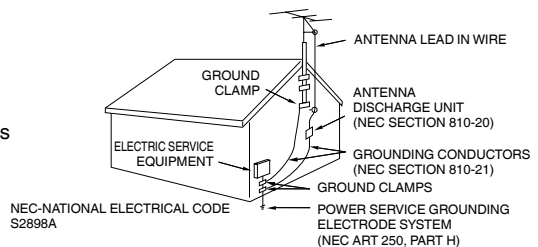

IMPORTANT SAFETY INSTRUCTIONS

- 20) When replacement parts are required, be sure the service technician uses replacement parts specified by the manufacturer or those that have the same characteristics as the original part. Unauthorized substitutions may result in fire, electric shock or other hazards.
- 21) Upon completion of any service or repairs to this unit, ask the service technician to perform safety checks to determine that the unit is in proper operating condition.
- 22) When you connect the product to other equipment, turn off the power and unplug all of the equipment from the wall outlet. Failure to do so may cause an electric shock and serious personal injury. Read the owner's manual of the other equipment carefully and follow the instructions when making any connections.
- 23) Sudden high volume sound may cause hearing or speaker damage. When you use headphones, (if the unit is equipped with a headphone jack) keep the volume at a moderate level. If you use headphones continuously with high volume sound, it may cause hearing damage.
- 24) Do not allow the product to output distorted sound for an extended period of time. It may cause speaker overheating and fire.
- 25) This reminder is provided to call the cable TV system installer's attention to Article 820-40 of the NEC that provides guidelines for proper grounding and, in particular, specifies that the cable ground shall be connected to the grounding system of the building, as close to the point of cable entry as practical.
- 26) The socket-outlet must be installed near the unit and easily accessible.

CHILD SAFETY:

It Makes A Difference How and Where You Use Your Flat Panel Display

Congratulations on your purchase! As you enjoy your new product, please keep these safety tips in mind:

THE ISSUE

The home theater entertainment experience is a growing trend and larger flat panel displays are popular purchases. However, flat panel displays are not always supported on the proper stands or installed according to the manufacturer's recommendations.

Flat panel displays that are inappropriately situated on dressers, bookcases, shelves, desks, speakers, chests or carts may fall over and cause injury.

THIS MANUFACTURER CARES!

The consumer electronics industry is committed to making home entertainment enjoyable and safe.

TUNE INTO SAFETY

One size does NOT fit all. Follow the manufacturer's recommendations for the safe installation and use of your flat panel display.

Carefully read and understand all enclosed instructions for proper use of this product.

Don't allow children to climb on or play with furniture and television sets.

Don't place flat panel displays on furniture that can easily be used as steps, such as a chest of drawers.

Remember that children can become excited while watching a program, especially on a "larger than life" flat panel display. Care should be taken to place or install the display where it cannot be pushed, pulled over, or knocked down.

Care should be taken to route all cords and cables connected to the flat panel display so that they cannot be pulled or grabbed by curious children.

WALL MOUNTING: IF YOU DECIDE TO WALL MOUNT YOUR FLAT PANEL DISPLAY, ALWAYS:

Use a mount that has been recommended by the display manufacturer and/or listed by an independent laboratory (such as UL, CSA, ETL).

Follow all instructions supplied by the display and wall mount manufacturers.

If you have any doubts about your ability to safely install your flat panel display, contact your retailer about professional installation.

Make sure that the wall where you are mounting the display is appropriate to support the weight of the unit/product and wall mount. If you are unsure, contact a professional installer.

A minimum of two people are required for installation. Flat panel displays can be heavy.

IMPORTANT SAFETY INSTRUCTIONS

CONDENSATION

Moisture will form in the operating section of the unit if the unit is brought from cool surroundings into a warm room or if the temperature of the room rises suddenly. When this happens, unit's performance will be impaired. To prevent this, let the unit stand in its new surroundings for about an hour before switching it on, or make sure that the room temperature rises gradually.

Condensation may also form during the summer if the unit is exposed to the breeze from an air conditioner. In such cases, change the location of the unit.

HOW TO HANDLE THE LCD PANEL

- Do not press hard or jolt the LCD panel. It may cause the LCD panel glass to break and injury may occur.
- If the LCD panel is broken, make absolutely sure that you do not touch the liquid in the panel. This may cause skin inflammation.
If the liquid gets in your mouth, immediately gargle and consult with your doctor. Also, if the liquid gets in your eyes or touches your skin, consult with your doctor after rinsing for at least 15 minutes or longer in clean water.

Possible Adverse Effects on LCD Panel: If a fixed (non-moving) pattern remains on the LCD Panel for long periods of time, the image can become permanently engrained in the LCD Panel and cause subtle but permanent ghost images. This type of damage is NOT COVERED BY YOUR WARRANTY. Never leave your LCD Panel on for long periods of time while it is displaying the following formats or images:

- Fixed images, such as stock tickers, video game patterns, TV station logos, and websites.
- Special formats that do not use the entire screen. For example, viewing letterbox style (16:9) media on a normal (4:3) display (black bars at top and bottom of screen); or viewing normal style (4:3) media on a widescreen (16:9) display (black bars on left and right sides of screen).

The following symptoms are not signs of malfunction but technical limitation. Therefore we disclaim any responsibility for these symptoms.

- LCD Panels are manufactured using an extremely high level of precision technology, however sometimes parts of the screen may be missing picture elements or have luminous spots.
This is not a sign of a malfunction.
- Do not install the LCD Panel near electronic equipment that produces electromagnetic waves. Some equipment placed too near this unit may cause interference.
- Effect on infrared devices – There may be interference while using infrared devices such as infrared cordless headphones.

SAFETY PRECAUTIONS

The unit emits heat when in operation. Do not place any covers or blankets on the unit, this may cause overheating. Do not block ventilation holes, or set up near radiators. Do not place in direct sunshine. When placing on a shelf leave 4 inches (10 cm) free space around the entire unit.

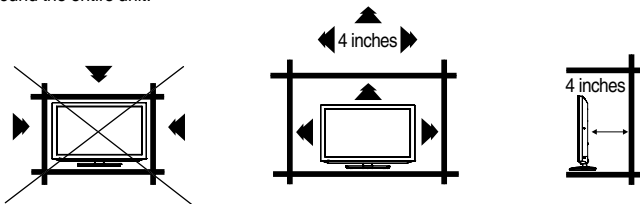

Notes when mounting the TV on a wall

- If the unit is to be mounted on the wall, contact the retailer where you purchased the TV for advice, and have the equipment professionally installed. Incomplete or improper installation may cause injury to you, and/or damage to the TV.
- Bracket holes: To attach a wall mounting bracket (not supplied) attach where indicated in the drawing right.
- This manufacturer recommends professional installation.
- Utilize an appropriate bracket and fasteners, sufficient to accommodate the size and weight of the unit.
- Assure the wall to which the unit is to be mounted will safely support the size and weight of the unit, using the bracket and fasteners you have selected.
- Keep cords and cables connected to this flat panel display out of reach of children.
- To hang the television on a wall, remove these screws and then remove a stand. Before performing work spread cushioning over the base area to lay the TV on.
- Before wall-mounting, please check carefully the location of the TV's mounting-holes

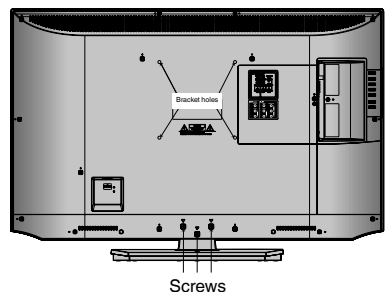

How to attach the stand

NOTE:

- Unplug the AC cord from the AC INPUT terminal.
- Before beginning this process, assure that the TV is laid on a clean, safe, and cushioned surface to avoid any damage to the unit.
- Do not touch or press the TV-screen, glass might break under pressure.

Place the TV on its front onto a table.

Align the stand's bottom-plate (supplied) as seen here.

It will fit in only one direction.

Hold the unit and attach the stand frame (a) slowly and secure the stand frame (a) with the 3 screws (supplied). (4x35mm(5/32x1-23/64 inches)), as shown in figure 1.

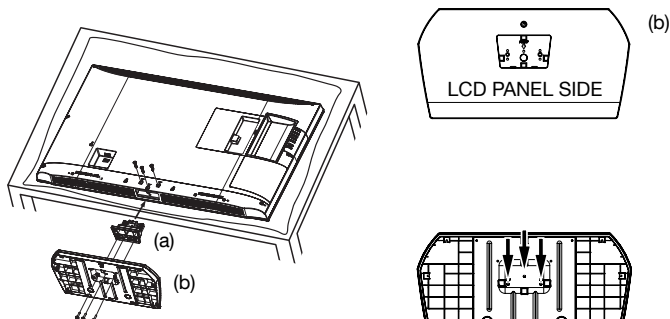

Figure 1

Figure 2

Finally secure the bottom-plate (b) with 3 screws (supplied) (4x12mm(5/32 x 15/32 inches)) as indicated by the arrows in figure 2.

- Be sure to follow the instructions. Insufficient tightening or incorrect installation of the stand will not support your unit correctly, and could result in damage or injury from tip-over.

How to remove the stand

When you transport this product, remove the stand and pack flat against the back of the unit in the carton. To remove the stand, perform these steps in reverse order.

For wall mounting, the base must be removed. To disconnect the base/stand remove the 3 screws from the back (see page 5).

Warning

To prevent injury, which could be expected due to an eventual fall, the TV must be fixed to the ground according to instruction (see right image). Fix to the appropriate ground with the supplied screw.

NOTE:

- There is no liability for any damage to the ground.

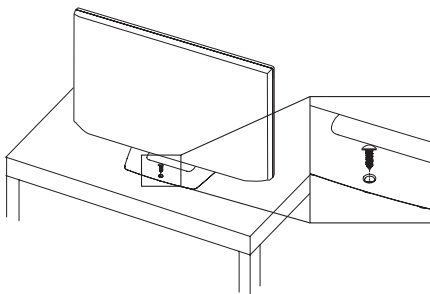

Features

- **Integrated Digital Tuner** - You can view digital broadcasts without using a Digital TV Set-Top Box.
- **Closed Caption Decoder With Full Text Mode** - Displays text captions or full screen text on the screen for hearing impaired viewers.
- **Picture Adjustments Using The Remote Control** - The On-Screen display allows precise remote control adjustment of BRIGHTNESS, CONTRAST, COLOR, TINT and SHARPNESS.
- **Programmable TV Sleep Timer** - Operable from the remote control, the TV can be programmed for up to 240 minutes to turn off automatically.
- **V-Chip** - The V-Chip function can read the rating of a broadcast program or movie content if the program is encoded with this information. V-Chip will allow you to set a restriction level.
- **Digital Audio Jack (Coaxial)** - When a component with a built-in Dolby Digital decoder is connected, Dolby Digital sound can produce the effect of being in a movie theater or a concert hall.
- **HDMI/Component Video Jacks** - A VCR, DVD player, satellite receiver or other audio/video component can be connected to this unit.
- **On-Screen 3 Languages Display** - You can select one of 3 languages, English, French or Spanish for on-screen programming.

* Manufactured under license from Dolby Laboratories. Dolby and the double-D symbol are trademarks of Dolby Laboratories.

* The terms HDMI and HDMI High-Definition Multimedia Interface, and the HDMI Logo are trademarks or registered trademarks of HDMI Licensing LLC in the United States and other countries.

Power source

TO USE AC POWER

1. Connect the AC cord plug into this unit's AC INPUT jack.
2. Connect the AC cord into an AC outlet.

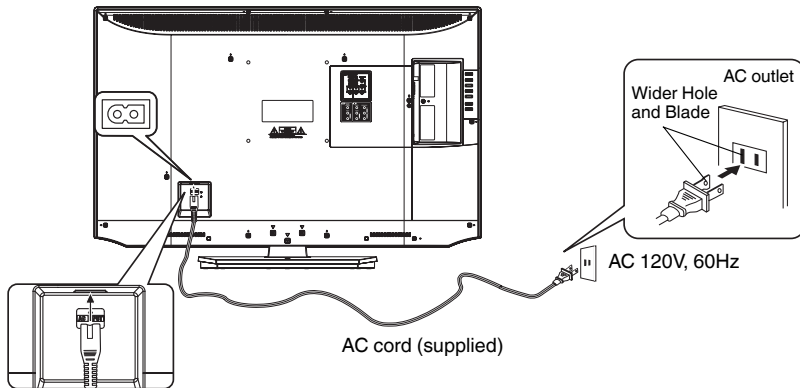

NOTE:

- Please make sure to insert the cord securely at both the LCD TV and the wall outlet.
- The AC cord has a polarized type AC line plug. If the supplied AC cord does not match your AC outlet, contact a qualified electrician.

WARNING:

- DO NOT CONNECT THIS UNIT TO THE POWER USING ANY DEVICE OTHER THAN THE SUPPLIED AC CORD. THIS COULD CAUSE FIRE, ELECTRICAL SHOCK, OR DAMAGE.
- DO NOT USE WITH A VOLTAGE OTHER THAN THE POWER VOLTAGE SPECIFIED. THIS COULD CAUSE FIRE, ELECTRICAL SHOCK, OR DAMAGE.

CAUTION:

- WHEN THIS UNIT IS NOT USED FOR A LONG TIME, (E.G., AWAY ON A TRIP) IN THE INTEREST OF SAFETY, BE SURE TO UNPLUG IT FROM THE AC OUTLET.
- DO NOT PLUG/UNPLUG THE AC CORD WHEN YOUR HANDS ARE WET. THIS MAY CAUSE ELECTRICAL SHOCK.
- IF YOU NEED TO REPLACE THE SUPPLIED AC ADAPTER OR AC CORD, THE SPECIFIED ONE IS RECOMMENDED. CONTACT CUSTOMER SERVICE AT 1-800-289-0980.

Contents

Before using your unit

IMPORTANT SAFETY INSTRUCTIONS	3
SAFETY PRECAUTIONS	5
How to attach the stand	6
How to remove the stand	6
Features.....	7
Power source	7
Contents	8
Parts and functions	9
Remote control	10
Antenna connections	11
Cable TV connections.....	11
Connections to other equipment.....	12

TV operation

Starting setup	15
TV operation	15
Quick guide for menu operation	16
Convenience functions	17
Channel setup.....	20
Labeling channels.....	21
Setting the Lock	21
Closed Caption	23
CC options.....	23
Aspect Ratio	24
Media Playback	25

Additional information

Reception disturbances	27
Troubleshooting	28
Specifications	29
limited WARRANTY	30

Parts and functions

Front

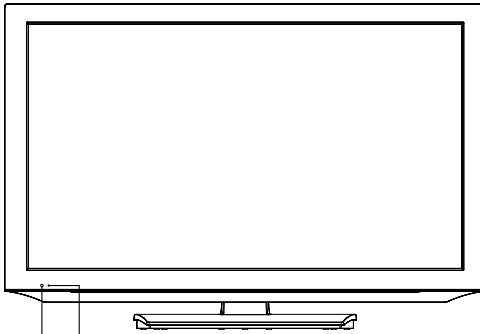

Power Indicator
Red: Standby
Green: On

Remote sensor

Left Side

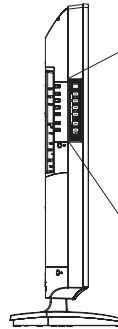

POWER button
CH (CHANNEL) $\wedge/\vee/\blacktriangle/\blacktriangledown$ buttons
VOL (VOLUME) $+/-/\blacktriangleright/\blacktriangleleft$ buttons
MENU button
INPUT/ENTER button

To display the menu screen.
Press **MENU** button to display the menu screen.
CH (CHANNEL) $\wedge/\vee/\blacktriangle/\blacktriangledown$ buttons, **VOL (VOLUME)** $+/-$ buttons and **INPUT/ENTER** button can be used to select the desired setting during the menu screen operations.

Rear

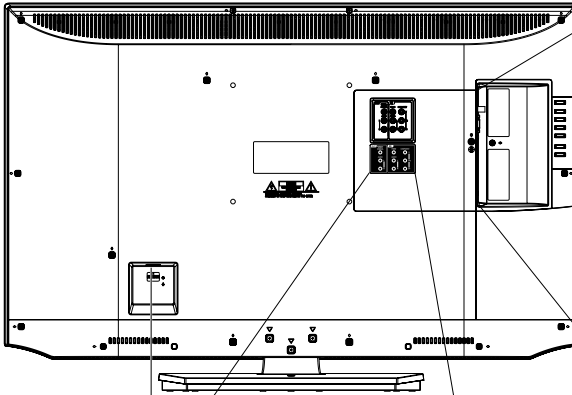

AC INPUT jack
DIGITAL AUDIO COAXIAL OUT jack
AUDIO OUT jacks

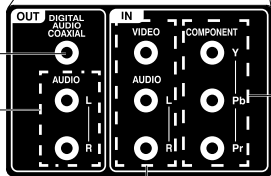

VIDEO IN jacks
(VIDEO/AUDIO (L/R))

Left Side

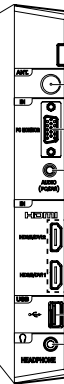

ANT. (RF) IN jack
PC MONITOR IN jack
PC/DVI AUDIO IN jack
HDMI/DVI1/2 IN jacks
USB INPUT
HEADPHONE jack

Remote control

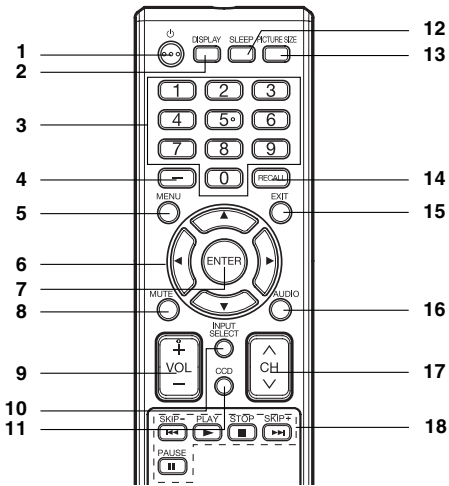

- 1. POWER Button** - Use to turn the power on/off to the TV.
- 2. DISPLAY Button** - When you press this button, the current information will be displayed on a screen. To remove the display from the screen, press this button again.
- 3. Direct Channel Selection Buttons (0-9)** - Allows direct access to any channel of the TV.
- 4. - Button** - This button is used when selecting digital channels.
- 5. MENU Button** - Use to display the On-Screen menu function.

- 6. CURSOR ▲/▼/◀/▶ Buttons** - Use to operate the menu functions of the TV.
- 7. ENTER Button** - Use to enter or select information for On-Screen operations.
- 8. MUTE Button** - To turn off the sound, press this button once. The TV will be silenced and the symbol will appear on the screen. The muting feature can be released by pressing the **MUTE** button again or one of the **VOL (VOLUME) + / -** buttons.
- 9. VOL (VOLUME) + / - Buttons** - Press the + button to increase, or the - button to decrease the sound level.
- 10. INPUT SELECT Button** - Use to change the external input.
- 11. CCD Button** - Use to select Closed Caption to "CC Off", "CC On" or "CC on Mute".
- 12. SLEEP Button** - To set the TV to turn off after a preset amount of time, use the **SLEEP** button on the remote control.
- 13. PICTURE SIZE Button** - Use to change the picture size.
- 14. RECALL Button** - This button allows you to go back to the previous channel selected by just pressing the **RECALL** button. Press this button again to return to the channel you were watching.
- 15. EXIT Button** - Press to remove setup menu.
- 16. AUDIO Button** - Change soundtrack language.
- 17. CH (CHANNEL) ▲ / ▼ Buttons** - To change the channels of the TV.
- 18. USB Media control buttons** - See page 25.

Before using the remote control, batteries must first be installed.

HOW TO INSTALL BATTERIES

1. Open the battery compartment cover.



2. Install two "AAA" batteries (supplied).

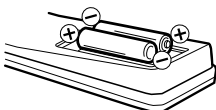

3. Replace the battery compartment cover.

Use two "AAA" size batteries. The batteries may last approximately one year depending on how much the remote control is used. For best performance, it is recommended that batteries should be replaced on a yearly basis, or when the remote operation becomes erratic. Do not mix old and new batteries or different types.

BATTERY PRECAUTIONS

These precautions should be followed when using batteries in this device:

- Use only the size and type of batteries specified.
- Be sure to follow the correct polarity when installing the batteries as indicated in the battery compartment. Reversed batteries may cause damage to the device.
- Do not mix different types of batteries together (e.g. Alkaline, Carbon-zinc or Rechargeable) or old batteries with fresh ones.
- If the device is not to be used for a long period of time, remove the batteries to prevent damage or injury from possible battery leakage.
- Do not try to recharge batteries not intended to be recharged; they can overheat and rupture. (Follow battery manufacturer's directions.)

Antenna connections

If you are using an indoor or outdoor antenna, follow the instructions below that correspond to your antenna system. If you are using a Cable TV service, see "Cable TV connections".

Combination VHF/UHF Antenna (Single 75 ohm cable)

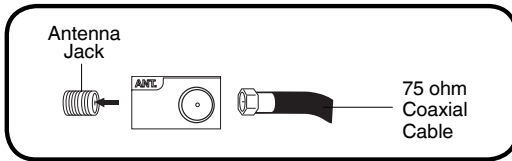

Connect the 75 ohm cable from the combination VHF/UHF antenna to the Antenna Jack.

Cable TV connections

This TV has an extended tuning range and can tune most cable channels without using a Cable TV Converter box. Some cable companies offer "premium pay channels" where the signal is scrambled. Descrambling these signals for normal viewing requires the use of a descrambler device which is generally provided by the Cable TV company.

For subscribers to basic Cable TV service

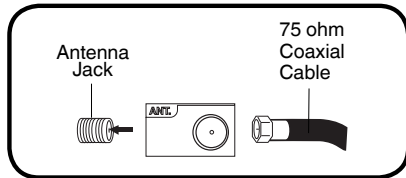

For basic Cable TV service not requiring a Converter/Descrambler box, connect the 75 ohm Coaxial Cable directly to the Antenna Jack on the back of the TV.

For subscribers to scrambled Cable TV service

If you subscribe to a Cable TV service which requires the use of a Converter/Descrambler box, connect the incoming 75 ohm Coaxial Cable to the Converter/Descrambler box. Using another 75 ohm Coaxial Cable, connect the output jack of the Converter/Descrambler box to the Antenna Jack on the TV. Follow the connections shown below. Set the TV to the output channel of the Converter/Descrambler box (usually channel 3 or 4) and use the Converter/Descrambler box to select channels.

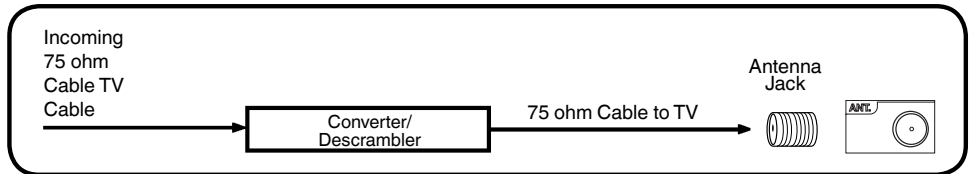

For subscribers to unscrambled Cable TV service with scrambled premium channels

If you subscribe to a Cable TV service in which basic channels are unscrambled and premium channels require the use of a Converter/Descrambler box, you may wish to use a signal Splitter and an A/B Switch box (available from the Cable TV company or an electronics supply store). Follow the connections shown below. With the switch in the "B" position, you can directly tune any unscrambled channels on your TV. With the switch in the "A" position, tune your TV to the output of the Converter/Descrambler box (usually channel 3 or 4) and use the Converter/Descrambler box to tune scrambled channels.

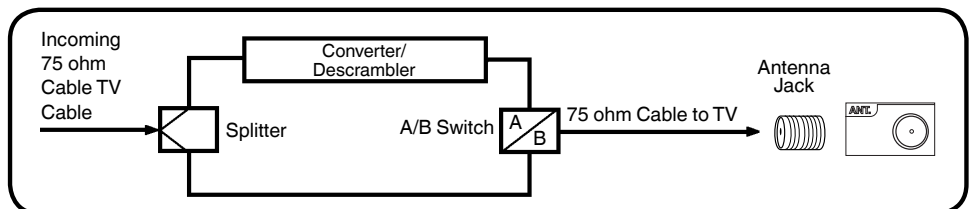

Connections to other equipment

The exact arrangement you use to interconnect various video and audio components to this unit is dependent on the model and features of each component. Check the Owner's Manual provided with each component for the location of video and audio inputs and outputs.

To connect the TV to a VCR

Rear of the unit

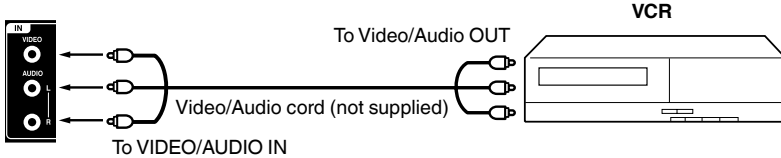

To connect the TV to a DVD player with Component Video Input

You can enjoy a high quality picture by connecting the unit's COMPONENT VIDEO OUT jacks of your DVD player with the component video cables (not supplied).

Rear of the unit

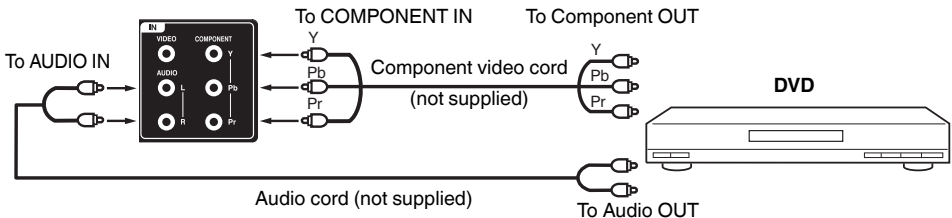

NOTE:

- Component Video input of the unit are for use with a device which output 480i/1080i interlaced signals and 480p/720p progressive signals.

To connect the TV to a camcorder, or a game console

To playback from a camcorder, connect the camcorder to the unit as shown.

This unit can also be used as a display device for many video games. However, due to the wide variety of signals generated by these devices and subsequent hook-up variations required, they have not all been included in the suggested connection diagrams. You'll need to consult each component's Owner's Manual for additional information.

Rear of the unit

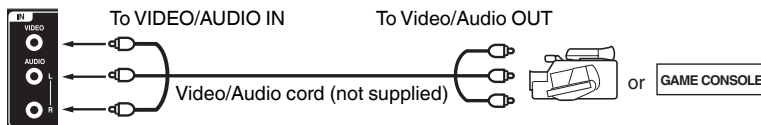

Connections to other equipment

To connect an audio system

This connection allows you to use an audio amplifier and external speakers, and adjust the audio level using the TV's remote control.

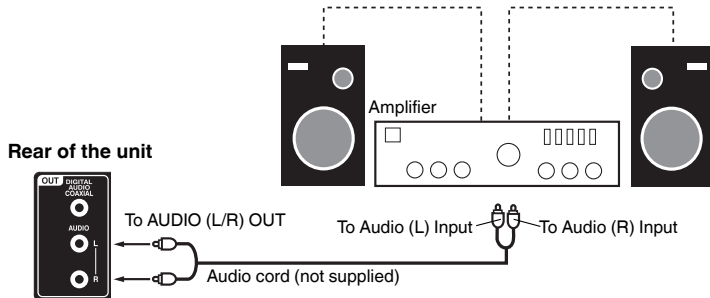

NOTE:

- To hear sound when using an external audio amplifier, the volume of both the TV and the amplifier must be set above 0 (zero).
- For example, if the volume of the TV is set to 0, you will not be able to hear any sound, even if the volume of the amplifier is at its highest level.

Using an AV Amplifier with built-in digital surround

If you are using an AV Amplifier with built-in digital surround sound, you can enjoy various audio systems including Dolby Digital Surround audio that sounds just like the movie.

Connect an AV amplifier with built-in Dolby Digital decoder, etc. as shown below.

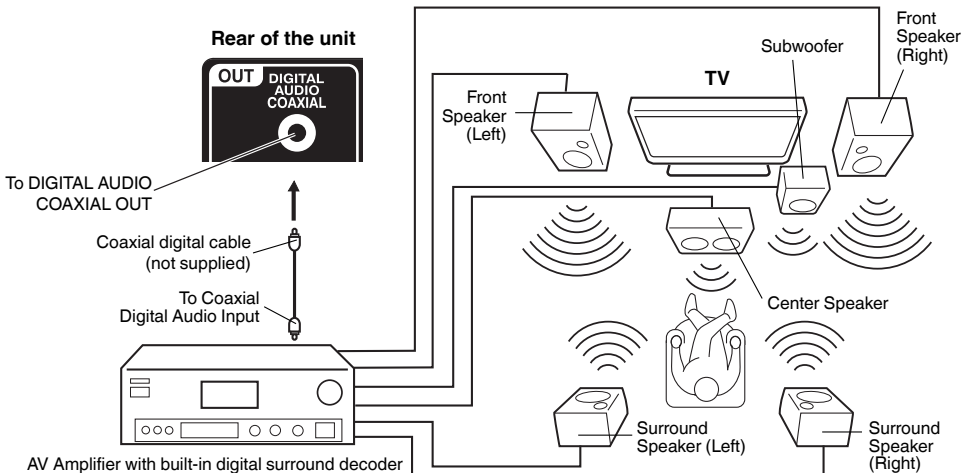

NOTE:

- When you are viewing digital broadcast, this unit will not work in conjunction with DTS audio or MPEG audio. There will be no sound output if connected to an AV amplifier with a built-in DTS decoder or MPEG decoder.

Connections to other equipment

To connect a HDMI or a DVI device to the unit

The HDMI input receives digital audio and uncompressed video from a HDMI device or uncompressed digital video from a DVI device.

When you connect to a DVI device with a HDMI-to-DVI adapter cable, it transfers only video signal. Separate analog audio cords required.

Left of the unit

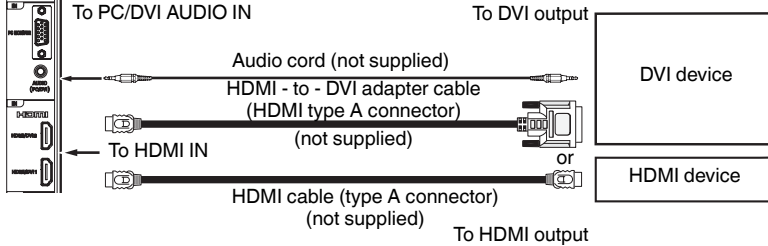

NOTE:

- When using HDMI/DVI1/2 IN to connect your HDMI or DVI devices, you must select the corresponding audio input source (HDMI or DVI) on the menu screen. Otherwise you will only see the image with no sound.

To connect the TV to a PC (Personal Computer)

BEFORE YOU CONNECT THIS TV TO YOUR PC, CHANGE THE ADJUSTMENT OF YOUR PC'S RESOLUTION AND REFRESH RATE (60 HZ).

Connect one end of a (male to male) VGA cable to the video cord of the computer and the other end to the VGA connector PC MONITOR IN on the rear of the TV. Attach the connectors firmly with the screws on the plug. In case of a Multimedia computer, connect the audio cord to the audio output of your Multimedia computer and to the AUDIO IN connector of the PC/DVI AUDIO IN jack of the TV. You can also connect the PC with HDMI cable. If you use HDMI cable, you don't have to connect the audio cord. If you use DVI-to-HDMI cable, please connect audio cord as same way as VGA cable.

Press **INPUT SELECT** on the remote control to select PC mode.

Switch on the computer. The TV can operate as the computer monitor.

Left of the unit

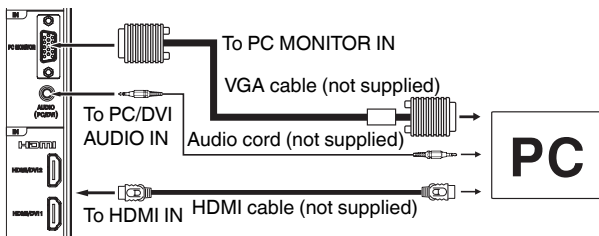

Monitor Display modes

Mode	Resolution	Refresh rate
VGA	640x480	60/ 75 Hz
VGA	720x400	70Hz
SVGA	800x600	60/ 75 Hz
XGA	1024x768	60/ 70/ 75 Hz
WXGA	1360x768	60Hz
SXGA	1280x1024	60Hz
WXGA+	1440x900	60Hz
WSXGA+	1680x1050	60Hz
FHD	1920x1080	60Hz

To return to normal mode

Press **INPUT SELECT** again.

NOTE:

- The on-screen displays will have a different appearance in PC mode than in TV mode.
- If there is no video signal from the PC when the unit is in PC mode, "No Signal" will appear on the TV-screen.
- When the PC connected to the HDMI terminal and 1920x1080 resolution (FHD) is selected, the top and bottom, right and left edges of the picture may be hidden on all picture sizes. In this case, use the PC MONITOR IN jack (VGA cable) is recommended to connect.
- When the PC's resolution is set to 1920 x 1080/60 Hz (FHD mode), a signal that differs from the FHD signal, which has been confirmed operational on this TV, may appear depending on the PC used. In this case, "Auto" or other Position Adjustment functions may fail to correct the image position. To solve this problem, change the PC settings to select another resolution.

Starting setup

The Setup Wizard menu appears the first time you turn on the TV, and assists you to specify the Air/Cable setting, and program your channels automatically.

IMPORTANT: Make sure that the antenna or cable TV system connection is made!

- 1 To turn on the TV, press **POWER**. (POWER indicator on the front of the unit changes green. It may take approx. 10 seconds for a picture to appear on screen.) The Setup Wizard function begins.



- 2 Press **▲** or **▼** to select "Menu Language", then press **◀** or **▶** to select desired language. Press **▼** or **ENTER**.
- 3 Press **◀** or **▶** to select "Store" or "Home". This product qualifies for ENERGY STAR In Home mode default setting. Then press **▼** or **ENTER**.

NOTE:

- This unit has been preset to STORE brightness. This setting does not qualify under ENERGY STAR. To reduce brightness and energy consumption, change setting to 'HOME'. This setting does qualify under ENERGY STAR.

- 4 Press **▶** or **ENTER** to go to next step.
- 5 Press **◀** or **▶** to select your time zone, then press **▼** or **ENTER**.
 - In the rare event that you live within broadcast range of two stations in two different time zones, the TV may recognize the wrong station for the auto clock set.
- 6 Press **◀** or **▶** to select daylight saving time on or off, then press **▼** or **ENTER**.
- 7 Press **◀** or **▶** to select desired time format, then press **▼** or **ENTER**.
- 8 Press **▶** or **ENTER** to go to next step.
- 9 Press **▲** or **▼** to select "Air/Cable", then press **◀** or **▶** to select signal type that you using, then press **▼** or **ENTER**.
- 10 Press **▶** or **ENTER** to go to next step.

- 11 Auto Scan will begin. After tuning is completed, the TV channel appears on the screen.
 - Depending on the reception condition, it may take up to 30 minutes to complete memorizing digital cable channels. Please allow the process to complete without interruption.

NOTE:

- If you press **MENU** or **EXIT** in the process of "Auto Scan", the Auto Scan stops and changes to normal screen.
- When you make a menu selection, your changes occur immediately. You do not have to press **MENU** to see your changes.

TV operation

- 1 To turn on the TV, press **POWER**. (POWER indicator on the front of the unit changes green. It may take approx. 10 seconds for a picture to appear on screen.)
- 2 Adjust the volume level by pressing **VOL +** or **-**. The volume level will be indicated on the screen by brown bars. As the volume level increases, so do the number of bars. If the volume decreases, the number of brown bars also decreases.
- 3 Set the signal type option to the appropriate position (see "Air/Cable selection" on page 20).
- 4 Press the **Direct Channel Selection (0-9, -)** buttons to select the channel. (If you press only channel number, channel selection will be delayed for a few seconds.)

TO SELECT ANALOG CHANNELS

- 1-9: Press 1-9 as needed. Example, to select channel 2, press **2**, then press **ENTER**.
- 10-99: Press the 2 digits in order. Example, to select channel 12, press **1, 2**, then press **ENTER**.
- 100-135: Press the 3 digits in order. Example, to select channel 120, press **1, 2, 0**, then press **ENTER**.

TO SELECT DIGITAL CHANNELS

- Press the first 1-3 digits, then press the **-** button, followed by the remaining number. Example, to select channel 15-1, press **1, 5, -, 1**, then press **ENTER**.
- If a channel is selected with only audio content, "Audio Only" will be displayed on the screen.
 - If a channel is selected with a weak digital signal, "No Signal" will be displayed on the screen. The same program may be available on either an analog channel or a digital channel. You may choose to watch either format.

VHF/UHF/CABLE CHANNELS

Air	Cable
VHF 2-13	VHF 2-13
UHF 14-69	STD/HRC/IRC 14-36 (A) (W) 37-59 (AA) (WW) 60-85 (AAA) (ZZZ) 86-94 (86) (94) 95-99 (A-5) (A-1) 100-135 (100) (135) 01 (4A)

NOTE:

- If a channel with no broadcast is selected, the sound will automatically be muted.
- It may take a few seconds for a digital channel picture to appear on screen after being selected.

To select the video input source

To view a signal from another device connected to your TV, such as a VCR player, press **INPUT SELECT**, then press **▲** or **▼**, then press **ENTER**.

CH \wedge / \vee

Press and release **CH \wedge / \vee** . The channel automatically stops at the next channel set into memory.

For proper operation, before selecting channels, they should be set into the memory. See "Channel setup" on page 20.

DISPLAY

Press **DISPLAY** to display the current information on the screen.

When the TV receives a digital signal, the digital information will appear.

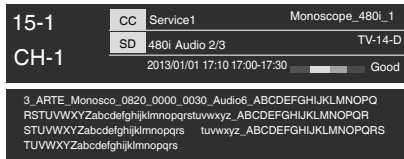

- Channel number
- Channel label (if preset)
- V-Chip rating
- Program guide
- Resolution
- DTV Signal condition
- Broadcast program name
- Current date and time
- Audio language
- Closed Caption

Press **DISPLAY** again to clear the call display.

NOTE:

- After a few seconds, DISPLAY screen will return to normal TV operation automatically.

SLEEP

To set the TV to turn off after a preset amount of time, press **SLEEP** on the remote control. The clock will change for each press of the **SLEEP** button (Off, 5 min, 10 min, ..., 240 min). To confirm the sleep timer setting, press **SLEEP** and the remaining time will be displayed for a few seconds. To cancel the sleep timer, press **SLEEP** repeatedly until the display turns to Off.

Quick guide for menu operation

Call menu and for example: Select Menu Language.

- 1 Press **INPUT SELECT** to select TV mode.
- 2 Press **MENU**. The TV menu screen will appear.

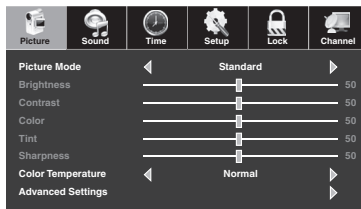

- 3 Press \leftarrow or \rightarrow to select "Setup", then press ∇ .
- 4 Press \blacktriangle or \blacktriangledown to select "Menu Language", then press \leftarrow or \rightarrow to select the desired language.
... on the following pages the menu can be called in the same way as here.
- 5 Press **MENU** to return to the previous screen.

NOTE:

- If no buttons are pressed for more than about 30 (depending on your setting) seconds, the menu screen will return to normal operation automatically.

Convenience functions

You can change the default settings by pressing the **MENU** button on your remote, then select the one of the icons at the top of the menu - follow the On-Screen prompts to set your preferences.

Icon	Selected Items	Setup hint	
Picture	Picture Mode		
	Power Saving	The darker the brightness for power-saving	
	Standard	Standard picture quality	
	Dynamic	Bright and dynamic picture	
	Soft	Soft edge picture setting	
	User	Your personal preferences	
		Brightness	You can adjust the picture quality to your preference. <ul style="list-style-type: none"> • Available only when you selected "User". • "Tint" is available only in Analog TV and AV mode.
		Contrast	
		Color	
		Tint	
		Sharpness	
		Color Temperature	Cool (Bluish) / Normal (Neutral) / Warm (Reddish)
		Advanced Settings	
		Aspect Ratio	See page 24.
		Noise Reduction	To set the level of decreasing noises included in the video signal.
		Medium / High / Off / Low	
		DBC	Use this feature to change the Black level automatically according to the brightness of an image. The Black level will become dark in a dark scene. If "ECO" is selected, the power consumption is reduced. <ul style="list-style-type: none"> • DBC is not available in Media mode.
		Off / ECO / On	
		DLC	DLC (Dynamic Luminance Contrast) function would adjust the luminance follow the average brightness automatically
		Off / On	
		HDMI Mode	Select the HDMI input signal as Video (for video) or Graphic (for PC).
		Video / Graphic	
		MFC Level	To change the setting of motion enhancement. A smoother motion may be obtained by this setting. <ul style="list-style-type: none"> • MFC Level is not available in HDMI, PC and Media mode.
	Off / Low / Medium / High		

Convenience functions

Icon	Selected Items	Setup hint
Sound	Equalizer Settings	
	Equalizer Mode	
	Standard / Music / Movie / Sports	You can choose a basic equalizer mode. Depending on this setting, the following detail setting is set to default value of each mode.
	User	
	150 / 500 / 1K / 5K / 10K Hz	The setting of this item adjusts the audio level of its frequency corresponding to each setting. • Available only when you selected "User".
	Balance	Adjust the left and right sound channel volume.
	MTS	
	Stereo / SAP / Mono	The multi-channel TV sound (MTS) feature provides high-fidelity stereo sound. MTS also can transmit a second audio program (SAP) containing a second language or other audio information. This item is valid only when the analog broadcast.
	Audio Language	
	English / French / Spanish	When two or more audio languages are included in a digital signal, you can select one of the audio language. (This function is available only for digital broadcast.)
	Digital Audio Output	
	Raw / Off / PCM	Select the format for your digital audio output. If you have connected an amplifier / receiver to the digital audio jack on your TV.
	Surround Sound	
	Off / On	The dynamic presence and sound created offers a thoroughly enjoyable listening experience.
	AVL	
Off / On	Volume level can be adjusted automatically by the sound level.	
Time	Sleep Timer	
	Off / 5 / 10 / 15 / 30 / 60 / 90 / 120 / 180 / 240 min	Sleep timer switches the TV to standby after a defined period of time. To cancel the Sleep Timer, set to "Off".
	Time Zone	
	Select your local time zone for auto clock feature. You can select Newfoundland, Atlantic, Eastern, Central, Mountain, Pacific, Alaska, Hawaii and Samoa.	
	Daylight Saving Time	
	Off / On	If you want to activate the daylight saving time, select "On".
	Time Format	
	12-hour / 24-hour	Select the time format.
Auto Clock		
Off / On	The Auto clock function will automatically set the built-in clock (Year, Month, Day and Time) when the TV is connected to an antenna or cable TV system and it is turned off. As the TV searches for a receivable station in your area and it receives a broadcast signal for Auto Clock, the Auto Clock needs several minutes to set itself.	
Clock		
Using the ▲/▼/◀/▶, the setting value is changed. • Available only when you selected "Auto Clock" to "Off".		

Convenience functions

Icon	Selected Items	Setup hint
Setup		
	Menu Language	
	English / Français / Español	You can choose from three different languages (English, Français (French) and Español (Spanish)) for the on-screen displays. Select the language you prefer first, then proceed with the other menu options.
	OSD Timeout	
	5 / 15 / 30 / 45 / 60 Sec.	You can set the display time of OSD Menu.
	Closed Caption	See page 23.
	Over Scan	To adjust the size of the display by removing excess or unattractive when set it to "On".
	Off / On	
	Input Label	The Input Label feature allows you to label each input source for your TV. You can select label from default value or input by yourself with ▲/▼ (alphabet select) / ◀/▶ (select character / position).
	Default / Antenna / Cable / Satellite / DTV / DVD / Blu-ray / HD-DVD / XBOX / Wii / PS3 / Game / Computer / VCR / DV / Custom (10 characters)	
	PC Settings (available only for PC mode)	
	H-Pos	To adjust the horizontal placing of the image.
	V-Pos	To adjust the vertical placing of the image.
	Clock	Eliminates the vertical (CLOCK) interfering lines.
	Phase	Eliminates the horizontal (PHASE) interfering lines.
	Auto	To adjust the all PC settings automatically.
	Other Settings	
	Audio Only	You can turn off the picture on your TV and listen to the program audio only. To exit audio only mode, press any buttons (except VOL +/-, MUTE) on your remote control or unit.
	Off / On	
	TV Location	Select location of TV. Usually, select "Home".
	Store / Home	
	Restore Default	Select "Yes", then press ENTER . Restore Picture, Sound and Time (Sleep Timer and Time Format only) (except "Menu Language") settings to the default factory settings.
	No / Yes	
	Setup Wizard	See page 15.
	Lock	See page 21.
	Channel	See page 20.

Channel setup

This TV is equipped with a channel memory feature which allows channels to skip up or down to the next channel set into memory, skipping over unwanted channels. Before selecting channels, they must be programmed into the TV's memory. To use this TV with an antenna, set the signal type option to the Air mode. When shipped from the factory, this menu option is in the Cable mode.

Air/Cable selection

- 1 Select "Channel ⇒ Air/Cable".
- 2 Press ◀ or ▶ to select "Air" or "Cable".

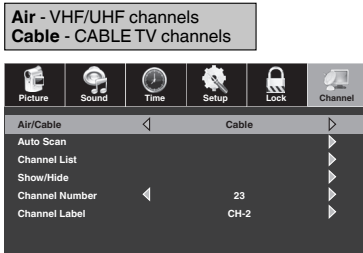

NOTE:

- It may take a few seconds for a digital channel picture to appear on screen after being selected.

Auto Scan

- 1 Select "Channel ⇒ Auto Scan", then press ▶ or ENTER.

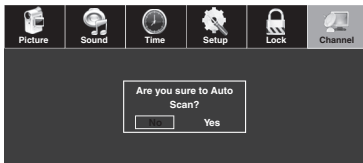

- 2 In confirmation window, Press ▶ to select "Yes", then press ENTER. The TV will begin memorizing all the channels available in your area.
 - It may take from 15 minutes to 30 minutes to complete memorizing digital cable channels. Depending on the reception condition, a bar display may not advance for several minutes, please be patient.
 - If you press **MENU** during search, digital channel search will stop.

NOTE:

- Memorizing channels is best accomplished during evening "PRIMETIME" hours, as more stations are broadcasting digital signals. Memorizing channels can only be accomplished while a station is broadcasting a digital signal to set that channel into memory.
- If you are unsure of the digital channels available in your area, you may visit www.antennaweb.org to

receive a list based on your address or zip code. Should you require further assistance you may call our toll-free customer service line at 1-800-289-0980.

- New digital channels may be added to your area periodically, it is recommended to perform the "Auto Scan" procedure regularly.

- 3 The new channel will be added into the channel memory.

Show/Hide channel

You can select the channel that you want to skip.

- 1 Select "Channel ⇒ Show/Hide", then press ▶ or ENTER.
- 2 Press ▲ or ▼ to select the channel that you want to skip.

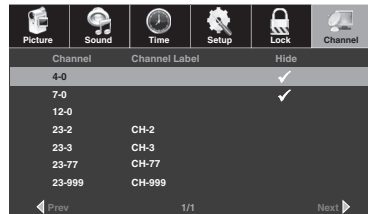

- 3 Press ENTER to assign ✓ mark for unwanted channel.
- 4 Repeat steps 2 - 3 for other channels you want to show/hide.

Labeling channels

Channel label appear with the channel number display each time you turn on the TV, select a channel, or press DISPLAY. You can choose any 7 characters to identify a channel.

To create channel labels

- 1 Select "Channel ⇒ Channel Number".
- 2 Press ◀ or ▶ to select a channel you want to label, then press ▼ to select "Channel Label". Then press ▶ or ENTER.
- 3 Press ▲ or ▼ repeatedly until the character you want appears in the first space.

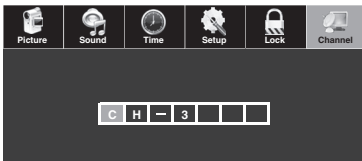
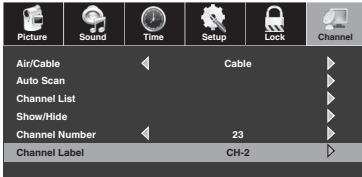

If the character which you desire appears, press ▶. You can also change the position which input character by pressing ◀ or ▶. Repeat this step to enter the rest of the characters.

- 4 Repeat steps 1-3 for other channel. You can assign a label to each channel.
- 5 When you finish inputting the label name, press EXIT to return to the normal screen.

NOTE:

- The channel labels will be reset after "Auto Scan" on page 20.

Setting the Lock

An age limitation can be set to restrict children from viewing or hearing violent scenes or pictures that you may choose to exclude. The restriction applies to "TV" and "MPAA" if this data is transmitted. You may set this restriction separately. To use the Lock function, you must register a password.

To register a password

- 1 Select "Lock", then press ▼.
- 2 Press 0000 using **Number buttons (0-9)**. (This is default password.)



"*" appears instead of the number.

NOTE:

- If you forget the password, contact Customer Service at 1-800-289-0980 for assistance. Your original remote control will be required.
- To avoid forgetting the password, write it down and keep in a safe place.

How to enter the Lock menu

- 1 Select "Lock" menu, then press ▼.
- 2 Use **Number buttons (0-9)** to enter your password.

To Lock connected devices

- 1 In the Lock menu, press ◀ or ▶ to set "System Lock" to "On".
- 2 Press ▲ or ▼ to select "Input Block", then press ▶ or ENTER.

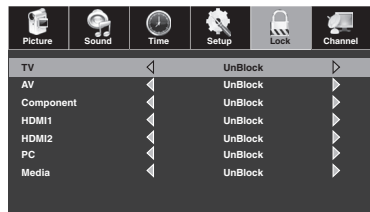

- 3 Press ▲ or ▼ to select which device will be blocked, then press ◀ or ▶ to select "Block".

NOTE:

- Blocked device will appear in Source Select window. Enter your password before watching. If you want to use such a device again, you should setting "UnBlock" in step 3.

To set the Lock

- 1 In the Lock menu, press ◀ or ▶ to set "System Lock" to "On".
- 2 Press ▲ or ▼ to select "US Rating", then press ► or ENTER.
- 3 Press ▲ or ▼ to select which rating will be used, then press ► or ENTER. Each rating below will appear.

TV Rating

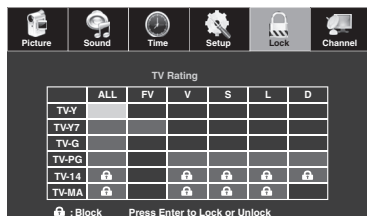

You can set the rating using age level and genre.

Age:

- TV-Y** : All children
- TV-Y7** : 7 years old and above
- TV-G** : General audience
- TV-PG** : Parental guidance
- TV-14** : 14 years old and above
- TV-MA** : 17 years old and above

Genre:

- All** : General
- FV** : Fantasy Violence
- V** : Violence
- S** : Sex
- L** : Language
- D** : Dialogue

Press ▲/▼/◀/▶ to select the desired rating, then press ENTER.

MPPAA Rating

- Off** : None
- G** : All ages
- PG** : Parental guidance
- PG-13** : Parental guidance less than 13 years old
- R** : Under 17 years old parental guidance suggested
- NC-17** : 17 years old and above
- X** : Adult only

Press ◀/▶ to select the desired rating.

- 4 Press EXIT to return to the normal screen. Lock function is activated now.

NOTE:

- The Lock function is activated only on programs and input sources that include a rating signal.

To change the password

- 1 In the Lock menu, press ▲ or ▼ to select "Change Password", then press ► or ENTER.

- 2 Enter a current password using **Number buttons (0-9)**.
- 3 Enter a new password using **Number buttons (0-9)**.
- 4 Enter the same password again to confirm. The password is now registered.

Downloading the additional Lock rating system

As a supplement to the standard Lock rating system, your television will be able to download an additional rating system, if such a system becomes available in the future.

To download the additional Lock rating system (when available)

- 1 In the Lock menu, press ◀ or ▶ to set "System Lock" to "On".
- 2 Press ▲ or ▼ to select "RRT Setting", then press ► or ENTER.
- 3 If the TV is not storing the additional rating system, the TV will begin downloading it, which may take some time to be completed.
- 4 Set your preferred content rating limits for the additional rating system.

NOTE:

- You can only download the additional Lock rating system when your TV is receiving a digital signal.
- When you download the additional rating system, it may take some time for the download to occur.
- The Lock rating information and system are not determined or controlled by the TV.
- The standard Lock rating system is available whether your TV is receiving a digital signal or not, and will block both analog and digital programs. To set the restriction level using the standard Lock rating system, select "US Rating" in step 2.
- The downloadable Lock rating system is an evolving technology, and availability, content, and format may vary.

To clear the RRT settings

- 1 In the Lock menu, press ◀ or ▶ to set "System Lock" to "On".
- 2 Press ▲ or ▼ to select "Reset RRT", then press ► or ENTER. The confirmation window will appear.
- 3 Press ► to select "Yes", then press ENTER. Your RRT Setting will clear.

Closed Caption

WHAT IS CLOSED CAPTIONING?

This television has the capability to decode and display Closed Captioned television programs. Closed Captioning will display text on the screen for hearing impaired viewers or it will translate and display text in another language.

Captions: This Closed Caption mode will display text on the screen in English or another language. Generally, Closed Captions in English are transmitted on CC1 and Closed Captions in other languages are transmitted on CC2.

Text: The Text Closed Caption mode will usually fill 1/2 of the screen with a programming schedule or other information.

1 Select "Setup ⇒ Closed Caption", then press ► or **ENTER**.

2 Press ◀ or ▶ to set "CC Mode" to "CC On" or "CC on Mute".

CC On: Captions will be displayed on the screen.

CC on Mute: Only when you press **MUTE**, captions will be displayed.

CC Off: Captions will not be displayed on the screen.

3 Press ▲ or ▼ to select "Analog CC" or "Digital CC".

When you select "Analog CC", you can choose from CC1~4, Text1~4.

When you select "Digital CC", you can choose from Service1~6 and Off.

4 Press ◀ or ▶ to select the desired Closed Caption mode for both Digital and Analog Captions.

NOTE:

- Depending on the broadcast signal, some Analog Captions will function with a Digital broadcast signal. This step prevent that two kind of captions are overlapping.

NOTE:

- If the program or video you selected is not closed-captioned, no captions will display on-screen.
- If text is not available in your viewing area, a black rectangle may appear on-screen. If this happens, set the CC Mode to "CC Off".
- When selecting Closed Captions, the captioning will be delayed approx. 10 seconds.
- If no caption signal is received, no captions will appear, but the television will remain in the Caption mode.
- Misspellings or unusual characters may occasionally appear during Closed Captioning. This is normal with Closed Captioning, especially with live programs. This is because during live programs, captions are also entered live. These transmissions do not allow time for editing.
- When Captions are being displayed, on-screen displays, such as volume and mute may be seen but may interfere with Closed Captions.
- Some cable systems and copy protection systems may interfere with the Closed Captioned signal.
- If using an indoor antenna or if TV reception is very poor, the closed caption decoder may not appear or may appear with strange characters or misspelled words. In this case, adjust the antenna for better reception or use an outdoor antenna.

- CC Mode will change to "CC Off", "CC On" or "CC on Mute" by each pressing **CCD** on the remote control.

CC options

When you have selected "Custom" as the display method, you can adjust the various setting listed below as follows:

This feature is designed to customize Digital Caption only.

1 Select "Setup ⇒ Closed Caption", then press ► or **ENTER**.

2 Press ◀ or ▶ to set "CC Mode" to "CC On" or "CC on Mute".

3 Press ▲ or ▼ to select "Option", then press ► or **ENTER**.

4 Press ▲ or ▼ to select "Mode", then press ◀ or ▶ to select "Custom".

5 Press ▲ or ▼ to select the desired item, then press ◀ or ▶ to change the setting.

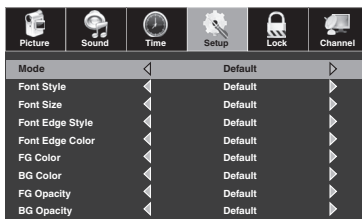

You can select from among the following items and parameters.

Font Style:

Select display font style.

Font Size:

Select display font size.

Font Edge Style:

Select display font edge style.

Font Edge Color:

Select display font edge color.

FG Color:

Select foreground color.

BG Color:

Select background color.

FG Opacity:

Select foreground opacity level.

BG Opacity:

Select background opacity level.

NOTE:

- You can not set both "FG Color" and "BG Color" as a same color.

Aspect Ratio

You can change to a variety of picture sizes—**Wide, Zoom, Cinema, Normal, Full 100% (for PC) and Point to Point (for PC)**.

Selecting the picture size

1 Select "Picture ⇒ Advanced setting ⇒ Aspect Ratio".

2 Press ◀ or ▶ to select the desired picture size, as described below.

NOTE:

- Selectable picture sizes may vary depending on the input source or broadcast signal.
- You can be select desired size of picture by pressing **PICTURE SIZE** on the remote control.

Normal

In some cases, this image will display the size of standard 4:3 with a black side bar.

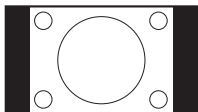

Wide (for 4:3 format programs)

To fill the screen, the right and left edges are extended, however; the center of the picture remains near its former ratio.

The top and bottom edges of the picture may be hidden.

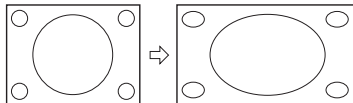

Zoom (for letter box programs with subtitles)

To fill the width of the screen, it is extended horizontally. However; it is only slightly extended at the top and the bottom.

The top and bottom edges of the picture may be hidden.



Cinema (for letter box programs)

The entire picture is uniformly enlarged—it is stretched the same amount both wider and taller (retains its original proportion).

The top and bottom edges of the picture may be hidden.

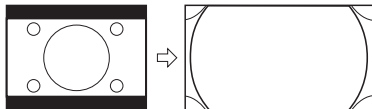

Full 100% (for PC mode only)

Full will display the picture at the maximum size.

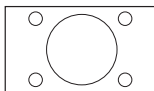

Point to Point (for PC mode only)

Detects the resolution of the signal of the image and it will be shown on the screen with same amount of pixels.



Media Playback

You can enjoy viewing pictures and movies from your USB storage device.

- 1 Connect the USB storage device into the USB Input terminal.
- 2 Press **INPUT SELECT** then press ▲ or ▼ to select "Media", then press **ENTER**.

NOTE:

- Do not disconnect a USB storage device while it is being accessed. Doing so can damage the device or the files stored on the device. You can safely connect or disconnect the USB storage device when the TV is not in media mode.
- Back up all the data in the USB storage device in case if data was lost due to unexpected accident. We do not assume any liability for the losses by misuse or malfunction.
- Not all USB storage devices are compatible with this TV.
- The character that exceeds the display area is not displayed.
- Do not use USB extension cable.
- Playable files are JPEG (.jpg/.jpeg) and Motion JPEG (.avi (MJPEG format)).

Media Browser

Media Selection

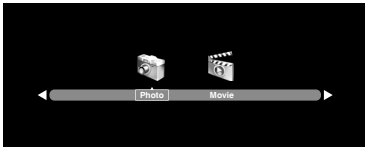

File Selection

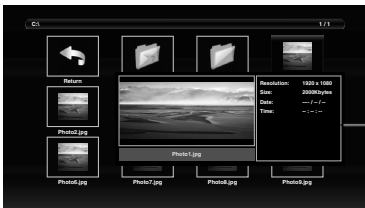

Information window

NOTE:

- The content will change in accordance with each media setting screen.















Playback files

- 1 Press ◀ or ▶ to select Photo or Movie at Media Selection and press **ENTER**.
- 2 Press ◀ or ▶ to select "C", then press **ENTER**.
- 3 Select folder or file with ▲/▼/◀/▶, and then start the playback with **ENTER**.

You can playback the files with the following remote control buttons.

Button	Action
ENTER	Press to start the playback. Press to open the folder. Press to open the operation window.
 	Press to pause the playback.
▶	Press to start the playback or slideshow.
■	Press to stop the playback.
▶▶	During the playback, press to select the next file.
◀◀	During the playback, press to select the previous file.

Details of operation commands

Icon	Operation
	Play / Resume playback. Pause.
	Skip file to reverse / forward direction.
	Stop.
	Repeat playback. Press ENTER repeatedly to select desired repeat option.
	Show the playlist. Press ▲ or ▼ and ENTER to select the playback
	Show the file information.
	Rotate the image.
	Zoom in / out.
	Move the frame from the center position.
	Review / Fast playback.
	Select start point, then select end point. Repeat material between two selected points.
	Slow-motion Playback.
	One frame is advanced each time select this command.
	Direct jump by desired time.

Reception disturbances

Most types of television interference can be remedied by adjusting the height and position of the VHF/UHF antenna. Outdoor antennas are recommended for best results. The most common types of television interference are shown below. If one of these symptoms appear when the TV is connected to a Cable TV system, the disturbance may be caused by the local Cable TV company broadcast.

IGNITION

Black spots or horizontal streaks may appear, the picture may flutter or drift. Usually caused by interference from automobile ignition systems, neon lamps or AC powered tools and appliances such as drills or hair dryers.



GHOSTS

Ghosts are caused by the television signal following two paths. One is the direct path and the other is reflected by tall buildings, hills or other large objects. Changing the direction or position of the antenna may improve the reception.



SNOW

If the TV is located far from the TV station, in a fringe reception area where the signal is weak, small dots may appear in the picture. If the signal is extremely weak, the installation of a larger external antenna may be necessary.



RADIO FREQUENCY INTERFERENCE (RFI)

Caused by two-way radios, this type of interference produces moving ripples or diagonal streaks in the picture. Some cases may cause a loss of contrast in the picture. Changing the direction and position of the antenna or installing an RFI filter may improve the picture.



PICTURE SIZE VARIATION

A slight picture size variation is normal when you adjust the CONTRAST or BRIGHTNESS settings.



CARE AND MAINTENANCE

To prevent fire or shock hazard, disconnect the TV from the power source before cleaning. The finish on the cabinet may be cleaned with mild soap and a soft, damp cloth and cared for as other furniture. Use caution when cleaning or wiping the plastic parts.

Troubleshooting

Use the following checklist for troubleshooting if you have problems with your LCD TV. Consult your local dealer or service outlet if problems persist. Be sure all connections are properly made when using with other units.

SYMPTOMS	POSSIBLE SOLUTIONS
TV does not operate.	<ul style="list-style-type: none"> • Make sure the power cord is plugged in. • Try another AC outlet. • Power is off, check fuse or circuit breaker. • Unplug unit for an hour, then plug it back in.
Poor sound or no sound.	<ul style="list-style-type: none"> • Station or Cable TV experiencing problems, tune to another station. • Check sound adjustments (VOL +/- or MUTE). • Check for sources of possible interference.
Poor picture or no picture.	<ul style="list-style-type: none"> • Station or Cable TV experiencing problems, tune to another station. • Make sure channels are set into memory. • Check antenna or Cable TV connections, adjust antenna. • Check for sources of possible interference. • Check picture control adjustments.
Poor reception on some channels.	<ul style="list-style-type: none"> • Station or Cable TV experiencing problems, tune to another station. • Make sure channels are set into memory. • Station is weak, adjust antenna to receive desired station. • Check for sources of possible interference.
Poor color or no color.	<ul style="list-style-type: none"> • Station or Cable TV experiencing problems, tune to another station. • Make sure channels are set into memory. • Check picture control adjustments. • Check antenna or Cable TV connections, adjust antenna. • Check for sources of possible interference.
Picture wobbles or drifts.	<ul style="list-style-type: none"> • Station or Cable TV experiencing problems, tune to another station. • Make sure channels are set into memory. • Cable TV company is scrambling signal. • Adjust antenna.

SYMPTOMS	POSSIBLE SOLUTIONS
Digital broadcasting screen problem.	<ul style="list-style-type: none"> • Check digital signal strength.
No CATV reception.	<ul style="list-style-type: none"> • Check all Cable TV connections. • Set Signal Type menu option to the Cable mode. • Station or Cable TV system problems, try another station.
Horizontal or diagonal bars on screen.	<ul style="list-style-type: none"> • Check antenna connections, adjust or re-direct antenna. • Check for sources of possible interference.
No reception above channel 13.	<ul style="list-style-type: none"> • Make sure Signal Type option is in the appropriate mode. • If using antenna, check UHF antenna connections.
No Remote operation.	<ul style="list-style-type: none"> • Batteries are weak, dead or inserted incorrectly. • Remote is out of range, move closer to TV (within 15 feet). • Make sure Remote is aimed at sensor. • Confirm there are no obstructions between the Remote and the TV. • Make sure the power cord is plugged in.
TV shuts off.	<ul style="list-style-type: none"> • Sleep Timer is set. • Power interrupted.
Closed Caption is not activated.	<ul style="list-style-type: none"> • TV station experiencing problems or program tuned is not closed captioned. Try another channel. • Check Cable TV connection or VHF/UHF antenna, reposition or rotate antenna. • Set closed caption decoder in the menu.
TV is not shown in your language.	<ul style="list-style-type: none"> • Select proper language in the menu options.

BLOCK NOISE / PICTURE FREEZE

Block noise or picture freeze may appear on the screen caused by weak signals, interference from automobile ignition systems, neon lamps or AC powered tools and appliances such as drills or hair dryers.



FOR CUSTOMER SERVICE, ADDITIONAL SET-UP AND OPERATING ASSISTANCE, OR TO ORDER ACCESSORIES PLEASE CALL:

1-800-289-0980

WHEN CALLING CUSTOMER SERVICE – PLEASE HAVE YOUR MODEL NUMBER READY

OR WRITE TO:
ORION SALES, INC.
 3471 N. UNION DR.
 OLNEY, ILLINOIS 62450

FOR INFORMATION ON OUR OTHER PRODUCTS, TO ORDER ACCESSORIES ONLINE,
 OR FOR RECYCLING INFORMATION, PLEASE VISIT OUR WEBSITE AT
www.sansuiproducts.com

Specifications

GENERAL

Power supply:	AC 120V, 60Hz
Power consumption:	Operation: 133W Stand by: 0.5W
Weight:	12.7kg (28.0 lbs)
Dimensions:	Width: 986.0 mm(38-13/16 inches) Height: 667.0mm(26-1/4 inches) Depth: 236.9mm(9-5/16 inches)
Operating temperature:	5°C - 40°C
Operating humidity:	Less than 80% RH
Type:	1016.1mmV(40" class/40.00 diagonal)
Display method:	Transmission TFT color LCD panel
Number of Pixels:	1920 (H) x 1080 (V)
Broadcasting system:	US System M ATSC standard (8VSB), QAM
Receiving channels:	VHF 2-13 UHF 14-69 CATV 14-36 (A)-(W) 37-59 (AA)-(WW) 60-85 (AAA)-(ZZZ) 86-94 (86)-(94) 95-99 (A-5)-(A-1) 100-135 (100)-(135) 01 (4A)
Tuner type:	Frequency synthesized
Inputs:	Video: (RCA) 1 V (p-p), 75 ohms Audio: (RCA) -8 dBm/50k ohms Component video: (Y) 1 V (p-p), 75 ohms (Pb)/(Pr) 0.7 V (p-p), 75 ohms HDMI: HDMI compliant (type A connector) HDCP compliant E-EDID compliant Suggested scan rates: 480p, 480i, 720p, 1080i, 1080p HDMI Audio: 2-channel PCM 32/44.1/48 kHz sampling frequency 16/20/24 bits per sample PC Monitor: Mini-Dsub 15pin Antenna: VHF/UHF In 75 ohms coaxial
Outputs:	Audio: 0-600mVrms/1k ohm Digital audio out: 0.5 V (p-p), 75 ohms terminated
Speakers:	40.6 mm x 121.9 mm (1-5/8 inches x 4-13/16 inches), 8 ohms x 2
Audio output power:	8.0W + 8.0W
ACCESSORIES	Remote control Batteries (AAA) x 2 AC Cord Stand Screws x 6 <ul style="list-style-type: none">• for Stand (4x12mm (5/32 x 15/32 inches)) x 3• for Frame Stand (4x35mm (5/32 x 1-23/64 inches)) x 3 Frame Stand

Designs and specifications are subject to change without notice.

SANSUI® *limited* **WARRANTY**

40" CLASS LCD HDTV

ORION warrants this product to be free from manufacturing defects in material and workmanship under normal use and conditions for a period of 1 year from date of original purchase in the United States.

Should service be necessary under this warranty for any reason due to a manufacturing defect or malfunction during the first 12 months from date of original purchase, ORION will provide carry-in service only by an ORION authorized Independent Service Center at no charge. Also, if an original part fails due to manufacturing defect in material and workmanship within one year from date of original purchase we will replace the defective part, provided the defect or malfunction is verified along with dated proof of purchase.

There are ORION authorized Independent Service Centers located throughout the country. For the one nearest you, DIAL TOLL FREE: 1-800-289-0980 or visit our website at www.sansuiproducts.com. ORION will not be liable for damages incurred in shipment of the unit. If there are no ORION authorized Independent Service Centers in your area please call - 1-888-296-7466 for assistance.

Note: This warranty is void if the product is:

- (a) Damaged through negligence, misuse, abuse, or accident.
- (b) Used in a commercial application or rentals.
- (c) Modified or repaired by anyone other than an Independent Service Center authorized by ORION to effect warranty repairs to the class of product or by the ORION Factory Service Center.
- (d) Damaged because it is improperly connected to the equipment of other manufacturers.

This warranty does not cover:

- (a) Damage to equipment not properly connected to the product.
- (b) Costs incurred in the shipping of the product to an ORION authorized Independent Service Center or ORION Factory Service Center.
- (c) Damage or improper operation of unit caused by customer abuse, misuse, negligence, or failure to follow operating instructions provided with the product.
- (d) Ordinary adjustments to the product which can be performed by customer as outlined in the owner's manual.
- (e) Signal reception problems caused by external antenna or cable systems.

THIS WARRANTY IS NON TRANSFERABLE AND APPLIES ONLY TO THE ORIGINAL PURCHASER AND DOES NOT EXTEND TO SUBSEQUENT OWNERS OF THE PRODUCT. ANY APPLICABLE IMPLIED WARRANTIES, INCLUDING THE WARRANTY OF MERCHANTABILITY, ARE LIMITED IN DURATION TO A PERIOD OF THE EXPRESS WARRANTY AS PROVIDED HEREIN BEGINNING WITH THE DATE OF ORIGINAL PURCHASE AT RETAIL AND NO WARRANTIES, WHETHER EXPRESS OR IMPLIED SHALL APPLY TO THIS PRODUCT THEREAFTER. ORION MAKES NO WARRANTY AS TO THE FITNESS OF THE PRODUCT FOR ANY PARTICULAR PURPOSE AND USE.

UNDER NO CIRCUMSTANCES SHALL ORION BE LIABLE FOR ANY LOSS, DIRECT, INDIRECT, INCIDENTAL, SPECIAL, OR CONSEQUENTIAL DAMAGE ARISING OUT OF OR IN CONNECTION WITH THE USE OF THIS PRODUCT.

THIS WARRANTY IS VALID ONLY IN THE UNITED STATES OF AMERICA. THIS WARRANTY GIVES YOU SPECIFIC LEGAL RIGHTS, HOWEVER, YOU MAY HAVE OTHER RIGHTS WHICH MAY VARY FROM STATE TO STATE. SOME STATES DO NOT ALLOW LIMITATION ON IMPLIED WARRANTIES OR EXCLUSION OF CONSEQUENTIAL DAMAGE, THEREFORE THESE RESTRICTIONS MAY NOT APPLY TO YOU.

ORION SALES, INC.
3471 N. UNION DR.
OLNEY, ILLINOIS 62450

Memo

.....
.....
.....
.....
.....
.....
.....
.....
.....
.....
.....
.....
.....
.....
.....
.....
.....
.....
.....
.....
.....
.....
.....
.....
.....
.....
.....
.....
.....
.....
.....
.....
.....
.....
.....
.....
.....
.....
.....
.....
.....
.....
.....
.....
.....
.....
.....
.....
.....
.....
.....
.....
.....
.....

Free Manuals Download Website

<http://myh66.com>

<http://usermanuals.us>

<http://www.somanuals.com>

<http://www.4manuals.cc>

<http://www.manual-lib.com>

<http://www.404manual.com>

<http://www.luxmanual.com>

<http://aubethermostatmanual.com>

Golf course search by state

<http://golfingnear.com>

Email search by domain

<http://emailbydomain.com>

Auto manuals search

<http://auto.somanuals.com>

TV manuals search

<http://tv.somanuals.com>