

SERVICE MANUAL

SANYO

12KHS32

FILE NO.

SPLIT SYSTEM AIR CONDITIONER

Indoor Model No.	Product Code No.
KHS1232	1 852 658 14

Outdoor Model No.	Product Code No.
CH1232	1 852 754 05

Indoor Unit

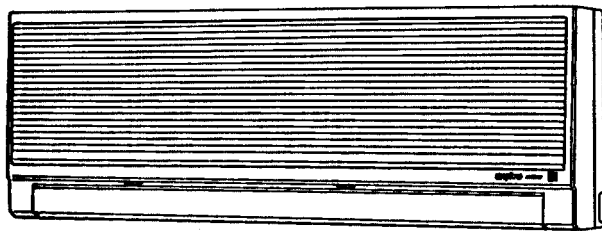

KHS1232

Outdoor Unit

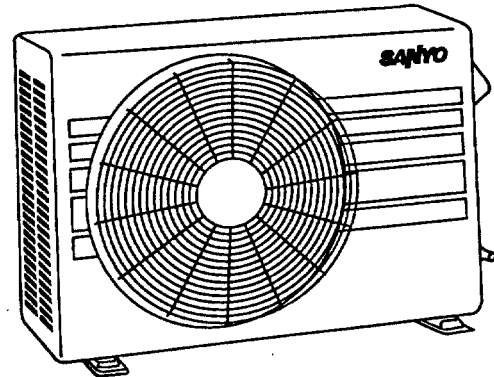

CH1232

REFERENCE NO. **SM700240**



IMPORTANT! Please Read Before Starting

This air conditioning system meets strict safety and operating standards. As the installer or service person, it is an important part of your job to install or service the system so it operates safely and efficiently.

For safe installation and trouble-free operation, you must:

- Carefully read this instruction booklet before beginning
- Follow each installation or repair step exactly as shown
- Observe all local, state, and national electrical codes
- Pay close attention to all warning and caution notices given in this manual



WARNING

This symbol refers to a hazard or unsafe practice which can result in severe personal injury or death.



CAUTION

This symbol refers to a hazard or unsafe practice which can result in personal injury or product or property damage.

If Necessary, Get Help

These instructions are all you need for most installation sites and maintenance conditions. If you require help for a special problem, contact our sales/service outlet or your certified dealer for additional instructions.

In Case of Improper Installation

The manufacturer shall in no way be responsible for improper installation or maintenance service, including failure to follow the instructions in this document.

SPECIAL PRECAUTIONS

When Wiring



ELECTRICAL SHOCK CAN CAUSE SEVERE PERSONAL INJURY OR DEATH. ONLY A QUALIFIED, EXPERIENCED ELECTRICIAN SHOULD ATTEMPT TO WIRE THIS SYSTEM.

- Do not supply power to the unit until all wiring and tubing are completed or reconnected and checked.
- Highly dangerous electrical voltages are used in this system. Carefully refer to the wiring diagram and these instructions when wiring. Improper connections and inadequate grounding can cause **accidental injury or death**.
- **Ground the unit** following local electrical codes.
- Connect all wiring tightly. Loose wiring may cause overheating at connection points and a possible fire hazard.

When Transporting

Be careful when picking up and moving the indoor and outdoor units. Get a partner to help, and bend your knees when lifting to reduce strain on your back. Sharp edges or thin aluminum fins on the air conditioner can cut your fingers.

When Installing...

...In a Ceiling or Wall

Make sure the ceiling/wall is strong enough to hold the unit's weight. It may be necessary to construct a strong wood or metal frame to provide added support.

...In a Room

Properly insulate any tubing run inside a room to prevent "sweating" that can cause dripping and water damage to walls and floors.

...In Moist or Uneven Locations

Use a raised concrete pad or concrete blocks to provide a solid, level foundation for the outdoor unit. This prevents water damage and abnormal vibration.

...In an Area with High Winds

Securely anchor the outdoor unit down with bolts and a metal frame. Provide a suitable air baffle.

...In a Snowy Area (for Heat Pump-type Systems)

Install the outdoor unit on a raised platform that is higher than drifting snow. Provide snow vents.

When Connecting Refrigerant Tubing

- Keep all tubing runs as short as possible.
- Use the flare method for connecting tubing.
- Apply refrigerant lubricant to the matching surfaces of the flare and union tubes before connecting them, then tighten the nut with a torque wrench for a leak-free connection.
- Check carefully for leaks before starting the test run.

NOTE:

Depending on the system type, liquid and gas lines may be either narrow or wide. Therefore, to avoid confusion the refrigerant tubing for your particular model is specified as either "narrow" or "wide" rather than as "liquid" or "gas."

When Servicing

- Turn the power OFF at the main power box (mains) before opening the unit to check or repair electrical parts and wiring.
- Keep your fingers and clothing away from any moving parts.
- Clean up the site after you finish, remembering to check that no metal scraps or bits of wiring have been left inside the unit being serviced.

Table of Contents

	Page
1. OPERATING RANGE	1
2. SPECIFICATIONS	
2-1. Unit Specifications	2
2-2. Major Component Specifications	3
2-2-1. Indoor unit	3
2-2-2. Outdoor unit	4
2-3. Other Component Specifications	5
2-3-1. Indoor unit	5
2-3-2. Outdoor unit	6
3. DIMENSIONAL DATA	7
4. PERFORMANCE CHARTS	9
5. FUNCTION	
5-1. Room Temperature Control	11
5-2. Automatic Switching between Cooling and Heating	13
5-3. Heater Operation (Heating)	13
5-4. Freeze Prevention (Cooling)	13
5-5. Overload Prevention (Heating)	14
5-6. Change-over (Heating)	14
5-7. Compressor Overheating Prevention (Heating)	15
5-8. Outdoor Fan Speed Control (Cooling)	15
5-9. Defrosting Operation (Heating)	16
5-10. Self-Diagnostic Function	18
5-10-1. Fault with serial communication	18
5-10-2. Locked compressor cut-off	18
5-10-3. Compressor winding protection	18
5-10-4. Open or short circuit of sensor (thermistor)	18
5-10-5. Combination of LED lamps on PCB Ass'y	19
5-10-6. Arrangement of LED lamps on PCB Ass'y	19
6. REFRIGERANT FLOW DIAGRAM	20
7. ELECTRIC WIRING DIAGRAMS	21
8. TROUBLESHOOTING	
8-1. Check before and after troubleshooting	23
8-1-1. Check power supply wiring	23
8-1-2. Check inter-unit wiring	23
8-1-3. Check power supply	23
8-1-4. Check lead wires and connectors in indoor and outdoor units	23

8-2.	Troubleshooting Flowchart	24
8-3.	Checking and Troubleshooting.....	27
8-3-1.	Measure insulation resistance for ground fault	27
8-3-2.	Check circuit breaker	27
8-3-3.	Measure resistance for short circuit.....	28
8-3-4.	Check power supply	28
8-3-5.	Check remote control unit.....	28
8-3-6.	Check OPERATION selector switch in indoor unit.....	28
8-3-7.	Check serial communication between indoor unit and outdoor unit	29
	(a) Check transformers in indoor and outdoor units	
	(b) Check fuses on PCB Ass'y in indoor and outdoor units	
	(c) PCB Ass'y in either indoor or outdoor unit is defective	
8-3-8.	Only compressor does not run.....	30
8-3-9.	Only fan motor does not run	30
8-3-10.	Function of outdoor fan speed control does not work properly	30
9.	CHECKING ELECTRICAL COMPONENTS	
9-1.	Measurement of Insulation Resistance	31
9-1-1.	Power supply wires.....	31
9-1-2.	Indoor unit.....	31
9-1-3.	Outdoor unit	31
9-1-4.	Measurement of insulation resistance for electrical parts	31
9-2.	Checking Continuity of Fuse on PCB Ass'y	32
9-3.	Checking Motor Capacitor	32
9-4.	Appearance of Electrical Parts	33
	(a) Heater Relay	
	(b) Relay	
	(c) Thermistor	
	(d) Thermostat (air blowout temperature)	
APPENDIX	INSTRUCTION MANUAL.....	34

1. OPERATING RANGE

	Temperature	Indoor Air Intake Temp.	Outdoor Air Intake Temp.
Cooling	Maximum	95°F DB / 71°F WB	115°F DB
	Minimum	67°F DB / 57°F WB	67°F DB
Heating	Maximum	80°F DB / 67°F WB	75°F DB / 65°F WB
	Minimum	— DB / — WB	17°F DB / 15°F WB

2. SPECIFICATIONS

2-1. Unit Specifications

Indoor unit **KHS1232**

Outdoor unit **CH1232**

Power Source				230 / 208V – Single phase – 60Hz				
Performance	Capacity	BTU/h		Cooling	11,700 / 11,500	Heating	13,000 / 12,700	
		kW			3.43 / 3.37		3.81 / 3.72	
	Air circulation (High)	ft ³ /min.		360 / 330				
	Moisture removal (High)	Pints/h		3.3 / 3.2			—	
Electrical Rating	Voltage rating	V		230 / 208			230 / 208	
	Available voltage range	V		253 to 187				
	Running amperes	A		5.5 / 5.9			5.1 / 5.4	
	Power input	W		1,210 / 1,180			1,170 / 1,120	
	Power factor	%		95 / 96			99 / 99	
	S.E.E.R. (H.S.P.F.)			10.0 / 10.0			(6.8 / 6.8)	
	Compressor locked rotor amperes	A		34				
	Heater element	kW		1.5 / 1.23				
Features	Controls / Temperature control			Microprocessor / I.C. thermostat				
	Control unit			Wireless remote control unit				
	Timer			ON/OFF, 24-hours & Program				
	Fan speeds		Indoor / Outdoor	3 and Auto / 2 (Auto)				
	Airflow direction (Indoor)		Horizontal	Manual				
			Vertical	Auto				
	Air filter			Washable, Anti-mold				
	Compressor			Rotary (Hermetic)				
	Refrigerant / Amount charged at shipment		lbs. (g)	R22 / 2.51 (1,140)				
	Refrigerant control			Capillary tube				
	Operation sound		Indoor – Hi / Me / Lo	dB-A		43 / 39 / 36		
			Outdoor – Hi	dB-A		49		
	Refrigerant tubing connections			Flare type				
	Max. allowable tubing length at shipment		ft. (m)	33 (10)				
	Refrigerant tube diameter		Narrow tube	in. (mm)		1/4 (6.35)		
		Wide tube	in. (mm)		1/2 (12.7)			
Refrigerant tube kit / Accessories			Optional / Hanging wall bracket					
Dimensions & Weight	Unit dimensions		Height	in. (mm)	Indoor unit	14-3/16 (360)	Outdoor unit	20-7/8 (530)
			Width	in. (mm)		38-31/32 (990)		29-17/32 (750)
			Depth	in. (mm)		7-13/16 (198)		11-1/32 (280)
	Package dimensions		Height	in. (mm)		10-23/32 (272)		23-1/2 (597)
			Width	in. (mm)		42-17/32 (1,080)		35-13/32 (899)
			Depth	in. (mm)		18-1/32 (458)		13-27/32 (352)
	Weight		Net	lbs. (kg)		29.7 (13.5)		92.5 (42.0)
			Shipping	lbs. (kg)		37.4 (17.0)		99.1 (45.0)
	Shipping volume		ft ³ (m ³)			4.8 (0.13)		6.5 (0.18)

DATA SUBJECT TO CHANGE WITHOUT NOTICE.

Remarks: Rating conditions are:

Cooling: Indoor air temperature 80°F DB/67°F WB
 Outdoor air temperature 95°F DB/75°F WB
 Heating: Indoor air temperature 70°F DB
 Outdoor air temperature 47°F DB/43°F WB

2-2. Major Component Specifications

2-2-1. Indoor unit

Indoor unit KHS1232

Remote Control Unit		RCS-KHS2422W		
Control PCB	Control circuit fuse		POW-KHS1222-A AC 250V - 3A	
	Switch Ass'y		SW-KHS2412W	
Heater Element (Aux. Heater)	Model ... Number		AH-KH1212	
	Input (230 / 208V)	kW	1.5 / 1.23	
	Protective thermostat		OFF 140 ± 5°F, ON 122 ± 9°F	
Thermo fuse		Cut-off 341 ± 2, -5°F, 277V - 15A		
Fan	Type		Cross-flow	
	Number ... Dia. and length	in. (mm)	1 ... O.D. 4 (100), L 30 (760)	
Fan Motor	Model ... Number		UF4Q-11A6P ... 1	
	No. of pole ... rpm (230V, High)		4 ... 1,330	
	Nominal output		W	
	Coil resistance (Ambient temp. 68°F)		Ω	
			BRN - WHT: 281.6 WHT - VLT: 45.3 VLT - ORG: 56.0 ORG - YEL: 117.0 YEL - PNK: 59.4	
	Safety devices	Type		Internal protector
		Operating temp.	Open °F	248 ± 9
			Close	Automatic reclosing
	Run capacitor		μF	0.8
			VAC	440
Louver Motor	Model		M2EA24ZA01	
	Rating		208 to 230V, 60Hz	
	No. of pole ... rpm		8 ... 3	
	Output		W	
	Coil resistance (at 68°F)		kΩ	
		16.45 ± 15%		
Heat Exch.	Coil		Aluminum plate fin / Copper tube	
	Rows ... Fins per inch		2 ... 14.1	
	Face area		ft. ² (m ²)	
		2.08 (0.19)		

DATA SUBJECT TO CHANGE WITHOUT NOTICE.

2-2-2. Outdoor unit

Outdoor unit CH1232

Controller POB	Control circuit fuse		POW-CH1232 AC 250V - 3A		
	Type		Rotary (hermetic)		
Compressor	Model ... Number		C-R95H6E ... 1		
	No. of cyl. ... rpm		1 ... 3,500		
	Nominal output		W	950	
	Compressor lubricant		cc	600	
	Coil resistance (Ambient temp. 77°F)		Ω	C - R: 1.89 C - S: 4.90	
	Safety devices	Type		Internal	External
		Overload relay models		—	MST00AKU-9200
		Operating temp.	Open	°F	275 ± 9
			Close	°F	156 ± 27
	Operating amp. (Ambient temp. 77°F)		—	Trip in 6 to 16 sec. at 21.0A	
	Run capacitor		μF	20	
VAC			400		
Crank case heater		230V - 20W			
Fan	Type		Propeller		
	Number ... Dia.		in. (mm)	1 ... 15-3/4 (400)	
Fan Motor	Model		UE6S-21L6P		
	No. of pole ... rpm (230V, High)		6 ... 840		
	Nominal output		W	20	
	Coil resistance (Ambient temp. 68°F)		Ω	BRN - WHT: 201.7 WHT - YEL: 156.1 YEL - PNK: 27.1	
	Safety devices	Type		Internal protector	
		Operating temp.	Open	°F	248 ± 9
	Close				Automatic reclosing
Run capacitor		μF	2.5		
		VAC	440		
Heat Exch.	Coil		Aluminum plate fin / Copper tube		
	Rows ... Fins per inch		2 ... 15.9		
	Face area		ft. ² (m ²)	3.29 (0.30)	
External Finish		Acrylic baked-on enamel finish			

DATA SUBJECT TO CHANGE WITHOUT NOTICE.

2-3. Other Component Specifications

2-3-1. Indoor unit

Indoor unit KHS1232

Transformer		ATR-H85U
Rated	Primary	AC 220V, 60Hz
	Secondary	11V, 0.727A
	Capacity	8VA
Coil resistance	Ω (at 77°F)	Primary (WHT – WHT): $294.0 \pm 15\%$ Secondary (BRN – BRN): $1.0 \pm 15\%$
Thermal cut-off temp.		259°F, 2A, 250V

Heater Relay		G4E-2123T-US
Coil rating		DC 12V
Coil resistance	Ω (at 73°F)	$133.5 \pm 10\%$
Contact rating		AC 250V, 15A

Thermistor (Coil sensor)		PBC-41E-S4			
Resistance	k Ω	14°F	$23.7 \pm 5\%$	77°F	$5.3 \pm 5\%$
		32°F	$15.0 \pm 5\%$	86°F	$4.4 \pm 5\%$
		50°F	$9.7 \pm 5\%$	104°F	$3.1 \pm 5\%$
		68°F	$6.5 \pm 5\%$		

Thermistor (Room sensor)		SDT-500B6-2			
Resistance	k Ω	50°F	$10.3 \pm 4\%$	86°F	$4.0 \pm 4\%$
		59°F	$8.0 \pm 4\%$	104°F	$2.6 \pm 4\%$
		68°F	$6.3 \pm 4\%$	122°F	$1.8 \pm 4\%$
		77°F	$5.0 \pm 4\%$		

Thermostat (air blowout temp.)		CT-7L
Operating temp.	°F	OFF 131 ± 5
		ON 113 ± 5
Contact rating		DC 24V, 0.2A

2-3-2. Outdoor unit

Outdoor unit CH1232

Transformer		ATR-H85U
Rated	Primary	AC 220V, 60Hz
	Secondary	11V, 0.727A
	Capacity	8VA
Coil resistance	Ω (at 77°F)	Primary (WHT – WHT): 294.0 ± 15% Secondary (BRN – BRN): 1.0 ± 15%
Thermal cut-off temp.		259°F, 2A, 250V

Power Relay		G4F-11123T-US
Coil rating		DC 12V
Coil resistance	Ω (at 68°F)	160 ± 10%
Contact rating		AC 240V, 20A

Thermistor (Coil sensor, Air temp. sensor)		PBC-41E-S15			
Resistance	k Ω	14°F	23.7 ± 5%	77°F	5.3 ± 5%
		32°F	15.0 ± 5%	86°F	4.4 ± 5%
		50°F	9.7 ± 5%	104°F	3.1 ± 5%
		68°F	6.5 ± 5%		

Thermistor (Discharge sensor)		DTN-TKS101B			
Resistance	k Ω	32°F	185.5 ± 5%	86°F	45.1 ± 5%
		50°F	112.2 ± 5%	104°F	29.7 ± 5%
		68°F	70.1 ± 5%	122°F	20.0 ± 5%

Thermistor (PTC)		TDK 101YV
Max. voltage		AC 400V
Max. ampere		11.5A
Resistance	Ω (at 77°F)	100 ± 25%

Solenoid Valve (4-way valve)		LB59005 (Coil), V26 9100 (Valve)
Coil rating		AC 208 to 240V, 60Hz, 5W
Coil resistance	Ω (at 68°F)	1,770

3. DIMENSIONAL DATA

Indoor unit KHS1232

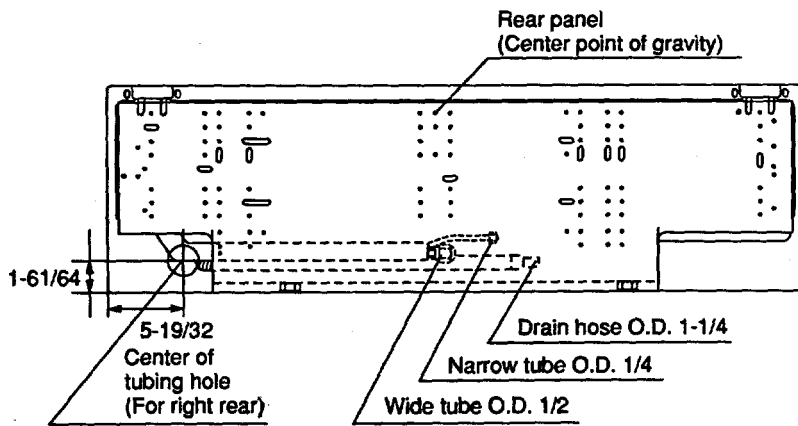
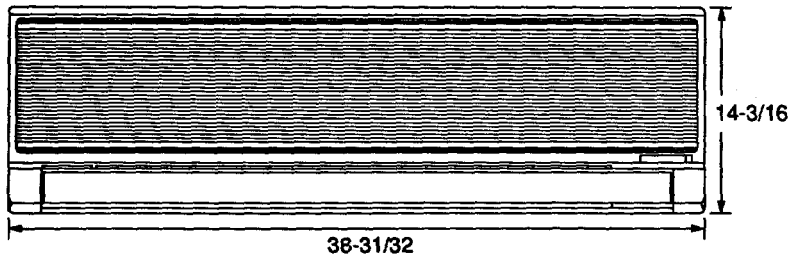

Wireless remote control unit

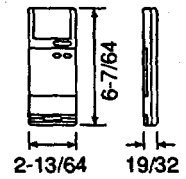

Dimension: In.

Outdoor unit CH1232

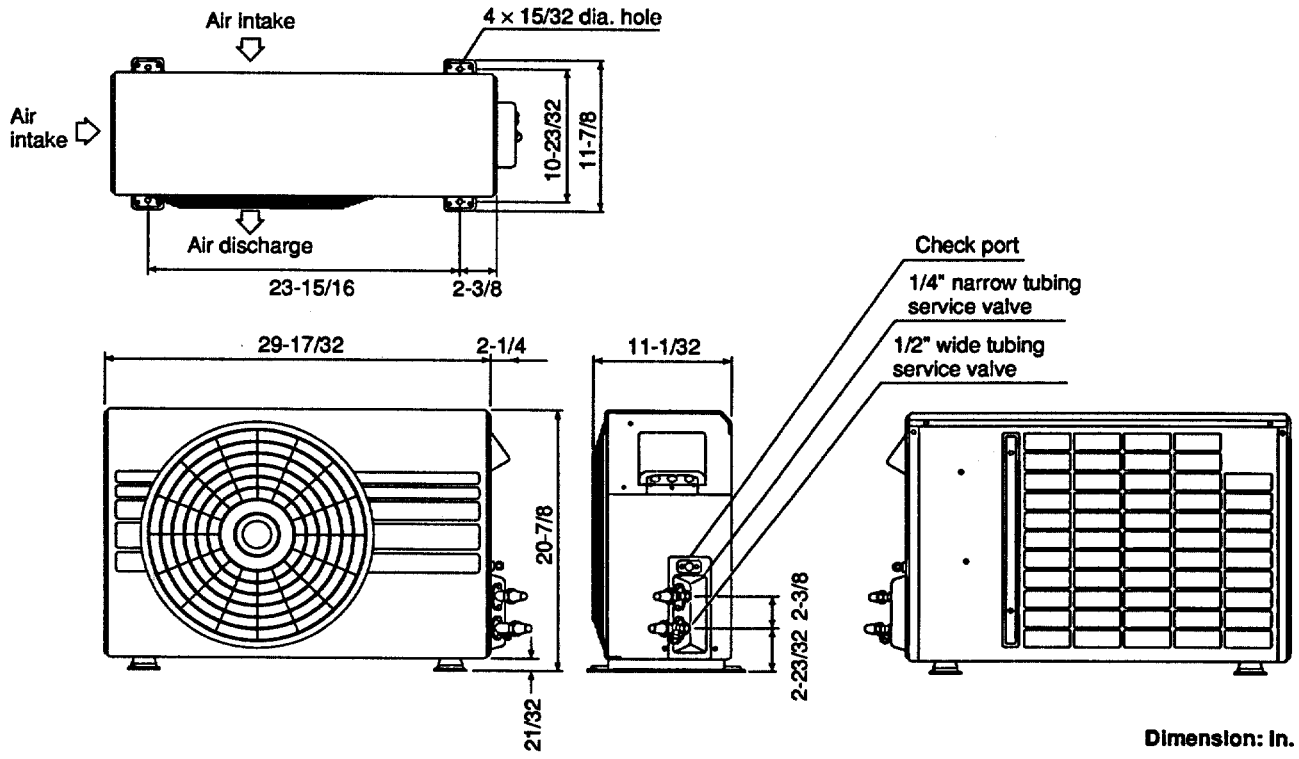

4. PERFORMANCE CHARTS

Indoor unit KHS1232 Outdoor unit CH1232

● Cooling characteristics

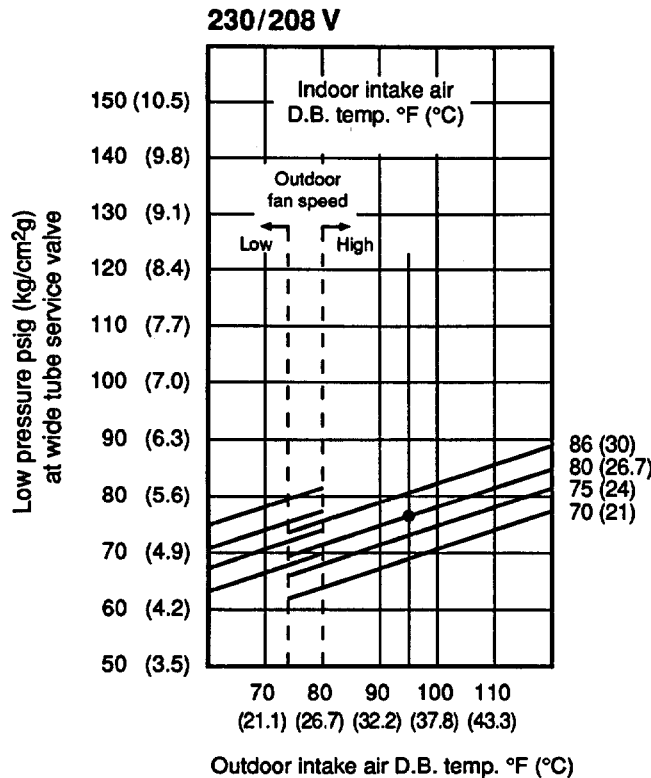
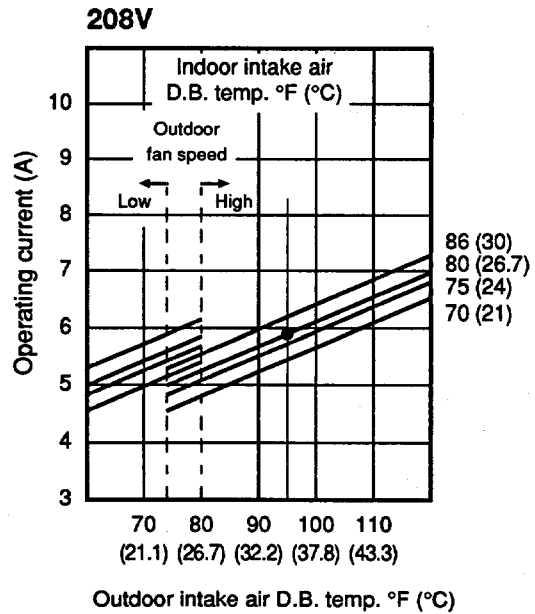
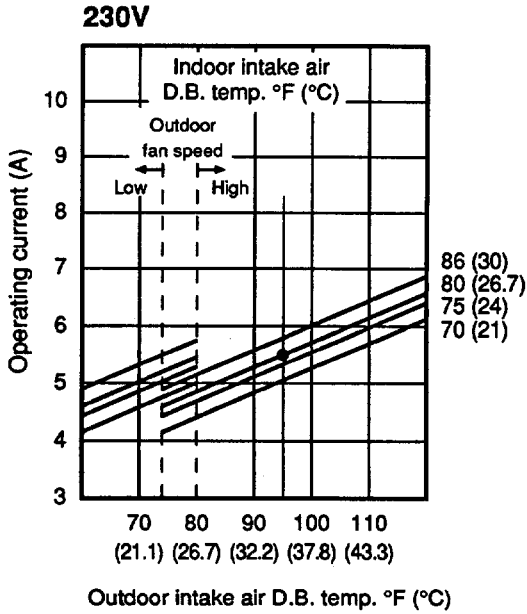

NOTE

-Points of rating condition

Black dots in above charts indicate the following rating conditions.

Cooling: Indoor air temperature 80°F DB/67°F WB
Outdoor air temperature 95°F DB

● Heating characteristics

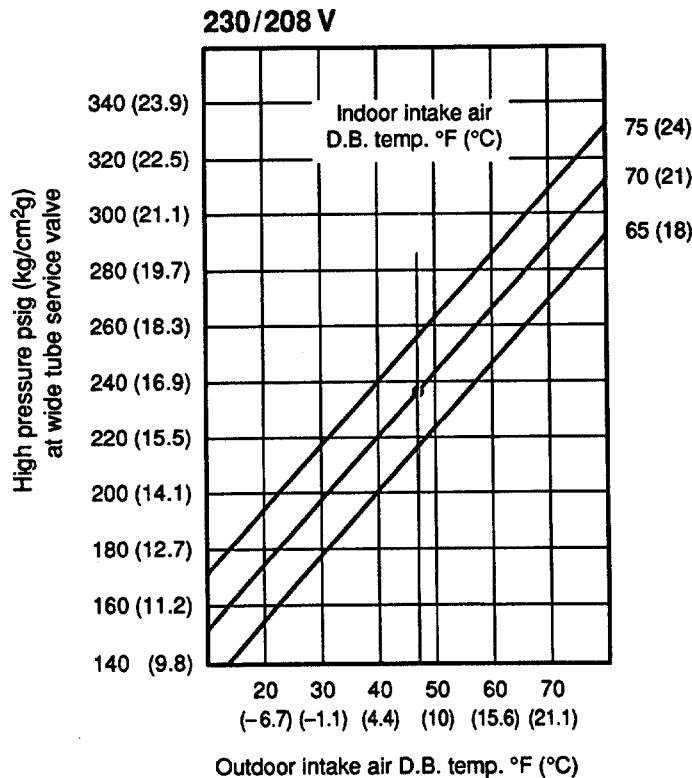
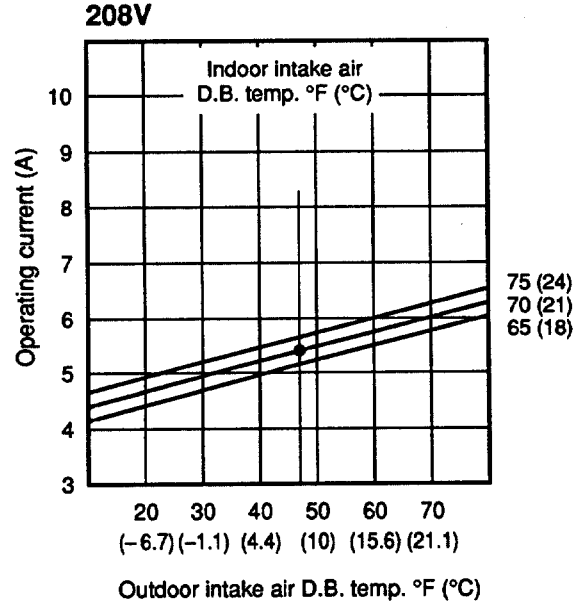
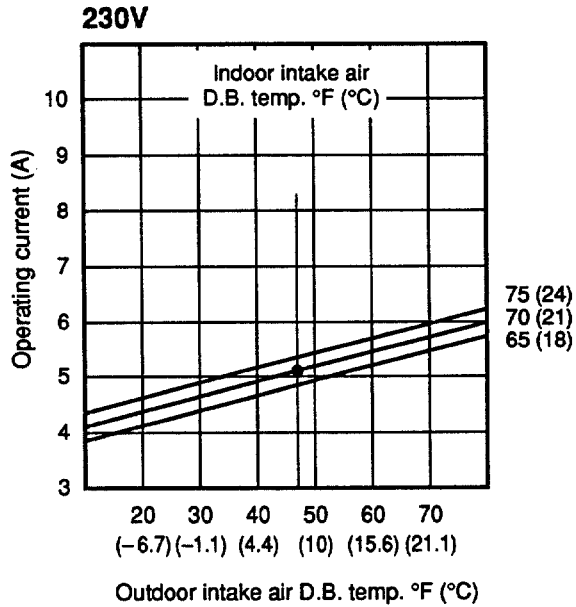

NOTE

Overload prevention operates to protect the air conditioner when the outdoor ambient temperature reaches an abnormally high level while in heating mode. (Refer to 5-5. Overload prevention)

●Points of rating condition

Black dots in above charts indicate the following rating conditions.

Heating: Indoor air temperature 70°F DB
Outdoor air temperature 47°F DB/43°F WB

5. FUNCTION

5-1. Room Temperature Control

■ Cooling

- Room temperature control is obtained by cycling the compressor ON and OFF under control of the room temperature sensor in the remote control unit.
- The room temperature (and other information) is transmitted every 3 minutes by the remote control unit to the controller in the indoor unit.

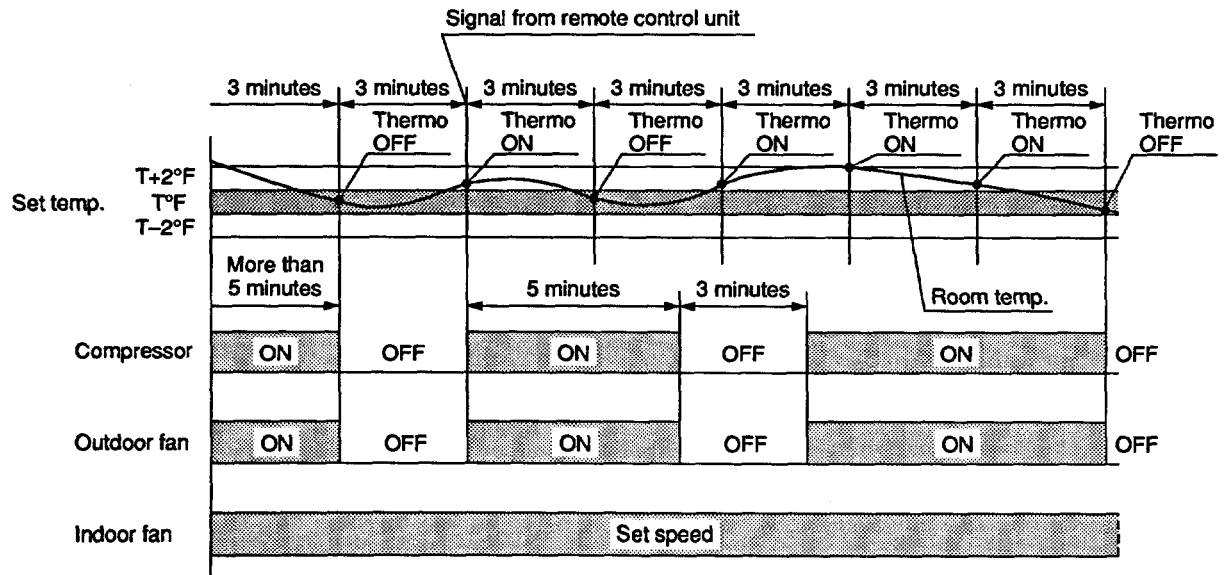

- The control circuit will not attempt to turn the compressor ON until the compressor has been OFF for at least 3 minutes. To protect the compressor from stalling out when trying to start against the high side refrigerant pressure, the control circuit has a built-in automatic time delay to allow the internal pressure to equalize.
- As a protective measure, the control circuit switches the compressor OFF after 5 minutes or more of compressor operation.
- Thermo ON : When the room temperature is above $T + 2^{\circ}\text{F}$ ($T^{\circ}\text{F}$ is set temperature).
Compressor → ON
- Thermo OFF : When the room temperature is equal to or below set temperature $T^{\circ}\text{F}$.
Compressor → OFF

■ Heating

- Room temperature control is obtained by cycling the compressor ON and OFF under control of the room temperature sensor in the remote control unit.
- The room temperature (and other information) is transmitted every 3 minutes by the remote control unit to the controller in the indoor unit.

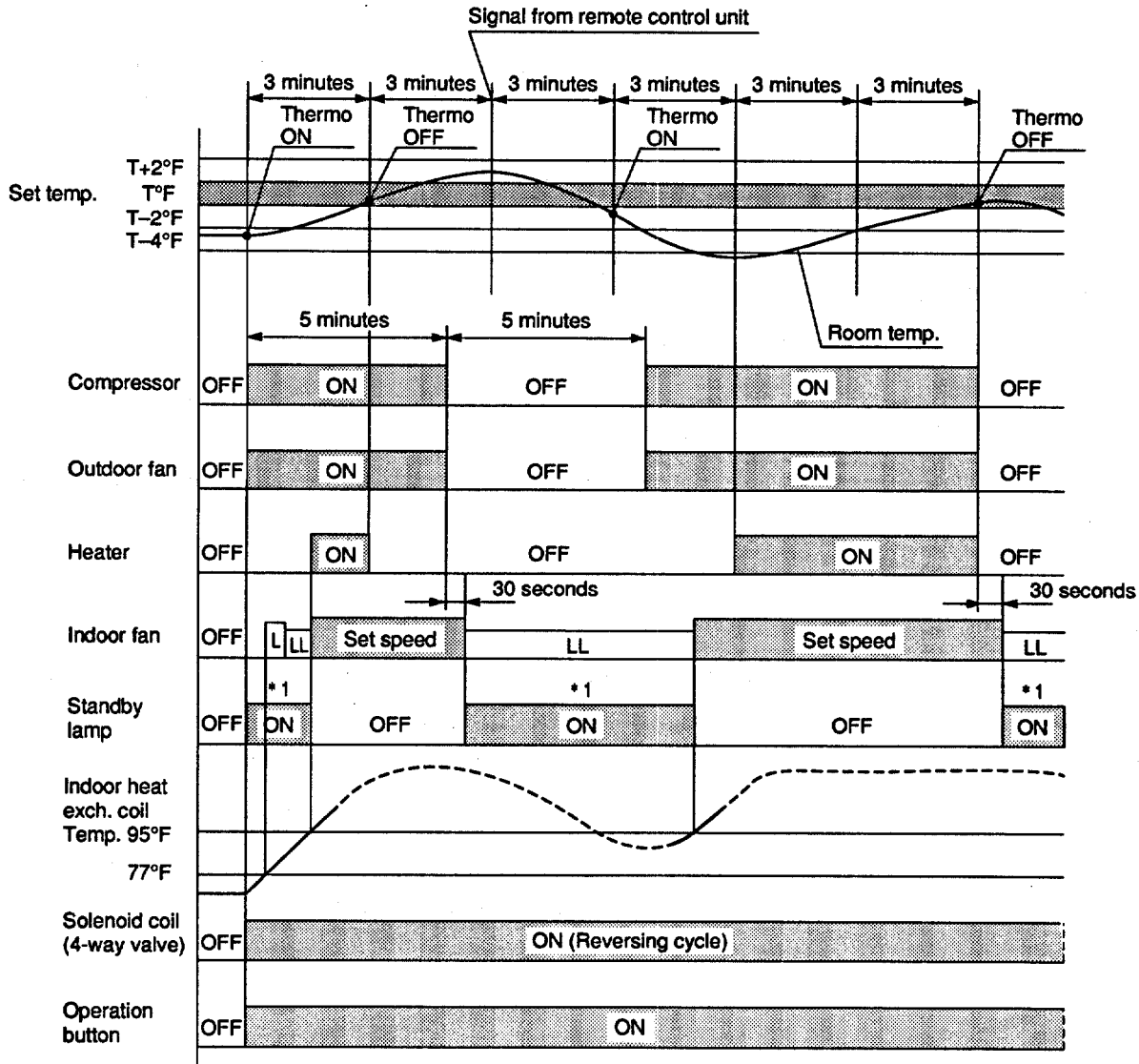

*1: Cold draft prevention

- The control circuit will not attempt to turn the compressor ON until the compressor has been OFF for at least 5 minutes. To protect the compressor from stalling out when trying to start against the high side refrigerant pressure, the control circuit has a built-in automatic time delay to allow the internal pressure to equalize.
- As a protective measure, the control circuit switches the compressor OFF after 5 minutes or more of compressor operation.
- Thermo ON : When the room temperature is below $T - 2^{\circ}\text{F}$ ($T^{\circ}\text{F}$ is set temperature).
Compressor → ON
- Thermo OFF : When the room temperature is equal to or above set temperature $T^{\circ}\text{F}$.
Compressor → OFF

5-2. Automatic Switching between Cooling and Heating

- When AUTO mode is selected, the microprocessor calculates the difference between the set temperature and the room temperature, and automatically switches to COOLING or HEATING mode to maintain the desired temperature.

Room temp. \geq Set temp. \rightarrow COOL

Room temp. $<$ Set temp. \rightarrow HEAT

This means that if the room temperature is **higher than or equal to** the set temperature, **COOLING** operation begins. If the room temperature is **lower than** the set temperature, **HEATING** operation begins.

5-3. Heater Operation (Heating)

- The electric heater operates in Thermo ON at the time of initial start or when the room temperature is 4°F lower than the set temperature.
- When the air conditioner is thermo OFF, the heater is OFF at the same time.
- When the indoor outlet air temperature rises above 131°F, heater operation stops. It resumes operation when the indoor outlet air temperature falls below 113°F.
- When the outdoor temperature falls to around 10°F, the compressor stops but the electric heater continues to operate.

5-4. Freeze Prevention (Cooling)

- This function prevents freezing of the indoor heat exchange coil.
- When the compressor has been running for 10 minutes or more and the temperature of the indoor heat exchange coil falls below 30°F, the control circuit stops the compressor for at least 6 minutes.

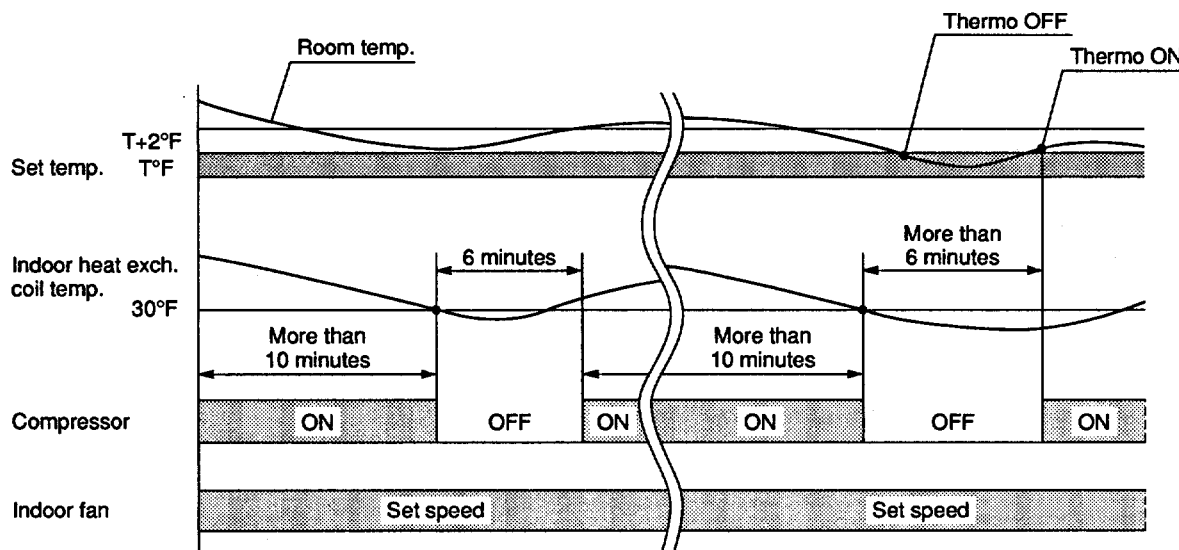

5-5. Overload Prevention (Heating)

- This function prevents overheating of the indoor heat exchange coil.
- When the temperature of the indoor heat exchange coil rises above 135°F, and if the indoor fan is L (low speed), then the fan speed changes from L (low speed) to M (medium speed).
- When the temperature of the indoor heat exchange coil rises above 138°F, the outdoor fan stops.

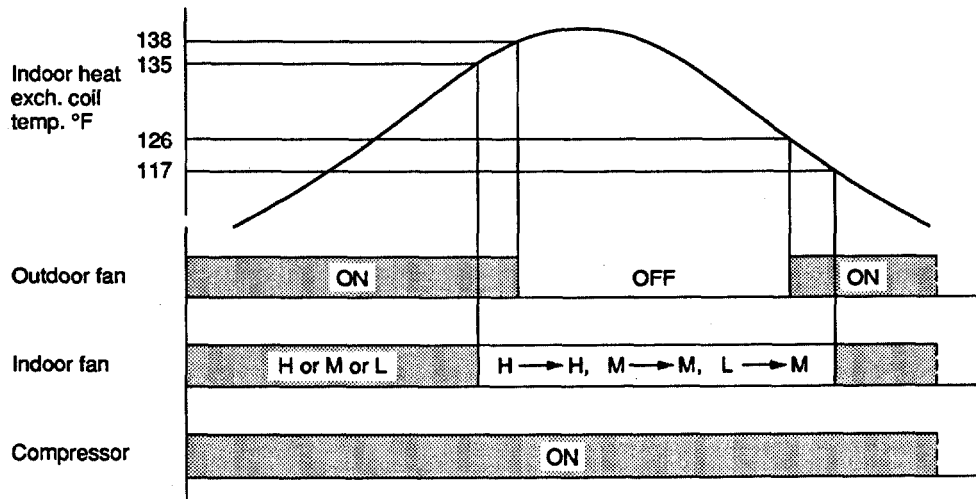

5-6. Change-over (Heating)

- This function protects the compressor from being damaged due to liquid back-flow.
- Low ambient operation during heating can cause the outdoor heat exchanger to become super-cooled which may result in liquid back-flow. To protect the compressor from this condition, the compressor stops if the outdoor temperature drops below 10°F. However, the indoor fan and the heater continue to operate even after the compressor has stopped.

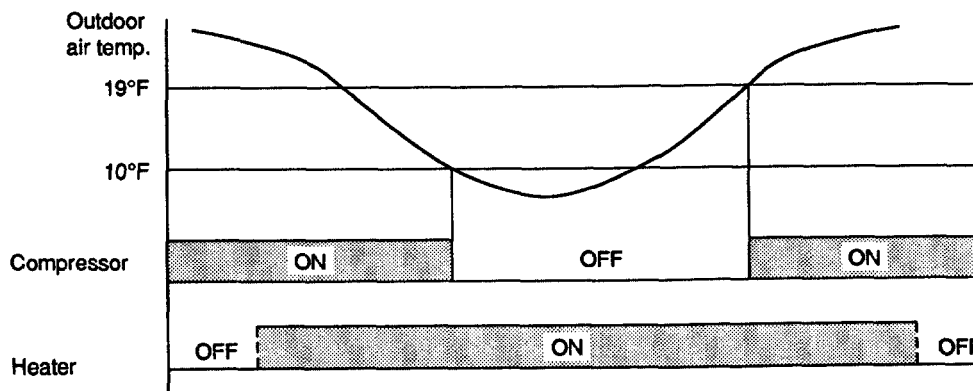

5-7. Compressor Overheating Prevention (Heating)

- This function protects the compressor from overheating using the outdoor fan.

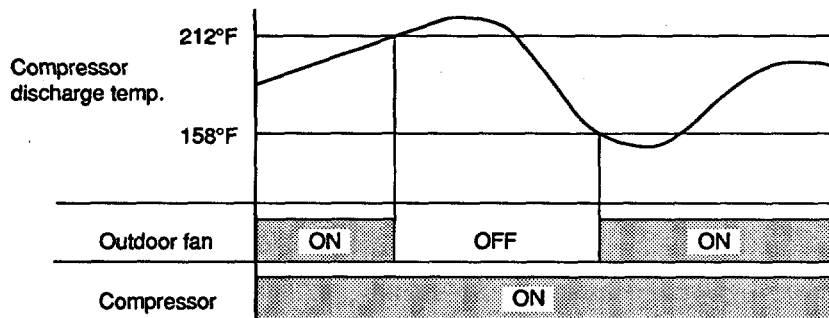

5-8. Outdoor Fan Speed Control (Cooling)

- The outdoor fan speed switches automatically to LOW to prevent the indoor heat exchange coil from freezing due to low ambient temperature.
- If the outdoor air temperature falls below 74°F, the fan speed switches to LOW.
- If the outdoor air temperature rises above 80°F for 5 minutes or longer, the fan speed switches to HIGH.

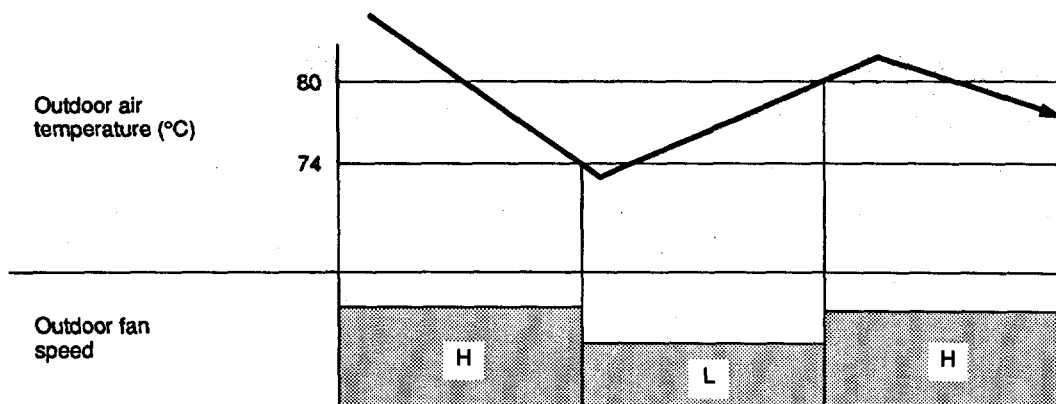

5-9. Defrosting Operation (Heating)

■ Defrosting Flowchart

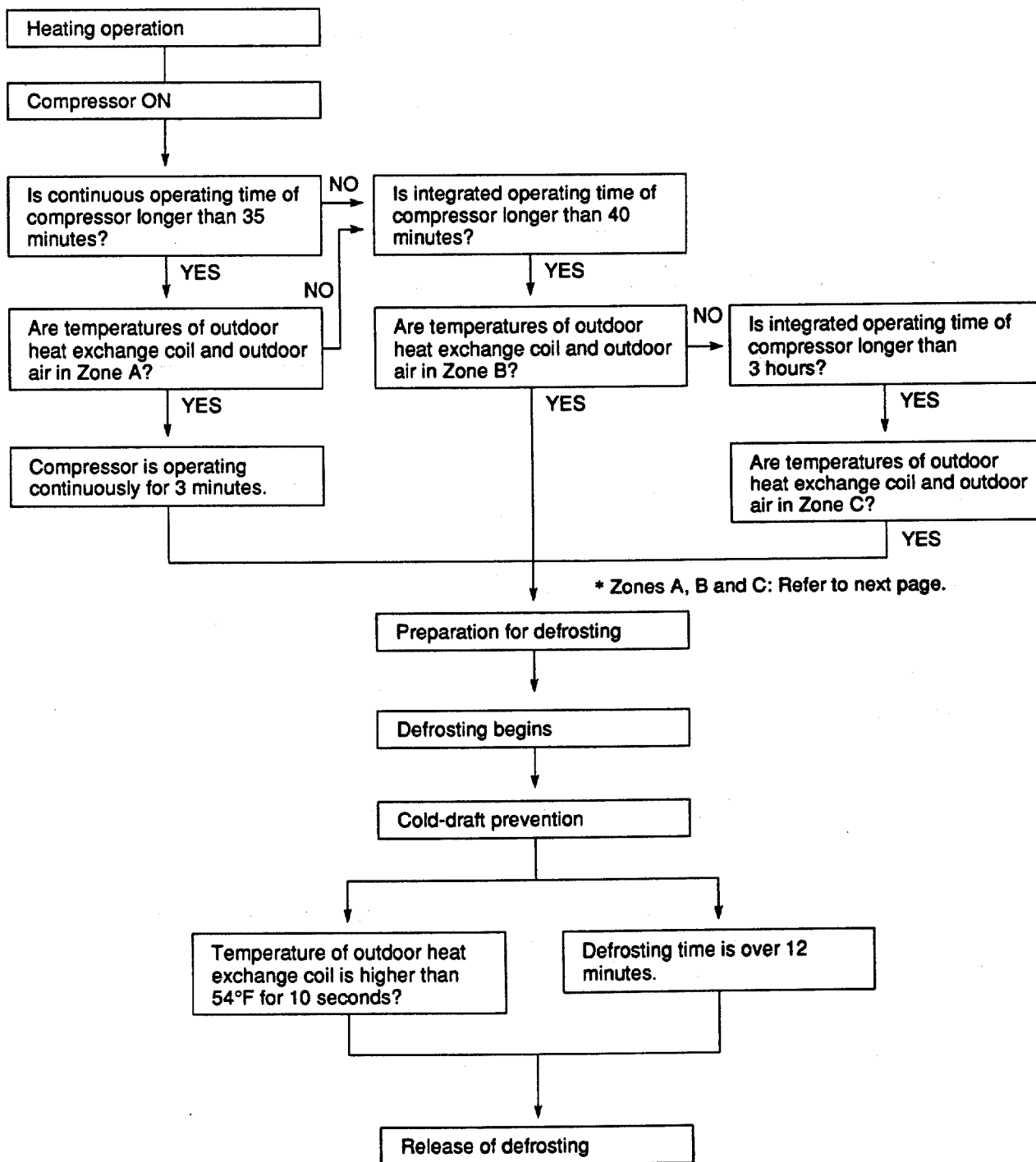

● Defrosting Mode Timing Chart

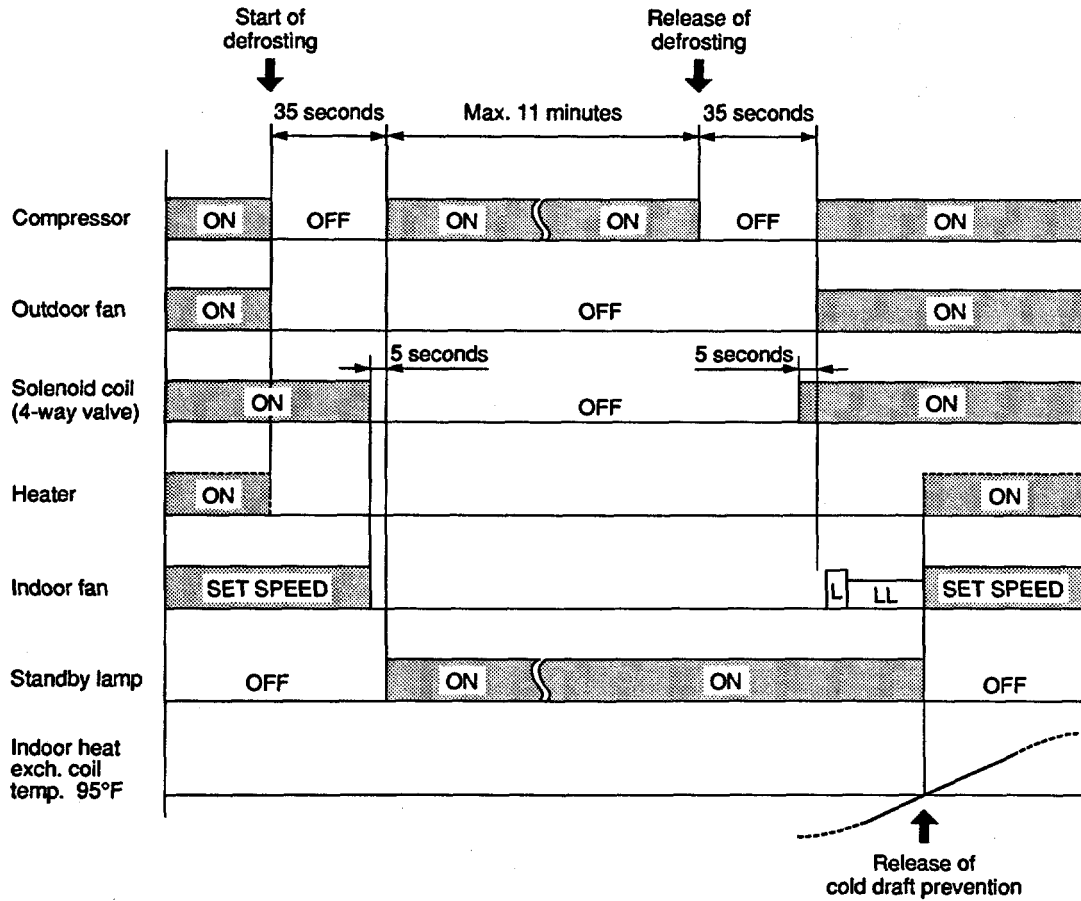

● Defrosting Zone

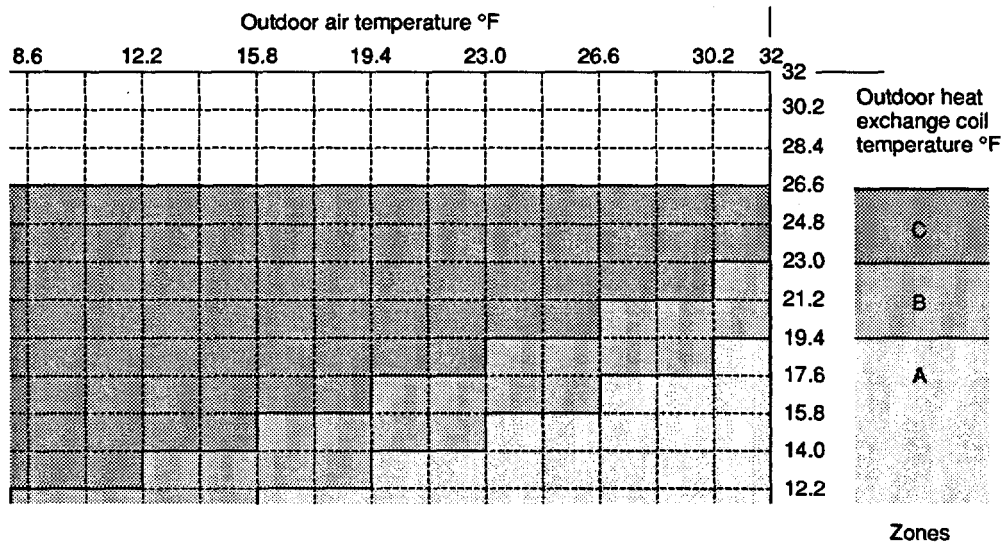

5-10. Self-Diagnostic Function

- When the following problems occur in the air conditioner, operation stops and the operation lamp in the indoor unit flashes.

At the same time, LED lamps on the PCB Ass'y in the indoor and outdoor units also flash. The combination of flashing LED lamps indicates the cause of the problem.

5-10-1. Fault with serial communication

- Fault in transmission between indoor and outdoor units.
- Error message appears on the PCB Ass'y after 3 minutes.
- To release this error, push the operation ON-OFF button again.

5-10-2. Locked compressor cut-off

- This function prevents the compressor from being damaged by overcurrent.
- The air conditioner stops when the current exceeds 17A for 2 seconds, repeating 3 times.
- To release this error, push the operation ON-OFF button again.

5-10-3. Compressor winding protection

- The air conditioner stops if the compressor discharge temperature rises above 239°F, repeating 2 times within 1 hour.
- To release this error, wait 15 minutes and push the operation ON-OFF button.

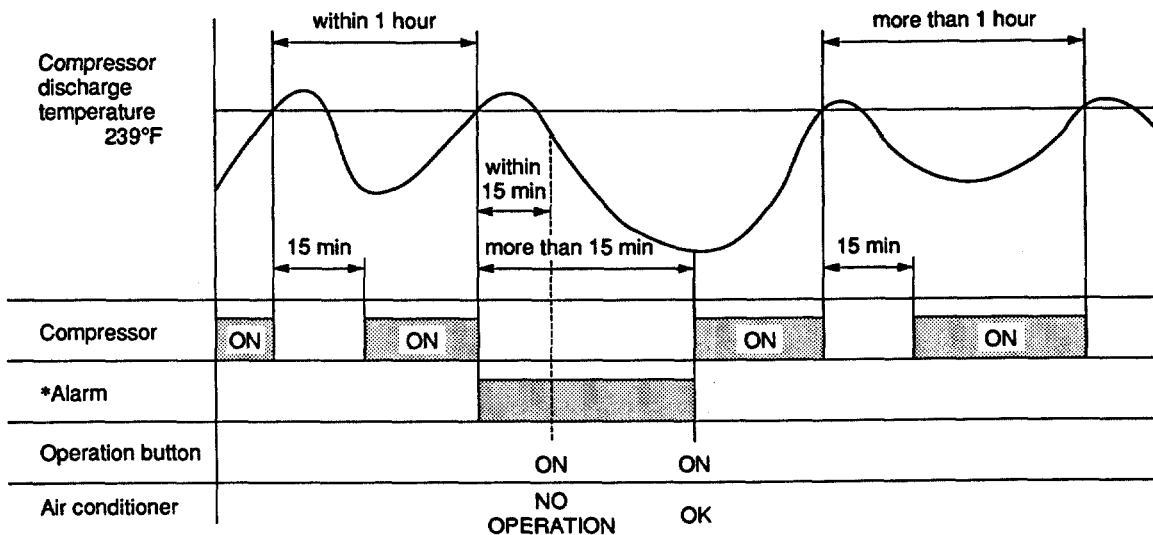

* Flashing of LED lamps on the PCB Ass'y

5-10-4. Open or short circuit of sensor (thermistor)

- The following sensors are provided in the outdoor unit.
 - TH1: Outdoor heat exchange coil temperature sensor
 - TH2: Outdoor air temperature sensor
 - TH3: Compressor discharge gas temperature sensor
- For checking the sensor fault, measure the sensor resistance.

5-10-5. Combination of LED lamps on PCB Ass'y

Type of problem	Indoor unit				Outdoor unit		
	LED lamp combination				LED lamp combination		
	24	25	26	27	2	4	6
Fault with serial communication				☆			☆
Locked compressor cut-off		☆		☆		☆	
Compressor winding protection	☆			☆		☆	☆
Open or short circuit of sensor		☆			☆		

☆: Flashing lamps

5-10-6. Arrangement of LED lamps on PCB Ass'y

- KHS1232

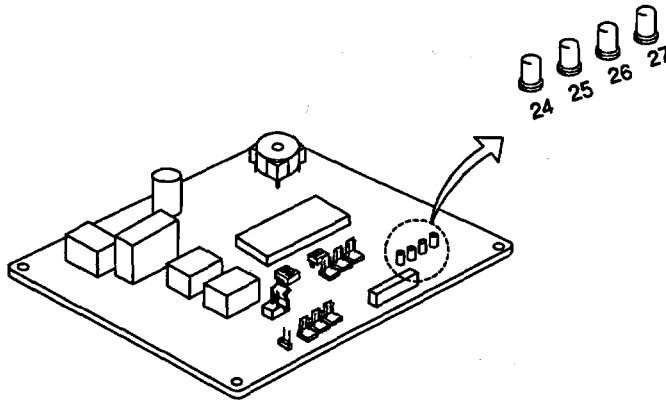

- CH1232

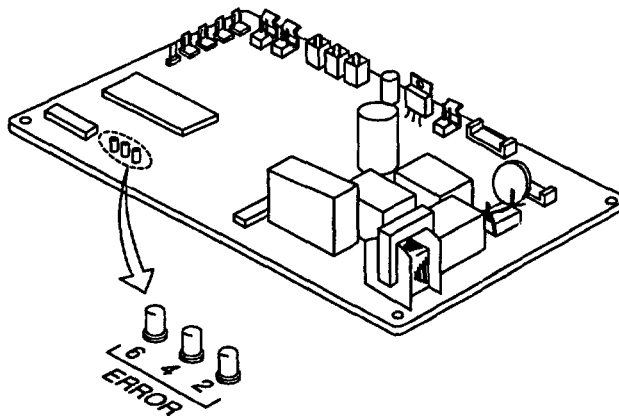

6. REFRIGERANT FLOW DIAGRAM

Indoor unit KHS1232

Outdoor unit CH1232

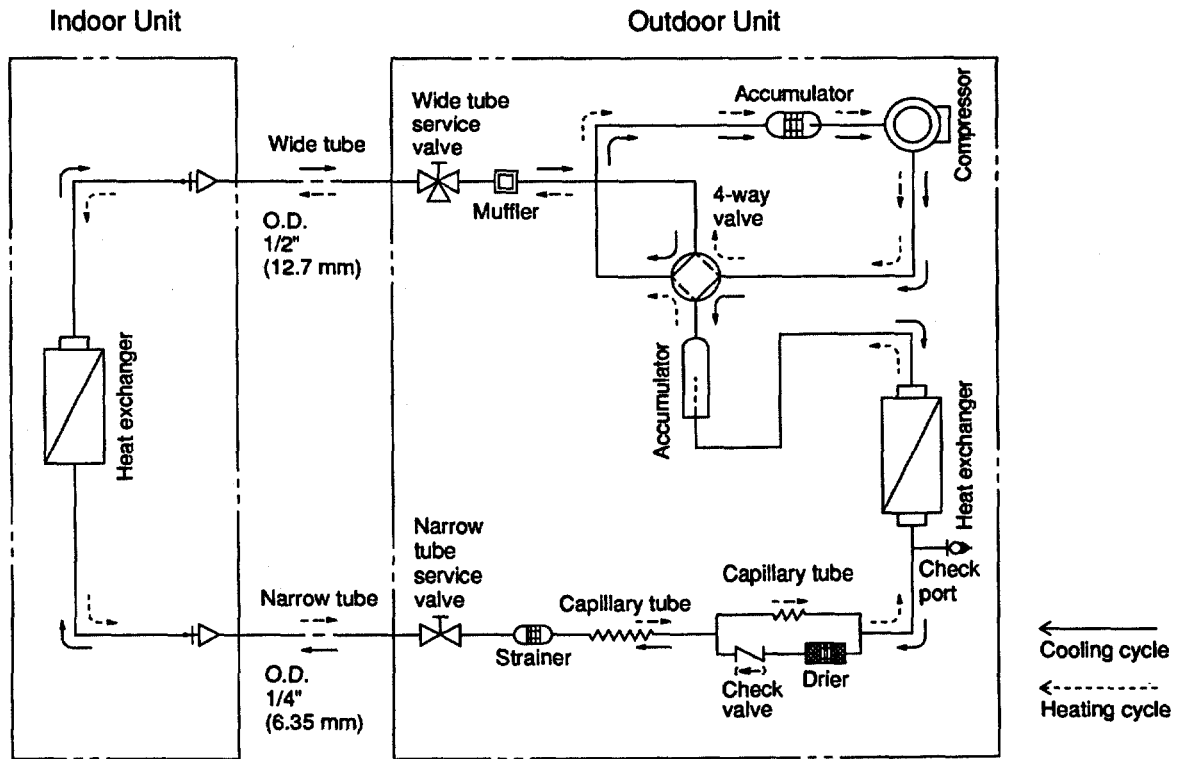

Insulation of Refrigerant Tubing

IMPORTANT

To prevent heat loss and wet floors due to dripping of condensation, **both the wide and narrow tubes must be well insulated with a proper insulation material.** The thickness of the insulation should be a min. 5/16 in.

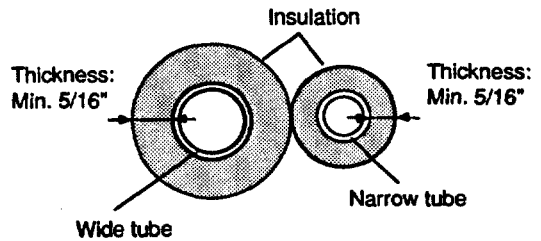

CAUTION

After a tube has been insulated, never try to bend it into a narrow curve because it can cause the tube to break or crack.

7. ELECTRIC WIRING DIAGRAMS

Indoor unit KHS1232



WARNING

To avoid electrical shock hazard, be sure to disconnect power before checking, servicing and/or cleaning any electrical parts.

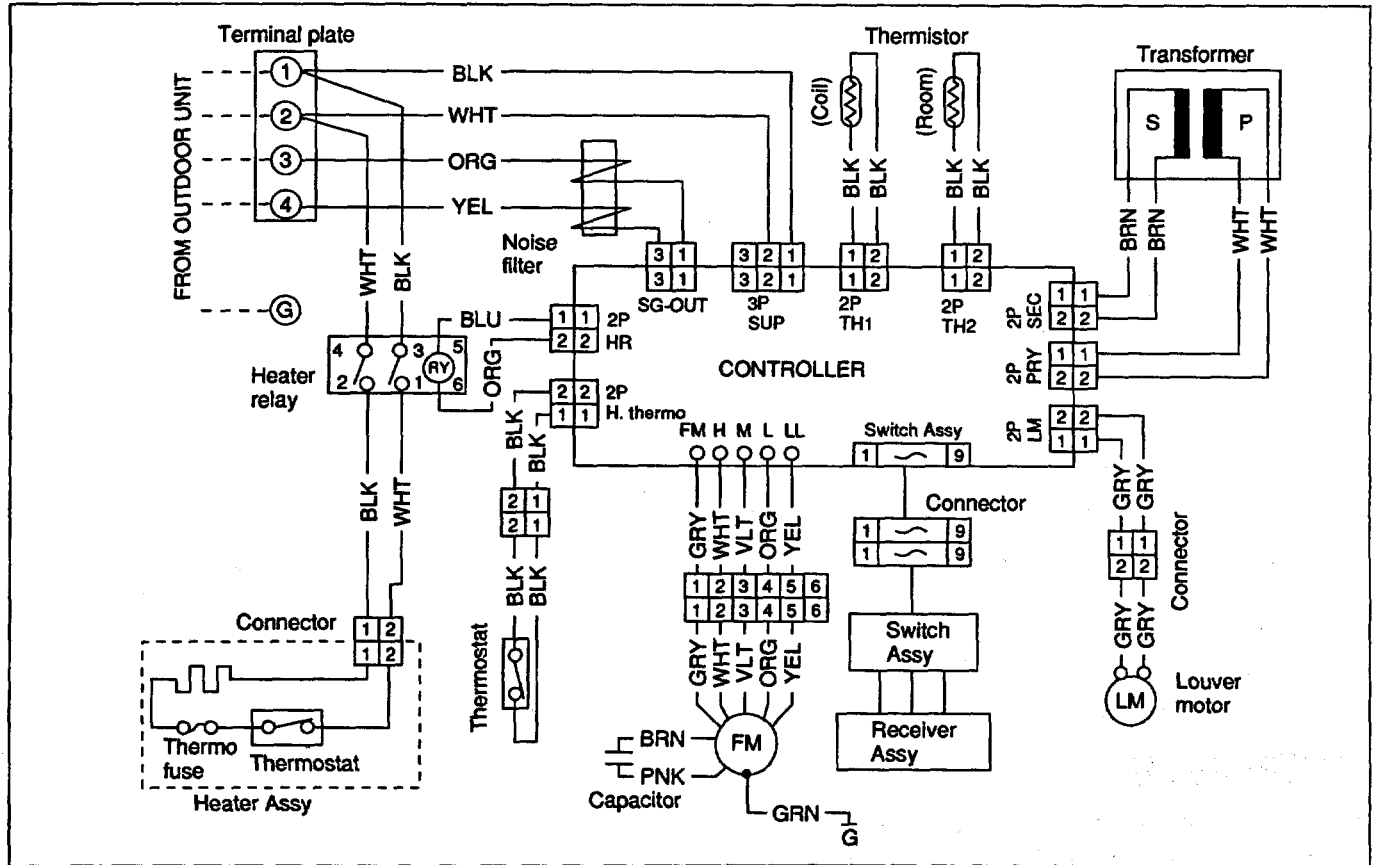



WARNING

To avoid electrical shock hazard, be sure to disconnect power before checking, servicing and/or cleaning any electrical parts.

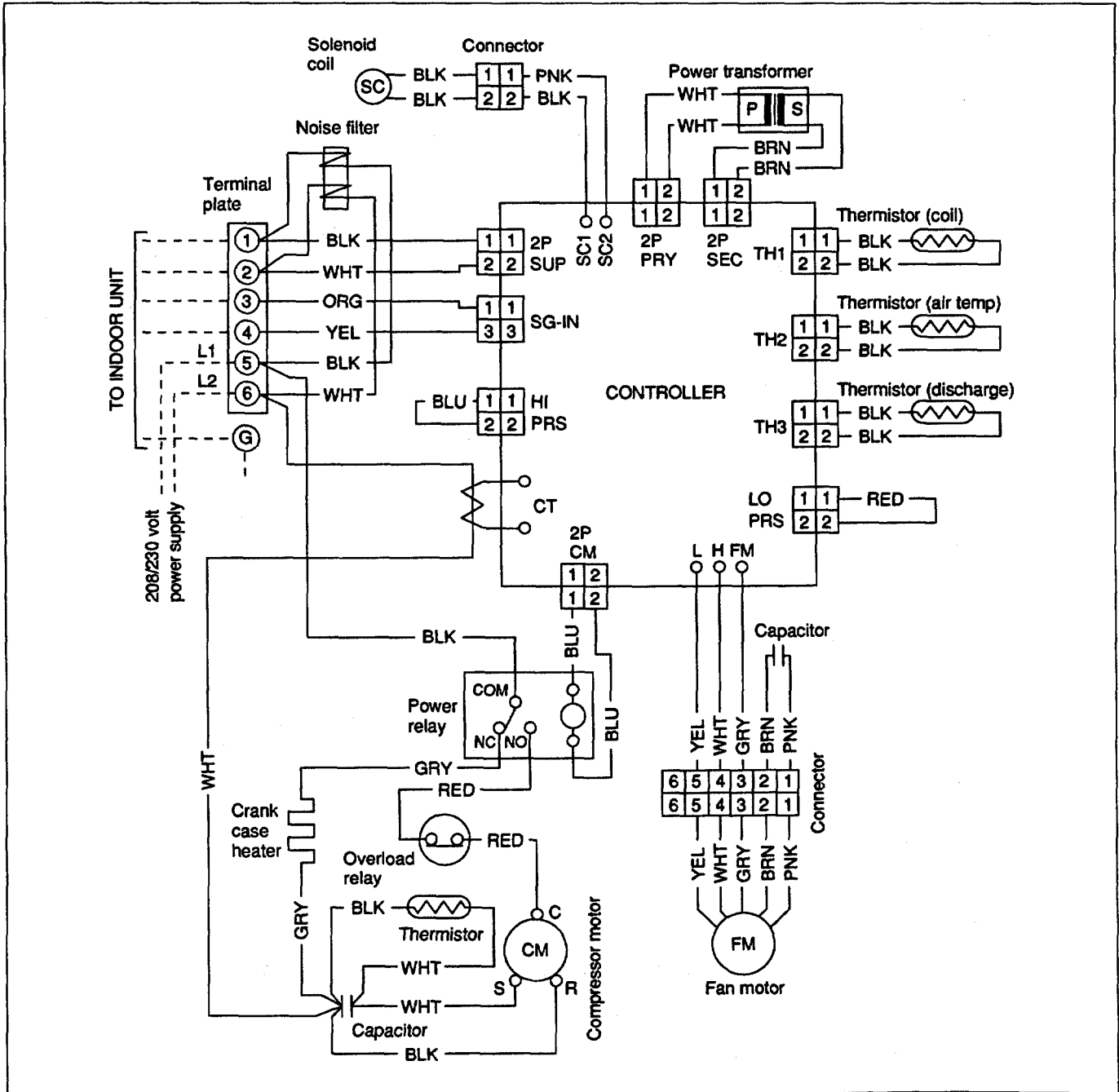

8. TROUBLESHOOTING

8-1. Check before and after troubleshooting



WARNING

Hazardous voltage can cause **ELECTRIC SHOCK** or **DEATH**. Disconnect power or turn off circuit breaker before you start checking or servicing.

8-1-1. Check power supply wiring.

- Check that power supply wires are correctly connected to terminals No. 5 and No. 6 on the terminal plate in the outdoor unit.

8-1-2. Check inter-unit wiring.

- Check that inter-unit wiring is correctly connected to the indoor unit from the outdoor unit.

Power supply:
60Hz, single-phase
230/208 V

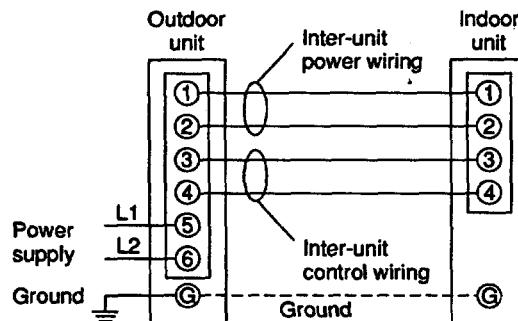

8-1-3. Check power supply.

- Check that voltage is in specified range ($\pm 10\%$ of the rating).
- Check that power is being supplied.

8-1-4. Check lead wires and connectors in indoor and outdoor units.

- Check that coating of lead wires is not damaged.
- Check that lead wires and connectors are firmly connected.
- Check that wiring is correct.

8-2. Troubleshooting Flowchart

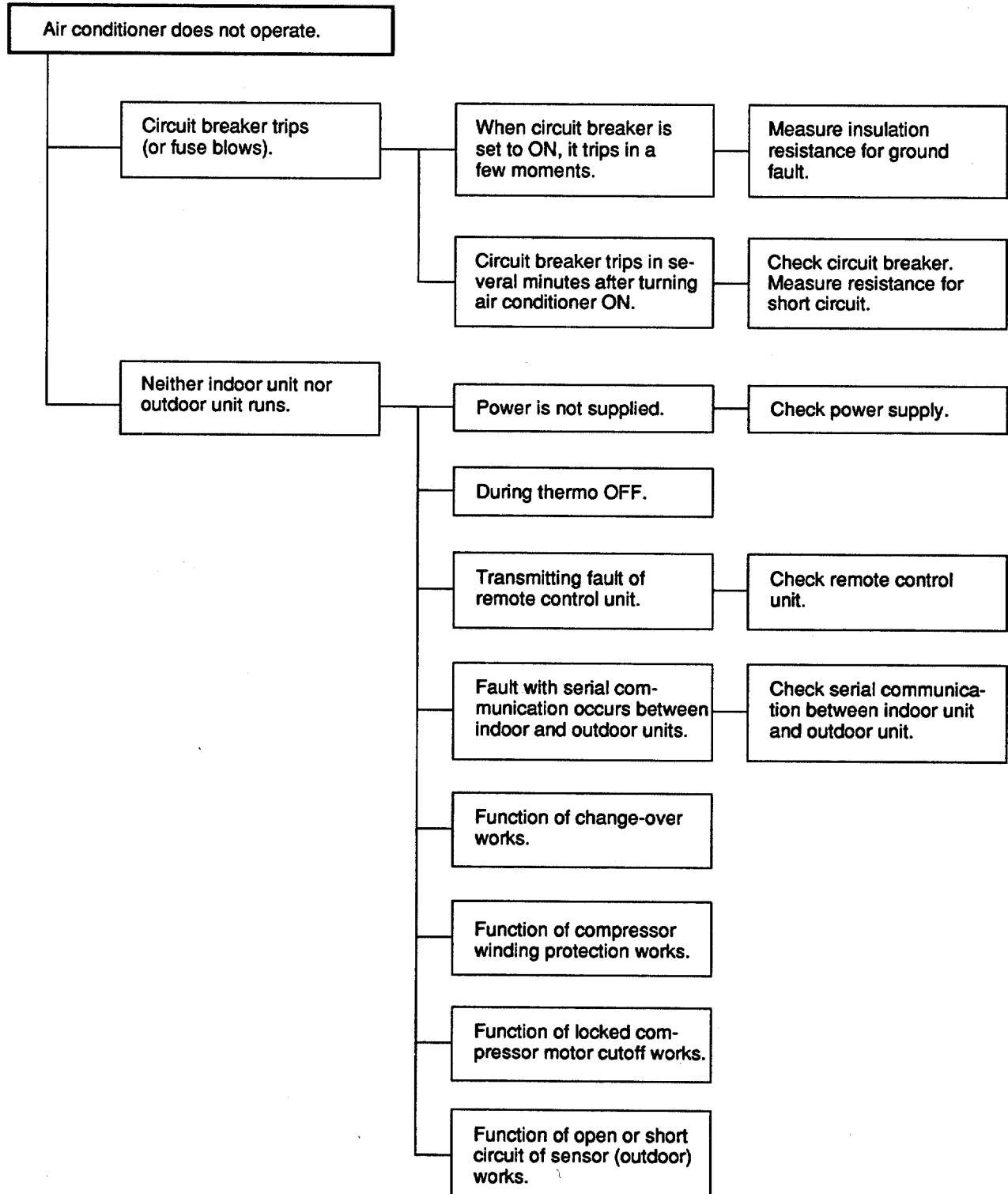

Troubleshooting Flowchart (cont'd)

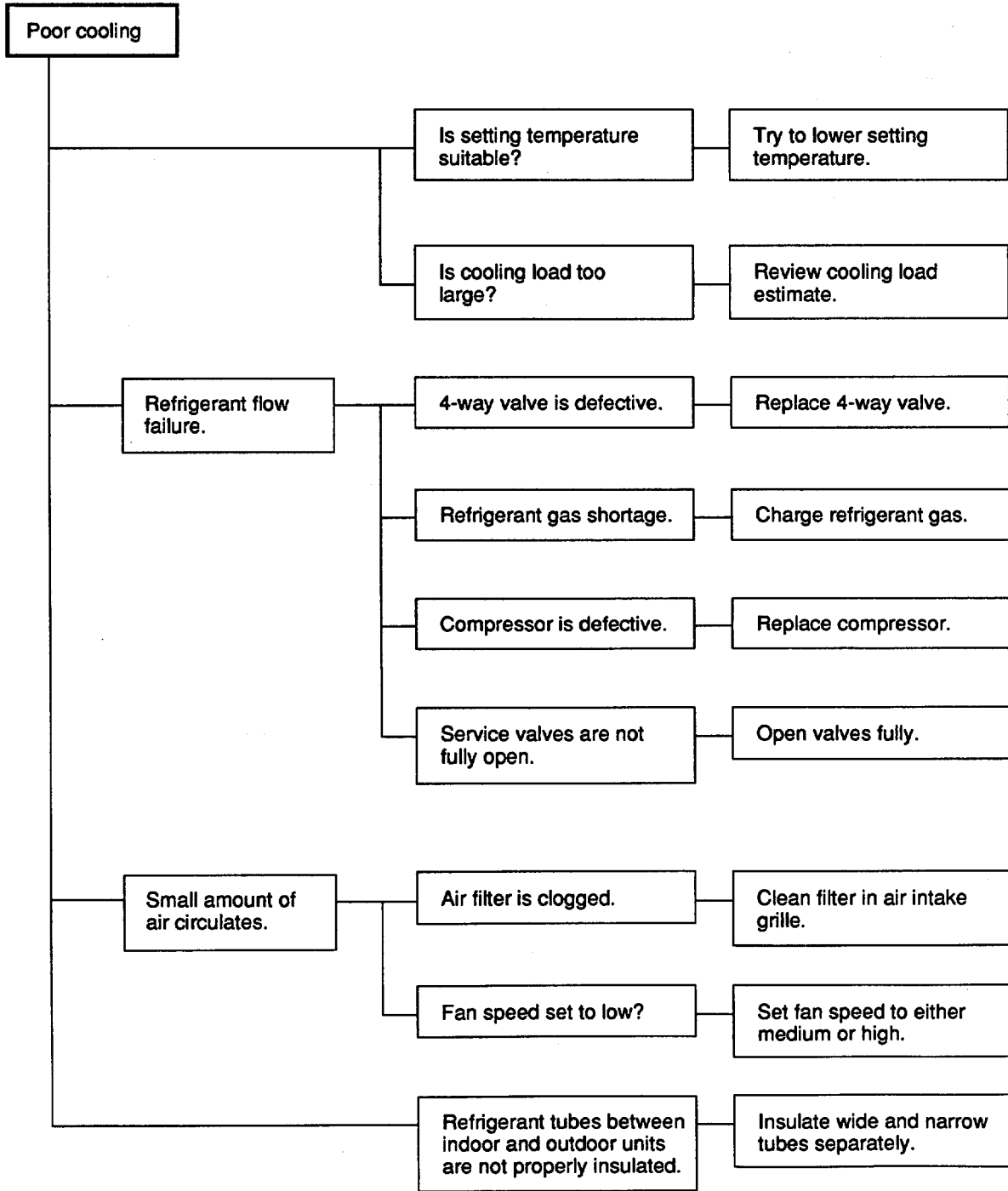

Troubleshooting Flowchart (cont'd)

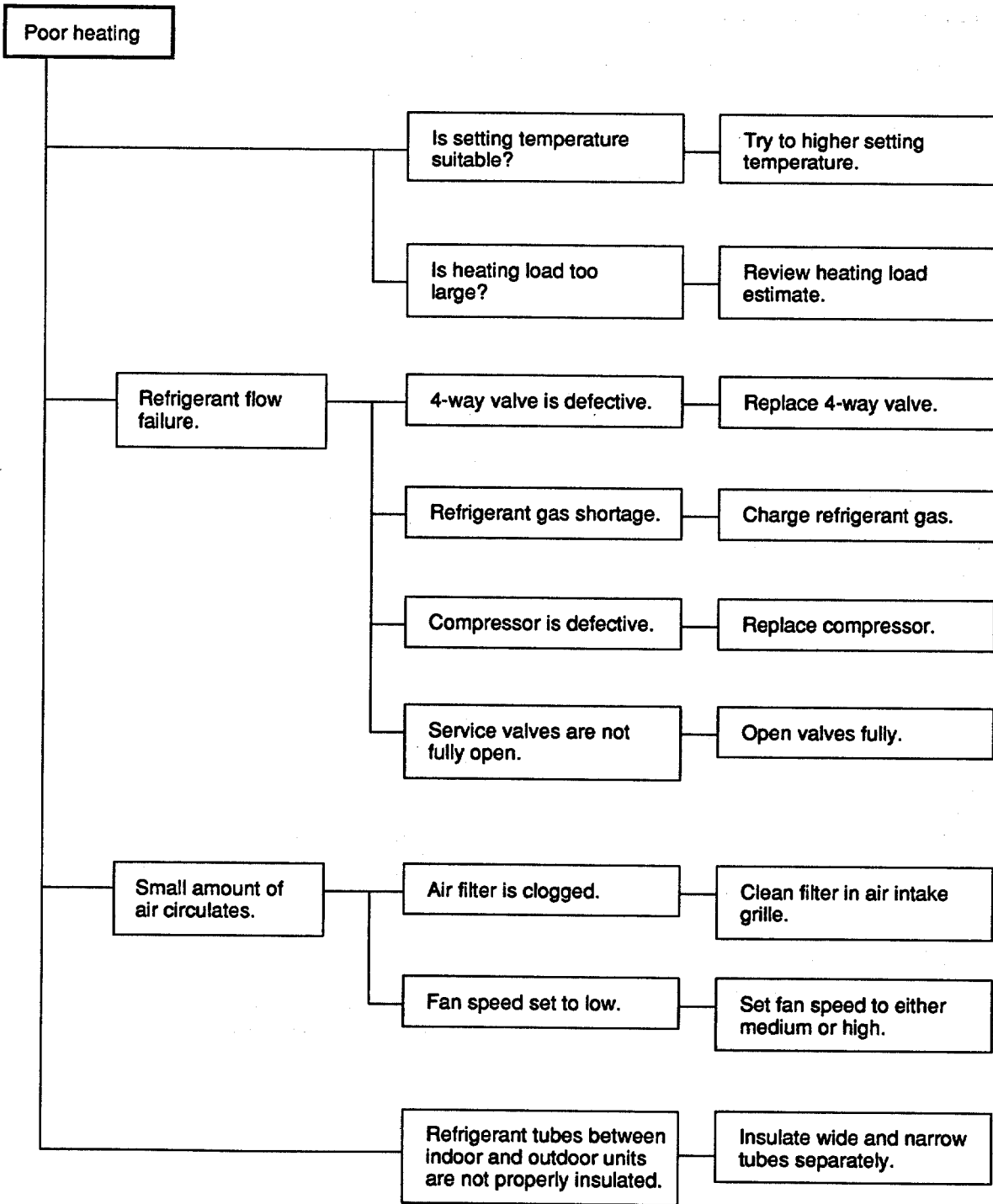

8-3. Checking and Troubleshooting

8-3-1. Measure insulation resistance for ground fault.

If resistance value is $1\text{M}\Omega$ or less, insulation is defective ("NO").

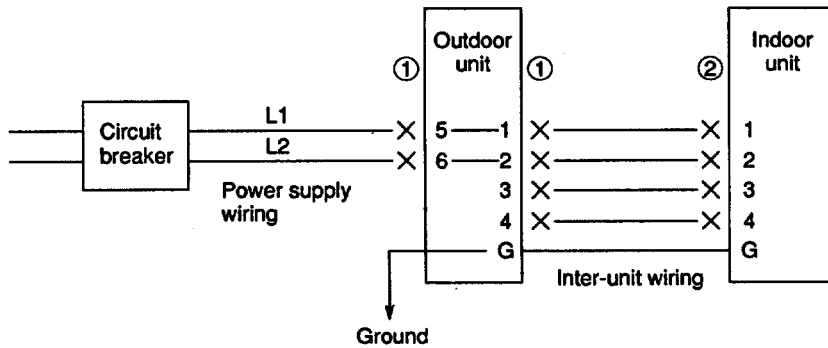

* Set circuit breaker to OFF.

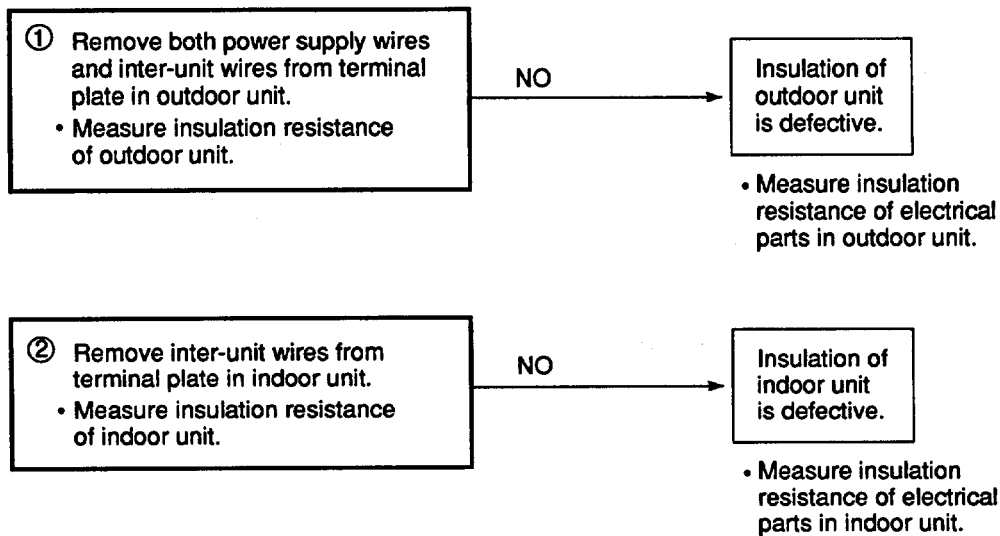

8-3-2. Check circuit breaker.

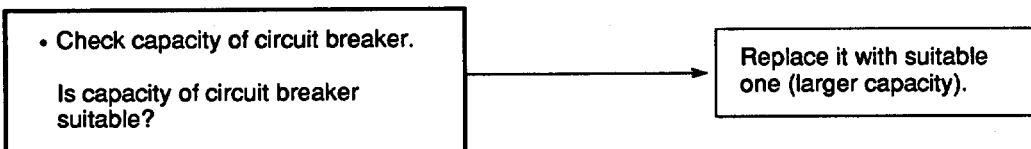

8-3-3. Measure resistance for short circuit.

• Measure resistance of compressor motor winding.

8-3-4. Check power supply.

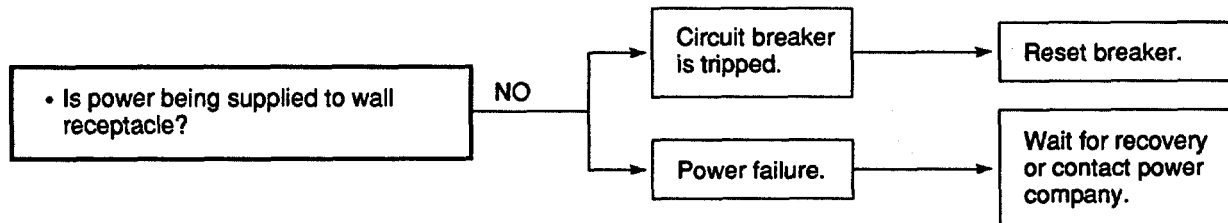

8-3-5. Check remote control unit.

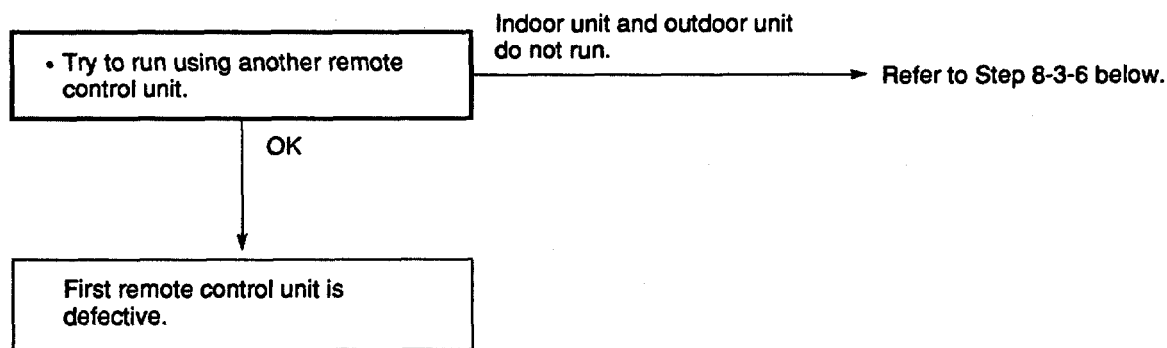

8-3-6. Check OPERATION selector switch in indoor unit.

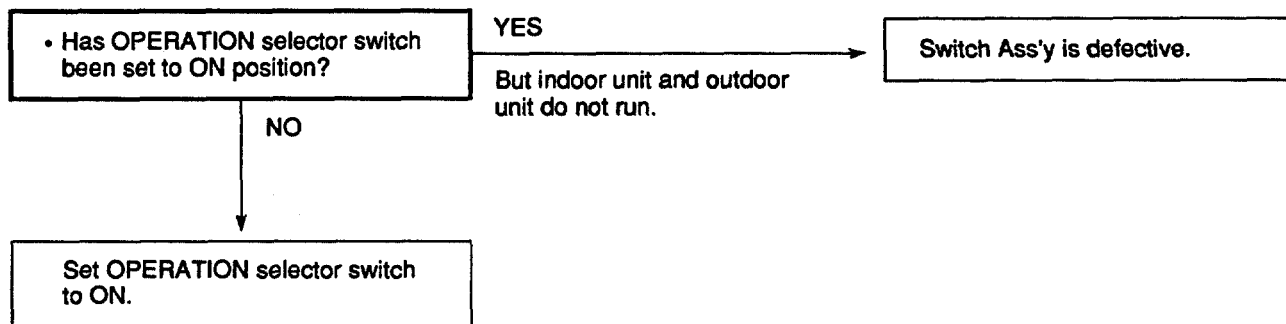

8-3-7. Check serial communication between indoor unit and outdoor unit.

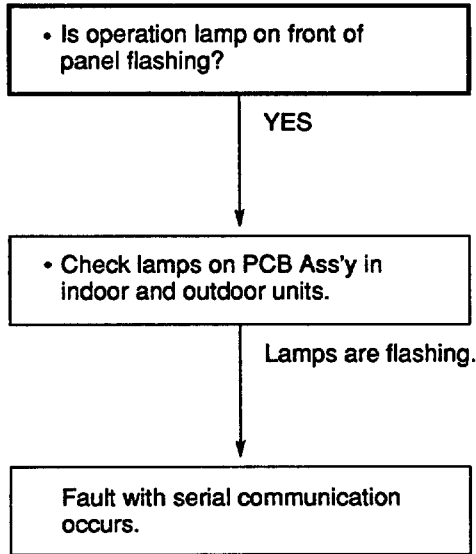

Refer to 5-10. Self-Diagnostic Function.

● Check cause of fault.

(a) Check transformers in indoor and outdoor units.

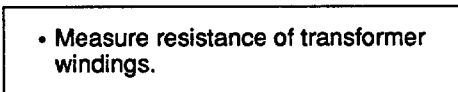

(b) Check fuses on PCB Ass'y in indoor and outdoor units.

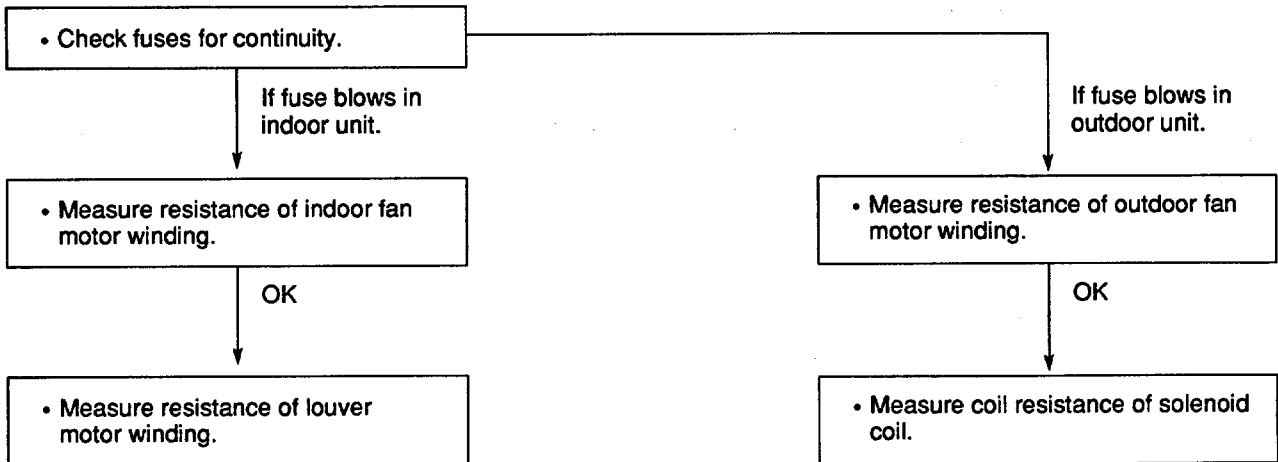

(c) PCB Ass'y in either indoor or outdoor unit is defective.

8-3-8. Only compressor does not run.

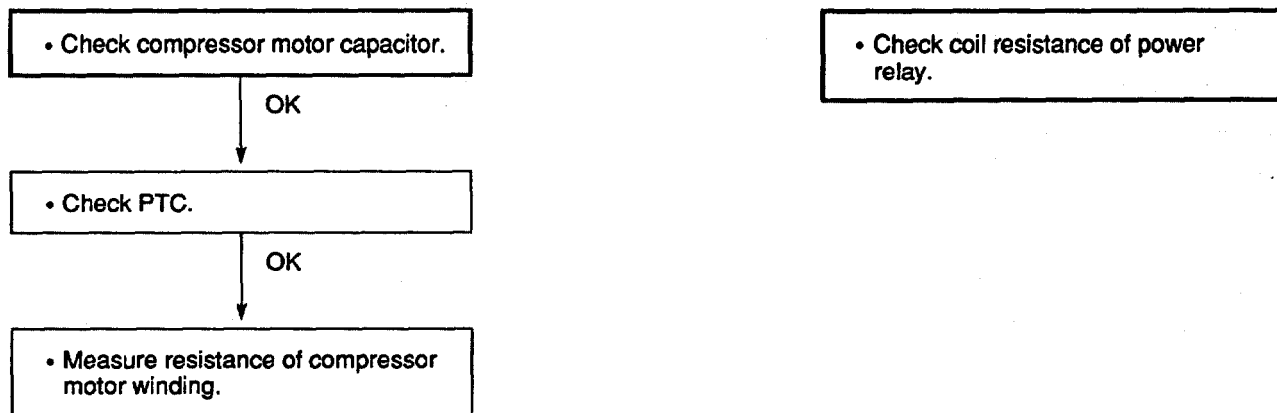

8-3-9. Only fan motor does not run.

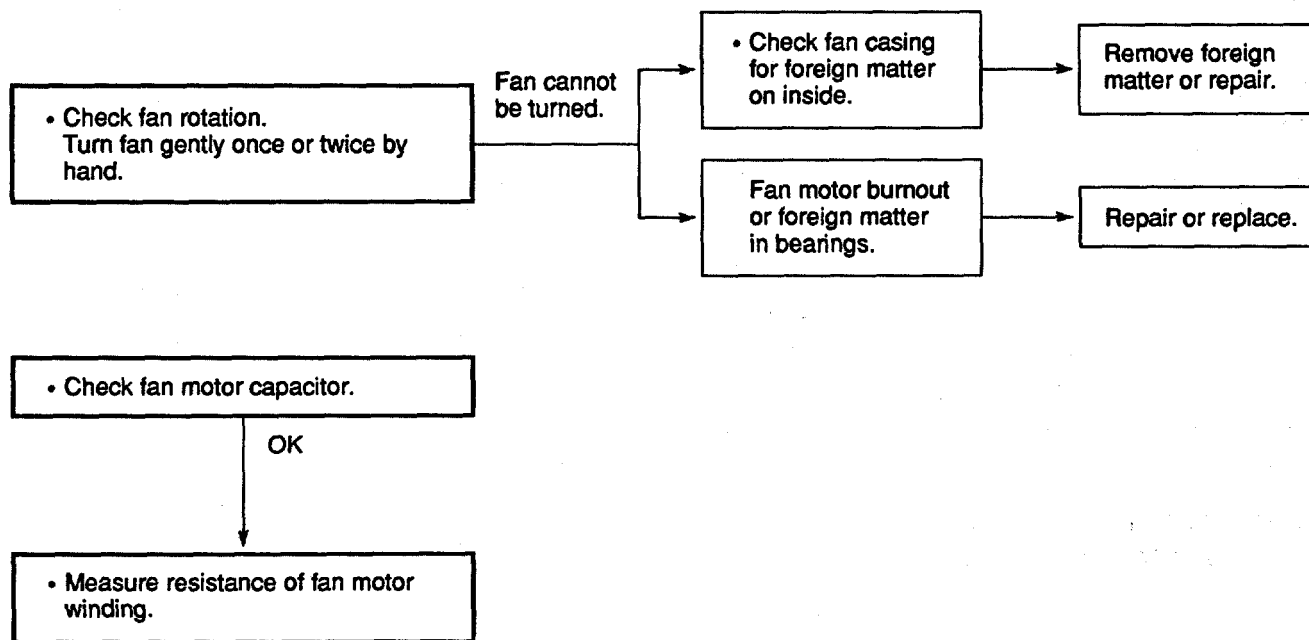

8-3-10. Function of outdoor fan speed control does not work properly.

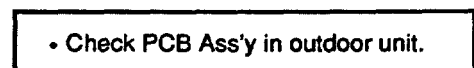

Refer to 5-8. Outdoor Fan Speed Control.

9. CHECKING ELECTRICAL COMPONENTS

9-1. Measurement of Insulation Resistance

- The insulation is in good condition if the resistance exceeds $1M\Omega$.

9-1-1. Power supply wires

Clamp the ground wire of the power supply wires with the lead clip of the insulation resistance tester and measure the resistance by placing a probe on either of the power wires. (Fig. 1)

Then measure the resistance between the ground wire and the other power wire. (Fig. 1)

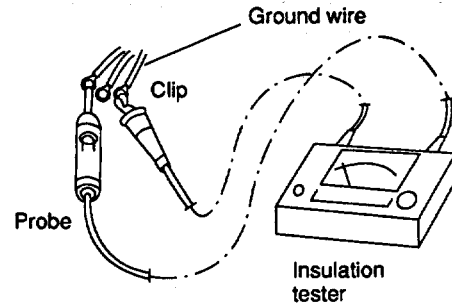

Fig. 1

9-1-2. Indoor unit

Clamp an aluminum plate fin or copper tube with the lead clip of the insulation resistance tester and measure the resistance by placing a probe on each terminal screw except where the ground line is connected on the terminal plate. (Fig. 2)

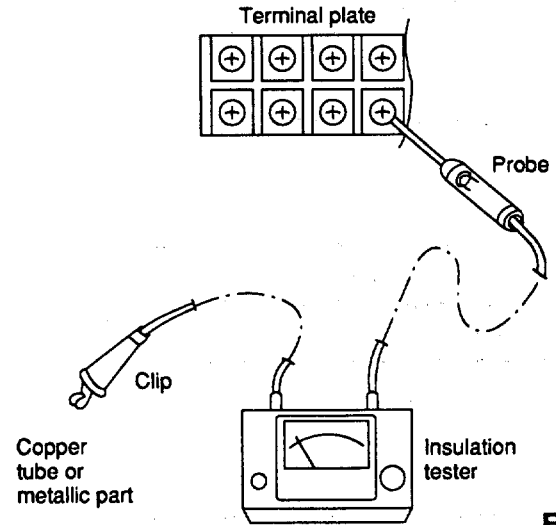

Fig. 2

9-1-3. Outdoor unit

Clamp a metallic part of the unit with the lead clip of the insulation resistance tester and measure the resistance by placing a probe on each terminal screw where power supply lines are connected on the terminal plate. (Fig. 2)

9-1-4. Measurement of insulation resistance for electrical parts

Disconnect the lead wires of the desired electric part from terminal plate, PCB Ass'y, capacitor, etc. Similarly disconnect the connector. Then measure the insulation resistance. (Figs. 1 to 4)

Refer to Electric Wiring Diagram.

NOTE

If the probe cannot enter the poles because the hole is too narrow then use a probe with a thinner pin.

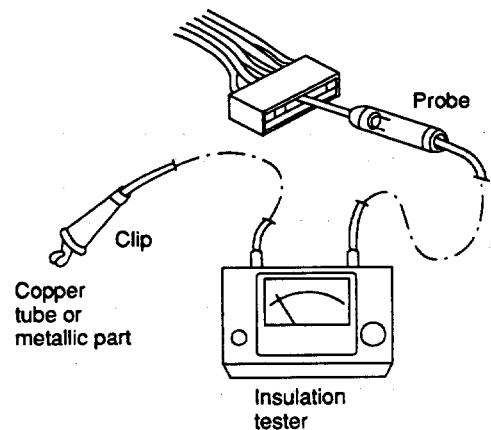

Fig. 3

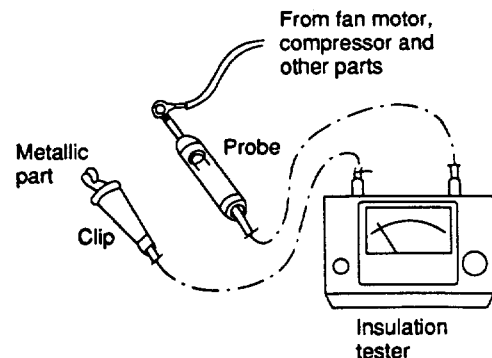

Fig. 4

9-2. Checking Continuity of Fuse on PCB Ass'y

- Check for continuity using a multimeter as shown in Fig. 5.

NOTE

Method Used to Replace Fuse on PCB Ass'y

1. Remove the PCB Ass'y from the electrical component box.
2. Pull the fuse from the metal clasp using pliers while heating the soldered leads on the back side of the PCB Ass'y with a soldering iron (30W or 60W). (Fig. 6)
3. Remove the fuse ends one at a time. For replacement, insert a fuse of the same rating and solder it. (Allow time to radiate heat during soldering so that the fuse does not melt.)



CAUTION

When replacing the fuse, be sure not to break down the varistor.

9-3. Checking Motor Capacitor

Remove the lead wires from the capacitor terminals, and then place a probe on the capacitor terminals as shown in Fig. 7. Observe the deflection of the pointer, setting the resistance measuring range of the multimeter to the maximum value.

The capacitor is "good" if the pointer bounces to a great extent and then gradually returns to its original position.

The range of deflection and deflection time differ according to the capacity of the capacitor.

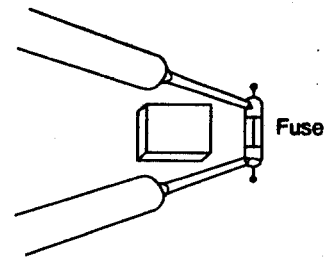

Fig. 5

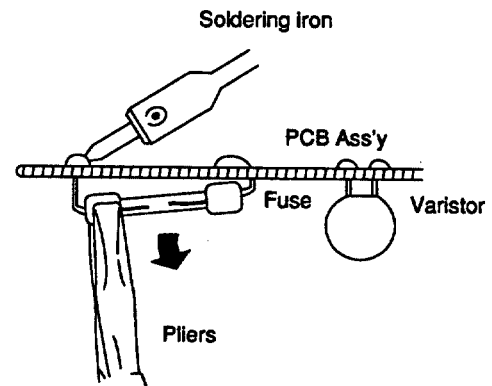

Fig. 6

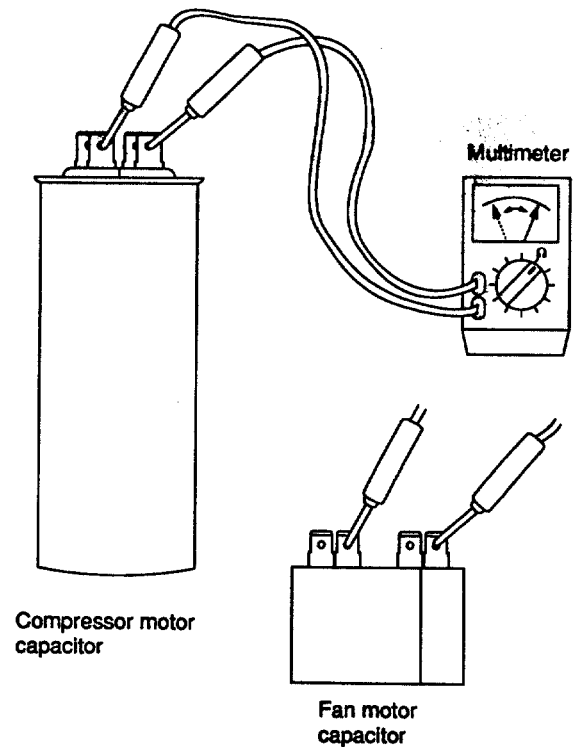

Fig. 7

9-4. Appearance of Electrical Parts

(a) Heater Relay

G4E-2123T-US

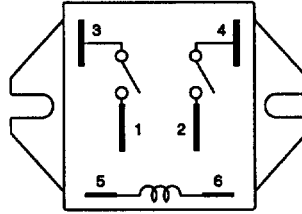

Fig. 8

(b) Power Relay

G4F-11123T-US

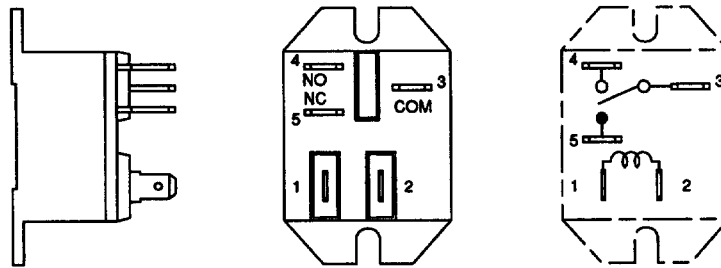

Fig. 9

(c) Thermistor (PTC)

TDK 101YV

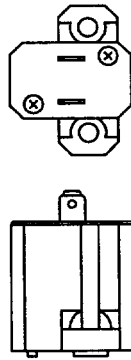

Fig. 10

(d) Thermostat (air blowout temperature)

CT-7L

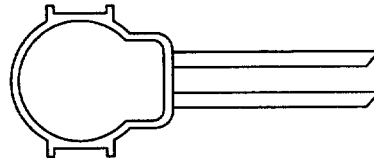

Fig. 11

APPENDIX INSTRUCTION MANUAL

Table of Contents

	Page
Installation Location	3
Electrical Requirements	3
Safety Instructions	3
Names of Parts	4
Using the Remote Control Unit	8
Operation with the Remote Control Unit	9
1. Cooling	9
2. Adjusting the Fan Speed	10
3. Fan Only	11
4. Heating	12
Operation without the Remote Control Unit	13
Setting the Timer	14
Adjusting the Airflow Direction	15
Care and Cleaning	16
Troubleshooting	17
Tips for Energy Saving	17

Installation Location

- We recommend that this air conditioner must be installed properly by a qualified installation technician in accordance with the Installation Instructions provided with the unit.
- Before installation, check that the voltage of the electric supply in your home or office is the same as the voltage shown on the nameplate.



WARNING:



Avoid:

- Do not install this air conditioner where there are fumes or flammable gases, or in an extremely humid space such as a green house.
- Do not install the air conditioner where excessively high heat-generating objects are places.
- To protect the air conditioner from heavy corrosion, avoid installing the outdoor unit where salty sea water can splash directly onto it or in sulphurous air near a spa.

Electrical Requirements

1. All wiring must conform to the local electrical codes. Consult your dealer or a qualified electrician for details.
2. Each unit must be properly grounded with a ground (or earth) wire or through supply wiring.
3. Wiring must be done by a qualified electrician.



CAUTION:

Power mains

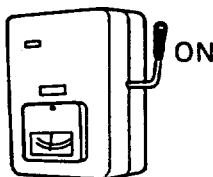

To warm up the system, power mains must be turned on at least five (5) hours before operation. Leave the power mains ON unless you will not be using this appliance for an extended period.

- Power supply: 60 Hz, single-phase
230/208 VOLT

Safety Instructions

- Read this booklet carefully before using this air conditioner. If you still have any difficulties or problems, consult your dealer for help.
- This air conditioner is designed to give you comfortable room conditioners. Use this only for its intended purpose as described in these Instruction Manual.



WARNING:

- Never use or store gasoline or other flammable vapor or liquid near the air conditioner — it is very dangerous.
- This air conditioner has no ventilator for intaking fresh air from outdoors. You must open doors or windows frequently when you use gas or oil heating appliances in the same room, which consume a lot of oxygen from the air. Otherwise there is a risk of suffocation in an extreme case.



CAUTION:

- Do not turn the air conditioner on and off from the power mains switch. Use the operation ON/OFF button.
- Do not stick anything into the air outlet of the air conditioner. This is dangerous because the fan is rotating at high speed.
- Do not let children play with the air conditioner.
- Do not cool or heat the room too much if babies or invalids are present.

Names of Parts

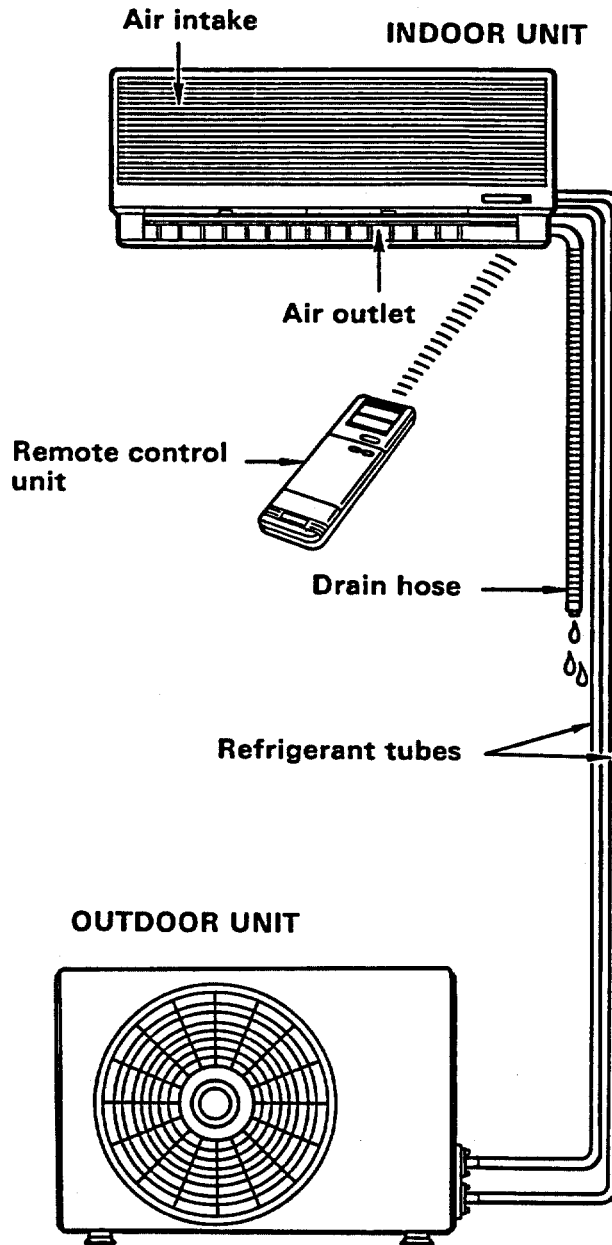

NOTE:

This illustration is based on the external view of a standard model. Consequently, the shape may differ from that of the air conditioner which you have selected.

This air conditioner consists of an indoor unit and an outdoor unit. You can control the air conditioner with the remote control unit.

- Air Intake**
- Air Outlet**
- Remote Control Unit**
- Refrigerant Tubes**
- Drain Hose**
- Outdoor (Condensing) Unit**

Air from the room is drawn into this section and passes through air filters which remove dust. Conditioned air is blown out of the air conditioner through the air outlet. The wireless remote control unit controls power ON/OFF, operation mode selection, temperature, fan speed, timer setting, and air sweeping. The indoor and outdoor units are connected by copper tubes through which refrigerant gas flows. Moisture in the room condenses and drains off through this hose. The outdoor unit contains the compressor, fan motor, heat exchanger coil, and other electrical components.

Unit Display and Operation Selector

INDOOR UNIT

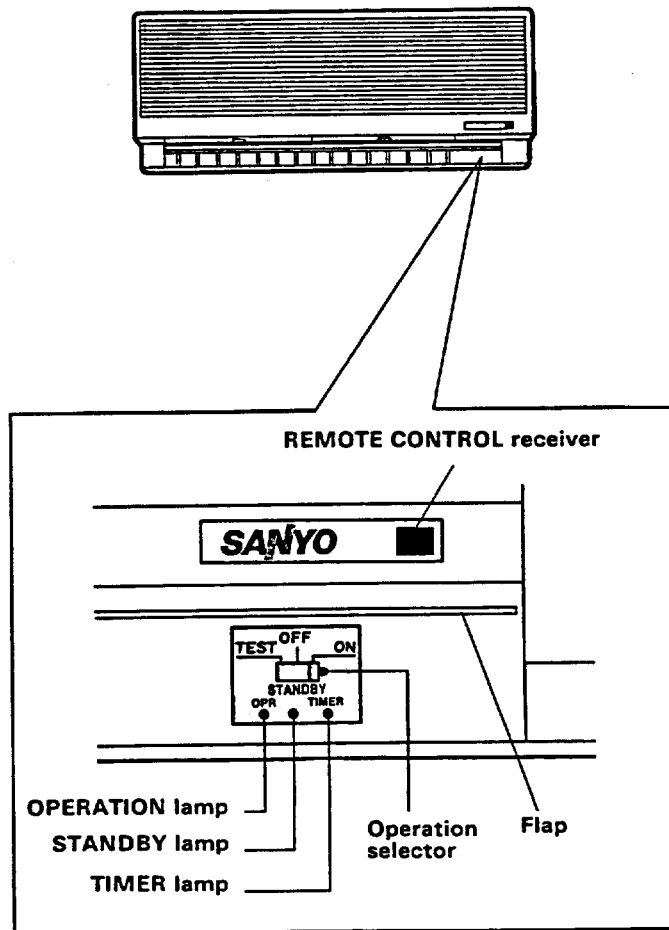

REMOTE CONTROL receiver

This section picks up infrared signals from the remote control unit (transmitter).

OPERATION lamp

This lights when the system is in the continuous COOL or FAN mode.

STANDBY lamp

This lamp lights during warm up period for heating and when the system is defrosting. To keep a constant room temperature, the air conditioner continues to supply a gentle breeze during warm up or when the heating operation is paused by the thermostat.

TIMER lamp

This lamp lights when the system is being controlled by the timer.

Operation selector

ON position

This position is for operating the air conditioner with the wireless remote control unit. Set the selector normally in this position.

OFF position

Switch the selector to the OFF position if you are not going to use the air conditioner for a few days or longer.



WARNING:

The OFF position does not disconnect the power. Use the main power switch to turn off power completely.



CAUTION:

TEST position

This position is used only when servicing the air conditioner, so don't leave the selector in this position.

Remote Control Unit

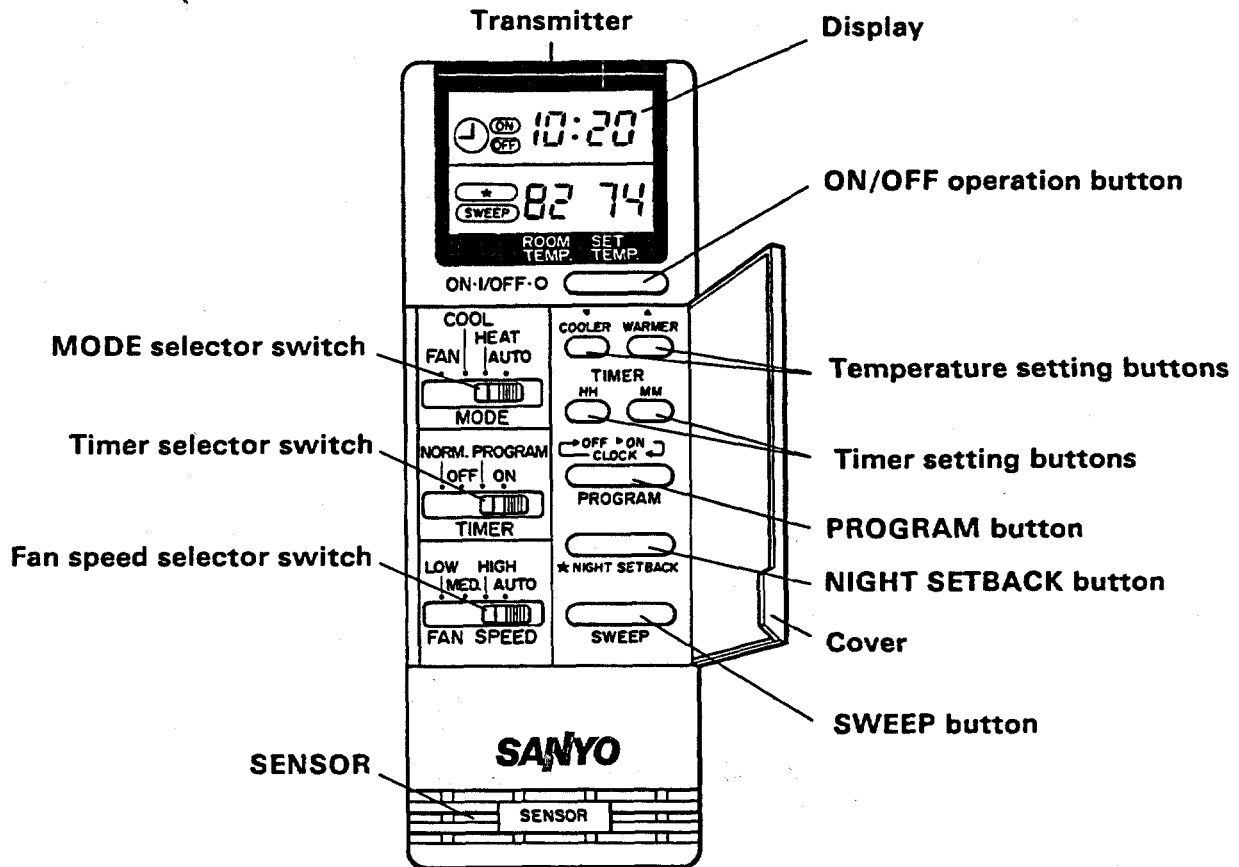

Transmitter

When you press the buttons or move the switches on the remote control unit, the lamp at the tip of the unit flashes to transmit the setting changes to the receiver in the air conditioner.

Display

Information is displayed while the remote control unit is switched on. The display shows the time and the room temperature at the remote control unit when the unit is switched off.

ON/OFF operation button

This button is for turning the air conditioner on and off.

Cover

The cover opens from the left. Just pull it open.

Temperature setting buttons

Press "COOLER" button to change the set temperature down.
Press "WARMER" button to change the set temperature up.



NOTE:

You can press the temperature setting buttons keeping the cover closed.

Timer setting buttons

First, press the PROGRAM button to select the mode you want. Each time you press "HH" button, the hours advance by one. Each time you press "MM" button, the minutes advance by one.

PROGRAM button

For details, see "Setting the Timer". Press this button to select the mode you want to program.

NIGHT SETBACK button

For details, see "Night Setback Mode". When you press this button in the COOL mode, the  mark appears at the lower left of the display, and the remote control unit will automatically adjust the set temperature to save energy.

Remote Control Unit (continued)

SWEEP button

When you press this button, the **SWEEP** mark will appear at the lower left of the display, and the flap in the air outlet starts moving up and down to deliver air over the sweep range set. To stop sweeping, just press the SWEEP button again.

MODE selector switch

FAN: The air conditioner works only as a circulation fan.
COOL: The air conditioner makes the room cooler.
HEAT: The air conditioner makes the room warmer.
AUTO: When this setting is selected, the air conditioner calculates the difference between the thermostat setting and the room temperature and automatically switches to the "cool" or "heat" mode as appropriate.

Timer selector switch

NORM.: The timer does not operate.
OFF: The air conditioner stops at the set time.
ON: The air conditioner starts at the set time.
PROGRAM: The air conditioner stops and starts, or starts and stops, at the set times every day.

Fan speed selector switch

AUTO: The air conditioner automatically decides the fan speeds.
HIGH: High speed for fast cooling
MED.: Medium speed
LOW: Low speed

SENSOR

A temperature sensor inside the remote control unit senses the room temperature.

Using the Remote Control Unit

How to Install Batteries

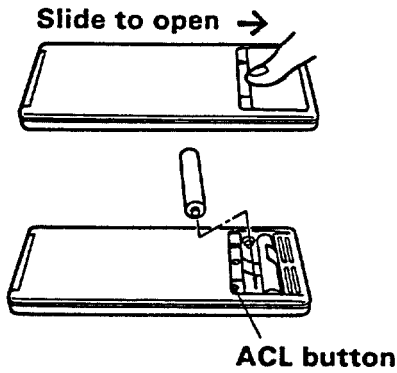

NOTE:

1. Press and slide the lid on the back of the remote control unit in the direction of the arrow.
 2. Install two AAA alkaline batteries. Make sure the batteries point in the direction marked in the battery compartment.
 3. Press the ACL button, then replace the lid. If you press it, the current time, ON time, and OFF time are all reset to 0:00. This may make it easier for you to reset those times. (See "Setting the Timer".)
- The batteries last about six months, depending on how much you use the remote control unit. Replace the batteries when the remote control unit's lamp fails to light, or when the remote control cannot be used to change the air conditioner's settings.
 - Use two fresh leak-proof type-AAA alkaline batteries.
 - In replacing batteries, follow the instructions as mentioned in the sub-section "How to Install Batteries".
 - If you do not use the remote control unit more than 1 month, take out the batteries.

How to Use the Remote Control Unit

When using the remote control unit, always point the unit's transmitter head directly at the air conditioner's receiver.

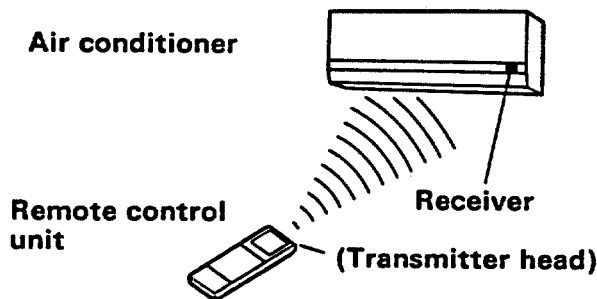

Remote Control Unit Installation Position

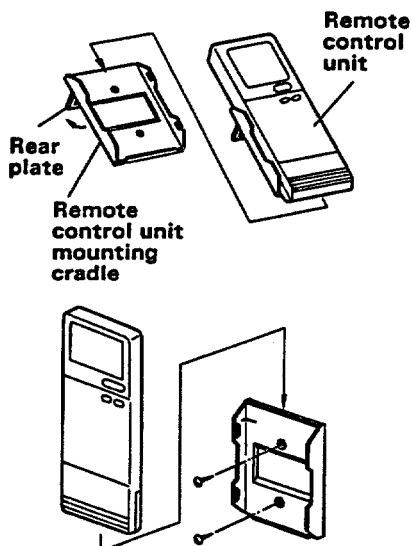

The indoor remote unit may be operated either from a non-fixed position or from a wall-mounted position. To ensure that the air conditioner operates correctly, do not install the remote control unit in the following places:

- In direct sunlight
- Behind a curtain or other places where it is covered
- More than 26 ft. away from the air conditioner
- In the path of the air conditioner's airstream
- Where it may become extremely hot or cold
- Where it may be subject to electrical or magnetic noise

1. If Non-fixed Position

Raise the rear plate of the remote control unit mounting cradle and insert the remote control unit. The unit can be used either in that position (placed on a table, for instance) or held in the hand.

2. If Wall-mounted Fixed Position

Install the remote control unit at a convenient location on a nearby wall. However, before attaching the remote control unit mounting cradle, check that the remote control unit can operate from the desired wall position.

Operation with the Remote Control Unit

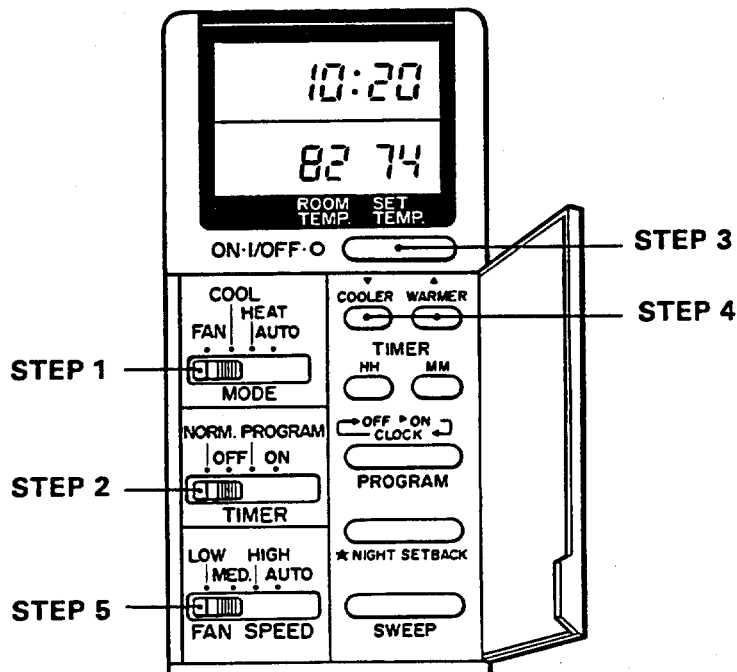

NOTE:

1. Cooling

Check that the circuit breaker on the power panel is turned on and the operation selector of the indoor unit is in the ON position.

- STEP 1:** Set the MODE selector switch to COOL.
STEP 2: Set the timer selector switch to NORM.
STEP 3: Press the ON/OFF operation button.
STEP 4: Press the COOLER or WARMER button to set a cooler or warmer temperature.
 Each time you press these buttons, the set temperature varies by 2° F.
 84° F max.
 64° F min.
- STEP 5:** Set the fan speed selector switch to the setting you want.

To stop the air conditioner, press the ON/OFF operation button again.



NOTE:

- Choose the best position in the room for the remote control unit, which also acts as the sensor for room comfort and transmits the operating instructions. Once you've found this best position, always keep the remote control unit there.
- This appliance has a built-in 3-minute time delay circuit to ensure reliable operation. If the operation button is pressed, the compressor will start running after three minutes. In the event of power failure, the unit will stop. When the power is applied, the unit will re-start automatically after 3 minutes.
- To prevent the appliance from malfunctioning, do not set any selector switch between two indicated positions. Make sure that it clicks into position.



CAUTION:

Operation with the Remote Control Unit (continued)

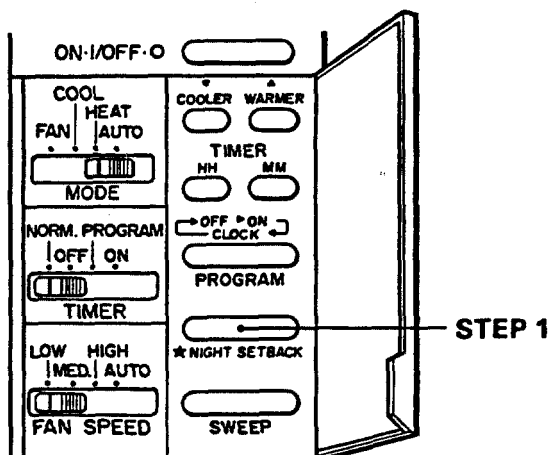

Night Setback Mode in Cooling

STEP 1: Press the NIGHT SETBACK button in cooling. The  mark appears at the lower left of the display. Press the NIGHT SETBACK button again to release the night setback function. This button has no effect in the FAN mode.

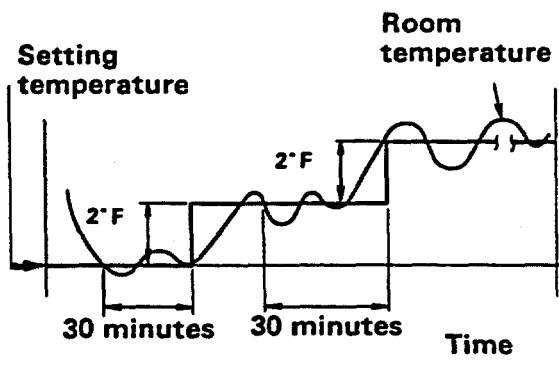

What does the Night Setback mode mean?

In this mode, the air conditioner will cool the room to the set temperature, and then the thermostat will make the unit pause. After about 30 minutes, the air conditioner will automatically raise the set temperature by 2°F. When the room temperature reaches the newly set value, the thermostat will cause the unit to pause. After about 30 minutes the temperature will again be raised by 2°F. This enables you to save energy without sacrificing comfort. This function is convenient when gentle cooling is needed.

2. Adjusting the Fan Speed

A. Automatic

STEP 1: Simply set the FAN SPEED selector to the "AUTO" position.

A microcomputer in the air conditioner automatically controls the fan speed when the AUTO mode is selected. When the air conditioner starts operating, the difference between the room temperature and the set temperature is detected by the microcomputer which then automatically switches the fan speed to the most suitable level.

Operation with the Remote Control Unit (Continued)

Cooling mode:

When difference between room temperature and set temperature is	FAN SPEED
4° F and over	High
Between 4° F and 2° F	Medium
Below 2° F	Low

Heating mode:

When difference between room temperature and set temperature is	FAN SPEED
2° F and over	High
Below 2° F	Medium

B. Manual

If you want to adjust fan speed manually during cooling, just set the FAN SPEED selector as desired. [HIGH, MED., or LOW]

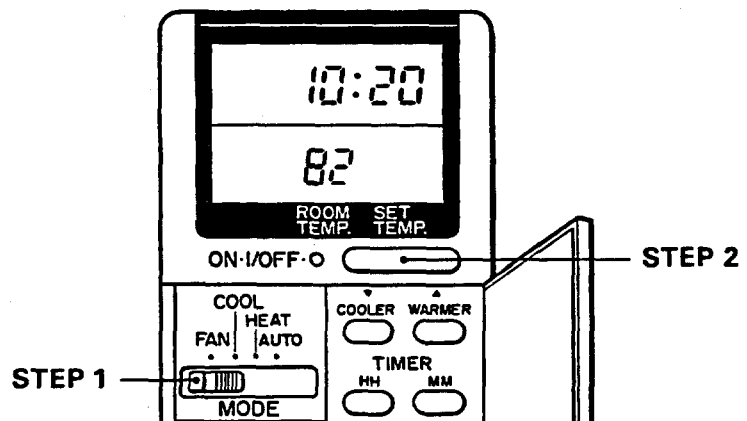

3. Fan Only

If you want to circulate air without any temperature control, follow these steps:

- STEP 1:** Set the MODE selector switch to FAN.
- STEP 2:** Press the ON/OFF operation button.

Operation with the Remote Control Unit (Continued)

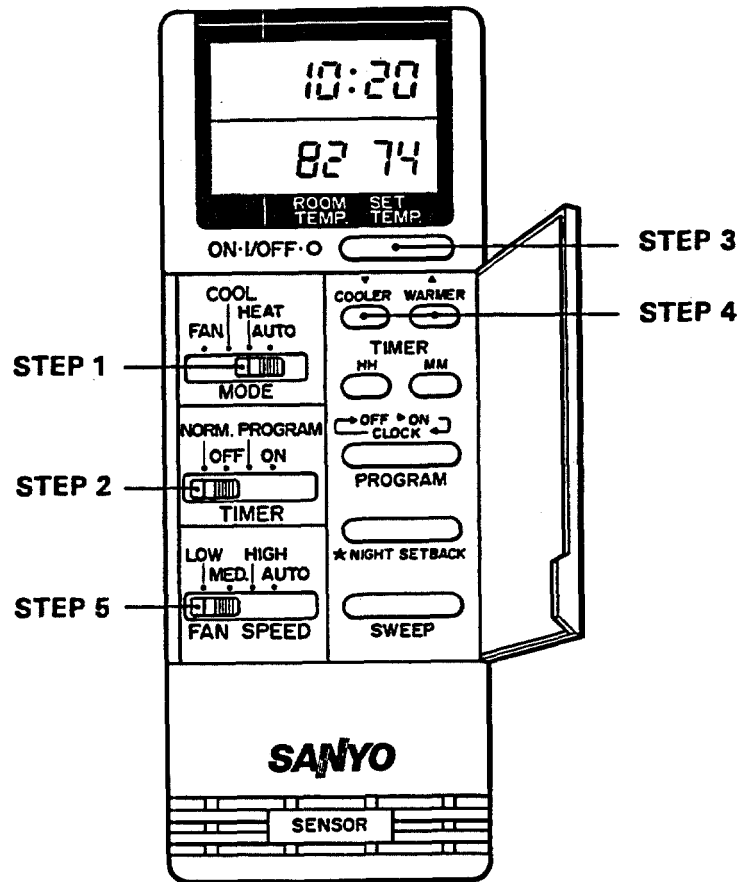

4. Heating

- STEP 1:** Set the MODE selector switch to HEAT.
STEP 2: Set the timer selector switch to NORM.
STEP 3: Press the ON/OFF operation button.
STEP 4: Press the COOLER or WARMER button to set a cooler or warmer temperature.
 Each time you press these buttons, the set temperature varies by 2° F.
 84° F max.
 64° F min.
- STEP 5:** Set the fan speed selector switch to the setting you want.
 To stop the air conditioner, press the ON/OFF operation button again.



NOTE:

- Choose the best position in the room for the remote control unit, which also acts as the sensor for room comfort and transmits the operating instructions. Once you've found this best position, always keep the remote control unit there.
- This appliance has a built-in 3-minute time delay circuit to ensure reliable operation. If the operation button is pressed, the compressor will start running after three minutes. In the event of power failure, the unit will stop. When the power is applied, the unit will re-start automatically after 3 minutes.



CAUTION:

- To prevent the appliance from malfunctioning, do not set any selector switch between two indicated positions. Make sure that it clicks into position.



CAUTION:

If the outdoor temperature is extremely low, it is recommended to use another heating appliance:
When the outdoor temperature falls to around 10° F, the compressor stops. In this case, to prevent room from freezing, use another heating appliance.

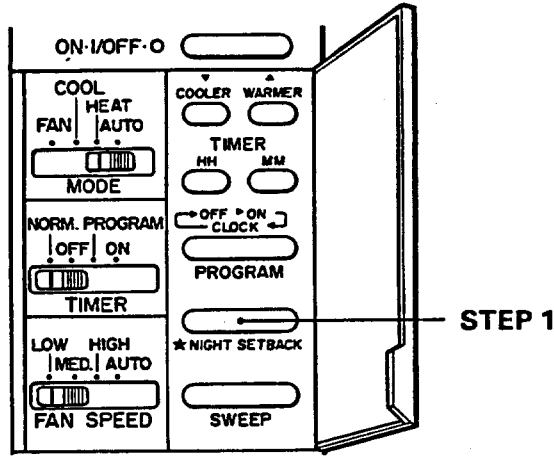

Night Setback Mode in Heating

STEP 1: Press the NIGHT SETBACK button in cooling. The  mark appears at the lower left of the display. Press the NIGHT SETBACK button again to release the night setback function. This button has no effect in the FAN mode.

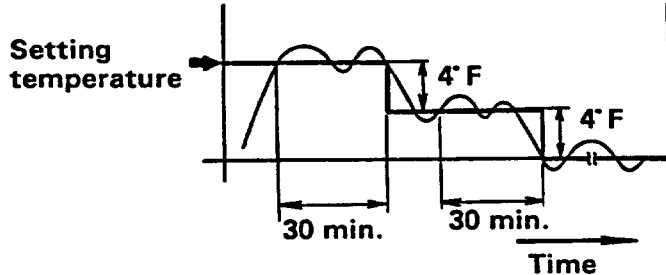

What does the Night Setback mode mean?

In this mode, the air conditioner will heat the room to the set temperature, and then the thermostat will make the unit pause. After about 30 minutes, the air conditioner will automatically lower the set temperature by 4° F. When the room temperature reaches the newly set value, the thermostat will cause the unit to pause. After about 30 minutes the temperature will again lowered by 4° F. This enables you to save energy without sacrificing comfort. This function is convenient when gentle heating is needed.

Operation without the Remote Control Unit

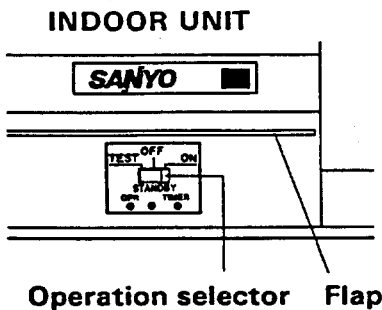

If you have lost the remote control unit or it has trouble, follow the steps below.

1. When the air conditioner is stopped. If you want to turn on the air conditioner, switch the operation selector to the OFF position, and then to the ON position.



NOTE:

The set temp. and fan speed are automatically set at the latest selection before stopping.

2. When the air conditioner is running. If you want to turn off the air conditioner, switch the operation selector to the OFF position.

Setting the Timer

1) How to set the present time

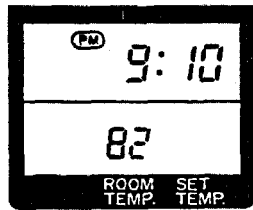

(Example) To set to 9:10 p.m.

Operation	Indication
1. Press the PROGRAM button three times. The time indication alone flashes.	Flashing
2. <ul style="list-style-type: none"> Press the HH button until 9 and (PM) are displayed. Press the MM button until 10 is displayed. The display will automatically stop flashing except for the ":" symbol after 10 sec. 	Flashing

2) How to set the OFF time

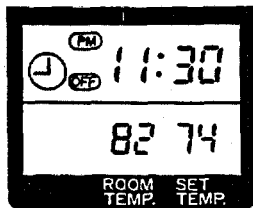

(Example) To stop the air conditioner at 11:30 p.m.

1. Press the PROGRAM button once. The timer OFF and time indications flash.	Flashing
2. <ul style="list-style-type: none"> Press the HH button until 11 is displayed. Press the MM button until 30 is displayed. The display will change automatically back to show the present time after 10 sec. 	Flashing
3. Set the timer switch(es) to OFF.	
4. Press the ON/OFF button to start the air conditioner.	

3) How to set the ON time

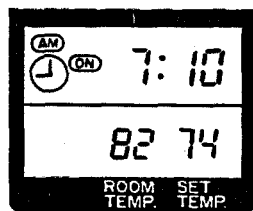

(Example) To start operation at 7:10.

1. Press the PROGRAM button twice. The timer ON and time indications flash.	Flashing
2. <ul style="list-style-type: none"> Press the HH button until 7 and (AM) are displayed. Press the MM button until 10 is displayed. The display will change automatically back to show the present time after 10 sec. 	Flashing
3. Set the timer switch(es) to ON.	
4. Press the ON/OFF button to start the air conditioner.	

4) How to set for daily ON/OFF operation

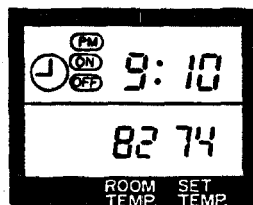

(Example) To start operation at 7:10 and stop the air conditioner at 11:30 p.m.

1. Set the timer ON/OFF times as shown in 2) and 3).	
2. Set the timer switch(es) to PROGRAM.	
3. Press the ON/OFF button to start the air conditioner.	



NOTE:

Power failure during timer operation

If power failure occurs, the time counted up to that point will become void. After the power is applied, the timer newly starts counting at the set time.

Adjusting the Airflow Direction

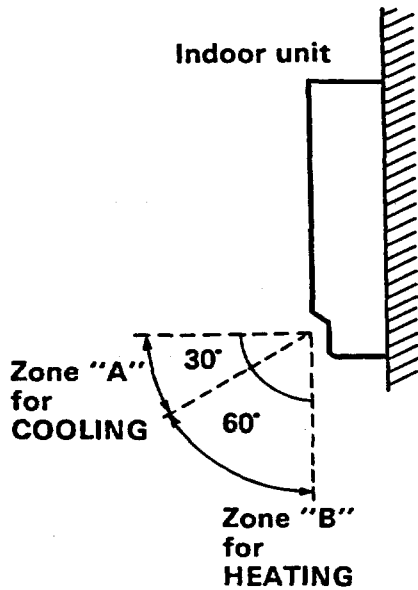

A. Horizontal

The horizontal airflow can be adjusted by moving the vertical vane to the left or right.

B. Vertical

Confirm that the remote control unit has been turned on. Press the SWEEP button to start the flap moving up and down. If you want to stop the flap movement and to direct the air in the desired direction, press the SWEEP button again. In the COOL mode, don't direct the flap down more than 30° otherwise, condensation may drip on to the floor. Zone "A" is the recommended flap position for cooling.



CAUTION:

Do not move the flap with your hands.

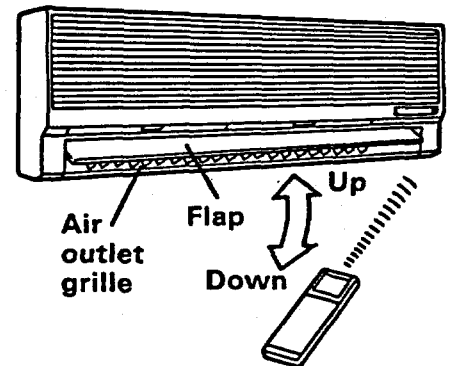
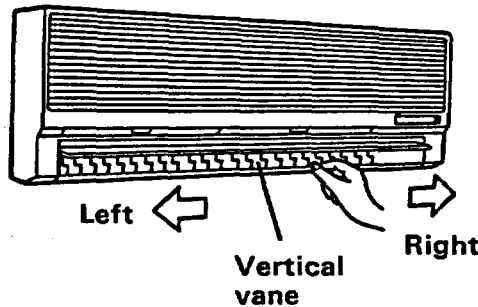

Care and Cleaning



WARNING:

1. For safety, be sure to turn the air conditioner off and also to disconnect the power before cleaning.
2. Do not pour water on the indoor unit to clean it. This will damage the internal components and cause an electric shock hazard.

Casing and Grille (Indoor Unit)

Clean the casing and grille of the indoor unit with a vacuum cleaner brush, or wipe them with a clean, soft cloth.

If these parts are stained, use a clean cloth moistened with a mild liquid detergent. When cleaning the grille, be careful not to force the vanes out of place.



CAUTION:

1. Never use solvents, or harsh chemicals when cleaning the indoor unit. Do not wipe the plastic casing using very hot water.
2. Some metal edges and the fins are sharp and may cause injury if handled improperly; be especially careful when you clean these parts.
3. The internal coil and other components of the outdoor unit must be cleaned every year. Consult your dealer or service centre.

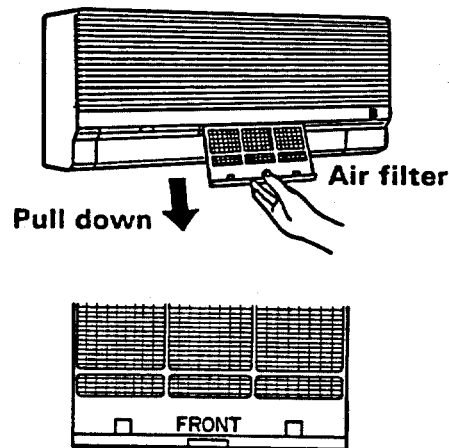

Air Filter

The air filter behind the air intake grille should be checked and cleaned at least once every two weeks.

How to remove the filter

1. Move the flap on the air outlet grille to its lowest position.
2. Hold the air filter by the tab at the bottom, and pull downward.

Use a vacuum cleaner to remove light dust. If there is sticky dust on the filter, wash the filter in lukewarm, soapy water, rinse it in clean water, and dry it. When replacing the filter, make sure that the **FRONT** mark is facing you.

Troubleshooting

If your air conditioner does not work properly, first check the following points before requesting service. If it still does not work properly, contact your dealer or service centre.

Trouble	Possible Cause	Remedy
Air conditioner does not run at all	<ol style="list-style-type: none"> 1. Power failure 2. Leakage breaker tripped 3. Line voltage too low 4. Operation button is OFF 5. Batteries in remote control unit have run down 	<ol style="list-style-type: none"> 1. Restore power 2. Contact service centre 3. Consult with electrician or dealer 4. Press the button again 5. Replace batteries
Compressor runs but soon stops	<ol style="list-style-type: none"> 1. Obstruction in front of condenser coil 	<ol style="list-style-type: none"> 1. Remove obstruction
Poor cooling (or heating) performance	<ol style="list-style-type: none"> 1. Dirty or clogged air filter 2. Heat source or many people in room 3. Doors and/or windows are open 4. Obstacle near air intake or air discharge port 5. Thermostat is set too high for cooling (or too low for heating) 6. (Outdoor temperature is too low) 7. (Defrosting system does not work) 	<ol style="list-style-type: none"> 1. Clean air filter to improve airflow 2. Eliminate heat source if possible 3. Shut them to keep the heat out 4. Remove it to ensure good airflow 5. Set the temperature lower 6. (Try to use any back-up heater) 7. (Consult your dealer)

Tips for Energy Saving

Do not:

- Block the air intake and outlet of the unit. If it is obstructed, the unit will not work well, and may be damaged.
- Let direct sunlight into the room. Use sunshades, blind or curtains. If the walls and ceiling of the room are warmed by the sun, it will take longer to cool the room.

Do:

- Always try to keep the air filter clean. (Refer to "Care and Cleaning"). A clogged filter will impair the performance of the unit.
- To prevent conditioned air from escaping, keep windows, doors and any other openings closed.

Nov. / '95 / 1350 Printed in the U.S.A.

For Parts or Service Contact
SANYO FISHER SERVICE CORPORATION
1200 West Artesia Blvd., Compton, California, 90220, USA
50 Beth Neilson Drive, Toronto, Ontario, M4H 1M6, CANADA

Free Manuals Download Website

<http://myh66.com>

<http://usermanuals.us>

<http://www.somanuals.com>

<http://www.4manuals.cc>

<http://www.manual-lib.com>

<http://www.404manual.com>

<http://www.luxmanual.com>

<http://aubethermostatmanual.com>

Golf course search by state

<http://golfingnear.com>

Email search by domain

<http://emailbydomain.com>

Auto manuals search

<http://auto.somanuals.com>

TV manuals search

<http://tv.somanuals.com>