

INSTRUCTION MANUAL

Split System Air Conditioner

COOL/FAN Model

Wall-mounted type	Ceiling-mounted type	Recessed type
KS2432	TS2432	XS1822, XS1852
KS3032	TS3632	XS2432
KS3632	TS4232	XS3632
		XS4232



Save These Instructions!

Features

These air conditioners are equipped with cooling function. Details on this function are provided below; refer to these descriptions when using the air conditioner.

- **Microprocessor Controlled Operation**
The interior compartment of the remote control unit contains several features to facilitate automatic operation, easy logically displayed for easy use.
- **Air Sweep Control**
This function moves a flap up and down in the air outlet, directing air in a sweeping motion around the room and providing comfort in every corner.
- **Simple One-touch Wireless Remote Control**
The remote control unit has several features to facilitate automatic operation.
- **Automatic Restart Function for Power Failure**
Even when power failure occurs, preset programmed operation can be reactivated once power resumes.
- **24-hour clock with ON/OFF Program Timer**
The wireless remote controller allows you to set up a wide variety of time based operations. Such functions include automatic on/off with time settings, same time on/off every day, on timer and off timer.
- **Anti-Mold Filter**
This unit is equipped with an anti-mold filter that inhibits the growth of mold and bacteria.
- **1-Hour OFF Timer**
This timer can be set to automatically turn off the unit at any time after one hour.
- **Night Setback**
Pressing this button changes the setting of the room temperature thermostat, allowing you to set the temperature at whatever level that you find comfortable.
- **Automatic and 3-step Fan Speed**
Auto/High/Medium/Low

Contents

	Page
Features.....	2
Product Information	3
Alert Symbols	3
Installation Location.....	4
Electrical Requirements	4
Safety Instructions	4
Names of Parts	5
Using the Remote Control Unit	11
Operation with the Remote Control Unit.....	13
1. Operation	13
2. Adjusting the Fan Speed.....	14
3. Fan Only.....	14
4. Night Setback Mode	15
Special Remarks	16
Setting the Timer	17
Using the 1-Hour OFF Timer.....	19
Adjusting the Airflow Direction	20
Operation without the Remote Control Unit.....	20
Care and Cleaning.....	21
Troubleshooting.....	23
Tips for Energy Saving.....	23
Operating Range	23

Product Information

If you have problems or questions concerning your Air Conditioner, you will need the following information. Model and serial numbers are on the nameplate on the bottom of the cabinet.

Model No. _____ Serial No. _____

Date of purchase _____

Dealer's address _____

Phone number _____

Alert Symbols

The following symbols used in this manual, alert you to potentially dangerous conditions to users, service personnel or the appliance:



WARNING

This symbol refers to a hazard or unsafe practice which can result in severe personal injury or death.



CAUTION

This symbol refers to a hazard or unsafe practice which can result in personal injury or product or property damage.

Installation Location

- We recommend that this air conditioner be installed properly by qualified installation technicians in accordance with the Installation Instructions provided with the unit.
- Before installation, check that the voltage of the electric supply in your home or office is the same as the voltage shown on the nameplate.



WARNING

- Do not install this air conditioner where there are fumes or flammable gases, or in an extremely humid space such as a greenhouse.
- Do not install the air conditioner where excessively high heat-generating objects are placed.

Avoid:

- To protect the air conditioner from heavy corrosion, avoid installing the outdoor unit where salty sea water can splash directly onto it or in sulphurous air near a spa.
- The unit may malfunction when the receiver in the indoor unit is exposed to the inverter lamp light.

Electrical Requirements

1. All wiring must conform to the local electrical codes. Consult your dealer or a qualified electrician for details.
 2. Each unit must be properly grounded with a ground (or earth) wire or through the supply wiring.
 3. Wiring must be done by a qualified electrician.
- Power supply: 60 Hz, single-phase, 230/208 volts.



CAUTION

To warm up the system, the power mains must be turned on at least five (5) hours before operation. Leave the power mains ON unless you will not be using this appliance for an extended period. (CL MODEL)

Power mains

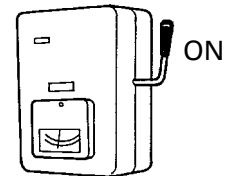

Safety Instructions

- Read this Instruction Manual carefully before using this air conditioner. If you still have any difficulties or problems, consult your dealer for help.
- This air conditioner is designed to give you comfortable room conditions. Use this only for its intended purpose as described in this Instruction Manual.



WARNING

- Never touch the unit with wet hands.
- Never use or store gasoline or other flammable vapor or liquid near the air conditioner — it is very dangerous.
- This air conditioner has no ventilator for intaking fresh air from outdoors. You must open doors or windows frequently when you use gas or oil heating appliances in the same room, which consume a lot of oxygen from the air. Otherwise there is a risk of suffocation in an extreme case.



CAUTION

- Do not turn the air conditioner on and off from the power mains switch. Use the ON/OFF operation button.
- Do not stick anything into the air outlet of the outdoor unit. This is dangerous because the fan is rotating at high speed.
- Do not let children play with the air conditioner.
- Do not cool the room too much if babies or invalids are present.

Names of Parts

Each air conditioner as shown below consists of an indoor unit and an outdoor unit. You can control the air conditioner with the remote control unit.

Ceiling mounted type

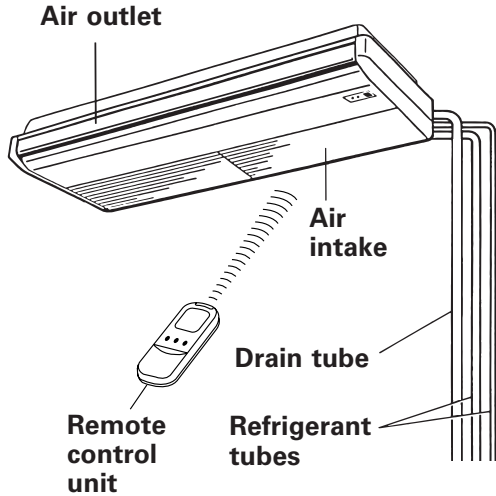

Recessed type

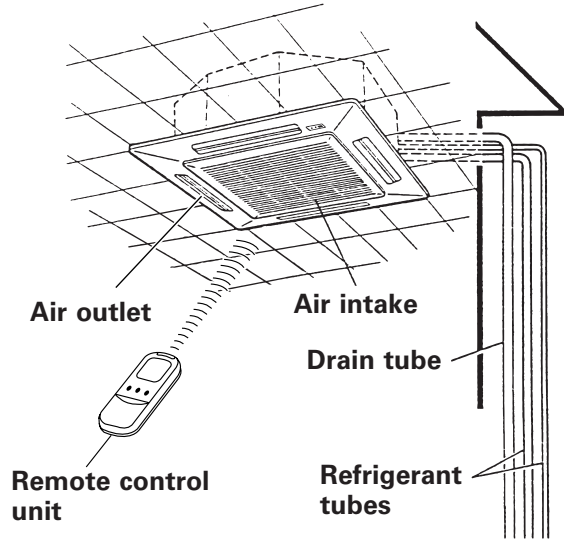

Wall mounted type

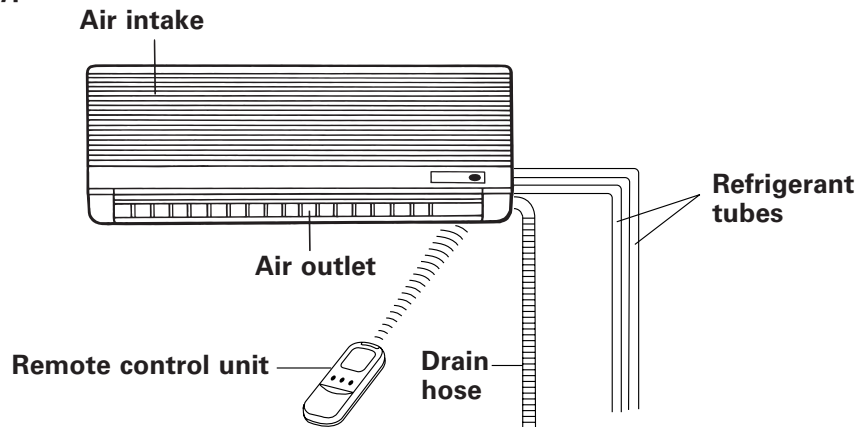

NOTE

This illustration is based on the external view of a standard model. Consequently, the shape may differ from that of the air conditioner which you have selected.

Air intake	The return air in the room is drawn into this section and passes through air filters which remove dust and foreign particles.
Air outlet	Conditioned air is returned to the room through the air outlet (ceiling and wall mounted type) or four air outlets (Recessed type). The direction of airflow can be adjusted as desired using the remote control unit.
Remote control unit	The wireless remote control unit controls power ON/OFF, operation mode selection, temperature, fan speed, timer setting, and air sweeping.
Refrigerant tubes	The indoor and outdoor units are connected by copper tubes through which refrigerant gas flows.
Drain tube	Moisture in the room is condensed and drains off by means of this tube.
Outdoor (condensing) unit	The outdoor unit contains the compressor, fan motor, heat exchanger coil, and other electrical components.

Unit Display and Operation Selector

Recessed type

Ceiling mounted type

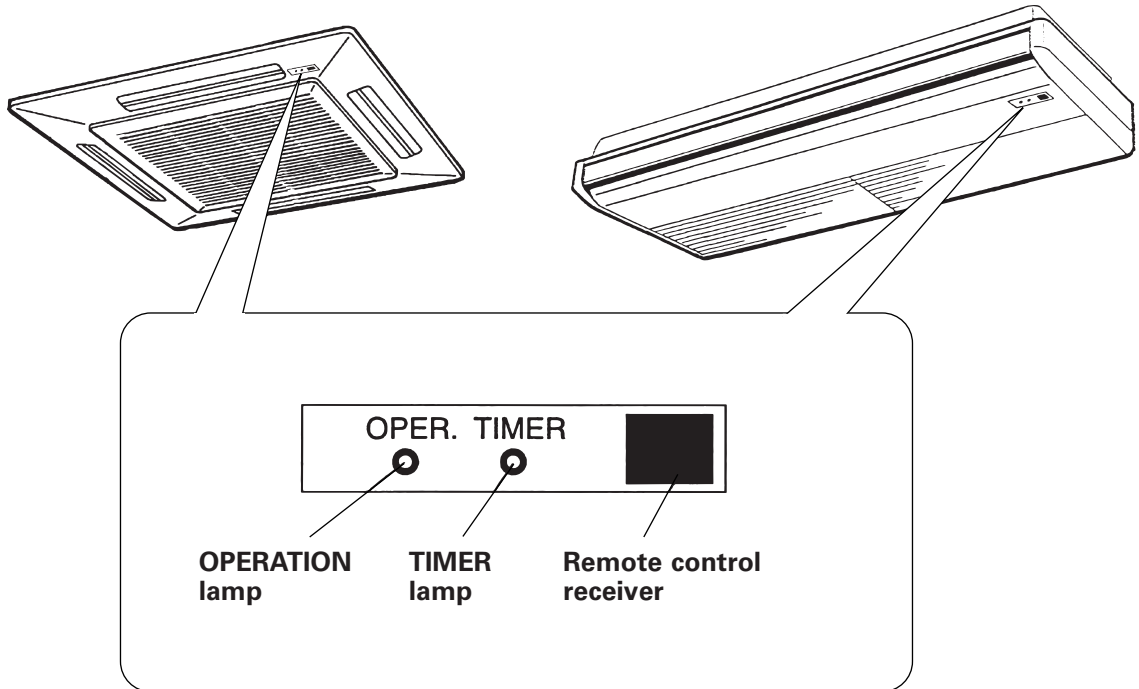

Recessed type

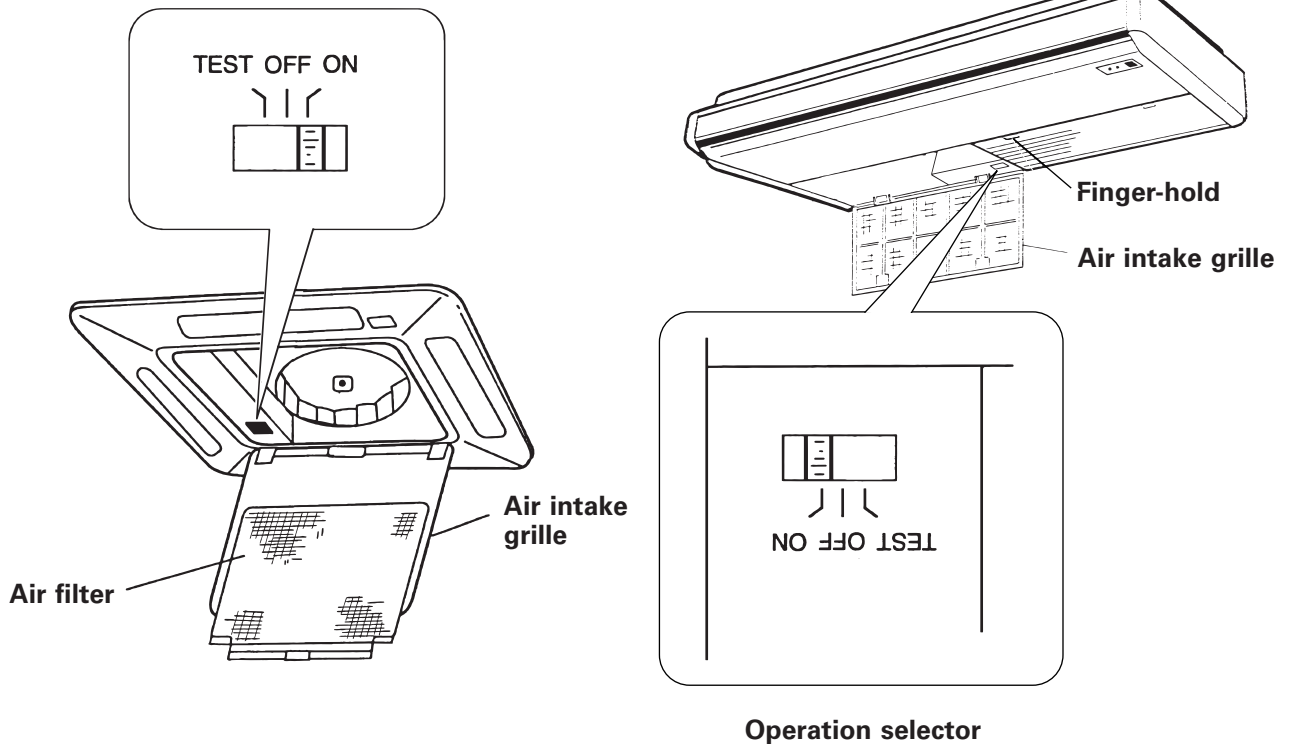

Ceiling mounted type

Operation selector

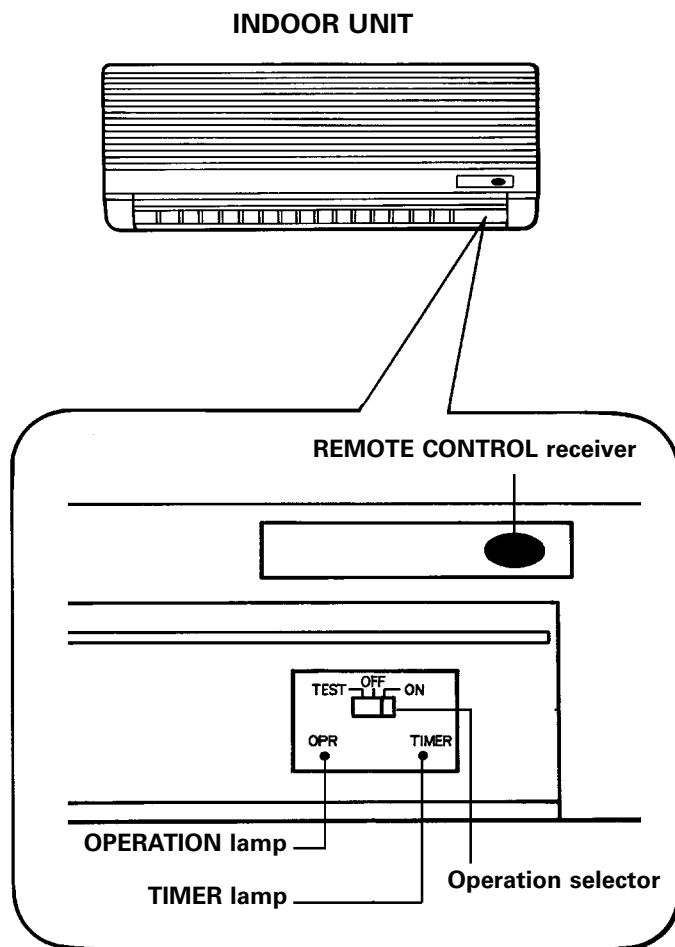

Unit Display and Operation Selector (continued)



<p>REMOTE CONTROL receiver</p>	<p>This section picks up infrared signals from the remote control unit (transmitter).</p>
<p>Operation selector ON position</p>	<p>This position is for operating the air conditioner with the wireless remote control unit. Set the selector normally in this position.</p>
<p>OFF position</p> <p> WARNING</p>	<p>Switch the selector to the OFF position if you are not going to use the air conditioner for a few days or longer.</p> <p>The OFF position does not disconnect the power. Use the main power switch to turn off power completely.</p>
<p>TEST position</p> <p> CAUTION</p>	<p>This position is used only when servicing the air conditioner.</p> <p>Do not set at the TEST position for normal operation.</p>
<p>OPERATION lamp</p>	<p>This lights when the system is in the continuous COOL or FAN mode.</p>
<p>TIMER lamp</p>	<p>This lamp lights when the system is being controlled by the timer.</p>

Remote Control Unit (Display)

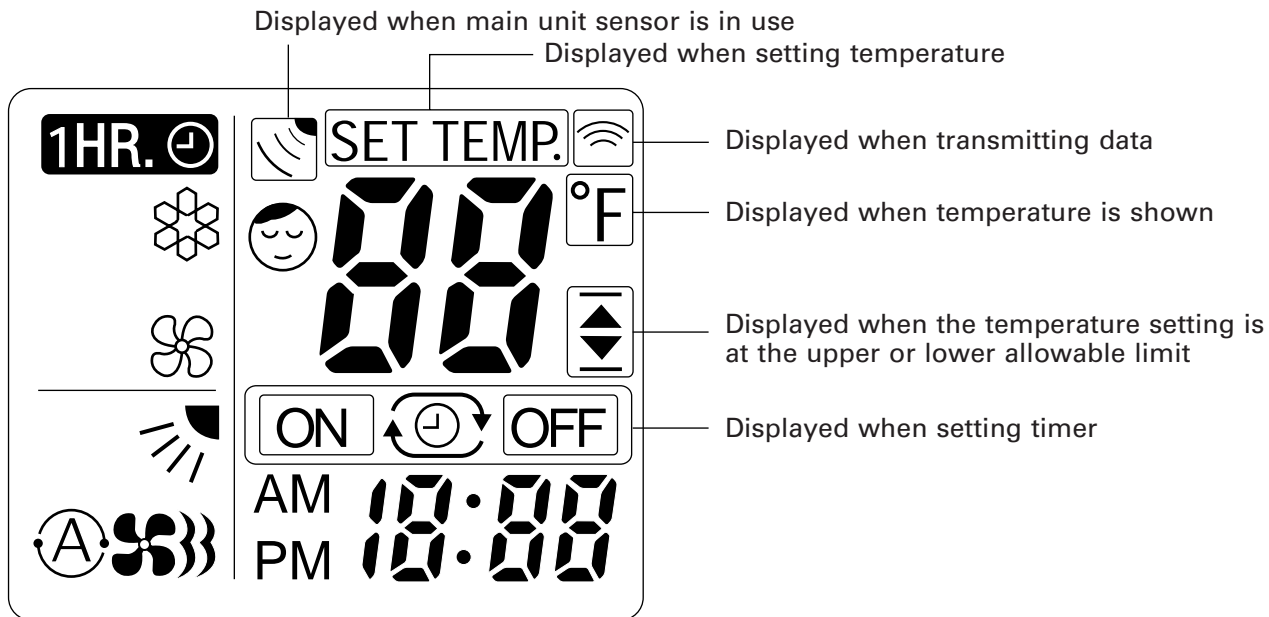

Symbols

(1) Operation mode

COOL

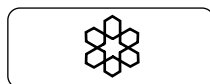

FAN

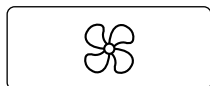

(2) Fan speed

Automatic operation



HIGH



MEDIUM



LOW

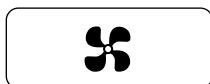

(3) Set temperature

60 – 88 °F

When set to 82 °F

Current temperature

indication



(4) Timer

24-hour clock with ON/OFF

Program Timer

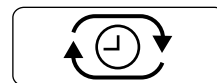

24-hour ON Timer



24-hour OFF Timer



1-hour OFF Timer



(5) NIGHT SETBACK



(6) Confirmation of transmission



(7) Sweep indication





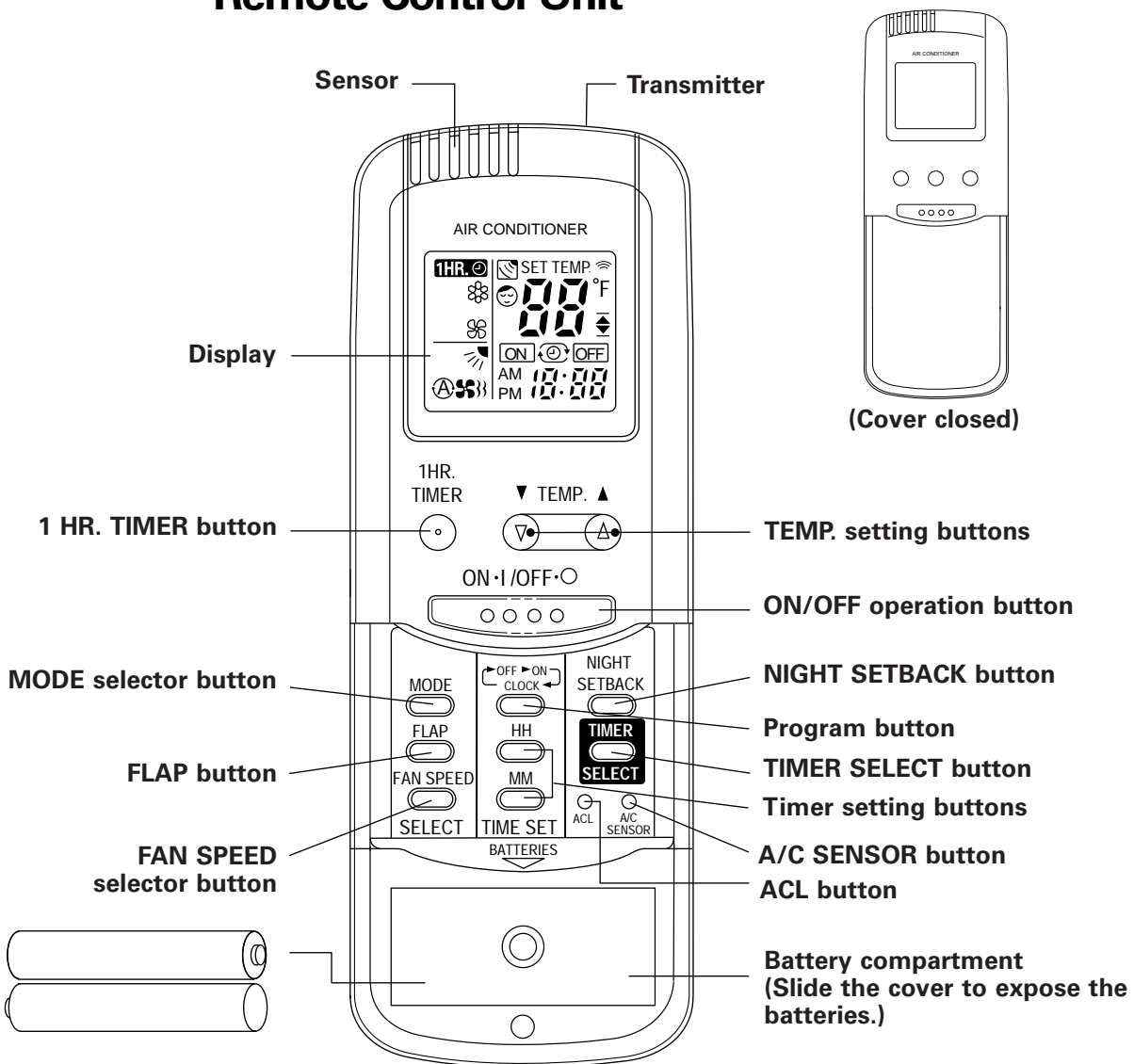

Remote Control Unit















NOTE



The illustration above pictures the remote control unit after the cover has been lowered and removed.

Transmitter	When you press the buttons on the remote control unit, the  mark appears in the display to transmit the setting changes to the receiver in the air conditioner.
Sensor	A temperature sensor inside the remote control unit senses the room temperature.
Display	Information on the operating conditions is displayed while the remote control unit is switched on. If the unit is turned off, only the mode that was set previously is still displayed.
NIGHT SETBACK button	For details, see "Night Setback Mode". When you press this button in the COOL mode, the  mark appears in the display, and the remote control unit will automatically adjust the set temperature to save energy.
TEMP. setting buttons	Press the  button to increase the set temperature. Press the  button to reduce the set temperature.
ON/OFF operation button	This button is for turning the air conditioner on and off.
Timer setting buttons	First, press the PROGRAM button to select the mode you want. Each time you press the "HH" button, the hours advance by one. Each time you press the "MM" button, the minutes advance by one.

Remote Control Unit (continued)

PROGRAM button	For details, see "Setting the Timer". Press this button to select the mode you want to program.
TIMER SELECT button	No display : The timer does not operate.  : The air conditioner stops at the set time.  : The air conditioner starts at the set time.  : The air conditioner stops and starts, or starts and stops, at the set times every day.
MODE selector button (COOL) (FAN)	Use this button to select COOL or FAN mode  : The air conditioner makes the room cooler.  : The air conditioner works only as a circulation fan.
FLAP button	Press this button to select the sweep function, which moves the flap up and down automatically.  : The flap moves up and down automatically.
FAN SPEED selector button	 : The air conditioner automatically decides the fan speeds.  : High fan speed  : Medium fan speed  : Low fan speed
1 HR. TIMER button (1-HOUR OFF TIMER)	 : When you press this button, regardless of whether the unit is operating or stopping, the unit operates for one hour and then shuts down.
ACL button (ALL CLEAR)	Puts the remote control unit into pre-operation status. Always press this button after replacing the batteries.
A/C SENSOR button	When you press this button (use a small-tipped object such as a ballpoint pen), the  mark will appear at the display. And the room temperature is detected by the sensor which is built into the indoor unit and the air conditioner is controlled accordingly.
NOTE	If the remote control is located near a heat source, such as a space heater or in direct sunlight, press the A/C SENSOR button to switch to the sensor on the indoor unit.

NOTE

- The remote control unit sends the temperature signal to the air conditioner regularly at three minute intervals. If the signal from the remote control unit stops for more than ten minutes due to the loss of the remote control unit or other trouble, the air conditioner will switch to the temperature sensor which is built into the indoor unit and control the room temperature. In these cases, the temperature around the remote control unit may differ from the temperature detected at the air conditioner's position.
- **Operation when the outdoor temperature is low**
If an indoor unit connected to a "CL-" type outdoor unit is operating in the cooling mode during the winter months when the outdoor temperature is low, setting the FAN SPEED selector to  (low fan speed) can result in intermittent operation to prevent freezing. In such cases, use the  (high fan speed) or  (medium fan speed) setting instead.

Using the Remote Control Unit

How to Install Batteries

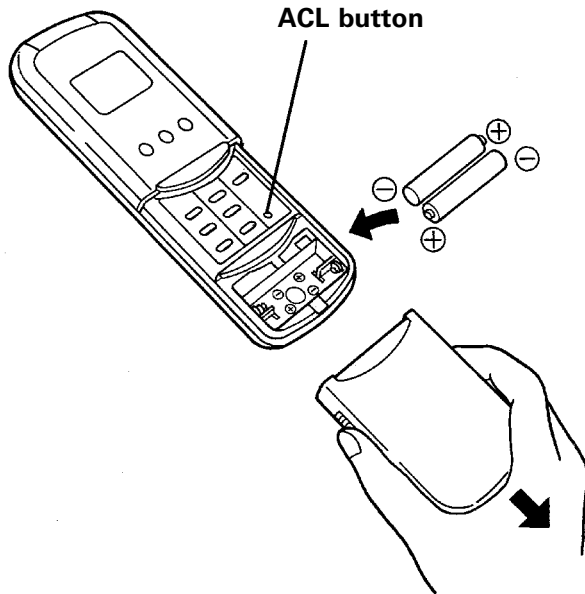

1. Slide the cover in the direction indicated by the arrow and remove it.
2. Install two AAA alkaline batteries. Make sure the batteries point in the direction marked in the battery compartment.
3. Use a thin object such as the tip of a pen to press the ACL button.

NOTE

- The batteries last about six months, depending on how much you use the remote control unit. Replace the batteries when the remote control unit's display fails to light, or when the remote control cannot be used to change the air conditioner's settings.
- Use two fresh leak-proof type-AAA alkaline batteries.
- In replacing batteries, follow the instructions as mentioned in the sub-section "How to Install Batteries".
- If you do not use the remote control unit more than 1 month, take out the batteries.

How to Use the Remote Control Unit

When using the remote control unit, always point the unit's transmitter head directly at the air conditioner's receiver.

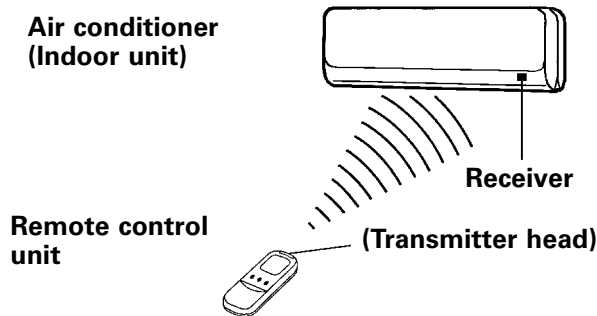

Remote Control Unit Installation Position

The remote control unit may be operated either from a non-fixed position or from a wall-mounted position. To ensure that the air conditioner operates correctly, DO NOT install the remote control unit in the following places:

DO NOT

- In direct sunlight
- Behind a curtain or other places where it is covered
- More than 26 ft. away from the air conditioner
- In the path of the air conditioner's airstream
- Where it may become extremely hot or cold
- Where it may be subject to electrical or magnetic noise
- Where there is an obstacle between the remote control unit and air conditioner (since a check signal is sent from the remote control unit every 3 minutes)

Using the Remote Control Unit (continued)

Mounting the Remote Control Unit

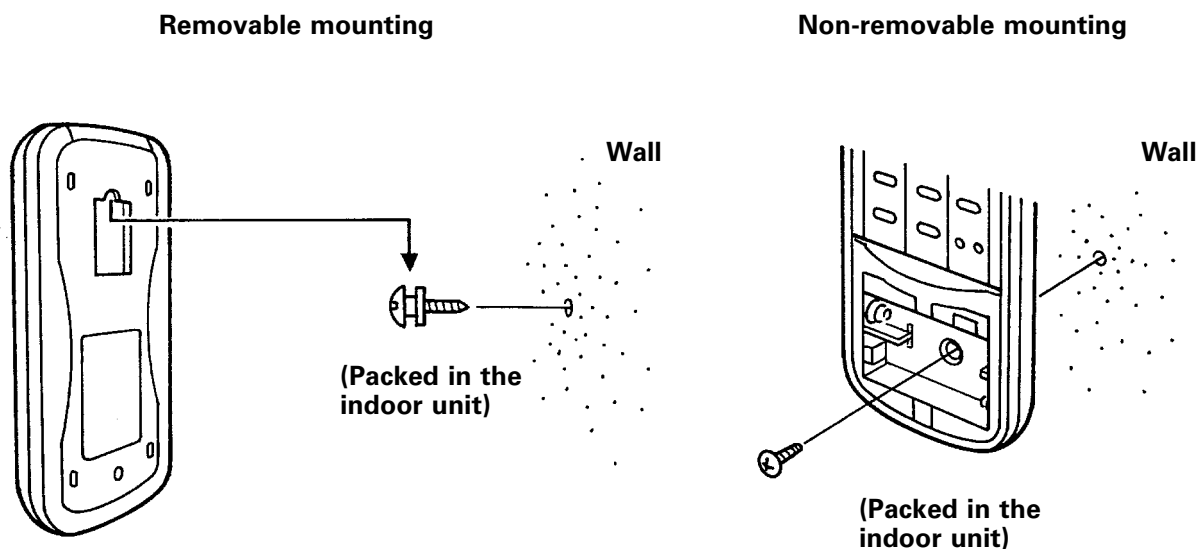

Mounting on a wall

A. Removable mounting

- 1) Momentarily hold the remote control unit at the desired mounting position.
- 2) Confirm that the air conditioner responds correctly when you press keys on the remote control from that position.
- 3) After confirming correct operation, use a screwdriver to screw the mounting screw into the wall.
- 4) Hang the remote control unit from the mounting screw.

B. Non-removable mounting

- 1) Momentarily hold the remote control unit at the desired mounting position.
- 2) Confirm that the air conditioner responds correctly when you press keys on the remote control from that position.
- 3) After confirming correct operation, use a screwdriver to screw the mounting screw into the wall.
- 4) Remove the batteries of the remote control unit.
- 5) Use a screwdriver to screw the remote control unit securing screw into the wall through the hole in the battery compartment.
- 6) Replace the batteries.
- 7) Again confirm that the remote control unit operates correctly.

Operation with the Remote Control Unit

1. Operation

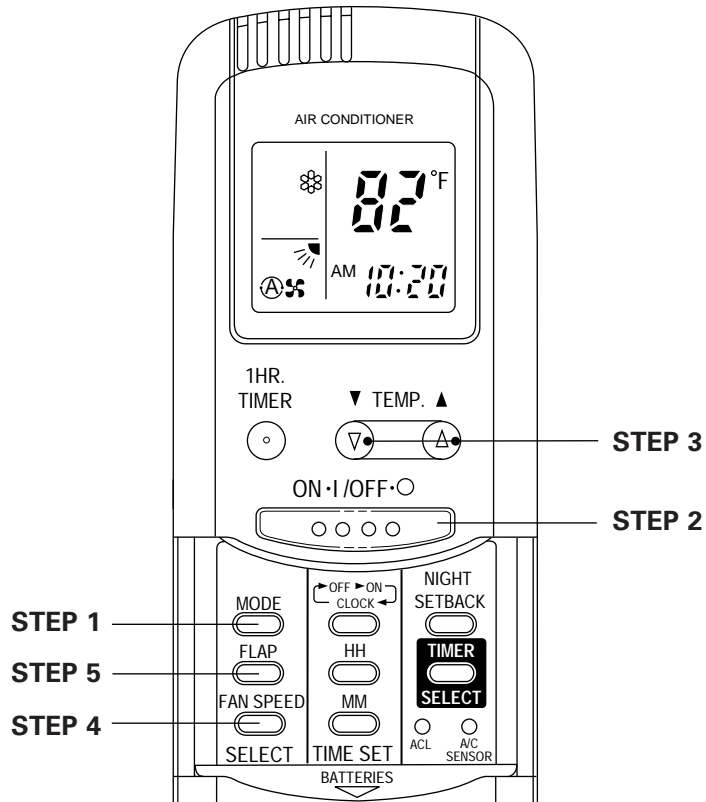

NOTE

Check that the circuit breaker on the power panel is turned on and that the operation selector of the indoor unit is in the ON position.

Press the setting buttons as described below and change the settings as desired.

STEP 1	Set the MODE selector button to COOL. For cooling operation → ☼
STEP 2	To start the air conditioner, press the ON/OFF operation button.
STEP 3	Press the TEMP. setting buttons to change the temperature setting to the desired temperature. Adjustable temperature range: 88 °F max. 60 °F min.
STEP 4	Set the FAN SPEED selector button to the setting you want.
NOTE	If the fan speed is set to Ⓜ (Automatic), the fan speed switches automatically, according to the difference between the actual room temperature and the temperature setting.
STEP 5	Press the FLAP button and set the airflow direction as desired. (Refer to “Adjusting the Airflow Direction” on page 20.)

To stop the air conditioner, press the ON/OFF operation button again.

Operation with the Remote Control Unit (continued)

NOTE

- Choose the best position in the room for the remote control unit, which also acts as the sensor for room comfort and transmits the operating instructions. Once you've found this best position, always keep the remote control unit there.
- This appliance has a built-in 3-minute time delay circuit to ensure reliable operation. When the operation button is pressed, the compressor will start running within three minutes. In the event of power failure, the unit will stop. When the power is restored, the unit will restart automatically after three minutes.

2. Adjusting the Fan Speed

A. Automatic

Simply set the FAN SPEED selector to the  position.

A microcomputer in the air conditioner automatically controls the fan speed when the  mode is selected. When the air conditioner starts operating, the difference between the room temperature and the set temperature is detected by the microcomputer which then automatically switches the fan speed to the most suitable level.



Cooling mode:

When difference between room temperature and set temperature is	FAN SPEED
4 °F and over	High
Between 4 °F and 2 °F	Medium
Below 2 °F	Low

NOTE

The above table assumes that the sensor on the remote control is being used. If the sensor on the indoor unit is being used (the  indicator is on), actual operation may differ slightly from the operation described in the table.
(Refer to "A/C SENSOR button" on page 10.)

B. Manual

If you want to adjust fan speed manually during operation, just set the FAN SPEED selector as desired. [ ,  , or ]

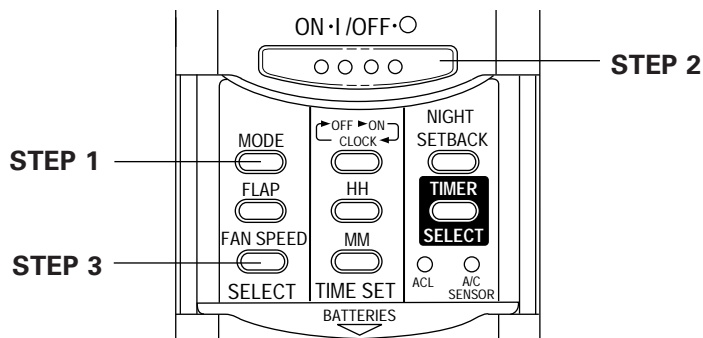

3. Fan Only



If you want to circulate air without any temperature control, follow these steps:

STEP 1: Press the MODE selector button to switch to the fan mode.
()

STEP 2: Press the ON/OFF button.

STEP 3: Press the FAN SPEED button to select the fan speed of your choice ( ,  , or ).

Operation with the Remote Control Unit (continued)

4. Night Setback Mode

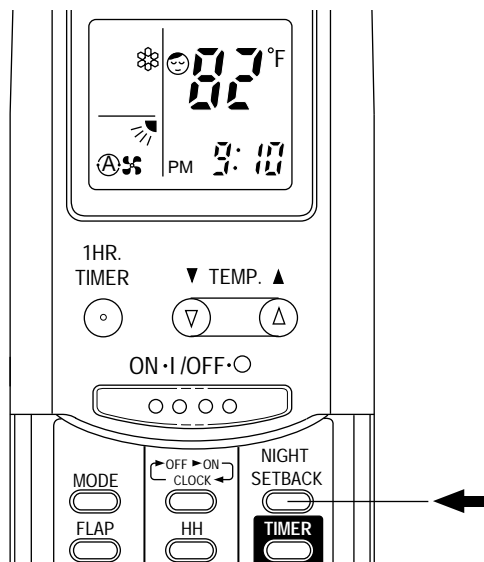

Night Setback Mode is used for saving energy.

Press the NIGHT SETBACK button while operation.
The ☺ mark appears in the display.

To release the night setback function, press the NIGHT SETBACK button again.

NOTE

The night setback mode cannot be used during automatic operation.

In Cooling Mode:
(※)

When the night setback mode is selected, the air conditioner automatically raises the temperature setting 2 °F when 30 minutes have passed after the selection was made, and then another 2 °F after another 30 minutes have passed, regardless of the indoor temperature when night setback was selected. This enables you to save energy without sacrificing comfort. This function is convenient when gentle cooling is needed.

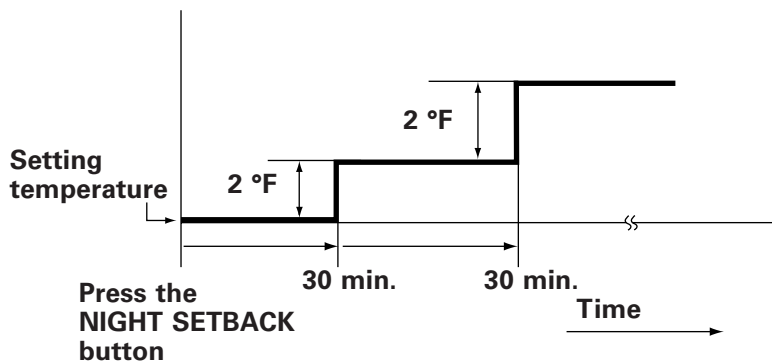

Special Remarks

**Power failure
during operation**

- In the event of power failure, the unit will stop. When the power is resumed, the unit will restart automatically after three minutes.

Remote Control Unit

- The remote control unit sends the setting condition to the air conditioner regularly at three minute intervals.

Setting the Timer

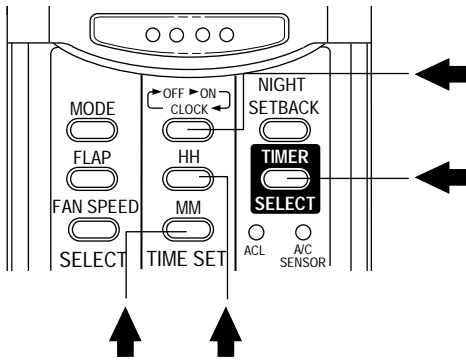

1. How to set the present time

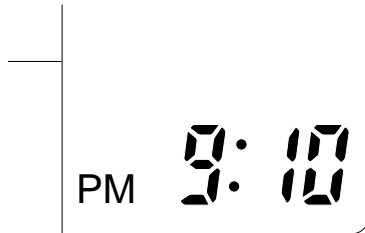

(Example) To set to 9:10 p.m.

Operation	Indication
1. Press the Program button () three times.	The time indication alone flashes.
2. <ul style="list-style-type: none"> • Press the HH button until PM 9 is displayed. • Press the MM button until 10 is displayed. 	The display will automatically stop flashing except for the ":" symbol after 10 sec.

2. How to set the OFF time



(Example) When air conditioner is running, turning it off at 11:30 p.m.

1. Press the Program button () once.	The timer and time indications flash.
2. <ul style="list-style-type: none"> • Press the HH button until PM 11 is displayed. • Press the MM button until 30 is displayed. 	The display will change automatically back to show the present time after 10 sec.
3. Press the TIMER SELECT button once to set OFF time.	The present time and are displayed.

Setting the Timer (continued)

3. How to set the ON time

(Example) When air conditioner is off, starting operation at 7:10 a.m.

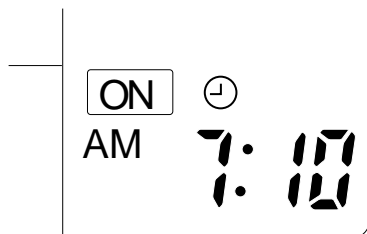

Operation	Indication
1. Press the Program button () twice.	The timer ON and time indications flash.
2. <ul style="list-style-type: none"> Press the HH button until AM 7 is displayed. Press the MM button until 10 is displayed. 	The display will change automatically back to show the present time after 10 sec.
3. Press the TIMER SELECT button three times to set ON time.	The present time and are displayed.
4. Press the ON/OFF button to start the air conditioner.	The present time is displayed.

4. How to set a program for daily ON/OFF operation

(Example) When air conditioner is running, starting operation at 7:10 a.m. and turning it off at 11:30 p.m.

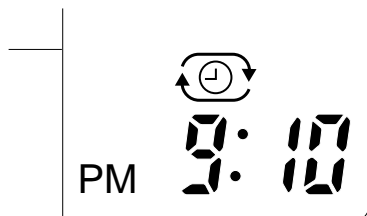

1. Set the timer ON/OFF times as shown in 3.	
2. Press the TIMER SELECT button twice to set the ON/OFF combination timer.	is displayed.

NOTE

You can check the timer ON/OFF times after you have set them by pressing the Program button ().

Using the 1-Hour OFF Timer

1. 1-Hour OFF Timer

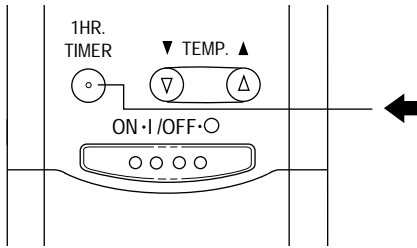

This function causes the unit to operate for one hour and then stop, regardless of whether the unit is on or off when this button is pressed. The **1HR. ⌚** indicator in the display indicates that this function is operating.

Setting procedure:

Regardless of whether the unit is operating or stopped, press the 1 HR. TIMER button.

1HR. ⌚ appears in the display.

Cancellation procedure:

Press the ON/OFF operation button to turn the unit off, wait for the unit to stop operating, and then press the ON/OFF operation button again. The 1-Hour Timer function is now cancelled and the unit operates normally.

NOTE

- If, while the 1-Hour Timer function is operating, the 1 HR. TIMER button is pressed once to cancel the function and then again, the unit continues to operate for one hour from that point in time and then stops.

2. Operation Together with the Program Timer

- The Program Timer and 1-Hour OFF Timer may be used together.
- It is not possible to use the OFF Timer and 1-Hour OFF Timer together. Whichever function is set last takes precedence. If the 1 HR. TIMER button is pressed while the TIMER OFF function operates, the OFF Timer is cancelled and the unit will stop operating one hour later.

Adjusting the Airflow Direction

A. Horizontal (Wall mounted type only)

The horizontal airflow can be adjusted by moving the vertical vane to the left or right.

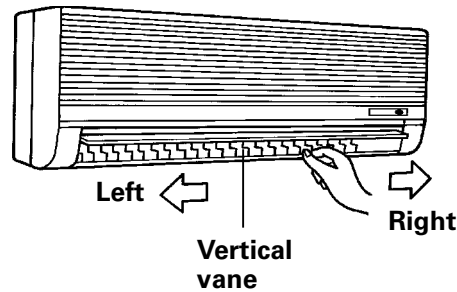
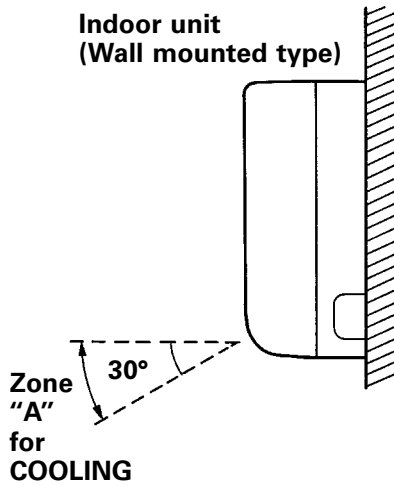

B. Vertical

Confirm that the remote control unit has been turned on. Press the FLAP button to start the flap moving up and down (). If you want to stop the flap movement and to direct the air in the desired direction, press the FLAP button again. In the COOL mode, don't direct the flap down more than 30° (KS, TS Types), or leave it in the vertical position (XS Type), otherwise condensation may drip onto the floor. Zone "A" (KS, TS Type) and any position other than vertical (XS Type) are the recommended flap positions for cooling.



CAUTION

Do not move the flap with your hands.

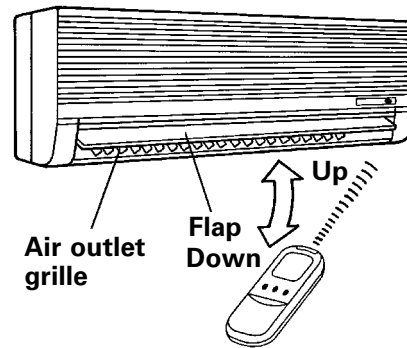
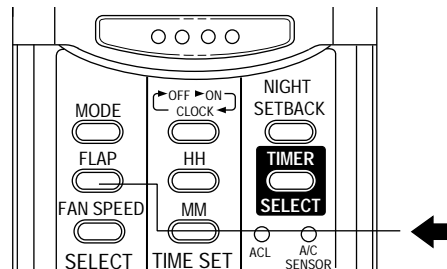

Operation without the Remote Control Unit

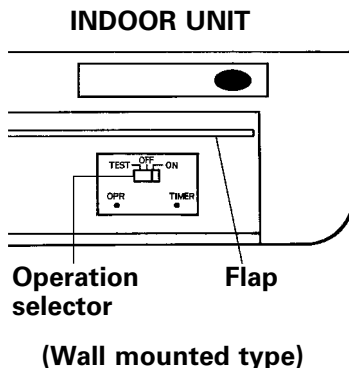

If you have lost the remote control unit or it has trouble, follow the steps below.

1. When the air conditioner is stopped.
If you want to turn on the air conditioner, switch the operation selector to the OFF position, and then to the ON position.

NOTE

The set temperature and fan speed are automatically set at the last selection before stopping.

2. When the air conditioner is running.
If you want to turn off the air conditioner, switch the operation selector to the OFF position.

Care and Cleaning



WARNING

1. For safety, be sure to turn the air conditioner off and also to disconnect the power before cleaning.
2. Do not pour water or spray detergent on the indoor unit to clean it. This will damage the internal components and may cause an electric shock or fire.

Air Intake and outlet side (Indoor Unit)

Clean the air intake and outlet side of the indoor unit with a vacuum cleaner brush, or wipe them with a clean soft cloth.

If these parts are stained, use a clean cloth moistened with a mild liquid detergent. When cleaning the air outlet side, be careful not to force the vanes out of place.



CAUTION

1. Never use solvents or harsh chemicals when cleaning the indoor unit. Do not wipe plastic parts using very hot water.
2. Some metal edges and the fins are sharp and may cause injury if handled improperly; be especially careful when you clean these parts.
3. The internal coil and other components of the outdoor unit must be cleaned every year. Consult your dealer or service center.

Air filter

The air filter collects dust and other particles from the air and should be cleaned about once every six months (Recessed type) or two weeks (ceiling mounted type and wall mounted type). If the filter gets blocked, the efficiency of the air conditioner drops greatly.

NOTE

The frequency with which the filter should be cleaned depends on the environment in which the unit is used.

How to remove the filter

Recessed type:

1. Remove the bolt screw on each side out of the latch using a screwdriver. (After cleaning, be sure to reattach the two bolt screws.)
2. Press on the two latches of the air intake grille with your thumbs in the direction of the arrow to open the grille.
3. Open the air intake grille downward.



CAUTION

When cleaning the air filter, never remove the safety string. If it is necessary to remove it for servicing and maintenance inside, be sure to reinstall the safety string securely (hook on the grille side) after the work.

4. Remove the air filter attached to the air intake grille.

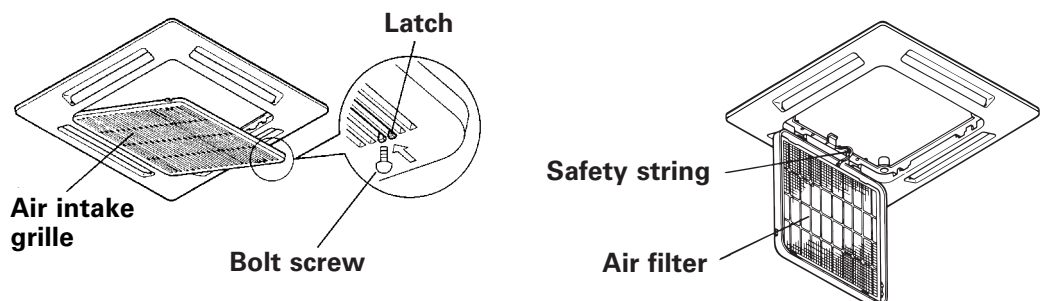

Care and Cleaning (continued)

How to remove the filter

Ceiling mounted type:

1. Remove the bolt screws on the latch using a screwdriver. (After cleaning, be sure to reattach the two bolt screws.)
2. Take hold of two latches on the air intake grille and press it to the rear, and the grille will open downward.
3. Take hold of the finger-hold on the air filter, first lift it and then pull it toward you to release it from the catch.

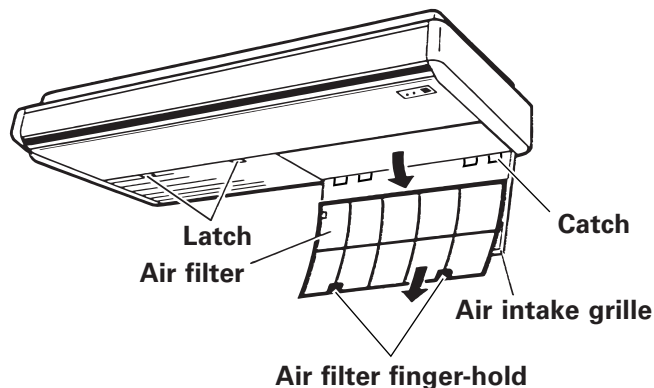

How to remove the filter

Wall type

1. Move the flap on the air outlet grille to its lowest position.
2. Hold the air filter by the tab at the bottom, and pull downward.

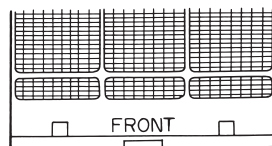
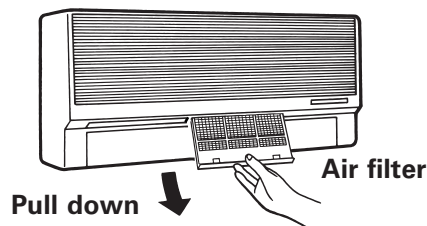

How to clean the filter

Use a vacuum cleaner to remove light dust. If there is sticky dust on the filter, wash the filter in lukewarm, soapy water, rinse it in clean water, and dry it.

Outdoor Unit



CAUTION

1. Certain metal edges and the condenser fins are sharp and may cause injury if handled improperly; special care should be taken when you clean these parts.
2. Periodically check the outdoor unit to see if the air outlet or air intake is clogged with dirt or soot.
3. The internal coil and other components of the outdoor unit must also be cleaned periodically. Consult your dealer or service center.

Care: After a Prolonged Idle Period

Check the indoor and outdoor unit air intakes and outlets for blockage; if there is a blockage, remove it.

Care: Before a Prolonged Idle Period

- Operate the fan for half a day to dry out the inside.
- Disconnect the power supply and also turn off the breaker.
- Clean the air filter and replace it in its original position.
- Outdoor unit internal components must be checked and cleaned periodically. Contact your local dealer for this service.

Troubleshooting

If your air conditioner does not work properly, first check the following points before requesting service. If it still does not work properly, contact your dealer or service center.

Trouble	Possible Cause	Remedy
Air conditioner does not run at all.	<ol style="list-style-type: none"> 1. Power failure. 2. Leakage breaker tripped. 3. Line voltage is too low. 4. ON/OFF operation button is OFF. 5. Batteries in remote control unit have run down. 	<ol style="list-style-type: none"> 1. Restore power. 2. Contact service center. 3. Consult with electrician or dealer. 4. Press the button again. 5. Replace batteries.
Compressor runs but soon stops.	<ol style="list-style-type: none"> 1. Obstruction in front of condenser coil. 	<ol style="list-style-type: none"> 1. Remove obstruction.
Poor cooling performance.	<ol style="list-style-type: none"> 1. Dirty or clogged air filter. 2. Heat source (cooker, heater, or electrical appliance) or many people in room. 3. Doors and/or windows are open. 4. Obstacle near air intake or air discharge port. 5. Thermostat is set too high. 	<ol style="list-style-type: none"> 1. Clean the air filter to improve the air flow. 2. Eliminate heat source if possible. 3. Shut them to keep the heat out. 4. Remove it to ensure good air flow. 5. Set the temperature lower.

Tips for Energy Saving

- Do not**
- **Block the air intake and outlet of the unit. If either is obstructed, the unit will not work well, and may be damaged.**
 - Let direct sunlight into the room. Use sunshades, blinds or curtains. If the walls and ceiling of the room are warmed by the sun, it will take longer to cool the room.
- Do**
- Always try to keep the air filter clean. (Refer to "Care and Cleaning.") A clogged filter will impair the performance of the unit.
 - To prevent conditioned air from escaping, keep windows, doors and any other openings closed.

NOTE

Should the power fail while the unit is running

If the power supply for this unit is temporarily interrupted the unit will automatically resume operation (once the power is restored) with the same settings that were in effect before the power was interrupted.

Operating Range

The air conditioner is operable within the temperature ranges as listed below:

	Temperature	Indoor air temperature	Outdoor air temperature
COOLING	Max.	95 °F DB/71 °F WB	115 °F DB
	Min.	67 °F DB/57 °F WB	67 °F DB *(0 °F DB)

* Only for CL Models.

**SANYO FISHER COMPANY
A DIVISION OF SANYO NORTH AMERICA CORPORATION
21605 Plummer Street
Chatsworth, CA 91311 U.S.A.**

**In Canada
SANYO Canada Inc.
50 Beth Neilson Drive
Toronto, Ontario,
M4H 1M6, Canada**

Free Manuals Download Website

<http://myh66.com>

<http://usermanuals.us>

<http://www.somanuals.com>

<http://www.4manuals.cc>

<http://www.manual-lib.com>

<http://www.404manual.com>

<http://www.luxmanual.com>

<http://aubethermostatmanual.com>

Golf course search by state

<http://golfingnear.com>

Email search by domain

<http://emailbydomain.com>

Auto manuals search

<http://auto.somanuals.com>

TV manuals search

<http://tv.somanuals.com>