



**DCS & Labeling Worldwide**

# **RFID USER GUIDE**

**(Alien C1 UHF)**



PN 9001147B

**SATO America, Inc.**

**10350A Nations Ford Road  
Charlotte, NC 28273**

**Main Phone: (704) 644.1650**

**Technical Support Hotline: (704) 644.1660**

**Technical Support Fax: (704) 644.1661**

**E-Mail: [satosales@satoamerica.com](mailto:satosales@satoamerica.com)**

**[techsupport@satoamerica.com](mailto:techsupport@satoamerica.com)**

**[www.satoamerica.com](http://www.satoamerica.com)**

## SCOPE

This document is to serve as a guide on how to create RFID data using Label Gallery Plus/ TruePro software. It will include menu selection and all relative command code sequences.

## OVERVIEW

The Alien Technologies RFID Reader and antenna are integrated into printer among the standard components. A data cable connects the main circuit board to the RFID Reader. The Reader is, in turn, connected to the antenna by its own antenna cable. Through software configuration and hardware installation, the printer is then capable of writing and verifying EPC Class-1 RFID tags. Tag location and orientation within the label is critical to the performance of the unit.

All “e” series, plug-in interfaces may be used with the RFID print engine, including Ethernet and 802.11b wireless interfaces.

The following process details the steps involved in writing to the EPC tag:

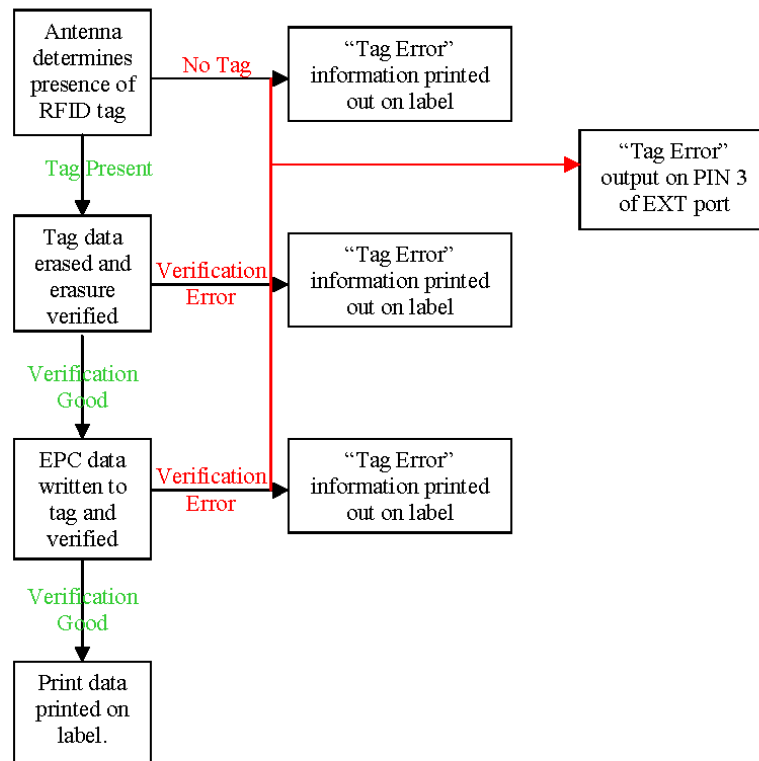

# RFID HARDWARE CONFIGURATION

The RFID hardware kit is comprised of the: RFID Module, RFID Antenna w/coaxial cable, RFID Cable Set. The figure below displays configuration:

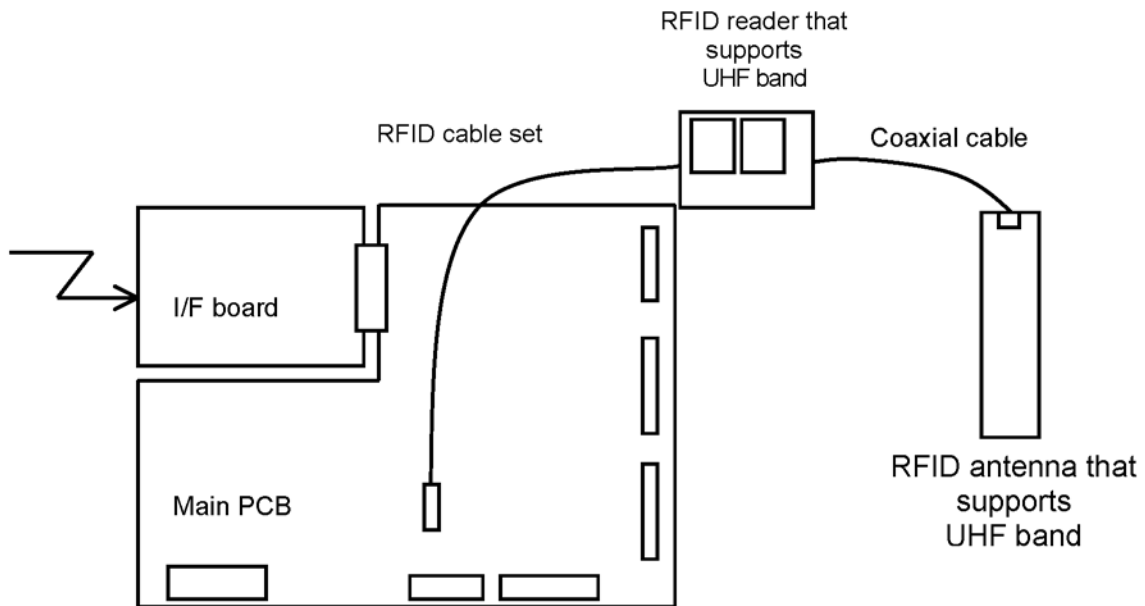

RFID ANTENNA SPECIFICATIONS	
Module	85.47 x 53.98 x 7.62 mm (sealed in a shield case)
Antenna	16 x 118 x 1.6 mm

RFID READER SPECIFICATIONS	
Name	ALR-9930 (module by Alien Technology)
Frequency	902-928 MHz
Communication System	Frequency hopping spectrum dispersion
Transmission Output	Maximum 1W (30 dBm), Uses less than 250mW
Transmission Output Control	14dB and 0.1 dB steps
Communications Protocol	EPC global UHF, Class 1
Source Voltage	5-6 V +/- 3%
Demand Current	Maximum 650 mA
Electrostatic Voltage Resistance	ESD Class 2

## EXT CONNECTOR

The EXT Port pin-out information for the RFID has changed slightly to accommodate the addition of a “tag error” output. The tag error output is available on PIN 3. The “Ribbon Out” output, formerly found at PIN 3, has been combined with the “Label Out” output on PIN 1. PIN 1 will now provide a “Media Out” (ribbon and/or label) error. The PIN 3 signal polarity is the same for “tag Error” as it was for “Ribbon Out” previously.



PIN ASSIGNMENTS		
PIN	DESCRIPTION	DIRECTION
1	Media Out - Pin goes low (0V) when label or ribbon is out.	Output
2	Signal Ground	Reference
3	RFID Tag Error - Pin goes low (0V) when a bad RFID tag is identified and begins to feed from the printer.	Output
4	Printer Error - Pin goes low (0V) when the printer detects an error condition such as head open, receiving buffer full or when the user specified number of RFID errors has been reached.	Output
5	Print Start - The printer will print one label when this pin is pulled to ground.	Input
6	End Print - Used to drive an applicator or other external device requiring synchronization with the print cycle.	Output
7	Reprint - Prints a duplicate of the last label when this signal is received.	Input
8	Reserved.	Input
9	Offline - Pin goes low (0V) when the printer is offline.	Output
10	Ribbon Near End - Pin goes high when the amount of ribbon on the unwind shaft is approximately 46 feet (14 m). The output will be low when the ribbon is gone.	Output
11	Reserved	Output
12	+24 +/- 10% @ 2A - Power for external devices.	Output
13	Vcc - +5V	Output
14	Frame Ground	Reference

NOTE: If backfeed is set to occur “After Print”, the RFID tag will be in the improper location relative to the antenna and the tag will not be programmed.

## RFID SPECIFIC MENU ITEMS

The LCD menu items specific to RFID are located in the Service Mode menu area. To reach the Service Mode menu area, power the printer on while pressing and holding the LINE and FEED keys. Release the keys upon hearing the printer beep. Press the LINE key twice, and then the FEED key to enter the Service Mode menu items.

The following LCD menus are specific to RFID operation:

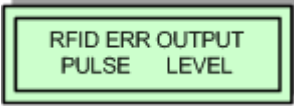
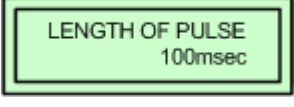
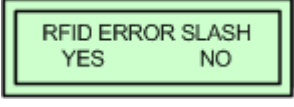
RFID MENUS	
DISPLAY	DESCRIPTION
	<p>Sets the number of times the printer will attempt to re-encode and re-print data following a Tag Error. The printer will enter the error mode when the entered number of retries has been met. The default is 00. The range is 00 to 99.</p>
	<p>Sets the printer response after the “REPRINT CONT” has been reached. When “STOP” is selected, the printer will enter an error state that can be cleared by pressing the LINE key. Selecting “AUTO” will allow the error to be cleared by the next PRINT START signal from the applicator.</p>
	<p>Sets the RFID Tag Error output for either a level signal or a pulse signal. The default is Level.</p>
	<p>When “PULSE” is selected in the previous menu, the length of the pulse can be set through this menu item. The default is 100ms. The range is 100 to 500 ms increments.</p>
	<p>Selecting “YES” prints the message “RFID TAG ERROR” and a diagonal slash through the label. For the slash to print to the size of the label, the Media Size command (&lt;ESC&gt;A1) must be included in the data stream. Selecting “NO” prints only the message “RFID TAG ERROR” at the top of the label. The default is YES.</p>

# LABEL GALLERY

Open Label Gallery Plus. The following main menu screen will appear.

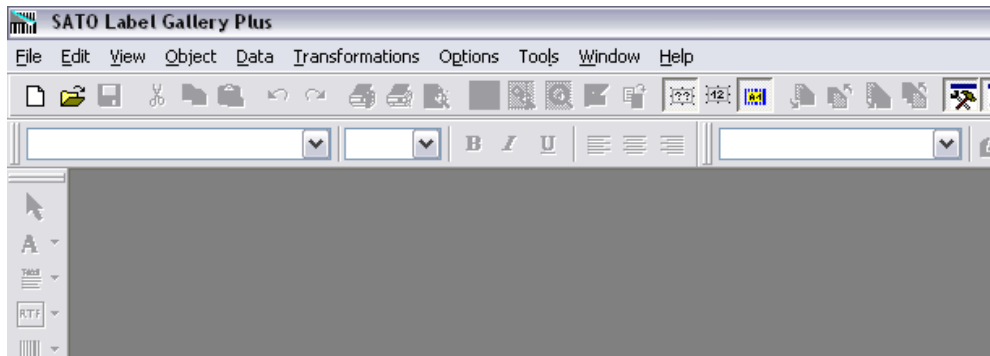

Click on FILE of the upper task bar and then click on NEW from the menu options. The Label Setup Wizard screen for Select Printer will display as shown below.

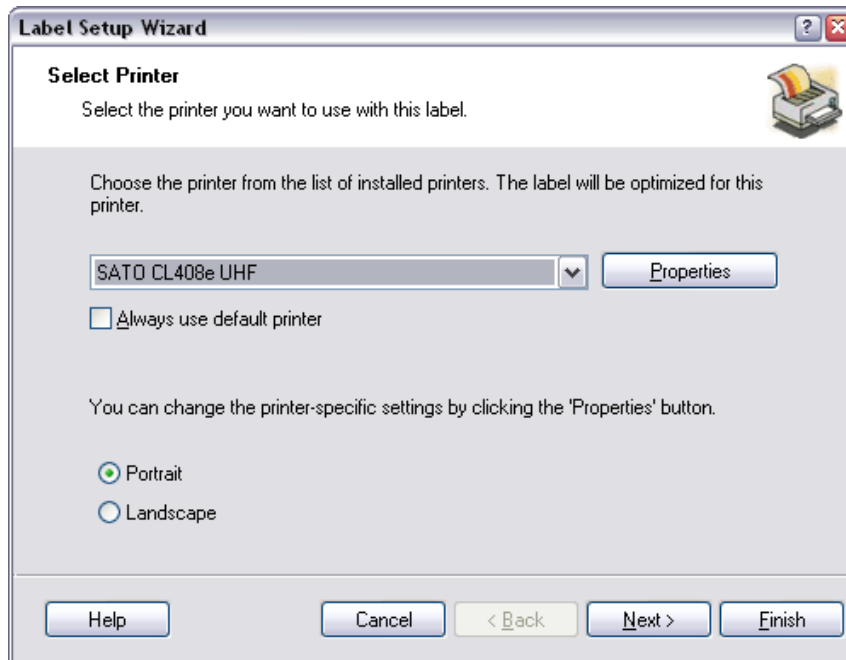

Click on the menu scroll-down arrow and select the RFID printer driver relative to the printer of use. Make other screen selections as deemed necessary and then click on the NEXT button until the Label Dimensions screen appears. The Label Dimensions screen is shown below.

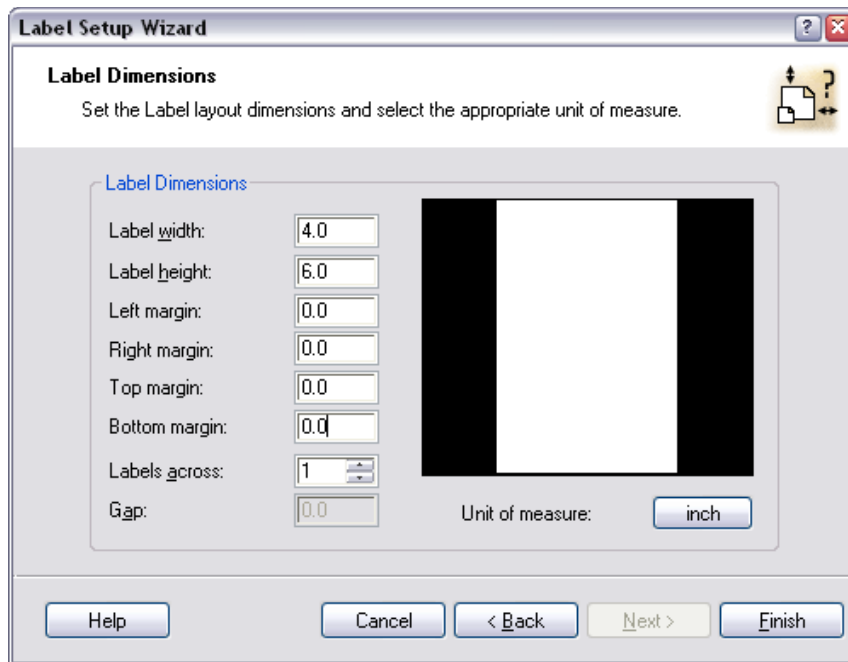

Move the mouse cursor to each Label Dimension field and enter the required dimensions to properly format for the print job at hand. Click on the FINISH button when complete and the following Label Gallery screen will appear with a blank label present.

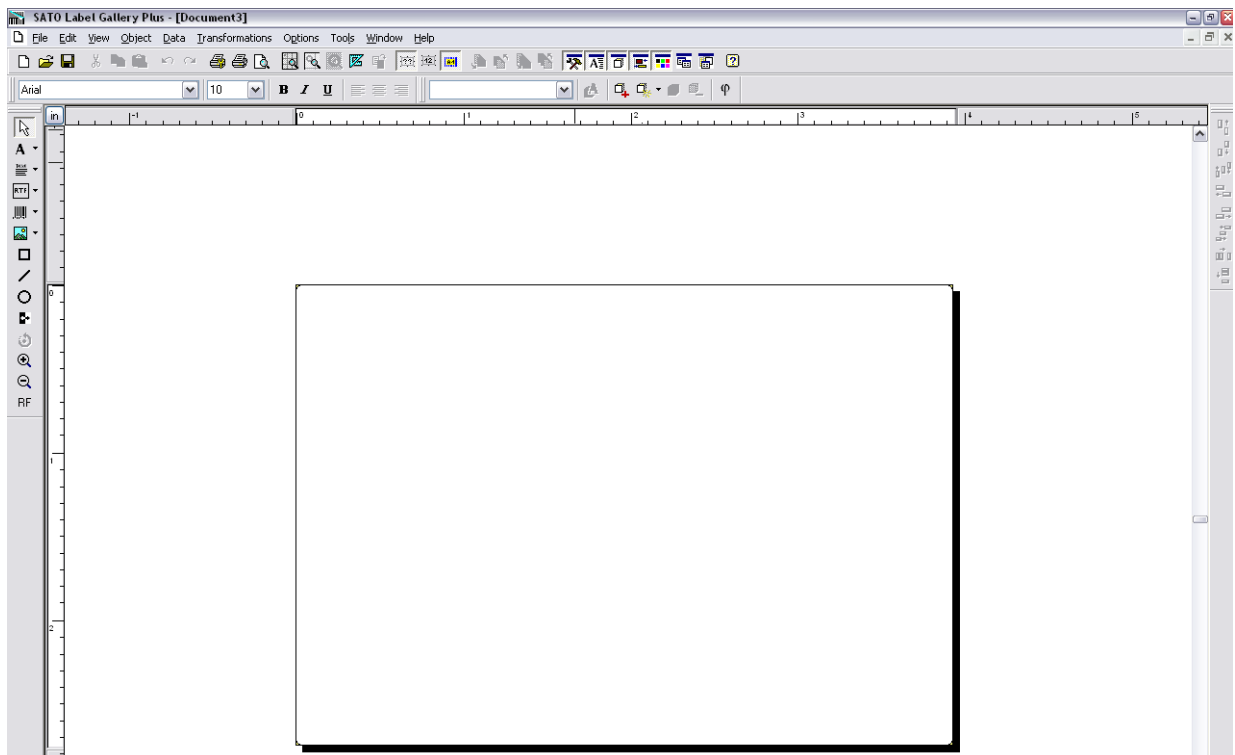

Click on DATA of the upper task bar and then select the RF DATA option. The following RF TAG screen will appear.



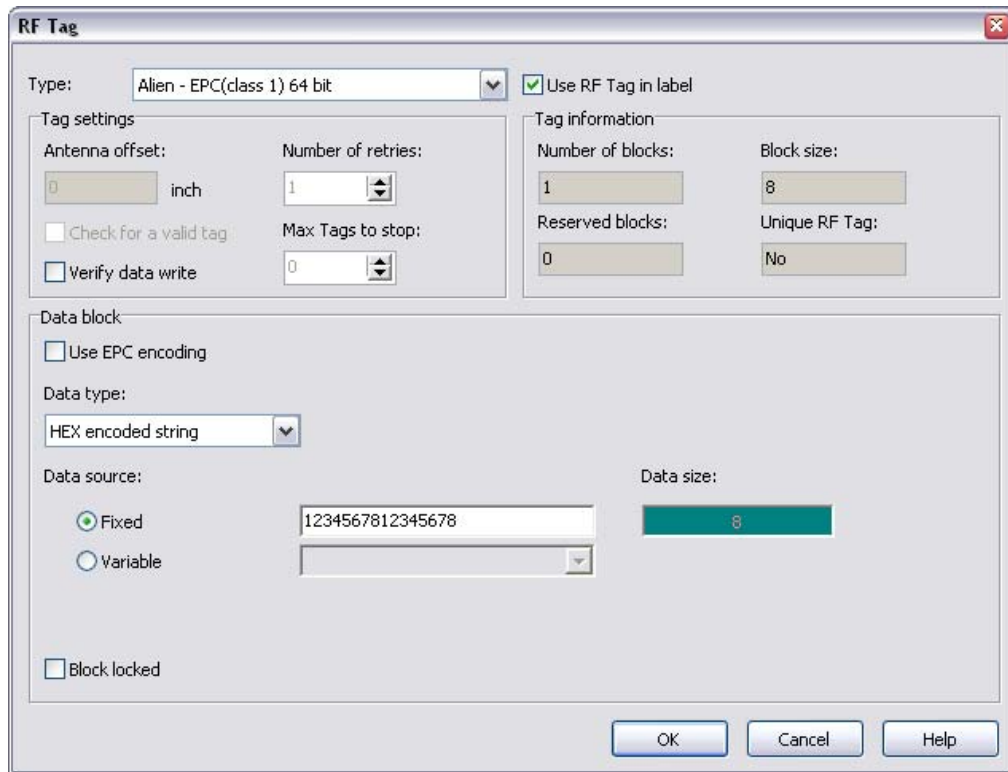

Click on the scroll-down arrow for the Type field and select the Alien - EPC (class 1) 64 bit menu option or the type of inlay desired.

Next, click on the scroll-down arrow for the Data Type field and select either ASCII or Hex Encoded String option.

**ASCII** Allows the data to be entered as full ASCII table and the software changes over to HEX when sending it to the printer. For a 64 bit tag selection, eight (8) digits must be used and for a 96 bit selection, twelve (12) digits must be used.

**HEX** Allows the data to be entered using 0 through 9 and A through F. The exact data is sent to the printer's chip. For a 64 bit tag selection, sixteen (16) digits must be used and for 96 bit selection, twenty-four (24) digits must be used.

Note that this data may also be substituted with a variable previously created in Label Gallery by selecting the Variable option for the Data Source ratio.

EPC encoding translators may also be used by selecting that relative box on the screen. When checked, select the type of EPC encoding you wish to use and then fill in the data values which show up as shown on the following screen.

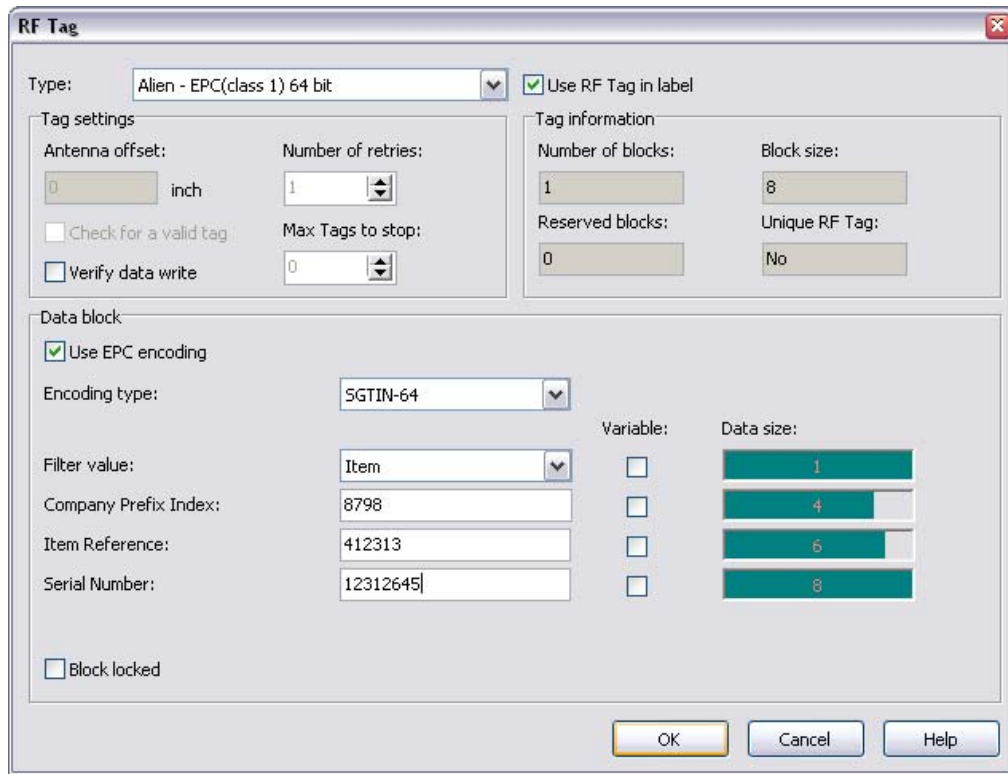

Click on the OK button when complete and the label will show up on the next screen with the RFID inlay outlined around the label. Refer to the screen below.

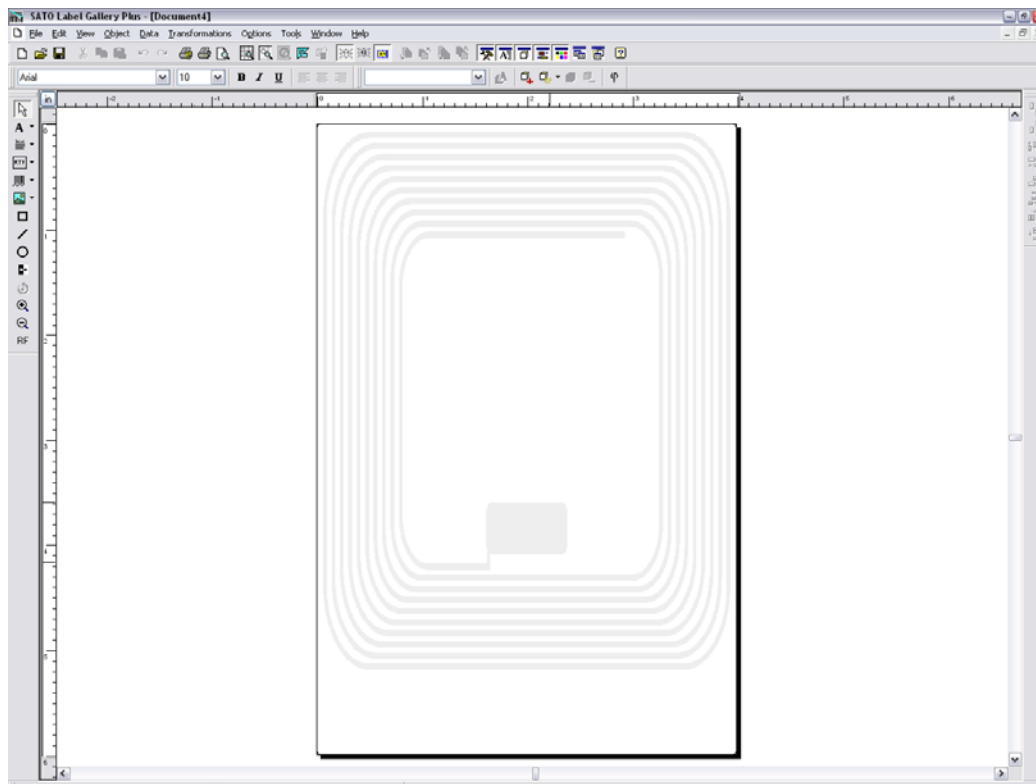

Populate the label with label fields. Refer to the Label Galley Manual's Help Files for assistance as required.

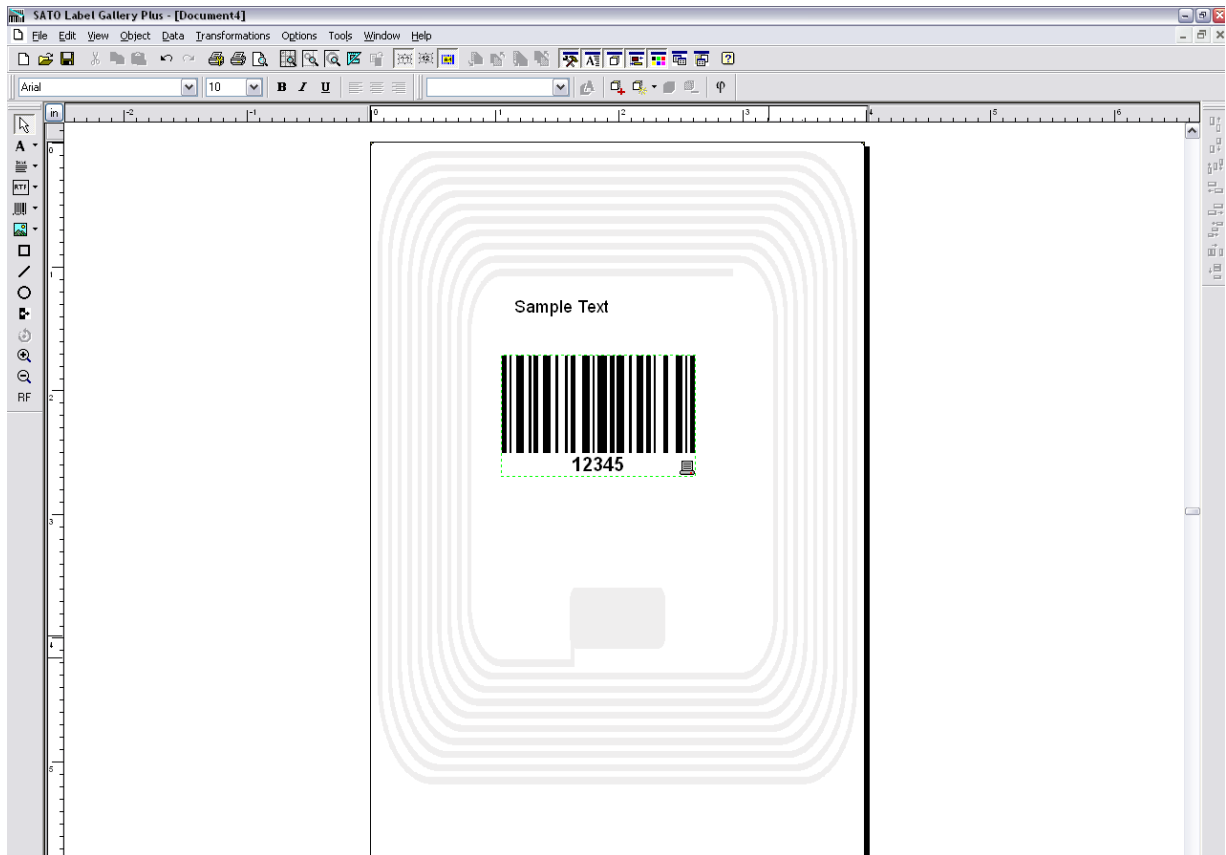

Once complete, click on FILE on the upper task bar, select the Print option and then enter the desired print quantity. The Print screen is displayed below.

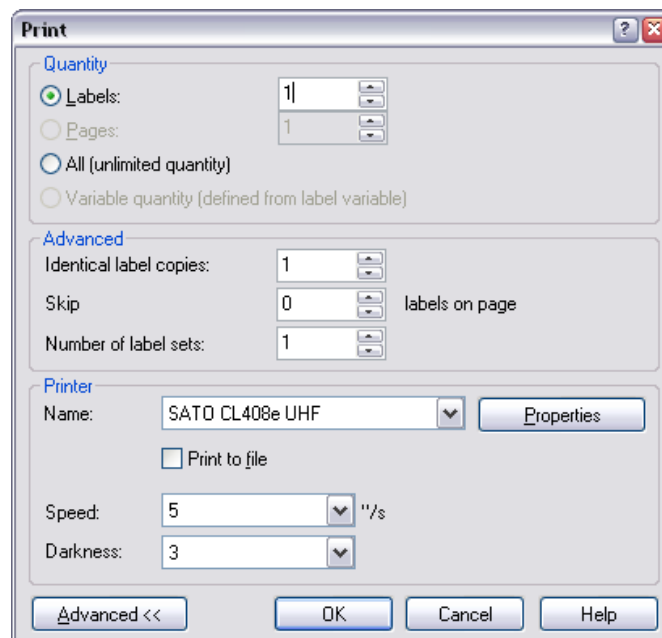

<b>EPC CODE WRITE DESIGNATION COMMAND</b>	
<b>FUNCTION</b>	Writes EPC code in RFID supply that supports EPC code.
<b>FORMAT</b>	<ESC>IP0n.nnn
<b>PARAMETER</b>	n = Data to be written (16 bytes fixed for 64 bit inlays) or (24 bytes fixed for 96 bit inlays).
<b>EXAMPLE</b>	To write 64-bit EPC code "8000 0000 4000 0001" for label issuance in RFID supply that supports EPC code: <ESC>A <ESC>V50<ESC>H50<ESC>BD3020654912345678904 <ESC>IP08000000040000001 <ESC>Q1 <ESC>Z
<b>NOTES</b>	Printing of multiple tags (QTY > 1) is available with this command. If data is written to an RFID tag, labels are printed after sent EPC data and encoded EPC data are automatically checked. If EPC code writing could not be carried out (i.e. bad tag), a tag error label is printed and an output is sent via EXT Port, PIN 3. Data other than 0 to 9 and A to F will be considered a command error. If used without print data, this command will not cause a label to feed in the case of a successful tag encode.

<b>EPC CODE READ DESIGNATION COMMAND</b>	
<b>FUNCTION</b>	Reads information of RFID supply supporting EPC code.
<b>FORMAT</b>	<ESC>IP1
<b>RETURN STATUS FORMAT</b>	STX (02H) . EPC code . ETX (03H)
<b>RETURN STATUS LIST</b>	STX (02H) = Starting code: 1 byte. EPC Code = EPC Code; 16 bytes fixed. ETX (03H) = Ending code: 1 byte fixed.
<b>EXAMPLE</b>	<ESC>A<ESC>IP1<ESC>Z If "8000 0000 4000 0001" is recorded in RFID supply that supply that supports EPC code: 02 = Starting code 38 30 30 30 30 30 30 30 34 30 30 30 30 30 30 31 EPC 03 = Ending code. NOTE: In actuality, all data is continuous without spaces.
<b>NOTES</b>	This command cannot be combined with another command to designate. This command cannot be received during printing. If the connection is closed before all status' are returned to the host, the tag data will not be correctly returned.

## Free Manuals Download Website

<http://myh66.com>

<http://usermanuals.us>

<http://www.somanuals.com>

<http://www.4manuals.cc>

<http://www.manual-lib.com>

<http://www.404manual.com>

<http://www.luxmanual.com>

<http://aubethermostatmanual.com>

Golf course search by state

<http://golfingnear.com>

Email search by domain

<http://emailbydomain.com>

Auto manuals search

<http://auto.somanuals.com>

TV manuals search

<http://tv.somanuals.com>