



CL608e/CL612e Printers



Service Manual

PN 9001079
Rev. B

SATO America, Inc.
10350-A Nations Ford Rd.
Charlotte, NC 28273
Main Phone: (704) 644-1650
Technical Support Hotline: (704) 644-1660
Fax: (704) 644-1661
<http://www.satoamerica.com>

© Copyright 2002
SATO America, Inc.

The information supplied in this manual was current at time of publication. If you come across procedures that need clarification or find errors or have suggestions contact us at qc@satoamerica.com

Warning: This equipment complies with the requirements in Part 15 of FCC rules for a Class B computing device. Operation of this equipment in a residential area may cause unacceptable interference to radio and TV reception requiring the operator to take whatever steps are necessary to correct the interference.

All rights reserved. No part of this document may be reproduced or issued to third parties in any form whatever without the express permission of SATO America, Inc. The materials in this document are provided for general information and are subject to change without notice. SATO America, Inc. assumes no responsibility for any errors that may appear.

Table of Contents

Section 1. Overview and Specifications	Page
1 Overview	1-1
2 Physical Characteristics	1-2
3 Printer Features	1-3
4 Operation Panel/Displays	1-5
5 Components	1-7
6 Switches and Sensors	1-8
7 Ribbon	1-10
8 Installation Considerations	1-10
9 Optional Accessories	1-10
10 Environment & Approvals	1-11
11 General Printer Specifications	1-11
12 Character Fonts	1-14
13 Bar Codes	1-15
Section 2. Configuration	
1 Dip Switch Settings	2-1
2 Default Settings	2-7
3 LCD Panel Printer Configuration	2-8
Normal Mode	2-9
M8400 Compatible Mode	2-12
Advanced Mode	2-13
Card Mode	2-17
Service Mode	2-25
Counters Mode	2-31
Test Print Mode	2-32
Default Setting Mode	2-33
Maintenance Mode	2-34
Clear Non-Standard Protocol	2-36
Download User Defined Protocol Codes	2-36
Hex Dump Mode	2-37
Download Mode	2-38
User Download Mode	2-39
4 Sample Test Labels	2-40
Section 3. Interface Specifications	
1 Overview	3-1
2 Interface Types	3-1
3 Receive Buffer	3-3
4 IEEE 1284 Parallel Interface	3-4
5 Optional RS232C Serial Interface	3-6
6 Universal Serial Bus (USB) Interface	3-9
7 Local Area Network (LAN) Interface	3-10
8 Bi-Directional Communications	3-10
9 Accessory (EXT) Connector	3-19
Section 4. Electrical Checks and Adjustments	
1 Overview	4-1
2 Steps Prior to Some Procedures	4-2
3 DC Power Voltage Checks	4-3
4 Potentiometer Assignments & Adjustments	4-6
5a Pitch Offset Adjustment	4-8

Table of Contents

Section 4. Electrical Checks and Adjustments

5b Pitch Offset Adjustment	4-9
6 Label Gap Adjustment	4-10
7 Eye-Mark Adjustment	4-11
8 Feed/Backfeed Adjustment (Tear-Off)	4-12
9 Feed/Backfeed Adjustment (Cutter)	4-13
10 Feed/Backfeed Adjustment (Dispenser)	4-14
11 Ribbon Sensor Verification	4-15
12 Ribbon Sensor Adjustment (Near End)	4-16
13 LCD Display Adjustment	4-17
14 Print Darkness Adjustment	4-18

Section 5. Mechanical Adjustments

1 Overview	5-1
2 Ribbon Clutch Adjustments	5-2
3 Print Head Position Adjustment	5-5
4 Print Head Balance Adjustment	5-7
5 Ribbon Roller Adjustment	5-8
6 Feed Roller Adjustment (Label Tracking)	5-9
7 Timing Belt Tension Adjustment	5-11
8 Head Latch Adjustment	5-12
9 Notch/Gap Sensor Adjustment	5-13

Section 6. Replacement Procedures

1 Overview	6-1
2 Replacing the Main Circuit Board	6-2
3 Replacing the Fuses	6-7
4 Replacing the Power Supply	6-9
5 Replacing the Stepper Motor	6-12
6 Replacing the Timing Belts	6-13
7 Replacing the Print Head	6-16
8 Replacing the Platen	6-19
9 Replacing the Ribbon Drive Clutch Washers	6-23
10 Replacing the Ribbon Motion Sensor	6-27
11 Replacing the Paper End Switch (Micro-Switch) and the Bottom Half of the Notch/Gap and Eye-Mark Sensors	6-30
12 Replacing the Top Half of the Notch/Gap Sensor	6-34
13 Replacing the Display Panel or Keyboard	6-37

Section 7. Factory Resets

1 Overview	7-1
2 Factory/Service Test Print	7-2
3 Clear Head Counters	7-3
4 Clear Dispenser Counter	7-4
5 Clear Cutter Counter	7-5
6 Clear EEPROM	7-6
7 Sample Test Prints	7-7

Section 8. Troubleshooting

1 Overview	8-1
2 Initial Checklist	8-2
3 The IEEE 1284 Parallel Interface	8-2

Table of Contents

Section 8. Troubleshooting

4	The RS232C Serial Interface	8-4
5	The Universal Serial BUS (USB)	8-4
6	The LAN Ethernet Interface	8-5
7	Error Signals	8-10
8	Troubleshooting Tables	8-11
9	Head Pattern Examples	8-15
10	Hex Dump Diagnostic Labels	8-17

Section 9. Optional Accessories

1	Overview	9-1
2	Label Cutter Kit Installation	9-2
3	Label Dispenser Kit Installation	9-6
4	PCMCIA Memory Expansion Installation	9-15
5	Flash Memory Expansion Installation	9-20
6	Real Time Clock Installation	9-22

Section 10. Parts List

1	Overview	10-1
2	Base Cover Assembly	10-2
3	Frame Assembly	10-11
4	Print Head Assembly	10-18
5	Ribbon Assembly	10-22
6	Feed Roller Assembly	10-27
7	Main PCB Assembly	10-30
8	Interface Option	10-31
9	Dispenser Assembly Option	10-32
10	Cutter Assembly Option	10-39
11	PCMCIA Memory Option	10-43

Index	Index -1
-------------	----------



Overview and Specifications

1.1 Overview

The SATO CL608e/CL612e Printers Service Manual provides information for installing and maintaining CL608e/CL612e Thermal Transfer printers. Step-by-step maintenance instructions are included in this manual with typical problems and solutions. It is recommended that you become familiar with each section in this manual before installing and maintaining the printer.

The major differences between the CL608e and the CL612 printers is the resolution of the head and label width. The CL608e with its 203 dpi head provides an economical labeling solution for most applications. It can print labels up to six inches wide. The CL612e provides a higher print resolution, 305 dpi to give laser-quality printing. It is useful when higher resolution is needed for detailed graphic images. It can print labels up to 6.5 inches wide.

The CL Series "e" printers use a subset of the standard SATO Command Language. The CL608e/CL612e share the same command set, the only differences are the allowable values representing the print positions on the label. These values are specified in "dots" and will vary depending upon the resolution of the printer and the amount of memory available for imaging the label. The allowable range for each printer is specified in a table for those command codes.

The sections in this manual cover the following:

- *Section 1. Overview and Specifications*
- *Section 2. Configuration*
- *Section 3. Interface Specifications*
- *Section 4. Electrical Checks and Adjustments*
- *Section 5. Mechanical Adjustments*
- *Section 6. Replacement Procedures*
- *Section 7. Factory Resets*
- *Section 8. Troubleshooting*
- *Section 9. Optional Accessories*
- *Section 10. Parts list*

1.2 Physical Characteristics

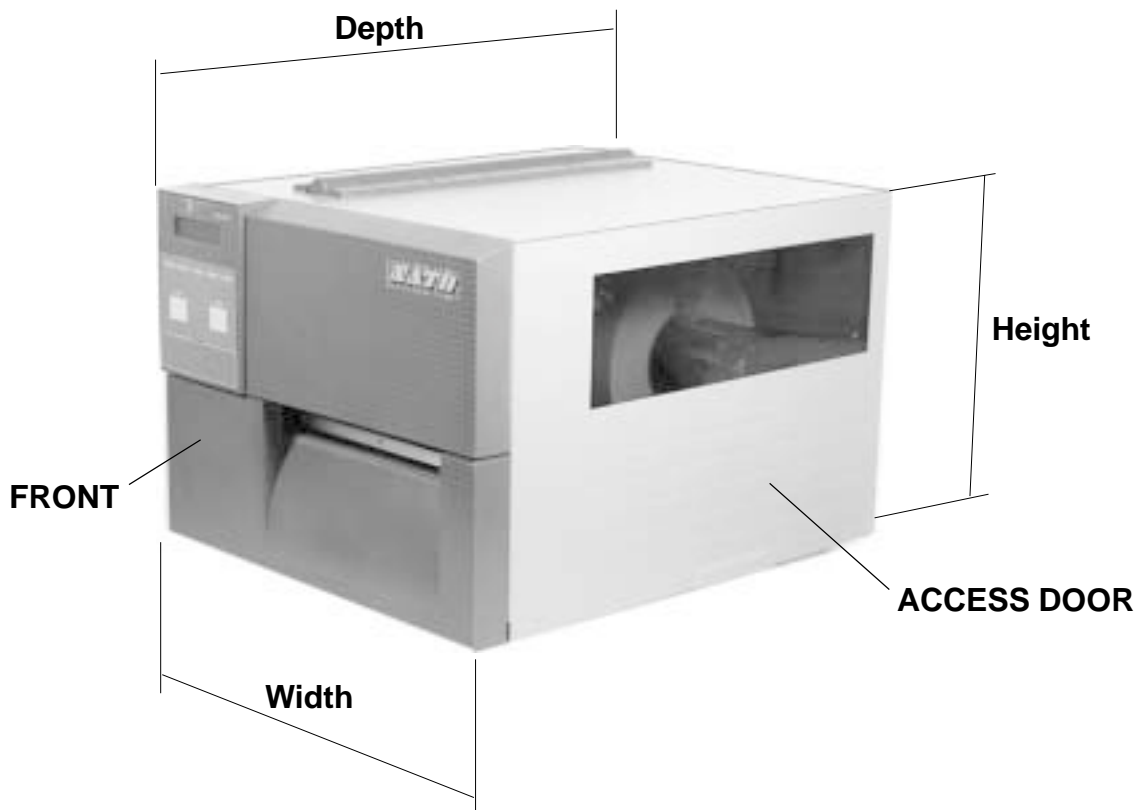

Dimensions	CL608e	CL612e
Wide	13.8 in. (352 mm)	
Deep	16.9 in. (430 mm)	
High	11.7 in. (298 mm)	
Weight	41.9 lbs. (19 kg)	
Power Requirements		
Voltage	115 -220 V (+/- 10%) 50/60 Hz (+/- 1%)	
Power Consumption	50W idle 130W Operating	

1.3 Printer Features

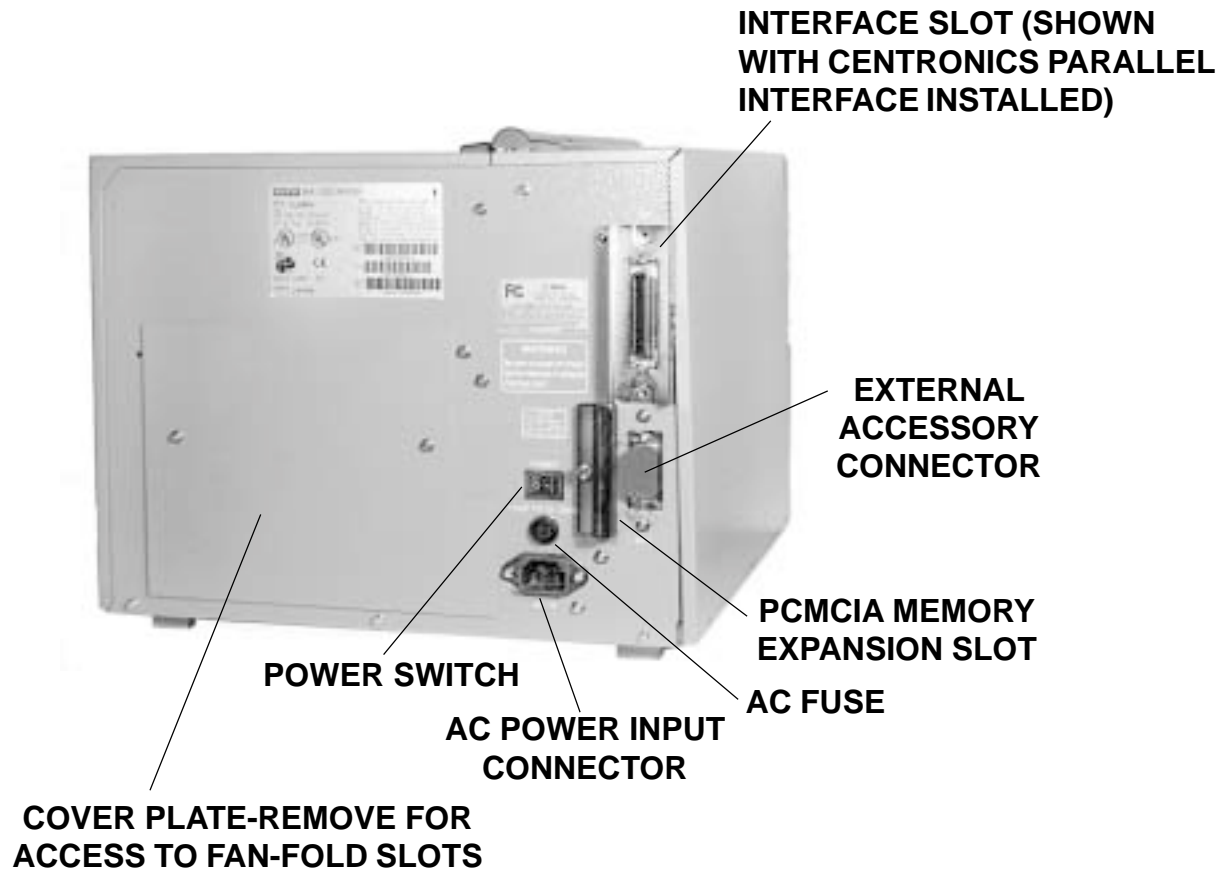

Rear Panel

INTERFACE SLOT	Slot to plug in an interface adapter. An adapter must be connected before the printer is operational. The adapter types available are: RS232C Serial I/F Module, DP-25P IEEE1284 Parallel I/F Module, AMP 57-40360 Universal Serial Bus I/F Module Ethernet 10/100 BaseT I/F Module
MEMORY CARD SLOT	One slot for optional PCMCIA Memory Cards.
EXT CONNECTOR	External signal connector for Accessories, AMP 57-60140
POWER SWITCH	Turns power On/Off
AC FUSE	Input power protection. Type 3A/250V.
AC POWER INPUT	Input 115V 50/60 Hz connector. Use the cable provided.

Printer Features

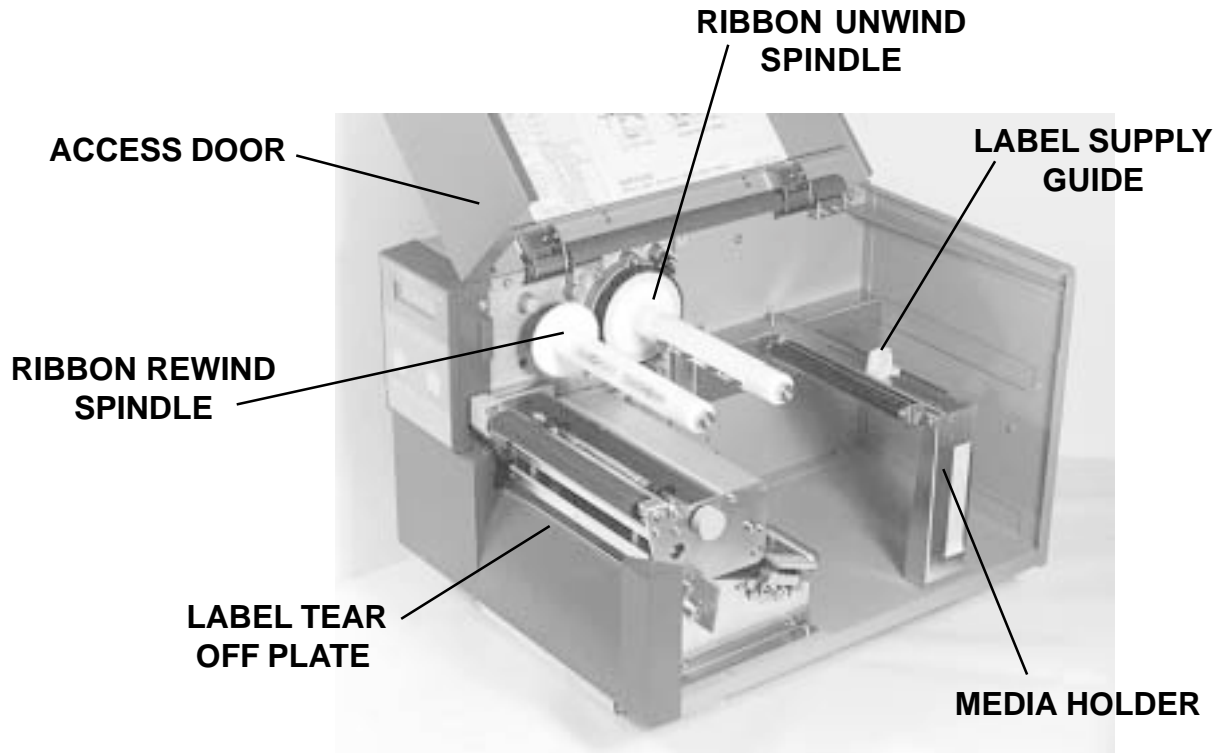

SWITCHES AND SENSORS Refer to Section 1.6

Adjust the Media Knob based on the media you have loaded. For media up to 2.3 inches wide, use the "1" position. For media between 2.3 and 4.6 inches wide, use the "2" position. For media wider than 4.6 inches wide, use the "3" position. If you use media narrower than 7 inches, using the wrong setting can void the print head warranty due to excessive pressure.

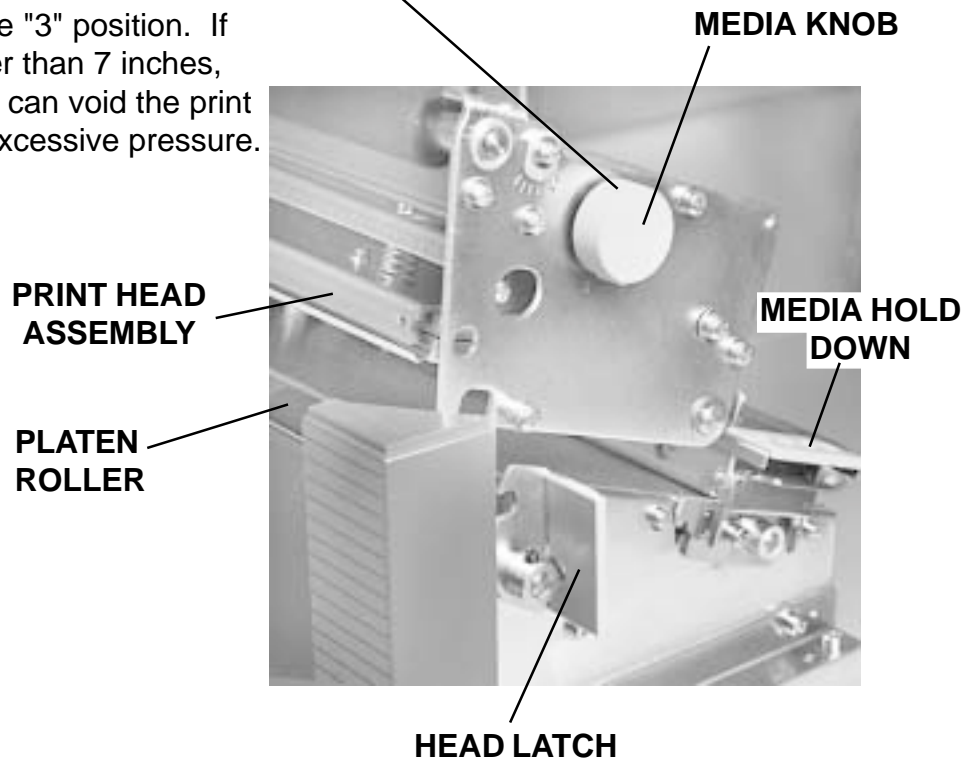

1.4 Operation Panel/Displays

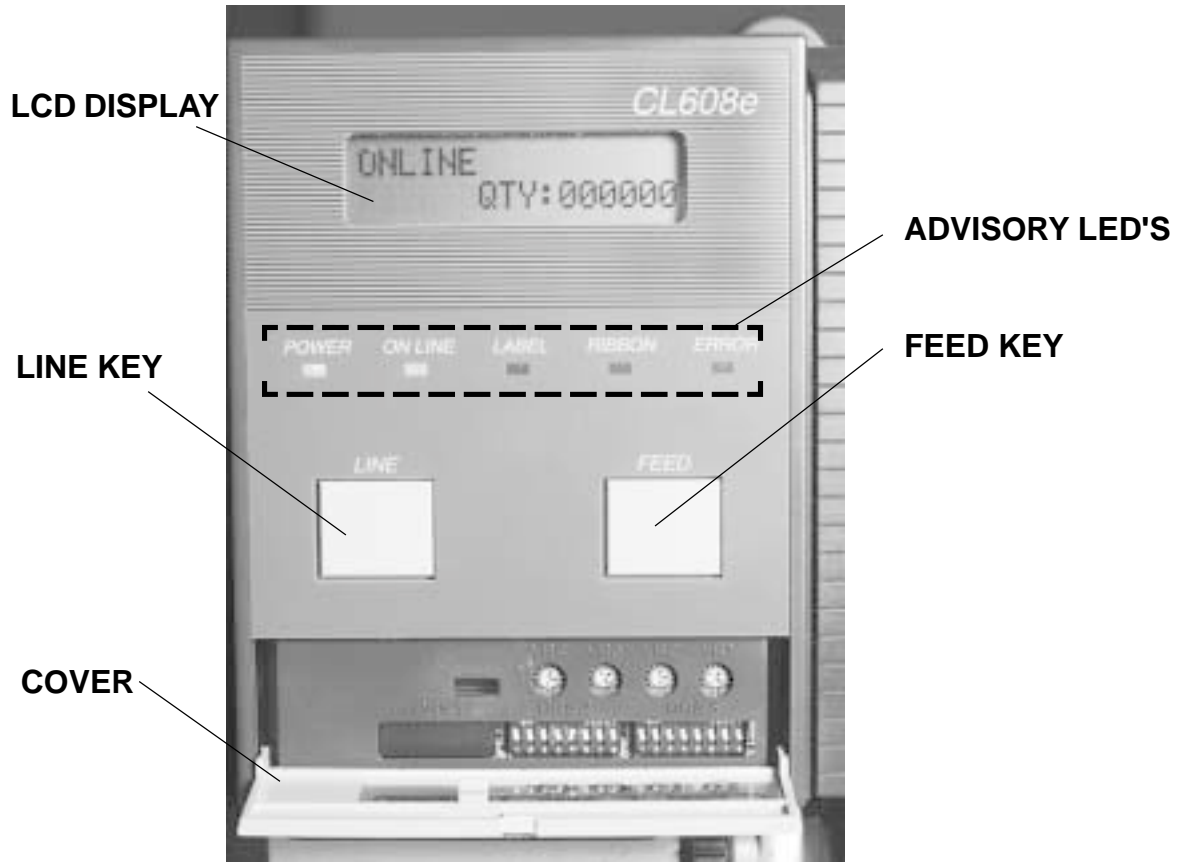

ADVISORY LED'S

POWER	Illuminated when power is on.
ONLINE	Illuminated when printer is ready to receive data. Turn ON/OFF by toggling the LINE key.
LABEL	Illuminated when label supply is out.
RIBBON	Illuminated when ribbon motion sensor does not detect any ribbon motion.
ERROR	Illuminated when there is a system fault such as an open print head.

LCD SCREEN	2 LINE x 16 Character LCD display. Used for setting operational parameters of the printer and displaying error conditions
LINE KEY	Momentary switch. Pressing this key toggles the printer between the on-line and off-line mode. When the printer is on-line, it is ready to receive data from the host. This key acts as a pause during a print job by taking the printer off-line.
FEED KEY	Momentary switch. Pressing this key feeds one blank label through the printer when it is off-line. When the printer is on-line, there is a user selectable option in the Service Mode (see page 2-28) to either print a copy of the previously printed label or feed a blank label. The default is to feed a blank label.

Operation Panel/Displays

POTENTIOMETERS

VR1 (Print)	To adjust print darkness (fine adjustment).
VR2 (Offset)	To adjust amount of back/forward feed for dispenser/cutter/tear-off bar position (+/- 3.75).
VR3 (Pitch)	To adjust home print position of the label (+/- 3.75 mm).
VR4 (Display)	To adjust the contrast of the LCD display.

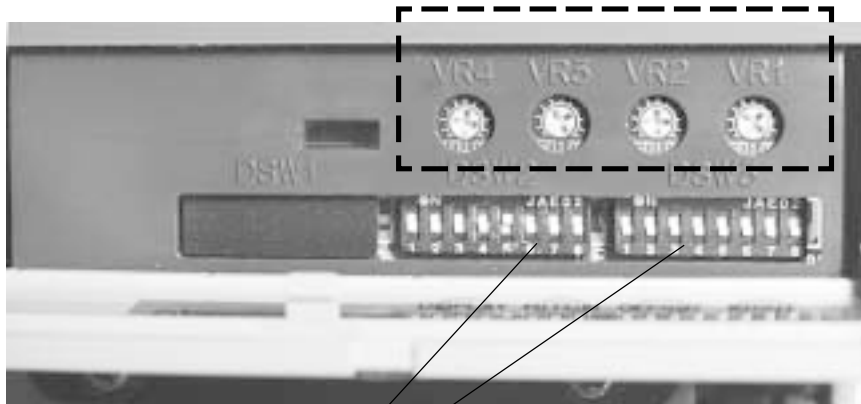

***DSW2 & DSW3** Dip Switches used to set operational parameters of printer. Refer to Section 2 for settings.

***NOTE:** Optional RS232 Communication Card contains DSW1 switches which are configured when supplied with the printer.

1.5 Components

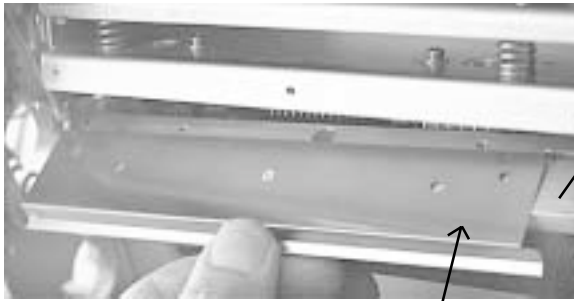

PRINT HEAD

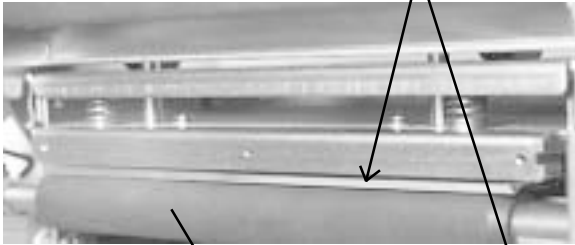

PLATEN

RIBBON GUIDE
PLATE

LCD BOARD AND
KB BOARD ON
BACKSIDE OF PANEL

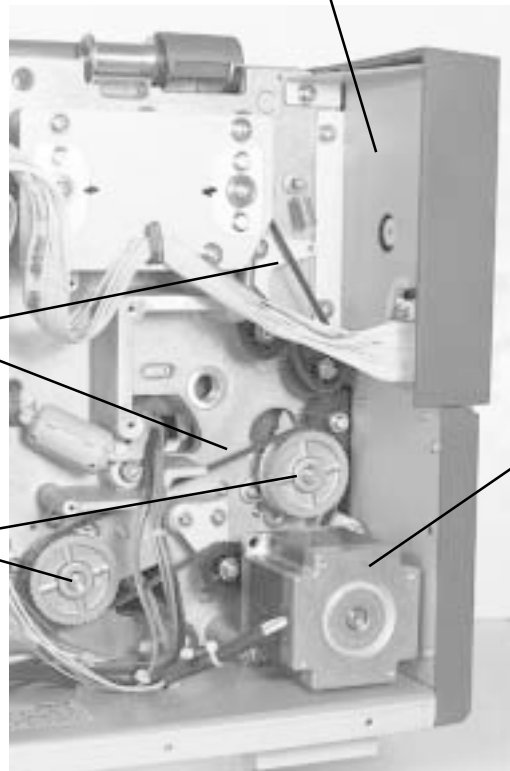

TIMING
BELTS

PLATENS

STEPPER
MOTOR

Components

POWER SUPPLY UNIT

PLUG-IN INTERFACE
CARD - CENTRONICS
I/O SHOWN

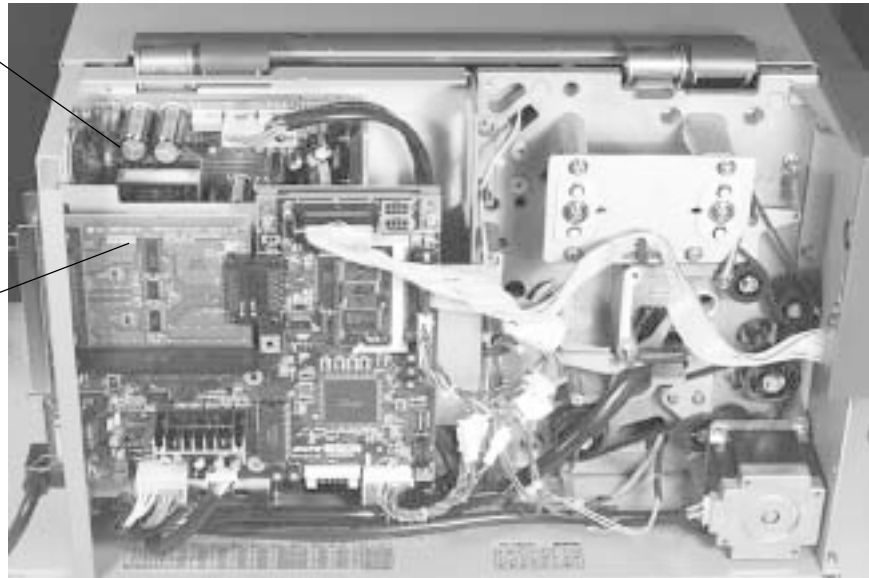

1.6 Sensors and Switches



RIBBON SENSOR: This sensor is a motion detector that signals the printer when the ribbon supply is turning. This sensor is used for both the ribbon end and ribbon near end sensing.

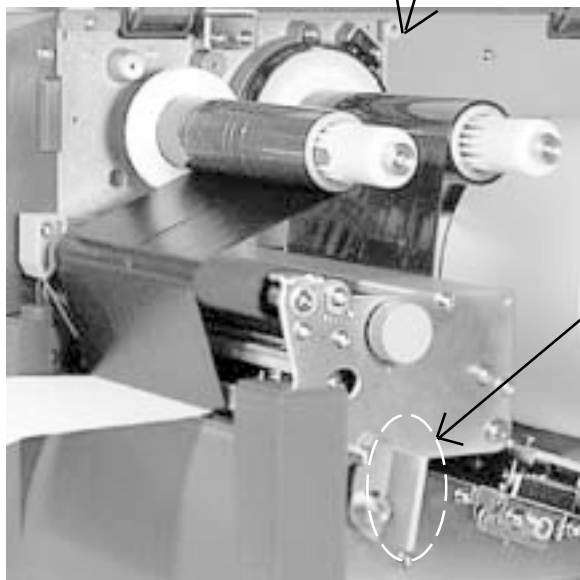

HEAD LATCH LEVER: When the print head is opened, a micro switch is activated and the printer will stop printing. Error message will be displayed on the LCD operator panel.

Switches and Sensors

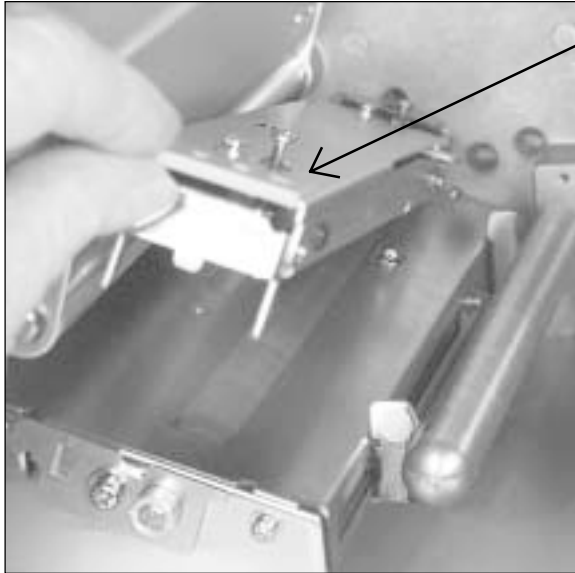

MEDIA HOLD DOWN: Open by lifting up on the release tab underneath the green tab marked "PUSH". The Media Hold Down is spring loaded and will remain in the up position. Close by pushing down on the same green tab.

NOTCH/GAP SENSOR
(Top Half is adjustable)
(Refer to Section 5-10)

MEDIA HOLD DOWN
(Underside)

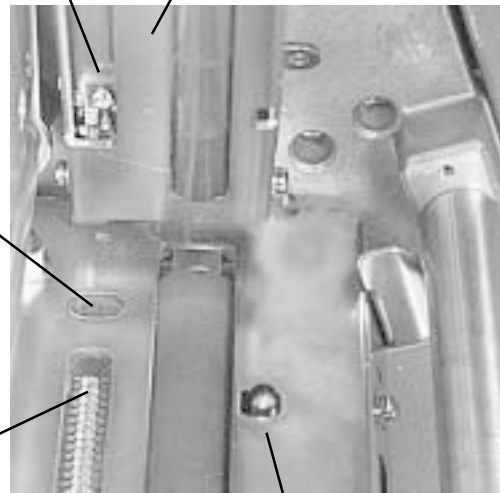

"EYE-MARK" SENSOR
(Fixed: Non adjustable)

NOTCH/GAP SENSOR LED ARRAY (Bottom Half is Non-adjustable)

LABEL OUT SENSOR: This micro switch is activated when media stock is out or when the Media Hold Down is in the up position. All printer operations stop, and an error message is displayed on the LCD.

1.7 Ribbon

Use only SATO thermal transfer ribbons which were formulated expressly for use in all SATO printers. Use of other than approved ribbons may result in unsatisfactory print quality and/or damage to the print head and may void your warranty.

1.8 Installation Considerations

Printer operation can be affected by the printer environment. The location of the printer should be free from dust, humidity and sudden vibrations. To obtain optimum results from the printer, avoid locations influenced by:

- Direct or bright sunlight, since bright light will make the label sensor less responsive and may cause the label to be sensed incorrectly.
- Warm temperatures which can cause electrical problems within the printer. (See Section 1.10 Environment.

1.9 Optional Accessories

ACCESSORY	CL608e/CL612e
Memory Expansion	One slot for PCMCIA Memory Cards (up to 16 MB Flash or 4 MB SRAM) and/or 4 MB internal Flash ROM. Can be used for graphic file storage, print buffer expansion, format storage and downloaded True Type fonts.*
Calendar	An internally mounted Date/Time chip that can be used to date/time stamp labels at the time of printing.*
Label Cutter	An internally mounted attachment allowing labels to be cut at specified internals. Controlled through programming.*
Label Dispenser	Internal attachment allowing labels to be peeled from backing for immediate (on demand) application. Backing take-up mounted externally to rear of printer.
Label Rewinder	External option that rewinds labels onto a roll after they are printed.
Parallel Interface	IEEE1284 Parallel Interface Module
Serial Interface	High Speed Serial RS232 Interface Module
Universal Serial I/F	USB Interface Module
Ethernet Interface	10/100BaseT Interface Module
Coax/Twinax Interface	Coax/Triax Interface Module. Coax I/F emulates an IBM 3287-2 printer with a standard Type A BNC connector. Twinax I/F emulates IBM 5224, 5225, 5226 or 4214 printers with auto-terminate/cable-thru capabilities

* Check with your software vendor to make sure these functions are supported.

1.10 Environment & Approvals

Environmental	CL608e/CL612e
Operating Temperature	41° to 104° F (5° to 40° C)
Storage Temperature	-0° to 104° F (-20° to 40° C)
Operating Humidity	15-85% RH, non-condensing
Storage Humidity	Max 90% RH, non-condensing
Electrostatic Discharge	8KV
Regulatory Approvals	
Safety	UL, CSA
RF/EMI	FCC Class A

1.11 General Printer Specifications

Specification	CL608e	CL612e
Print		
Method	Direct or Thermal Transfer	
Speed (User Selectable)	4 to 8 ips - 100 to 200 mm/s	
Print Module (Dot Size)	.0049 in. - .125 mm	.0033 in. - .083 mm
Resolution	203 dpi - 8 dpmm	305 dpi - 12 dpmm
Maximum Print Width	6.0 in. - 152 mm	6.5 in. - 164 mm
Maximum Print Length	49.2 in. - 1249 mm	32.8 in. - 833 mm

Specification	CL608e	CL612e
Media		
Minimum Width	1.96 in. (50 mm)	
Minimum Length	.78 in. (20 mm)	
Maximum Width	7 in. (178 mm)	
Type	Die Cut Labels, Fan-Fold, Tag Stock or Continuous	
Caliper	.010 in. (.25 mm)	
Roll OD (max)	8.6 in. (218 mm), Face-in Wind	
Core ID (min)	1.5 in. (38 mm)	
Core ID (Recommended)	3 in. (76 mm)	

General Printer Specifications

Specification	CL608e	CL612e
Sensing		
Transmissive See-thru	Movable	
Reflective Eye-Mark	Fixed	
Continuous Form	Sensor not used	
Ribbon		
Maximum Width	6.75 in. (172 mm)	
Length	1345 ft. (410 m)	
Thickness	4.5 micron, Face in Wind	
Controls and Signals		
On-Line LED	Green	
Power LED	Green	
Media Out LED	Red	
Ribbon Out LED	Red	
Error LED	Red	
LCD Panel	2 Line x 16 Character	
On/Off-Line Switch	Front Panel	
Label Feed Switch	Front Panel	
Power On/Off Switch	Rear Panel	
Potentiometer Adjustments		
Print Darkness	Front Panel	
Pitch	Front Panel	
Offset	Front Panel	
Display	Front Panel	

General Printer Specifications

Specification	CL608e	CL612e
Interface Modules		
Parallel	IEEE 1284 Parallel	
Serial	RS232C (9600 to 57,600 bps) RS422/485 (9600 to 57,600 bps)	
Serial Protocol	Hardware Flow Control (Ready/Busy) Software Flow Control (X-On/X-Off) Bi-directional Status 2,3 or 4	
Universal Serial Bus	USB Version 1.1	
Ethernet	10/100BaseT	
Data Transmission	ASCII Format	
Processing		
CPU	32 Bit RISC	
Flash ROM	2 MB	
SDRAM	16 MB	
Receive Buffer	2.95 MB	
Optional Flash ROM	4 MB	
Optional PCMCIA Memory	Up to 16 MB Flash or 4 MB SRAM	

1.12 Character Fonts

Specification	CL608e	CL612e
Matrix Fonts		
U Font	(5 dots W x 9 dots H)	
S Font	(8 dots W x 15 dots H)	
M Font	(13 dots W X 20 dots H)	
XU Font	(5 dots W x 9 dots H) Helvetica	
XS Font	(17 dots W x 17 dots H) Univers Condensed Bold	
XM Font	(24 dots W x 24 dots H) Univers Condensed Bold	
OA Font	(15 dots W x 22 dots H) OCR-A	(22 dots W x 33 dots H) OCR-A
OB Font	(20 dots W x 24 dots H) OCR-B	(30 dots W x 36 dots H) OCR-B
Auto Smoothing Fonts		
WB	WB Font (18 dots W x 30 dots H)	
WL	WL Font (28 dots W x 52 dots H)	
XB	XB Font (48 dots W x 48 dots H) Univers Condensed Bold	
XL	XL Font (48 dots W x 48 dots H) Sans Serif	
Vector Font		
	Proportional or Fixed Spacing Font Size 50 x 50 dots to 999 x 999 dots Helvetica, 10 Font Variations	
AGFA Raster Fonts		
A Font	CG Times, 8 to 72 pt	
B Font	CG Triumvirate, 8 to 72 pt	
Downloadable Fonts		
	Bit Mapped TrueType Fonts with Utility Program	
Character Control		
	Expansion up to 12 X in either the X or Y coordinates Character Pitch control Line Space control Journal Print facility 0°, 90°, 180° and 270° Rotation	

1.13 Bar Codes

Specification	CL608e	CL612e
Symbologies		
	Bookland (UPC/EAN Supplemental) EAN-8, EAN-13 CODABAR Code 39 Code 93 Code 128 Interleaved 2 of 5 Industrial 2 of 5 Matrix 2 of 5 MSI POSTNET UCC/EAN-128 UPC-A and UPC-E Data Matrix Maxicode PDF417	
Ratios	1:2, 1:3, 2:5 User definable bar widths	
Bar Height	4 to 600 dots, User programmable	
Rotation	0°, 90°, 180° and 270°	
Other Features		
Sequential Numbering	Sequential numbering of both numerics and bar codes	
Custom Characters	RAM storage for special characters	
Graphics	Full dot addressable graphics, SATO Hex/Binary, .BMP or .PCX formats	
Form Overlay	Form overlay for high-speed editing of complex formats	



Section 2

Configuration

2.1 Dip Switch Settings

Two DIP switches (DSW2 & DSW3) are located inside the Front Access Door. These switches can be used to set:

- *Thermal transfer or direct thermal mode*
- *Head Check Mode*
- *Hex Dump Mode*
- *Label sensor enable/disable*
- *Single Job or Multi-Job Receive Buffer*
- *Operation Mode*



DIP SWITCHES

In addition, a third DIP switch (DSW1) is located on the optional RS232C Serial Adapter card and is used to set the RS232C transmit/receive parameters.

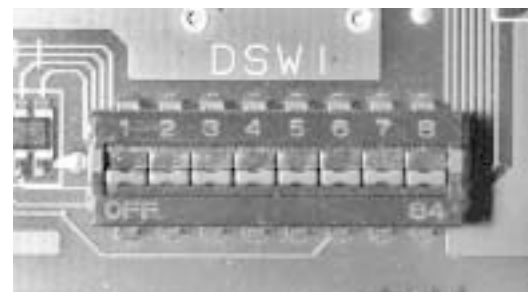
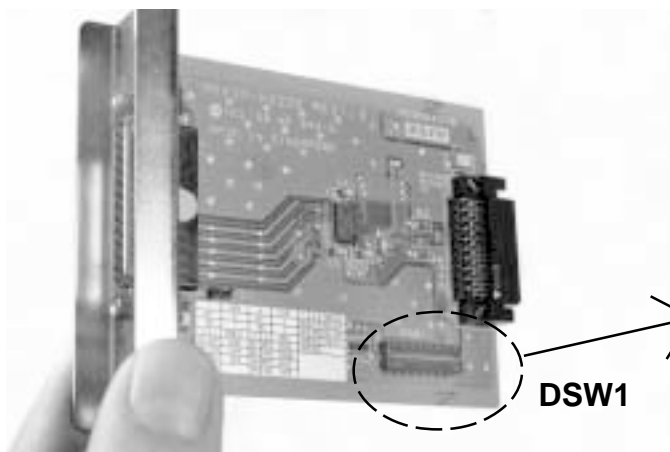

Each switch is an eight section toggle switch. The On position is always to the top. To set the switches, first power the unit Off, then position the DIP switches. Finally after placing the switches in the desired positions, power the printer back on. The switch settings are read by the printer electronics during the power-up sequence. They will not become effect until the power is cycled.

Dip Switch Settings

RS232 Transmit/Receive Setting (located on RS232 I/F Module)

Data Bit Selection (DSW1-1): This switch sets the printer to receive either 7 or 8 data bits for each byte transmitted.

DSW1-1	SETTING
Off	8 data bits
On	7 data bits

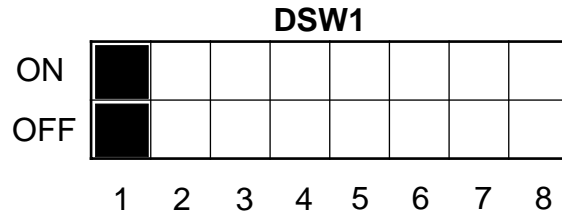

Parity Selection (DSW1-2, DSW1-3): These switches select the type of parity used for error detection.

DSW1-2	DSW1-3	SETTING
Off	Off	None
Off	On	Even
On	Off	Odd
On	On	Not Used

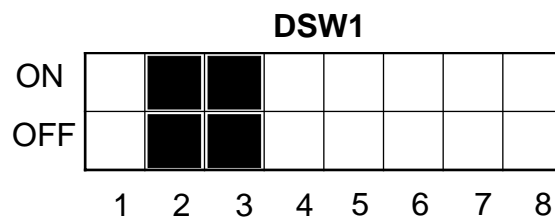

Stop Bit Selection (DSW1-4): Selects the number of stop bits to end each byte transmission.

DSW1-4	SETTING
Off	1 Stop Bit
On	2 Stop Bits

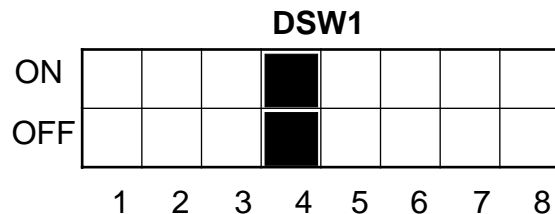

Baud Rate Selection (DSW1-5, DSW1-6): Selects the data rate (bps) for the RS232 port.

DSW1-5	DSW1-6	SETTING
Off	Off	9600
Off	On	19200
On	Off	38400
On	On	57600

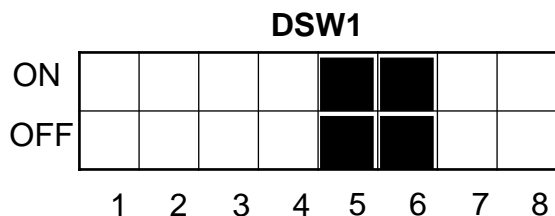

Protocol Selection (DSW1-7, DSW1-8): Selects the flow control and status reporting protocols.

(* Will select protocol Bi-Com 2 for M-8400 if DSW2-8 is ON)

DSW1-7	DSW1-8	SETTING
Off	Off	Rdy/Bsy
Off	On	Xon/Xoff
On	Off	Bi-Com 3
On	On	Bi-Com 4*

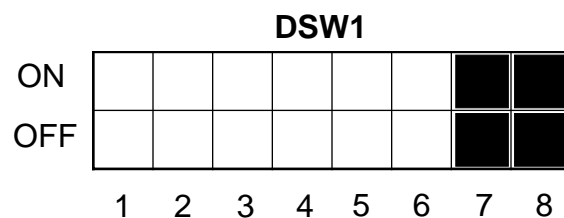

Dip Switch Settings

Printer Set up

Print Mode Selection (DSW2-1): Selects between direct thermal printing on thermally sensitive paper and thermal transfer printing using a ribbon.

DSW2-1	SETTING
Off	Transfer
On	Direct Therm

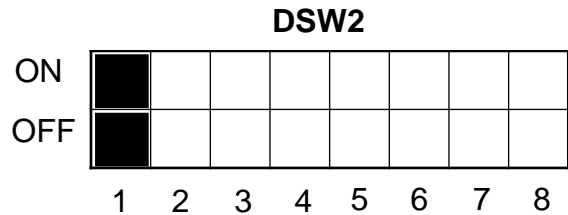

Sensor Type Selection (DSW2-2): Selects between the use of a label gap or a reflective Eye-Mark.

DSW2-2	SETTING
Off	Gap
On	Eye-Mark

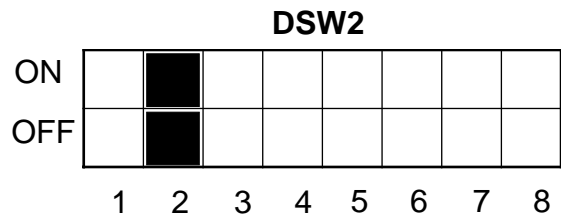

Head Check Selection (DSW2-3): When selected, the printer will check for head elements that are electrically malfunctioning.

DSW2-3	SETTING
Off	Disable
On	Enable

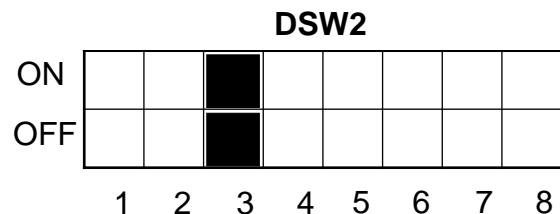

Hex Dump Selection (DSW2-4): Selects Hex Dump mode.

DSW2-4	SETTING
Off	Disable
On	Enable

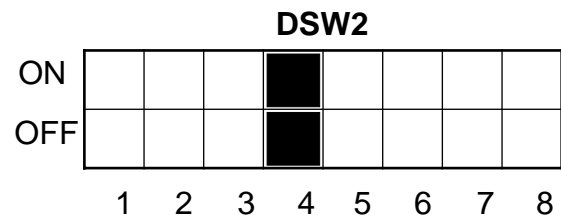

Receive Buffer Selection (DSW2-5): Selects the operating mode of the receive buffer. See Section 3: Interface Specifications for more information.

DSW2-5	SETTING
Off	1 Item
On	Multi-Job

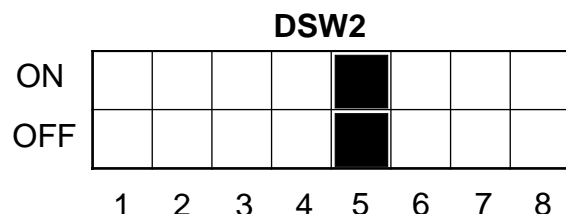

For more information about the cause of troubleshooting printer errors, see Section 8, Troubleshooting.

Dip Switch Settings

Firmware Download (DSW2-6): Places the printer in the Firmware Download mode for downloading new firmware into flash ROM.

DSW2-6	SETTING
Off	Disabled
On	Enabled

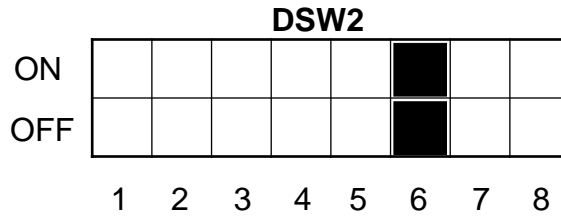

Protocol Code Selection (DSW2-7): Selects the command codes used for protocol control.

DSW2-7	SETTING
Off	Standard
On	Non-Std.

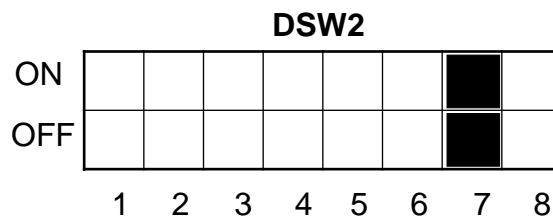

M8400 Emulation Mode (DSW2-8): For emulating earlier series software commands. Should be used only if problems are encountered when using existing software. This switch will also affect the settings selected by DSW1-7 and DSW1-8.

DSW2-8	SETTING
Off	Disabled
On	Enabled

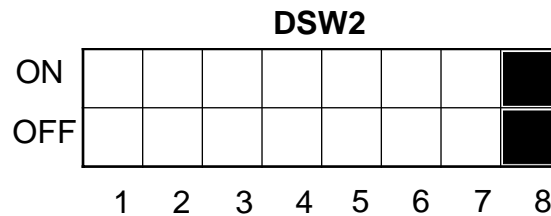

Backfeed Sequence Selection (DSW3-1 and DSW3-2): Selects the operating mode of the printer. Batch/Continuous disables the label taken (dispense option) sensor.

DSW3-1	DSW3-2	SETTING
Off	Off	Batch/Continuous
Off	On	Tear Off
On	Off	Cutter
On	On	Dispenser



Dip Switch Settings

Label Sensor Selection (DSW3-3): Enables or disables the Label Pitch sensor. If the sensor is enabled, it will detect the edge of the label and position it automatically. If it is disabled, the positioning must be under software control using Line Feed commands.

DSW3-3	SETTING
Off	Sensor Used
On	Sensor Not Used

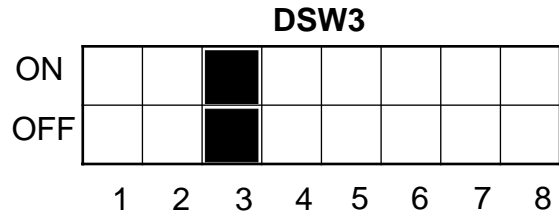

Back-Feed Selection (DSW3-4): When Back-Feed is enabled, the printer will position the label for dispensing/cutting and retract it before printing the next label. The amount of backfeed is adjustable.

DSW3-4	SETTING
Off	Enabled
On	Disabled

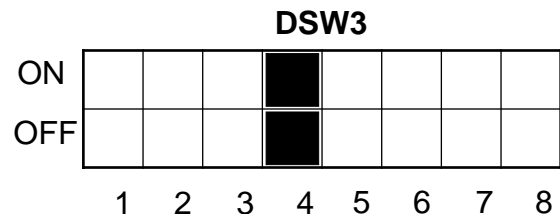

External Signal Interface

The EXT connector on the printer rear panel is intended for use with the external printer accessories such as label rewinders or applicators. The 14-pin Centronics type connector provides a choice of four different output signals along with various error conditions.

EXT Print Start Signal Selection (DSW3-5): Allows an external device to initiate a label print for synchronization with the applicator. See Section 3: Interface Specifications for a description of the signal level and requirements. When DSW3-5 is On, the unit is in the Continuous print mode, Backfeed is disabled and External Signals are ignored.

DSW3-5	SETTING
Off	Disabled
On	Enabled

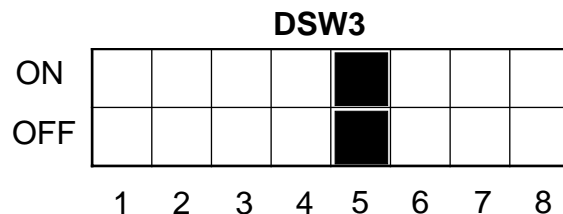

Dip Switch Settings

External Signal Type Selection (DSW3-6, DSW3-7): Both the polarity and signal type (level or pulse) of the external print synchronizing signal can be selected. See Section 3 for a definition of signal types.

DSW3-6	DSW3-7	SETTING
Off	Off	Type 4
Off	On	Type 3
On	Off	Type 2
On	On	Type 1

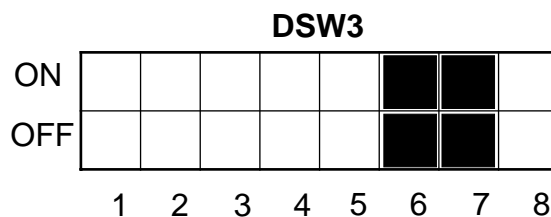

Repeat Print via External Signal (DSW3-8): Allows an applicator or other device to reprint the last label of the print job. See Section 3: Interface Specifications for a description of the signal requirements.

DSW3-8	SETTING
Off	Disabled
On	Enabled

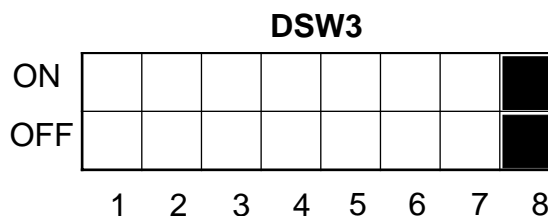

2.2 Default Settings

Dip Switch Selections

All switches are placed in the Off position (default) except Receive Buffer for shipping. This will result in the following operating configuration:

Communications: ⁽¹⁾	8 data bits, no parity, 1 Stop bit, 9600 Baud ⁽¹⁾
Protocol: ⁽¹⁾	Ready/Busy
Sensor:	Gap Sensor
Receive Buffer:	Multi-Job
Mode:	Batch Continuous
Label Sensor:	Sensor Used
Backfeed:	Enabled
External Signals:	Disabled

(1) Applicable only if an RS232 Interface Card is installed in the printer.

Software Default Settings - The printer stores any software settings upon receipt from the host and uses them until they are again changed by receipt of a command containing a new setting. These settings are stored in non-volatile memory and are not affected by powering the printer off. The printer may be reset to use the default software settings by depressing the LINE and FEED keys simultaneously while powering the printer on. You will be asked to confirm that you want the printer default settings by selecting either YES or NO by using the LINE key to step the underline cursor to the desired setting. If you select YES and press the FEED key, the following default configuration will be stored:

	CL608e/CL612e
Print Darkness	2
Print Speed	6 in. per sec.
Print Reference	Vertical = 0000, Horizontal = 0000
Zero	Slash
Auto On-Line	Enabled

Once the default operation is completed, a **DEFAULT SETTING COMPLETED** message will be displayed on the LCD panel and a single "beep" will be heard. The printer should be powered off while this message is being displayed. This saves the default settings in the EEPROM where they will be automatically loaded the next time the printer is powered on.

**DEFAULT SETTING
COMPLETED**

2.3 LCD Panel Configuration

The LCD Panel on the CL608e/CL612e is used in conjunction with the **LINE** and **FEED** switches by the operator to manually enter printer configuration settings. Many of the settings can also be controlled via software commands and in the case of conflict between software and control panel settings, the printer will always use the last valid setting. If you load a label job that includes software settings and then enter a new setting via the LCD Panel, the manually set values will be used by the printer. If you set the values manually and then download a job with software settings, the software settings will be used.

There are 7 configuration and operation modes you can access from the LCD panel. To enter the desired mode, the KEY SEQUENCE combination listed in the table below must be performed. The initial LCD display message is shown for each mode.

MODE	KEY SEQUENCE	INITIAL DISPLAY	PAGE
Normal Mode	Power	ONLINE QTY:000000	2-9
Advanced Mode	LINE + POWER	ADVANCED MODE	2-13
Test Print Mode	FEED + POWER	TEST PRINT MODE CONFIGURATION	2-33
Default Setting Mode (Std Protocol)	LINE + FEED + POWER	DEFAULT SETTING YES NO	2-34
Maintenance Mode	DSW2-4 ON + LINE + FEED + POWER	MAINTENANCE MODE DIPSW2-4 ON->OFF	2-35
Hex Dump Mode	DSW2-4 ON + POWER	ONLINE QTY:000000	2-38
Firmware Download Mode	DSW2-6 ON + POWER	FLASH DOWNLOAD READY	2-39

LCD Panel — Normal Mode

When the printer is first powered on it displays the current ROM version of the printer then immediately displays the ONLINE mode.

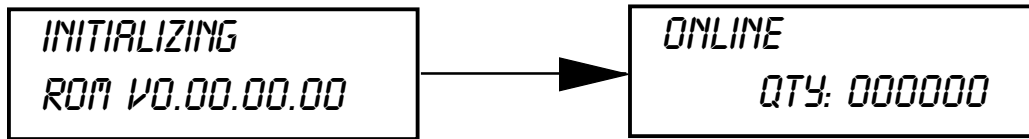

The LCD Panel will display the ONLINE status on the top line of the display. The bottom line will contain the label quantity (QTY) status. The message will be changed to OFFLINE whenever the printer is switched offline by depressing the LINE key. As soon as a print job is received, the QTY message will indicate the number of labels to be printed. As soon as the label job begins to print, the display will indicate the number of labels remaining in the print job that remain to be printed.

The user can access the User Settings using the following procedures:

User Settings

STEP	PROCEDURE
1.	The printer is first taken offline by pressing the LINE key once. The display will change to OFFLINE.
2.	Press the LINE and FEED keys simultaneously for more than one second. The printer now displays the first USER mode adjustment (Print Darkness).

Print Darkness Setting

There are three **Darkness** (or heat range) settings on the printer. The higher numbers represent darker settings. The current setting is indicated by a line under one of the range settings.

To change the setting perform the following steps:

STEP	PROCEDURE
1.	Use the LINE key to step the underlined cursor to the desired setting.
	1 = Light 2 = Medium 3 = Dark
2.	Once the correct setting is underlined, press the FEED key to accept the setting and advance to the next adjustment.

LCD Panel — Normal Mode

Print Speed Adjustment

There are three **Speed** settings on the printer. The setting is listed on the bottom line of the display. The current setting is indicated by an underline under one of the speed settings. To change the setting:

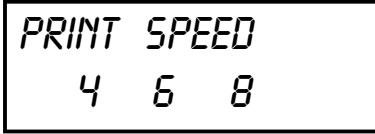
STEP	PROCEDURE
1.	<p>Use the LINE key to step the underlined cursor to the desired speed setting.</p> <p>4 = 4 in/s (100mm/s) 6 = 6 in/s (150mm/s) 8 = 8 in/s (200mm/s)</p> 
2.	<p>Once the correct setting is underlined, press the FEED key to accept the setting and advance to the next adjustment.</p>

Pitch Offset Adjustment

The label pitch is the distance from the leading edge (the edge that comes out of the printer first) of a label and the leading edge of the next label. The leading edge position of the label can be adjusted relative to the print head +/- 49mm in increments of 1mm. Once the position is set, it can be fine adjusted +/- 3.75mm using the PITCH potentiometer on the adjustment panel.

STEP	PROCEDURE
1.	<p>The underline cursor will initially be positioned underneath the Pitch Direction setting. Use the LINE key to step the underline to either the positive (+) or negative (-) selection. A positive selection moves the leading edge of the label forward (away from the print head) while a negative selection moves the leading edge of the label back into the mechanism.</p>
2.	<p>Once the correct setting is underlined, press the FEED key to accept the setting and advance to the Offset adjustment.</p>
3.	<p>Use the LINE Key to step the first digit of the counter to the desired setting. The display will increment one step each time the LINE key is pressed. The reading will advance to a setting of 4 after which it will automatically wrap and start at 0 again.</p>



LCD Panel — Normal Mode

Pitch Offset Adjustment

STEP	PROCEDURE
4.	<p>Press the FEED key to accept the setting and advance the cursor to the second digit. Again use the LINE key to step to the desired setting. Once it is correct, press the FEED key to advance to the next adjustment.</p> <p>Print a test label after completing the adjustments to ensure it is correct.</p>

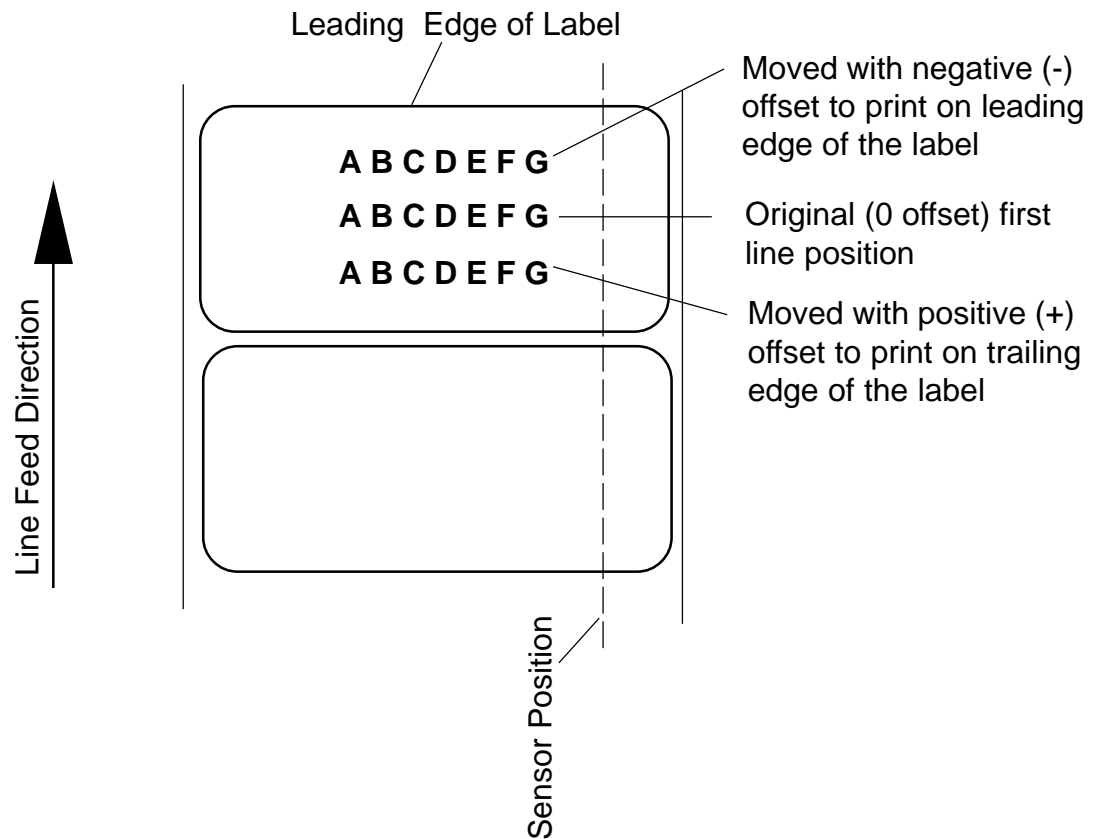

LCD Panel — Normal Mode

Cancel Print Job

If the printer has a print job(s) loaded in memory, selecting YES will cause the job(s) to be cleared. The default selection is NO. Make sure that you want to cancel the print job before selecting YES as the job cannot be recovered and will have to be retransmitted to the printer.

To cancel the print, perform the following steps:



STEP	PROCEDURE
1.	Press the LINE key to step the underlined cursor to either No or Yes .
2.	Once the correct setting is underlined, press the FEED key to accept the setting.
3.	After the print job(s) have been cleared from memory, the printer will display a COMPLETED message for 3 seconds and then return to the initial ONLINE Normal Mode.



If you wish to change any of the settings, you must enter the User mode again by taking the printer OFFLINE and simultaneously pressing **FEED** and **LINE** keys.

LCD Panel— Advanced Mode

Advanced mode is provided to make adjustments that require only occasional adjustments. Since they affect the basic operation of the printer, the procedure for entering this mode is designed to prevent someone from accidentally changing the settings.

To Enter Advanced Mode:

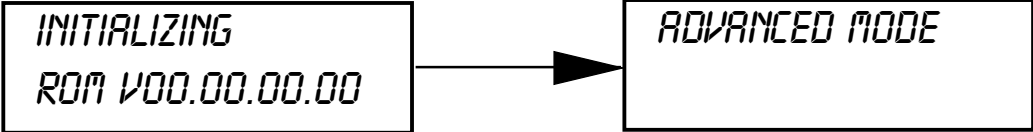
STEP	PROCEDURE
1.	<p>Press the LINE key while simultaneously turning the power ON. When the printer emits one long beep, release the LINE key to display the first screen.</p> 
2.	Press the FEED key to display the Zero Slash display.

Zero Slash

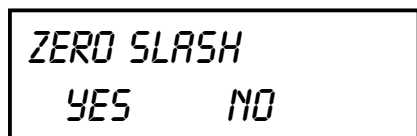

This setting determines if a zero is printed with a slash or without a slash. This setting can also be controlled via software commands. When YES is selected, the printer internal fonts will have a slash through the center of the zero character.

STEP	PROCEDURE
1.	Use the LINE key to step the underlined cursor to either Yes or No .
2.	Once the correct setting is underlined, press the FEED key to accept the setting and advance to the Auto Online display.

AutoOnline

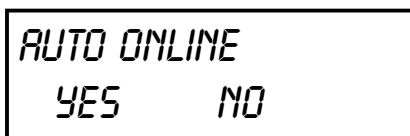

This setting determines the mode in which the printer powers up. If YES is selected the printer powers up in the ONLINE mode and is ready to print. If NO is selected, the printer powers up in the OFFLINE mode and must be manually placed in the ONLINE mode by pressing the LINE key before it is ready to print.

STEP	PROCEDURE
1.	Use the LINE key to step the underline to either the YES or NO selection.
2.	Once the correct setting is underlined, press the FEED key to accept the setting and advance the display to the Offset display.

LCD Panel — Advanced Mode

Print Offset

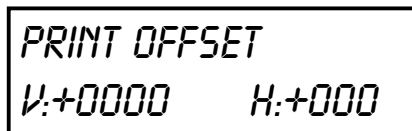

Since the printer moves the label in discrete steps equal to the size of the print dot, the units of measure for Vertical and Horizontal Offset distance is dots.

Vertical Offset is the distance down from the leading edge in dots (the edge of the label that comes out of the printer first) to the first vertical print position. A positive setting moves the first print position down the length of the label while making it negative moves it up the length of the label. The maximum value that can be set is 823 dots.

Horizontal Offset is the distance that the label image is shifted either to the right or left on the label. For a positive setting the image is shifted to the left (towards the inside edge of the label). For a negative setting the image the image is shifted to the right (towards the outside edge of the label). This setting changes the base reference point for all subsequent label jobs. The effect is identical to the <ESC>A3 Base Reference point command. The maximum values that can be set is 1424 dots.

STEP	PROCEDURE
1.	Use the LINE key to step the first digit of the counter to the desired setting. The display will increment one step each time the LINE key is pressed.
2.	Press the FEED key to accept the setting and advance the cursor to the second digit. Again use the LINE key to step to the desired setting. Once it is correct, press the FEED key to advance to the next adjustment.
3.	Once the setting is correct, press the FEED key to accept the setting and advance to the next display.

Print a test label after completing the adjustments to ensure it is correct.
Note: This setting can be overridden by the Base Reference Point Command in your software..

Set Calendar



This message will only be displayed if the Calendar Option is installed in the printer.

The Calendar is an optional feature in CL608e/CL612e printers allowing the date and time to be set manually using the LCD Display or via the <ESC>WT Calendar Set command. The last setting, set either manually via software command, received by the printer will be the value used. The format of the display is YY/MM/DD hh:mm (Year/Month/Day/ hours:minutes). The date format is fixed and cannot be changed.

To enable the Calendar feature (if installed), press the **LINE** key until the underline cursor is beneath the YES. If the Calendar feature is to be disabled, press the **LINE** key until the cursor is underneath the NO. When the desired setting is selected, Press the **FEED** key.

LCD Panel — Advanced Mode**Set Calendar
(Continued)**

Calendar
00/00/00 00:00

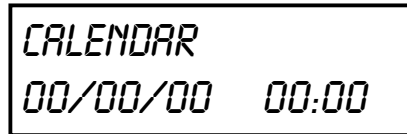

STEP	PROCEDURE
1.	Year - The first display shown will have the two digit year selection underlined. You can scroll through the dates by pressing the LINE key. The year number will increase by one each time the LINE key is pressed until it reaches its maximum legal value (i.e., "99" for the year digits) at which point it will wrap around to the "00" setting.
2.	Month - After you have set the correct year, pressing the FEED key will advance the underline cursor to the two digit Month position. You can scroll through the numbers corresponding to the month by pressing the LINE key. The month number will increase by one each time the LINE key is pressed until it reaches a value of "12" at which point it will wrap around to the "01" setting.
3.	Day - After you have set the correct month, pressing the FEED key will advance the underline cursor to the two digit Day position. You can scroll through the numbers corresponding to the month date by pressing the LINE key. The date number will increase by one each time the LINE key is pressed until it reaches a value of "31" at which point it will wrap around to the "01" setting.
4.	Hour - After you have set the correct date, pressing the FEED key will advance the underline cursor to the two digit Hour position. You can scroll through the numbers corresponding to the hour (using a 24 hour clock) by pressing the LINE key. The hour number will increase by one each time the LINE key is pressed until it reaches a value of "24" at which point it will wrap around to the "01" setting.
5.	Minute - After you have set the correct hour, pressing the FEED key will advance the underline cursor to the two digit Minute position. You can scroll through the numbers corresponding to the hour by pressing the LINE key. The minute number will increase by one each time the line key is pressed until it reaches a value of "60" at which point it will wrap around to the "01" setting.
6.	After you have set the minutes, pressing the FEED key will accept the setting and advance to the Ignore CR/LF selection.

LCD Panel — Advanced Mode

Ignore CR/LF

```

IGNORE CR/LF
  YES    NO
  
```

This setting tells the printer to strip out all carriage return/line feed pairs (CRLF) from the data stream, including graphics and 2D bar codes. It is used primarily to maintain compatibility with earlier models of SATO printers.

STEP	PROCEDURE
1.	Use the LINE key to step the underlined cursor to either YES or NO.
2.	Once the desired setting is underlined, press the FEED key to accept the setting and advance to the Character Pitch display.

Character Pitch

```

CHARACTER PITCH
  PROP    FIXED
  
```

This setting allows you to set the default character pitch to either fixed character spacing or proportional character spacing.

STEP	PROCEDURE
1.	Use the LINE key to step the underlined cursor to the desired setting.
2.	Once the desired setting is underlined, press the FEED key to accept the setting and return to the Advance Mode screen.

Note: This command can be overridden by the <ESC>PR or <ESC>PS Character Pitch Commands.

Exit Advanced Mode

```

ADVANCED MODE
  
```

To exit the Advanced mode, power off the printer then back on.

LCD Panel —Card Mode

The Card Mode allows the operator to manage the Expanded Memory (PCMCIA Card or Internal Expanded Flash ROM). The Card Mode is entered from the Advanced Mode display by pressing the **LINE** key once.

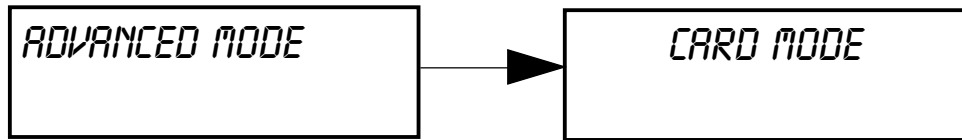

The Card Mode display indicates that the printer is in the Card Mode. To advance to the Mem Select (CC1), press the **FEED** key.

Mem Select (CC1)

```

MEM SELECT (CC1)
CARD MEMORY
  
```

This selection determines which type of optional expanded memory will be addressed as "CC1" in the command streams. The CARD selection specifies the optional PCMCIA card as CC1 and the optional Expanded Flash ROM as CC2. The Memory selection specifies the optional Expanded Flash ROM as CC1 and the optional PCMCIA card as CC2.

STEP	PROCEDURE
1.	Use the LINE key to step the cursor to the desired setting (Card or Memory).
2.	Once the desired setting is underlined, press the FEED key to accept the setting and advance the display.

LCD Panel — Card Mode

Card ->MemoryCopy
TrueTypeFont Y/N

```
CARD ->MEMORYCOPY
TRUETYPEFONT Y/N
```

This selection allows you to copy TrueType fonts from the PCMCIA Memory card installed in the Memory Card slot (on the rear of the printer) to the optional Flash ROM.

STEP	PROCEDURE
1.	<p>Use the LINE key to step the underlined cursor to the desired setting. IF Yes is selected, the printer will enter the Card Copy mode.</p> <p>If No is selected, the display will advance to <i>Card to Memory Copy SATO Font</i> mode. Press the FEED key to accept the selection and advance the display.</p>
2.	<p>Confirm your selection by stepping the underline cursor to the Yes selection. If you select No, the display will return to the previous selection.</p>
	<pre>COPY START YES NO</pre>
3.	<p>Press the FEED key to accept the selection. If Yes was selected, the copy process will start.</p>
	<pre>TRUETYPEFONTCOPY COPYING</pre>
4.	<p>Once the copy process is completed, press the FEED key to advance the display.</p>
	<pre>TRUETYPEFONTCOPY COMPLETED</pre>
5.	<p>If an error is encountered in the copy process, one of the following messages will be displayed on the second line.</p>
	<pre>CARD COPY/FORMAT XXXXXXX ERROR</pre>
	<p>R/W Error Indicates a Read/Write error occurred No Card Error Indicates no card was recognized Mem Full Error Indicates that there is insufficient memory available</p>



LCD Panel — Card Mode

Card ->MemoryCopy
SatoFont Y/N



CARD ->MEMORYCOPY
 SATOFONT Y/N

This selection allows you to copy SATO fonts from the PCMCIA Memory card installed in the Memory Card slot (on the rear of the printer) to the optional Flash ROM.

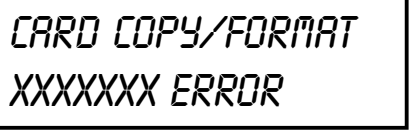
STEP	PROCEDURE
1.	<p>Use the LINE key to step the underlined cursor to the desired setting. IF Yes is selected, the printer will enter the Card Copy mode.</p> <p>If No is selected, the display will advance to Card->MemoryCopy All mode. Press the FEED key to accept the selection and advance the display.</p>
2.	<p>Confirm your selection by stepping the underline cursor to the Yes selection. If you select No, the display will return to the previous selection.</p>
	 <p>COPY START YES NO</p>
3.	<p>Press the FEED key to accept the selection. If Yes was selected, the copy process will start.</p>
	 <p>SATO FONT COPY COPYING</p>
4.	<p>Once the copy process is completed, press the FEED key to advance the display.</p>
	 <p>SATO FONT COPY COMPLETED</p>
5.	<p>If an error is encountered in the copy process, one of the following messages will be displayed on the second line.</p>
	 <p>CARD COPY/FORMAT XXXXXXXX ERROR</p>
	<p>R/W Error Indicates a Read/Write error occurred No Card Error Indicates no card was recognized Mem Full Error Indicates that there is insufficient memory available.</p>

LCD Panel — Card Mode

Card ->MemoryCopy
All Y/N

```
CARD ->MEMORYCOPY
ALL      Y/N
```

This selection allows you to copy the entire contents from PCMCIA Memory card installed in the Memory Card slot on the rear of the printer to the optional internal Expanded Memory.

STEP	PROCEDURE
1.	<p>Use the LINE key to step the underlined cursor to the desired setting. IF Yes is selected, the printer will enter the Card Copy mode.</p> <p>If No is selected, the display will advance to Card->MemoryCopy All mode.</p>
2.	<p>Confirm your selection by stepping the underline cursor to the Yes selection. If you select No, the display will return to the previous selection.</p> <pre>COPY START YES NO</pre>
3.	<p>Press the FEED key to accept the selection. If Yes was selected, the copy process will start.</p> <pre>CARD -> MEMORY COPYING</pre>
4.	<p>Once the copy process is completed, press the FEED key to advance the display.</p> <pre>CARD ->MEMORY COMPLETED</pre>
5.	<p>If an error is encountered in the copy process, one of the following messages will be displayed on the second line.</p> <pre>CARD COPY/FORMAT XXXXXXXX ERROR</pre> <p>R/W Error Indicates a Read/Write error occurred No Card Error Indicates no card was recognized Mem Full Error Indicates that there is insufficient memory available</p>

LCD Panel — Card Mode

Memory->Card Copy
All <XMB> Y/N

```
MEMORY ->CARDCOPY
ALL      <XMB> Y/N
```

This selection allows you to copy the entire contents of the optional Expanded Memory to the PCMCIA Memory card installed in the Memory Card slot on the rear of the printer.

STEP	PROCEDURE
1.	<p>Use the LINE key to step the underlined cursor to the desired setting. IF Yes is selected, the printer will enter the Card Copy mode.</p> <p>If No is selected, the display will advance to Card->MemoryCopy All mode.</p>
2.	<p>Confirm your selection by stepping the underline cursor to the Yes selection. If you select No, the display will return to the previous selection.</p> <div data-bbox="834 898 1243 1031" style="border: 1px solid black; padding: 5px; margin: 10px auto; width: fit-content;"> <pre>COPY START YES NO</pre> </div>
3.	<p>Press the FEED key to accept the selection. If Yes was selected, the copy process will start.</p> <div data-bbox="834 1108 1243 1241" style="border: 1px solid black; padding: 5px; margin: 10px auto; width: fit-content;"> <pre>MEMORY-> CARD COPY COPYING</pre> </div>
4.	<p>Once the copy process is completed, press the FEED key to advance the display.</p> <div data-bbox="834 1335 1243 1467" style="border: 1px solid black; padding: 5px; margin: 10px auto; width: fit-content;"> <pre>MEMORY-> CARD COPY COMPLETED</pre> </div>
5.	<p>If an error is encountered in the copy process, one of the following messages will be displayed on the second line.</p> <div data-bbox="834 1598 1243 1730" style="border: 1px solid black; padding: 5px; margin: 10px auto; width: fit-content;"> <pre>CARD COPY/FORMAT XXXXXXXX ERROR</pre> </div> <p>R/W Error Indicates a Read/Write error occurred No Card Error Indicates no card was recognized Mem Full Error Indicates that there is insufficient memory available</p>

LCD Panel — Card Mode

**Card->Memory Copy
Program Y/N**

```

CARD ->MEMORYCOPY
PROGRAM   Y/N
    
```

This selection allows you to copy printer firmware from the PCMCIA Memory card to the printer.

STEP	PROCEDURE
1.	Use the LINE key to step the underlined cursor to the desired setting. IF Yes is selected, the printer will enter the Card Copy mode. If No is selected, the display will advance to the mode display.
2.	Confirm your selection by stepping the underline cursor to the Yes selection. If you select No, the display will return to the previous selection.
	<pre> COPY START YES NO </pre>
3.	Press the FEED key to accept the selection. If Yes was selected, the copy process will start.
	<pre> CARD-> MEMORY COPY COPYING </pre>
4.	Once the copy process is completed, press the FEED key to advance the display.
	<pre> CARD-> MEMORY COPY COMPLETED </pre>
5.	If an error is encountered in the copy process, one of the following messages will be displayed on the second line.
	<pre> CARD COPY/FORMAT XXXXXXX ERROR </pre>
	<p>R/W Error Indicates a Read/Write error occurred No Card Error Indicates no card was recognized Mem Full Error Indicates that there is insufficient memory available</p>

LCD Panel — Card Mode

Memory->Card Copy Program Y/N

```
MEMORY->CARDCOPY
PROGRAM   Y/N
```

This selection allows the user to copy the current firmware installed in the printer to a PCMCIA Memory Card.

STEP	PROCEDURE
1.	Use the LINE key to step the underlined cursor to the desired setting. IF Yes is selected, the printer will enter the Card Copy mode. If No is selected, the display will advance to the mode display.
2.	Confirm your selection by stepping the underline cursor to the Yes selection. If you select No, the display will return to the previous selection.
	<pre>COPY START YES NO</pre>
3.	Press the FEED key to accept the selection. If Yes was selected, the copy process will start.
	<pre>MEMORY-> CARD COPY COPYING</pre>
4.	Once the copy process is completed, press the FEED key to advance the display.
	<pre>MEMORY-> CARD COPY COMPLETED</pre>
5.	If an error is encountered in the copy process, one of the following messages will be displayed on the second line.
	<pre>CARD COPY/FORMAT XXXXXXX ERROR</pre>
	<p>R/W Error Indicates a Read/Write error occurred No Card Error Indicates no card was recognized Mem Full Error Indicates that there is insufficient memory available</p>

LCD Panel — Card Mode

Card Format
Yes No



Before a PCMCIA card can be used, it must be formatted.

Note: Formatting a card destroys all data currently stored on the Card.

STEP	PROCEDURE
1.	Use the LINE key to step the underlined cursor to the desired setting. IF Yes is selected, the printer will enter the Card Format mode. If No is selected, the display will advance to the mode display.

Memory Format
Yes No



Before the internal Expanded Memory can be used, it must be formatted.

Note: Formatting the memory will destroy any stored data.

STEP	PROCEDURE
1.	Use the LINE key to step the underlined cursor to the desired setting. IF Yes is selected, the printer will enter the Memory Format mode. If No is selected, the display will advance to the mode display.

To exit the Card Mode, power off the printer, then back on.



LCD Panel — Service Mode

The Service Mode allows the operator to set up the basic operation parameters of the printer and is entered from the Advanced Mode.

To Enter Advanced Mode:

STEP	PROCEDURE
1.	<p>Press the LINE key while simultaneously turning the power on. When the printer emits one long beep, release the LINE key to display the first screen.</p> <div style="text-align: center; border: 1px solid black; padding: 5px; width: fit-content; margin: 10px auto;">ADVANCED MODE</div>
2.	<p>Press the LINE key twice to enter the Service Mode.</p> <div style="text-align: center; border: 1px solid black; padding: 5px; width: fit-content; margin: 10px auto;">SERVICE MODE</div> <p>The Service Mode display indicates that the printer is in the Service Mode. To advance to the first selection, press the FEED key.</p>

Gap [X.XV]
Input [X.XV}

GAP [X.XV]
INPUT [X.XV}

The CL608/CL612e printers determine the location of the leading edge of the label by measuring the difference between light levels when it sees either a label gap or a black "EYE" mark. This adjustment allows you to manually set the threshold voltage level between the maximum and minimum light levels. DIP switch DSW2-2 selects the sensor type. If DSW2-2 is in the OFF position, the setting will be for a See-Thru (or Gap) sensor and the LCD will display "GAP" on the top line along with the current setting. If DSW2-2 is in the ON position, the LCD will display "EYE" on the top line with its current setting. If the value entered for the bottom line setting is "0.0V", then the printer will automatically calculate the setting when the first label is fed after the printer is powered on or the head is closed. There are some instances where the automatically calculated value must be adjusted to ensure reliable label feeding, such as when the backing opacity or the reflectance of the "EYE" mark varies significantly within a roll of labels or between label rolls. In these instances the value should be set using the following procedures.

LCD Panel — Service Mode

Gap [X.XV]
 Input [X.XV}

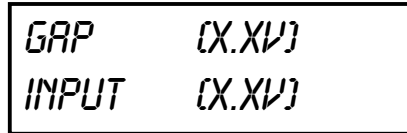

GAP - When setting the "GAP" threshold, the voltage shown on the top line of the display must be measured with nothing but the backing in the sensor and then again with a label still attached to the backing. The formula to be used for setting the threshold is:

$$(\text{High Voltage Level} + \text{Low Voltage Level}) \times 0.5 = \text{Start Value}$$

STEP	PROCEDURE
1.	Insert a label still attached to the backing into the sensor and close the Label Hold-Down. Record the voltage shown on the top line of the LCD panel. This line should have the message "GAP" on the top line (DIP switch DSW2-2 = OFF). Make sure the label is all the way under the sensor.
2.	Strip the label from the backing and insert the backing strip under the sensor and close the Label Lid. Record the voltage shown on the top line of the LCD panel. The voltage ranges measured should be within the following range. <p style="text-align: center;"> Backing without label = 0.5V or less Backing with label = 1.0V >/- the low value </p> If the measured values are outside this range, you may have trouble finding a value that will work properly under all conditions. If this is the case, a higher quality label may be needed to get adequate performance.
3.	Calculate the starting point voltage using the formula.
4.	Use the LINE key to step the counter to the desired setting. The display will increment one step for each time the LINE key is pressed. If the LINE key is held down for more than two seconds, it will automatically go into the fast scroll mode. The reading will advance to a setting of 3.3 (the maximum voltage) after which it will automatically wrap and start at "0.0" again. If a value of "0.0" is set, the printer will automatically set the level each time the printer is powered on with labels loaded or the head is closed.
5.	Once the setting is correct, pressing the FEED key will accept the setting and advance to the Online Feed display.

LCD Panel — Service Mode

Eye [X.XV]
Input [X.XV}

EYE	[X.XV}
INPUT	[X.XV}

EYE - When setting the "EYE" threshold, the voltage must be measured with nothing but the label under the sensor and then again with the printed "eye" mark under the sensor. The formula to be used for this is:

(High Voltage Level + Low Voltage Level) x 0.5 = Start Value

STEP	PROCEDURE
1.	Insert a label into the sensor and close the Label Hold-Down. Make sure the printed "eye" mark is not under the sensor. Record the voltage shown on the top line of the LCD panel. This line should have the message "EYE" on the top line (DIP switch DSW2-2 = ON).
2.	Now pull the label forward until the "eye" mark is positioned under the sensor (the voltage reading should be at its highest point). Record the voltage shown on the top line of the LCD panel. The voltage ranges measured should be within the following ranges: <p style="text-align: center;">Label Only = 0.3 - 0.5V Eye-mark = Equal to or greater than 1.2V above the low value.</p> <p>If the measured values are outside this range, you may have trouble finding a value that will work properly under all conditions. If this is the case, a higher quality label may be needed to get adequate performance.</p>
3.	Calculate the starting point voltage using the formula.
4.	Use the LINE key to step the counter to the desired setting. The display will increment one step for each time the LINE key is pressed. If the LINE key is held down for more than two seconds, it will automatically go into the fast scroll mode. The reading will advance to a setting of 3.3 (the maximum voltage) after which it will automatically wrap and start at "0.0" again. If a value of "0.0" is set, the printer will automatically set the level each time the printer is powered on with labels loaded or the head is closed.
5.	Once the setting is correct, pressing the FEED key will accept the setting and advance to the Auto Online Feed display.

LCD Panel — Service Mode

Auto Online Feed
Yes No

AUTO ONLINE FEED YES NO

This selection specifies whether or not the printer will automatically feed a blank label when it is placed in the Online mode.

STEP	PROCEDURE
1.	Use the LINE key to step the underlined cursor to the desired setting. IF Yes is selected, the printer will feed a blank label anytime it enters the Online mode. If No is selected, the display will advance to the mode display.

Feed on Error
Yes No

FEED ON ERROR YES NO

This selection specifies whether or not the printer will feed a blank label automatically when an error condition is cleared.

STEP	PROCEDURE
1.	Use the LINE key to step the underlined cursor to the desired setting. IF Yes is selected, the printer will feed a blank label anytime an error condition is cleared. If No is selected, the display will advance to the mode display.

Reprint W/Feed
Yes No

REPRINT W/FEED YES NO

This selection specifies whether or not the printer will print the last printed label stored in memory when the FEED key is pressed in the Normal Online mode.

STEP	PROCEDURE
1.	Use the LINE key to step the underlined cursor to the desired setting. IF Yes is selected, the printer will reprint the last label when the FEED key is pressed when the printer is Online. If the printer is Offline, pressing the FEED key will feed a blank label. If No is selected, the display will advance to the mode display.

LCD Panel — Service Mode

Forward/Backfeed Distance Default

```
FORWARD/BACKFEED
DISTANCE  DEFAULT
```

This display will only appear when Backfeed is enabled (DSW3-4 = OFF). The maximum backfeed distance is 255mm.

STEP	PROCEDURE
1.	Press the FEED key to use the default distance. This setting will be appropriate for use with standard labels with a 1/8" gap between labels and most tag stock applications.
2.	Press the LINE key to set your own backfeed distance up to 255mm. Each time you press the LINE key, the distance is advanced 1mm. <u>CAUTION:</u> A backfeed distance over 40mm may cause ribbon wrinkle and require ribbon tension adjustments.
	<pre>FORWARD/BACKFEED DISTANCE XXXMM</pre>
3.	Press the FEED key to accept the selected backfeed distance.

Ext Port Pin 9 Select

```
EXT  PIN9  SELECT
MODE 1    MODE2
```

This selection allows user selection of when Pin #9 of the 14 pin EXT connector goes HIGH, to allow printer status to be determined without using Bi-Directional Communication Select Mode1 or Mod2, using the Line key. Press **FEED** key to save and exit.

MODE 1 = On-Line print job waiting.

MODE 2 = On-Line

LCD Panel — Service Mode

Euro Code
D5

EURO CODE
D5

This selection allows the user to specify the hexadecimal code for the character which is replaced with the Euro Character. The default is D5 Hex.

STEP	PROCEDURE
1.	The underline cursor should be positioned underneath the first digit selection. Use the LINE key to step to the desired setting.
2.	Press the FEED key to advance the underline cursor to the second digit of the desired hexadecimal code.
3.	Press the LINE key to step to the desired setting.
4.	When the setting is correct, press the FEED key to accept the setting and advance to the next display.

Select LCD Display
Language

SELECT LANGUAGE
ENGLISH

This selection allows the user to select the language used in the LCD menu and error messages. The selections are English, French, German, Spanish, Italian and Portuguese.

STEP	PROCEDURE
1.	Press the LINE key to advance to the desired language setting.
2.	When the setting is correct, press the FEED key to accept the setting and advance to the next display.

LCD Panel — Service Mode

Priority Setting LCD Command

```
PRIORITY SETTING
LCD COMMAND
```

This selection allows the user to assign a priority for Print Darkness, Print Speed and Print Offset.

STEP	PROCEDURE
1.	Use the LINE key to step to the desired priority. If LCD is selected, the setting established via the LCD display/menu system will be used for an incoming label job, regardless of any different command settings. If Command is selected, any commands in the label job will take precedence and be used for printing the job and the LCD Display will reflect the new setting.
2.	Once the desired setting is selected, press the FEED key to accept the setting and advance to the next display.

```
IGNORE      CAN/DLE
YES         NO
```

This function allows the user to disable:

<DLE> (Hex 10) the print stop command and

<CAN> (Hex 18) the cancel command.

Used for compatibility with some third party hardware and software. It is only displayed and functional when RS-232C HS serial interface is installed and configured for Status 4 Bi-direction operation.

```
RIBBON NEAR END
ENABLE      DISABLE
```

This function is only displayed when a RS232 HS serial interface card is installed and configured for Status 3 Bi-direction operation. The disable function was added for compatibility with older non "e" version printers, where ribbon near end was not reported. Use the **LINE** key to select Enable or Disable and press **FEED** to save and exit.

Service Mode



```
SERVICE MODE
```

To exit the Service Mode power the printer off, then back on.

LCD Panel — Counters Mode

The Counters Mode is provided to allow the user to access the internal printer counters and is entered from the Advanced Mode.

To Enter Advanced Mode:

STEP	PROCEDURE
1.	Press the LINE key while simultaneously turning the power on. When the printer emits one long beep, release the LINE key to display the first screen.
	
2.	Press the LINE key 3X to advance to the Counters Mode.
	
3.	Press the FEED key to advance the display to the counters selections.

Counters

HD DSP CUT LIFE

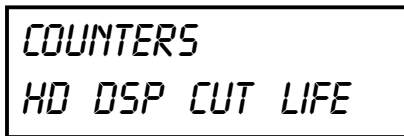

The counters are identified in the display as:

HD: Head Counter (should be reset when print head is replaced)

DSP: Dispense Counter

CUT: Cutter Counter

LIFE: Life Counter (cannot be reset)

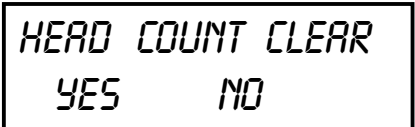
STEP	PROCEDURE
1.	Use the LINE key to step the underlined cursor to the desired counter, the Head (HD) counter or the LIFE counter. The default position is the Head Counter.
2.	Press the FEED key to display the current value (in meters) stored in the counter.
	
3.	Press the FEED key to advance to the next screen.
	

LCD Panel — Counters Mode

STEP	PROCEDURE
4.	<p>Use the FEED key to select the desired setting. If you only want to read the counter value, select NO. If you want to read the counter and reset it to 0.0, place the underline cursor under YES. Once the desired setting is selected, press the FEED key to return to the Counter Mode display.</p> <div style="text-align: center; border: 1px solid black; padding: 5px; width: fit-content; margin: 10px auto;"> <p>COUNTERS MODE</p> </div> <p>To exit the Counters Mode power the printer off, then back on.</p>

Test Print Mode

The Test Print Mode offers four different printer status labels for troubleshooting. If DSW3-5 is ON, the Test Print cycle must be initiated with a Print Start command.

Test Print Mode Configuration

TEST PRINT MODE
CONFIGURATION

This option allows you to print a test label. It is recommended that you print a test label after you have changed any of the settings in the Advanced Mode. The test label allows you to verify that you indeed did make the desired changes.

To enter the User Test Print Mode:

STEP	PROCEDURE
1.	Power on the printer while pressing the FEED key. Release the FEED key and the printer will display the Test Print Mode message on the LCD panel.
2.	<p>Use the LINE key to step the underline cursor to the type of test label you wish to print. The choices are:</p> <ul style="list-style-type: none"> Configuration Bar Code Head Check Memory Factory <p style="text-align: right;">See last pages in this section for test label sample print-outs</p>
3.	Once you have selected the type of test label to be printed, use the FEED key to accept the selection and advance to the Test Print Size display. This display allows you to select the label width.

LCD Panel — Test Print Mode

Test Print Size
10 CM

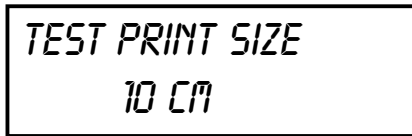

NOTE: This display does not appear when a Memory Test Print is chosen. Only a small Memory Test Print can be printed.

Once you have selected the type of test label to be printed, use the **FEED** key to accept the selection and the display advances to the Test Print Size display. This display allows you to select the label width.

STEP	PROCEDURE
1.	Use the LINE key to select the label width. Each time the LINE key is pressed, the label size advances 1 cm until it reaches a maximum width of 10 cm at which point it will wrap to the smallest size of 4 cm.
2.	Press the LINE key to accept the selection.
3.	Press the FEED key to start printing test labels continuously.
4.	Press the FEED key to stop the printer.



To exit the Test Print Mode, power the printer off, then back on.

Default Setting Mode

Occasionally it is desirable to reset all printer configuration settings to their original default conditions. This allows the operator to start the reconfiguration of the printer starting from a known set of conditions.

Default Setting Mode

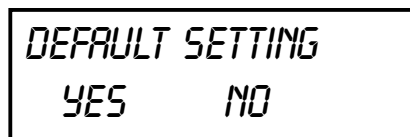

To enter the Default Setting Mode press the **FEED** key while simultaneously powering on the printer. When the printer emits one long beep release the **FEED** and **LINE** keys.

STEP	PROCEDURE
1.	Use the LINE key to select either YES or NO.
2.	Once the desired setting is selected, press the FEED key to accept the selection and the printer will reset to the original default conditions.
3.	When the printer has completed the reset process, the Default Setting Completed display will appear. The printer is now in the default configuration.

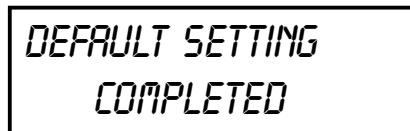





To exit the Default Setting Mode, power the printer off, then back on.

LCD Panel — Maintenance Mode — Factory Mode

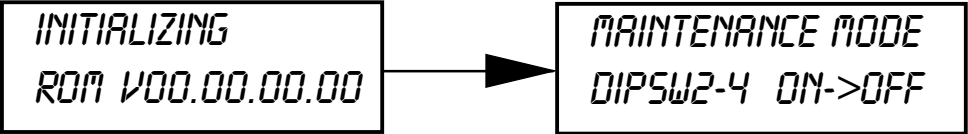
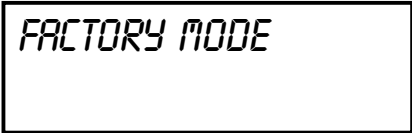
This function is used to clear counters and reset the printer's firmware.



This procedure is used after upgrading the flash firmware or installing a new memory module.

STEP	PROCEDURE
1.	Record all current dip switch positions, then place all switches in the OFF position.
2.	Place the DSW2-4 in the ON or up position.
3.	Press the LINE and FEED key while simultaneously turning ON the power switch. When the printer beeps, release the keys. The following screens will appear.
	
4.	Place the DSW2-4 in the OFF position and the following screen will appear.
	
5.	Press the FEED key to display the next screen.
	
6.	Press the LINE key once to change the message to the proper selection.
	The counters are identified in the display as:
	HD: Head Counter (should be reset only when a print head is replaced).
	DSP: Dispense Counter - meters of label stock dispensed.
	CUT: Cutter Counter - number of cutter cycles.
	LIFE: Life Counter (cannot be reset) meters of label stock run through the printer.
	ALL: Clears all counters and resets firmware and returns printer to factory default setting. This setting is used when upgrading firmware.
	
7.	Press the FEED key to clear the selected function. After a pause, the next screen will appear.
	
8.	Select the print label size by pressing the LINE key. The default is LARGE.
9.	Press the FEED key for a test print. Press the FEED key again to stop printing.
	

LCD Panel — Maintenance Mode

All Clear Mode

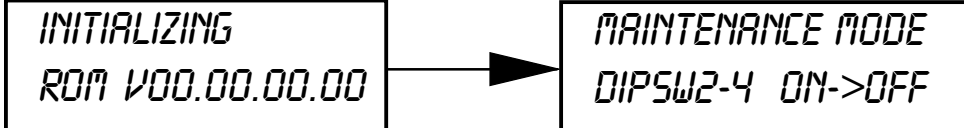
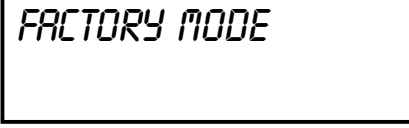
This function is used to clear counters and reset the firmware and doesn't produce a test label.

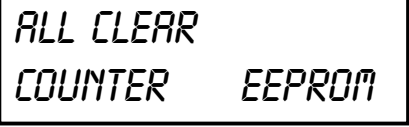
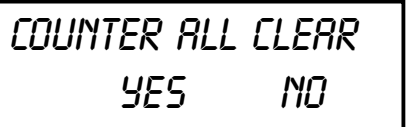
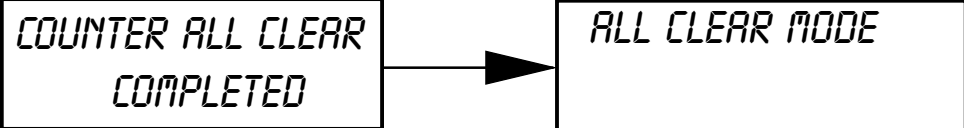
STEP	PROCEDURE
1.	Record all current dip switch positions, then place all switches in the OFF position.
2.	Place the DSW2-4 in the ON or up position.
3.	Press the LINE and FEED key while simultaneously turning ON the power switch. When the printer beeps, release the keys. The following screens will appear.
	
4.	Place the DSW-4 in the OFF position and the following screen will appear.
	
5.	Press the LINE key to display the next screen.
	
6.	Press the FEED key to display the next screen.
	
7.	Press the LINE key to select either COUNTER or EEPROM. Select Counter to clear all counters. Select EEPROM to clear/reset the firmware to factory default setting
8.	Press the FEED key to display the next screen.
	
9.	Press the LINE key to select YES or NO . If YES is selected press the FEED key to clear your selection.
	
10.	The printer will beep three times signaling the completion of the process.
11.	Power off the printer to exit Maintenance Mode.

LCD Panel — Clear Non-Standard Protocol

The standard protocol codes used by the printer can be modified to accommodate the requirements of different host systems. However, if the printer is to be used with a system that does not use the custom protocol codes, they can be cleared and the default protocol codes reactivated.

The default values are:

STX = 7B_H, ETX = 7D_H, ESC = 5E_H, ENQ = 40_H, NULL = 7E_H,
CAN = 21_H and OFFLINE = 5D_H.

Alt. Protocol
Default Complete

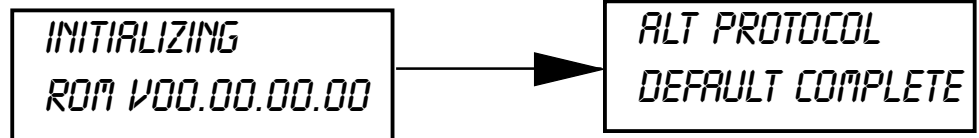

To Clear Non-Standard protocol codes, place **DSW2-7** in the **ON** position and power on the printer while simultaneously pressing the **LINE** and **FEED** keys.

STEP	PROCEDURE
1.	When the printer emits one long beep release the LINE and FEED keys.
2.	When the keys are released, the printer will replace the Alternate protocol codes with the default values.
3.	After the default setting is complete, the printer will emit three short beeps indicating that the process is complete. To exit the mode, power the printer off, then back on.

Download User Defined Protocol Codes

The user can define a set of custom protocol codes and download them to the printer using the <ESC>LD command.

User Download
Press the Line Key

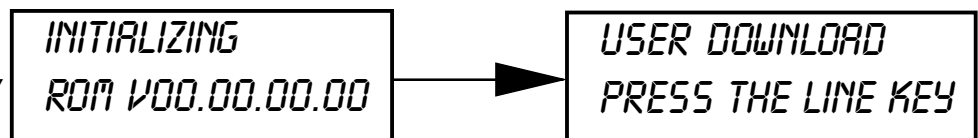

To enter the User Download mode, place DSW2-7 in the **ON** position and power on the printer while simultaneously pressing the **LINE** key. When the printer emits one long beep release the **LINE** key.

STEP	PROCEDURE
1.	Set DSW2-7 to the OFF position to replace the Standard protocol codes or ON to replace the Alternate set of protocol codes.
2.	Press the LINE key. The printer is now waiting for the data to be sent.

USER DOWNLOAD
WAITING

LCD Panel — Download User Defined Protocol Codes

User Download Press the Line Key (Continued)

STEP	PROCEDURE
3.	Transmit the download data command stream to the printer.
4.	After the data has been received, the printer will beep and print a status label. If it does not beep and print a status label, the printer did not accept the data.
5.	If the printer did not beep and print a status label, turn the printer off and check you data stream for errors and start the download process over.
6.	If the custom codes are correct, press the FEED key to accept them and terminate the download process. If they are incorrect, turn the printer off without pressing the FEED key and begin the process again.

Refer to the Operator and Technical Reference Manual for the data stream command structure required.

Hex Dump Mode

In addition to the User Test Print Labels, the printer can print the contents of the receive buffer in a hexadecimal format to allow the data stream to be examined for errors and troubleshooting.

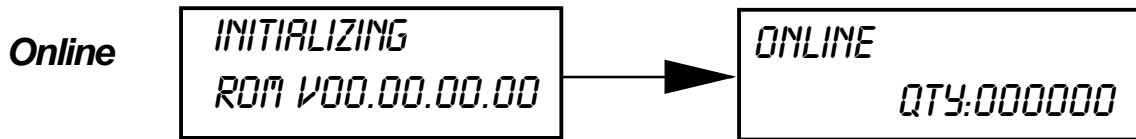

To enter the Hex Dump mode, place **DSW2-4** in the **ON** position and power on the printer.

STEP	PROCEDURE
1.	The printer is now ready to receive data.
2.	Send the data stream to the printer.
3.	The receive data will be printed in a hexadecimal format.
4.	To return the printer to normal position, place DSW2-4 in the OFF position and power the printer OFF and then back ON.

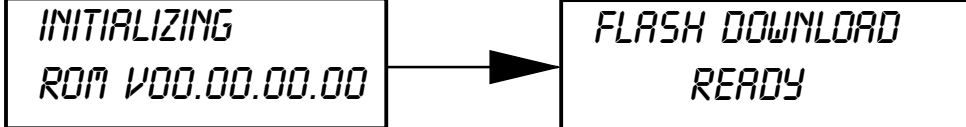

LCD Panel —Firmware Download Mode

STEP	PROCEDURE
1.	Record all current dip switch positions, then place all switches in the OFF position.
2.	Place the DSW2-6 in the ON or up position.
3.	Turn ON the power switch. The following screens will appear.
<div style="text-align: center;">  <pre> graph LR A["INITIALIZING ROM V00.00.00.00"] --> B["FLASH DOWNLOAD READY"] </pre> </div>	

Refer to the specific instructions provided with the flash firmware files provided by SATO America Technical Support or downloaded from the SATO America Web Site.

www.satoamerica.com

Section 3

Interface Specifications

3.1 Overview

This section presents the interface specifications for the CL608e/CL612e printers.

CL608e/CL612e printers utilize a Plug-In Interface Module for maximum printer configuration flexibility.

The following information is presented in this section.

- Interface Types
- The Receive Buffer
- IEEE1284 Parallel Interface
- RS232C Serial Interface
- BI-Directional Communications using the RS232C Serial Interface
- Universal Serial BUS (USB)
- Local Area Network (LAN)
- Ext Connector

3.2 Interface Types

The parallel interface for CL608e/CL612e printers is a high speed, bi-directional parallel interface that conforms to the IEEE 1284 specification. (ECP mode on some computers). The interface is also compatible with the older Centronics parallel interface standard. If it does not detect the correct IEEE 1284 signals in the interface connection, it will automatically operate in the standard Centronics mode which is much slower. To use the IEEE 1284 parallel interface to its fullest capability requires that the host also have an IEEE 1284 compatible interface and that the two be connected with a cable that meets the IEEE 1284 specification. If either of these two are not present, the data rate is severely compromised.

Interface Types

In order to provide flexibility in communicating with a variety of host computer systems, CL608e/612e printers use a Plug-In Interface Module. The IEEE1284 Interface module is shipped with the printer unless another interface type is specified at the time of the order. The other interfaces available are a high speed (to 57.6K bps) serial interface, an Ethernet interface or an optional Universal Serial Bus (USB) interface.

The Parallel interface will probably be the most useful in communicating with IBM PCs and compatibles. The RS232C Serial interface allows connectivity to a number of other hosts. The USB interface allows the printer to be connected to a computer that supports peripherals attached to a USB bus.

WARNING: Never connect or disconnect interface cables (or use a switch box) with power applied to either the host or the printer. This may cause damage to the interface circuitry in the printer/host and is not covered warranty.



**CENTRONICS
PARALLEL INTERFACE**



**RS232C SERIAL
INTERFACE**



USB INTERFACE



**ETHERNET
INTERFACE**

Available Interfaces

3.3 The Receive Buffer

The CL608e/CL612e printers have the ability to receive a data stream from the host in one of two ways. The receive buffer may be configured to accept one print job at a time or multiple print jobs. The single job print buffer is generally used by software programs that wish to maintain control of the job print queue so that it can move a high priority job in front of ones of lesser importance. The multiple job buffer on the other hand prints all jobs in the order they are received by the printer and the order of printing cannot be changed.

Single Job Buffer

The printer receives and prints one job at a time. Each job must not exceed 2.95MB.

Multi Job Buffer

The printer is able to continuously receive print jobs, compiling and printing other jobs at the same time. It acts much like a "print buffer" or maximize the performance of the host and the printer.

When using the RS232 Serial interface, the Multi Job Buffer uses either the **Ready/Busy** with **DTR** (pin 20) or **X-On/X-Off** flow control protocols. See these sections for more details. With an empty receiving buffer, the status of **DTR** is "high" (or an **X-On** status if using **X-On/X-Off**), meaning the printer is ready to receive data. When the receive buffer is holding 2.0MB of data (1MB from being full), **DTR** will go "low" (or an **X-Off** is sent) indicating the printer can no longer receive data. This condition is called "Buffer Near Full."

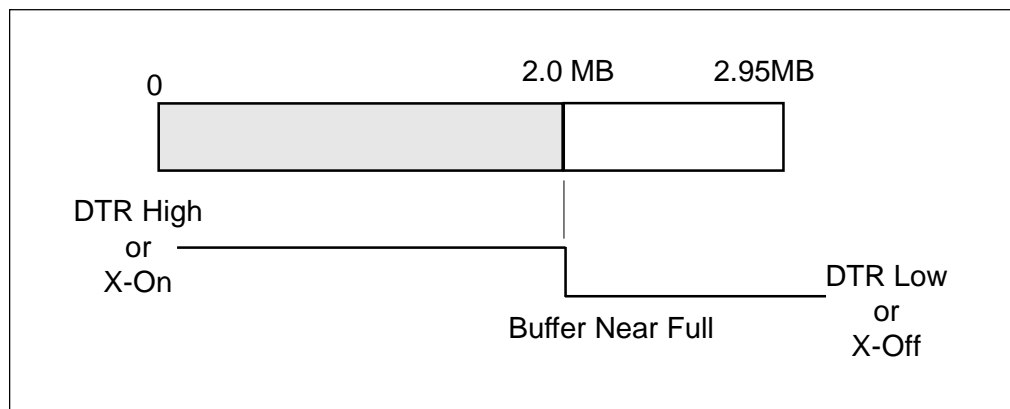

The receiving buffer will not be able to receive more data again until a "Buffer Available" condition occurs. This takes place when the receiving buffer has emptied so that only 1MB bytes of data are being held (2.0MB bytes from being full). At this time, DTR will go "high" or an X-On is sent to tell the host that it can again receive data.

The Receive Buffer

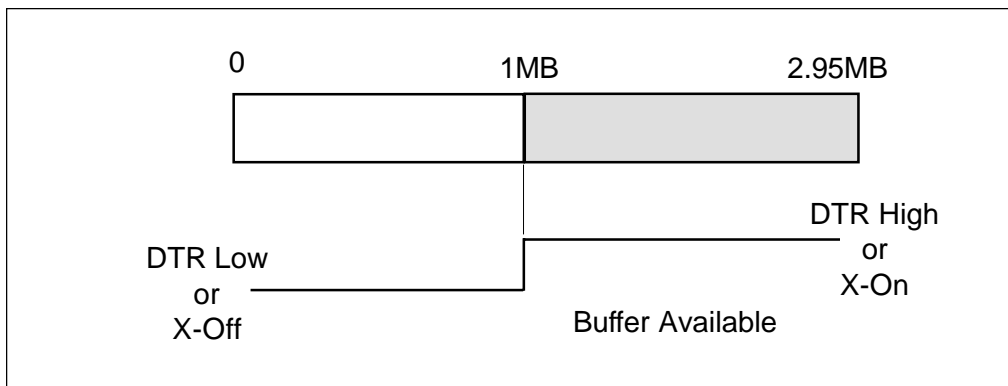

All printer error conditions (i.e., label out, ribbon out) will cause the printer to go busy (**DTR "low" or X-Off**) until the problem is corrected and the printer is placed online. The printer will also be busy if taken offline from the front panel.

3.4 IEEE 1284 Parallel Interface

The parallel interface for the CL608e/CL612e printers is a Plug-In Interface Module that can be installed by the user. It conforms to the IEEE 1284 specification. It will automatically detect the IEEE 1284 signals and operate in the high speed mode. If it does not detect the IEEE 1284 signals, it will operate in the standard Centronics mode, which is significantly slower. *For this reason, an interface cable and host interface conforming to the IEEE 1284 specification must be present to fully utilize the speed capabilities.* This interface also operates bi-directionally and can report the status of the printer back to the host.

Electrical Specifications:

Printer Connection	AMP 57-40360 (DDK) or equivalent
Cable Connection	AMP 57-30360 (DDK) or equivalent
Cable	IEEE1284 Parallel, 10 ft. (3 m) or less
Signal Level	High = +2.4V to +5.0V Low = 0V to -0.4V

Data Streams:

<ESC>A .. Job#1 .. <ESC>Z<ESC>A .. Job#n .. <ESC>Z

Please Note:

SATO does not recommend the use of mechanical data switches commonly called A/B switches, as they are known to damage both the computer and printer parallel ports.

IEEE 1284 Parallel Interface

PIN	SIGNAL	DIRECTION	PIN	SIGNAL	DIRECTION
1	STROBE	To Printer	19	STROBE Return	Reference
2	DATA 1	To Printer	20	DATA 1 Return	Reference
3	DATA 2	To Printer	21	DATA 2 Return	Reference
4	DATA 3	To Printer	22	DATA 3 Return	Reference
5	DATA 4	To Printer	23	DATA 4 Return	Reference
6	DATA 5	To Printer	24	DATA 5 Return	Reference
7	DATA 6	To Printer	25	DATA 6 Return	Reference
8	DATA 7	To Printer	26	DATA 7 Return	Reference
9	DATA 8	To Printer	27	DATA 8 Return	Reference
10	ACK	To Host	28	ACK Return	Reference
11	Busy	To Host	29	BUSY Return	Reference
12	Printer Error	To Host	30	PE Return	Reference
13	SELECT	To Host	31	INIT	From Host
14	AUTOFD ⁽¹⁾	To Host	32	FAULT	To Host
15	Not Used		33	Not Used	
16	Logic Gnd		34	Not Used	
17	FG	Frame Ground	35	Not Used	
18	+5V(Z=24K ohm)	To Host	36	SELECTION ⁽¹⁾	From Host

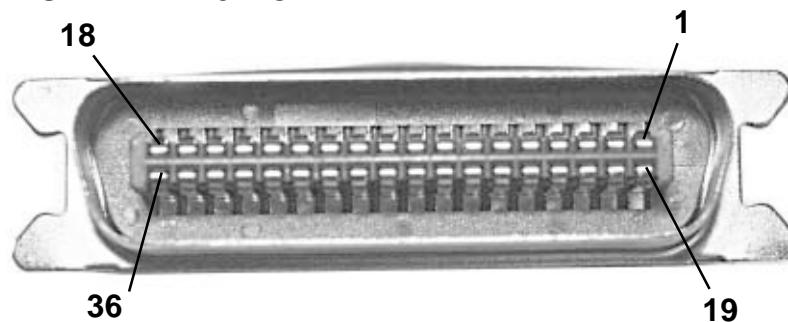
PIN ASSIGNMENTS - IEEE 1284 CABLE END

3.5 RS232C Serial Interface

The High Speed Serial Interface is a Plug-In Interface Module that can be installed in the printer by the user.

General Specifications:

Asynchronous ASCII Half-duplex communication
Ready/Busy Hardware Flow Control
Pin 20, DTR Control
Pin 4, RTS Error Condition
X-On/X-Off Software Flow Control
Bi-Directional Communication

Data Transmission Rate 9600, 19200, 38400, 57600 bps

Character Format 1 Start Bit (fixed)
7 or 8 data bits (selectable)
Odd, Even or No Parity (selectable)
1 or 2 Stop bits (selectable)

Electrical Specifications:

Connector DB-25S (Female)

Cable DB-25P (Male), 50 ft. maximum length. For cable configuration, refer to Cable Requirements appropriate to the RS232C protocol chosen.

Signal Level High = +5V to +12V
Low = -5V to -12V

PIN ASSIGNMENTS - RS232C PRINTER END



RS232C Serial Interface

Cable Requirements

DB9	DB25	HOST	INTERCONNECTION	DB25	PRINTER
1	1	FG	←→	1	FG (Frame Ground)
2	3	RD	←	2	TD (Transmit Data)
3	2	TD	→	3	RD (Receive Data)
8	5	CTS	←	4	RTS (Request to send)
7	4	RTS	→	5	CTS (Clear to Send)
4	20	DRT	→	6	DSR (Data Set Ready)
6	6	DSR*	←	20	DTR (Data Terminal Ready)
5	7	SG	←→	7	SG (Frame Ground)

* This connection at the host side of the interface would depend upon the pin that is being used as the Ready/Busy signal by the driving software. Typically on a PC, it would be either CTS (pin 5) or DSR (pin 6) on a DB-25 connector.

Please Note:

SATO does not recommend the use of mechanical data switches commonly called A/B switches, as they are known to damage both the computer and printer serial ports.

RS232C Interface Signals

PIN	DIRECTION	SIGNAL DESCRIPTION
1	Reference	FG (Frame Ground)
2	To Host	TD (Transmit Data) - Data from the printer to the host computer. Sends X-On/X-Off characters or status data (Bi-Directional protocol).
3	To Printer	RD (Receive Data) - Data to the printer from the host computer.
4	To Host	RTS (Request to Send) - Used with Ready/Busy flow control to indicate an error condition. RTS is high and remains high unless the print head is open (in this case, RTS would return to the high state after the print head is closed and the printer is placed back on-line) or an error condition occurs during printing (e.g. label out).
5	To Printer	CTS (Clear to Send) - When this line is high, the printer assumes that data is ready to be transmitted. The printer will not receive data when this line is low. If this line is not being used, it should be tied high (to pin 4).
6	To Printer	DSR (Data Set Ready) - When this line is high, the printer will be ready to receive data. This line must be high before data is transmitted. If this line is not being used, it should be tied high (to pin 20).
7	Reference	SG (Signal Ground)
20	To Host	DTR (Data Terminal Ready) - This signal applies to Ready/Busy flow control. The printer is ready to receive data when this pin is high. It goes low when the printer is off-line either manually or due to an error condition, and while printing in the Single Job Buffer mode. It will also go low when the data in the buffer reaches the Buffer Near Full level.

Ready/Busy Flow Control

Ready/Busy is the hardware flow control for the serial interface on the CL608e/CL612e printers. By raising/lowering the voltage level on Pin 20 of the RS232 port, the printer notifies the host when it is ready to receive data. Pin 4 (**RTS**) and pin 20 (**DTR**) are the important signals on the printer for this method of flow control. The host must be capable of supporting this flow control method for it to function properly.

X-On/X-Off Flow Control

X-On/X-Off flow control must be used whenever hardware (Ready/Busy) flow control is not available or desirable. Instead of a voltage going high/low at pin 20, control characters representing "Printer Ready" (**X-On** = 11 hexadecimal) or "Printer Busy" (**X-Off** = 13 hexadecimal) are transmitted by the printer on pin 2 (Transmit Data) to the host. In order for this method of flow control to function correctly, the host must be capable of supporting it. **X-On/X-Off** operates in a manner similar to the function of pin 20 (**DTR**) as previously explained. When the printer is first powered on and goes on-line, an **X-On** is sent out. In the Single Job Buffer mode, when the printer receives a viable job, it transmits an **X-Off** and begins printing. When it is done printing, it transmits an **X-On**. In the Multi Job Buffer mode, the printer sends an **X-Off** when the "Buffer Near Full" level is reached and a **X-On** when the data level of the buffer drops below the "Buffer Available" mark. When the printer is taken off-line manually, it transmits an **X-Off** indicating it cannot accept data. When it is placed back on line manually, it sends an **X-On**, indicating it is again available for receipt of data. If an error occurs during printing (paper out, ribbon out), the printer sends nothing in the Single Job Buffer mode since the last character transmitted was an **X-Off**. When the error is cleared and the printer resumes printing, no **X-On** is sent until the current job is completed and the printer is once again ready to receive the next job. If it is in the Multi-Job Buffer mode, it sends an **X-Off** as soon as an error condition is detected. When the error is cleared and the printer is placed back on-line, it transmits as **X-On** indicating it is again ready to accept data.

Upon power up if no error conditions are present, the printer will continually send **X-On** characters at five millisecond intervals until it receives a transmission from the host.

Data Streams

The data streams for **X-On/X-Off** and **Ready/Busy** flow control are constructed in the same way as they are for Ready/Busy flow control.

<ESC>A .. Job#1 .. <ESC>Z<ESC>A .. Job#n .. <ESC>Z

Example: <ESC>A .. Job#1 .. <ESC>Z

NOTE: All characters are in ASCII.

3.6 Universal Serial Bus (USB) Interface

The Universal Serial Bus (USB) interface is a Plug-In Interface Module that can be installed by the user. It requires a driver (shipped with each printer that has the interface installed) that must be loaded on your PC and the PC must be configured to support USB peripherals using Windows 98 or above. Details for loading the USB driver are contained in the USB Interface Manual that is shipped with each printer with a USB Optional interface installed. Up to 127 devices may be connected to a USB port.

Universal Serial Bus (USB) Interface (Cont)

General Specifications:

Connector:	USB Type B Plug
Cable:	10ft (3 m) max.
Host:	Windows 98 USB Port

Electrical Specifications:

Power Supply:	Bus Power through cable
Power Consumption::	+5V@80ma

3.7 Ethernet Interface

The Ethernet interface is a Plug-In Interface Module that can be installed by the user. It requires a driver (shipped with each printer) that has the interface installed. The driver must be loaded on your PC and the PC must be configured to run one of the supported network protocols using a 10/100BaseT LAN connection. Details for loading the Ethernet driver are contained in the Ethernet Interface Manual that is shipped with each printer with a Ethernet interface installed.

General Specifications:

Type:	10/100BaseT
Connector:	RJ-45 Receptical
Cable:	Category 5

Electrical Specifications:

Power Supply: Powered from printer

Refer to the manual & CD supplied with the interface card.

3.8 Bi-Directional Communications

This is a two-way communications protocol between the host computer and the printer, thus enabling the host to check printer status. When Bi-Com 4, Bi-Com 3 or Bi-Com 2 communications is selected on the serial interface card, there is no busy signal from the printer. The host must request the complete status from the printer, including ready/busy.

Refer to the Operator's and Technical Manual for complete information.

3.9 Accessory (EXT) Connector

The EXT connector on the rear panel of the CL408e/CL412e printers is intended for use with external printer accessories such as label rewinders or applicators. The 14 pin Centronics type connector provides a choice of four different output signals along with various error conditions. A DB-9 to 14 pin Centronics adapter cable is provided for legacy applications.

Old

DB-9 14 Pin
Centronics

Pin Assignments

PIN	PIN	DIRECTION	SIGNAL DESCRIPTION
1	13	To Host	Vcc +/-5V
2	10	To Host	Ribbon Near End - This pin goes high when the amount of ribbon on the unwind shaft is approximately 46 feet (14 m). The output will be low when the ribbon is completely out.
3	4	To Host	Error - This pin goes low when the printer detects an error condition such as head open or receiving buffer is full.
4	7	To Printer	Reprint - A duplicate of the last label in a print job will be reprinted when this signal is received.
5	5	To Printer	Print Start - The printer will print one label when this pin is pulled to ground. This signal must be enabled by placing switch DSW3-5 on the Control Panel in the OFF position.
6	6	To Host	End Print - It is used to drive an applicator or other external device requiring synchronization with the print cycle. You may choose between four types of output signals using control panel DSW3-6 and DSW3-7 selections. See timing charts on next page.
7	1	To Host	Label Out - This pin goes low (0V) when a label error exists.
8	3	To Host	Ribbon Out - This pin goes low (0V) when ribbon is out.
9	2	Reference	Signal Ground
	8	To Printer	Isolated Power Source for signal input.
	9	To Host	When Mode 1 in LCD selected High Voltage = On-Line Print Job waiting. When Mode 2 in LCD selected High Voltage = On-Line. This goes low (0V) when printer Off-Line.
	11		Reserved
	12	To Host	+24V +/- 10% @2A - Power for external devices
	14		Frame Ground

Section 3. Interface Specifications

NOTE: The signals on pins 1, 3, 4, 6, 9 and 10 each have an open collector output. These pins normally measure +.07V maximum when a true condition exists. If a false condition occurs, the voltage will drop to 0V. To achieve a signal level of +5V, you must add a 330 ohm, 1/4 W pull-up resistor between the open collector output pin and Vcc (pin 13) as illustrated. This will provide a signal level of +5V for a true condition and 0V when a false condition exists. The maximum voltage that can be applied to these pins is +50V and the maximum current they can sink is 500 milliamps.

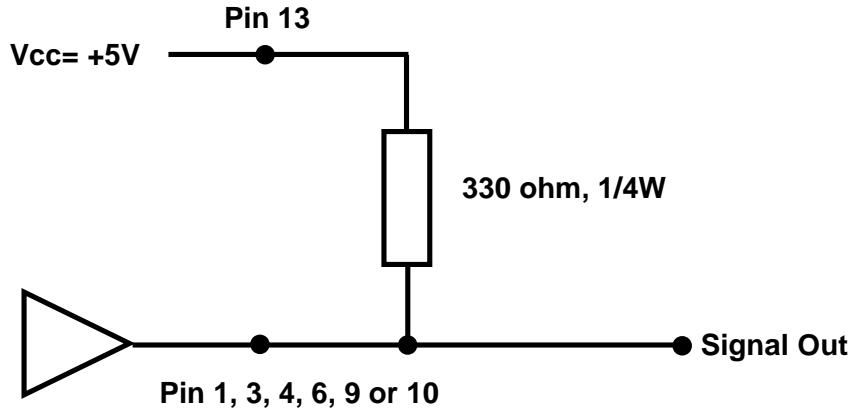

Standard Operation

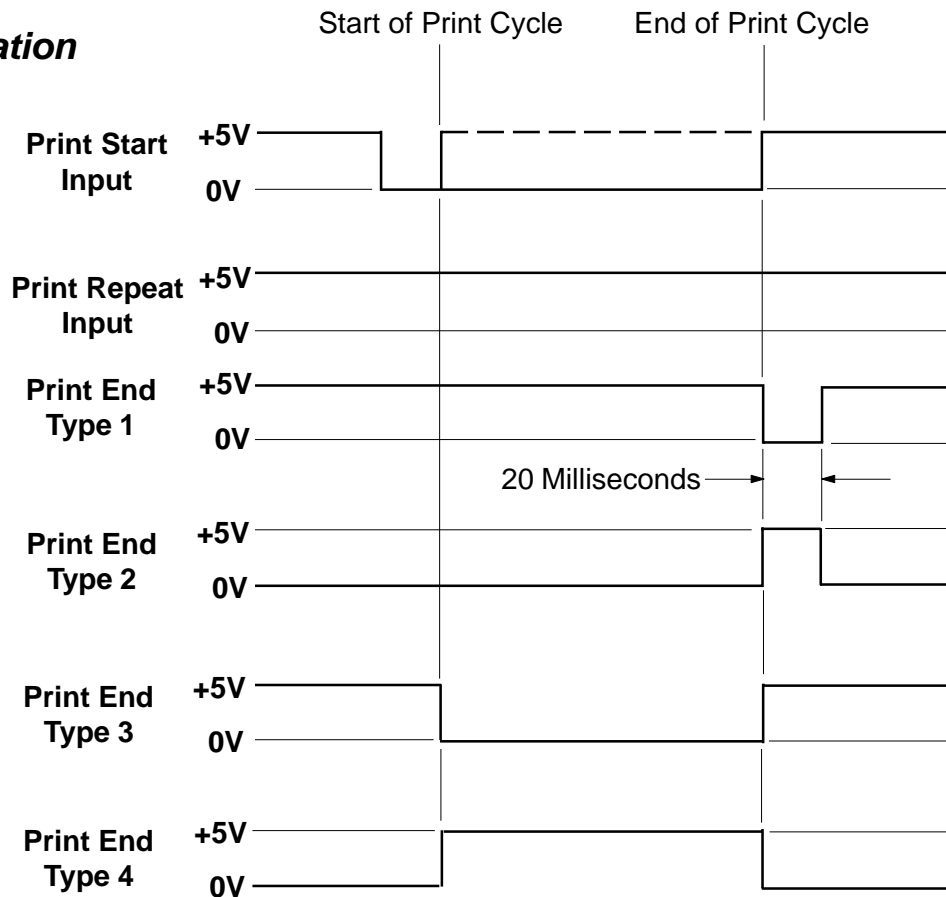

Repeat Print

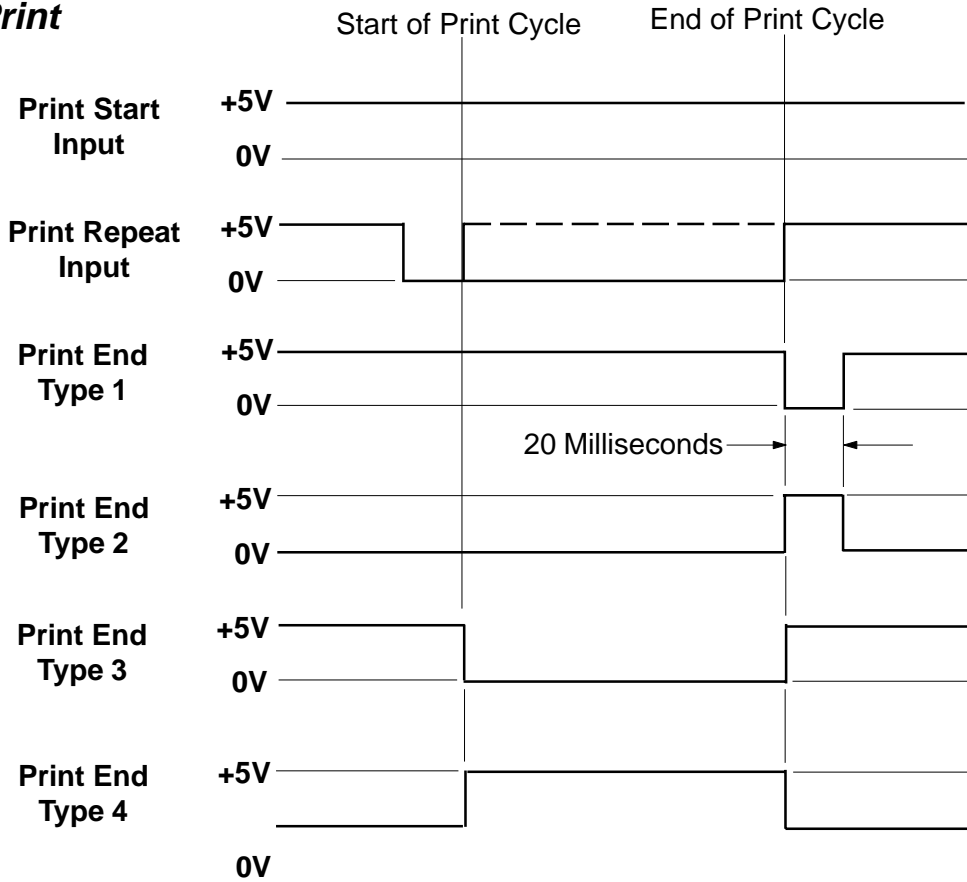

Error Signals

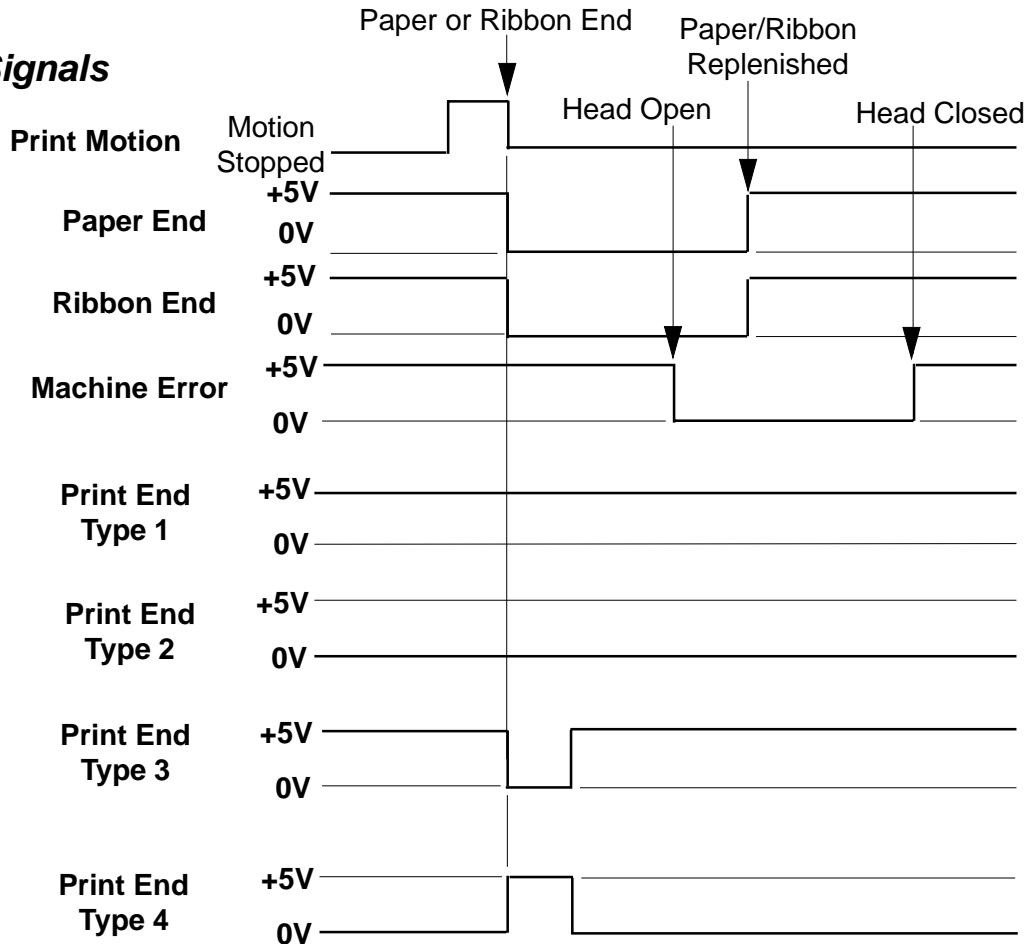



Section 4

Electrical Checks and Adjustments

4.1 Overview

This chapter describes how to check CL608e/CL612e Printers voltage levels and adjust threshold sensor voltages.

The power supply converts 125 VAC into regulated DC voltages. The printer uses: +5V and +24V. These DC voltages are not adjustable, however you can measure these DC voltages at test points located on the PCB. Section 4-2 contains procedures for measuring DC voltage levels.

You can adjust threshold voltage levels for label sensors. These adjustments are made to allow for variations in the characteristics of the labels used with the printer. If you cannot calibrate the label sensor voltage level within the specified voltage range, you should reposition the label sensor by following the adjustment procedures included in this section. After completing the label sensor adjustment procedures, perform the label sensor voltage level adjustment procedure.

You can check or adjust:

- *Power Supply*
- *Label Sensors*
- *Ribbon Sensor*
- *Pitch Offset*
- *Label Positions*

Checks and adjustments in this section require standard metric tools.

Also required:

Digital Multimeter required for use with SATO TP Test Module (Voltage Checker) Part # RH1773100 and is required for most electrical adjustments.

4.2 Steps Prior to Some Procedures

Some adjustments in this section require access to potentiometers and the test point connector located on the main PCB. Remove the LH cover for accessing the main PCB.

STEP	PROCEDURE
1.	Switch the printer OFF and disconnect the AC power cord.
2.	Remove (3) screws holding the left side cover to the printer. Raise the access door and loosen the (2) screws on the inside top of the printer. Lift off the left side cover to expose the main PCB.
Refer to the appropriate sub-section to begin adjustments.	

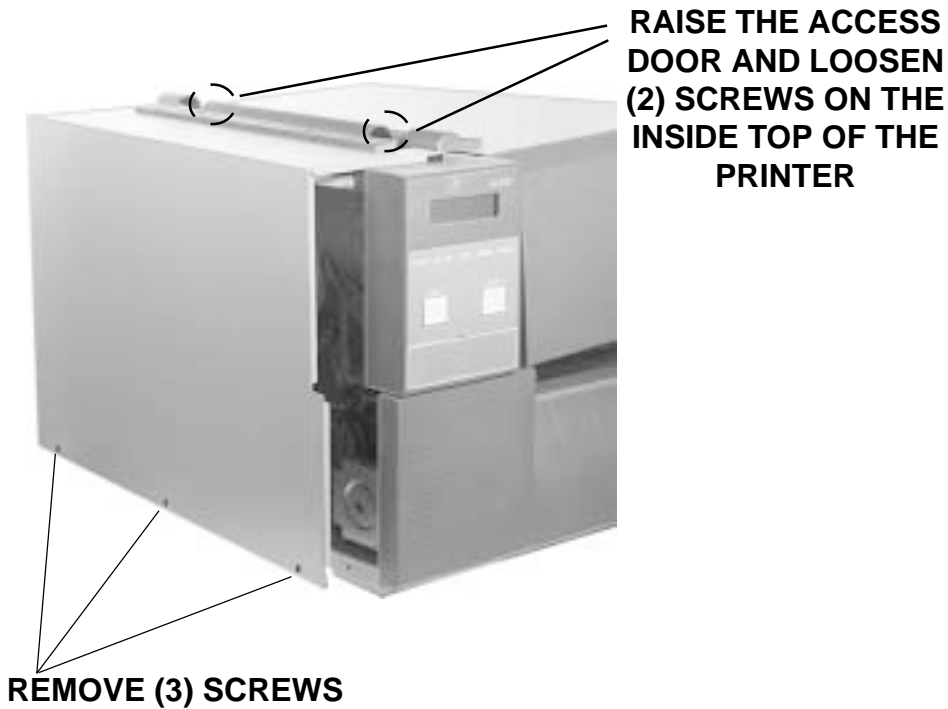

4.3 DC Power Voltage Checks

To check voltage levels, first check the fuses (Section 6.3) and replace if necessary. Then remove the LH cover, (Section 4.2) and perform the following steps.

Additional equipment required: TP Test Module
Digital Multimeter

STEP	PROCEDURE
1.	Refer to illustrations on pages 4-3 through 4-5. Attach the connector from the TP Test Module to the test port on the main PCB. Note correct positioning of connector. Nibs on the connector are placed down in the receptacle on the PCB in the forward position.
2.	Attach the ground probe of the multimeter to the TP Test Module Gnd pin.
3.	Attach the positive probe of the multimeter to the +SIG pin on the TP Test Module terminal.
4.	Turn printer on and rotate the dial to a dial POS on the TP Test Module. Record the values from the Multimeter LCD.
5.	Confirm voltages are correct. If not, then replace power supply. Refer to Section 6.4.
6.	After performing tests, replace the LH cover to the printer.

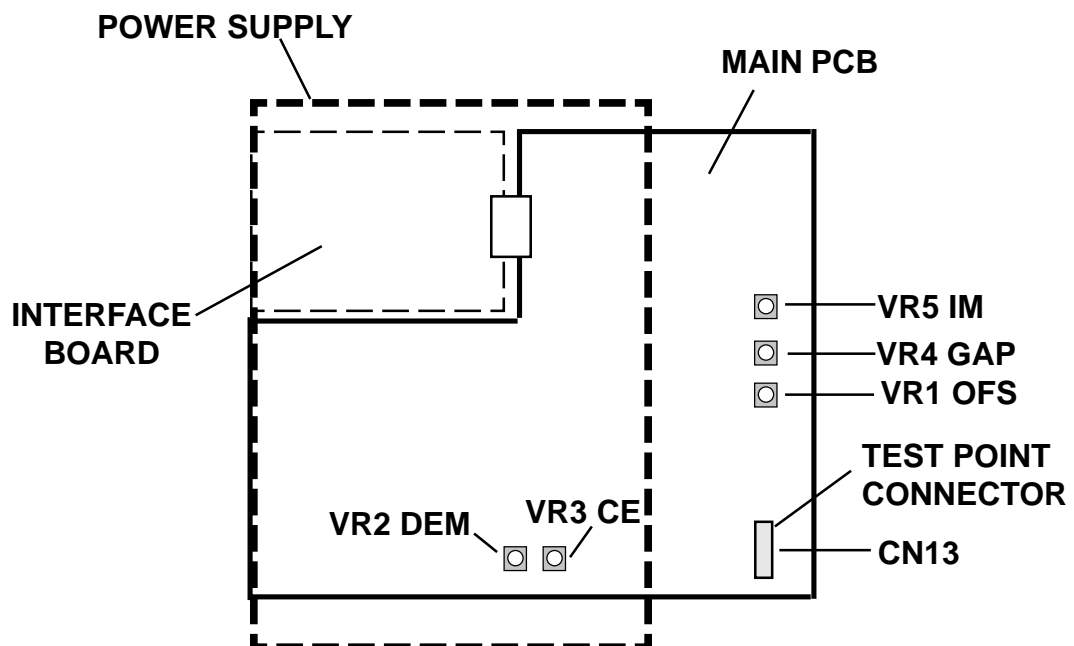

DC Power Voltage Checks

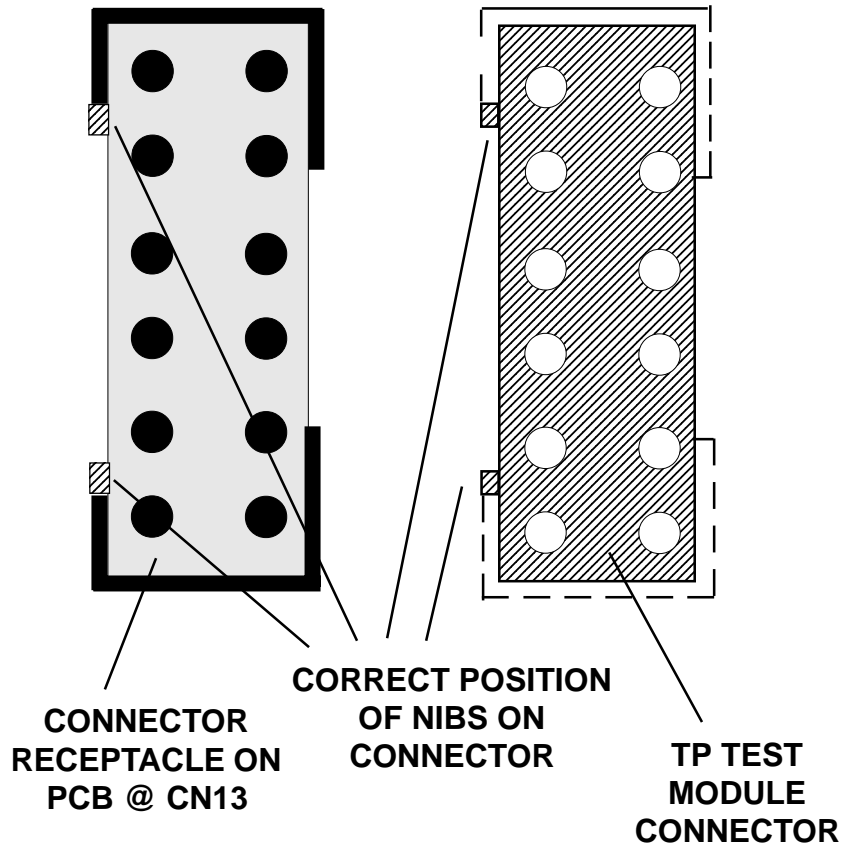
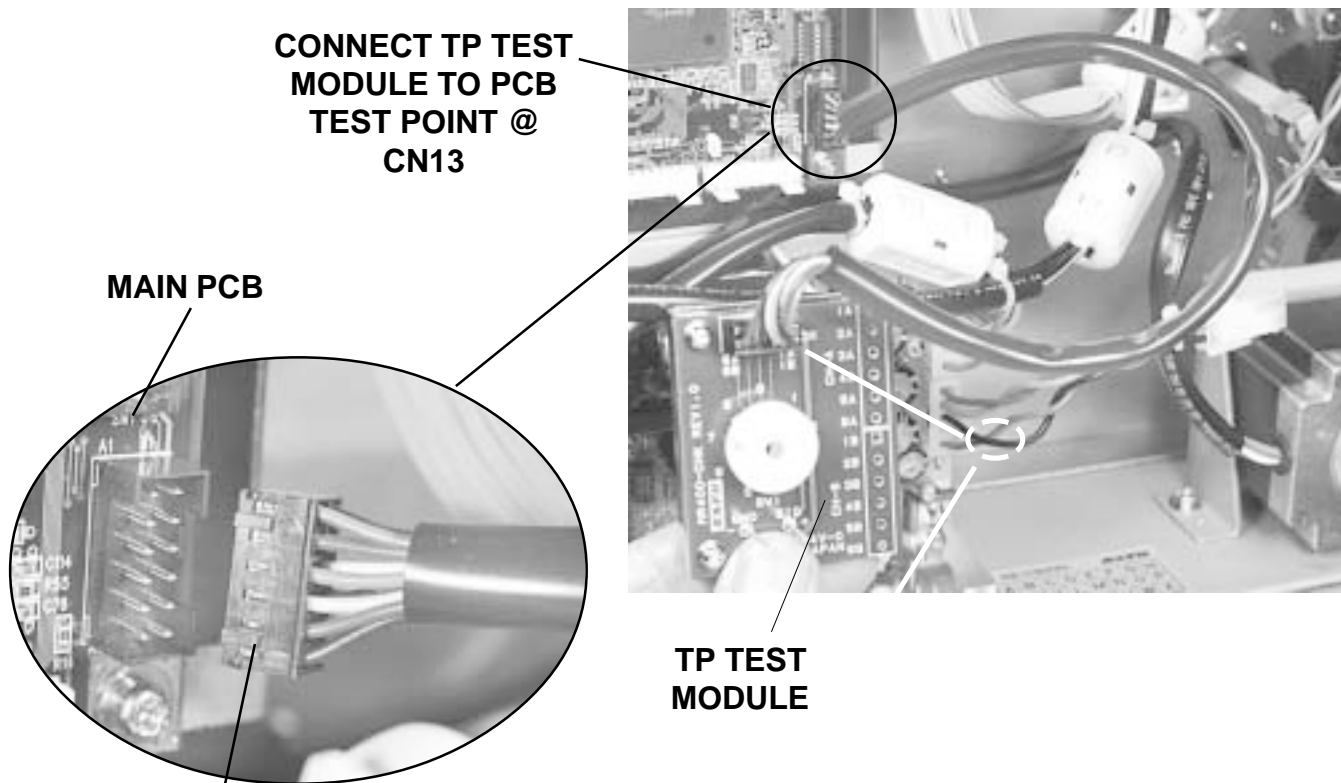

DC Power Voltage Checks

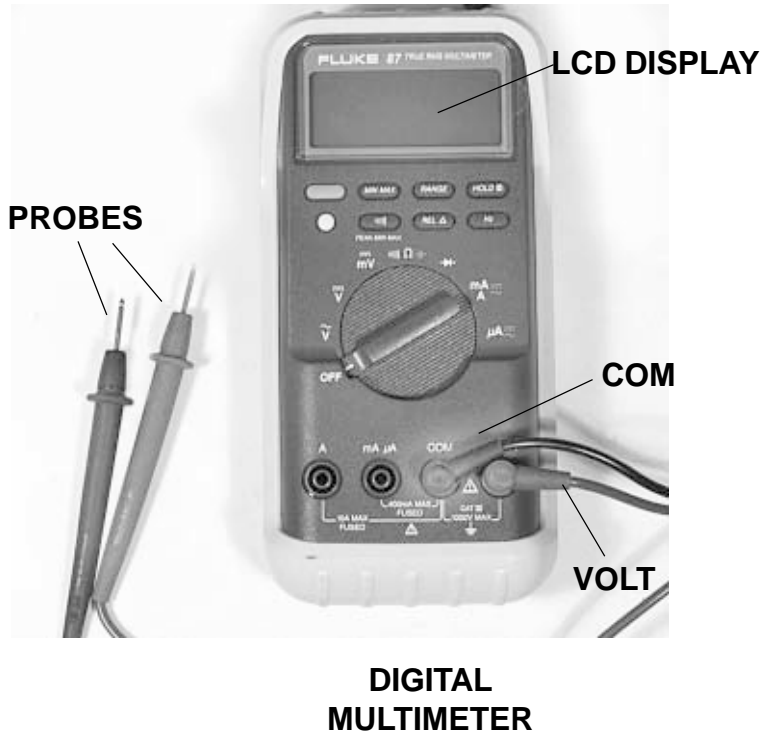
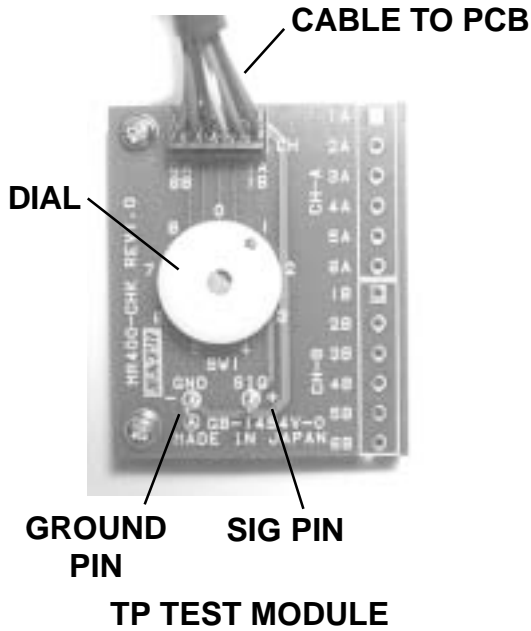

Dial POS	DISC	VOLTAGE RANGE	TP TEST MODULE
	SG		
	NC		
0	+5V	+4.8 to +5.2V	CHA3 (+5V) - CHA1 (GND)
1	+2.0V	+1.90 to +2.1V	CHA4 (+2.0V) - CHA1 (GND)
2	+3.3V	+3.1V to +3.5V	CHA5 (+3.3V) - CHA1 (GND)
3	+24V	+23.5V to +24.5V	CHA6 (+24V) - CHA1 (GND)

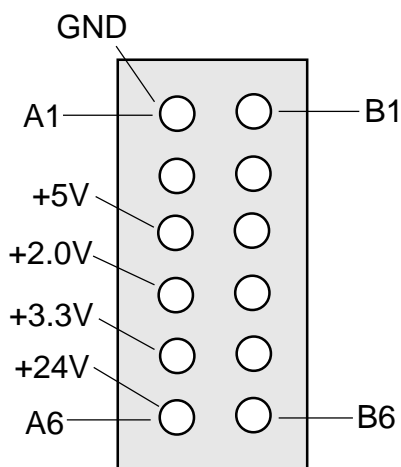

TEST POINT CHART

NOTE: The power supply voltages are not adjustable. All voltages must read within +/- 10% of the nominal value for correct operation of the printer.

4.4 Potentiometer Assignments & Adjustments

VR to Adjust	ITEM	POSITION DIAL
	5V	0
	2V	1
	3.3V	2
	24V	3
VR1	Pitch Offset	
VR4	GAP	5
VR5	Eye-Mark	4
VR2	DEM	6*
VR3	CE	7

POTENTIOMETERS ARE
LOCATED ON MAIN PCB

* USED WITH DISPENSER OPTION
TURN VR2 FULL CW FOR DISPENSER

VR TO ADJUST	ITEM
VR1	Darkness
VR2	Offset
VR3	Pitch
VR4	Display

POTENTIOMETERS ARE LOCATED
UNDERNEATH A FLIP - DOWN COVER
ON THE FRONT PANEL

Potentiometer Assignments & Adjustments

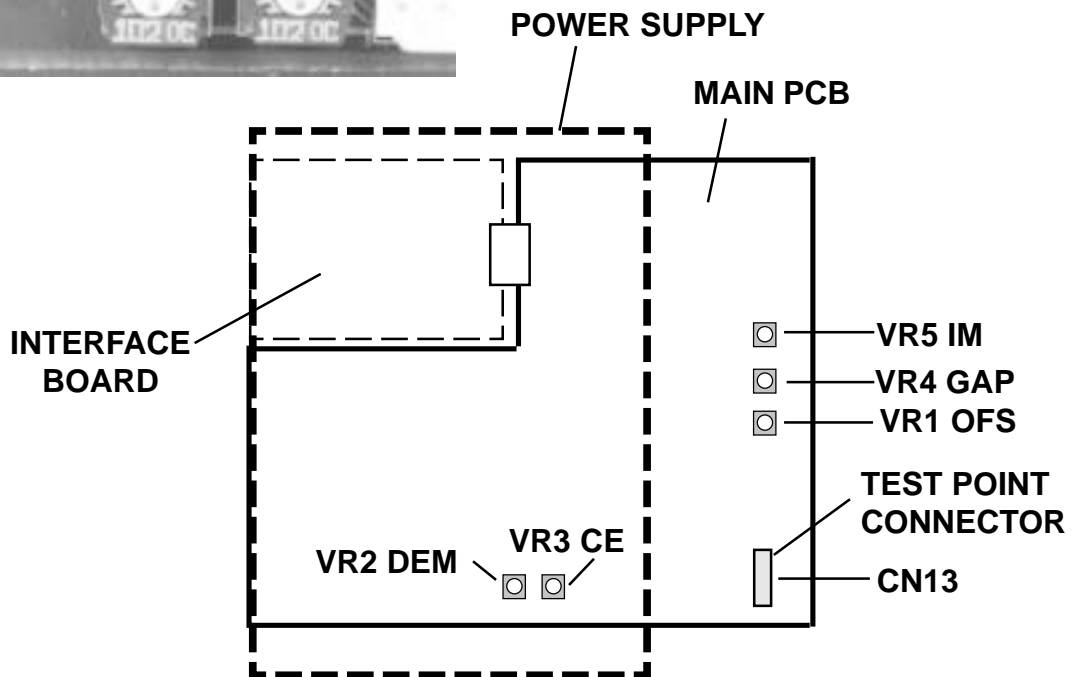
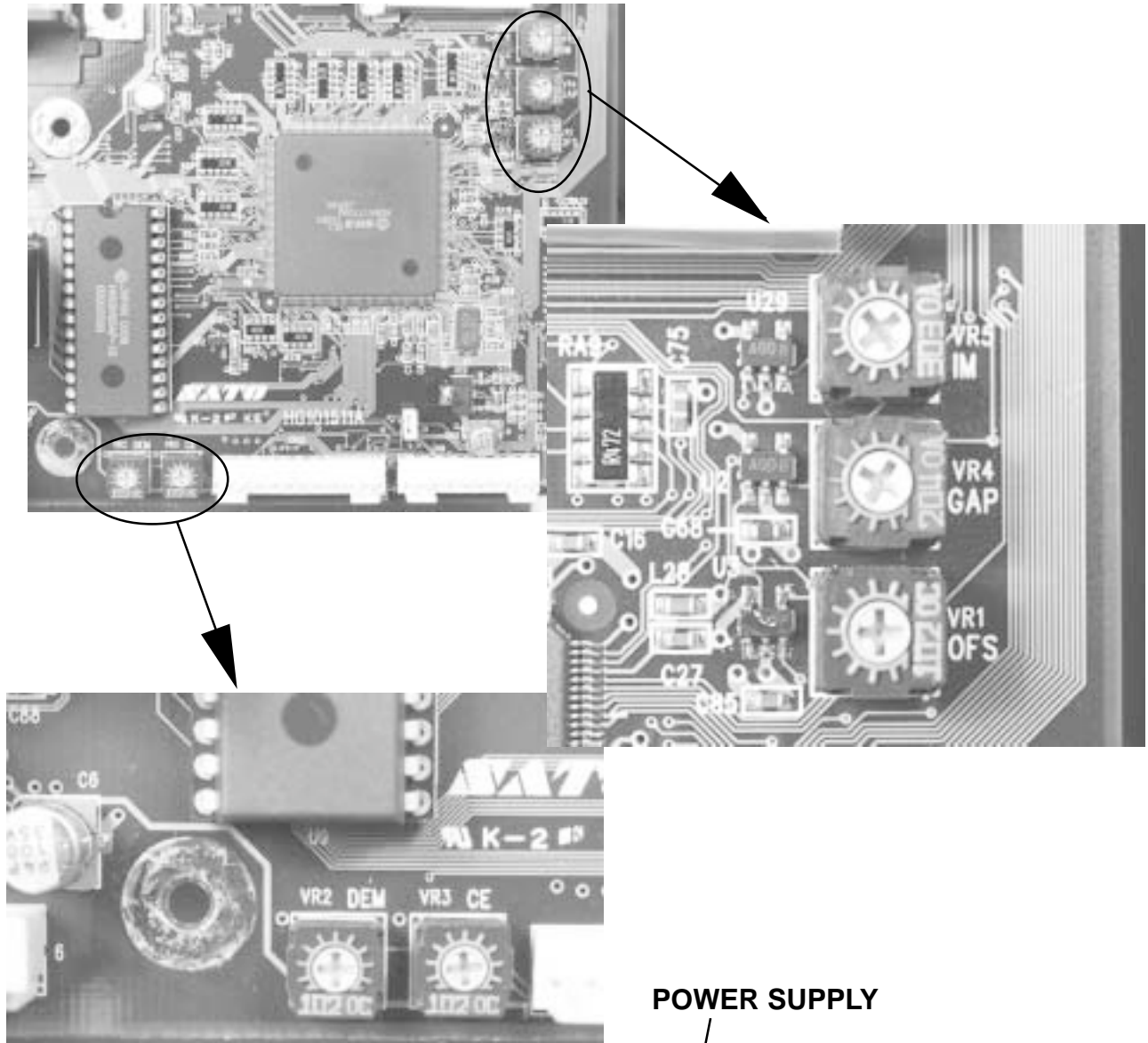

4.5a Print Position Adjustment

Print Position is adjusted with the VR3(PITCH) potentiometer on the Front Panel and/or VR1 potentiometer on the main PCB board.

The following instructions are for adjusting the potentiometer on the Front Panel. Refer to Section 4.5b for making adjustments using the potentiometer on the PCB board.



POTENTIOMETERS ARE LOCATED UNDERNEATH A FLIP - DOWN COVER OF THE FRONT PANEL

Note: The VR3 (PITCH) is for changing the print position but not for the print stop position. The stop position can be changed with the VR2 (OFFSET).





VR3 adjustment range is +/- 3.75mm.

STEP	PROCEDURE
1.	Flip down the cover on the front panel for access to the potentiometers.
2.	Turn VR3 to the center position.
3.	Press the FEED key while simultaneously turning ON the power switch.
4.	When the printer beeps, release the key. The following screens will appear.
	<div style="display: flex; align-items: center; justify-content: center;"> <div style="border: 1px solid black; padding: 5px; margin-right: 20px;"> <p style="text-align: center;">INITIALIZING ROM V00.00.00.00</p> </div> <div style="font-size: 2em; margin-right: 10px;">➔</div> <div style="border: 1px solid black; padding: 5px;"> <p style="text-align: center;">TEST PRINT MODE CONFIGURATION</p> </div> </div>
5.	Press the FEED key to display the next screen.
	<div style="border: 1px solid black; padding: 10px; margin: 10px auto; width: 200px;"> <p style="text-align: center;">TEST PRINT SIZE 10CM</p> </div>
6.	Use the LINE Key to step to the second digit of the counter to the desired setting. The display will increment one step each time the LINE key is pressed. After the reading will advances to a setting of 09, it will automatically wrap and start at 10 CM again.
7.	Press the FEED key for a test print. Press the FEED key again to stop printing.
	<div style="border: 1px solid black; padding: 10px; margin: 10px auto; width: 200px;"> <p style="text-align: center;">PRESS FEED KEY TO STOP PRINTING</p> </div>
8.	Adjust the position using the potentiometer and feed another label. When the adjustment is correct, turn the printer off. If the print position can't be adjusted replace the Keyboard PCB. Refer to Section 6.

4.5b Print Position Adjustment

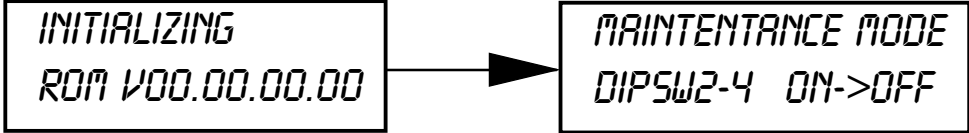
Using VR1 potentiometer on the main PCB board.

**VR1 adjustment range is
+/- 3.75mm.**

STEP	PROCEDURE
	Refer to Section 4.2 for access to main PCB
1.	Record all current dip switch positions, then place all switches in the OFF position and the power switch OFF .
2.	Turn VR1 on the main PC Board to the center position.
3.	Place DSW2-4 in the ON (up) position.
4.	Press the LINE and FEED key while simultaneously turning the power switch ON .
5.	When the printer beeps, release the keys. The following screens will appear.
	
6.	Place DSW2-4 in the OFF (down) position and the screen will display the next screen.
	
7.	Press the FEED key to display the next screen.
	
8.	Confirm "None" then press the FEED key to display the next screen.
	
	The default is Large.
9.	Press the FEED key for a test print. Press the FEED key again to stop printing.
	
10.	Adjust the position using the VR1 potentiometer and feed another label. When the adjustment is correct, turn the printer off. If the print position can't be adjusted with the VR1, replace the Main PCB. Refer to Section 6.

4.6 Label Gap Adjustment

Additional equipment required: TP Test Module
Digital Multimeter

STEP	PROCEDURE
	Refer to Section 4.2 for access to main PCB
1.	Turn VR4 (GAP) potentiometer on the main PCB all the way to the left.
2.	Refer to Section 4.3. Set the digital multimeter to DC voltage measurement mode. Attach the connector from the TP Test Module to the test port on the main PCB. Note correct positioning of connector. Nibs on the connector are placed down in the receptacle on the PCB in the forward position. Set the dial to 5.
3.	Connect (+) probe of the multimeter to Sig+ and (-) probe to pin GND.
4.	For Low level (Label Gap part with backing only) adjustment, put label gap part in the sensor. Then adjust the electrical level with VR4 on the main PCB so that it will measure less than 0.5 V.
5.	For High level (paper part) adjustment, put paper part in the sensor and check the electrical level. If the level difference is +1.0 V more than the Low level, it is acceptable. If it is lower than 1.0V repeat STEPS 4 & 5 and readjust VR4 .
6	Standard values: Low level (gap): below 0.5 V High level (paper part): Low level +1.0 V or higher. If these values do not result, try the following: <ol style="list-style-type: none"> a) Repeat the process b) Clean the sensor c) Verify sensor is operational d) Replace labels with higher quality labels e) Perform factory reset

4.7 Eye-Mark Adjustment

Additional equipment required:	TP Test Module Digital Multimeter
--------------------------------	--------------------------------------

STEP	PROCEDURE
	Refer to Section 4.2 for access to main PCB
1.	Turn VR5 (IM) potentiometer on the main PCB all the way to the left.
2.	Refer to Section 4.3. Set the digital multimeter to DC voltage measurement mode. Attach the connector from the TP Test Module to the test port on the main PCB. Note correct positioning of connector. Nibs on the connector are placed down in the receptacle on the PCB in the forward position. Set the dial to 4.
3.	Connect (+) probe of the multimeter to Sig+ and (-) probe to pin GND.
4.	For Low level (no "Eye-Mark" part) adjustment, put paper part in the sensor. Then adjust the electrical level with VR5 on the main PCB so that it will measure less than 0.5 V.
5.	For High level ("Eye-Mark" part) adjustment, put paper part with the "Eye-Mark" part in the sensor and check the electrical level. If the level difference is +1.0 V more than the Low level, it is acceptable. If not, return to STEP 4 and readjust VR5 .
6.	Standard values: Low level (no "Eye-Mark" part): +0.5 V or less. High level ("Eye-Mark"): Low level +1.0 V or higher. If these values do not result, try the following: <ol style="list-style-type: none"> a) Repeat the process b) Clean the sensor c) Verify sensor is operational d) Replace labels with higher quality labels e) Perform factory reset

4.8 Offset Label Stop Position Adjustment

Used for fine adjustment of label stop position for Tear Off, Cutter and Dispense Modes.

The Label Stop Position is adjusted with the Offset potentiometer on the Front Panel.



POTENTIOMETERS ARE LOCATED UNDERNEATH A FLIP - DOWN COVER OF THE FRONT PANEL

Note: The stop position only is changed with the VR2 (OFFSET). The print position is changed with the VR3(PITCH).

The VR2(OFFSET) adjustment range is +/- 3.75mm.

STEP	PROCEDURE
1.	Flip down the cover on the front panel for access to the potentiometers.
2.	Turn VR2(OFFSET) to the center position.
3.	Press the FEED key while simultaneously turning ON the power switch.
4.	When the printer beeps, release the key. The following screens will appear.
	<div style="display: flex; align-items: center; justify-content: center;"> <div style="border: 1px solid black; padding: 5px; text-align: center; width: 150px;"> <p>INITIALIZING</p> <p>ROM V00.00.00.00</p> </div> <div style="margin: 0 10px;">→</div> <div style="border: 1px solid black; padding: 5px; text-align: center; width: 150px;"> <p>TEST PRINT MODE</p> <p>CONFIGURATION</p> </div> </div>
5.	Press the FEED key to display the next screen.
	<div style="border: 1px solid black; padding: 5px; text-align: center; width: 150px;"> <p>TEST PRINT SIZE</p> <p>10CM</p> </div>
6.	Use the LINE Key to step to the second digit of the counter to the desired setting. The display will increment one step each time the LINE key is pressed. After the reading will advances to a setting of 09, it will automatically wrap and start at 10 CM again.
7.	Press the FEED key for a test print. Press the FEED key again to stop printing.
	<div style="border: 1px solid black; padding: 5px; text-align: center; width: 150px;"> <p>PRESS FEED KEY</p> <p>TO STOP PRINTING</p> </div>
8.	Adjust the stop position using VR2 and feed another label. When the adjustment is correct, turn the printer off. If the print position can't be adjusted replace the Keyboard PCB. Refer to Section 6.

4.9 Ribbon Sensor Operation Verification

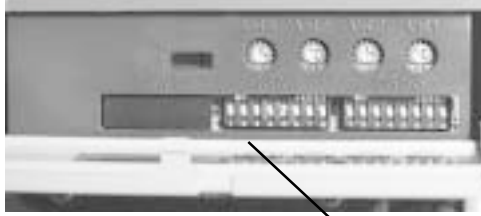

PLACE DSW2-1 IN
THE OFF POSITION

No adjustment is provided
for this sensor

SEE PAGE 1-8 FOR
SENSOR LOCATION

STEP	PROCEDURE
1.	Flip down the cover on the front panel for access to the dip switches.
2.	Record all dip switch positions, then place DSW2-1 in the OFF position and the power switch OFF .
3.	Remove the ribbon from the printer and close the Head Open Lever.
4.	Turn the power switch ON to initialize the printer. The following screens will display.
	<div style="display: flex; align-items: center; justify-content: center;"> <div style="border: 1px solid black; padding: 5px; text-align: center;"> <p><i>INITIALIZING</i></p> <p><i>ROM V00.00.00.00</i></p> </div> <div style="margin: 0 10px;">→</div> <div style="border: 1px solid black; padding: 5px; text-align: center;"> <p><i>ONLINE</i></p> <p><i>QTY:000000</i></p> </div> </div>
5.	Press the LINE key to place the printer off-line.
6.	Press the FEED key. The printer will beep and the following screen will display to confirm that the ribbon is not in position and confirm the sensor is functioning.
	<div style="border: 1px solid black; padding: 10px; width: fit-content; margin: 0 auto;"> <p><i>RIBBON END</i></p> </div>
7.	Turn off the printer and reinstall the ribbon.
8.	Turn ON the printer. The printer will initialize as in Step 4. Be sure to place the printer off line. Press the FEED key to generate a blank label and confirm ribbon has been installed and is in position.

4.10 Ribbon Sensor Adjustment

Additional equipment required: TP Test Module
Digital Multimeter

STEP	PROCEDURE
	Refer to Section 4.2 for access to main PCB
1.	Turn VR4 potentiometer on the main PCB all the way to the right.
2.	Refer to Section 4.3. Set the digital multimeter to DC voltage measurement mode. Attach the connector from the TP Test Module to the test port on the main PCB. Note correct positioning of connector. Set the dial to 7.
3.	Connect (+) probe of the multimeter to Sig+ and (-) probe to pin GND.
4.	Refer to Section 1-6 to locate the ribbon sensor. For Low level adjustment, rotate the ribbon unwind shaft to align one of the "slots" with the sensor. Then adjust the electrical level with VR4 on the main PCB so that it will measure less than +1.0.
5.	For High level adjustment, rotate the ribbon unwind shaft to align one of the "tabs" with the sensor. Check the electrical level. If the level difference is +2.3 V more than the Low level, it is acceptable. If not, return to STEP 4 and readjust.
6.	Standard values: Low level (slot): +1.0 V or less. High level (tab): Low level +2.3 V or higher NOTE: Adjust low level to achieve the biggest difference between each level by repeating the process If these values do not result, try the following: <ul style="list-style-type: none">a) Repeat the processb) Clean the sensorc) Replace the sensor

4.11 LCD Display Adjustment

STEP	PROCEDURE
1.	Turn ON the power.
2.	Confirm the backlight on the LCD is lit and message is displayed.
3.	Adjust the display darkness with VR4 potentiometer (located underneath a flip-down cover of the front panel) as necessary.

VR 4
/



**POTENTIOMETERS ARE LOCATED
UNDERNEATH A FLIP - DOWN COVER
OF THE FRONT PANEL**

4.12 Print Darkness Adjustment

STEP	PROCEDURE
1.	Turn VR1 potentiometer (located underneath a flip-down cover of the front panel) to the center position.
2.	Turn ON the power. Press the LINE key to go off-line. Then press LINE and FEED keys simultaneously and the following message will display. <div data-bbox="899 516 1295 642" style="border: 1px solid black; padding: 5px; margin: 10px auto; width: fit-content;">PRINT DARKNESS 1(L) 2(M) 3(O)</div>
3.	Press LINE key and place the cursor under the print darkness desired, then press the FEED key to enter.
4.	Turn OFF the power.
5.	Check the print darkness and adjust to suit with VR1 .



**POTENTIOMETERS ARE LOCATED
UNDERNEATH A FLIP - DOWN COVER
ON THE FRONT PANEL**

Section 5

Mechanical Adjustments

5-1 Overview

SATO CL608e/CL612e printers contain adjustable sub-assemblies. This means that during your regular maintenance, your service technicians are able to make adjustments to reset the printer to factory specifications thereby ensuring optimum performance of your printer.

The main mechanical sub-assemblies are:

- *Ribbon Unwind/Rewind Assembly's*
- *Ribbon Guide Roller Assembly*
- *Print Head Assembly*
- *Drive Belt Assembly's*

In this section you will find procedures for:

- *Ribbon Clutch Adjustment*
- *Print Head Position Adjustment*
- *Print Head Balance Adjustment*
- *Ribbon Roller Adjustment*
- *Feed Roller Adjustment*
- *Timing Belt Tension Adjustment*
- *Head Latch Adjustment*
- *Notch/Gap Sensor Adjustment*

5.2 Ribbon Clutch Adjustments

Excessive ribbon unwind and rewind tension will result in variable ribbon motion and could be the cause of print quality problems.

Follow the procedures 5.2.1 and 5.2.2 to verify that the ribbon unwind and rewind tensions are within specifications or if adjustment of either clutch is necessary.

- | | |
|---------------------|---|
| Required Equipment: | <ul style="list-style-type: none">• 1 Kg Tension Gauge• Ribbon Core, empty• String• 12mm Wrench• #2 Pozidrv Screwdriver |
|---------------------|---|

5.2.1 Ribbon Unwind Clutch Adjustment

STEP	PROCEDURE
1.	Connect the power cable to the printer and AC outlet. Turn the printer ON .
2.	Raise the access door and remove the ribbon and label stock if installed. Fig. 5-1
3.	Attach string to an empty ribbon core and place on the Ribbon Unwind Spindle. Wind the string tightly around the ribbon core in a single layer and in a clockwise direction. Attach the free end of the string to the tension gauge. Fig. 5-2 & 5-3
4.	Gradually lift the tension gauge, pulling the string to unwind it from the core. Once the spindle begins to move, the gauge should indicate 450 to 550 grams of tension. Excessive or insufficient tension must be corrected by adjusting the Ribbon Unwind Clutch. Fig. 5-2 & 5-3
5.	To adjust the clutch, loosen the locking screw and move the adjust nut CW for more tension and CCW for less tension. Tighten the locking screw and repeat Steps 3 and 4 until the correct tension is achieved.

**REMOVE THE
RIBBON AND
LABEL STOCK**

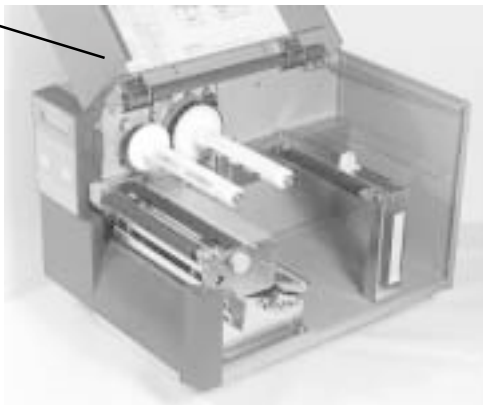

Fig. 5-1

Ribbon Clutch Adjustments

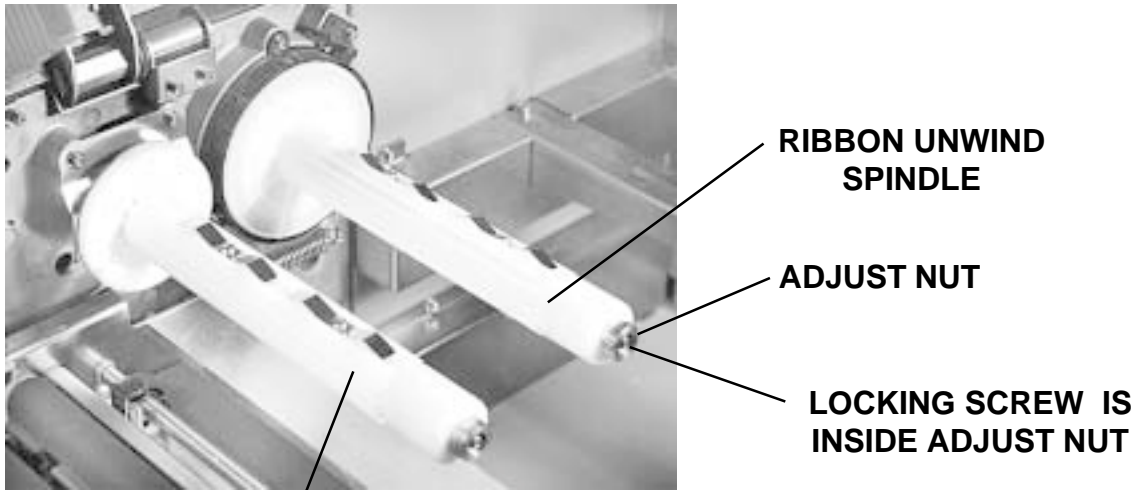

Fig. 5-2

RIBBON REWIND SPINDLE

TENSION GAUGE

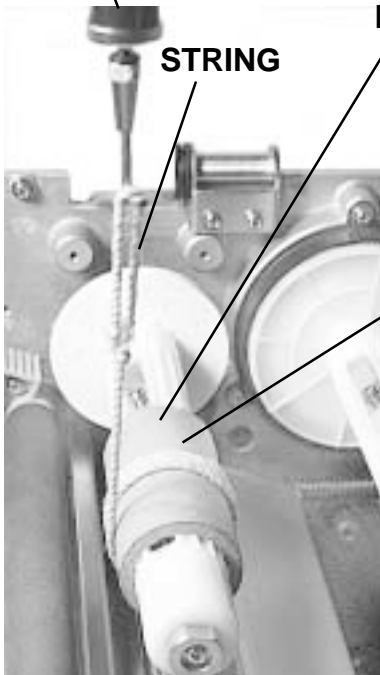

Fig. 5-4

REWIND CLUTCH

STRING TENSION GAUGE

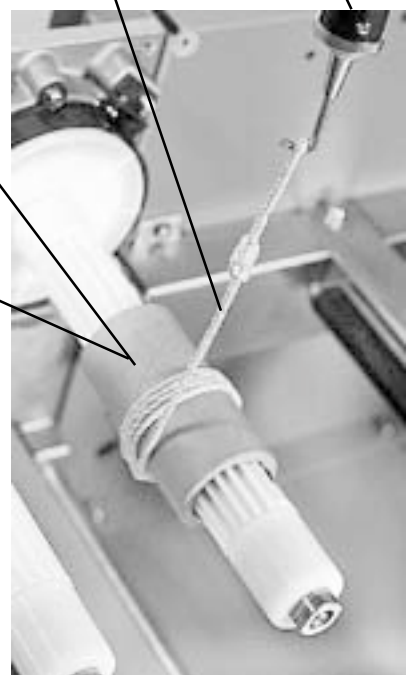

Fig. 5-3

UNWIND CLUTCH

Ribbon Clutch Adjustments

5.2.2 Ribbon Rewind Clutch Adjustment

STEP	PROCEDURE
1.	Connect the power cable to the printer and AC outlet. Turn the printer ON .
2.	Raise the access door and remove the ribbon and label stock if installed. Fig. 5-1
3.	Attach string to an empty ribbon core and place on the Ribbon Rewind Spindle. Wind the string tightly around the ribbon core in a single layer and in a clockwise direction. Attach the free end of the string to the tension gauge. Fig. 5-2 & 5-4
4.	Gradually lift the tension gauge, pulling the string to unwind it from the core. Once the spindle begins to move the gauge should indicate 950 to 1050 grams of tension. Excessive or insufficient tension must be corrected by adjusting the ribbon unwind clutch. Fig. 5-2 & 5-4
5.	To adjust the clutch, loosen the locking screw and move the adjust nut CW for more tension and CCW for less tension. Tighten the locking screw and repeat Steps 3 and 4 until the correct tension is achieved.

5.3 Print Head Position Adjustment

Required Equipment:	<ul style="list-style-type: none"> • Allen Wrench 2.5mm • Ruler
---------------------	---

STEP	PROCEDURE
1.	Refer to Section 7.2 and run a test print. Fig. 5-5
2.	By adjusting the Allen head screws on the rear of the Stay, you can move the print head forward or backward. This allows you to position the burnline of the print head directly and evenly over the apex of the platen surface. Fig. 5-6 & 5-7
3.	While printing the test pattern, adjust the Allen adjustment screws for the best print quality. NOTE: It is vital that a known good platen be in the unit.
4.	Verify the image is even on the label by measuring the distance from the bottom of the barcode to the bottom of the label on both sides. Refer to Fig. 5-5 . If uneven, adjust the Allen adjustment screws to correct the alignment. This may affect the print quality and may need to be readjusted.
5.	If you are unable to get the unit to produce good print quality, proceed to Section 5.4 Print Head Balance Adjustment and perform the adjustment; then return to this section and redo the Print Head Position Adjustment. NOTE: You may have to do both of these adjustments concurrently several times to achieve proper print quality and alignment.

Print Head Position Adjustment

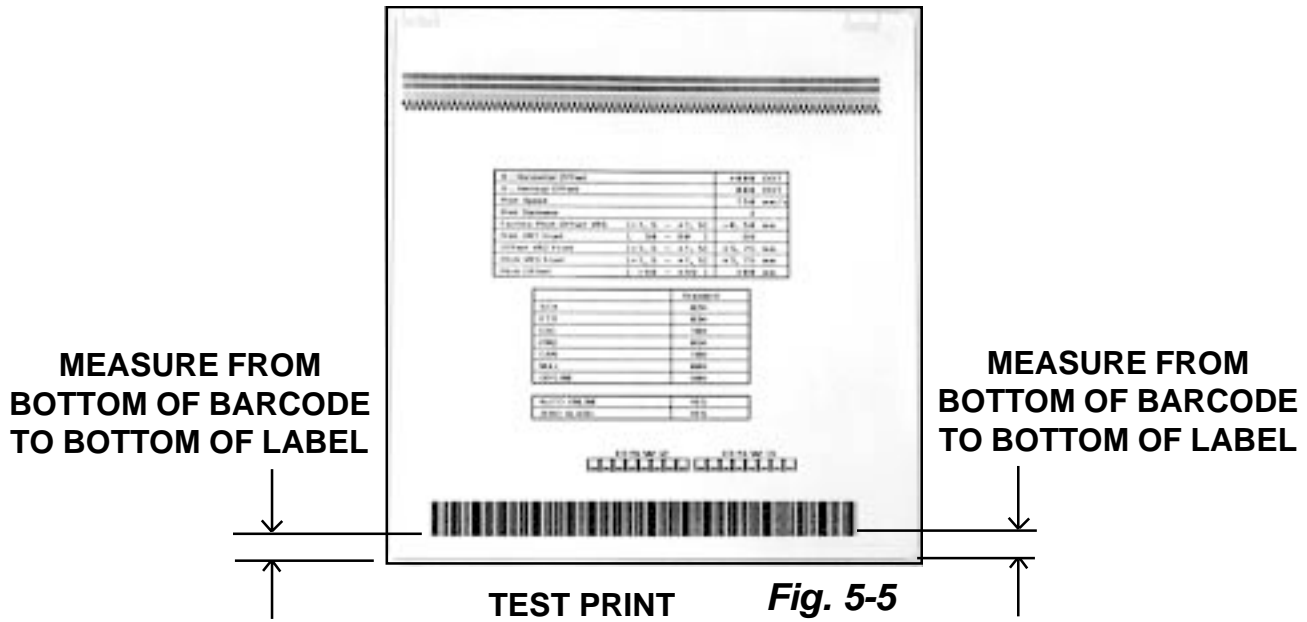

STAY
Fig. 5-6

ROTATION OF ALLEN WRENCH	MOVEMENT OF PRINT HEAD
CLOCKWISE	TO THE FRONT
COUNTER-CLOCKWISE	BACKWARD

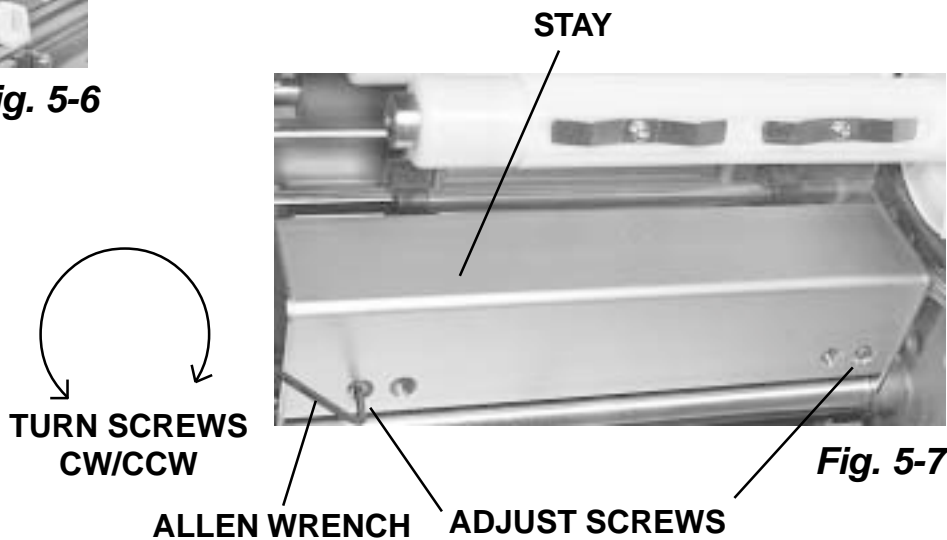

5.4 Print Head Balance Adjustment

Required Equipment:	<ul style="list-style-type: none"> • #2 Pozidrv Screwdriver • 10mm wrench
---------------------	---

To optimize print quality, perform the following steps to adjust the Print Head Balance using head pattern as a guide. Proper adjustment is necessary to avoid ribbon wrinkle.

STEP	PROCEDURE
1.	Connect the power cable to the printer and AC outlet. Turn the printer ON .
2.	Raise the access door and load the ribbon and label stock. NOTE: It is vital that a known good platen be in the unit.
3.	Loosen the locking screws. Fig. 5-8
4.	While printing, adjust the eccentric with a 10mm wrench. Turn the eccentric clockwise to increase the density (darker impression) of the inner side of the image or counter-clockwise to increase the density (darker impression) of the outer side of the image.
5.	Hold the eccentric in place with the 10mm wrench and tighten the locking screws loosened in Step 3 above.
6.	After adjustment, verify that label and ribbon are still tracking correctly.
7.	If you are unable to get the unit to produce good print quality, return to Section 5.3 Print Head Position Adjustment and perform the adjustment; then return to this section and redo the Print Head Balance Adjustment. NOTE: You may have to do both of these adjustments concurrently several times to achieve proper print quality and alignment.

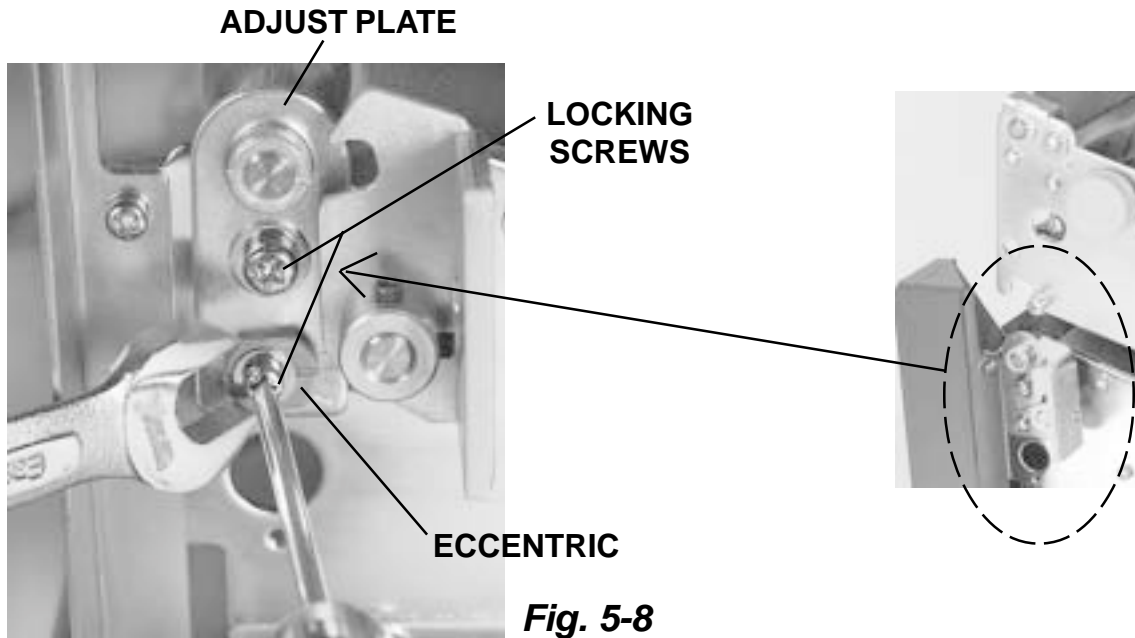

5.5 Ribbon Roller Adjustment

- | | |
|---------------------|--|
| Required Equipment: | <ul style="list-style-type: none">• #2 Pozidrv Screwdriver• 10mm wrench |
|---------------------|--|

NOTE: Only do this adjustment after adjusting ribbon wind and unwind tension in Section 5.2.1 and 5.2.2

STEP	PROCEDURE
1.	Connect the power cable to the printer and AC outlet. Turn the printer ON .
2.	Raise the access door and load the ribbon and label stock. Fig. 5-1
3.	Loosen the locking screws. Fig. 5-9
4.	Turn eccentric with wrench.
5.	When the carbon ribbon moves evenly without wrinkling, tighten the locking screws.

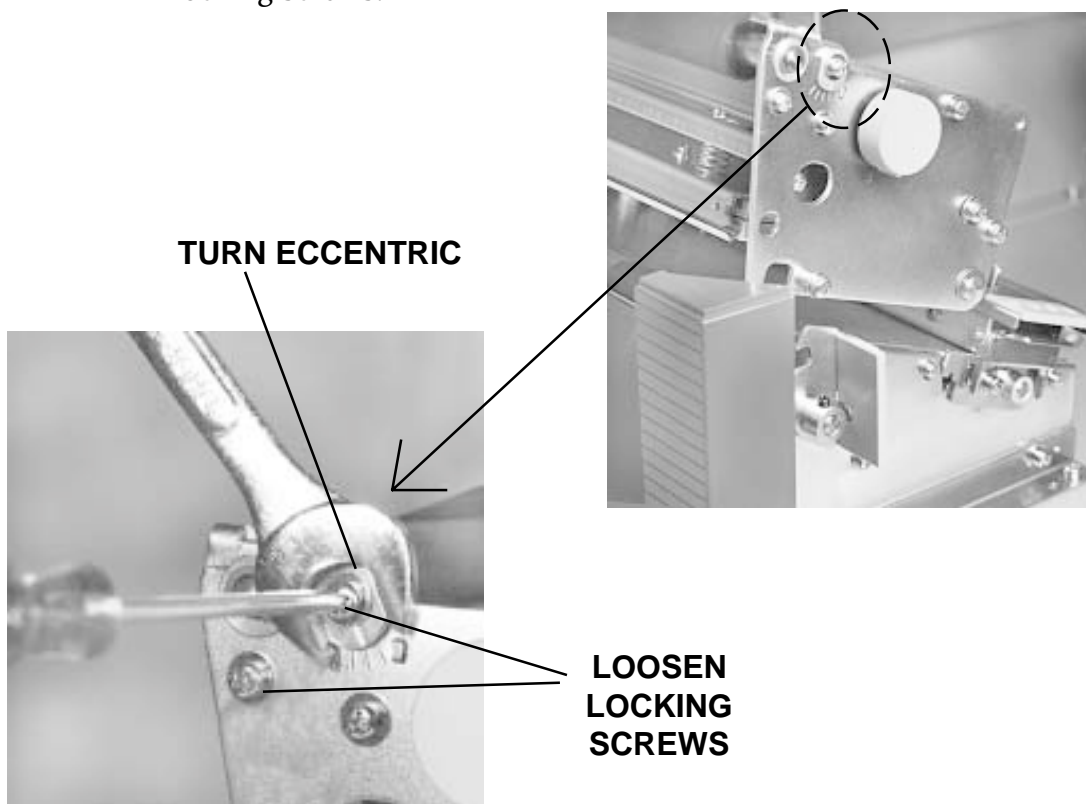

Fig. 5-9

5.6 Feed Roller Adjustment (Label Tracking)

Required Equipment:	<ul style="list-style-type: none"> • #2 Pozidrv Screwdriver • 5.5mm wrench • 1 Kg Tension Gauge
---------------------	--

Used for fine tuning. Adjusts pressure between upper and lower rollers.

STEP	PROCEDURE
1.	Switch the printer OFF and disconnect the power cable.
2.	Raise the access door and remove the label stock if installed. Fig. 5-1
3.	Attach a strip of 20mm + wide liner backing paper to the end of the tension gauge. Under the media cover, place the strip between the pressure rollers at one end with the print head assembly open. Gradually pull the tension gauge and measure the friction. Repeat at the opposite end of the rollers. Fig. 5-10 & 5-11
4.	The difference between the left side and the right side should be 100g or less.
5.	To adjust the pressure between the rollers, loosen the two fixing nuts with a 5.5mm wrench and adjust the screws. Fig. 5-12
6.	To adjust the alignment of the roller, loosen the locking screw and move the adjust plate with a screwdriver until the required positions are found. Fig. 5-13
7.	Tighten the locking screw.

Feed Roller Adjustment (Label Tracking)

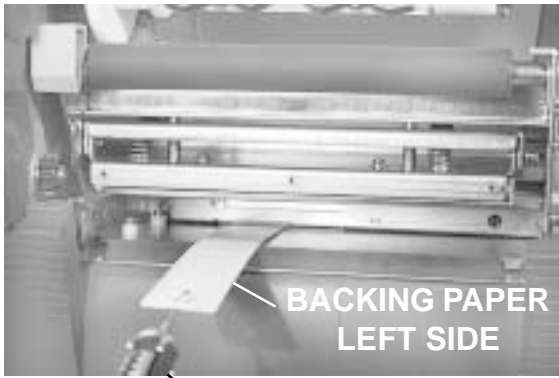

Fig. 5-10

TENSION
GAUGE

PULL

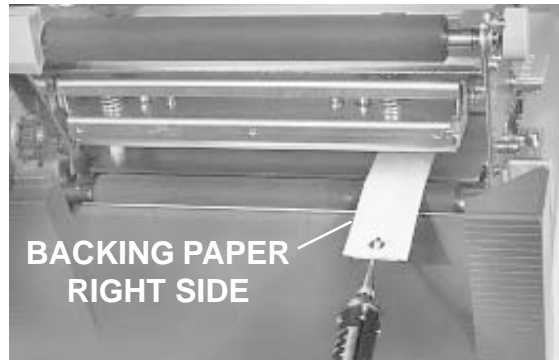

Fig. 5-11

PULL

ADJUST SCREW & FIXING
NUT ON BOTH ENDS OF
MEDIA COVER

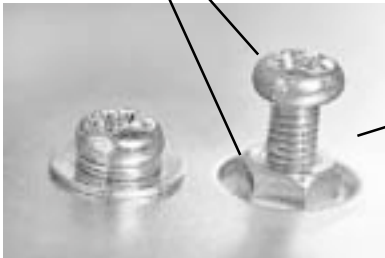

Fig. 5-12

MEDIA
LID



MOVE WITH
FLAT BLADE
SCREWDRIVER

ADJUST
PLATE

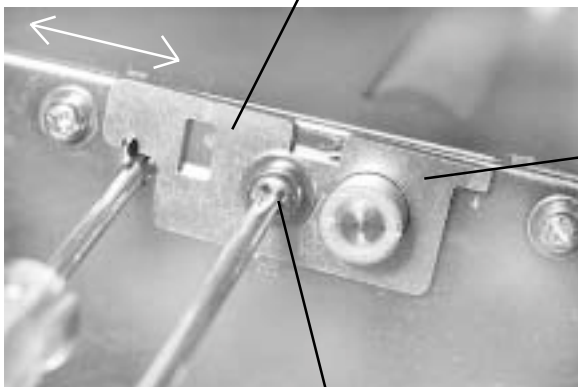
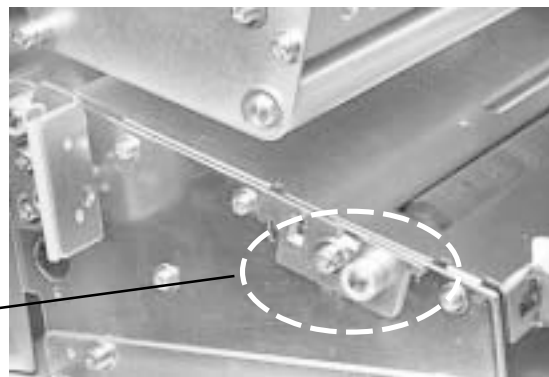
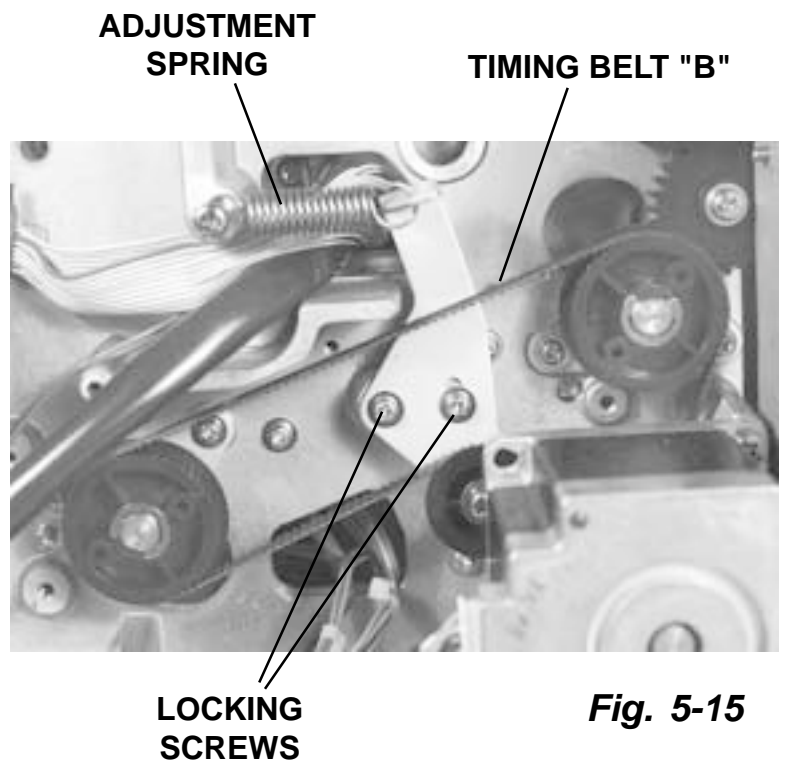
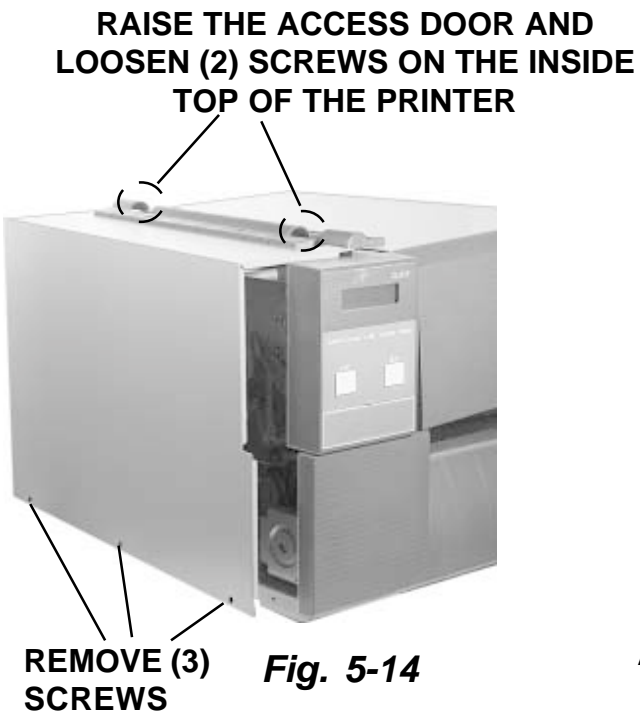

Fig. 5-13



5.7 Timing Belt Tension Adjustment

STEP	PROCEDURE
1.	Remove (3) screws holding the left side cover to the printer. Raise the access door and loosen the (2) screws on the inside top of the printer. Lift off the left side cover. Fig. 5-14
2.	Loosen the locking screws and belts will self-adjust. Tighten, but do not overtighten the screws. Fig. 5-15
3.	Replace the left side cover.



5.8 Head Latch Adjustment

The set-screws which attach the head latches to the latch shaft can become loosened during the operation of your printer. If you notice light printing on the left side of your labels, check the pairs of set-screws to be sure they are securely tightened.

To correct this problem:

Close the printhead and pull both latches so they are fully engaged to the latch posts. Tighten (2) set screws per latch.

Pairs of set-screws on each end of shaft must be tightened to avoid slippage of media and light printing on the left side of the labels

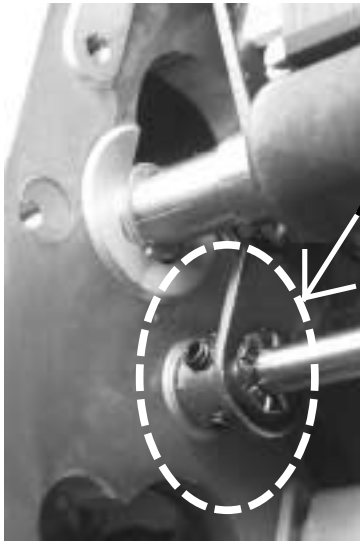
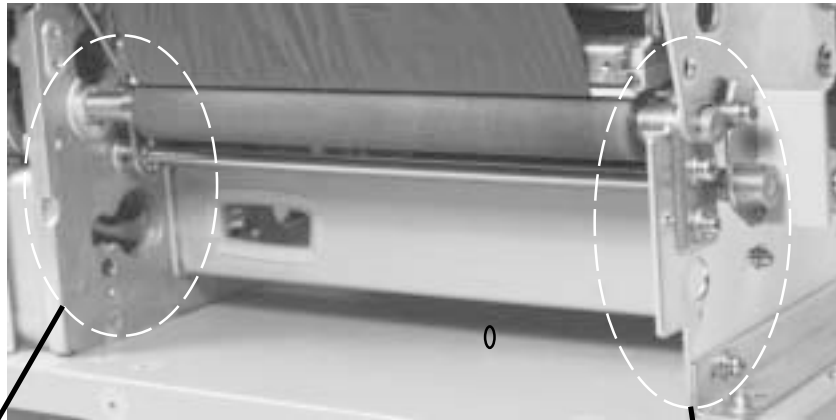

LATCHED
POSITION

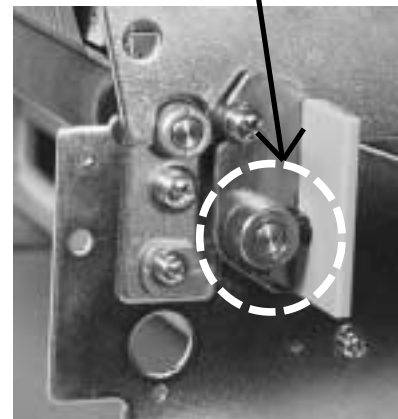

UNLATCHED
POSITION



5.9 Notch/Gap Sensor Adjustment

The CL-608e/612e printers can position labels using either a label gap (transmissive) or a Eye-Mark (reflective) sensor. The sensor used is selected by DSW2-2. (page 2-3) The gap sensor position can be adjusted over a limited range.

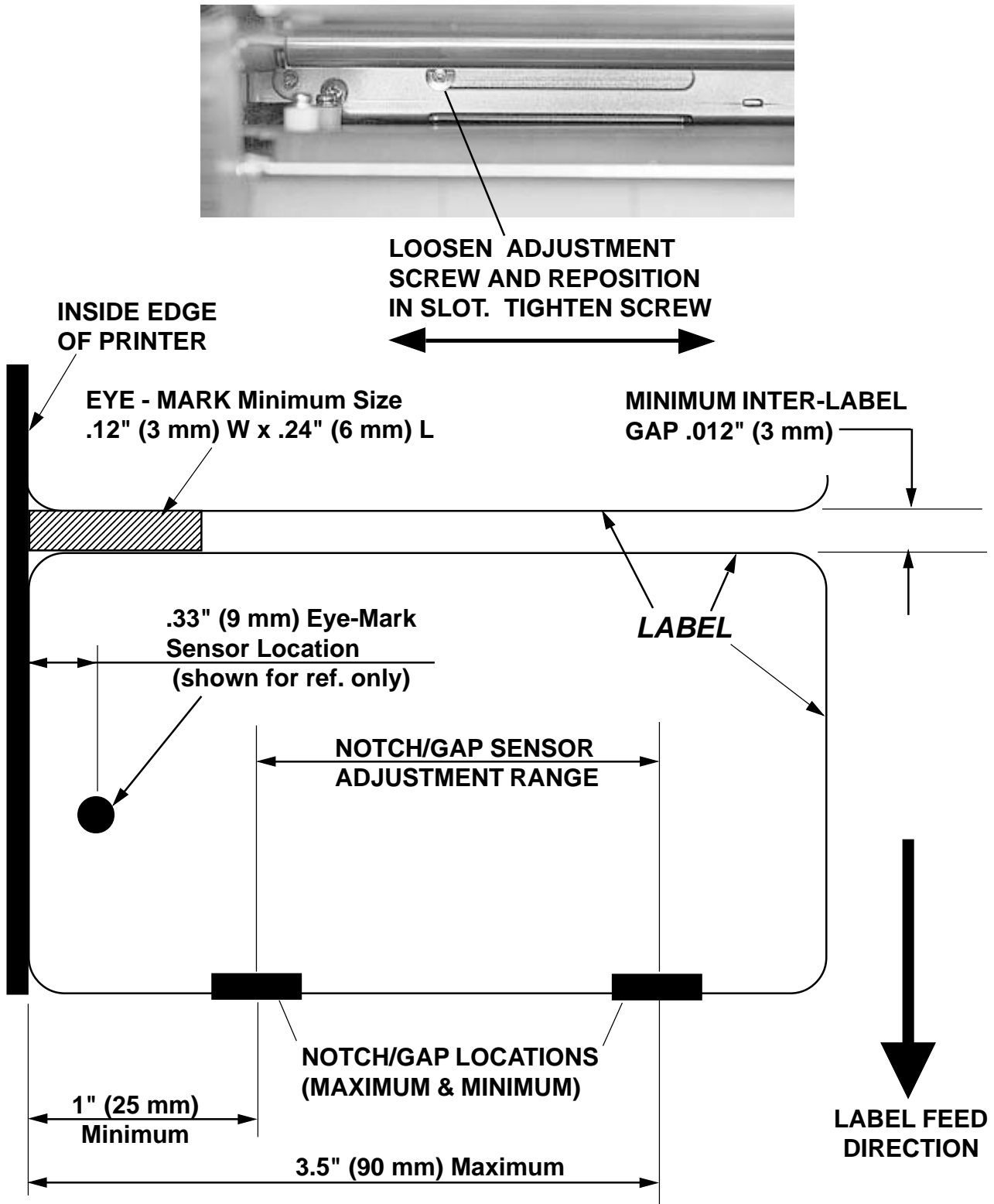



Section 6

Replacement Procedures

6.1 Overview

SATO CL608e/CL612e Printers contain replaceable components and sub-assemblies. This section contains step-by-step instructions for removing and replacing the following components and sub-assemblies.

- *Main Circuit Board*
- *Fuse(s)*
- *Power Supply*
- *Stepper Motor*
- *Timing Belts*
- *Print Head*
- *Platen*
- *Ribbon Drive Clutch Washers*
- *Ribbon Motion Sensor*
- *Paper End Switch*
- *Notch/Gap & Eye-Mark Switch*
- *Display Panel & Keyboard*

6.2 Replacing the Main Circuit Board

The Main Circuit Board contains the control electronics for the printers and is located behind L.H. cover of the printer. The I/O PCB interface and optional memory card unit if installed, which are attached to the main circuit board must first be removed.

NOTE: Many of the components on this board are susceptible to damage by static electricity. To avoid damage from static electricity, do not unpack new circuit boards from anti-static bags until instructed to do so and use a wrist grounding strap.

STEP	PROCEDURE
1.	Switch the printer OFF and disconnect the power cable.
2.	Remove (3) screws holding the left side cover to the printer. Raise the access door and loosen the (2) screws on the inside top of the printer. Lift off the left side cover to expose the main PCB. Fig. 6-1

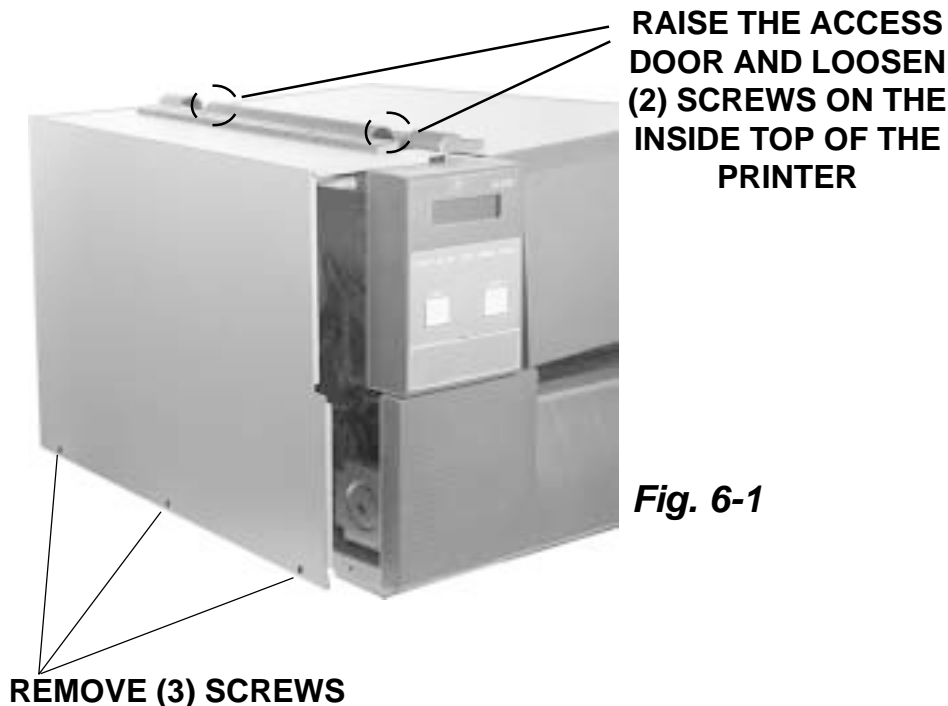

Replacing the Main Circuit Board

STEP	PROCEDURE
3.	Remove (2) screws holding the I/O PCB Interface from the back side of the unit. Pull away to detach the connector on the interface from the main circuit board. Figs. 6-2
4.	Remove (2) screws to detach the main circuit board. Figs. 6-2
5.	Note cable connection locations, then carefully disconnect the cables from the main circuit board. Figs. 6-3
6.	Remove (3) screws holding the PC Board to the frame. Remove the board from the printer. Figs. 6-3
7.	Locate the Flash Memory Module on the Main PC Board. Carefully press outward on the tabs on both ends of the Main PC Board Memory Frame to release the Memory Module PCB. The module should lift by itself when released. Remove the module from the frame. Note the indexing notches. Figs. 6-4 Set the Memory Module PCB aside for installing on the replacement Main PC Board.
8.	Install the Memory Module on the replacement Main PC Board. Note the indexing notches. Insert the module into the Main PCB Memory Frame at approximately 45° away from the Main PCB Board. Gently push down to snap into position. Figs. 6-5
9.	Reinstall the replacement PCB reversing Steps 1 through 5.
10.	Complete the Factory Reset Procedure.

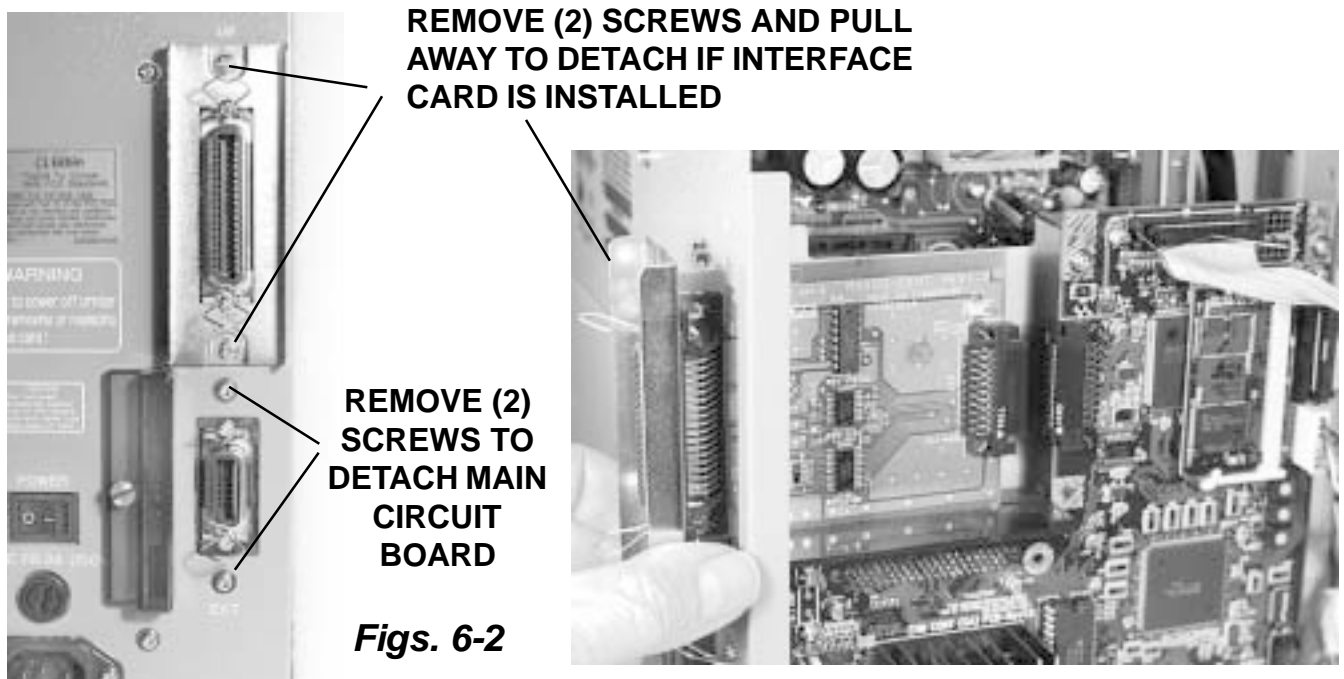

Replacing the Main Circuit Board

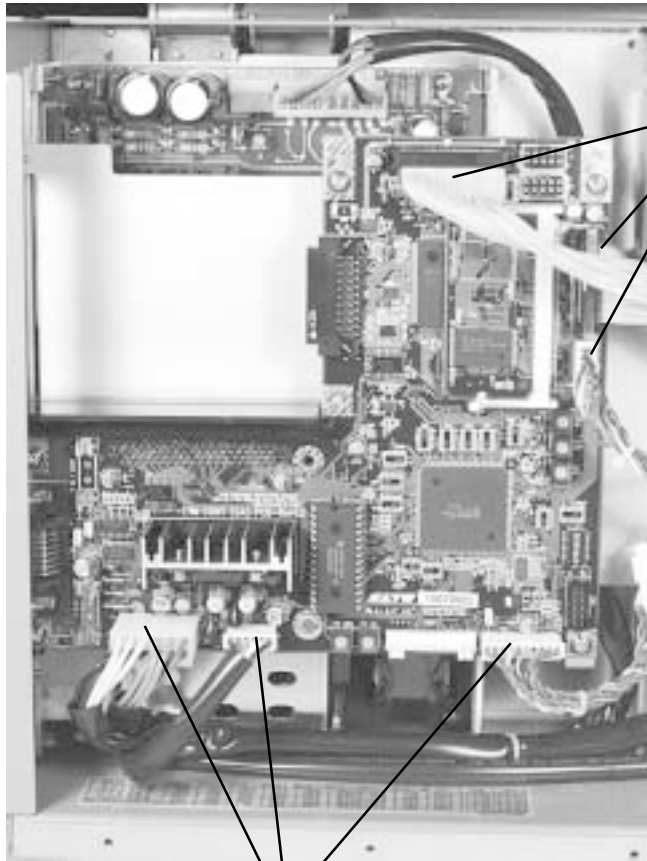

DISCONNECT CABLES

DISCONNECT CABLES

REMOVE (2) SCREWS



REMOVE SCREW

Figs. 6-3

Replacing the Main Circuit Board

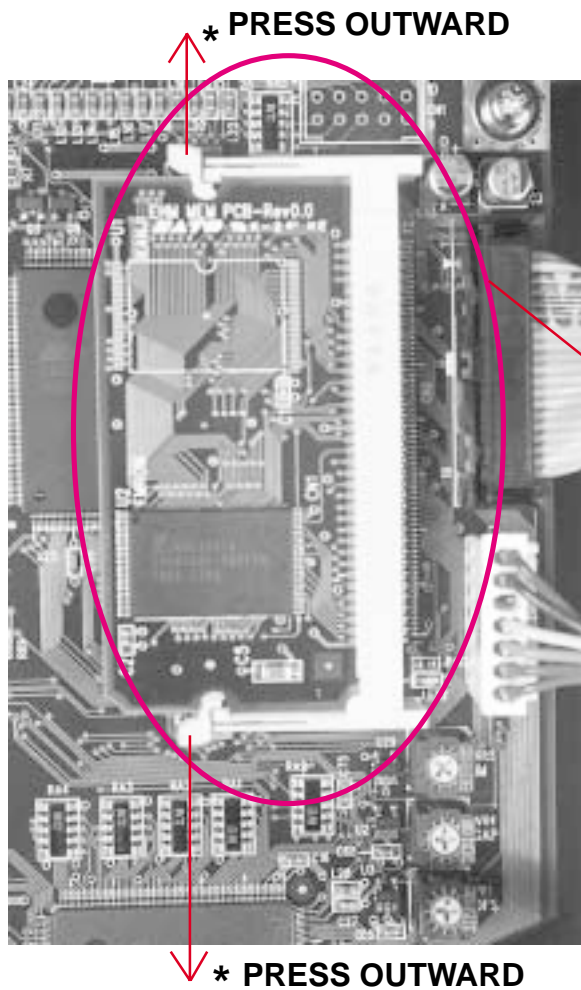

MEMORY MODULE PCB IN THE MAIN PCB MEMORY FRAME

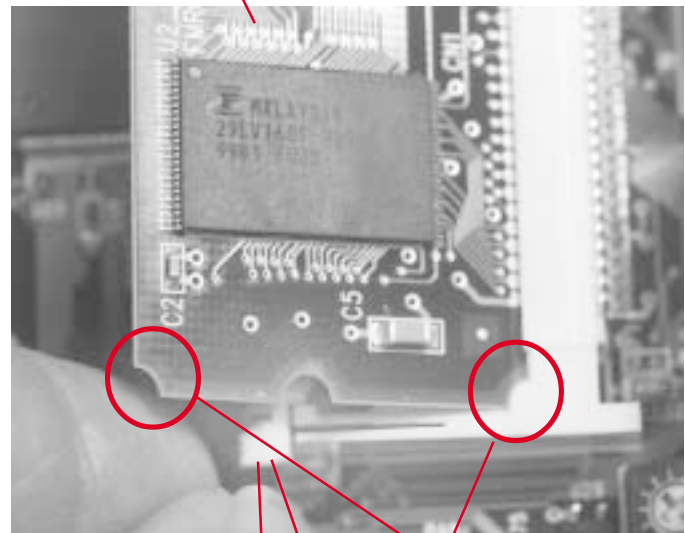

Figs. 6-4

* CAREFULLY PRESS OUTWARD ON TABS ON BOTH ENDS OF THE FRAME TO RELEASE THE MEMORY PCB.

Replacing the Main Circuit Board

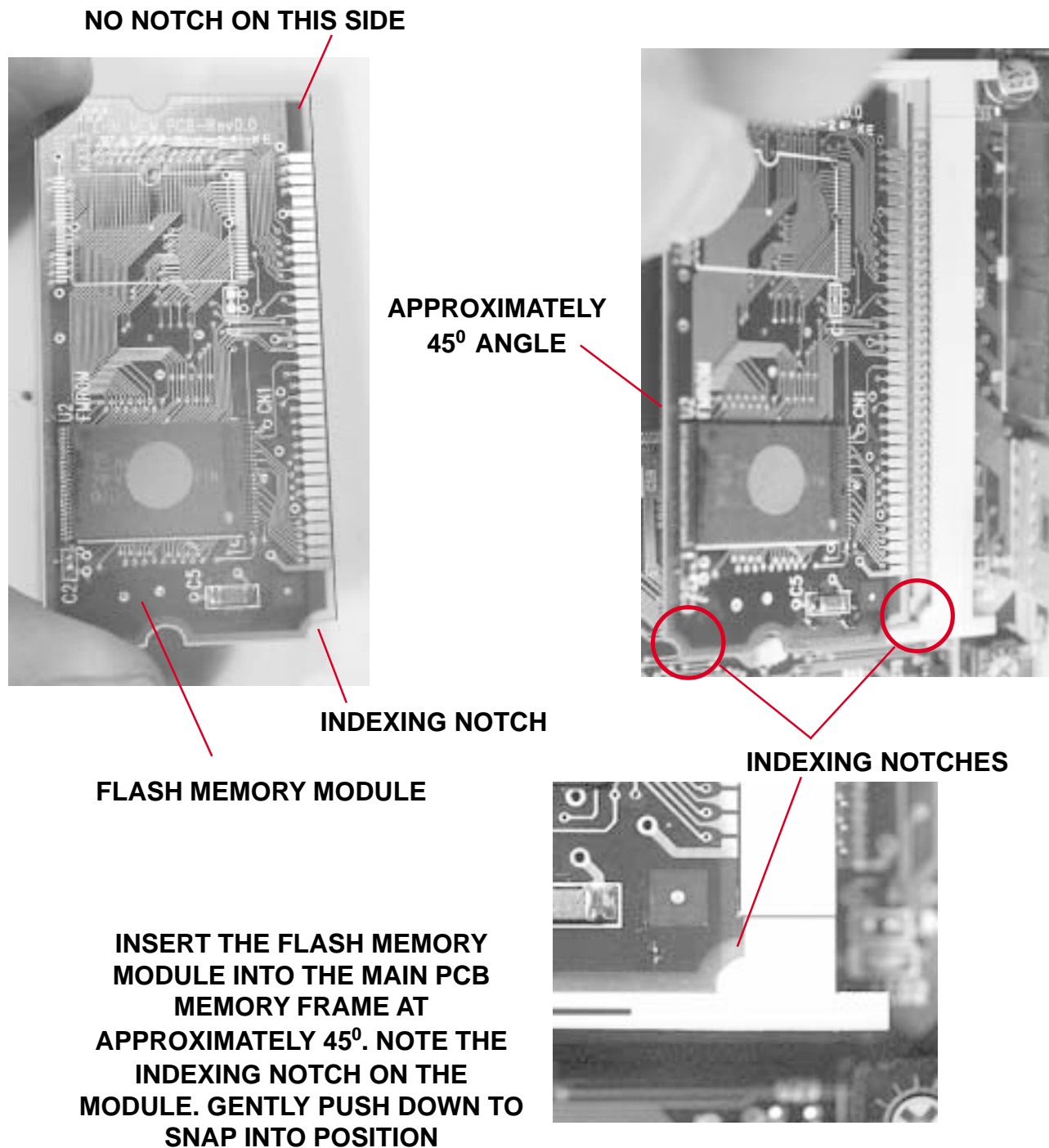

Figs. 6-5

6.3 Replacing the Fuses

Fuse replacement is described in the following section.

- 6.3.1 Removing and Replacing the Main Power Fuse
- 6.3.2 Removing and Replacing the Internal Fuse

NOTE: Before replacing a fuse, determine the cause of the overload condition.

6.3.1 Removing and Replacing the Main Power Fuse

Required: F3A, 250V Fuse Fuse

STEP	PROCEDURE
1.	Switch the printer OFF and disconnect the power cable.
2.	Locate the fuse cap on the back of the printer. Unscrew the cap and remove the defective fuse. Fig. 6-6
3.	Replace the fuse with one of equal rating (3A, 250V). Do not use a fuse with a higher rating.
4.	Screw the fuse cap back and connect the power cable.

BACK OF PRINTER

FUSE (UNDER COVER)



Fig. 6-6

Replacing the Fuses

Required: T3.15A, 250V Fuse or T1 Amp 250V Fuse

To remove and replace these fuse(s) do the following:

STEP	PROCEDURE
1.	Switch the printer OFF and disconnect the power cable.
2.	Remove (3) screws holding the left side cover to the printer. Raise the access door and loosen the (2) screws on the inside top of the printer. Lift off the left side cover to expose the main PCB. Fig. 6-1
3.	Refer to Fig. 6-7 and locate the appropriate fuse on the PCB.
4.	Remove and replace the fuse(s) with one of equal rating. Do not use a fuse with a higher rating.
5.	Replace the cover and replace the screws.
6.	Return the printer to service by reconnecting the power cable.

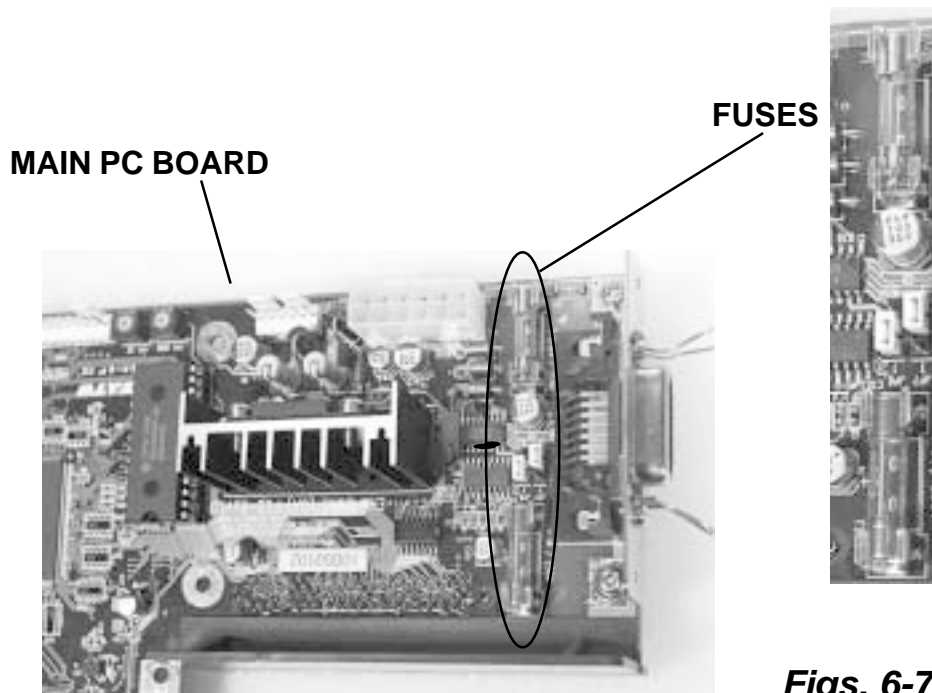

Figs. 6-7

6.4 Replacing the Power Supply

The Power Supply is a non-repairable component with no servicable parts and is to be replaced as a complete assembly.

STEP	PROCEDURE
1.	Switch the printer OFF and disconnect the power cable.
2.	Remove (3) screws holding the left side cover to the printer. Raise the access door and loosen the (2) screws on the inside top of the printer. Lift off the left side cover to expose the main PCB. Fig. 6-1
3.	Remove (2) screws holding the I/O PCB Interface from the back end of the unit. Pull away to detach the connector on the interface from the main PCB. Figs. 6-8
4.	Remove (2) screws to detach the main circuit board. Figs. 6-9
5.	Remove (2) screws to which secures the board mounting plate to the back side of the unit. Fig. 6-9
6.	Remove (2) screws to detach the Board Mounting Plate and carefully move out of the way of the Power Supply Assembly. Figs. 6-10 & 6-11
7.	Remove (2) screws to which secures the power supply to the back side of the unit. Fig. 6-12
8.	Lower the Media Holder in the mechanical section of the printer for access to (2) screws holding the power supply. Remove the screws. Figs. 6-13 & 6-14
9.	Detach (2) cable connections and remove the defective Power Supply. Fig. 6-15
10.	Install a replacement Power Supply reversing steps 1 through 9.
11.	Check the DC power voltages. Refer to Section 4.3.

Replacing the Power Supply

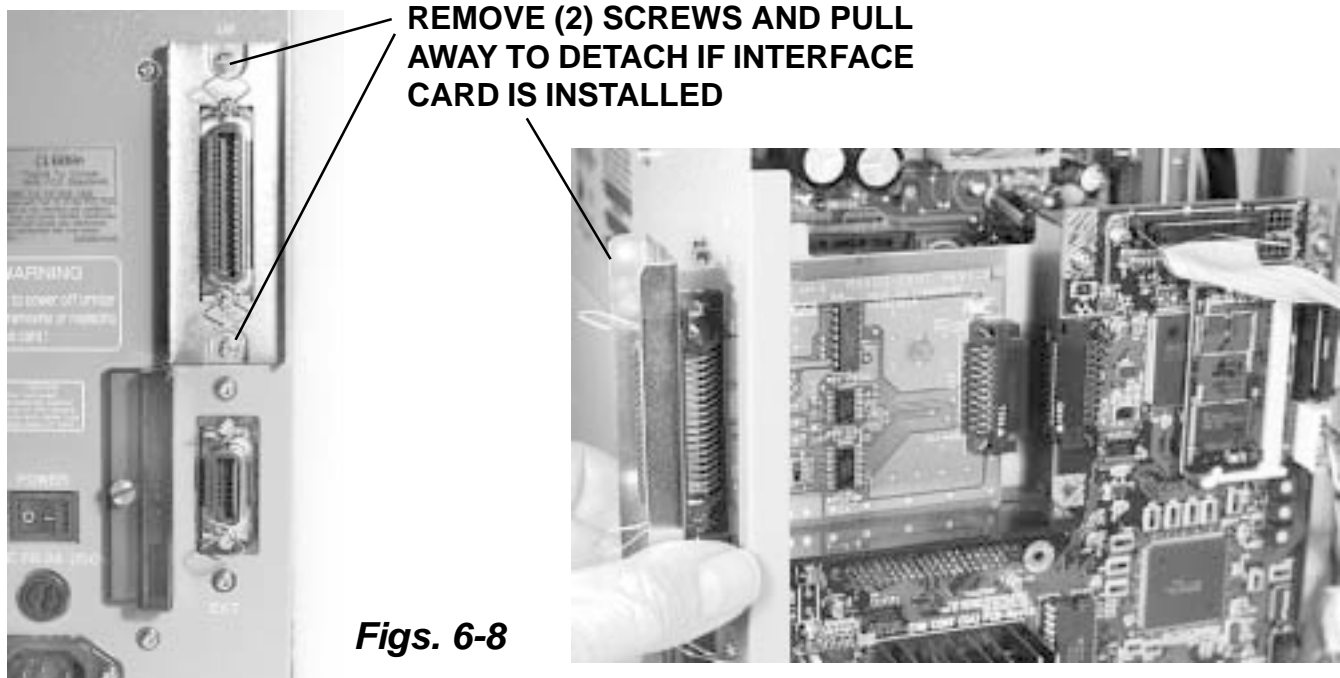

REMOVE (2) SCREWS

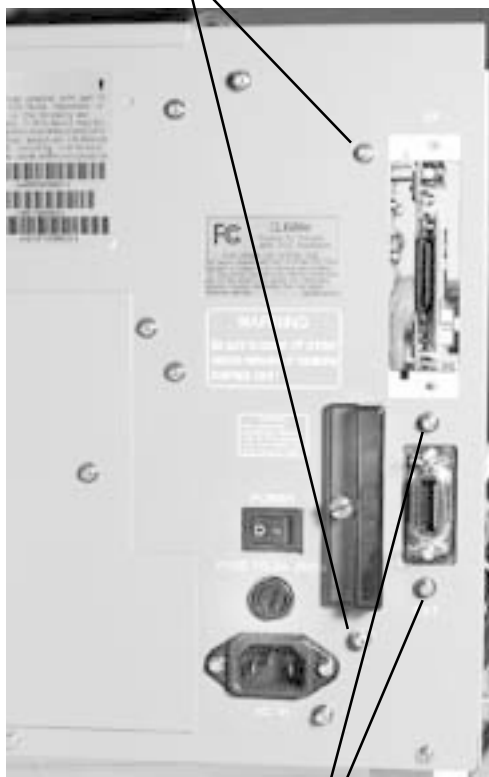

REMOVE (2) SCREWS TO DETACH MAIN CIRCUIT BOARD

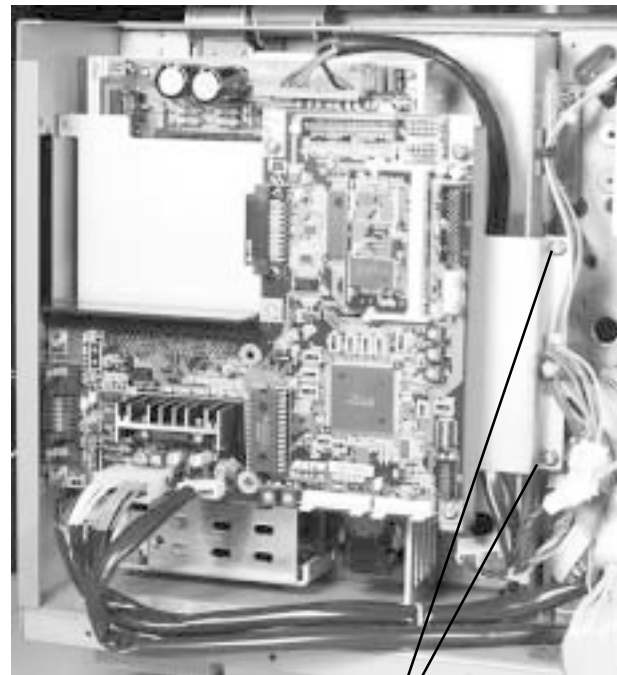

REMOVE (2) SCREWS

Fig. 6-10

Replacing the Power Supply



Fig. 6-11



Fig. 6-12

REMOVE MOUNTING PLATE
(WITH PCB ATTACHED) AND
MOVE AWAY FROM THE
POWER SUPPLY



Fig. 6-13

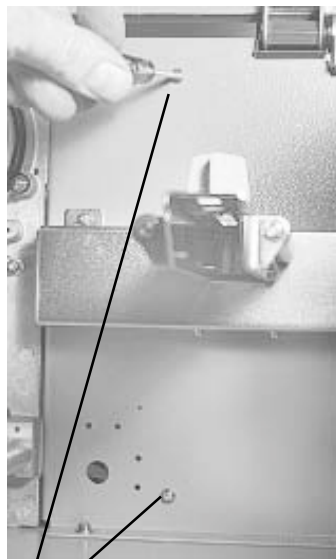

Fig. 6-14

LIFT OUT POWER
SUPPLY

DETACH CABLE



Fig. 6-15

6.5 Replacing the Stepper Motor

The Stepper Motor is used to transmit motion to the print mechanism for precise print positioning. The stepper motor transmits torque to the label feed roller, the platen roller, the ribbon feed roller, and the ribbon rewind spindle via a series of toothed timing belts and gears.

STEP	PROCEDURE
1.	Switch the printer OFF and disconnect the power cable.
2.	Remove (3) screws holding the left side cover to the printer. Raise the access door and loosen the (2) screws on the inside top of the printer. Lift off the left side cover to expose the main PCB. Fig. 6-1
3.	Remove (3) mounting screws holding the stepper motor to the frame. Detach the motor from the belt. Fig. 6-16
4.	Detach the motor cable connector from the main circuit board. Fig. 6-17
5.	Remove pulley unit from old motor and inspect for wear. Replace if necessary before reinstalling. Fig. 6-18
6.	Install replacement motor and belt. Belt will self adjust. Refer to Section 5.8. Attach motor cable connector to main circuit board.
7.	Replace the left side cover and reconnect the power cable.

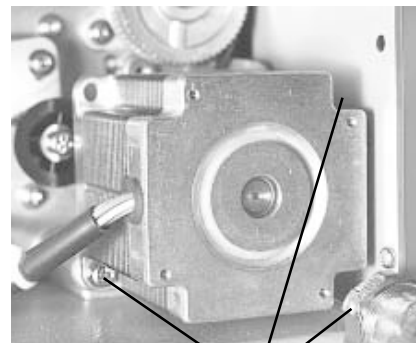

Fig. 6-16

REMOVE (3) MOUNTING SCREWS

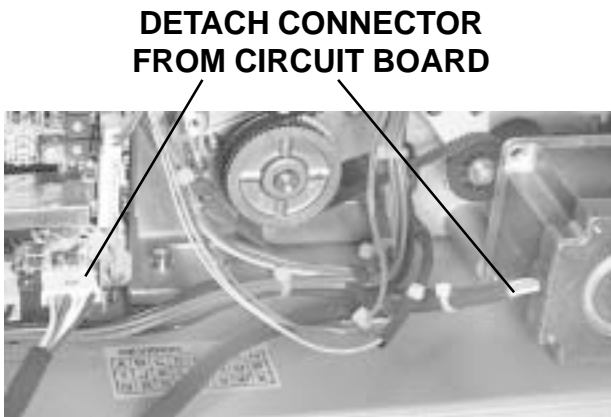

Fig. 6-17

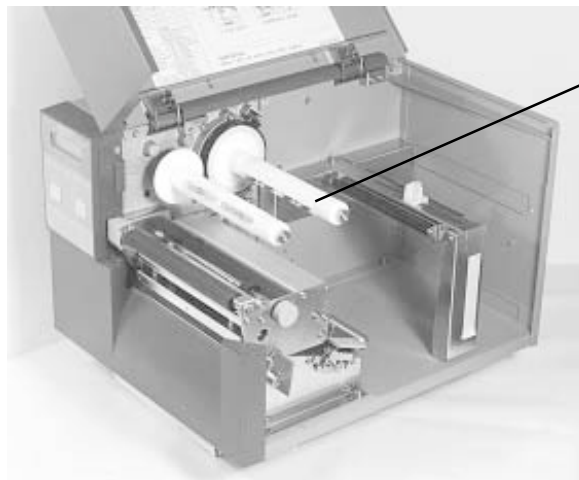

Fig. 6-18

REMOVE PULLEY FROM OLD UNIT AND TRANSFER OR REPLACE IF NECESSARY

6.6 Replacing the Timing Belts

STEP	PROCEDURE
1.	Switch the printer OFF and disconnect the power cable.
2.	Remove (3) screws holding the left side cover to the printer. Raise the access door and loosen the (2) screws on the inside top of the printer. Lift off the left side cover. Fig. 6-1
3.	Remove the ribbon and label stock if installed. Fig. 6-19
4.	Refer to Fig. 6-20 & 6-21 Locate Belts "A" and "B" in the electronics compartment.
5.	To remove and replace Belt "A", remove screw that attaches to the rewind spindle in the electronics compartment. Do not disturb two adjacent screws. These are used for fine adjustments only. Figs. 6-22
6.	In the mechanical section, gently pull the rewind spindle out to dislodge Belt "A". Figs. 6-22
7.	Inspect bearing for wear and replace as necessary.
8.	In the electronics section remove the belt from the gears. Install replacement belt. Figs. 6-23. Refer to Section 5.8 to adjust belts.
9.	To remove and replace Belt "B", loosen adjustment idler. Figs. 6-23 Dislodge Belt "B" from motor shaft and gears. Install replacement belt. Refer to Section 5.8 to adjust belts.
10.	Replace the left side cover and reconnect the power cable.



**REMOVE THE
RIBBON AND
LABEL STOCK**

Fig. 6-19

Replacing the Timing Belts

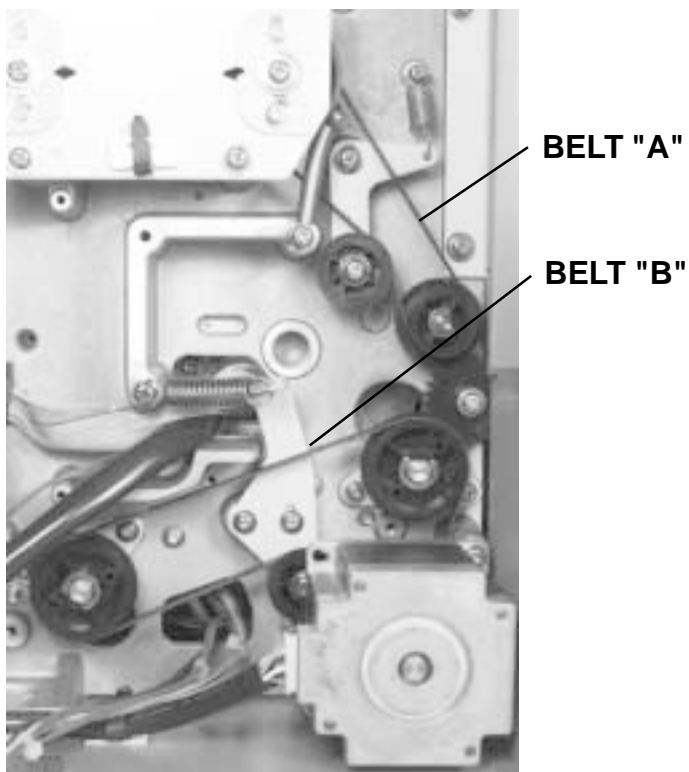

Fig. 6-20

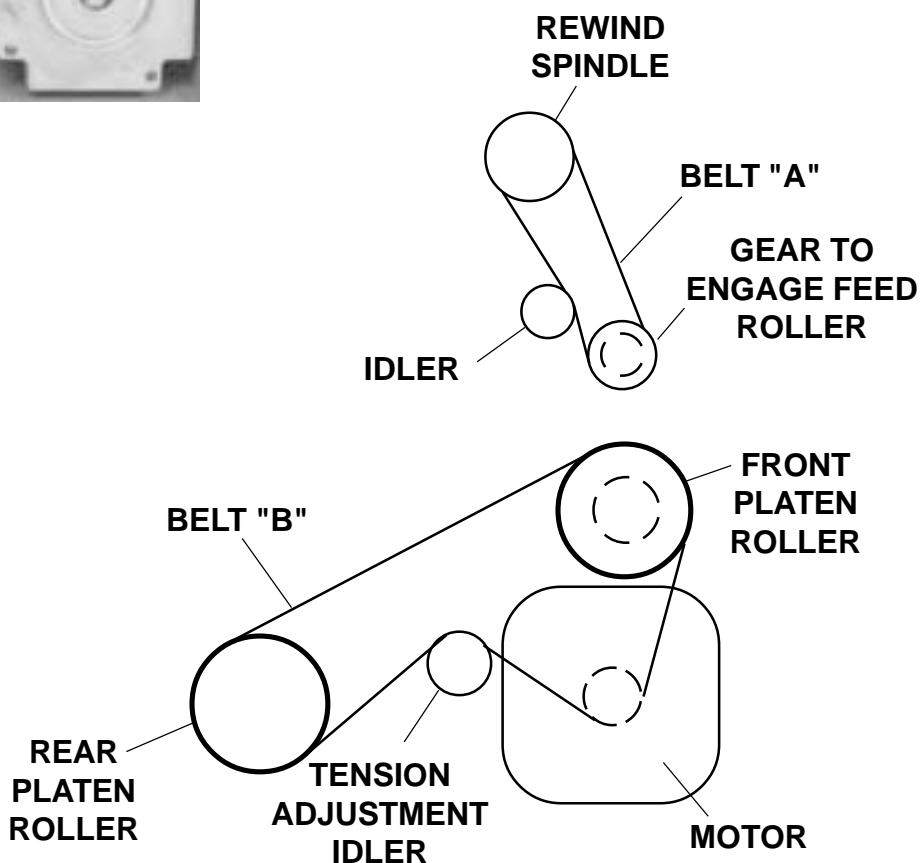
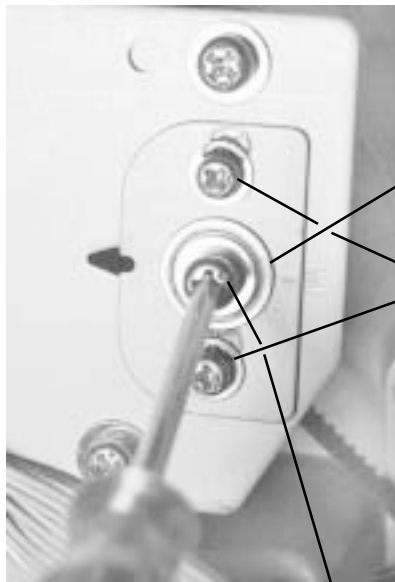

Fig. 6-21

Replacing the Timing Belts



BEARING

DO NOT DISTURB
THESE TWO
SCREWS

REMOVE SCREW
(ATTACHES TO
REWIND SPINDLE)

Figs. 6-22

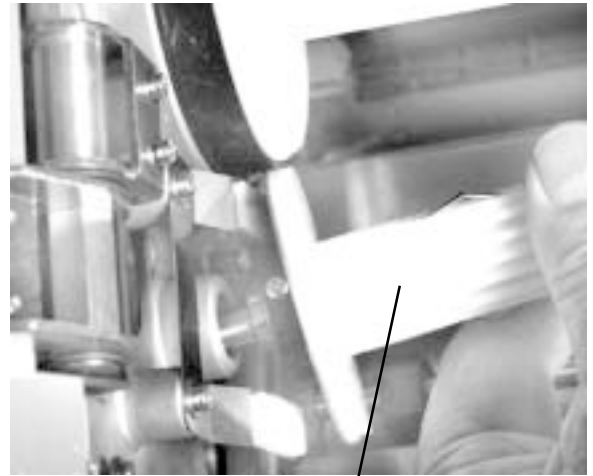

PULL REWIND SPINDLE
FORWARD TO
DISLodge BELT "A"

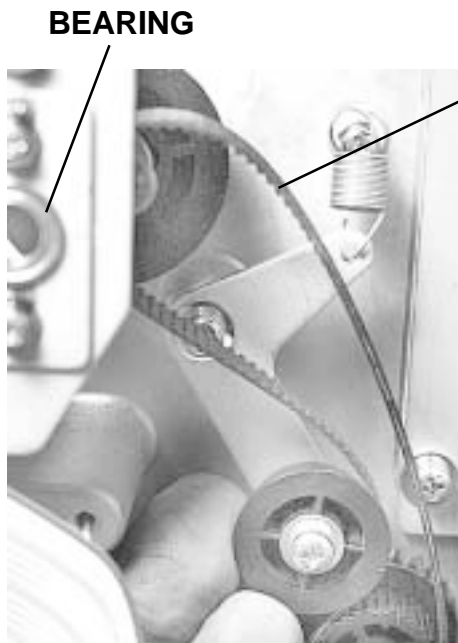

BEARING

REMOVE &
REPLACE
BELT "A"

Figs. 6-23

DISLodge BELT "B"
FROM MOTOR
SHAFT AND GEARS

LOOSEN
ADJUSTMENT
IDLER SCREWS

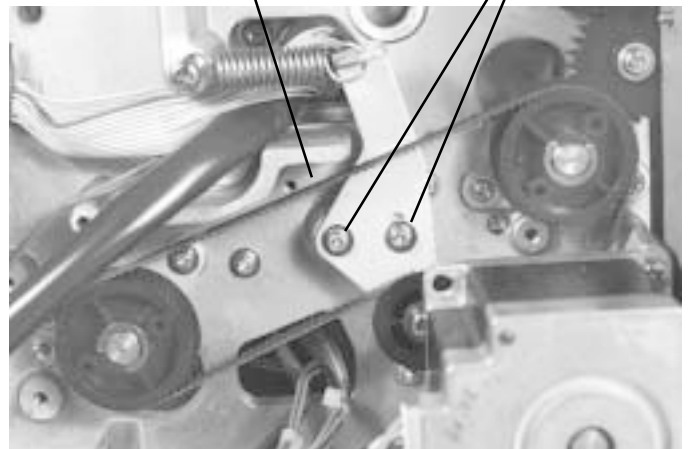

6.7 Replacing the Print Head

If the print head becomes damaged, it can be easily removed and replaced. No critical adjustments are required. Before you replace the print head, check the head counter values by printing a test pattern (Refer to Page 2-32).

STEP	PROCEDURE
1.	Switch the printer OFF and disconnect the power cable.
2.	Raise the access door and remove the ribbon and label stock if installed. Fig. 6-24
3.	Close the Head Latch Lever to facilitate removal of the Print Head. Remove (2) stud screws. Fig. 6-24 & 6-25
4.	Carefully open the Head Latch Lever so that the Print Head will drop down. Fig. 6-26
5.	Dislodge and remove the Ribbon Guide Plate from the Print Head. Fig. 6-26
6.	Carefully disconnect the cables and remove the Print Head. Fig. 6-27
7.	Set the switch setting on the new Print Head to the right side position. Fig. 6-28
8.	Install the Print Head by reconnecting the Print Head Data Cable and Print Head Power Cable to the Print Head. Attach the Ribbon Guide Plate. Fig. 6-26 & 6-29
9.	Position the Print Head so it aligns properly with the alignment pins and Ribbon Guide Plate. Fig. 6-26 & 6-29
10.	Close the Head Latch Lever and reinstall the two stud screws.

Before you return the printer to normal service, you should perform the following procedures.

- Clear Counter Heads (Refer to Section 7.3).
- Confirm that head cables are connected and that they do not touch the head opening spring. Also confirm that you can open and close the head without restriction.
- Print test pattern (Refer to Page 2-32).

Replacing the Print Head

REMOVE (2)
STUD SCREWS



Fig. 6-25

REMOVE THE
RIBBON AND
LABEL STOCK

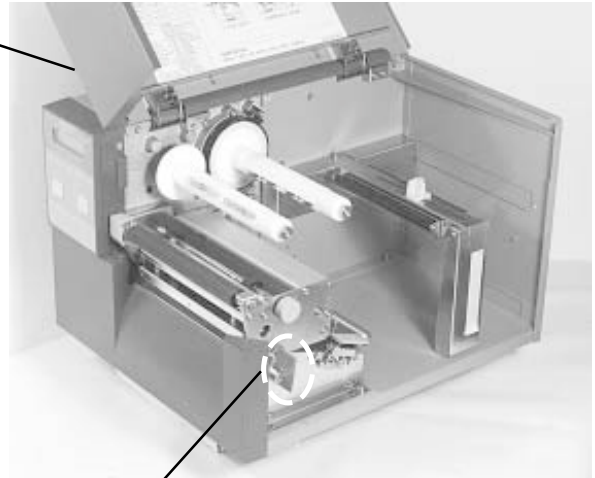

HEAD LATCH
LEVER

Fig. 6-24

DISLodge AND
REMOVE RIBBON
GUIDE PLATE



PRINT HEAD

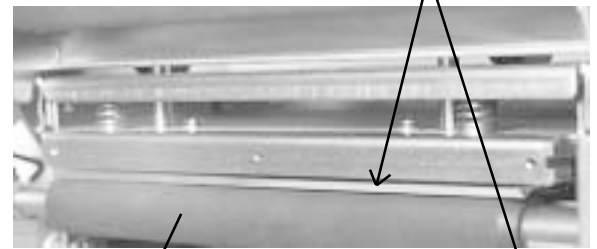

PLATEN

RIBBON GUIDE
PLATE

Fig. 6-26

DISCONNECT
CABLES



PRINT HEAD

Fig. 6-27

Replacing the Print Head

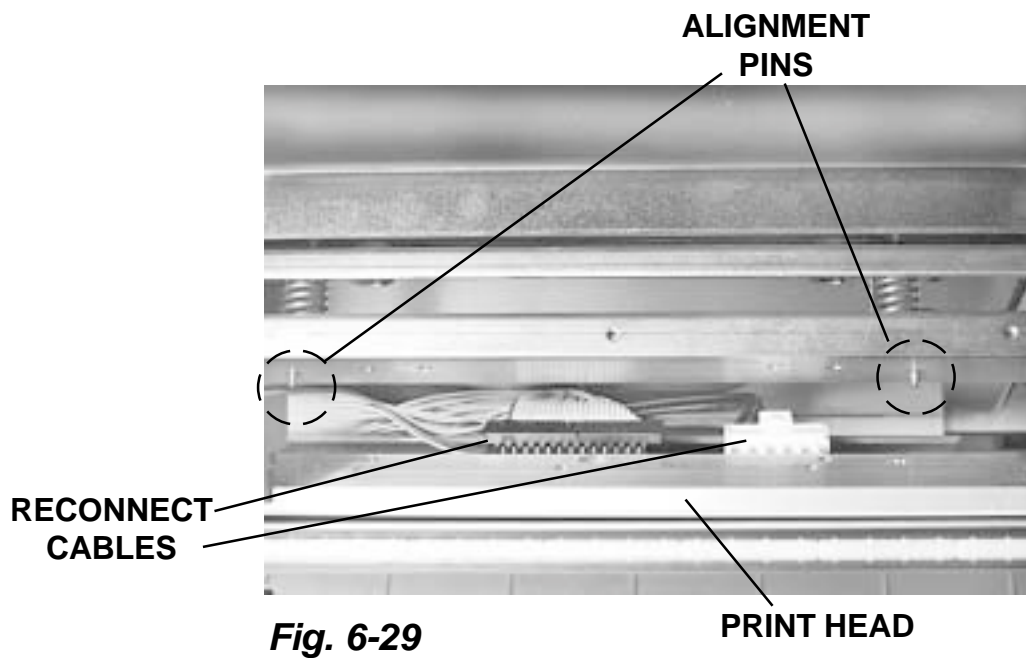
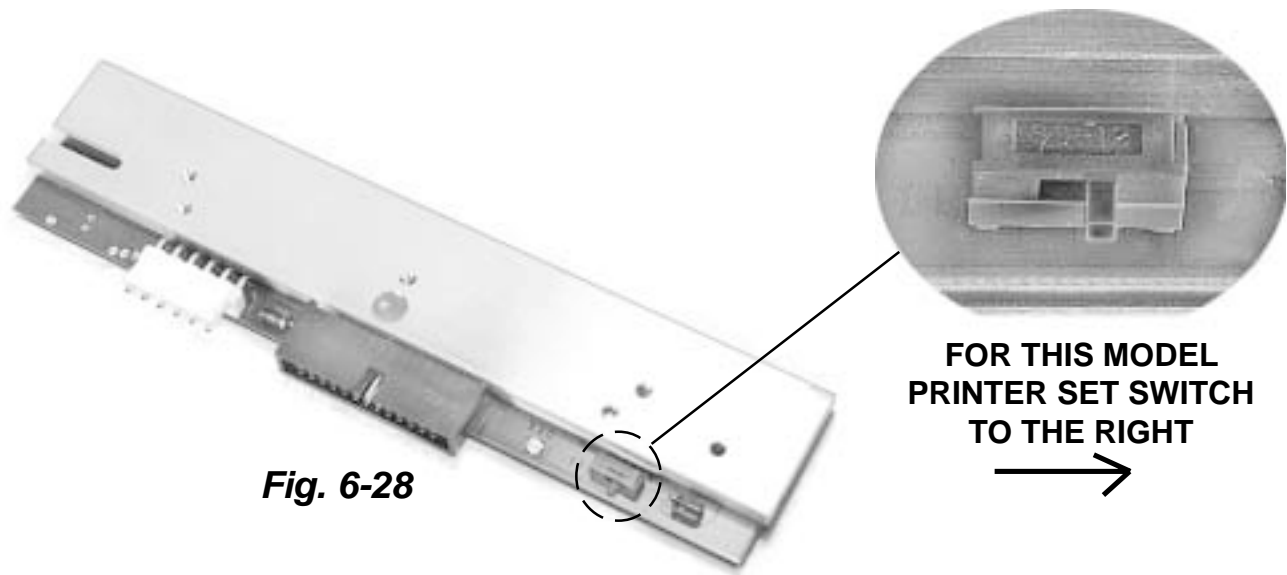

6.8 Replacing the Platen

STEP	PROCEDURE
1.	Switch the printer OFF and disconnect the power cable.
2.	Remove (3) screws holding the left side cover to the printer. Raise the access door and loosen the (2) screws on the inside top of the printer. Lift off the left side cover. Fig. 6-1
3.	Remove the ribbon and label stock if installed. Fig. 6-30
4.	Loosen but do not remove the screw holding clamp and platen to the frame. Fig. 6-31
5.	Slightly loosen screw holding eccentric adjustment. Fig. 6-31
6.	In the electronics compartment loosen (2) screws on tension idler to release tension on timing belts. Slide belt off platen gear. Fig. 6-32
7.	If unit is CL612, remove pulley from end of platen by loosening two set screws and sliding off shaft Fig. 6-33, 6-34
8.	Remove (2) screws holding the platen retainer to the frame. Fig. 6-35
9.	Displace platen by tilting up and away from the holding clamp in the mechanical section and pull forward through the hole in the frame and out the electronics compartment. Figs. 6-36 & 6-37
10.	Remove old bushings and replace with bushings from new platen.
11.	Install new platen by reversing removal procedure above. NOTE: It is important to verify that spring on head release lever is not under bushing holding plate but is properly positioned alongside it. Fig. 6-38, 6-39
12.	Reinstall platen pulley if applicable after inspecting for wear and replacing if necessary.
13.	Reinstall belts.
14.	Refer to Section 5.8 to adjust belts.
15.	Perform Print Head Balance adjustment Section 5.4.
16.	Replace the left side cover and reconnect the power cable.

Replacing the Platen



Fig. 6-30

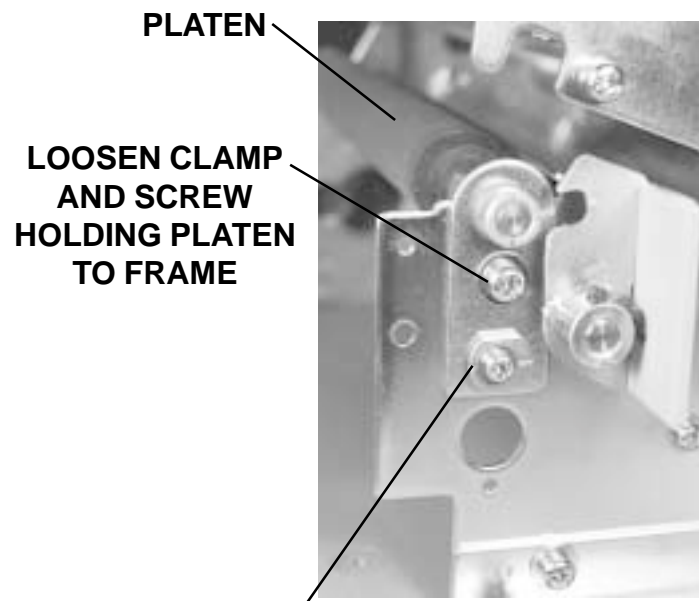

Fig. 6-31

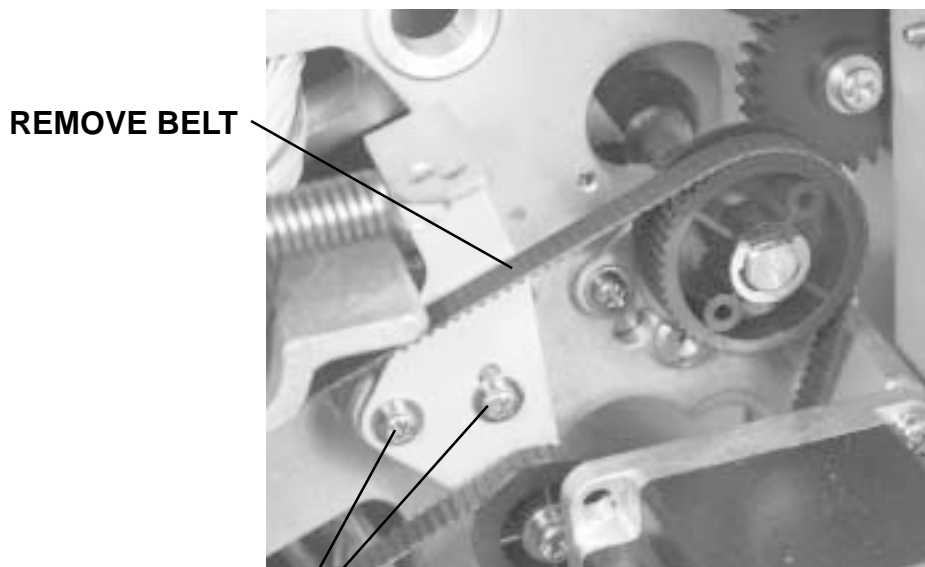

Fig. 6-32

Replacing the Platen

LOOSEN (2) SET SCREWS
AND REMOVE PULLEY
FROM END OF SHAFT

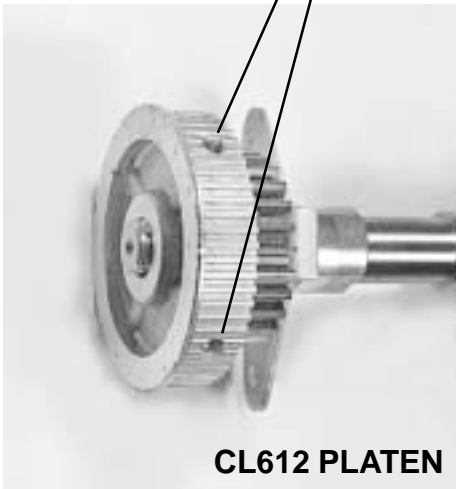

Fig. 6-33

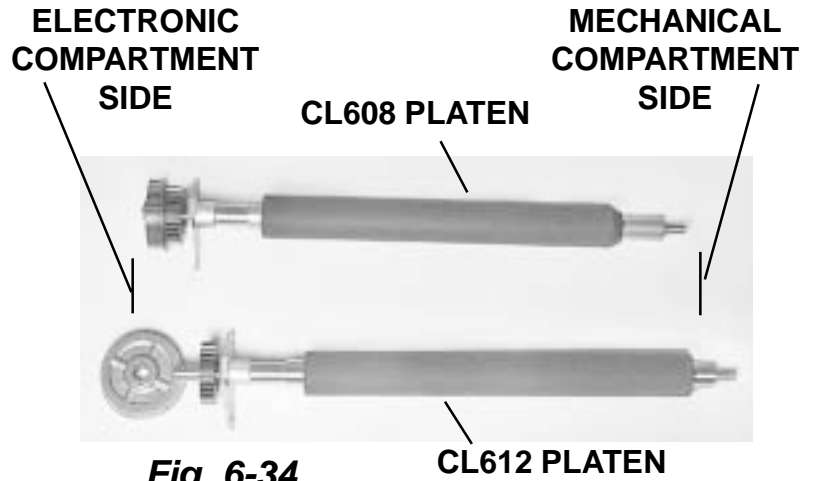

Fig. 6-34

REMOVE (2) SCREWS
HOLDING RETAINER
TO THE FRAME

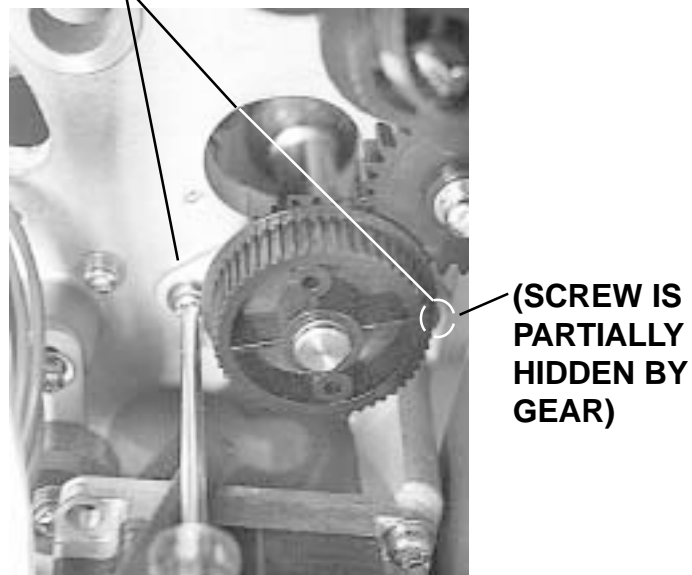

Fig. 6-35

Replacing the Platen

DISPLACE PLATEN BY
PULLING UP AND
AWAY FROM HOLDING
CLAMP



Fig. 6-36

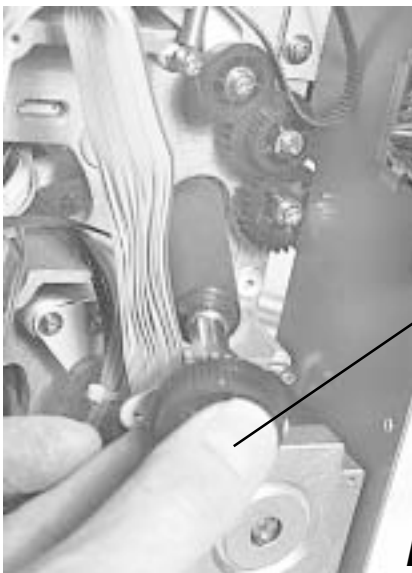

PULL PLATEN
THROUGH HOLE IN
FRAME AND OUT THE
ELECTRONICS
COMPARTMENT

Fig. 6-37

HOLDING CLAMP
WITH HEAD RELEASE
LEVER REMOVED
FOR CLARITY AND
SHOWING THE
SPRING IN CORRECT
POSITION

HOLDING CLAMP
WITH HEAD RELEASE
LEVER IN PLACE

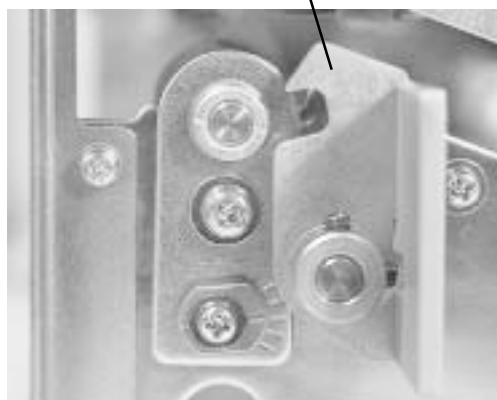

Fig. 6-38

BUSHING PLATE

SPRING END MUST
NOT BE UNDER
BUSHING PLATE

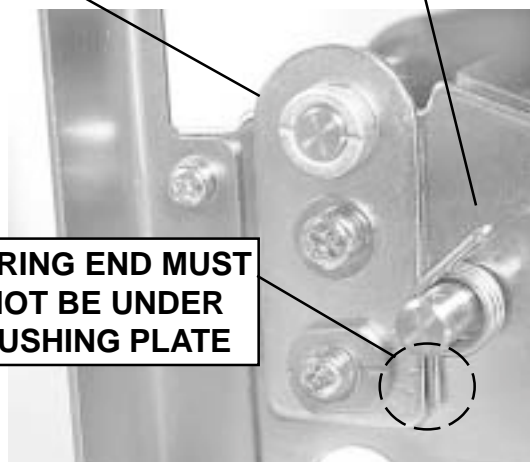

Fig. 6-39

6.9 Replacing the Ribbon Drive Clutch Washers

Both the ribbon unwind and the rewind drive spindles incorporate a friction clutch assembly to control tension. The friction washers within these clutch assemblies are replaceable. The procedure is identical for both the off-wind and the on-wind clutch assemblies.

DISASSEMBLE

STEP	PROCEDURE
1.	Switch the printer OFF and disconnect the power cable.
2.	Raise the main cover and remove the ribbon and label stock if installed. Fig. 6-40
3.	Remove the following parts from the two spindle shafts (in order). List 6A and Figs. 6-41 through 6-44
	NOTE: Disassemble one spindle at a time so that the other can be used for reference.

ITEM NO.	DESCRIPTION	QTY. EACH ASSY
1	Locking Screw	(1)
2	Adjustment Nut	(1)
3	Stopper Collar	(1)
4	Spring	(1)
5	Disc	(1)
6	Oil-less Dry Metal Washer	(1)
7	Collar	(3)
8	Ribbon Boss	(1)
9A & 9B	Disc Plate (each assy different)	(1)
10	Friction Washer	(1)
11	Hold Plate	(1)

List 6-A



Fig. 6-40

Replacing the Ribbon Drive Clutch Washers



Fig. 6-41 USE 12mm OPEN END WRENCH AND PHILLIPS SCREW DRIVER TO REMOVE THE LOCKING SCREW AND ADJUSTMENT NUT

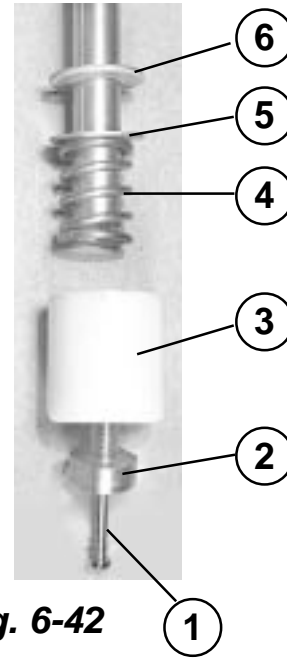

Fig. 6-42

REMOVE & INSTALL PARTS IN THIS ORDER (SEE ITEM LIST 6A)

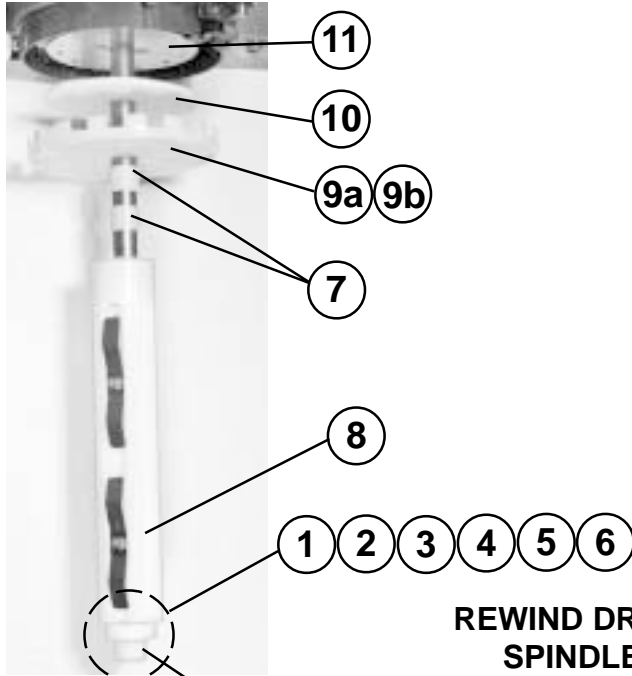

Fig. 6-43 CONTINUED FROM FIG. 6-42

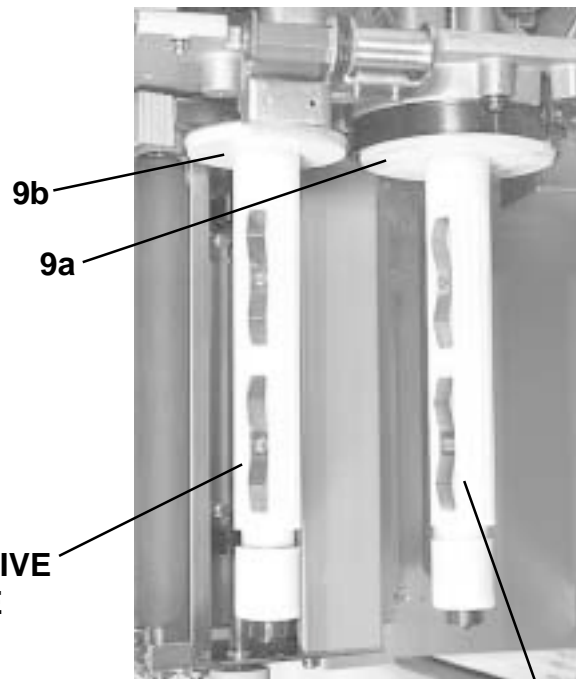

Fig. 6-44 UNWIND DRIVE SPINDLE

Replacing the Ribbon Drive Clutch Washers

ASSEMBLE

STEP	PROCEDURE
1.	For each spindle, position and fasten Item 11 Plate, with teeth facing outward with (2) screws. Except for Item 9, all items are the same for the ribbon unwind and ribbon rewind assemblies, List 6-A and Figs. 6-41 through 6-44.
2.	Install Item 10 Felt Friction Washer onto the Ribbon Shaft and slide it against Item 11 Plate. The jagged teeth on Item 11 Plate will "dig into" the felt washers. Slide (1) Item 9a or 9b Wind or Unwind Disc Plates onto each Ribbon Shaft. The teeth/slots on the unwind disc plate must be face towards felt washer. Fig. 6-45 & 6-46
3.	Slide (2) Item 7 Collars onto the Ribbon Shaft and against Item 9a or 9b Wind or Unwind Disc Plates. NOTE: The collars may still be inside the ribbon boss. List 6-A and Fig. 6-43
4.	Slide Item 8 Ribbon Bosses onto the Ribbon Shaft. Align the pegs on Item 8 with the location holes on the Item 9a/9b disc plates. Slide the 3rd Item 7 Collar onto the shaft and into Item 8 Ribbon Boss. List 6-A, Fig. 6-43 and Fig. 6-47
5.	Install Item 6 Oil-less Dry Metal Washer onto the ribbon shaft with the frictionless coated side facing outward away from Item 8. Align the hole on Item 6 Washer with the peg on Item 8 Ribbon Boss. List 6-A, Fig. 6-43 and Fig. 6-48
6.	Install Item 5 Disc onto the ribbon shaft with the smooth side facing Item 6 Washer, (one side of the disc is smooth and the other side has rough edges). List 6-A and Fig. 6-42
7.	Place Item 4 Spring next on the shaft, then Item 3 Stopper Collar. List 6-A and Fig. 6-42
8.	Screw Item 2 Adjustment Nut clockwise into the end of the ribbon shaft until it just touches the stopper collar. Fig. 6-41 & 6-42 NOTE: Do not over-tighten the adjustment nut since this screw is used to adjust the clutch tension. Adjust the clutch tension as outlined in Section 5-2
9.	Install Locking screw. Hold Adjust nut with 12mm wrench while tightening screw to avoid changing clutch adjustment.
10.	Reconnect the power cable.

Replacing the Ribbon Drive Clutch Washers

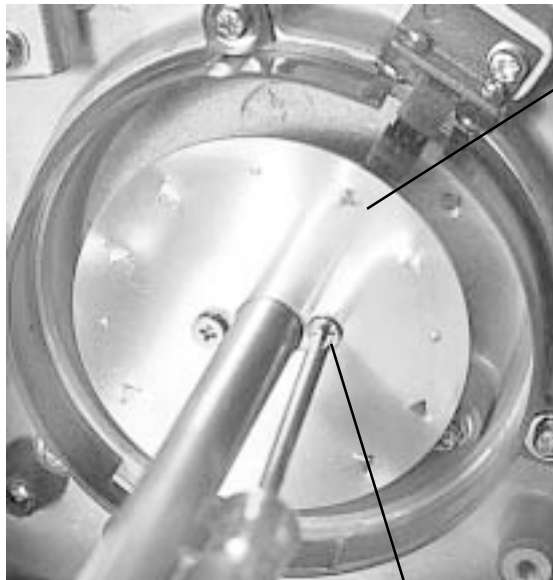

Fig. 6-45
FASTEN ITEM 11
WITH (2) SCREWS

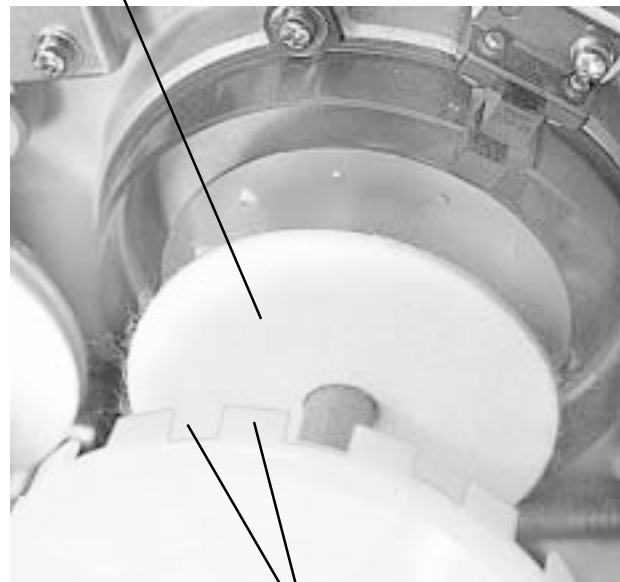

Fig. 6-46
TEETH/SLOTS ON
ITEM 9a DISC PLATE
FACING TOWARDS
FELT WASHER

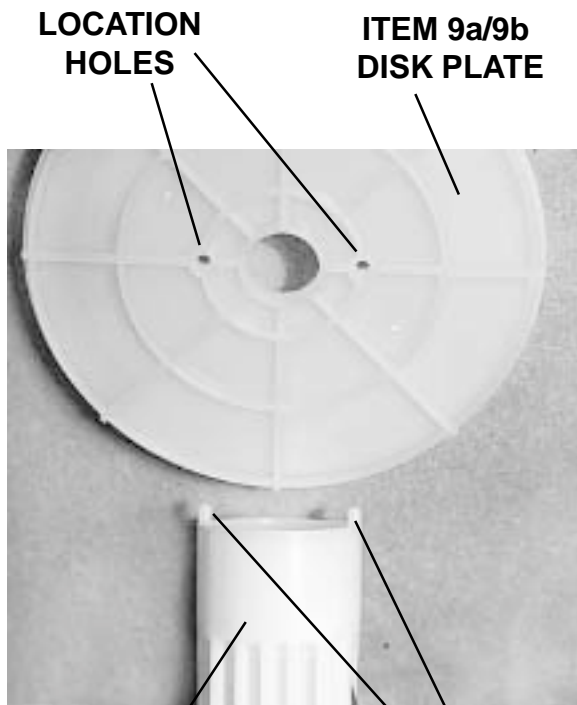

Fig. 6-47
ITEM 8 RIBBON
BOSS
INSERT PEGS INTO
LOCATION HOLES

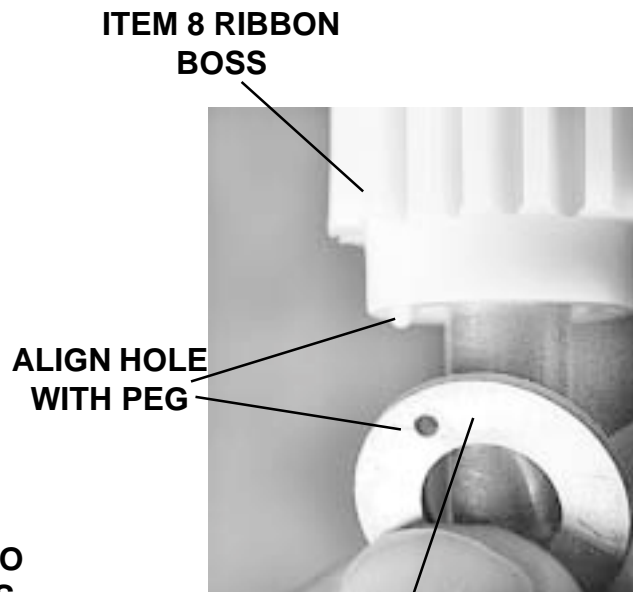

Fig. 6-48
ITEM 6 OIL-LESS
WASHER

6.10 Replacing the Ribbon Motion Sensor

The Ribbon Motion Sensor is easily replaced for service.

STEP	PROCEDURE
1.	Switch the printer OFF and disconnect the power cable.
2.	Remove (3) screws holding the left side cover to the printer. Raise the access door and loosen the (2) screws on the inside top of the printer. Lift off the left side cover to expose the main PCB. Refer to Section 4-2.
3.	Remove the ribbon and label stock if installed. Fig. 6-49
4.	Remove the sensor mounting screw Figs. 6-50 & 6-51
5.	Unplug the SEN4 connector from the PCB harness and pull the sensor cable and connector through the frame hole. Figs. 6-52 & 6-53
6.	Remove (2) screws holding the sensor to the bracket. Figs. 6-54 & 6-55
7.	Replace sensor and reattach to the mounting bracket. Feed new sensor connector back through the frame hole and reattach SEN4 on the PCB. Attach the sensor bracket to the frame insuring alignment pin is in correctly. Fig. 6-50
8.	Replace the left side cover and reconnect the power cable.

**REMOVE THE
RIBBON AND
LABEL STOCK**

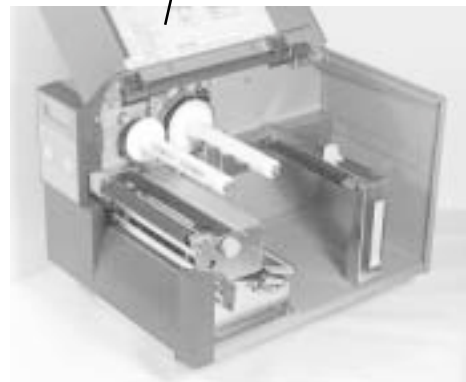
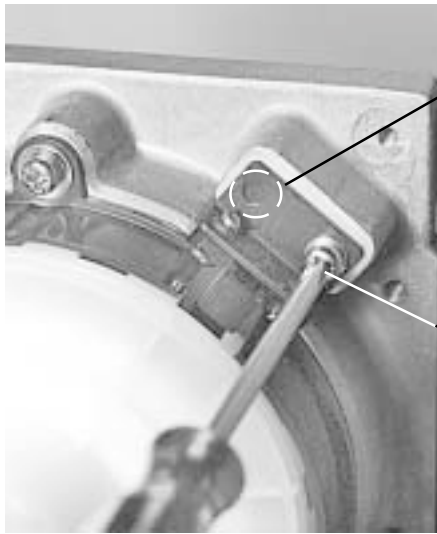

Fig. 6-49

Replacing the Ribbon Motion Sensor



ALIGNMENT PIN

REMOVE SCREW

Fig. 6-50

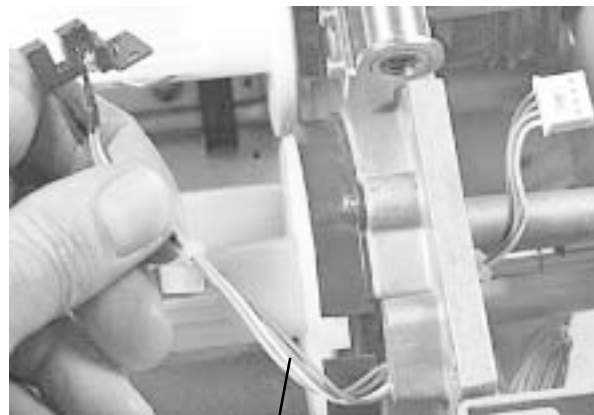

Fig. 6-51



UNPLUG SEN4
FROM THE PCB
HARNESS

Fig. 6-52



PULL THE SENSOR CABLE
AND CONNECTOR
THROUGH THE FRAME HOLE

Fig. 6-53

Replacing the Ribbon Motion Sensor

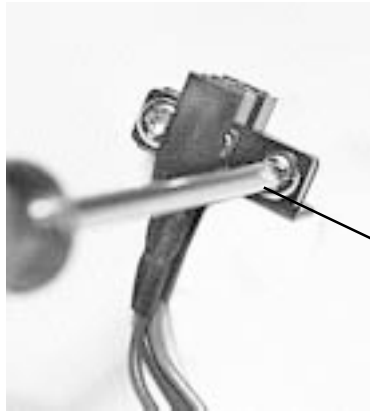

**REMOVE (2) SCREWS
HOLDING SENSOR TO
THE BRACKET**

Fig. 6-54



**DISASSEMBLED RIBBON
MOTION SENSOR AND
MOUNTING BRACKET**

Fig. 6-55

6.11 Replacing the Paper End Switch (Micro-Switch) and the Bottom Half of the Notch/Gap and Eye-Mark Sensors

MEDIA HOLD DOWN COVER
(SHOWN IN RAISED POSITION)
CONTAINS THE TOP HALF OF
THE NOTCH/GAP SENSOR

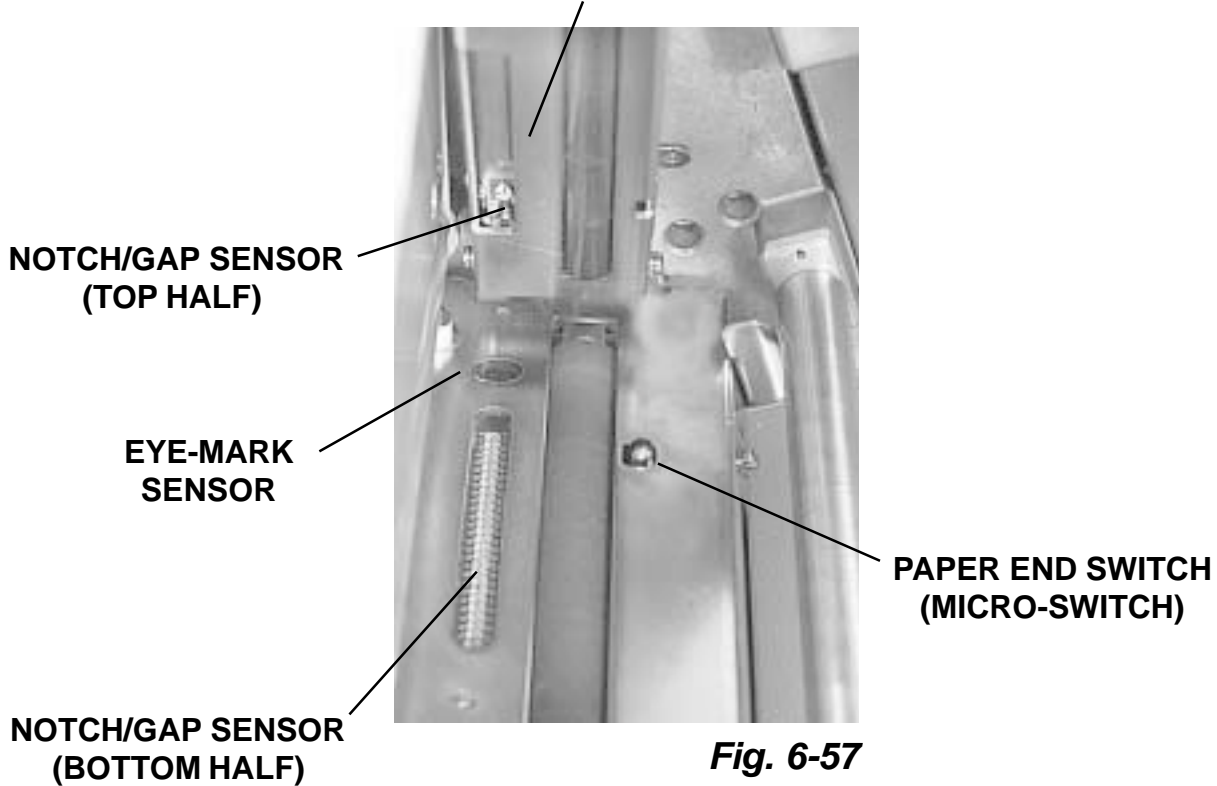

SENSOR LOCATIONS

REMOVE THE
RIBBON AND
LABEL STOCK



Replacing the Paper End Switch (Micro-Switch) and the Bottom Half of the Notch/Gap and Eye-Mark Sensors

The Notch/Gap and Eye-Mark Sensors can be removed from the printer to clear label fragments and for service. No critical alignment is required when replacing these sensors.

STEP	PROCEDURE
1.	Switch the printer OFF and disconnect the power cable.
2.	Remove (3) screws holding the left side cover to the printer. Raise the access door and loosen the (2) screws on the inside top of the printer. Lift off the left side cover to expose the main PCB. Fig. 6-1
3.	Remove the ribbon and label stock if installed. Fig. 6-56
4.	Raise the media hold-down cover and locate the sensors. Fig. 6-57 Remove (3) screws to detach the ramp plate from the ramp frame (mechanical section). Fig. 6-58
5.	Loosen screws from idler gear plate for access to screw. Remove (3) screws to detach the opposite end of the ramp plate from back plate (electronics section). Fig. 6-59
6.	Detach connections from the main PCB harness to the sensors on the ramp plate.
7.	Carefully wiggle the ramp plate free from the ramp frame and the printer. Fig. 6-60
8.	Turn the ramp plate over to expose the sensors. Fig. 6-61
9.	To replace the Paper End Switch, remove (2) screws that attach the switch to the bracket. Install a replacement switch. Fig. 6-62
10.	To replace the bottom half of the Notch/Gap and Eye-Mark Sensors, remove (2) screws that attach the sensor board to the ramp plate. Install a replacement sensor board. Fig. 6-63 NOTE: If plastic windows are scratched or otherwise damaged, they should be replaced.
11.	Reattach the ramp plate to the ramp frame. Attach connections from the sensors to the PCB harness insuring that cable, (Paper End Switch), passes under the paper feed platen and the cable for the gap sensor is properly routed through notch in ramp plate.
12.	Replace the left side cover and reconnect the power cable.

Replacing the Paper End Switch (Micro-Switch) and the Bottom Half of the Notch/Gap and Eye-Mark Sensors

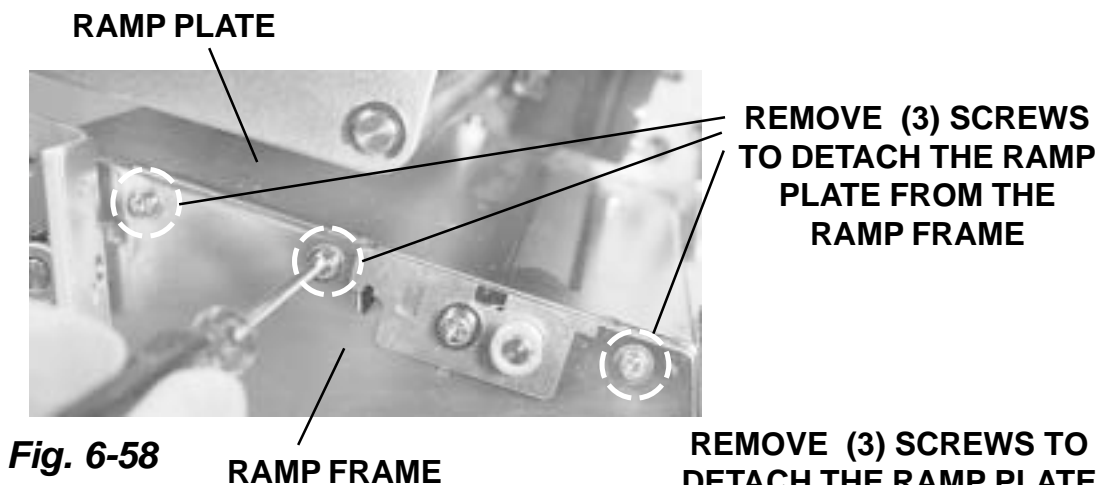

Fig. 6-58

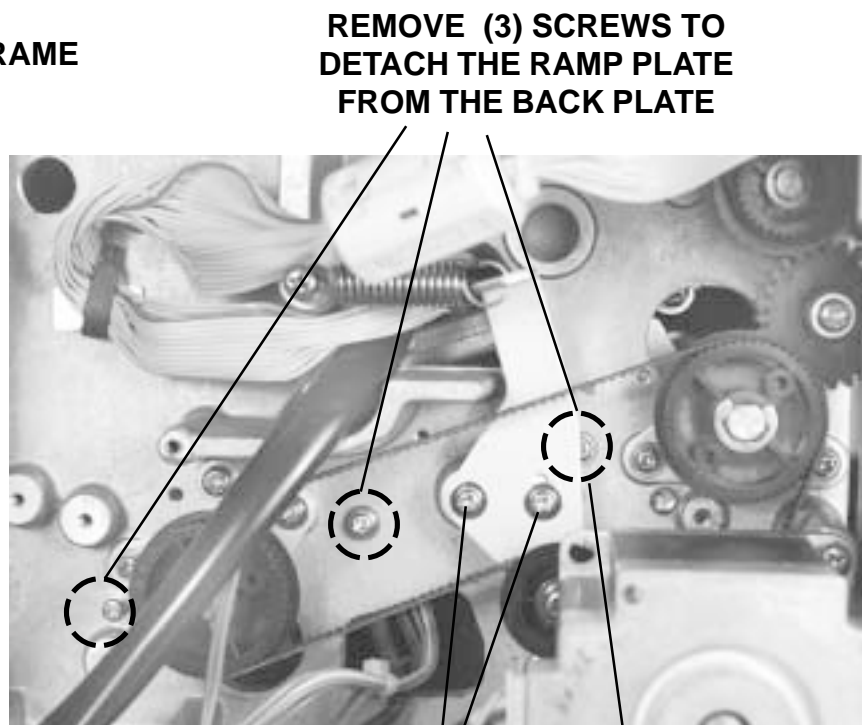

Fig. 6-59

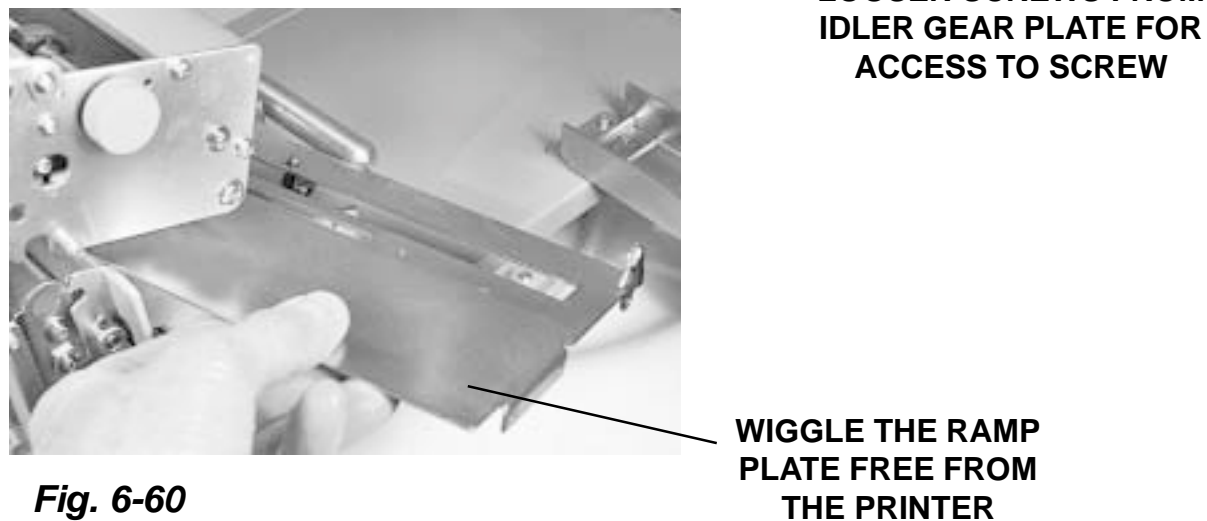

Fig. 6-60

Replacing the Paper End Switch (Micro-Switch) and the Bottom Half of the Notch/Gap and Eye-Mark Sensors

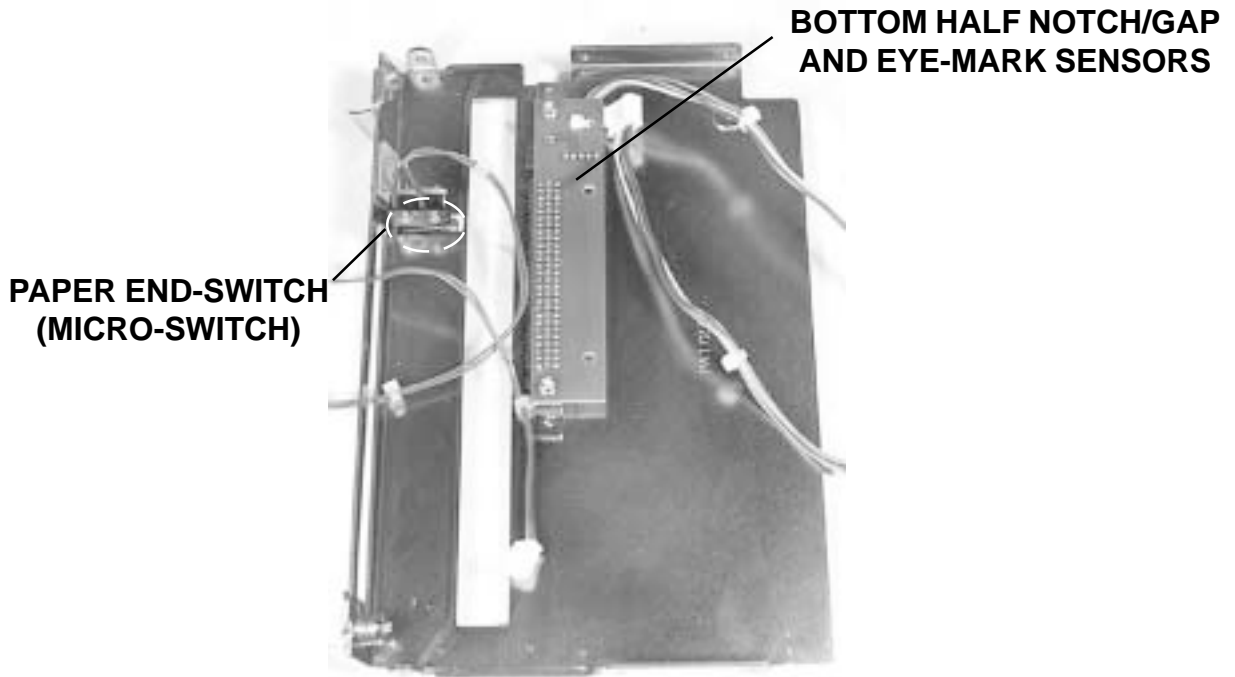

Fig. 6-61



Fig. 6-62

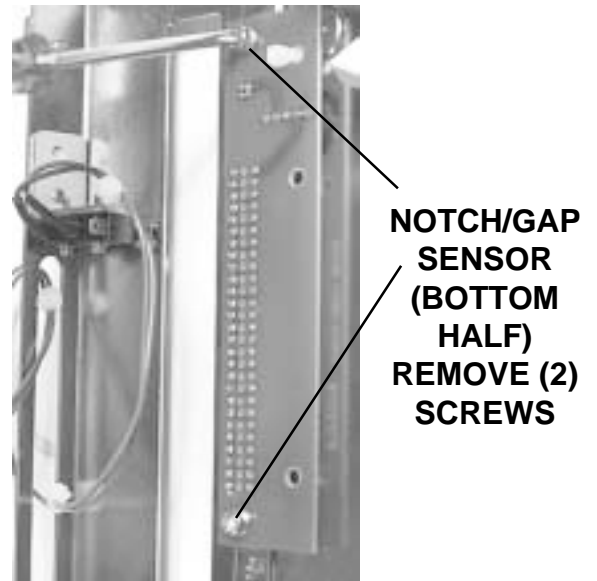

Fig. 6-63

6.12 Replacing the Top Half of the Notch/Gap Sensor

The media hold down cover contains the top half of the Notch/Gap Sensor and adjustment screws. It also contains the pressure roller.

STEP	PROCEDURE
1.	Switch the printer OFF and disconnect the power cable.
2.	Remove (3) screws holding the left side cover to the printer. Raise the access door and loosen the (2) screws on the inside top of the printer. Lift off the left side cover to expose the main PCB. Fig. 6-1
3.	Remove the ribbon and label stock if installed. Fig. 6-64
4.	Refer to Fig. 6-65 . In the electronics compartment locate and remove the screw holding the media hold-down unit (containing the top half of the Notch/Gap Sensor) to the frame. Detach connector from the sensor to the PCB and withdraw the cable through the frame hole. Remove the media hold-down unit. Fig. 6-66
5.	Remove (2) screws to open the media hold down cover to access the Notch/Gap Sensor. Fig. 6-67, 6-68 & 6-69
6.	Remove Allen head screw and Phillips head screw to detach bracket and sensor. Dislodge the bracket and sensor from the media hold-down shell noting correct routing of cable. Fig. 6-70, 6-71 & 6-73
NOTE: There is a small collar on the Allen head screw that must be installed. Fig. 6-72	
7.	Remove (2) screws to detach the Notch/Gap Sensor from the bracket. Fig. 6-74
8.	Install new sensor to bracket.
9.	Install bracket with sensor into media hold-down unit, insuring collar under Allen head screw is installed.
10.	Reattach the media hold-down cover. Reattach the media hold-down unit to the frame.
11.	Attach connector to the PCB, insuring proper routing through notch in ramp plate.
12.	Replace the left side cover and reconnect the power cable.

REMOVE THE RIBBON AND LABEL STOCK



Fig. 6-64

Replacing the Top Half of the Notch/Gap Sensor

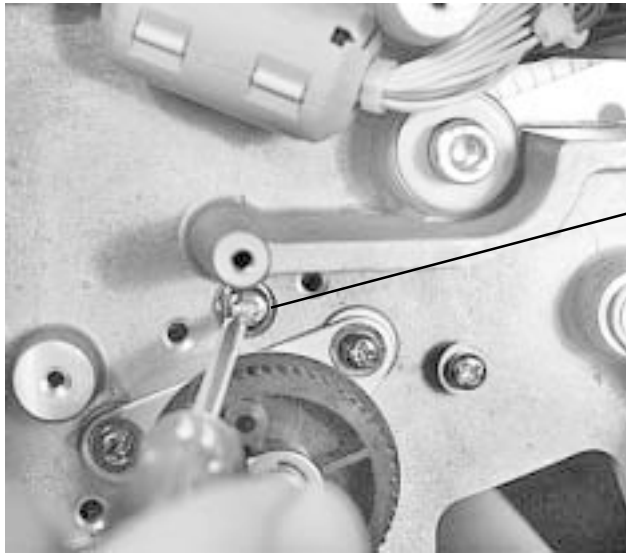

REMOVE SCREW TO
DETACH MEDIA HOLD
DOWN UNIT

REMOVE MEDIA
HOLD DOWN UNIT
FROM THE FRAME

Fig. 6-65



Fig. 6-66

REMOVE (2) SCREWS TO OPEN
COVER AND ACCESS THE
NOTCH/GAP SENSOR



Fig. 6-67

NOTCH/GAP SENSOR

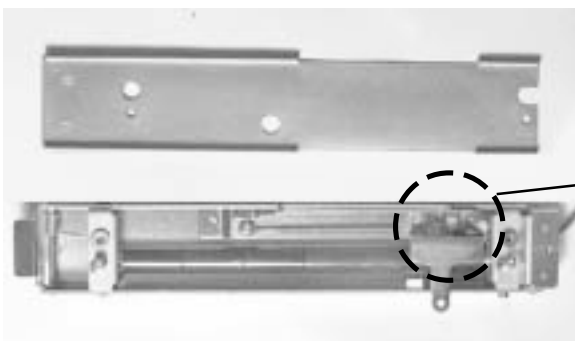

Fig. 6-68

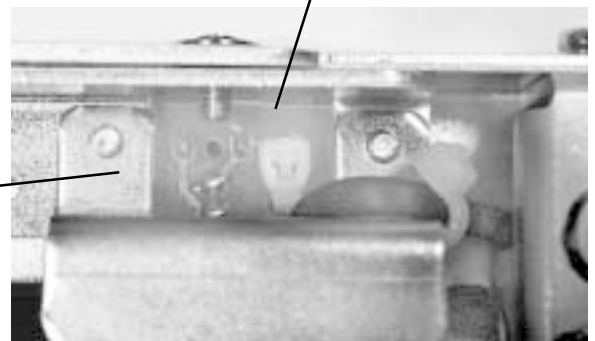

Fig. 6-69

Replacing the Top Half of the Notch/Gap Sensor

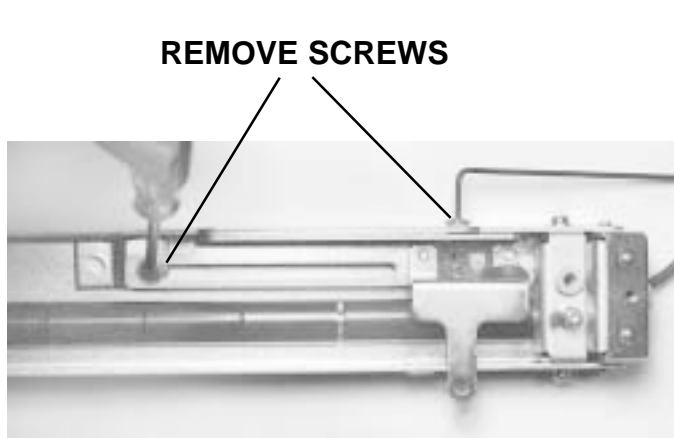

Fig. 6-70

ALLEN HEAD
SCREW

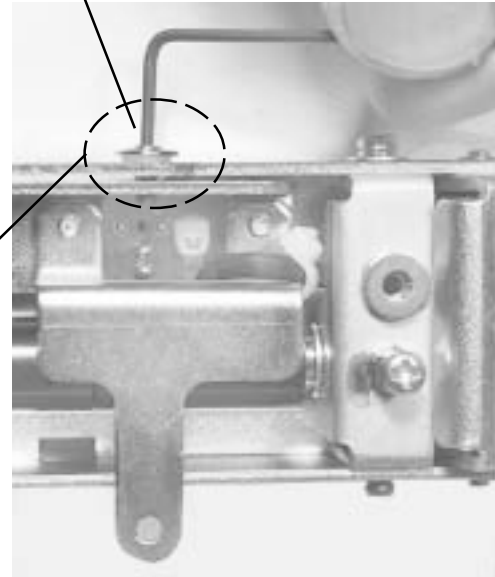
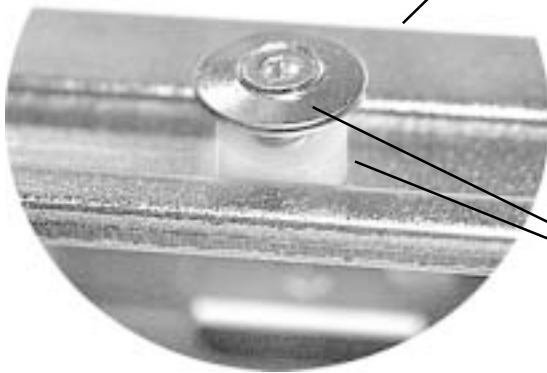

Fig. 6-71



ALLEN HEAD
SCREW WITH
COLLAR

Fig. 6-72

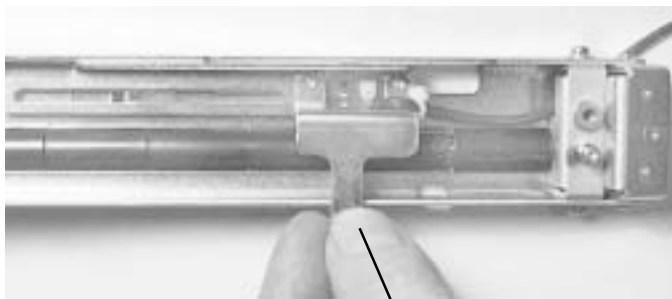

Fig. 6-73

DISLODGE BRACKET
WITH SENSOR

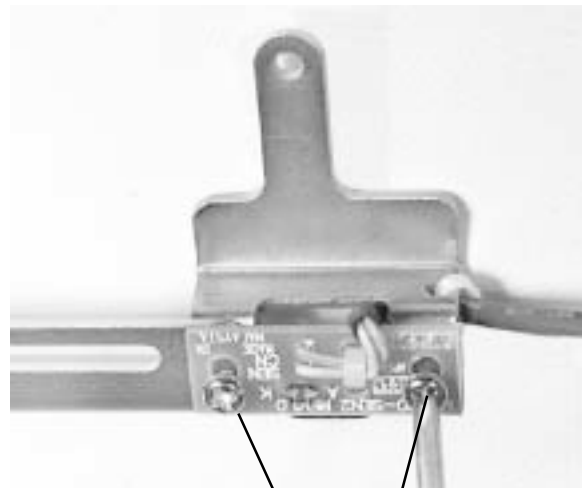

Fig. 6-74

REMOVE (2) SCREWS TO
DETACH SENSOR FROM
BRACKET

6.13 Replacing the Display Panel or Keyboard

STEP	PROCEDURE
1.	Switch the printer OFF and disconnect the power cable.
2.	Remove (3) screws holding the left side cover to the printer. Raise the access door and loosen the (2) screws on the inside top of the printer. Lift off the left side cover to expose the main PCB. Fig. 6-1
3.	Raise the access door. Remove (1) screw from the cover that is attached to the frame. The location is where the platen goes through the casting. Fig. 6-75 & 6-76
4.	Remove (2) screws from cover. Fig. 6-77
5.	In the electronics compartment, detach cable marked KB from the Display Panel back.
6.	Remove (2) screws from the back plate that is secured to the cover and the Display Panel Assembly. Fig. 6-78 Rotate forward and lift to detach the cover. Fig. 6-79
7.	In the mechanical section, remove (1) screw that attaches the Display Panel Assembly to the frame. Fig. 6-80
8.	Remove (2) screws from the bottom of the Display Panel Assembly. Fig. 6-81
9.	Lift to remove the Display Panel Assembly. Fig. 6-82
10.	Install a replacement display panel or keypad.
11.	Reinstall Display Panel Assembly using screws previously removed.
12.	Reconnect KB cable to the display after reinstalling assembly.
13.	Reinstall Cover.
14.	Replace the left side cover and reconnect the power cable.

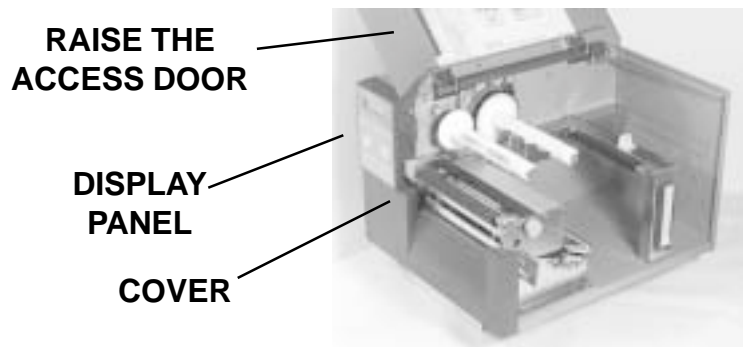
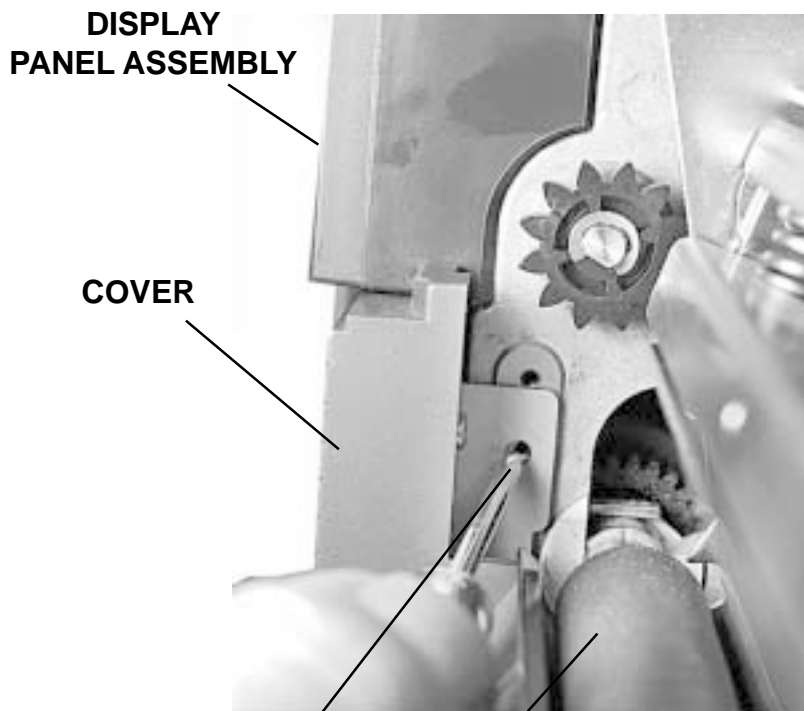

Fig. 6-75

Replacing the Display Panel or Keyboard



REMOVE (1) SCREW

Fig. 6-76

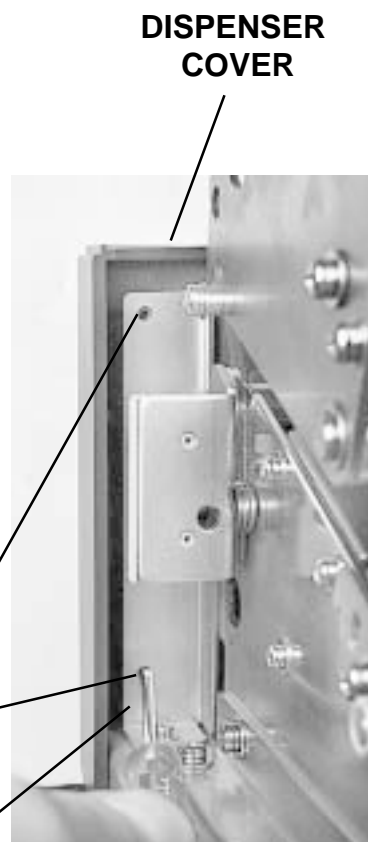

REMOVE (2)
SCREWS

Fig. 6-77



Fig. 6-78



Fig. 6-79

Replacing the Display Panel or Keyboard

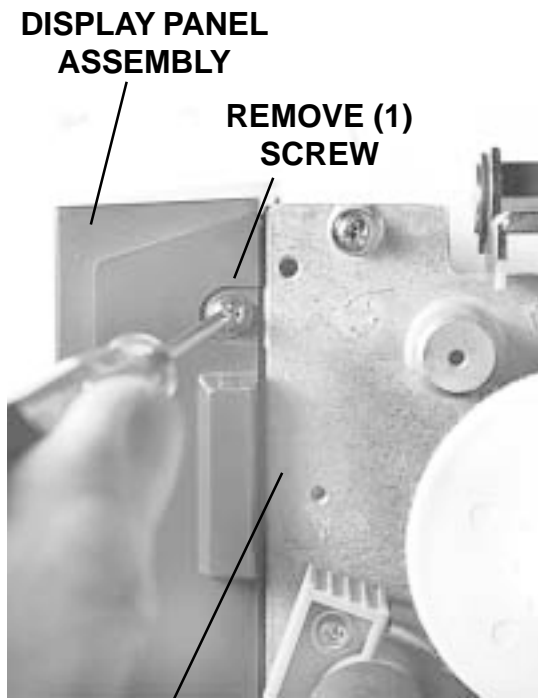

Fig. 6-80



Fig. 6-81

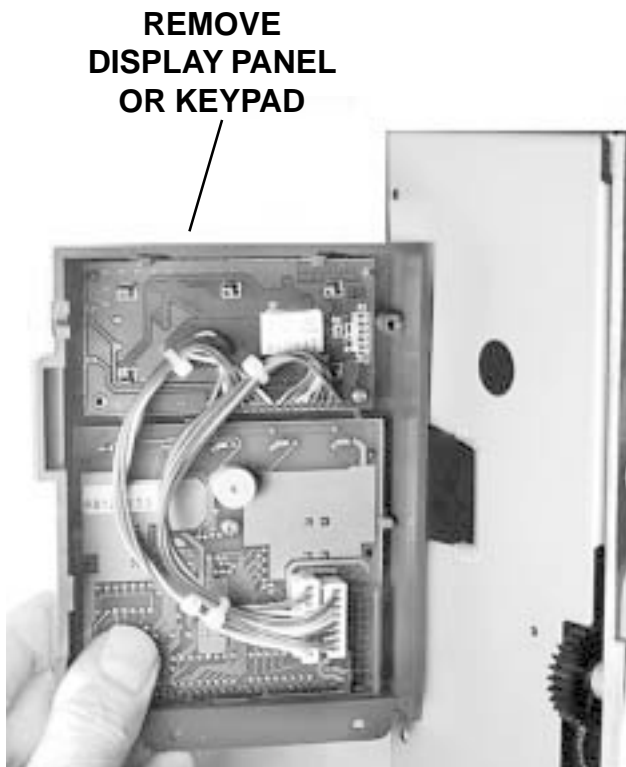

Fig. 6-82



Factory Resets

7.1 Overview

The Factory Reset Mode allows you to:

- *Factory Settings/Test Print*
- *Clear Head Counters*
- *Clear Dispenser Counter*
- *Clear Cutter Counter*
- *Clear EEPROM*

7.2 Factory Settings/Test Print

To reset the printer to the factory settings, perform the following steps.







Caution: *Resetting the printer will clear all registers.*

STEP	PROCEDURE
1.	Record all current dip switch positions, then place all switches in the OFF position.
2.	Place the DSW2-4 in the ON or up position.
3.	Press the LINE and FEED key while simultaneously turning ON the power switch. When the printer beeps, release the keys. The following screens will appear.
4.	Place the DSW-4 in the OFF position and the following screen will appear.
5.	Press the FEED key to display the next screen.
6.	Press the LINE key once to change the message from NONE to ALL .
7.	Press the FEED key to clear the EEPROM. After a pause, the next screen will appear.
8.	Select the print label size by pressing the LINE key. The default is LARGE.
9.	Press the FEED key for a test print. Press the FEED key again to stop printing.
	<p>Warning: This test activates all the heating elements on the print head and therefore should be used for testing purposes only with full width labels to avoid damaging the print head.</p>
10.	Verify that the counters on the test print have reset to 0.0 km.
11.	Power OFF the printer and confirm that all switches are in the OFF or down position.

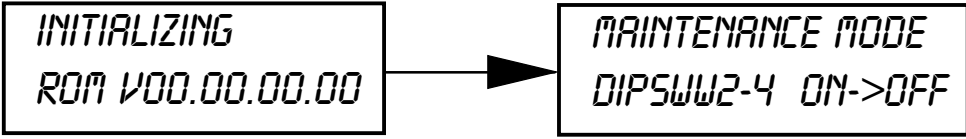
7.3 Clear Head Counters

To reset the printer to the factory settings, perform the following steps.

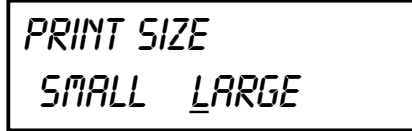
Caution: *Resetting the printer will clear all registers.*

STEP	PROCEDURE
1.	Record all current dip switch positions, then place all switches in the OFF position.
2.	Place the DSW2-4 in the ON or up position.
3.	Press the LINE and FEED key while simultaneously turning ON the power switch. When the printer beeps, release the keys. The following screens will appear.
	
4.	Place the DSW-4 in the OFF position and the following screen will appear.
	 <p data-bbox="1013 806 1398 919">The Head Counter will be cleared by the following steps:</p>
5.	Press the FEED key to display the next screen.
	
6.	Press the LINE key twice to change the message from NONE to HEAD .
	
7.	Press the FEED key to clear the Head Counter. After a pause, the next screen will appear.
	
8.	Select the print label size by pressing the LINE key. The default is LARGE .
9.	Press the FEED key for a test print. Press the FEED key again to stop printing.
	 <p data-bbox="911 1640 1500 1808">Warning: This test activates all the heating elements on the print head and therefore should be used for testing purposes only with full width labels to avoid damaging the print head.</p>
10.	Verify that the counters on the test print have reset to 0.0 km.
11.	Power OFF the printer and confirm that all switches are in the OFF or down position.

7.4 Clear Dispenser Counter

To reset the printer to the factory settings, perform the following steps.







Caution: *Resetting the printer will clear all registers.*

STEP	PROCEDURE
1.	Record all current dip switch positions, then place all switches in the OFF position.
2.	Place the DSW2-4 in the ON or up position.
3.	Press the LINE and FEED key while simultaneously turning ON the power switch. When the printer beeps, release the keys. The following screens will appear.
4.	Place the DSW-4 in the OFF position and the following screen will appear.
5.	Press the FEED key to display the next screen.
6.	Press the LINE key three times to change the message from NONE to DIS .
7.	Press the FEED key to clear the DISPENSER Counter. After a pause, the next screen will appear.
8.	Select the print label size by pressing the LINE key. The default is LARGE.
9.	Press the FEED key for a test print. Press the FEED key again to stop printing.
	<p>Warning: This test activates all the heating elements on the print head and therefore should be used for testing purposes only with full width labels to avoid damaging the print head.</p>
10.	Verify that the counters on the test print have reset to 0.0 km.
11.	Power OFF the printer and confirm that all switches are in the OFF or down position.

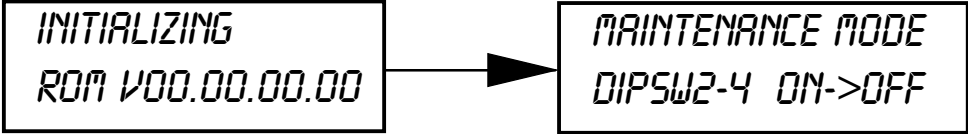
7.5 Clear Cutter Counter

To reset the printer to the factory settings, perform the following steps.

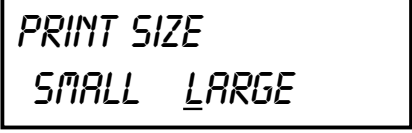

Caution: *Resetting the printer will clear all registers.*

STEP	PROCEDURE
1.	Record all current dip switch positions, then place all switches in the OFF position.
2.	Place the DSW2-4 in the ON or up position.
3.	Press the LINE and FEED key while simultaneously turning ON the power switch. When the printer beeps, release the keys. The following screens will appear.
	
4.	Place the DSW-4 in the OFF position and the following screen will appear.
	
5.	Press the FEED key to display the next screen.
	
6.	Press the LINE key four times to change the message from NONE to CUT .
	
7.	Press the FEED key to clear the Cutter Counter. After a pause, the next screen will appear.
	
8.	Select the print label size by pressing the LINE key. The default is LARGE .
9.	Press the FEED key for a test print. Press the FEED key again to stop printing.
	
	<p>Warning: This test activates all the heating elements on the print head and therefore should be used for testing purposes only with full width labels to avoid damaging the print head.</p>
10.	Verify that the counters on the test print have reset to 0.0 km.
11.	Power OFF the printer and confirm that all switches are in the OFF or down position.

7.6 Clear EEPROM

To clear the EEPROM, perform the following steps.

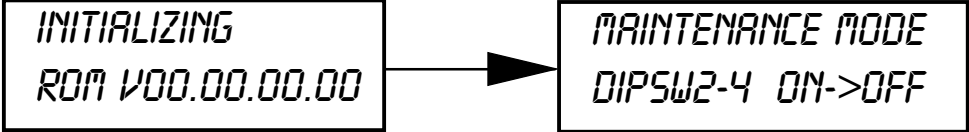
Caution: *Resetting the printer will clear all registers.*

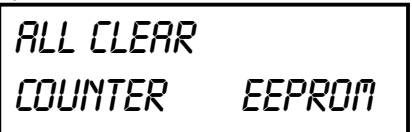
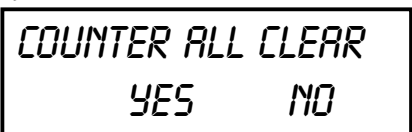
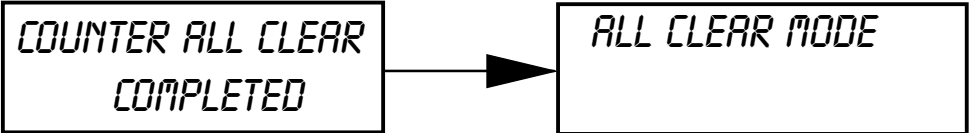
STEP	PROCEDURE
1.	Record all current dip switch positions, then place all switches in the OFF position.
2.	Place the DSW2-4 in the ON or up position.
3.	Press the LINE and FEED key while simultaneously turning ON the power switch. When the printer beeps, release the keys. The following screens will appear.
	
4.	Place the DSW-4 in the OFF position and the following screen will appear.
	
5.	Press the LINE key to display the next screen.
	
6.	Press the FEED key to display the next screen.
	
7.	Press the FEED key to display the next screen.
	
8.	Press the LINE key to select YES or NO . If YES is selected press the FEED key to clear the EEPROM .
	
9.	Power OFF the printer and confirm that all switches are in the OFF or down position.

7.7 Sample Test Prints



LARGE TEST PRINT



SMALL TEST PRINT

**ILLUSTRATIONS SHOWN ARE EXAMPLES ONLY
AND MAY NOT EXACTLY MATCH YOUR OUTPUT**



Section 8

Troubleshooting

8.1 Overview

This section has been devised to help you if you are unable to produce output on the CL608e/CL612e printers. Use this section to make sure the basics have been checked before deciding you are unable to proceed further. The design of the SATO CL608e/CL612e printers is based upon proven technology and reliable components. When a problem occurs, the solution can be easily traced using the troubleshooting tables in this section. These tables list symptoms, probable causes, and suggested corrective actions. Many of the suggested corrective actions include references to a section or paragraph found elsewhere in this manual where more complete descriptions and procedures may be found.

To help you, this section has been divided into the following parts.

- *Initial Checklist*
- *IEEE1284 Parallel Interface*
- *RS232C Serial Interface*
- *Universal Serial Bus Interface*
- *LAN Ethernet Interface*
- *Error Signals*
- *Troubleshooting Tables*
- *Head Pattern Examples*

8.2 Initial Check List

If you are unable to produce output on your printer, check the following before deciding you're unable to proceed any further.

1. Is the printer powered up and ON-LINE?
2. Is the ERROR light on the front panel OFF? If this light is ON, it may mean the Print Head Assembly or the Label Hold-Down is not closed and latched in position.
3. Are the Label and Ribbon lights on the front panel Off? If these lights are On, the labels or ribbons may be incorrectly loaded.

8.3 The IEEE1284 Parallel Interface

1. Is the IEEE1284 printer cable connected securely to your parallel port (DB25S Female) on the PC and to the Centronics connector on the printer?

WARNING: Never connect or disconnect interface cables (or use a switch box) with power applied to either the printer or the host. This may cause damage to the interface circuitry and is not covered by warranty.

2. Does the Parallel Interface cable used meet IEEE1284 specifications? If it does not and you are connected to an IEEE1284 or ECP parallel port on the computer, the printer may not be able to communicate correctly.
3. Is there more than one parallel interface port on your PC (LPT1, LPT2, etc.)? If so, make sure you are sending data out the correct port.
4. Is the IEEE1284 Interface Module installed in the printer? Older versions of the Parallel Interface module will not work correctly in the CL608e/CL612e printers.
5. When you send the print job to the printer and it does not respond, do you get an error message on your PC that says "Device Fault" or something similar?

This may mean that the computer doesn't know the printer is there. Verify that:

- a. Both ends of the cable are securely inserted into their respective connectors.
 - b. The printer is ON-LINE.
 - c. The cable is not defective. There are other things that can cause this error message on your computer but at this stage, a defective cable may be one of the reasons.
6. When you send the print job to the printer and it does not respond and there is no error message on the PC:
 - a. Check your data stream for some of the basics. Is your job framed as follows:
<ESC>A—Data—<ESC>Z
 - b. Verify that you've included all required parameters in the data stream.

The IEEE1284 Parallel Interface (Cont)

- c. Verify the following:
 - You have not typed a "0" (zero) for an "o" (letter) or vice-versa.
 - You have not missed any **<ESC>** characters where they're needed.
 - Make sure all printer command codes are capital letters.
 - Your protocol codes are set for Standard or Non-Standard and data stream is consistent with these.
7. If you've checked all the above and the printer still isn't printing, you may want to try a Receive Buffer Hex Dump to determine what (if anything) the printer is receiving from your computer. See Hex Dump Mode in Section 8-10.

The Parallel port is now listening for incoming data. Send your print job. The printer will now print (only once) a Hexadecimal (Hex) Dump of everything it received from the host computer. Each 2-digit hexadecimal character represents a character the printer received. It may be tedious, but now you can analyze and troubleshoot the data stream.

WARNING: A small label may produce a large amount of data when printed in Hex Dump.

8. While checking the Hex Dump printout, look for 0D_H 0A_H (Carriage Return and Line Feed) characters throughout. The command string should be continuous. CR or LF characters are not allowed between the Start Command (**<ESC>A**) and the Stop Command (**<ESC>Z**). If you are using BASIC, it may be adding these characters automatically as the line wraps. Adding a "width" statement to your program can help to suppress these extra 0D_H 0A_H characters by expanding the line length up to 255 characters.

If you're not programming in BASIC, check to see if you have an equivalent statement in the language you're using to suppress extra carriage returns and line feeds from your data being sent out to the printer. We want the data stream to be one complete line going to the printer.

8.4 The RS232C (Serial) Interface

1. Is the RS232C Serial cable connected securely to your serial port on the PC (DB-25S Male) and to the RS232C connector on the printer?

Warning: Never connect or disconnect interface cables (or use a switch box) with power applied to either the printer or the host. This may cause damage to the interface circuitry and is not covered by warranty.

2. Is the cable defective? At the very least, you should be using a "Null Modem Cable" which crosses pins in a specific manner. This should enable your printer to print. We recommend that you use a cable built to specifications described in Section 3, Interface Specifications.
3. Is the RS232 Interface Module installed in the printer?
4. Check for obvious errors in the data stream. Is the data properly framed with the <ESC> A and <ESC>Z commands?
5. If after sending your job to the printer, it only "beeps" and displays an error message on the LCD display, you may have a configuration problem. There may be some inconsistencies with the Baud Rate, Parity, Data Bits, or Stop Bits in relation to your host computer. If you are unsure as to what the printer's current RS232 settings are, print a Configuration Test Label. It will list all of the current printer configuration settings.
6. If you are still unable to get printer output, try the Hex Dump as described Step 7 under IEEE1284 Parallel Interface Troubleshooting. In this case, the printer monitors the RS232C interface for incoming data.
7. From the Hex Dump, if you are seeing extra 0D_H 0A_H (CR and LF) characters, and are using BASIC, refer to the beginning of the Command Code section in the Operator and Technical Reference Manual.

8.5 The Universal Serial BUS (USB)

If nothing prints when doing a test print you will need to verify that the device drivers have been successfully installed by doing the following:

1. Click on Start, then Settings and then Control Panel.
2. Within the new Window, you should have an Icon listed as System. Double click on this.
3. Click on the Device Manager tab.
4. Make sure that the View Device by type is checked. Scroll down until you get to SATO-USB device.
5. Verify that it does not have any errors next to it. If it shows an error, remove the device and then reinstall it.
6. Reboot the PC and the Printer.
7. Consult the Windows 98 Troubleshooting guide or contact technical support for further assistance.

8.6 Lan Ethernet Interface

Installation Problems

(Printer Does Not Come Up Ready)

If you cannot print to the SATO enhanced ethernet adapter after you install it, check the following:

1. Make sure that the printer is powered on, all cables are securely plugged in, and that the printer is on-line.
2. Make sure there is a secure connection between the hub and the printer.

Installation Problems

(Printer Comes up Ready but You Cannot Print)

If the printer starts up OK but you cannot print, the problem could one of the following:

- You've installed the wrong driver for your printer model type.
- There is a problem with the network connection or cabling.
- There is a queue setup problem, a print server setup problem, or other protocol-related problem.

Checking the Network Connection and Cabling

Check the network connection and cabling.

1. The LINK LED (Green LED) will come on solid if there is a valid 10baseT or 100baseTX connection. If the appropriate LEDs are not on, there is probably a bad 10baseT/100baseTX cable or the hub port is bad. If possible, try a different cable and hub port, or try connecting a different device (such as a PC) to the cable.
2. If you are using a repeater or hub, make sure that SQE (heartbeat) is turned off at the hub (this is the default setting for most hubs). Also, if you have a hub or multiport repeater, verify that the hub or repeater port is good by trying the print server on a different port.
3. If you have a bridge or router located between the SATO enhanced ethernet adapter and the host computer, make sure that the device is set up to allow the print server to send and receive data from the host. For example, a bridge can be set up to only allow certain types of Ethernet addresses to pass through (a process known as filtering); therefore, such a bridge must be configured to allow SATO enhanced ethernet adapter addresses. Likewise, a router can be set up to pass only certain protocols, so be sure that the desired protocol can be passed through to the SATO enhanced ethernet adapter. In the case of routers, also make sure that the protocol is routable (NetBEUI, and DLC/LLC are not routable).

4. If the job exits the queue but does not print, make sure that you have the correct driver installed. If you do, turn DSW2-4 on and cycle power. Try resending your print job. If something prints out at this point than we now that the connection is there but that the data is not correct.
5. Check the individual protocol troubleshooting sections in this chapter for additional causes of intermittent printer problems.

Intermittent Problems

If the print server and the printer start up OK, but you intermittently have problems printing, check the following:

1. Excessive NetWare polling can be a big cause of intermittent problems. Make sure that you have only enabled the NetWare file servers that you need for printing (do a SHOW NETWARE command from the print server console to see the enabled file servers). If you are not using NetWare, you can disable NetWare entirely with the command SET NETWARE DISABLED.
2. Check the individual protocol troubleshooting sections in this chapter for additional causes of intermittent printer problems.

TCP/IP Troubleshooting

If you are using TCP/IP and cannot print to the print server and you have checked the hardware and network as described in the previous steps, then check the following (*note that it is always a good idea to try creating a another print queue to eliminate the possibility of setup errors*):

1. The problem may be the result of mismatched or duplicate IP addresses. Verify that the IP address is correctly loaded into the SATO enhanced ethernet adapter and make sure that no other nodes on the network have this address (DUPLICATE IP ADDRESSES ARE THE BIGGEST CAUSE OF TCP/IP PRINTING PROBLEMS). If the address is not correct, then check whether the loading procedure was properly executed.
2. If you used NCP, XCONFIG, or ccr to enter the IP address, make sure that you exited the remote console properly with a CTRL-D or EXIT command.
3. If you used rarp, make sure that you started the rarp daemon using the rarpd, rarpd -a, in.rarpd -a, or equivalent command. Verify that the /etc/ethers file contains the correct Ethernet address and that the SATO enhanced ethernet adapter name matches the name in the /etc/hosts file.
4. If you used bootp, make sure that bootp is enabled (i.e., the “#” is removed from the bootp entry) in the /etc/inetd.conf file. Verify that /etc/bootptab file is correctly configured.

5. Also verify that the host computer and the print server are either on the same subnet (for example, if the print server has a subnet mask of 255.255.255.0, the host must have the same subnet mask) or that the router is properly configured to pass data between the two devices.
6. If you are using a Berkeley-based UNIX, make sure that the daemon is started on Berkeley based systems with the command `lpc start printer`, where *printer* is the name of the local print queue.
7. If you are using an AT&T-based UNIX, make sure the printer is enabled (enable *printer*, where *printer* is the name of the local print queue).
8. Make sure that the `lpr/lpd` remote line printer service are running on the host computer (refer to your host computer documentation for information on how to do this).
9. If you cannot print from DEC TCP/IP Services for VMS (UCX), make sure that you have version 2.0B or later of this software, because earlier versions will not work with the SATO enhanced ethernet adapters.
10. If you are using the raw TCP port and are experiencing intermittent queue stalling problems, make sure that queueing is enabled on the service (do a `SHOW SERVICE` command from the remote console, and note if "Q" is listed in the OPT column for the desired service). If it is not, enable queueing with the command `SET SERVICE servicename QUE ENA` command.
11. If the wrong IP address is loaded, check your network for file servers that have DHCP, BOOTP, or rarp enabled, and make sure that these file servers are not set up to load IP addresses into the print server. Also, make sure that you do not use the command `SET IP BOOT 0` to disable TCP/IP broadcasts; instead, you should use the command `SET IP METHOD STATIC` (unpredictable results will occur otherwise).
12. If you have problems with queues locking up when the active print job is deleted, try setting the IP timeout to one minute with the console command `SET IP TIMEOUT 1`.

NetWare Troubleshooting

If you cannot print from NetWare and you have checked the hardware and network as described in the previous steps, first verify that the print server is attached to the server queue by going to `PCONSOLE`, selecting `PRINT QUEUE INFORMATION`, and then `CURRENTLY ATTACHED SERVERS`. If the SATO enhanced ethernet adapter does not appear in the list of attached servers, then check the following (*note that it is always a good idea to try deleting and recreating the print server and creating a new print queue in order to eliminate the possibility of setup errors*):

Section 8. Troubleshooting

1. If you cannot create a print queue, make sure that you have sufficient NetWare privileges. With NetWare 3.12 and earlier, you **MUST** be logged in as SUPERVISOR (not someone with Supervisor privileges). If you are having problems creating queues with NetWare 4.xx and later, try logging in as ADMIN. Also, make sure that you are not trying to run XAdmin32 with the Microsoft NetWare client (you must use the Novell 32-bit client).
2. If you changed the login password, you must change the password in *both* the SATO enhanced ethernet adapter (using the SET NETWARE PASSWORD command) and in the file server (using the PCONSOLE Print Server Information Change Password command).
3. Make sure that you have enabled at least one NetWare file server using the SET NETWARE SERVER *servername* ENABLED command.
4. Have you exceeded your NetWare user limit?
5. Make sure that the print server name you used in PCONSOLE *exactly* matches the name that is configured in the print server, and make sure it is defined as a Queue Server for the print queue.
6. If you are running both 802.3 and Ethernet II frames on different file servers on your network, there is a possibility that the print server may not make a connection to the desired file server. Try forcing the frame type to the desired one using the SET NETWARE FRAME command from the SATO enhanced ethernet adapter remote console.
7. If you are losing portions of your print job and you are using the DOS NetWare drivers, try setting the TIMEOUT parameter in your CAPTURE statement to a higher value (at least 50 seconds for Windows).
9. Because of a bug in the vendor's software driver, file servers equipped with certain models of SMC Ethernet controllers may crash when an SATO enhanced ethernet adapter is connected to the network. This problem, which primarily affects EISA-based controllers made in 1993 or earlier, is not specific to SATO enhanced ethernet adapters, and can be fixed by upgrading the file server with the latest SMC drivers. Contact SMC technical support at (516) 435-6250 for additional information and instructions on how to download the new drivers from the SMC *bulletin board*.

Windows NT/LAN Server Troubleshooting

If you are having trouble printing with Windows NT or LAN Server, check the following:

1. Make sure that you can ping the SATO enhanced ethernet adapter using the DOS or OS/2 command PING *ipaddress*, where *ipaddress* is the IP address of the SATO enhanced ethernet adapter. If you cannot ping the print server, you will not be able to print.

Windows NT/LAN Server Troubleshooting

2. Make sure that TCP/IP and lpr printing are installed and running on the Windows NT system or the LAN Server file server.
3. If you are having problems printing to the SATO enhanced ethernet adapter from a client PC that is connected to a Windows NTAS or LAN Server file server, verify that you can print a job directly from the DOS or OS/2 prompt on the file server. If you can print from the file server but not from the client, then the problem is probably with the NetBEUI

communications rather than with the TCP/IP link to the SATO enhanced ethernet adapter. Check your file server network setup (for example, make sure that you can print from the client to other printers on the network).

4. If you have problems with Windows NT queues locking up when the active print job is deleted, try setting the IP timeout to one minute with the console command SET IP TIMEOUT 1.

Windows 95/98 Peer-to-Peer Troubleshooting

If you are having trouble printing on a Windows 95 Peer-to-Peer network, check the following:

1. If the print server does not show up under HP JetAdmin on a Windows 95/98 Peer-to-Peer network, try removing all of the Windows 95 network software from the Network Control panel and then reinstalling them as follows:
 - First install the **IPX/SPX-Compatible Protocol**, the **Client for Microsoft Networks**, and the network adapter card driver.
 - Restart the system, and then add the **HP JetAdmin** service.
2. Because of the many changes that have been incorporated in Windows 95/98 Peer-to-Peer printing since its introduction, it is a good idea to upgrade to the latest version of JetAdmin (available on the HP web site at <http://www.hp.com>).

Resetting the Print Server

Press the Factory button for at least 5 seconds. Please wait approximately 1 minute before trying the factory test print.

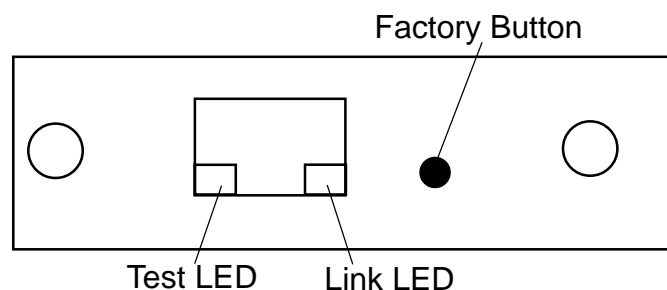

8.7 Error Signals

The LCD display, Front Panel LED Indicators and Buzzer provide a visual/audio indication of the type of error encountered.

LED	LCD Message	Audible Beep	Error Condition	To Clear
Error On	Machine Error	1 Long	Machine Error	Cycle Power ON/OFF
Error On	EEPROM Error	1 Long	EEPROM Read/Write	Cycle Power ON/OFF
Error On	Head Error	1 Long	Print Head is damaged	Replace Print Head Cycle Power ON/OFF
Error On	Sensor Error	3 Short	Sensor	Cycle Power ON/OFF
Error Blinks	Card R/W Error	1 Long	Memory Card Read/Write	Format Memory Card Cycle Power ON/OFF
Error Blinks	Card Low Battery	1 Long	Memory Card Battery Low	Replace MC Battery Cycle Power ON/OFF
Error Blinks	Head Open	3 Short	Head Open	Close Head Lever
Error On Line Blinks	Parity Error	3 Short	RS232 Parity Error	Correct parity to match system
Error On Line Blinks	Overrun Error	3 Short	RS232 Overrun Error	Verify RS232 Settings
Error On Line Blinks	Framing Error	3 Short	RS232 Framing Error	Verify RS232 Settings
Error On Line Blinks	Buffer Over	3 Short	Buffer Overflow	Verify RS232 Settings
Error On Line Blinks	Paper End	3 Short	Media End or Misselected Media Type	Replenish Media Select Correct Media Type Open/Close Head Lever Open/Close Media Hold Down
Error Blinks Ribbon On	Ribbon End	3 Short	Ribbon End Ribbon Broken	Replace Ribbon Open/Close Head Lever Open/Close Media Hold Down
Error Blinks Label Blinks	Media Error	3 Short	Media Error	Open/Close Head Lever
Ribbon Blinks		None	Ribbon Near End	Replace ribbon with full roll
Line Blinks		None	Buffer Near Full	Slow down transmission rate

8.8 Troubleshooting Tables

The troubleshooting table below includes the following general symptoms descriptions:

- Image Voids
- Ribbon Wrinkle
- Light Images
- Smearing
- No Ribbon Movement
- No Label Movement
- No Printed Image
- Display Problem
- POWER LED not on
- ERROR LED on
- ON LINE LED not on
- No Label Drive

Print Quality Problems

Symtom	Probable Cause	Suggested Corrective Action
Image Voids	Poor quality labels	Use thermal transfer compatible stock
	Poor quality ribbons	Use genuine SATO ribbons
	Ribbon not matched to label stock	Check with media suppliers
	Damaged electronics	Replace circuit board (Sec. 6.2)
Ribbon Wrinkle	Damaged platen	Replace platen
	Poor head alignment	Adjust head balance (Sec. 5.4) Adjust ribbon roller Adjust head alignment
	Poor ribbon tension	Adjust ribbon tension (Sec. 5.2 & 5.6)
	Worn platen	Replace platen (Sec. 6.8)
	Foreign material on head/platen	Clean head and platen
	Foreign material on labels	Use high quality label stock
	Damaged print head	Replace print head (Sec. 6.7)
	Light Images	Poor quality labels
Poor quality ribbons		Use genuine SATO ribbons
Low print head energy/darkness		Adjust darkness control (See Operator Manual)

Print Quality Problems

Symptom	Probable Cause	Suggested Corrective Action
Light Images	Low print head pressure	Adjust head balance (Sec. 5.4)
	Ribbon not matched to label stock	Use Premier II ribbon with a "1C" thermal transfer ribbon stock or equivalent for optimum results
	Low ribbon drive torque No ribbon movement	Adjust ribbon drive clutch (Sec. 5.2)
	Foreign material on head	Clean head and platen
	Poor head alignment	Align print head (Sec. 5.3)
	Excessive print speed	Reduce print speed setting
Smearing	Poor quality labels	Use high quality label stock
	Poor quality ribbons	Use genuine SATO ribbons
	Foreign material on head/platen	Clean head and platen
	Foreign material on labels	Use high quality label stock
	Excessive print head energy	Adjust darkness control
	Excessive print speed	Adjust print speed
	Excessive head pressure Carbon tension wrong	Adjust head balance (Sec. 5.4)
No Ribbon Movement	Incorrect ribbon core size	Use genuine SATO ribbons
	Loose drive clutch	Adjust drive clutch tension (Sec. 5.2)
	Loose platen drive belt	Adjust/replace belt (Sec. 6.6)
	No +24 volt output	Test power supply and replace if required (Sec. 6.4)
	Damaged electronics	Replace circuit board (Sec. 6.2)

Print Quality Problems

Symtom	Probable Cause	Suggested Corrective Action
No Label Movement	Loose/broken platen drive belt	Adjust/replace belt Sec. 6.6)
	Incorrect label pitch sensor selected	Select correct label sensor type (DSW2-2)
	No +24 volt output	Replace fuse on main PCB (Sec. 6.3) Test power supply and replace if necessary (Sec. 6.4)
	Loose set screw on platen pulley/stepper motor	Tighten set screws
No Printed Image	Print head not connected	Verify print head connector fully seated at head and main PCB (Sec. 6.7)
	Ribbon upside down	Use genuine SATO ribbons
	No + 24 volt output	Test power supply and replace if necessary (Sec. 6.4)
	Damaged print head	Replace print head (Sec. 6.7)
	Damaged electronics	Replace circuit board (Sec. 6.2)
Back light but no words on display or no display	The most likely cause is the ribbon cable has fallen out or not seated fully into connector.	Verify that the cable and connector are properly seated. Display POT not positioned properly.
POWER LED not on	AC power cable not connected	Verify that the cable is connected to the printer and the AC outlet
	Main power fuse defective	Replace fuse (Sec. 6.3)
	Defective power supply	Test power supply and replace if defective (Sec. 6.4)
ERROR LED on	Head not locked	Close and latch head release
LABEL LED on	Label supply roll empty	Replenish label supply
	Label stock not routed through sensor	Reload labels
	Label sensor not positioned correctly	Adjust sensor position

Section 8. Troubleshooting

Print Quality Problems

Symptom	Probable Cause	Suggested Corrective Action
LABEL LED On	Label sensor blocked	Clean label sensor
	Incorrect label sensor threshold setting	Adjust label sensor threshold (Sec. 4.6 & 4.7)
	Platen drive malfunction	See Section 6.8
Ribbon LED on	Ribbon supply roll empty	Replenish ribbon supply
	Ribbon supply out of alignment	Realign ribbon sensor
	Ribbon sensor blocked	Clean ribbon sensor
	No cardboard core on ribbon rewind	Use cardboard core on ribbon rewind

8.9 Head Pattern Examples

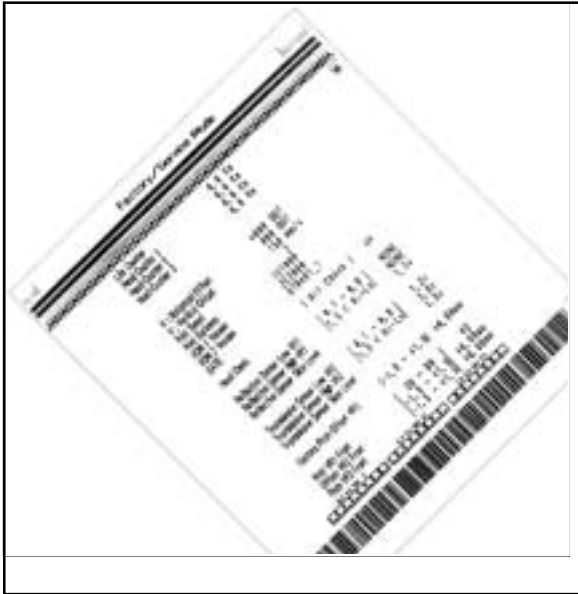

FACTORY DEFAULT

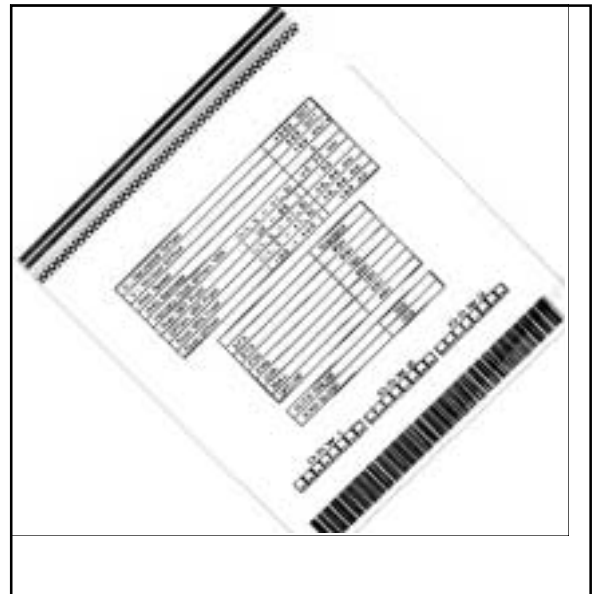

**GOOD ADJUSTMENT
CLEAR, DARK,
EVEN TEXT**

**FEED
DIRECTION**

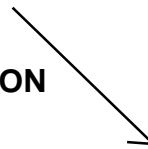

**POOR HEAD
ALIGNMENT, BALANCE
OUT OF ADJUSTMENT**

**IRREGULAR UNEVEN
TEXT**



**POOR HEAD
ALIGNMENT, BALANCE
OUT OF ADJUSTMENT**

**ILLUSTRATIONS SHOWN ARE EXAMPLES
ONLY AND WILL NOT EXACTLY MATCH
YOUR OUTPUT**

Head Pattern Examples

DIAGONAL VOIDS (WHITE STREAKS) THAT "WALK" ACROSS LABEL

RIBBON WRINKLE
POOR HEAD ALIGNMENT, POOR
RIBBON TENSION,
WORN PLATEN,
FOREIGN MATERIAL, DAMAGED
PRINT HEAD

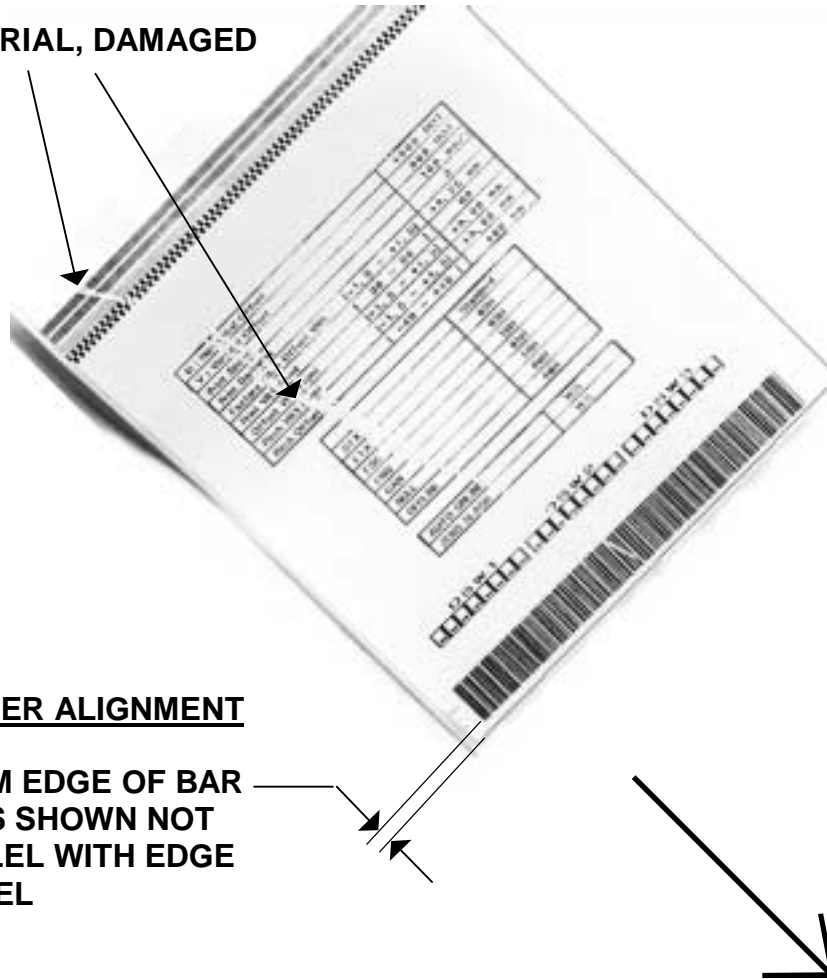

IMPROPER ALIGNMENT

BOTTOM EDGE OF BAR
CODE IS SHOWN NOT
PARALLEL WITH EDGE
OF LABEL

FEED
DIRECTION

8.10 Hex Dump Diagnostic Labels

In addition to the User Test Print Labels, the printer contents of the receive and print buffers can be examined using the Hex Dump Test Labels.

Print Buffer Hex Dump

The contents of the Print Buffer can be examined using the Hex Dump mode. The label numbers each line of data received in the left hand column, the data in hexadecimal format in the center columns, followed by the same data in ASCII format in the right hand column.

STEP	PROCEDURE
1.	Turn on the printer.
2.	Send and print a label.
3.	Place the printer in the Off-Line mode by pressing the LINE key. The LINE LED should go out.
4.	Place DSW2-4 in the On position.
5.	Press the LINE key to place the printer back On-Line.
6.	Press the FEED key.
7.	A label should be printed containing the contents of the print buffer in Hexadecimal format.
8.	Return DSW2-4 to the Off position.
9.	Turn the printer off and then back on to place it back in the normal print mode.

Receive Buffer Hex Dump

The data that is being received by the printer (before it is placed in the Print Buffer) can be examined by using the Hex Dump Mode. The label numbers each line of data received in the left hand column, the data in hexadecimal format in the center columns, followed by the same data in ASCII format in the right-hand column.

STEP	PROCEDURE
1.	Turn off the printer.
2.	Place DSW2-4 in the On position.
3.	Turn on the printer.
4.	Transmit the data to the printer.
5.	The data received is printed on a label in hexadecimal format.
6.	Return DSW2-4 to the Off position.
7.	Turn the printer off and then back on to place it back in the normal print mode.



Section 9

Optional Accessories

9.1 Overview

This section contains instructions for installing the following optional accessories:

- *Label Cutter Kit Installation*
- *Label Dispenser Kit Installation*
- *PCMCIA Memory Expansion*
- *Flash ROM Memory Expansion*
- *Real Time Clock*

9.2 Label Cutter Kit Installation

The Cutter is a field installable option. No critical adjustments or special tools are required.

STEP	PROCEDURE
1.	Turn the printer OFF and disconnect the AC power cord.
2.	Remove (3) screws holding the left side cover to the printer. Raise the access door and loosen the (2) screws on the inside top of the printer. Lift off the left side cover. Figs. 9-1
3.	Remove the ribbon and label stock if installed.
4.	Remove the front cover from the printer by removing 5 screws. Figs. 9-2
5.	Remove (2) screws and discard bracket. Fig. 9-3
6.	Place the cutter unit face down and identify the two sets of cables with cables marked CUTP & CUTS. Refer to Fig.9-4 . Detach cable and install new cable at same locations.
7.	Route the opposite end of cable connectors from the cutter through the access hole in the print engine and through the hole in the aluminum side plate. Figs. 9-5
8.	Refer to Figs. 9-6 . Detach the SEN3 connector from the printer PCB and save. Replace with cable connector marked "CUTS" from the cutter and cable connector marked "CUTP" from the cutter to CN2 connector on the power supply. Be sure all cables are properly routed.
9.	Secure the cutter unit to the front of the printer using (5) screws provided. Figs. 9-7
10.	Reinstall the printer's side cover and close the lid.
11.	Set dip switches on bank three, marked DSW3: 1= ON and 2= OFF . The dip switches are located on the front panel below the line and feed keys.
12.	Connect the power cord to the printer. The installation of the cutter is now complete.

Label Cutter Kit Installation

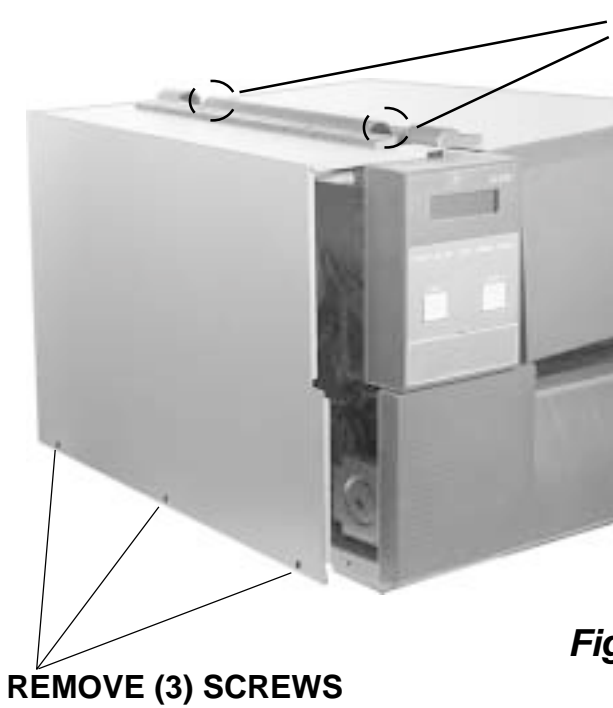

RAISE THE ACCESS DOOR AND LOOSEN (2) SCREWS ON THE INSIDE TOP OF THE PRINTER

REMOVE (3) SCREWS

Figs. 9-1

REMOVE RIBBON AND LABEL STOCK

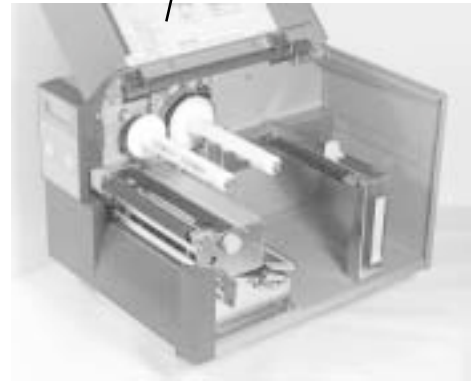

FRONT COVER

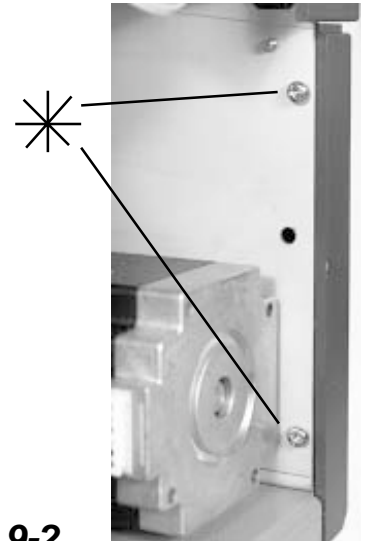
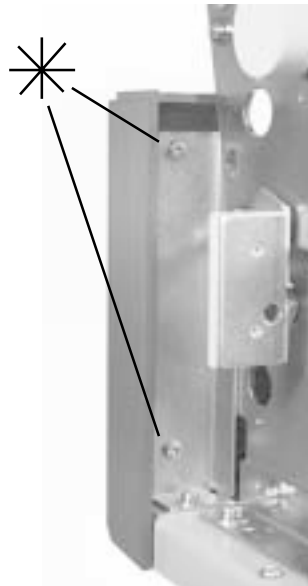

*** REMOVE SCREWS AT (5) PLACES TO DETACH FRONT COVER**

Figs. 9-2

Label Cutter Kit Installation



CUTTER UNIT

**REMOVE (2)
SCREWS AND
DISCARD BRACKET**

Fig. 9-3

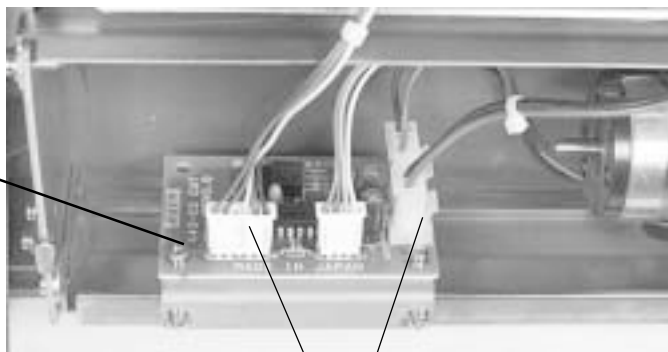

Fig. 9-4

**DETACH EXISTING CABLE FROM
THE CUTTER PCB AT "CUTP"
AND "CUTS".
INSTALL NEW CABLE AT SAME
LOCATIONS**

**ROUTE CABLE CONNECTORS FROM
THE CUTTER THROUGH ACCESS
HOLE IN PRINT ENGINE ASSEMBLY
AND THROUGH THE HOLE IN THE
ALUMINUM SIDE PLATE**



Figs. 9-5

Label Cutter Kit Installation

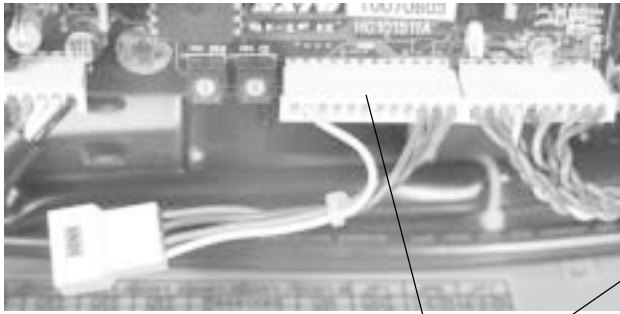

DETACH SEN3 CONNECTOR FROM PCB BOARD AND REPLACE WITH CABLE CONNECTOR MARKED "CUTS" FROM CUTTER

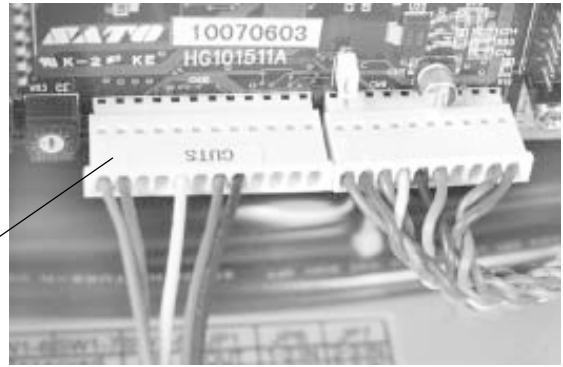

ATTACH CABLE CONNECTOR END MARKED "CUTP" FROM CUTTER TO CN2 ON POWER SUPPLY

Figs. 9-6

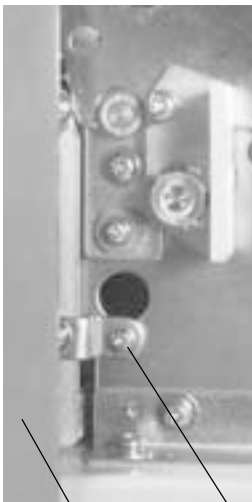

CUTTER



Figs. 9-7

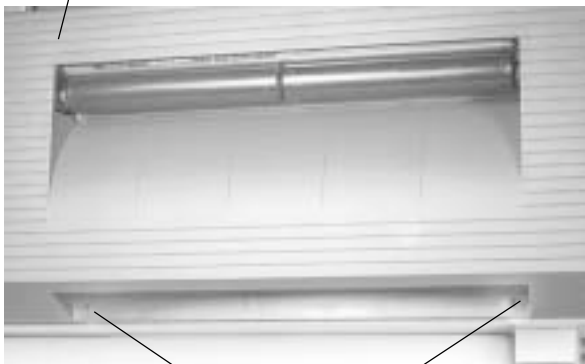

*** SECURE CUTTER WITH SCREWS AT (5) PLACES**

9-3 Label Dispenser Installation

Installation of the optional Label dispenser into the printer adds the convenience of automatic label dispensing. Each label is printed, then peeled from the backing paper and presented at the front of the printer for removal by the operator. A photo electric sensor detects the presence of a completed label and signals the printer to await removal. Once the completed label is removed, this sensor signals the printer to automatically backfeed the label stock for correct alignment of the printing on the next label.

Components as Supplied in Kit

Fig. 9-8a

DISPENSER UNIT WITH ROLLER AND SPRINGS

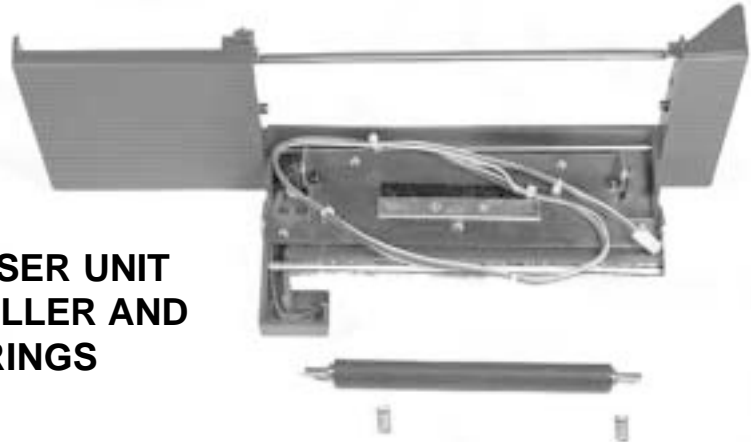

DISPENSER FEED ROLLER

Fig. 9-8b

PULLEY AND GEAR WITH HARDWARE

Fig. 9-8c



REWIND PULLEY ASSEMBLY AND BELT

Fig. 9-8d

Label Dispenser Installation

**Components as
Supplied in Kit**



**REWINDER
ASSEMBLY**

Fig. 9-8e



PULLEY COVER

Fig. 9-8f

**SCREWS
SUPPLIED IN KIT**

Fig. 9-8g



CABLE STAY

Fig. 9-8h

Label Dispenser Installation

STEP	PROCEDURE
1.	Switch the printer OFF.
2.	Remove (3) screws holding the left side cover to the printer. Raise the access door and loosen the (2) screws on the inside top of the printer. Lift off the left side cover. Figs. 9-9
3.	Remove the ribbon and label stock if installed.

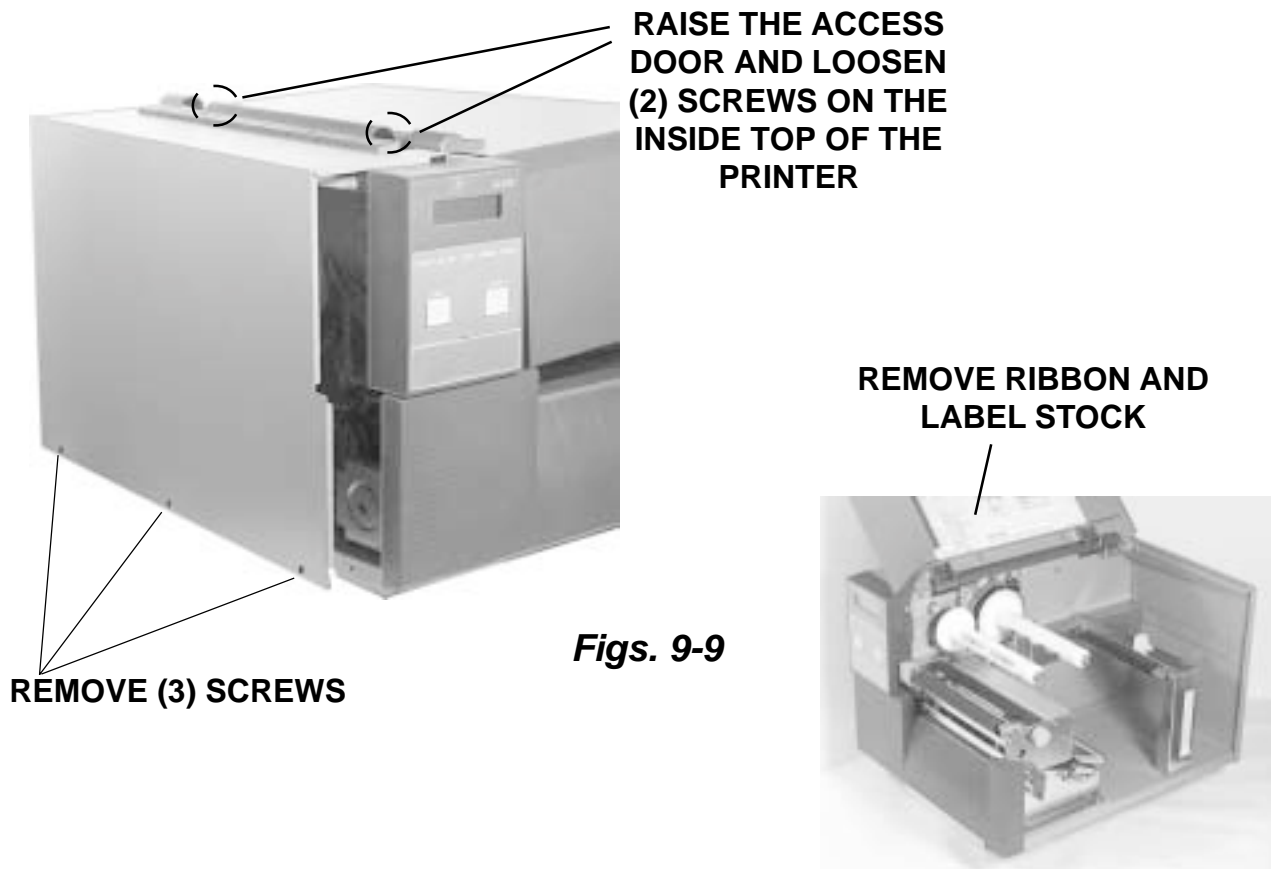

Figs. 9-9

Label Dispenser Installation

STEP	PROCEDURE
4.	Remove (3) motor mounting screws attaching motor to the frame. Fig. 9-10
5.	Refer to Section 6.2 and remove the main circuit board.
6.	Detach the front cover from the printer by removing (5) screws. Figs. 9-11
7.	Refer to Fig. 9-8a & Figs. 9-12 Place spring on pin (both ends) and attach roller with flat area of shaft over spring and into hole (both ends).
8.	Refer to Fig. 9-8b & Figs. 9-13 Install Dispenser Feed Roller Assembly through hole in space vacated by motor and into right side frame using hardware supplied.
9.	Refer to Fig. 9-8c and Fig. 9-14a Install the Idler Gear directly above the gear on the end of the feed roller assembly installed in Step 8. The idler gear should mesh freely with feed roller gear when installed correctly.
10.	Refer to Fig. 9-8c and Fig. 9-14b Install idler pulley with large teeth in/small teeth facing out.
11.	Refer to Fig. 9-8d and Fig. 9-14c Remove the "E" clip and pulley from bracket. Route the drive belt over the gear. Insert the gear shaft through the hole in the printer wall. Attach the bracket to the printer wall from the opposite side with (4) screws provided. Install the "O" ring pulley, shoulder side first and reattach the "E" clip to the end of the shaft. Attach belt from the gear on this assembly to the gear on the idler pulley as shown in Figs. 9-14 .
12.	Refer to Fig. 9-8c and Figs. 9-14d Attach the tension roller to the printer as shown in Figs. 9-14 with hardware provided. Attach right screw first then attach and tighten the screw in the adjustment slot.
13.	Refer to Fig. 9-8e and Figs. 9-15 & 9-16 Install the rewinder assembly to the back of the printer with (2) screws provided. Run the "O" belt from the rewinder assembly through the back of the printer and onto the rewind pulley installed in step 11.
14.	Refer to Fig. 9-8e and Figs. 9-17 Attach the pulley cover over the exposed pulley and belt with (1) screw provided.

Label Dispenser Installation

STEP	PROCEDURE
15.	Refer to Fig. 9-8a and Figs. 9-18 Install dispenser unit in its entirety to the front of the print cover previously removed in Step 6 with (5) screws.
16.	Refer to Fig. 9-8h and Figs. 9-19 Install cable stay in the approximate position shown in Figs. 9-19 . Route the dispenser cable under the stay and through opening in the printer to the main PCB connector harness @ SEN3.
17.	Disengage dispenser front door by grasping cut out section and lifting up and forward.
18.	Place DSW3-1 and DSW3-2 in the on position.

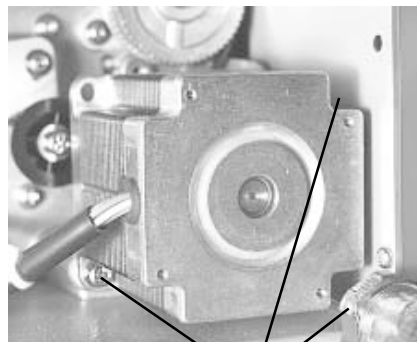
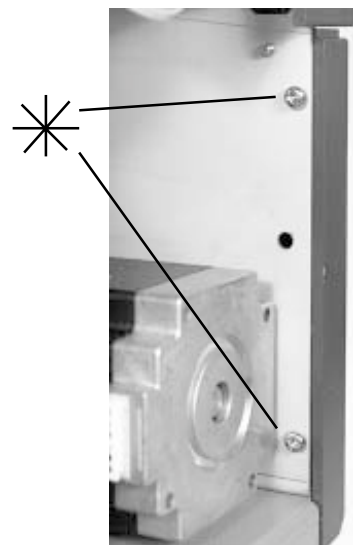

Fig. 9-10

**REMOVE (3)
MOUNTING SCREWS**



Figs. 9-11

*** REMOVE SCREWS
AT (5) PLACES TO
DETACH FRONT
COVER**

FRONT COVER

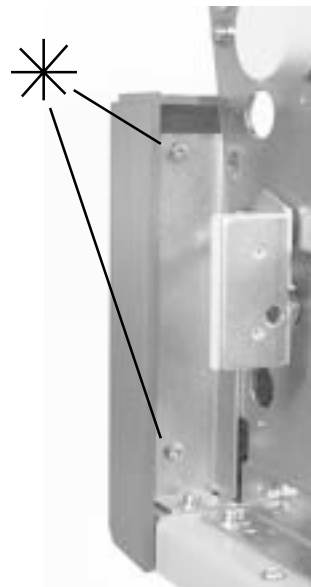
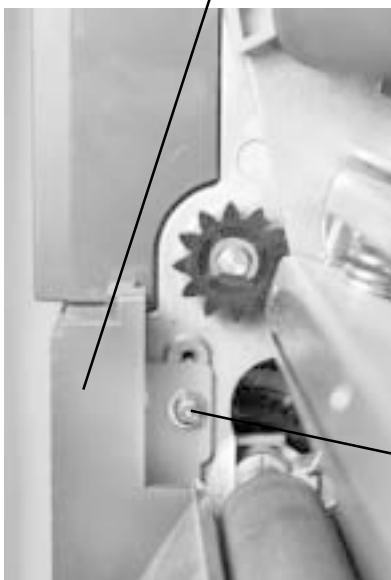

Label Dispenser Installation

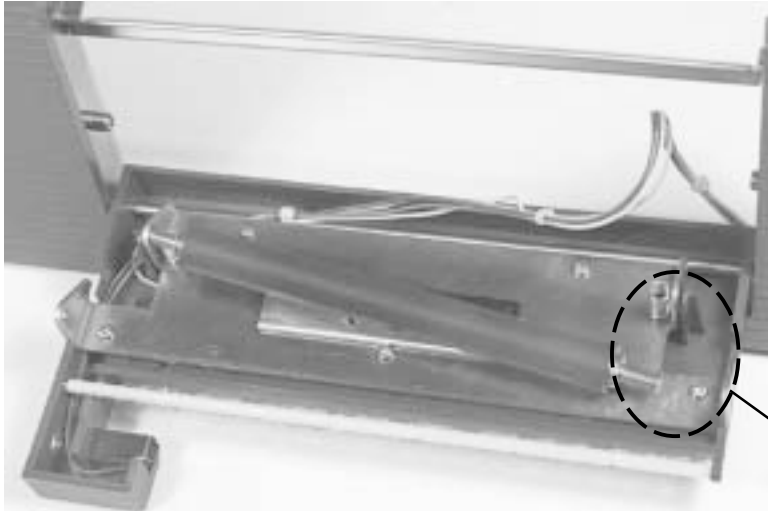

PLACE SPRING ON PIN
(BOTH ENDS) AND
ATTACH ROLLER WITH
FLAT AREA OF SHAFT
OVER SPRING AND INTO
HOLE (BOTH ENDS)

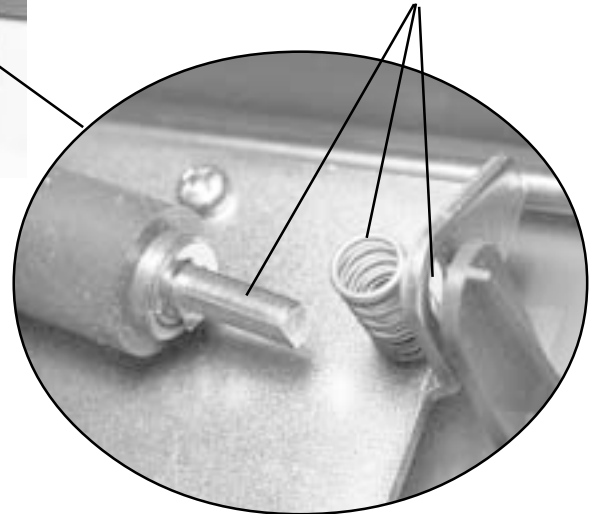

Figs. 9-12



INSTALL DISPENSER
FEED ROLLER FROM THIS
END IN SPACE VACATED
BY MOTOR

PLACE BEARING IN
RIGHT SIDE FRAME.
SLIDE ROLLER SHAFT
INTO POSITION

Figs. 9-13

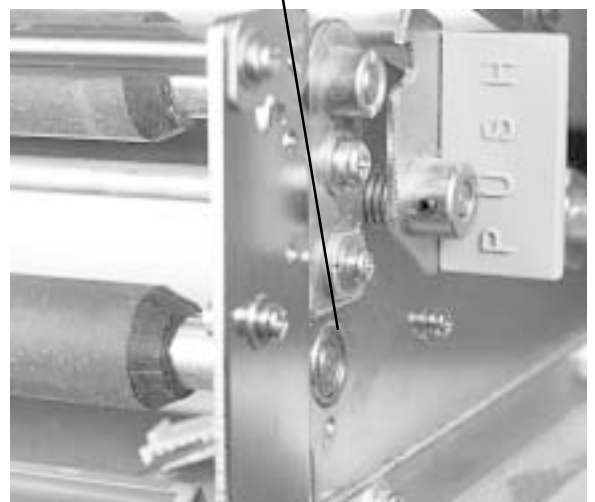

Label Dispenser Installation



Fig. 9-14d

**SECURE BRACKET
TO WALL FROM
OPPOSITE SIDE**

**ADJUSTMENT
SLOT**

TENSION ROLLER

**RIGHT
SCREW**

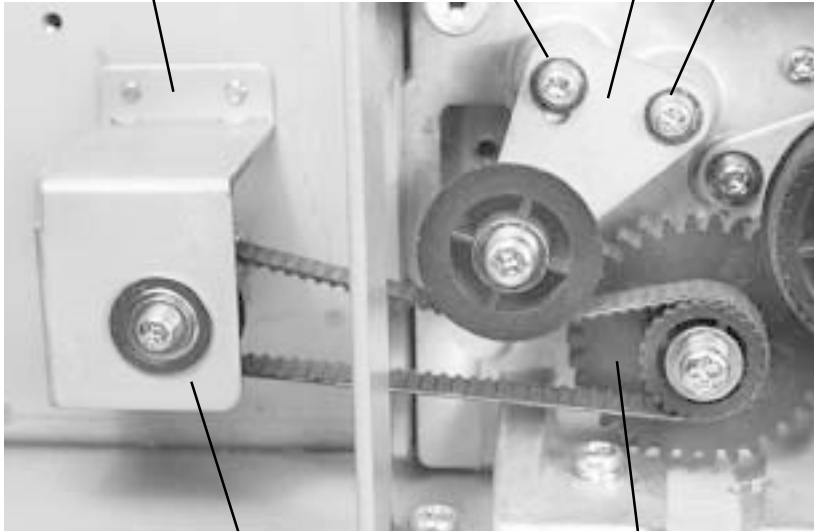

Figs. 9-14

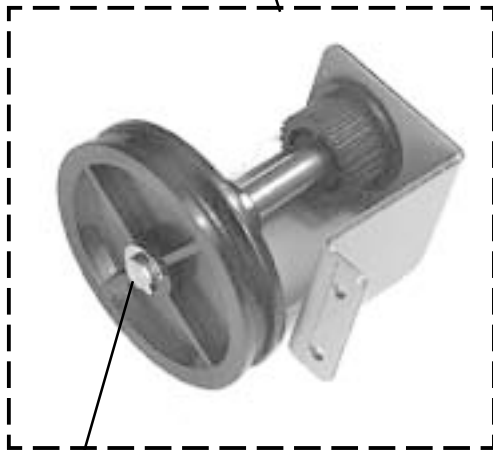
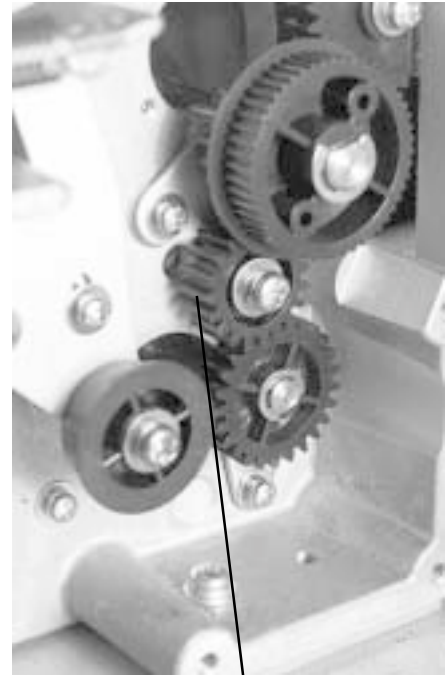

**REWIND PULLEY
Fig. 9-14c**

**REMOVE "E" CLIP AND REMOVE
PULLEY FROM BRACKET BEFORE
INSTALLING ASSEMBLY**

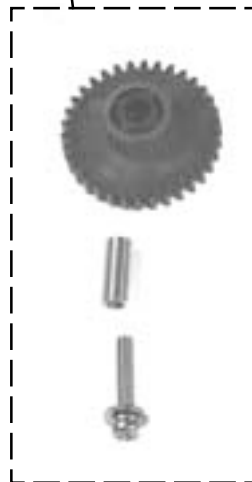

**IDLER PULLEY
Fig. 9-14b**

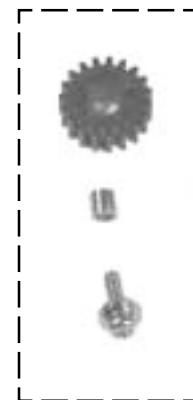

**IDLER GEAR
Fig. 9-14a**

**ATTACH PULLEYS AND
GEARS WITH HARDWARE
AS SHOWN**

Label Dispenser Installation

Fig. 9-15

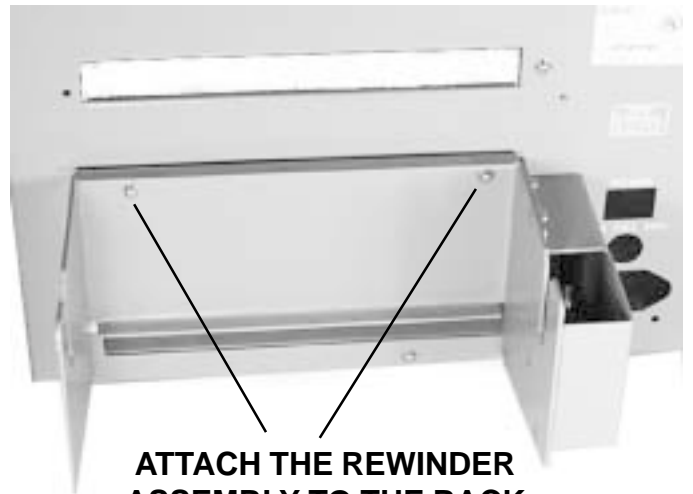

ATTACH THE REWINDER ASSEMBLY TO THE BACK OF THE PRINTER WITH (2) SCREWS

RUN THE "O" BELT FROM THE REWIND ASSEMBLY THROUGH THE BACK OF THE PRINTER AND ONTO THE REWIND PULLEY

REWIND PULLEY



BACK OF THE PRINTER

Fig. 9-16

ATTACH THE PULLEY COVER OVER THE EXPOSED PULLEY AND BELT WITH (1) SCREW



Fig. 9-17

Label Dispenser Installation

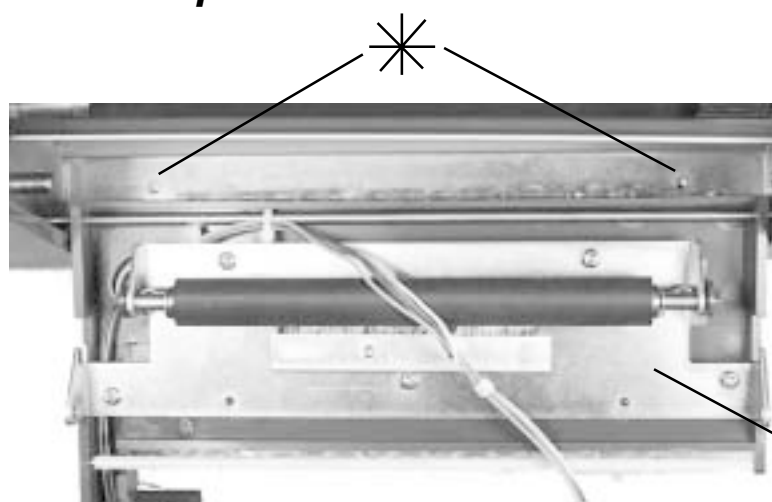

FRONT OF THE
PRINTER

DISPENSER
UNIT IN OPEN
POSITION

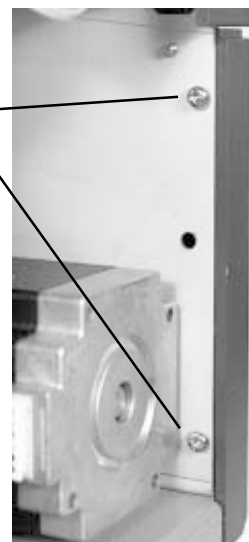

Figs. 9-18

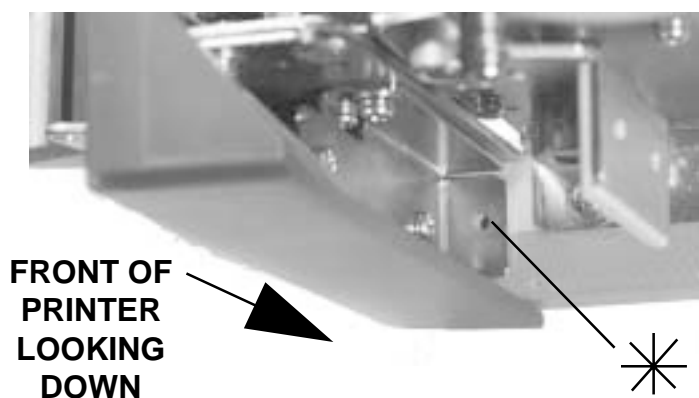

FRONT OF
PRINTER
LOOKING
DOWN

* SECURE DISPENSER
UNIT TO PRINTER WITH
SCREWS AT (5) PLACES

ROUTE CABLE FROM DISPENSER UNIT UNDER
STAY AND THROUGH OPENING IN PRINTER TO
THE MAIN PCB CONNECTOR HARNESS @ SEN3

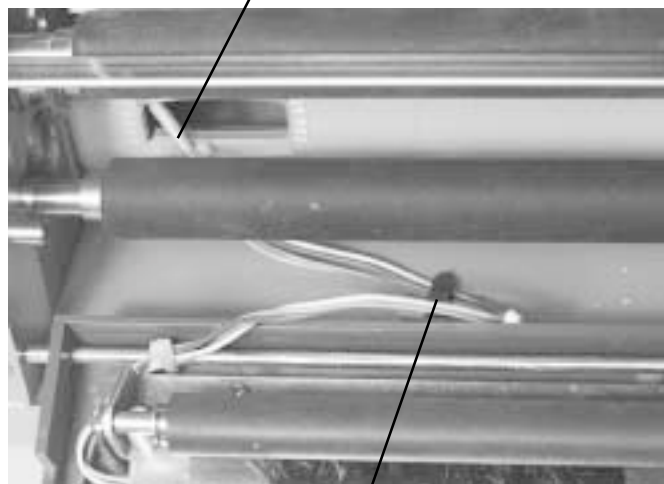

Figs. 9-19 ATTACH CABLE STAY IN THIS
APPROXIMATE POSITION.
(Ref. Fig. 9-8h)



9.4 PCMCIA Memory Expansion Installation

The Memory PCB Board provides the interface board for (1) PCMCIA memory card slot.

Applicable Specifications Size	PCMCIA Version 2.1 (JEIDA Version 4.1) Up to 4MB SRAM Up to 16MB Flash
Connector Pins	68
Battery	Approximately two years (manufacturer dependent)
Write Protect	Yes
Low Battery Detect	Yes

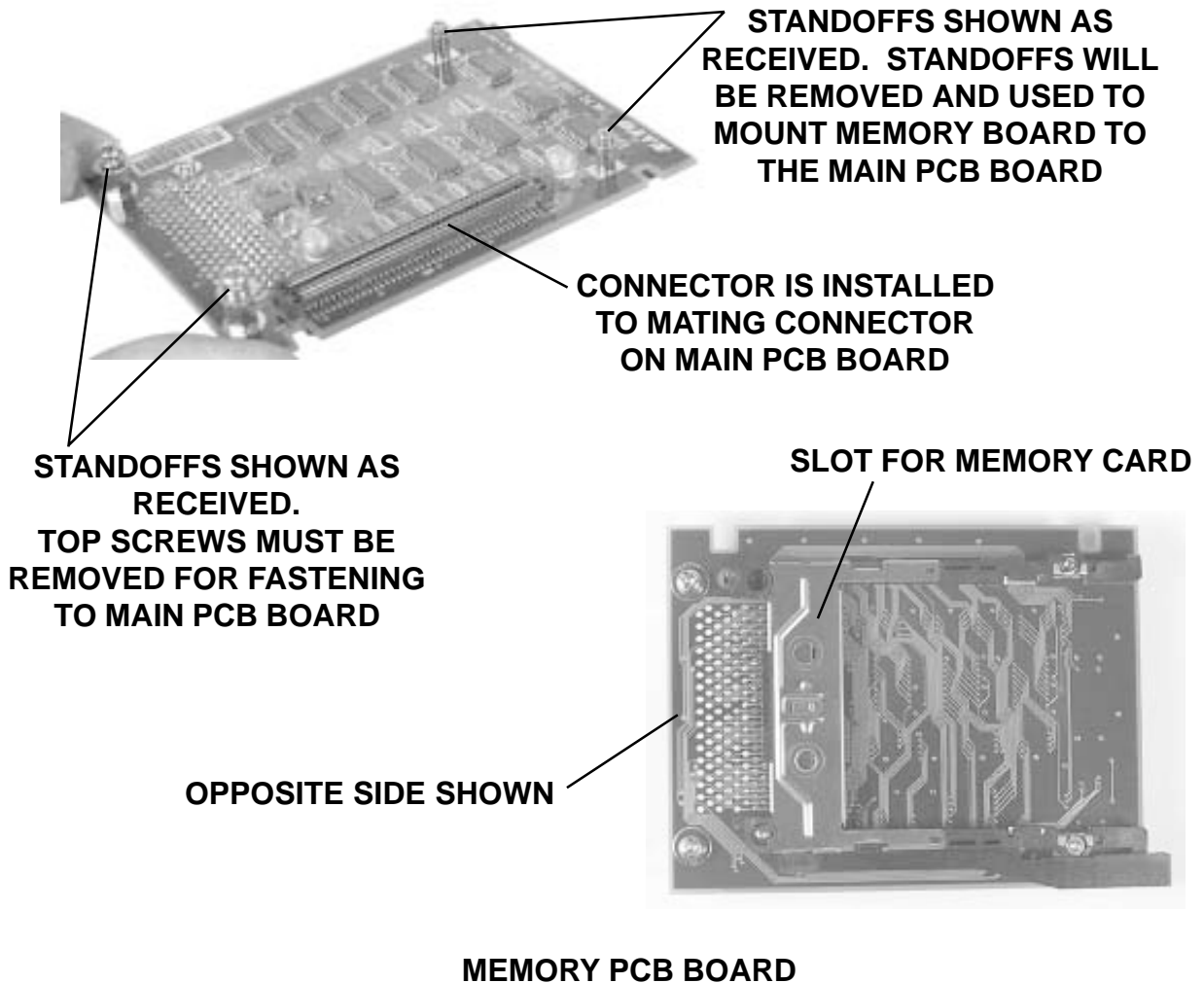

PCMCIA Memory Expansion Installation

STEP	PROCEDURE
1.	Switch the printer OFF.
2.	Refer to Section 6.2 and remove the main circuit board.
3.	Remove (2) screws, nuts and standoffs from the Memory PCB Board for mounting to the Main PCB Board. Fig. 9-20
4.	Remove (2) screws and washers as shown in Fig. 9-20 for installing to the Main PCB Board. Do not remove standoffs themselves.
5.	Refer to Fig. 21 for installation location on Main PCB Board. Insert the (2) screws through the Main PCB Board and into the standoffs as shown in Fig. 9-22
6.	Place the Memory PCB Board down over the Main PCB Board so the the connectors mate and the standoffs are aligned with the mounting holes through the standoffs. Fig. 9-22
7.	Secure one end of the Memory PCB Board with (2) screws previously removed and the opposite end from the underside of the Main PCB Board with (2) ea. screws and washers previously removed. Fig. 9-22
8.	Reinstall the completed Main PCB assembly to the printer reversing the Steps prior to the Memory Board installation.
9.	Complete the Factory Reset Procedure.

PCMCIA Memory Expansion Installation

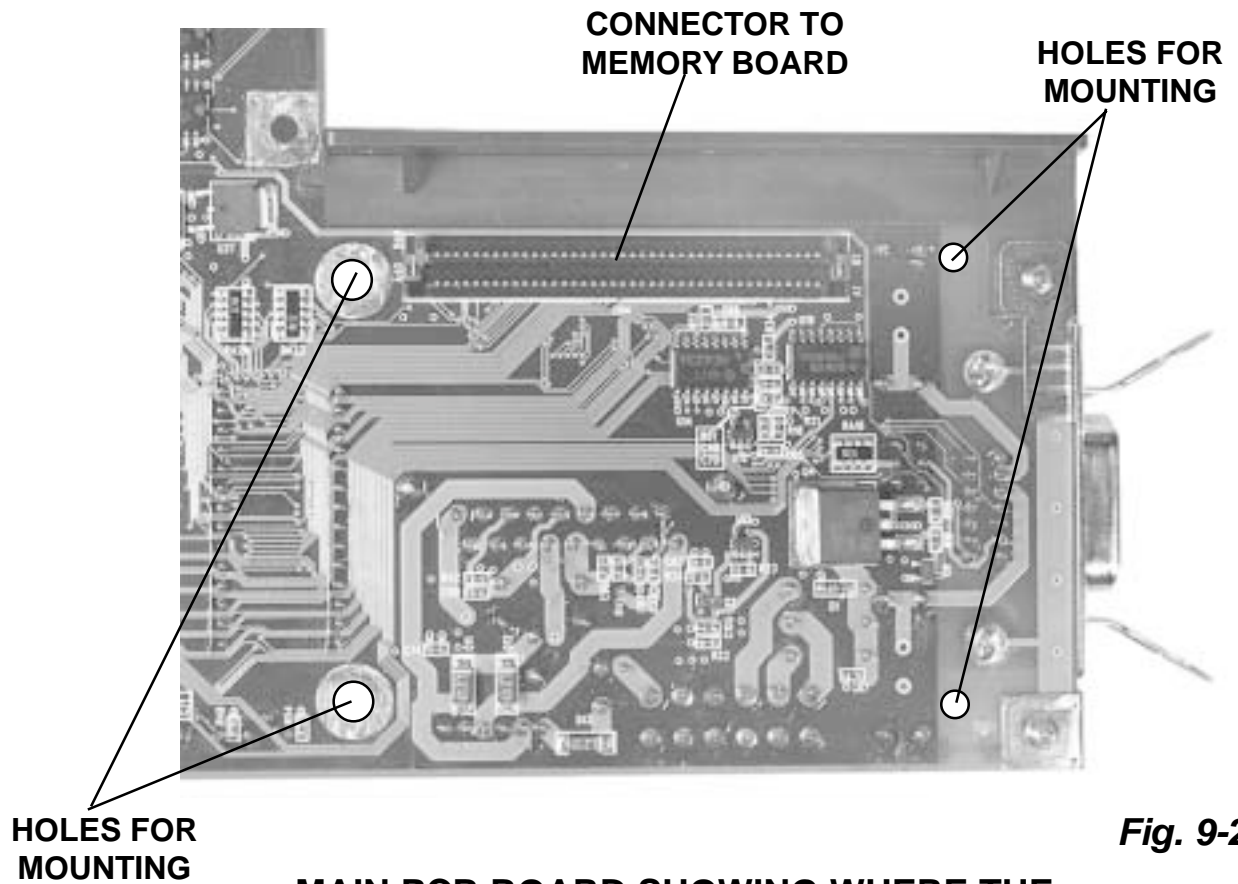
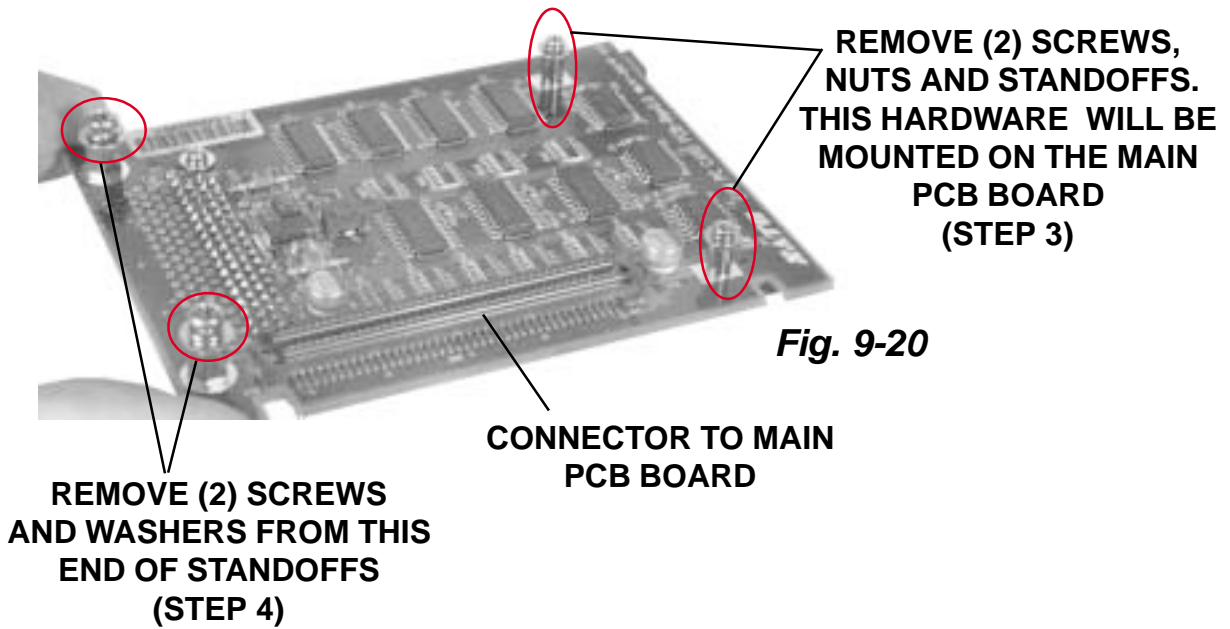

MAIN PCB BOARD SHOWING WHERE THE MEMORY BOARD WILL BE INSTALLED

PCMCIA Memory Expansion Installation

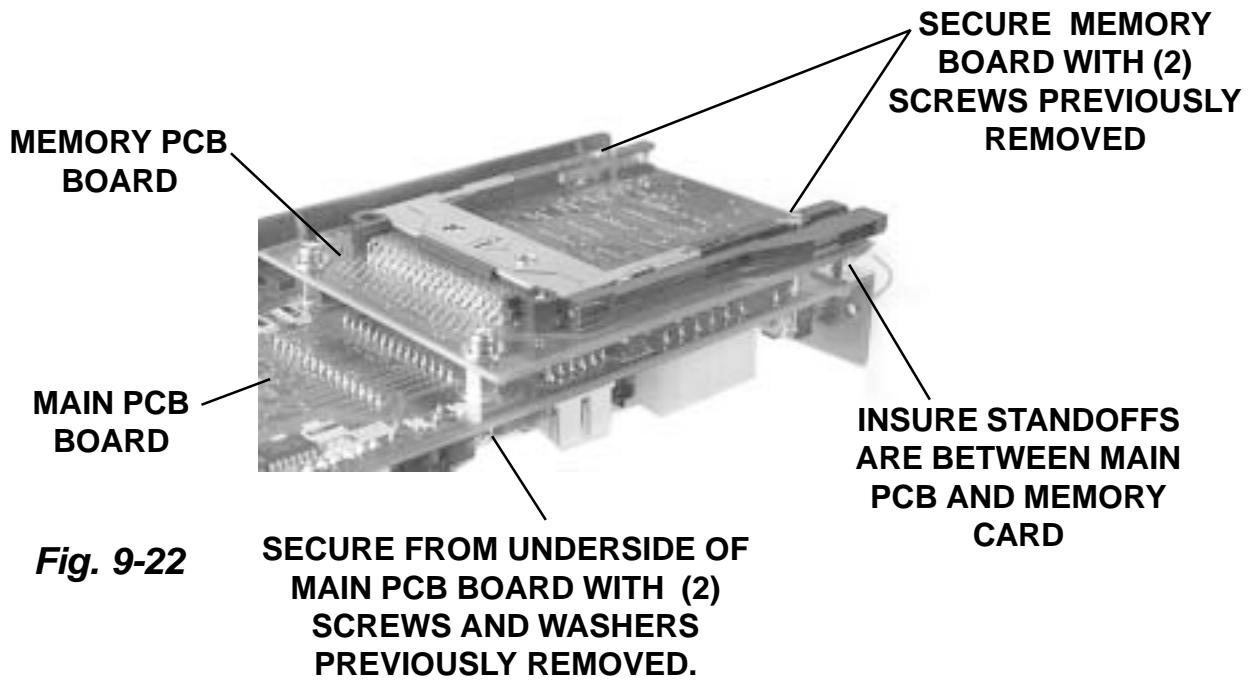

9.5 Flash Memory Expansion Installation

STEP	PROCEDURE
1.	Switch the printer OFF and disconnect the power cable.
2.	Remove (3) screws holding the left side cover to the printer. Raise the access door and loosen the (2) screws on the inside top of the printer. Lift off the left side cover to expose the main PCB. Fig. 9-23
3.	Carefully press outward on the tabs on both ends of the Main PCB Board Memory Frame to release the Standard Memory PCB. The Standard Memory PCB should lift by itself when released. Remove the Memory PCB from the frame. Note the indexing notches. Figs. 9-24
4.	Remove the Flash Memory Module from the anti-static bag handling the module by the edges. Note the indexing notches. Insert the module into the Main PCB Memory Frame at approximately 45° away from the Main PCB Board. Gently push down to snap into position. Figs. 9-25
5.	Replace the cover reversing removal steps.
6.	Complete the Factory Reset Procedure.

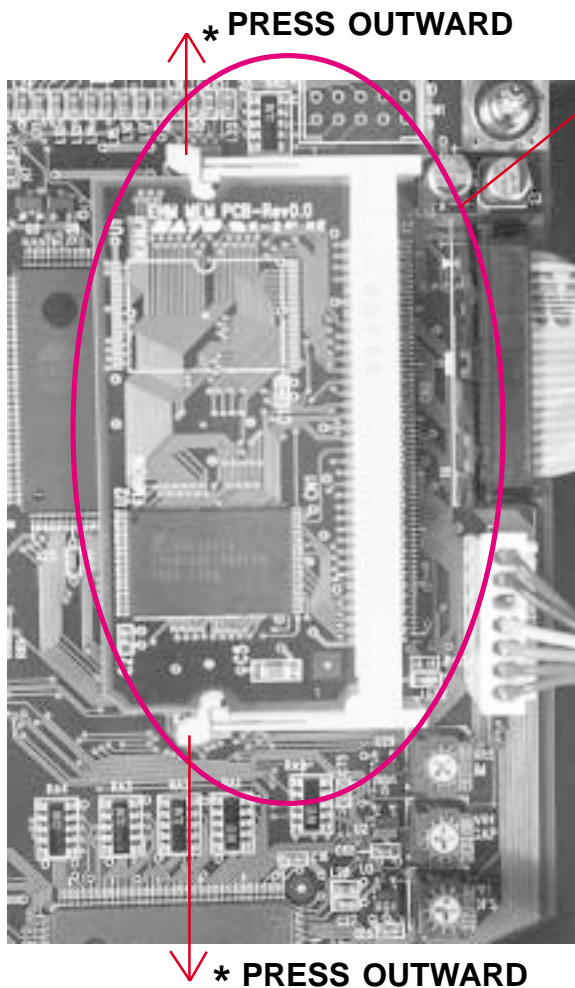

STANDARD MEMORY PCB IN THE MAIN PCB MEMORY FRAME

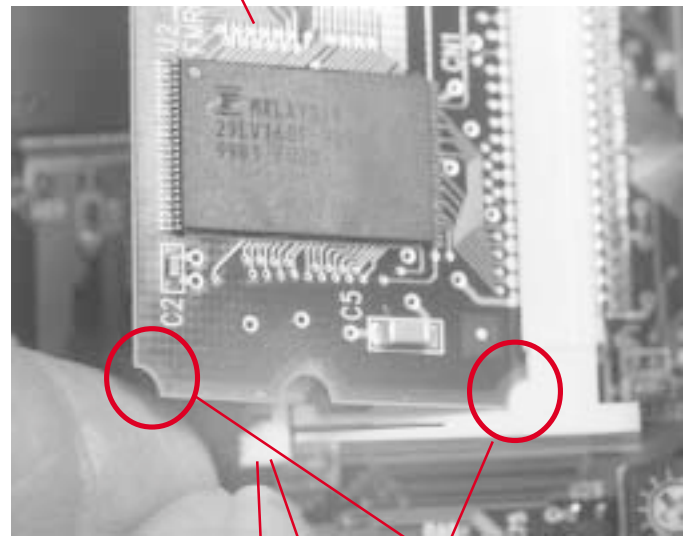

Figs. 9-24

INDEXING NOTCHES

*** CAREFULLY PRESS OUTWARD ON TABS ON BOTH ENDS OF THE FRAME TO RELEASE THE MEMORY PCB.**

Flash Memory Expansion Installation

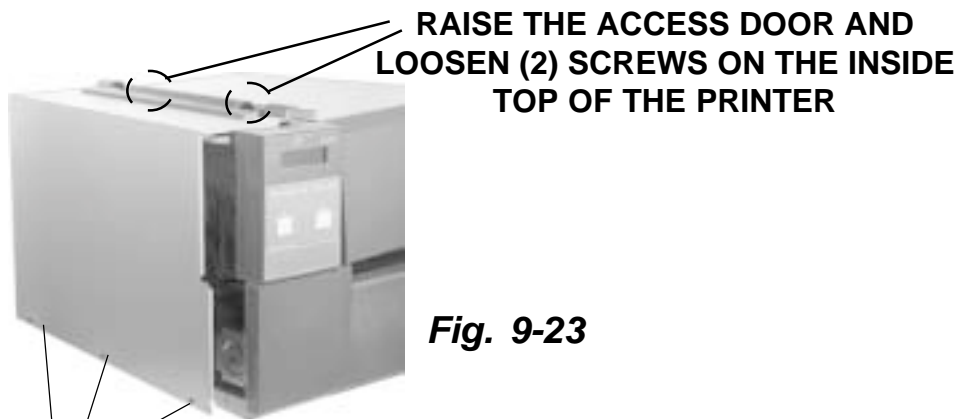
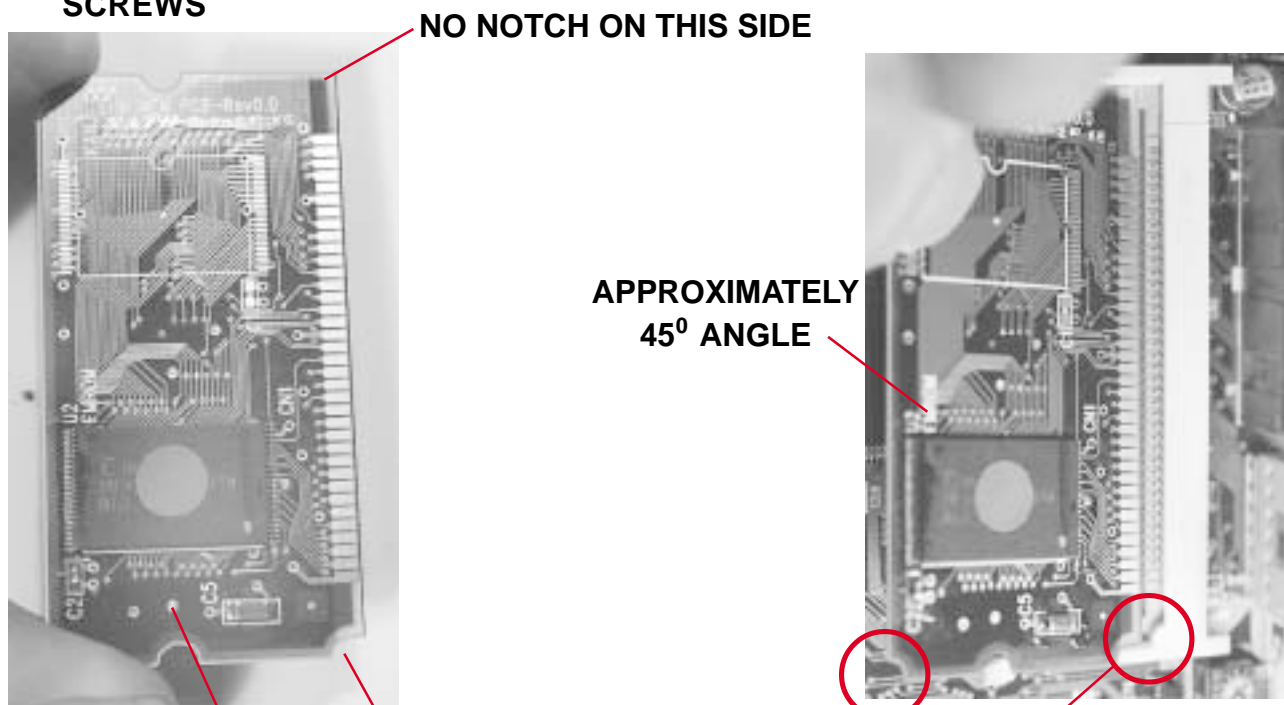

Fig. 9-23



REMOVE (3)
SCREWS

NO NOTCH ON THIS SIDE

APPROXIMATELY
45° ANGLE

INDEXING NOTCH

FLASH MEMORY MODULE

INDEXING NOTCHES

Figs. 9-25

INSERT THE FLASH MEMORY
MODULE INTO THE MAIN PCB
MEMORY FRAME AT
APPROXIMATELY 45°. NOTE THE
INDEXING NOTCH ON THE
MODULE. GENTLY PUSH DOWN TO
SNAP INTO POSITION

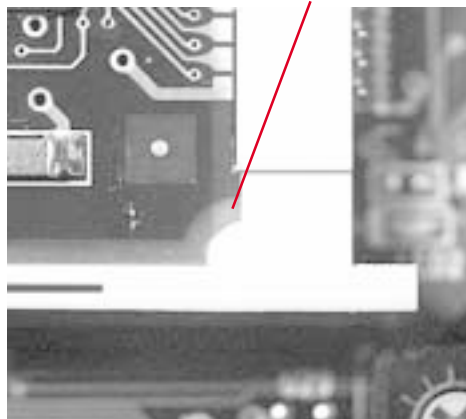

9.6 Real Time Clock Installation

The Real Time Clock Chip allows the date and time to be maintained in the local printer rather than using the system clock. It consists of a special clock chip that replaces the EEPROM chip on the main PCB.

STEP	PROCEDURE
1.	Switch the printer OFF and disconnect the power cable.
2.	Remove (3) screws holding the left side cover to the printer. Raise the access door and loosen the (2) screws on the inside top of the printer. Lift off the left side cover to expose the main PCB. Fig. 9-26.
3.	Refer to Figs. 9-27. Remove the EEPROM chip. CAUTION: Using a screwdriver to remove EEPROM may cause damage to the PCB. Be sure to have Prom remover under EEPROM and not under the socket itself.
4.	Install the Real Time Clock Chip in location vacated by the EEPROM chip. Carefully align and insert the chip with the mark spot on the chip (identifying pin1) securely into the chip block socket using the "U" shaped notch as reference. Be very careful not to bend any chip legs.
5.	Replace the cover reversing removal steps.
6.	Complete the Factory Reset Procedure.

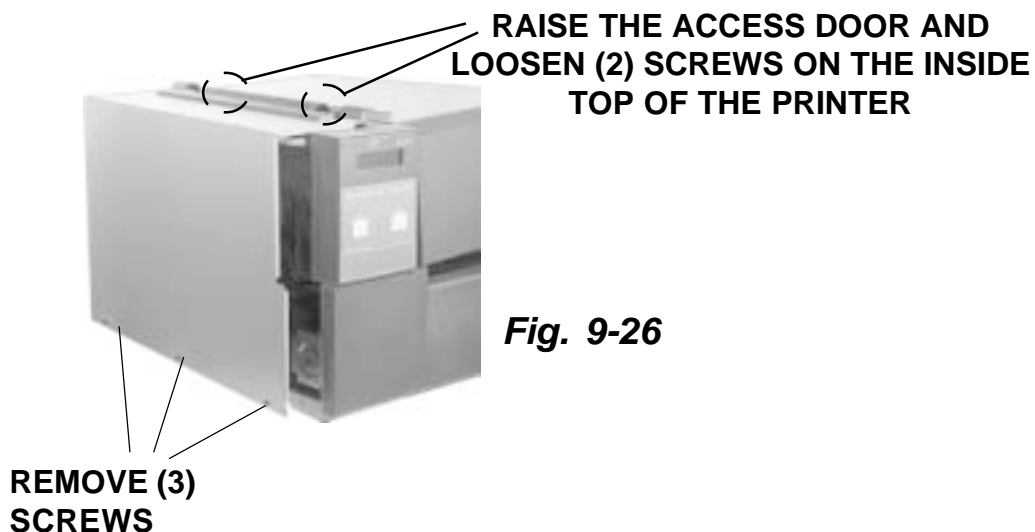

Real Time Clock Chip Installation

MAIN PCB BOARD

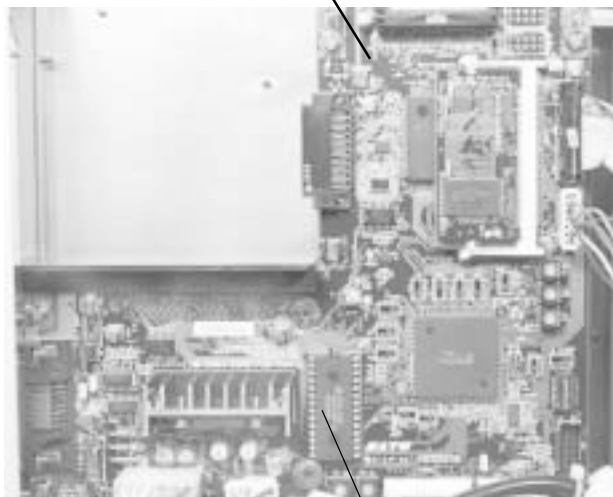

REMOVE THE EEPROM CHIP

INSTALL THE
TIMEKEEPER CHIP IN
VACATED LOCATION

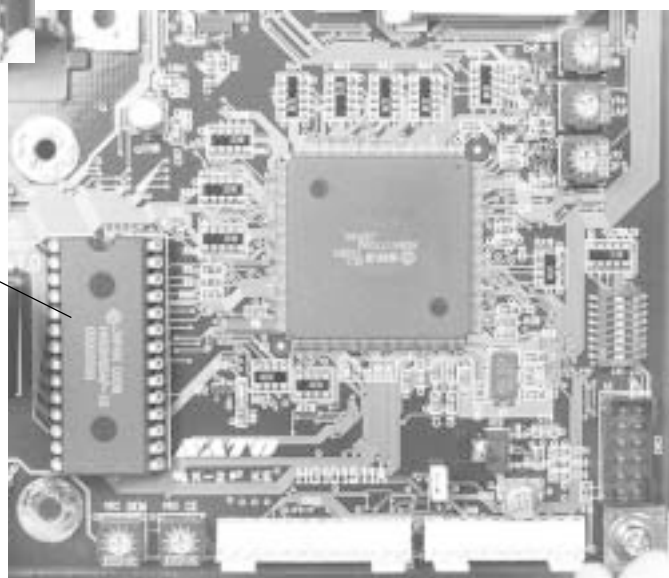

MARK ON CHIP IDENTIFIES
PIN 1. BE SURE TO ALIGN
CHIP CORRECTLY IN CHIP
BLOCK SOCKET USING THE
"U" SHAPED NOTCH AS
REFERENCE

PIN 1

PIN 1

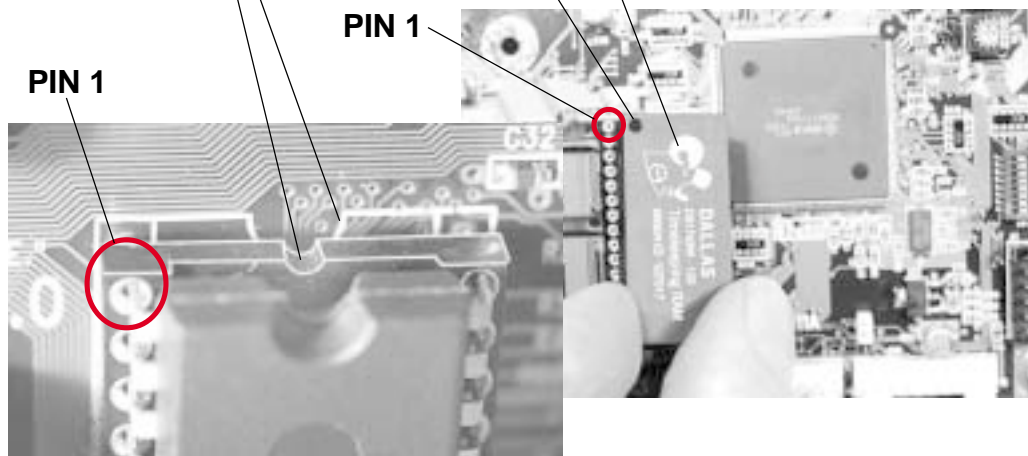





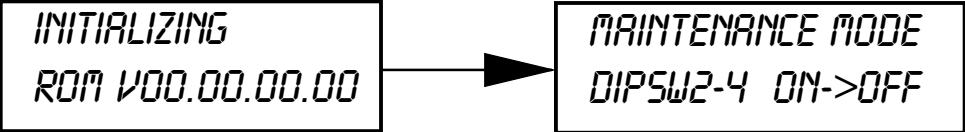

Figs. 9-27

Factory Reset Procedure

To reset the printer to the factory settings, perform the following steps.

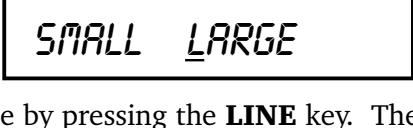
Caution: Resetting the printer will clear all registers.

STEP	PROCEDURE
1.	Record all current dip switch positions, then place all switches in the OFF position.
2.	Place the DSW2-4 in the ON or up position.
3.	Press the LINE and FEED key while simultaneously turning ON the power switch. When the printer beeps, release the keys. The following screens will appear.
	
4.	Place the DSW-4 in the OFF position and the following screen will appear.
	
5.	Press the FEED key to display the next screen.
	
6.	Press the LINE key once to change the message from NONE to ALL .
	
7.	Press the FEED key to clear the EEPROM. After a pause, the next screen will appear.
	
8.	Select the print label size by pressing the LINE key. The default is LARGE.
9.	Press the FEED key for a test print. Press the FEED key again to stop printing.
	 <p data-bbox="899 1633 1484 1801">Warning: This test activates all the heating elements on the print head and therefore should be used for testing purposes only with full width labels to avoid damaging the print head.</p>
10.	Verify that the counters on the test print have reset to 0.0 km.
11.	Power OFF the printer and confirm that all switches are in the OFF or down position.

Set Calendar

After the Real Time Chip has been installed you must enter the Advance Mode to set the Calendar. Several steps are necessary in the Advanced Mode to get to the Calendar screen. For a full description of the steps in the Advanced mode leading to the Calendar screen refer to the Section 2 in the Service Manual.

The following steps will take you to the Calendar screen where you can input the settings:

To Enter Advanced Mode:

STEP	PROCEDURE
1.	<p>Press the LINE key while simultaneously turning the power on. When the printer emits one long beep, release the LINE key to display the first screen.</p> <div style="display: flex; align-items: center; justify-content: center;"> <div style="border: 1px solid black; padding: 5px; margin-right: 20px;"> <p style="text-align: center;">INITIALIZING ROM V00.00.00.00</p> </div> <div style="font-size: 2em;">→</div> <div style="border: 1px solid black; padding: 5px; margin-left: 20px;"> <p style="text-align: center;">ADVANCED MODE</p> </div> </div>
2.	<p>Press the FEED key 11 times to display the “Set Calendar” display.</p> <div style="display: flex; align-items: center; justify-content: center;"> <div style="margin-right: 20px;"> <p>Set Calendar</p> </div> <div style="border: 1px solid black; padding: 5px;"> <p style="text-align: center;">SET CALENDAR YES NO</p> </div> </div>

This message will only be displayed if the Calendar Option is installed in the printer.

The Calendar is an optional feature in CL608e/CL612e printers allowing the date and time to be set manually using the LCD Display or via the <ESC>WT Calendar Set command (SATO Programming Language). The last setting, set either manually via software command, received by the printer will be the value used. The format of the display is YY/MM/DD hh:mm (Year/Month/Day/hours:minutes). The date format is fixed and cannot be changed.

To enable the Calendar feature (if installed), press the LINE key until the underline cursor is beneath the YES. If the Calendar feature is to be disabled, press the LINE key until the cursor is underneath the NO. When the desired setting is selected, Press the FEED key.



Set Calendar (Cont)

STEP	PROCEDURE
1.	Year - The first display shown will have the two digit year selection underlined. You can scroll through the dates by pressing the LINE key. The year number will increase by one each time the LINE key is pressed until it reaches its maximum legal value (i.e., "99" for the year digits) at which point it will wrap around to the "00" setting.
2.	Month - After you have set the correct year, pressing the FEED key will advance the underline cursor to the two digit Month position. You can scroll through the numbers corresponding to the month by pressing the LINE key. The month number will increase by one each time the LINE key is pressed until it reaches a value of "12" at which point it will wrap around to the "01" setting.
3.	Day - After you have set the correct month, pressing the FEED key will advance the underline cursor to the two digit Day position. You can scroll through the numbers corresponding to the month date by pressing the LINE key. The date number will increase by one each time the LINE key is pressed until it reaches a value of "31" at which point it will wrap around to the "01" setting.
4.	Hour - After you have set the correct date, pressing the FEED key will advance the underline cursor to the two digit Hour position. You can scroll through the numbers corresponding to the hour (using a 24 hour clock) by pressing the LINE key. The hour number will increase by one each time the LINE key is pressed until it reaches a value of "24" at which point it will wrap around to the "01" setting.
5.	Minute - After you have set the correct hour, pressing the FEED key will advance the underline cursor to the two digit Minute position. You can scroll through the numbers corresponding to the hour by pressing the LINE key. The minute number will increase by one each time the line key is pressed until it reaches a value of "60" at which point it will wrap around to the "01" setting.
6.	After you have set the minutes, pressing the FEED key will accept the setting. Power Off the printer to exit.



Spare Parts List

10.1 Overview

The following parts lists are included for the CL608e/CL612e Printers:

- *Base Cover Assembly*
- *Frame Assembly*
- *Print Head Assembly*
- *Ribbon Assembly*
- *Feed Roller Assembly*
- *Main PCB Assembly*
- *Interface Option*
- *Dispenser Assembly Option*
- *Cutter Assembly Option*
- *PCMCIA Memory Option*

Note:

The spare parts information in this manual is accurate at the time of publication of this service manual and is subject to change without notice.

10.2 Base Cover Assembly

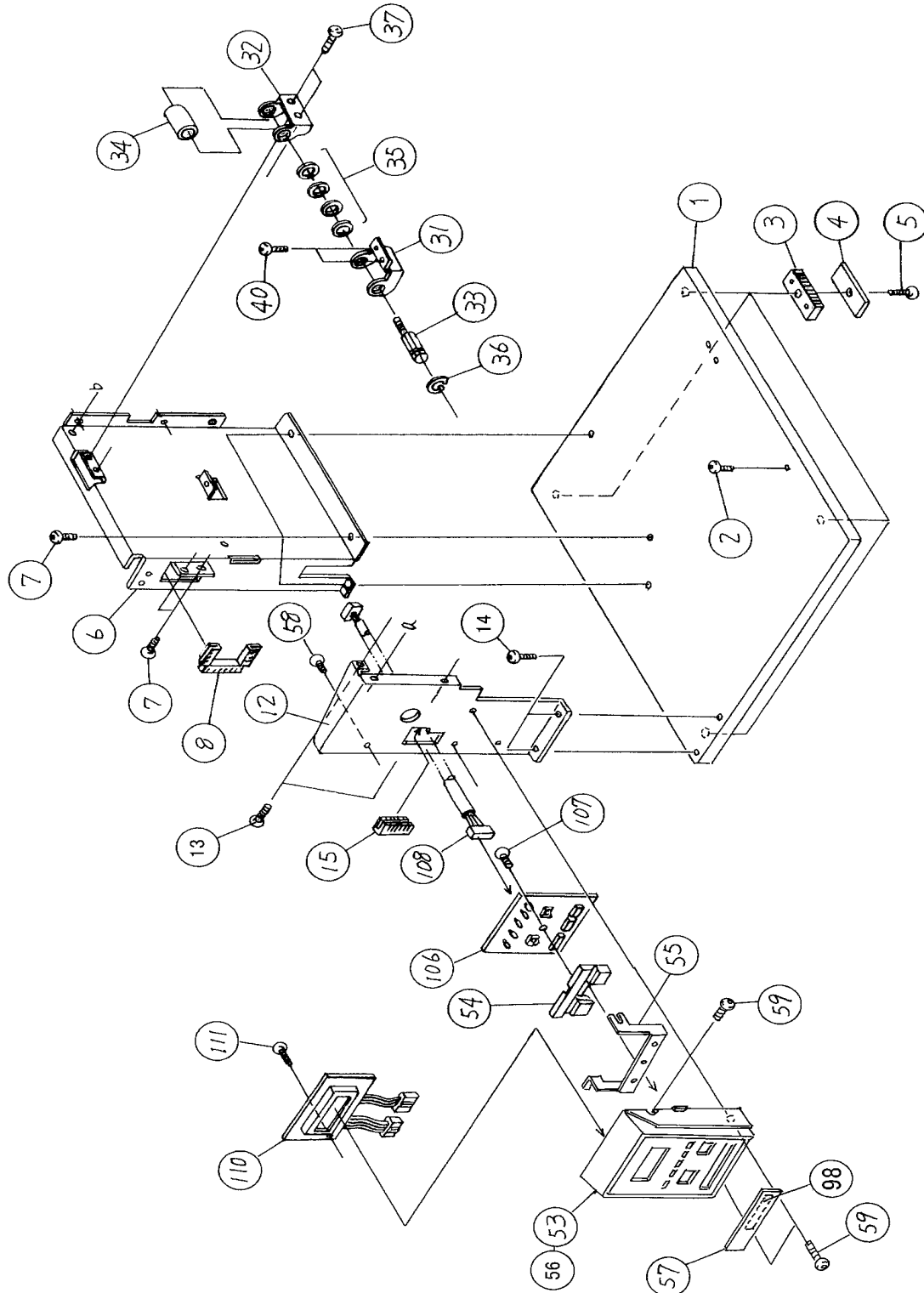

Base Cover Assembly

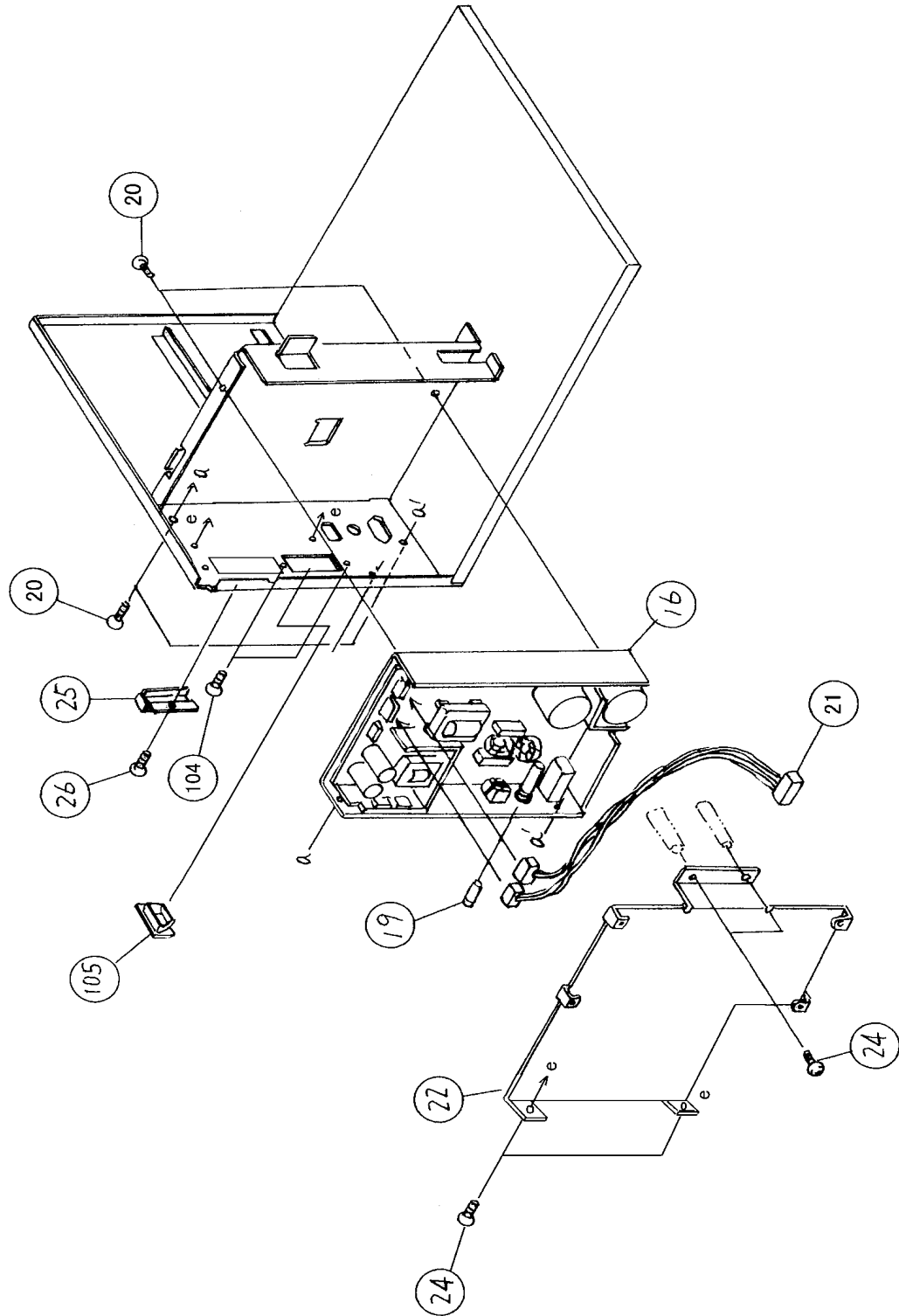

Base Cover Assembly

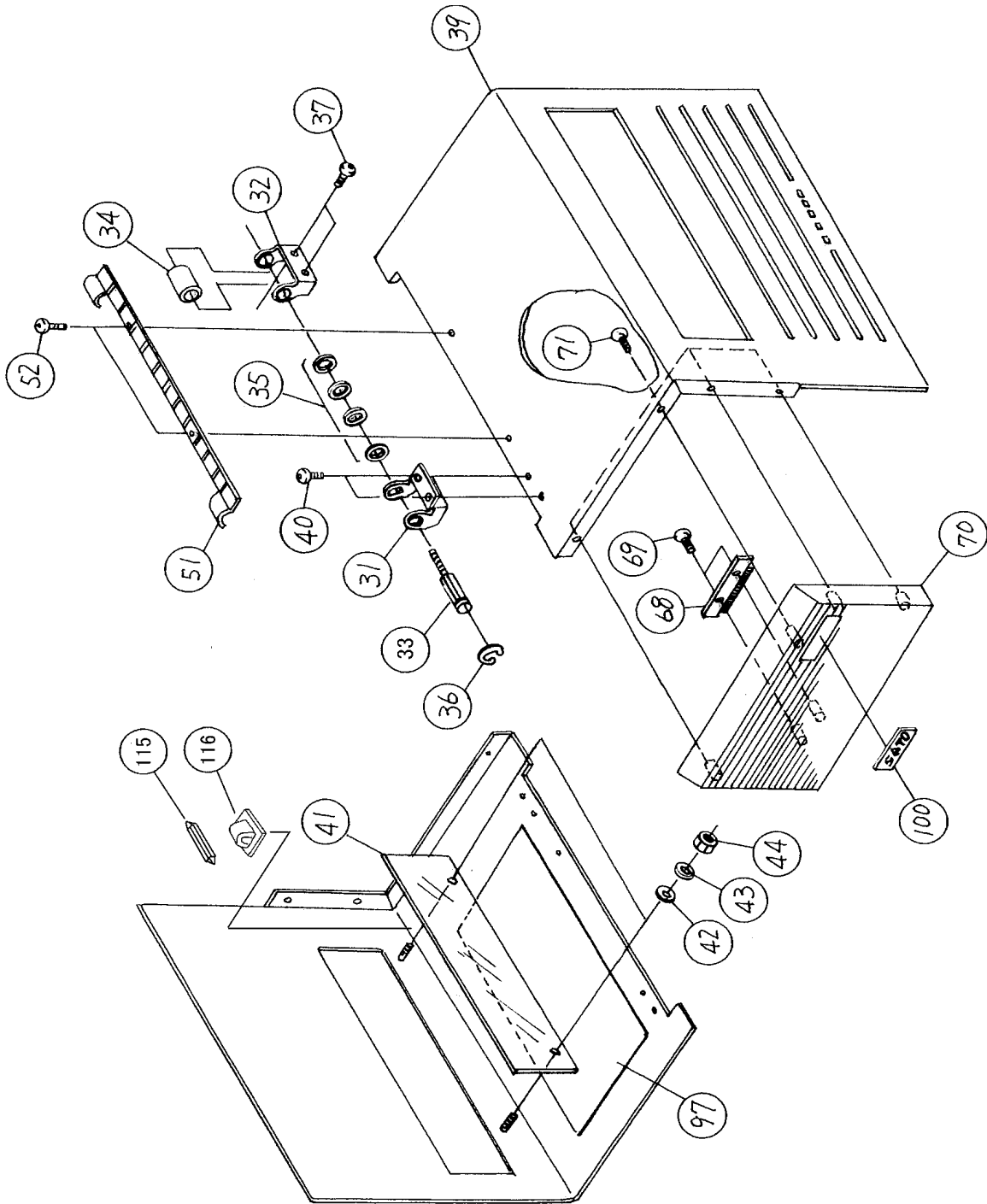

Base Cover Assembly

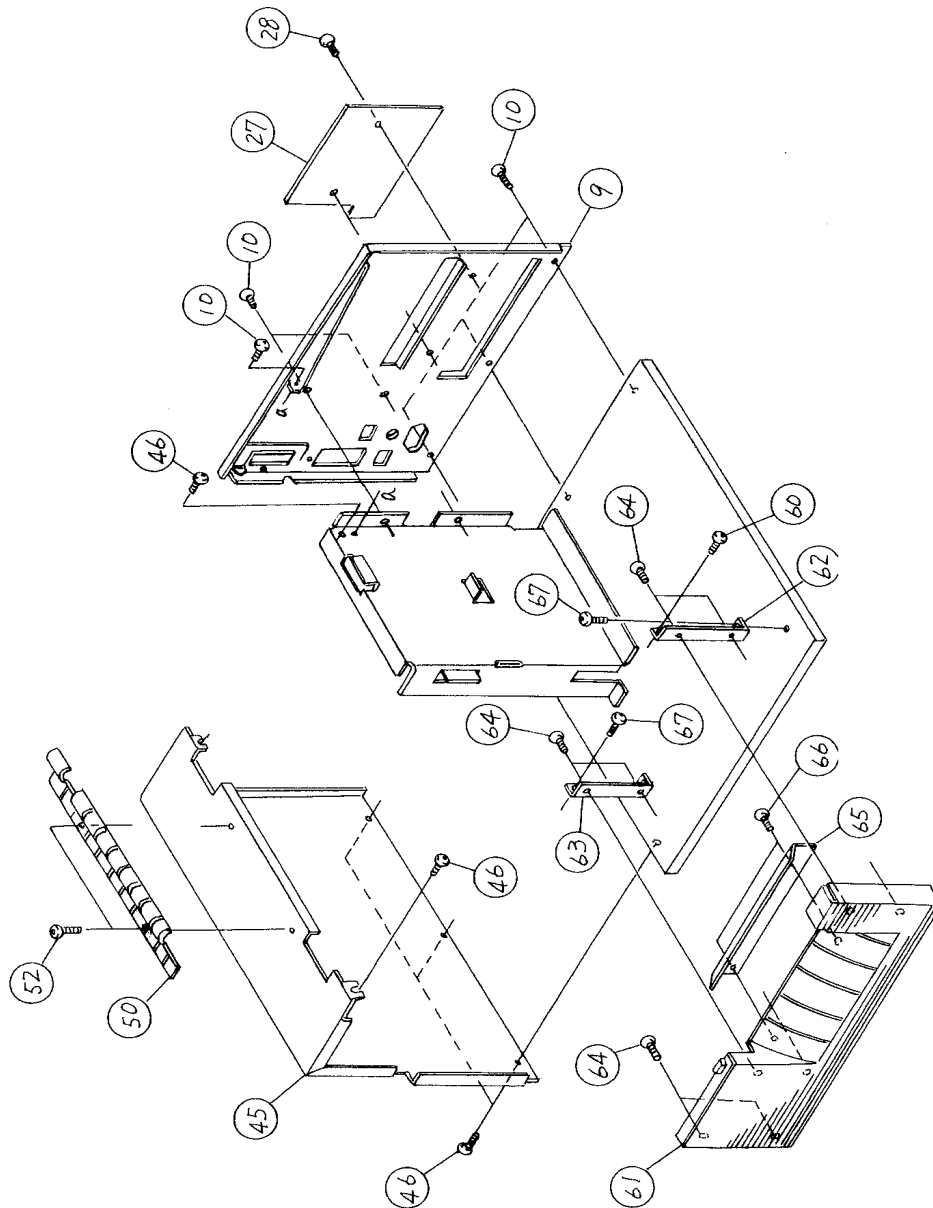

Base Cover Assembly

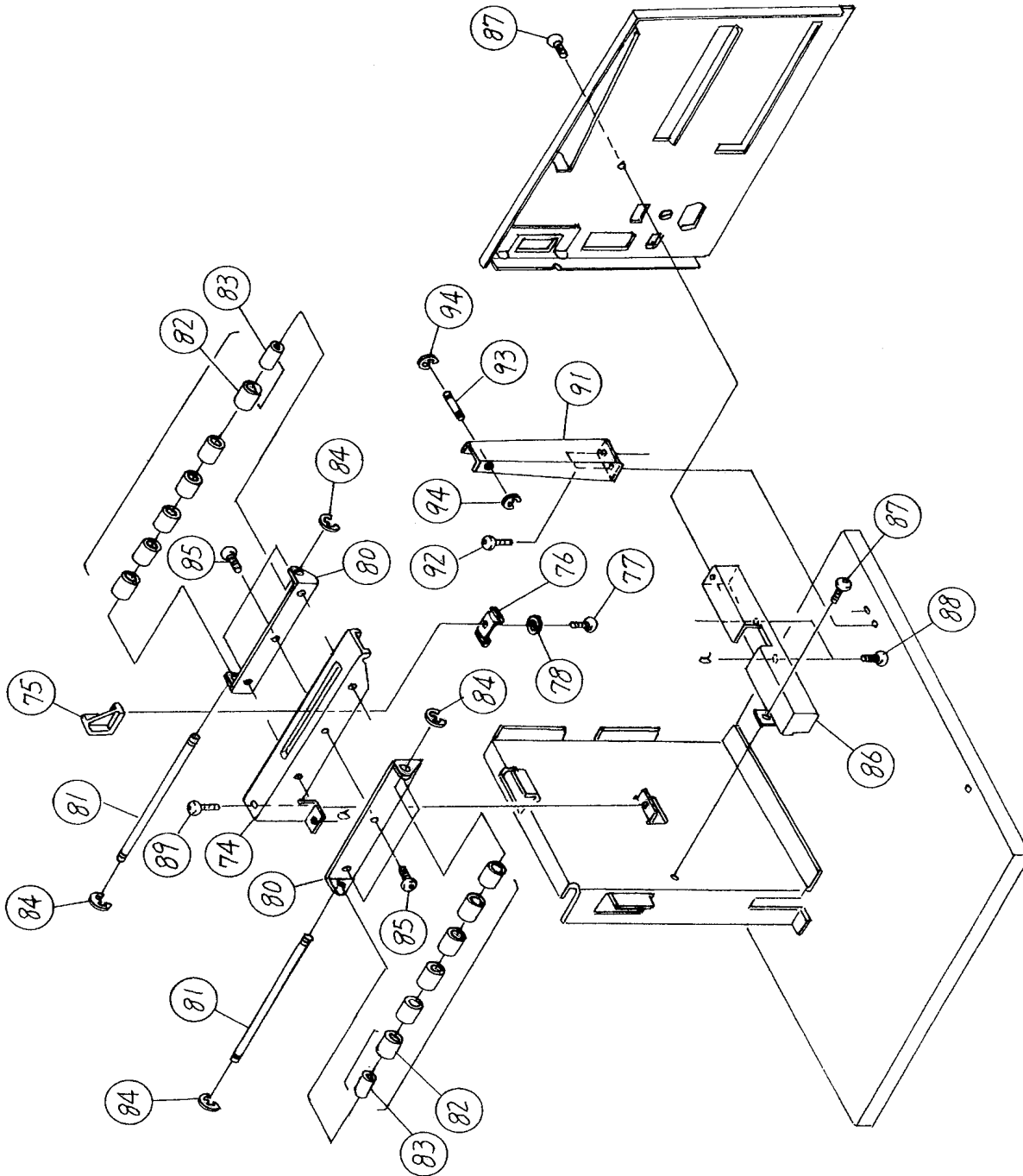

Base Cover Assembly

NO.	CODE	DESCRIPTION	QTY
1	PH1720101	Base Frame	1
2	MH4300621	S-tight screw	1
3	PE6721100	Foot	4
4	PV2720100	Foot rubber	4
5	MD4301021	Pan head screw	4
6	PH1720200	Center frame	1
7	MD4400821	Pan head screw	5
8	PV9720200	Bush	1
9	PZ0725001	Cover Rear	1
10	MD4300821	Pan head screw	6
12	PH1720400	Front frame	1
13	MD3401021	Pan head screw	3
14	MD4400821	Pan head screw	2
15	PV9720600	Bush	1
16	KA500821A	Power Supply	1
19	HD100311A	Fuse (6.3A,250V)	1
20	MD4300621	Pan head screw	4
21	RH1727700	Power Supply Cable	1
22	PA1729700	PCB Bracket	1
24	MD4300821	Pan head screw	4
25	PE6771001	Memory card cover	1
26	PB5A20001	Head Screw	1
27	PH1720700	Lid	1
28	MD4300821	Pan head screw	2

Base Cover Assembly

NO.	CODE	DESCRIPTION	QTY
31	PA1722300	Hinge bracket (A)	2
32	PA1722400	Hinge bracket (B)	2
33	PB5720100	Screw	2
34	PB5720200	Screw	2
35	NB5100030	Spring	8
36	ND3120024	E-Ring	2
37	MD4300821	Pan head screw	4
39	PR4720100	Cover RH	1
40	MD4300821	Pan head screw	4
41	PH2720100	Window	1
42	NA1030022	Plain washer	2
43	NB0030022	Spring washer	2
44	MT1300522	Hex nut	2
45	PH1720601	Cover LH	1
46	MD4300821	Pan head screw	5
50	PE6720900	Hinge cover (LH)	1
51	PE6721000	Hinge cover (RH)	1
52	MA7300625	Truss screw	4
53	PR4725000	Key Board Cover (CL608e)	1
54	PE6720800	Switch button	1
55	PA1728600	Plate	1
56	PR4725100	Key Board Cover (CL612e)	1
57	PR4720300	Dip-sw cover	1
58	MH0300821	P tight screw	1
59	MD4301021	Pan head screw	3
60	MD3300521	Pan head screw	1

Base Cover Assembly

NO.	CODE	DESCRIPTION	QTY
61	PH0720200	Front cover	1
62	PA1722500	Front cover bracket (A)	1
63	PA1722600	Front cover bracket (B)	1
64	MH0300821	P tight screw	6
65	PA1724000	Tear-off cutter	1
66	MH0300821	P tight screw	2
67	MD4300821	Pan head screw	2
68	PR1340500	Brush	1
69	MH0300821	P tight screw	2
70	PH0720300	Cover RH sub	1
71	MH0300821	P tight screw	4
74	PA1729100	Paper holder	1
75	PE1720300	Label stopper	1
76	PA4520300	Stopper spring	1
77	MH0300821	P tight screw	1
78	NA1030022	Plain washer	1
80	PA1729200	Roller bracket	2
81	PB0723600	Shaft (Unwind)	2
82	PE3720200	Roller	12
83	PE3720500	Roller	12
84	ND0040030	E-Ring	4
85	MD4300821	Pan head screw	6
86	PA1723700	Unwind bracket (A)	1
87	MD4300821	Pan head screw	2
88	MD4300821	Pan head screw	2
89	MD4400821	Pan head screw	1

Base Cover Assembly

NO.	CODE	DESCRIPTION	QTY
91	PR3720100	Unwind Bracket (B)	1
92	MD4300821	Pan head screw	2
93	PB0722500	Shaft (unwind)	1
94	ND0030030	E-Ring	2
97	QC6725000	Sticker (Route DIP SW)	1
98	QC6722300	Sticker	1
100	QC6685403	Log Name Plate	1
104	MA0300622	Pan head screw	2
105	JG900411A	Cap	1
106	RJ1721600	KB PCB Set	1
107	MH0300821	P tight screw	1
108	RH1720400	Control Panel	1
110	RH1745700	Cable Assy	1
111	MH0250621	P-tight screw	1
115	PE6A21900	Micro Driver	1
116	JG100551A	CK clamp	1

10.3 Frame Assembly

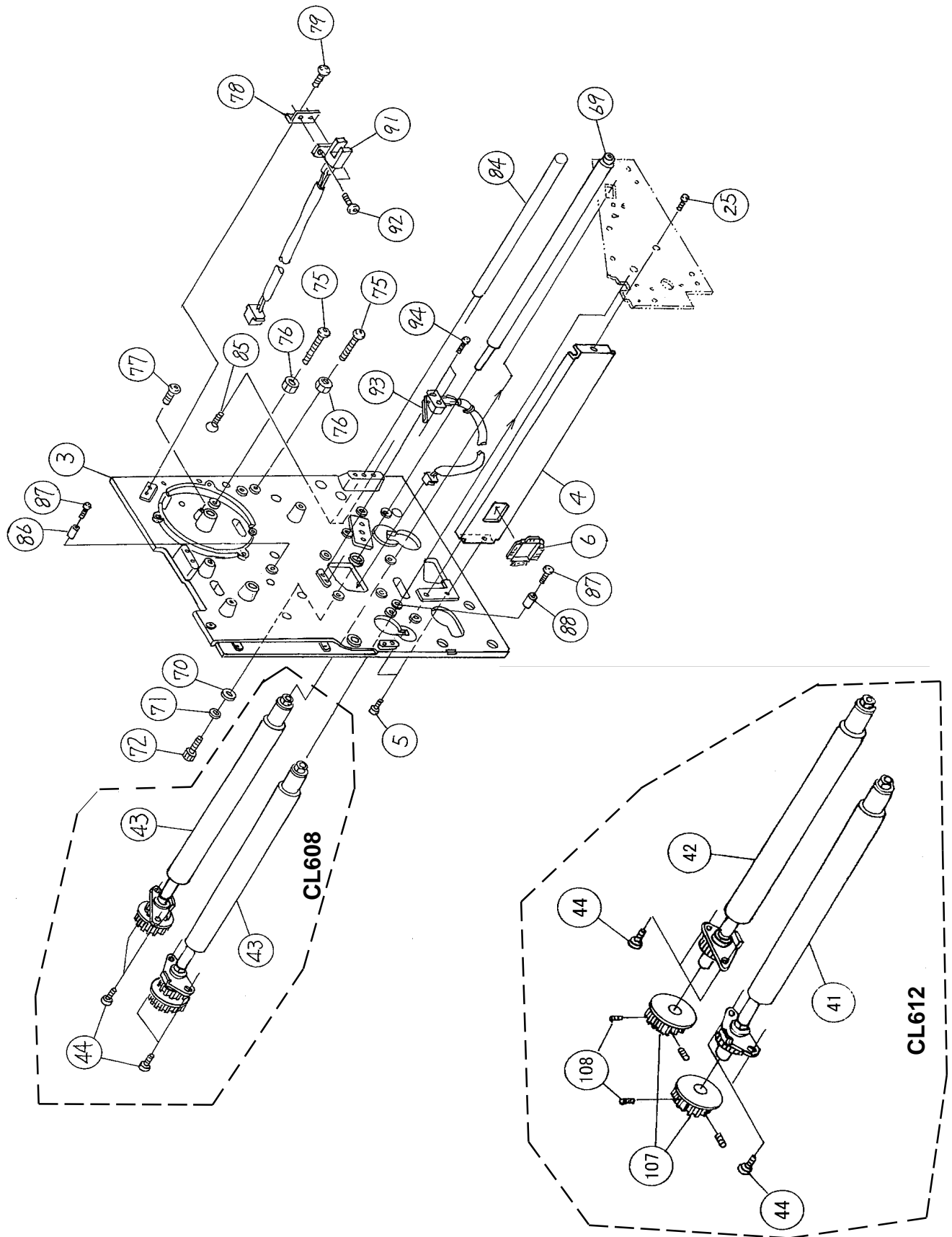

Frame Assembly

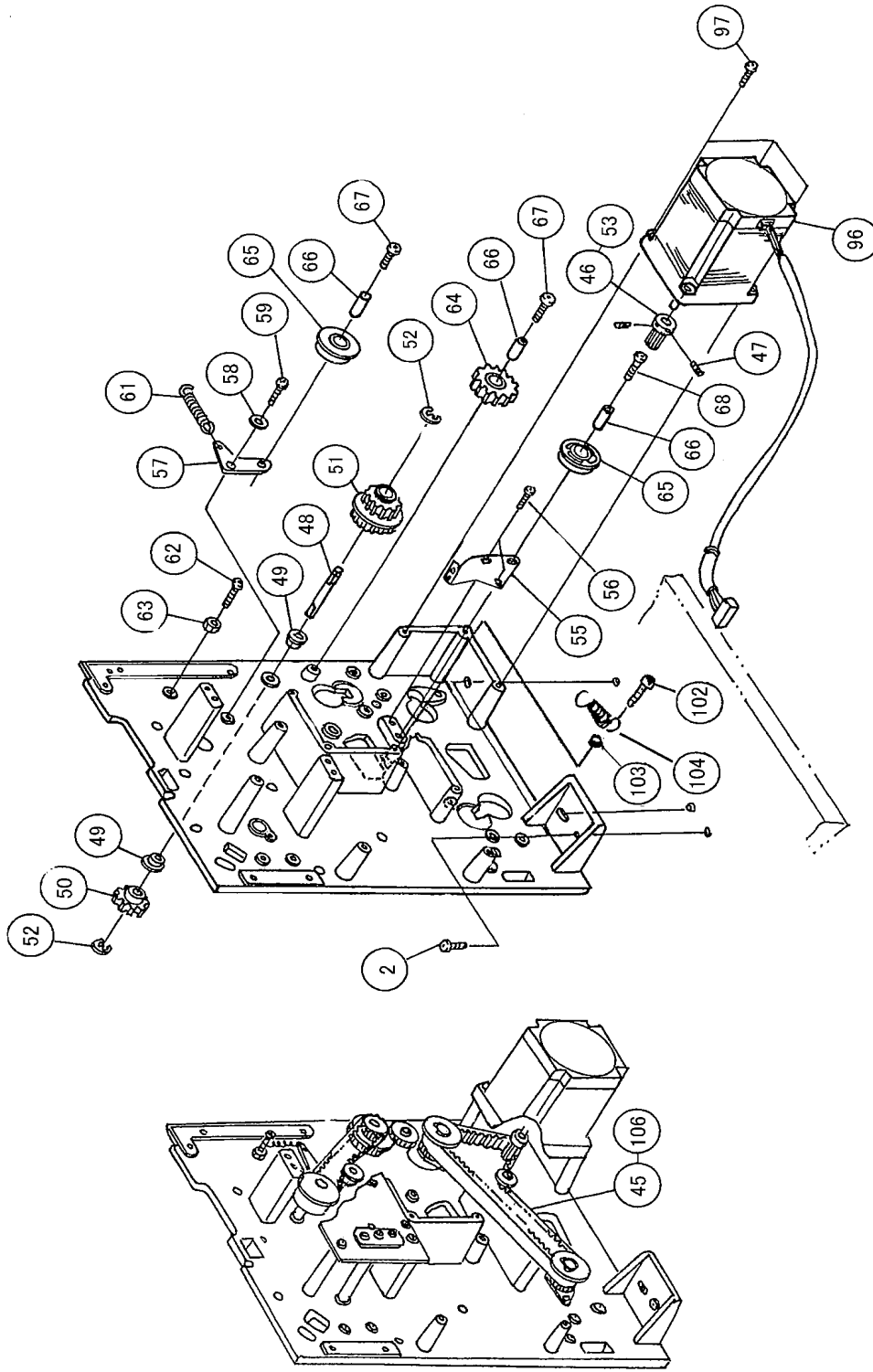

Frame Assembly

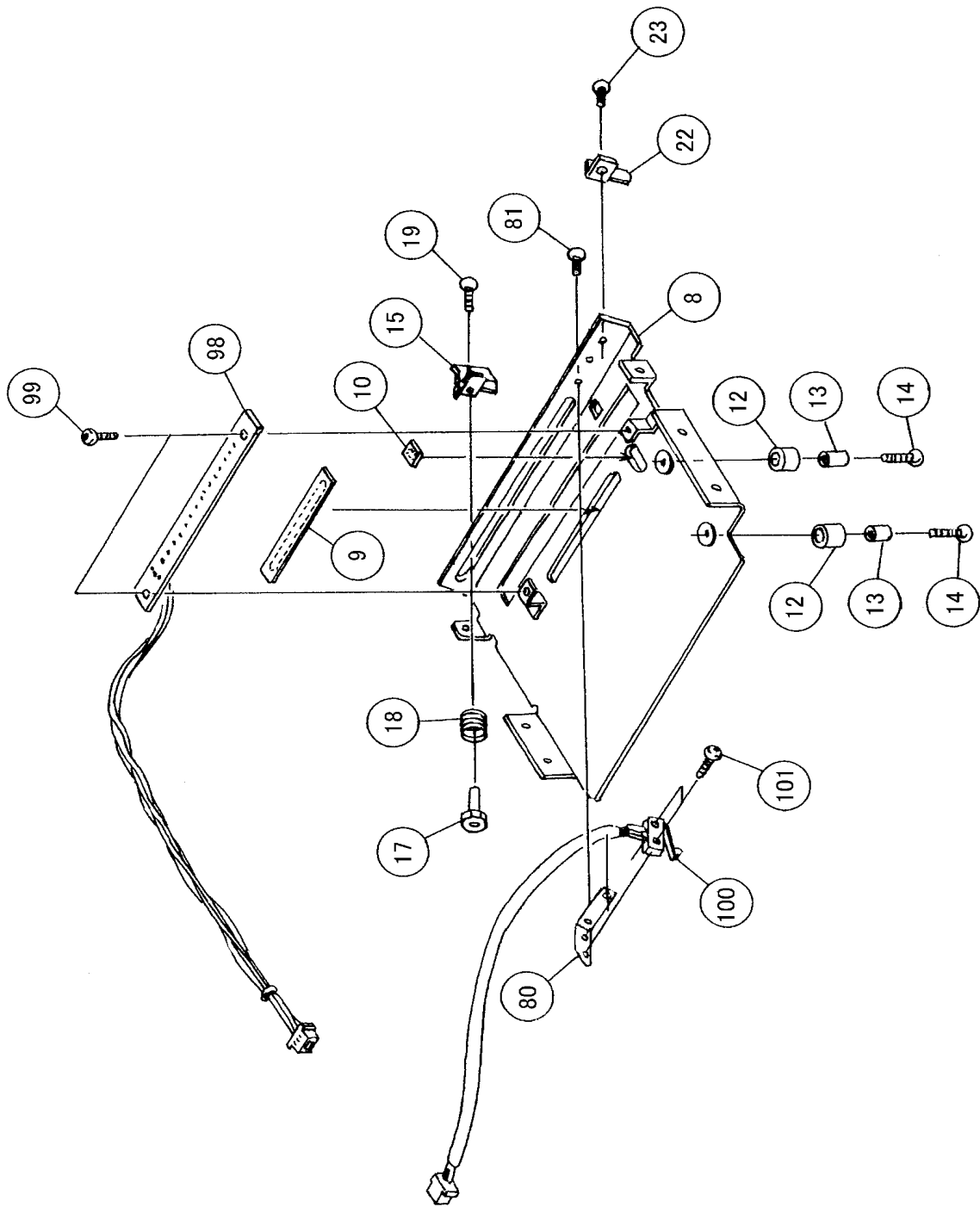

Frame Assembly

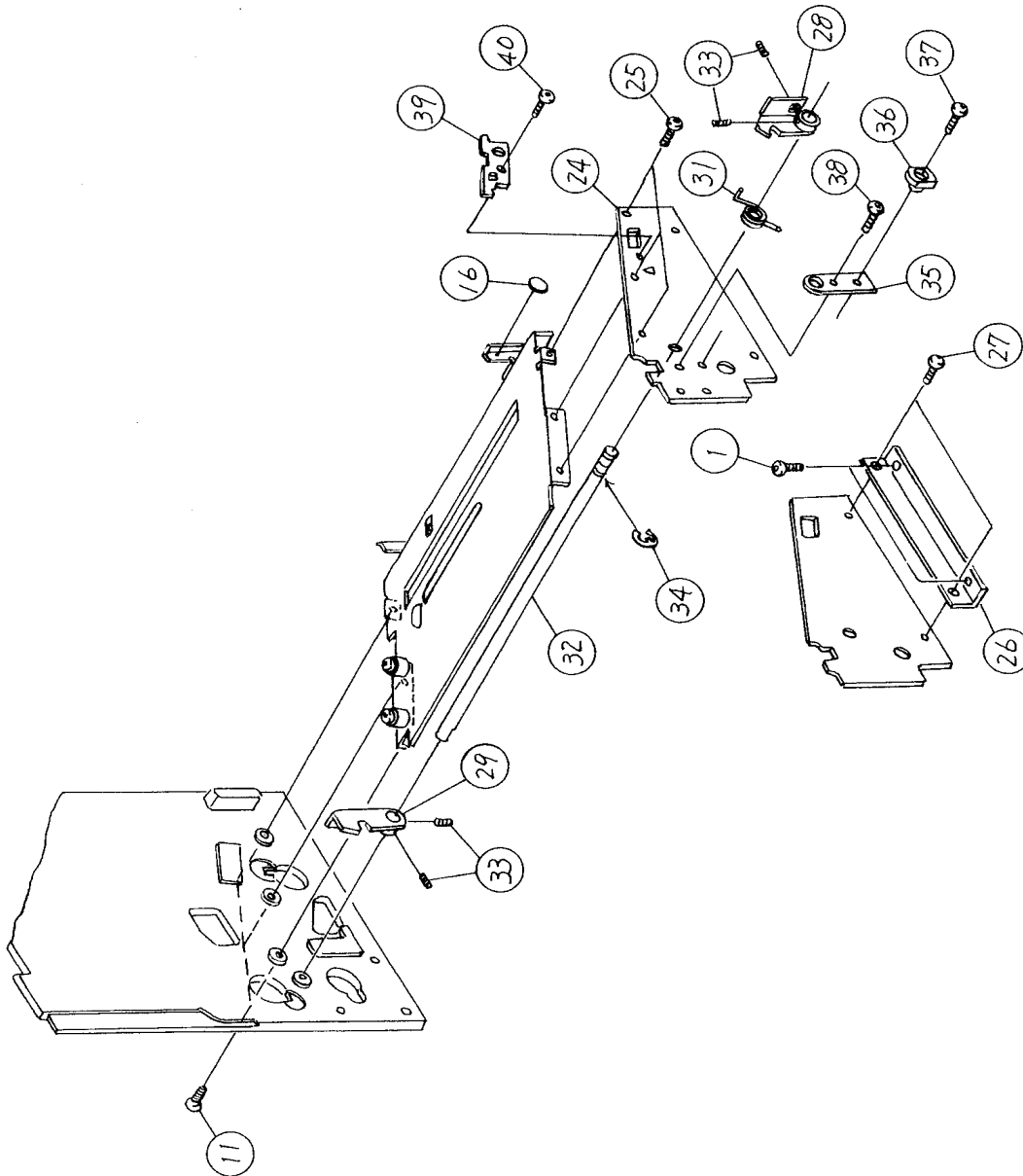

Frame Assembly

NO.	CODE	DESCRIPTION	QTY
1	MD4400821	Pan head screw	2
2	MD4401621	Pan head screw	2
3	PL1720601	Engine Frame	1
4	PA1721600	Support frame (A)	1
5	MD4301422	Pan head screw	2
6	PV9720500	Bush	1
8	PR3720400	Paper guide	1
9	PV9720900	Sensor protector	1
10	PD1720800	Sensor protector	1
11	MD4301422	Pan head screw	3
12	PE3720300	Roller	2
13	PB2740100	Collar	2
14	MD4301021	Pan head screw	2
15	PA1729500	Guide plate (A)	1
16	QC6771800	Sticker(Green)	1
17	PB2721100	Collar	1
18	PC1720700	Spring (Guide)	1
19	MD4301422	Pan head screw	1
22	PA1722900	Guide plate (B)	1
23	MD4300821	Pan head screw	1
24	PA1723000	Side frame	1
25	MD4300821	Pan head screw	4
26	PA1720800	Frame bracket	1
27	MD4400821	Pan head screw	2
28	PR4720400	Latch handle (A)	1
29	PR1720600	Latch handle(B)	1

Frame Assembly

NO.	CODE	DESCRIPTION	QTY
31	PC2720100	Spring (latch handle)	1
32	PB0723700	Shaft (latch handle)	1
33	MJ1400524	W-point screw	4
34	ND0050030	E-Ring	1
35	PA1720900	Plate (adjust A)	1
36	PL2720100	Adjust collar	1
37	MD4300821	Pan head screw	1
38	MD4400821	Pan head screw	1
39	PA1721000	Plate (adjust B)	1
40	MD4400821	Pan head screw	1
41	PR7720500	Platen Roller Sub (CL612)	1
42	PR7720600	Feed Roller Sub (CL612)	1
43	PR7720100	Platen Roller Sub (CL608)	2
44	MD4300821	Pan head screw	4
45	PT8180064	Timing belt (CL608)	1
46	PL1720100	Motor pulley (CL608)	1
47	MJ1400524	W-point screw	2
48	PB0720800	Shaft (idle gear)	1
49	PT1112060	Ball supporter	2
50	PE8720100	Gear	1
51	PE8720400	Gear pulley	1
52	ND0040030	E-Ring	2
53	PL1720400	Motor Pulley (CL612)	1
55	PA1729600	Tension bracket	1
56	MD4300821	Pan head screw	2
57	PA1723200	Tension bracket (B)	1
58	PB2720400	Collar	1
59	MD4401021	Pan head screw	1
61	PC0740100	Spring (tension)	1
62	MA0301221	Pan head screw	1
63	MT1300522	Hex nut	1
64	PE8720300	Gear	1
65	PE3720100	Tension roller	2
66	PB2720600	Collar	3

Frame Assembly

NO.	CODE	DESCRIPTION	QTY
67	MD4401421	Pan head screw	2
68	MD4401621	Pan head screw	1
69	PB0721100	Shaft (head)	1
70	PA0720100	Collar	1
71	NB0050022	Spring washer	1
72	MN1501030	Hex hole bolt	1
75	MA0301221	Pan head screw	2
76	MT1300522	Hex nut	2
77	MD3300622	Pan head screw	1
78	PA3730200	Sensor bracket (ribbon)	1
79	MD3300622	Pan head screw	1
80	PA1723500	Switch bracket	1
81	MD4300821	Pan head screw	1
84	PB0723800	Label guide shaft	1
85	MA0301221	Pan head screw	2
86	PT6720100	Cushioning rubber	1
87	MA0301221	Pan head screw	2
88	PB2720500	Collar	1
91	RH1721000	Ribbon sensor cord	1
92	MA0300622	Pan head screw	2
93	RH1721200	Head open sw cord	1
94	MD3201221	Pan head screw	2
96	RH1720500	Stepper Motor Assy	1
97	MD3401221	Pan head screw	3
98	RH1724100	Pitch sensor cord	1
99	MD3300622	Pan head screw	2
100	RH1721400	Paper end SW cord set	1
101	MD3201221	Pan head screw	2
102	MA0401421	Pan Screw	1
103	MT1400722	Hex nut	1
104	PC0720200	Spring (Tension)	1
106	PT8187064	Timing Belt (CL612)	1
107	PL1720500	Pulley (CL612)	2
108	MJ1300424	W-point screw	4

10.4 Print Head Assembly

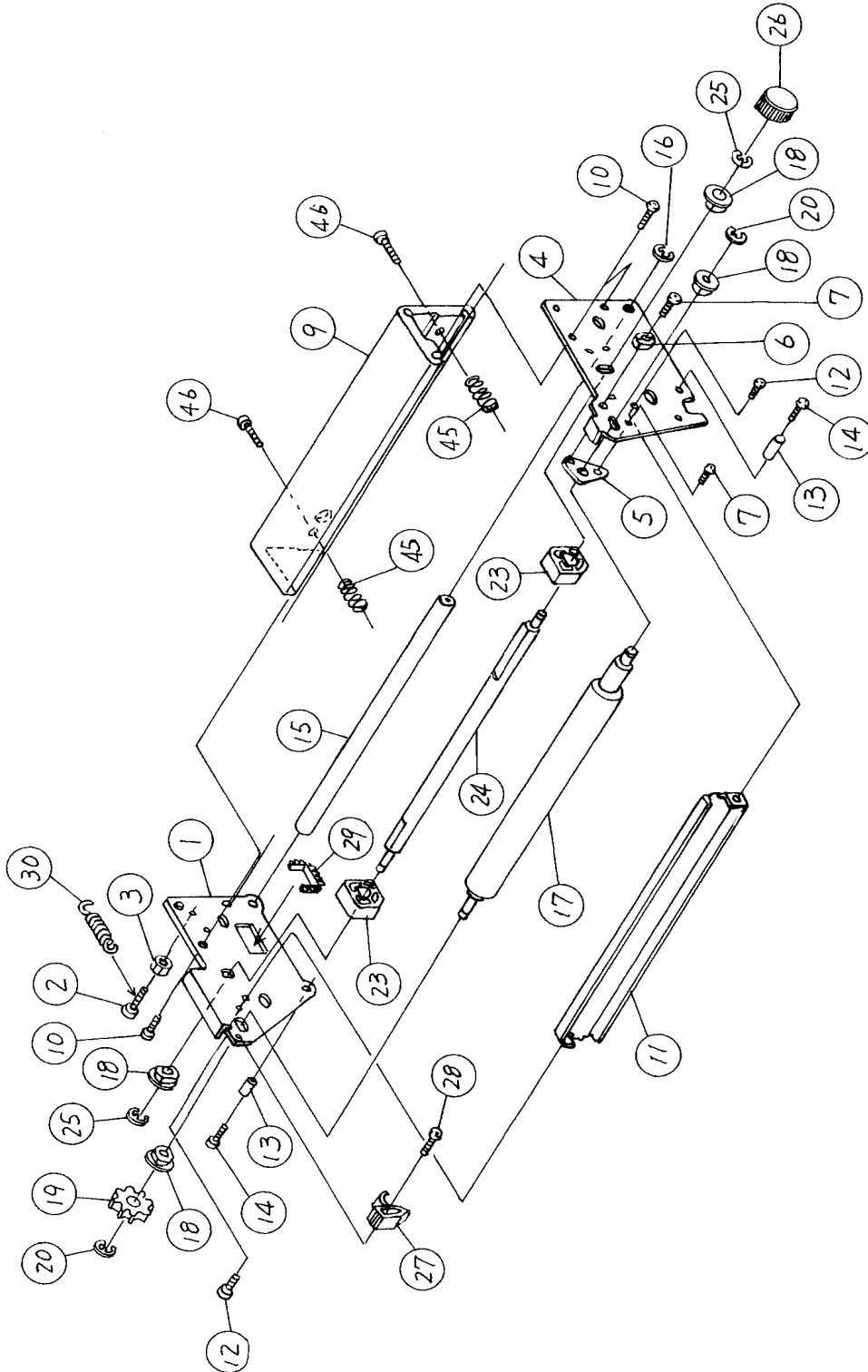

Print Head Assembly

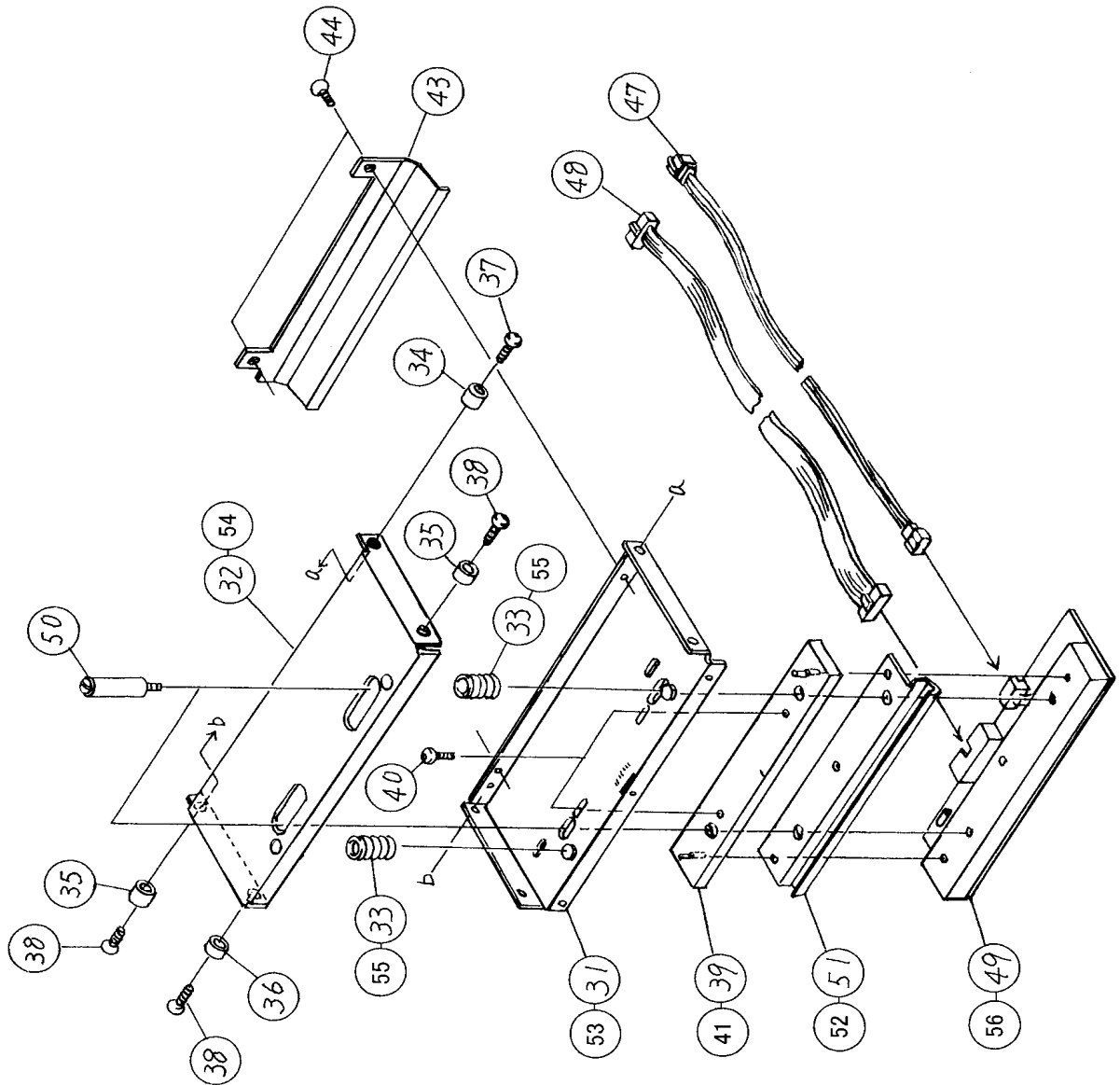

Print Head Assembly

NO.	CODE	DESCRIPTION	QTY
1	PA1721700	Head frame (LH)	1
2	MA0301221	Pan head screw	2
3	MT1300522	Hex nut	2
4	PA1721800	Head frame (RH)	1
5	PA1721200	Plate (adjust C)	1
6	PL2720100	Adjust collar	1
7	MD4300821	Pan head screw	2
9	PD1720400	Stay	1
10	MD3401021	Pan head screw	4
11	PA1721500	Support plate (B)	1
12	MD4300821	Pan head screw	2
13	PB2720100	Collar	2
14	MD3401021	Pan head screw	2
15	PR1720100	Roller	1
16	ND0060030	E-Ring	1
17	PR0720700	Feed roller	1
18	PL2720400	Bush	4
19	PE8720100	Gear	1
20	ND0040030	E-Ring	2
23	PE1720100	Cam (head pressure)	2
24	PB0720600	Shaft (head pressure)	1
25	ND0040030	E-Ring	2
26	PE1720200	Knob	1
27	PE6720500	Protector (B)	1
28	MD4300821	Pan head screw	1
29	PV9720100	Bush	1
30	PC0720100	Spring (open)	1

Print Head Assembly

NO.	CODE	DESCRIPTION	QTY
31	PA1727100	Head Bracket (A) (CL608)	1
32	PA1727200	Head Bracket (B) (CL608)	1
33	PC1720100	Spring (head) (CL608)	2
34	PB2720200	Collar	1
35	PB2720300	Collar	2
36	PB2720400	Collar	1
37	MD4402021	Pan head screw	1
38	MD4401021	Pan head screw	3
39	PR1720200	Head sub holder (CL608)	1
40	MD4300821	Pan head screw	2
41	PR1721400	Head sub holder(CL612)	1
43	PA1721400	Head cable cover	1
44	MD4300621	Pan head screw	2
45	PC1690201	Spring	2
46	MN1301630	Hex hole bolt	2
47	RH1727700	Power & Head Power Cord Set	1
48	RH1775201	Print Head Cable Assy	1
49	GH000661A	Print Head (CL608)	1
50	PB0723400	Post (Head)	2
51	PR4721000	Plate(Ribbon) (CL608)	1
52	PR4721100	Plate(Ribbon) (CL612)	1
53	PA1721900	Head bracket (A) (CL612)	1
54	PA1722000	Head bracket (B) (CL612)	1
55	PC1720400	Spring (head) (CL612)	2
56	GH000511A	Print Head (CL612)	1

10.5 Ribbon Assembly

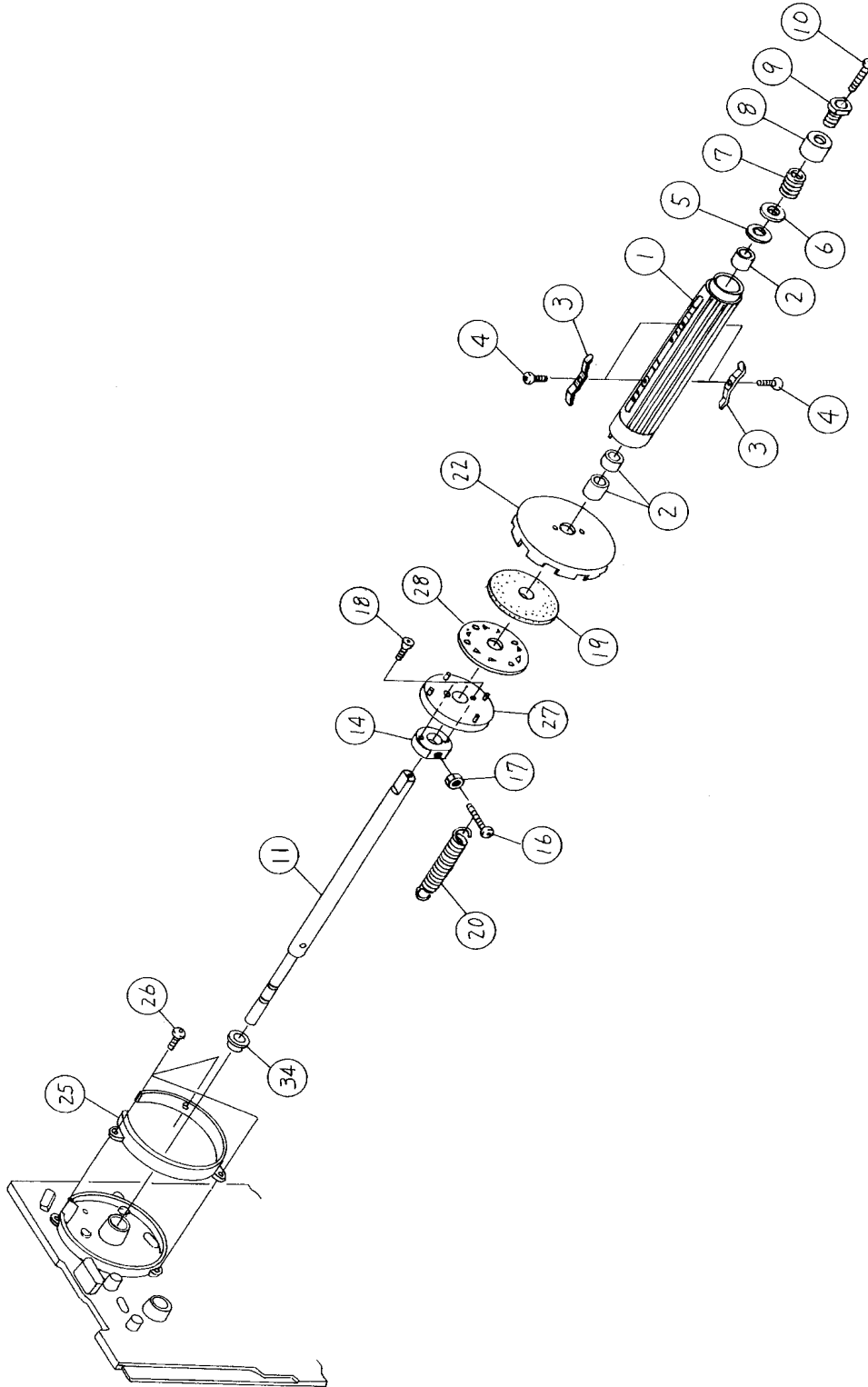

Ribbon Assembly

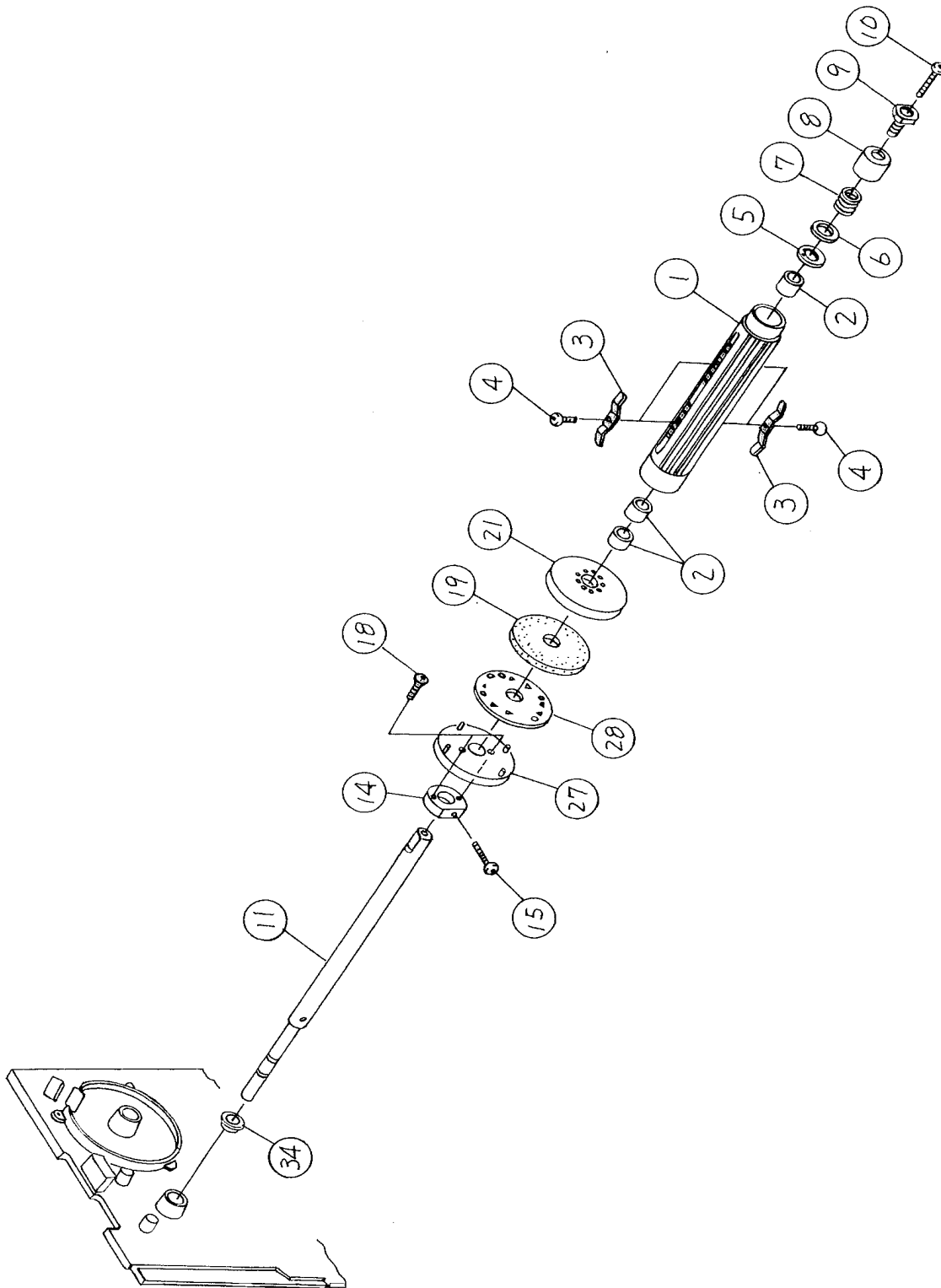

Ribbon Assembly

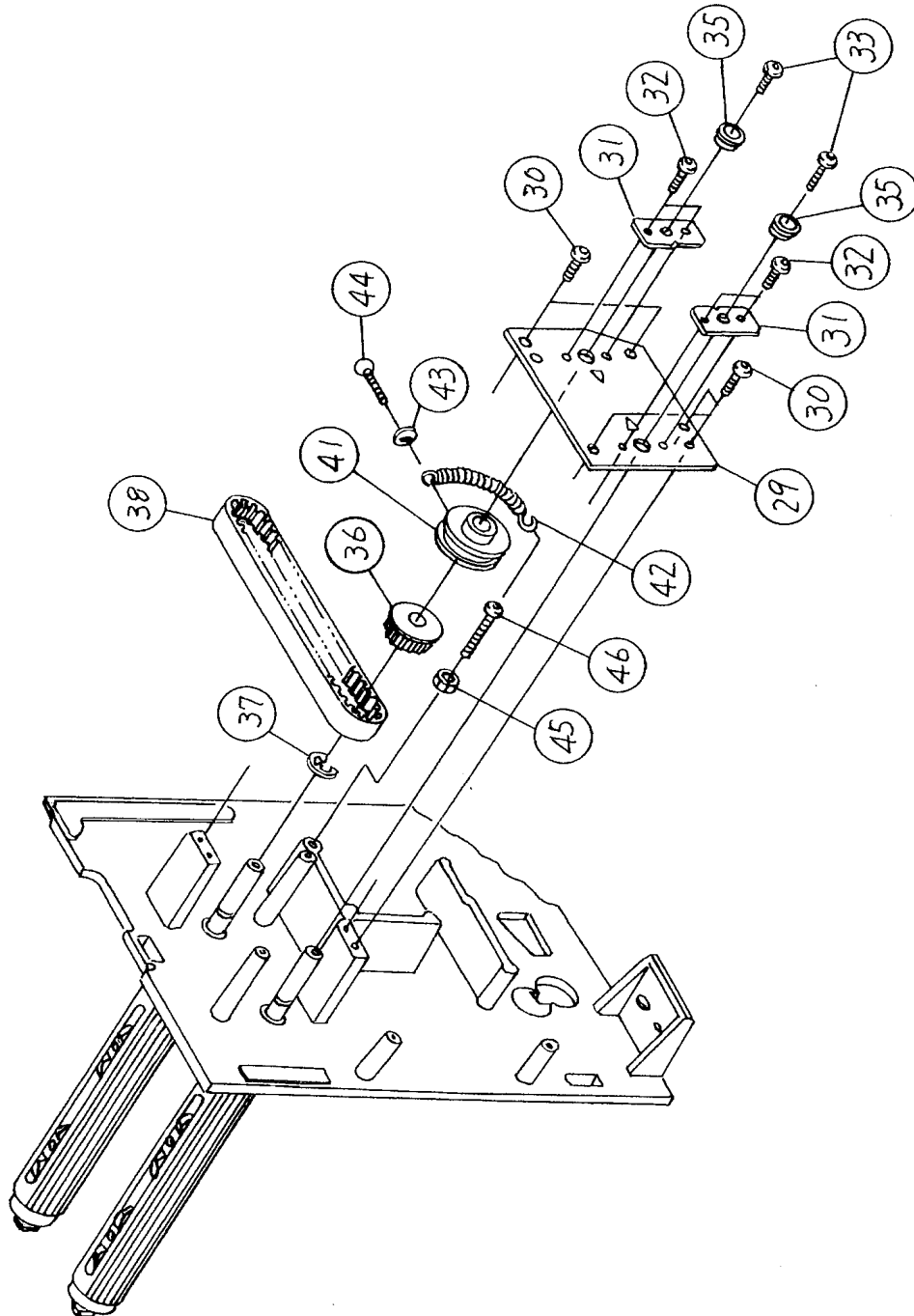

Ribbon Assembly

NO.	CODE	DESCRIPTION	QTY
1	PE4720100	Ribbon boss	2
2	PE2720100	Collor	6
3	PA4690900	Spring	8
4	MH0300521	P tight screw	8
5	PT2301020	Oilless dry metal	2
6	PA0680400	Disc	2
7	PC1730100	Spring	2
8	PE2730100	Stopper collar	2
9	PB5730100	Adjust screw	2
10	MA0303022	Pan head screw	2
11	PB0720400	Shaft (ribbon)	2
14	PE4720200	Plate holder boss	2
15	MA0301821	Pan head screw	1
16	MA0302522	Pan head screw	1
17	MT1300522	Hex nut	1
18	MH1250621	P-tight screw	4
19	PA0680300	Lining	2
20	PC0730100	Spring (back)	1
21	PE1681100	Guide plate (B)	1
22	PE7720100	Disc plate (A)	1
25	PE6720100	Disc plate cover	1
26	MD4300821	Pan head screw	3
27	PA0730100	Guide plate	2
28	PA0730200	Hold plate	2
29	PA1720700	Ribbon frame	1
30	MD4400821	Pan head screw	5
31	PA1731000	Adjust plate	2
32	MD4300621	Pan head screw	4
33	MD4400821	Pan head screw	2
34	PT1114080	Ball supporter	2
35	PT1112080	Ball supporter	2
36	PR1720400	Pulley	1
37	ND0060030	E-Ring	1
38	PT8131064	Timing belt	1

Ribbon Assembly

NO.	CODE	DESCRIPTION	QTY
41	PR1770100	Pulley	1
42	PC0760500	Spring (ribbon)	1
43	NA1030022	Plain washer	1
44	MH0300821	P tight screw	1
45	MT1400722	Hex nut	1
46	MD3401221	Pan head screw	1

Feed Roller Assembly

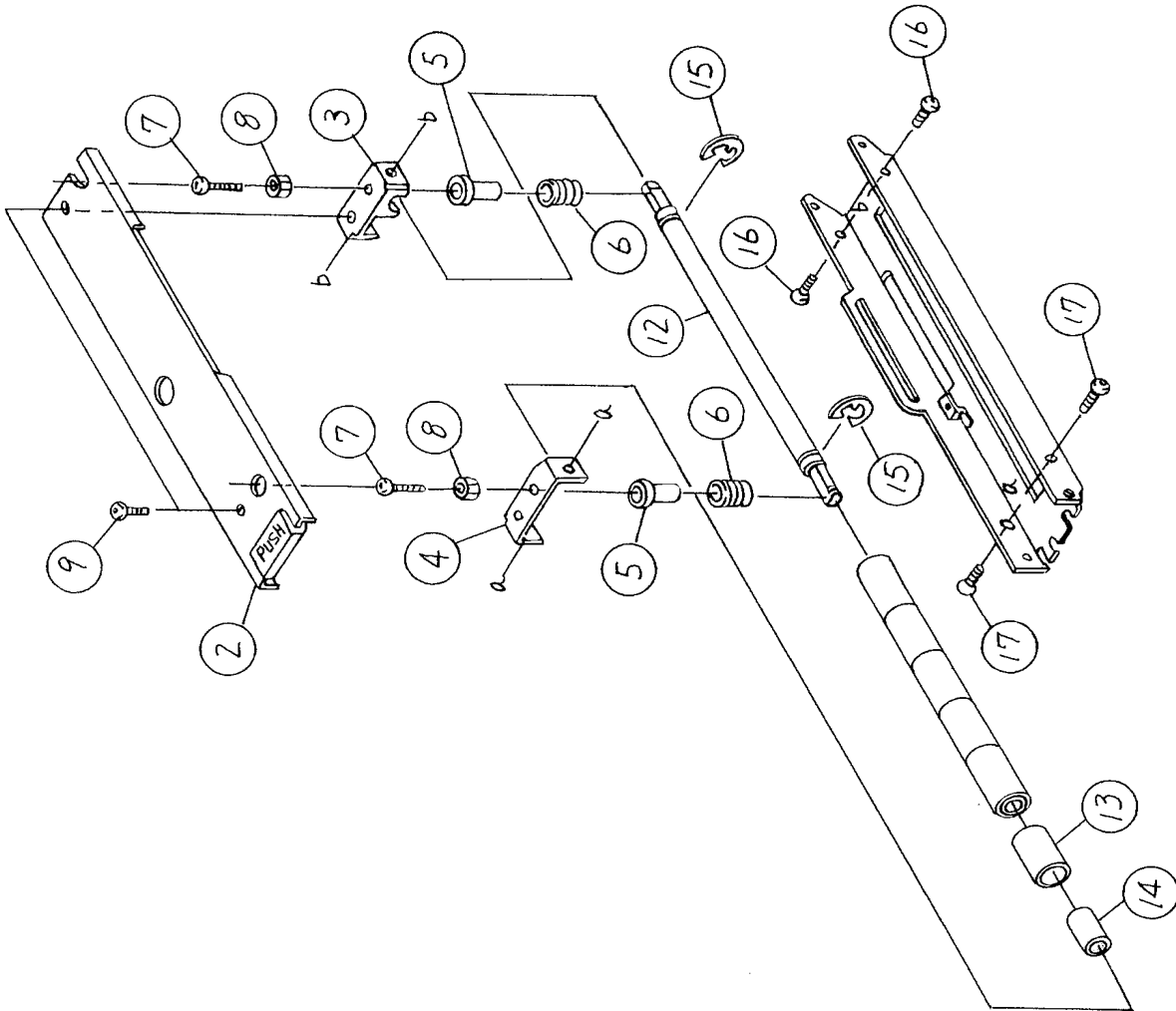

Feed Roller Assembly

NO.	CODE	DESCRIPTION	QTY
1	PR3720500	Paper lid	1
2	PR4721300	Paper lid cover	1
3	PA1720400	Roller bracket (A)	1
4	PA1720500	Roller bracket (B)	1
5	PE2730300	Stopper collar	2
6	PC1720601	Spring (pressure)	2
7	MA0301221	Pan head screw)	2
8	MT1300522	Hex nut)	2
9	MD4300821	Pan head screw)	2
12	PB0720500	Shaft (pressure)	1
13	PE3720200	Roller	6
14	PE3720500	Roller	6
15	ND0040030	E-Ring	2
16	MD4300821	Pan head screw	2
17	MA7300625	Truss screw	2
20	PV3720100	PCB bracket (A)	1
21	PA1729400	PCB Bracket (D)	1
22	MA0300622	Pan head screw	2
23	PB2720800	Collar	1
24	MJ9300622	Thin head screw	1
25	MD4300821	Pan head screw)	1
26	PA1720300	Lid bracket	1
27	PC2740200	Spring (open)	1
28	PA3742100	Latch handle	1
29	PC2740300	Spring (latch)	1
31	PB0741100	Shaft (lid)	2
32	ND0020030	E-Ring	4
33	MD4401621	Pan head screw	1
36	RH1724300	Pitch sensor cord(SEN2)	1

10.7 Main PCB Assembly

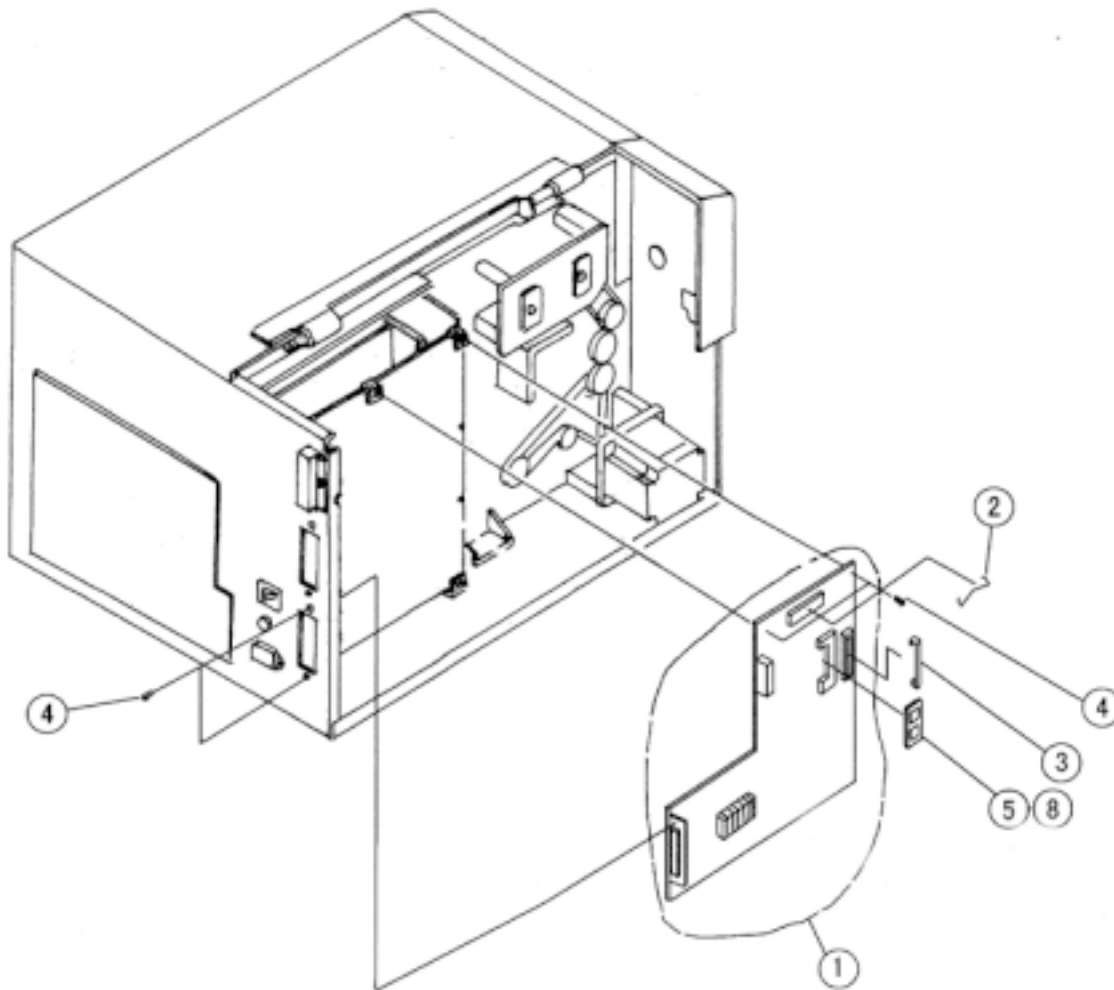

NO.	CODE	DESCRIPTION	QTY
1	RJ1771200	Main PCBA	1
2	PC9730100	Spring (Lock)	1
3	PA3739900	Connector lock	1
4	MD4300621	Pan head screw	5
5	RJ7770200	Memory PCB Assy-B	1
8	RJ7770300	Memory PCB (4 MB Memory Option)	1

10.8 Interface Option

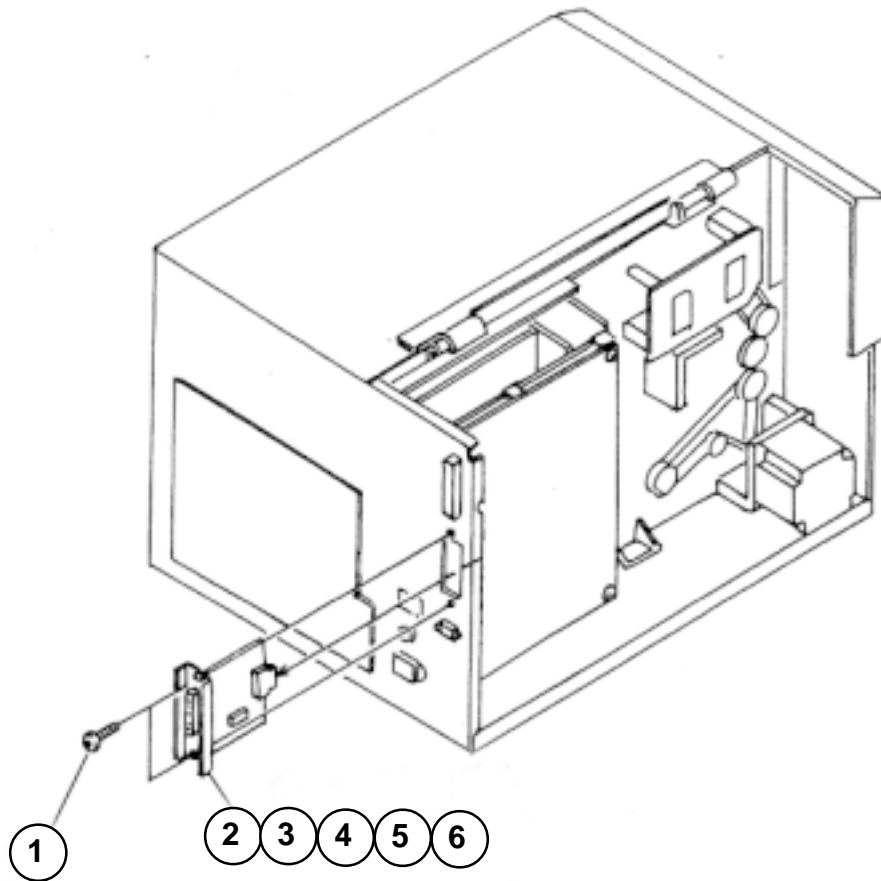

NO.	CODE	DESCRIPTION	QTY
1	MD3300622	Screw	2
2	WCL404070	IEEE-1284 Parallel Interface	1
3	WCL404051	Serial Interface	1
4	WCL404060	USB Interface	1
5	11S000158	Ethernet Interface	1
6	11S000136	CX/TX Interface	1

10.9 Dispenser Assembly Option

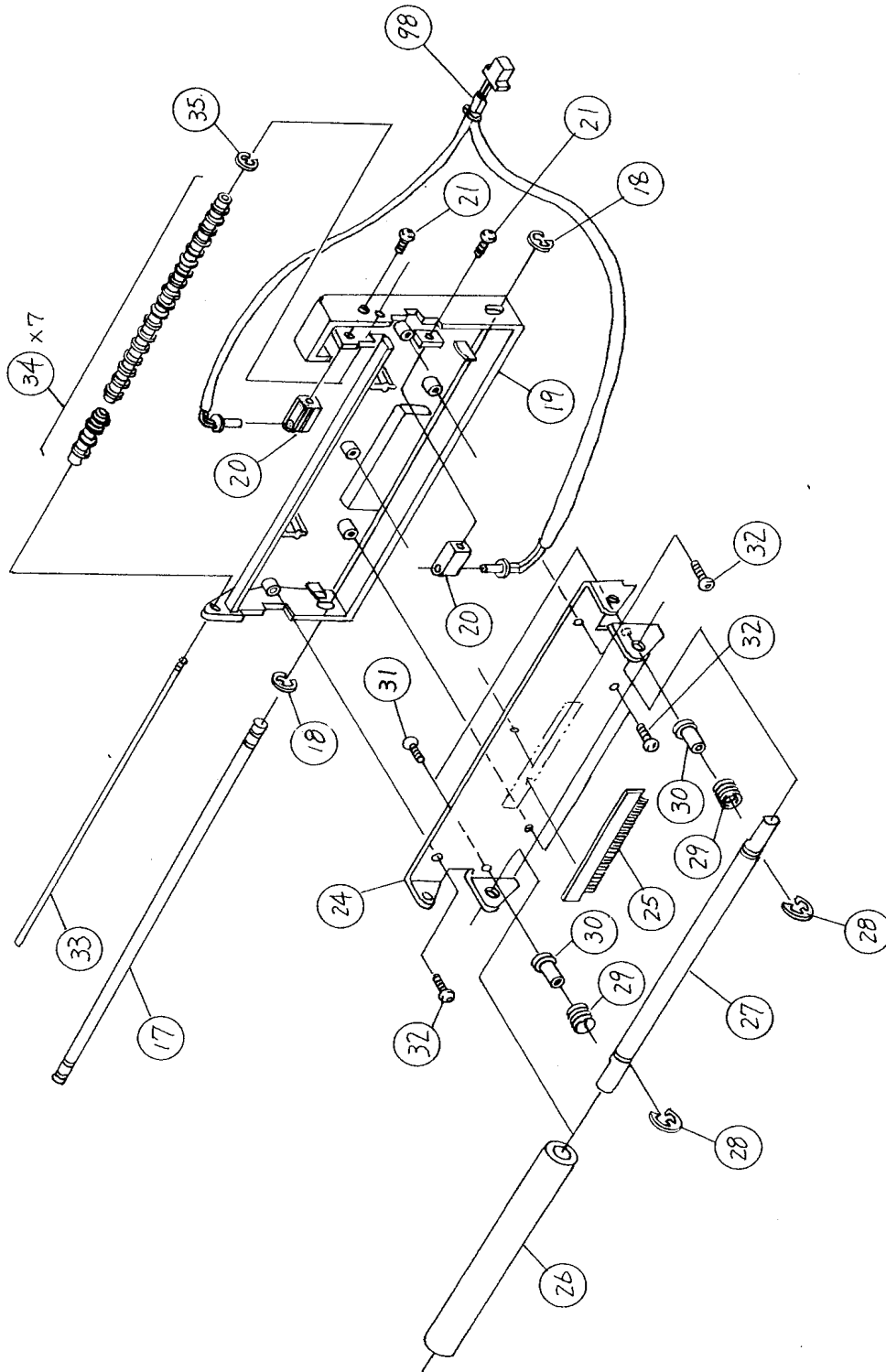

Dispenser Assembly Option

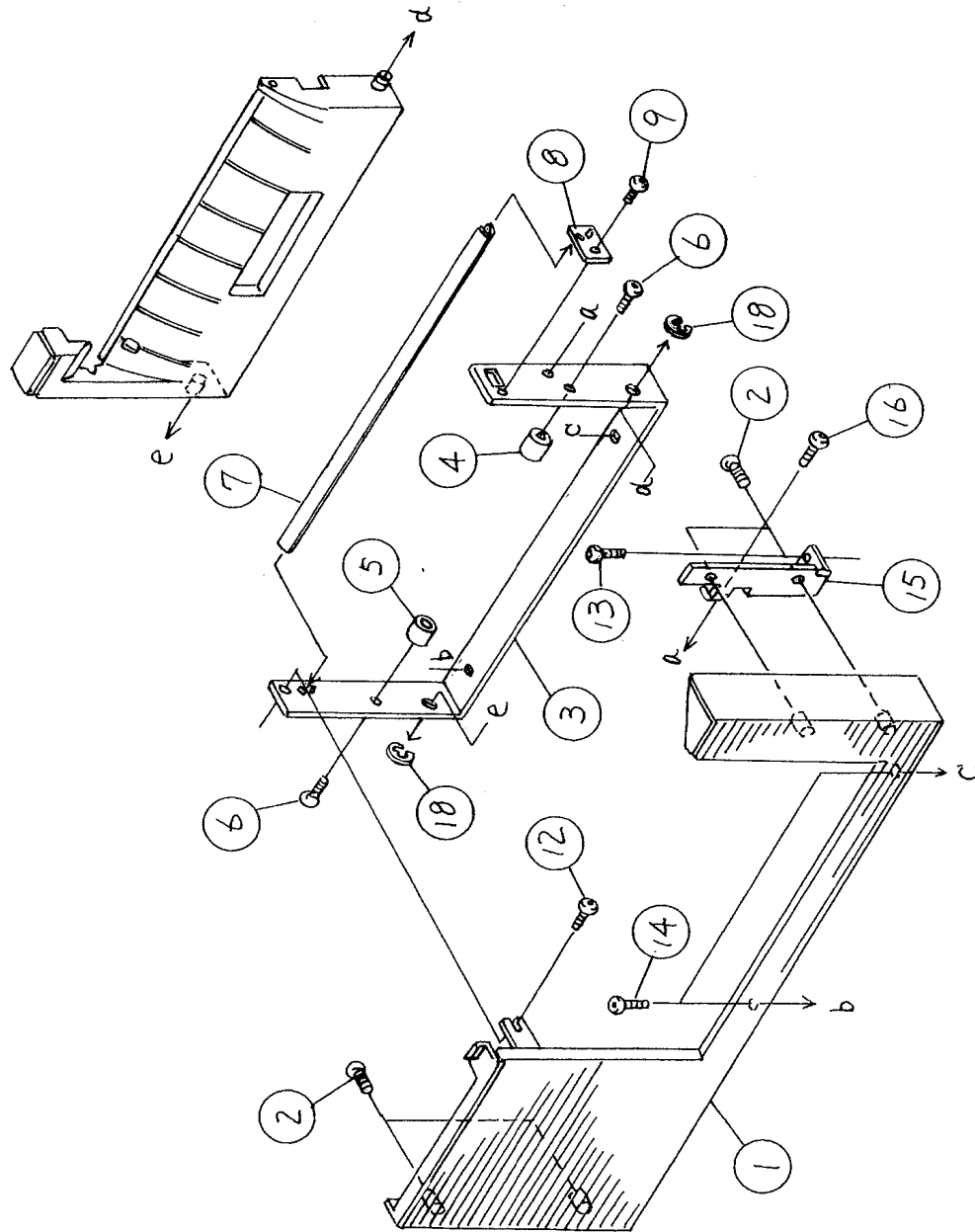

Dispenser Assembly Option

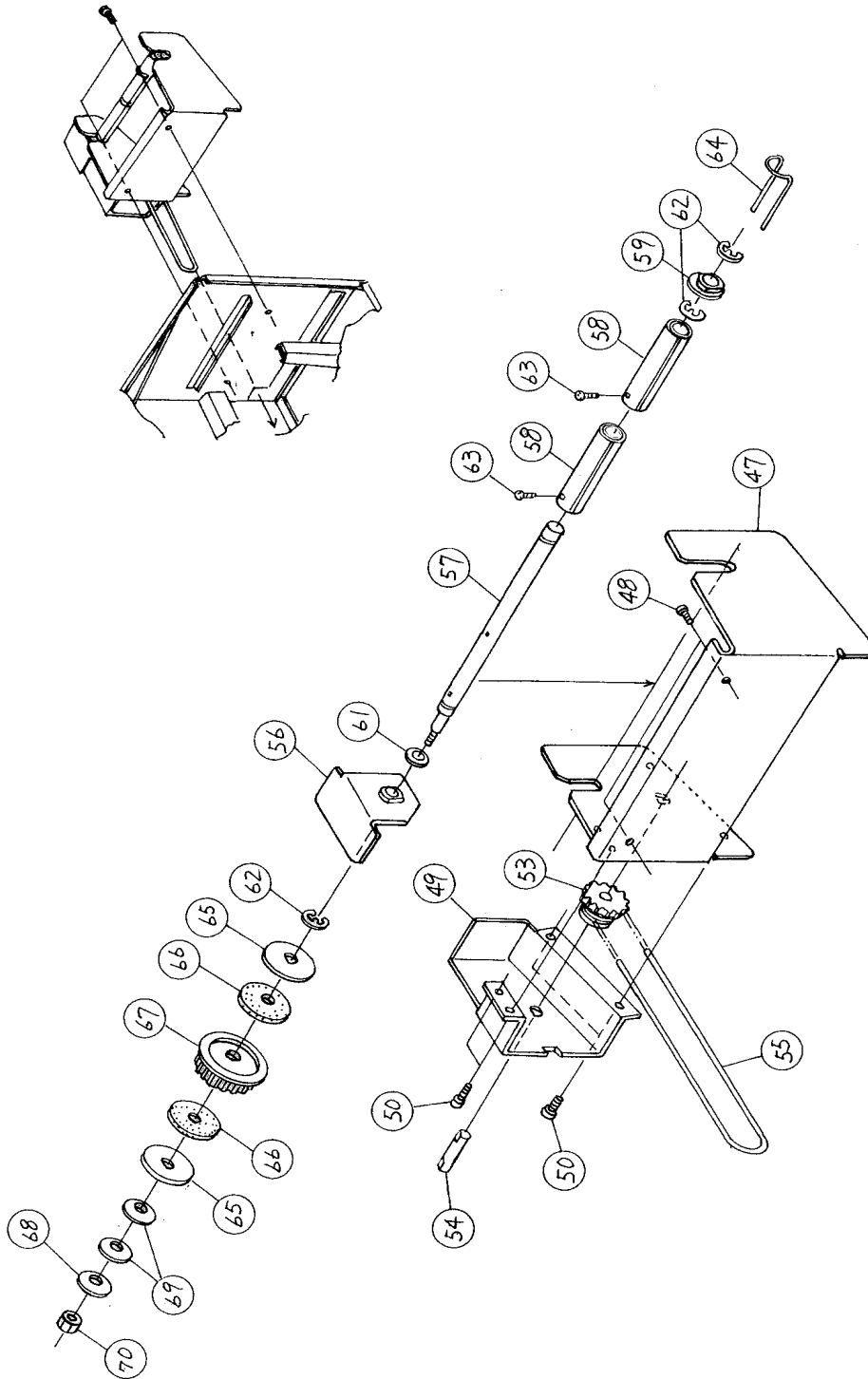

Dispenser Assembly Option

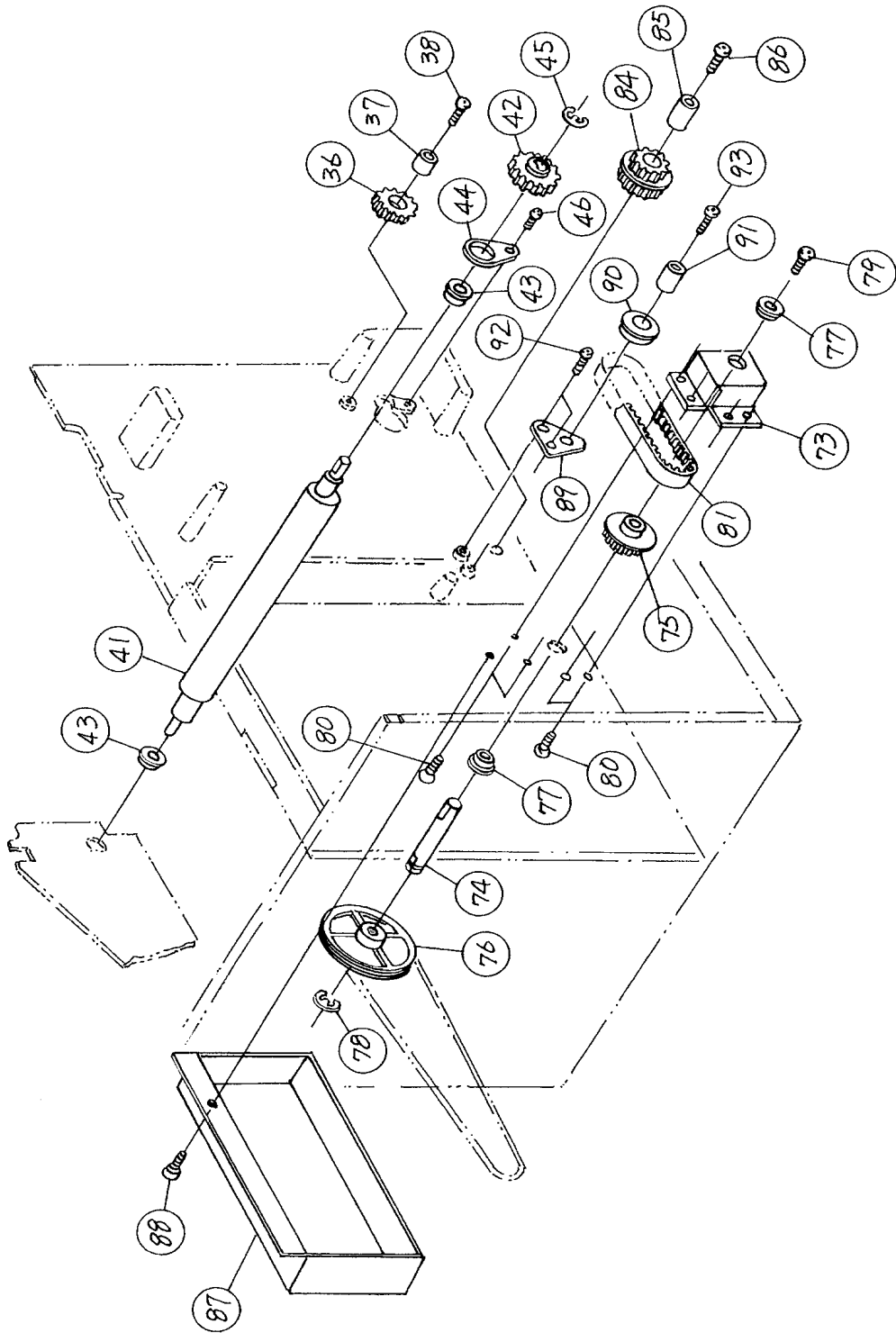

Dispenser Assembly Option

NO.	CODE	DESCRIPTION	QTY
1	PH0720400	Dispense cover	1
2	MH0300821	P tight screw	4
3	PA1724701	Dispense frame	1
4	PB0721600	Post (latch) RH	1
5	PB0721700	Post (latch) LH	1
6	MD4300621	Pan head screw	2
7	PA1724600	Dispense bar	1
8	PA1724500	Adjust plate	1
9	MD4300621	Pan head screw	1
12	MD4301021	Pan head screw	1
13	MD4300821	Pan head screw	1
14	MA7300625	Truss screw	2
15	PA1724800	Dispense cover bracket	1
16	MD4300621	Pan head screw	1
17	PB0721400	Shaft (Guide)	1
18	ND0030030	E-Ring	4
19	PE1720400	Dispense bracket	1
20	PE1570300	Dispense sensor bracket	2
21	MH0250621	P-tight screw	2
24	PA1724400	Roller bracket	1
25	PR1340500	Brush	1
26	PR1520200	Pressure roller sub assy	1
27	PB0721200	Shaft (Pressure roller)	1
28	ND0040030	E-Ring	2
29	PC1010200	Head spring	2
30	PE2730300	Stopper collar	2

Dispenser Assembly Option

NO.	CODE	DESCRIPTION	QTY
31	MD4300821	Pan head screw	2
32	MH0300821	P tight screw	5
33	PB0721300	Shaft (Dispense roller)	1
34	PE3520600	Dispense roller	7
35	ND0020030	E-Ring	1
36	PE8720800	Gear	1
37	PB2720100	Collar	1
38	MD4401421	Pan head screw	1
41	PR0720300	Feed roller	1
42	PE8720700	Gear	1
43	PT1112060	Ball supporter	2
44	PA1680200	Ball supporter clamp	1
45	ND0040030	E-Ring	1
46	MD4300821	Pan head screw	1
47	PA1725200	Rewind frame	1
48	MD4300821	Pan head screw	2
49	PA1725100	Side frame	1
50	MD4300621	Pan head screw	4
53	PE8721000	Gear pulley	1
54	PB0721800	Shaft (Idle gear)	1
55	PR4720600	Rewind belt	1
56	PR1720700	Rewind handle	1
57	PB0721900	Shaft (rewind)	1
58	PB4720100	Rewind core	2
59	PL2720200	Bush	1

Dispenser Assembly Option

NO.	CODE	DESCRIPTION	QTY
61	NA0060022	Plain washer	2
62	ND0040030	E-Ring	3
63	MD4301221	Pan head screw	2
64	PC3720100	Rewind knob	1
65	PA1724900	Flange	2
66	PJ4720100	Facing	2
67	PE8721100	Gear	1
68	PB9720100	Adjust nut	1
69	NB5100030	Spring	2
70	MT1400722	Hex nut	1
73	PA1725300	Idle shaft bracket	1
74	PB0722000	Shaft (Idle gear)	1
75	PE8721200	Pulley	1
76	PE8520500	Rewind pulley	1
77	PT1112060	Ball supporter	2
78	ND0040030	E-Ring	1
79	MD4300621	Pan head screw	1
80	MD4300621	Pan head screw	4
81	PT8095064	Timing belt	1
84	PE8720900	Gear pulley	1
85	PB2720200	Collar	1
86	MD4402221	Pan head screw	1
87	PA1725400	Belt cover	1
88	MD4300621	Pan head screw	1
89	PA1723100	Tension bracket (A)	1
90	PE3720100	Tension roller	1
91	PB2720600	Collar	1
92	MD4300821	Pan head screw	2
93	MD4401421	Pan head screw	1
98	RH1721100	Dispense sensor cord	1

10.10 Cutter Assembly Option

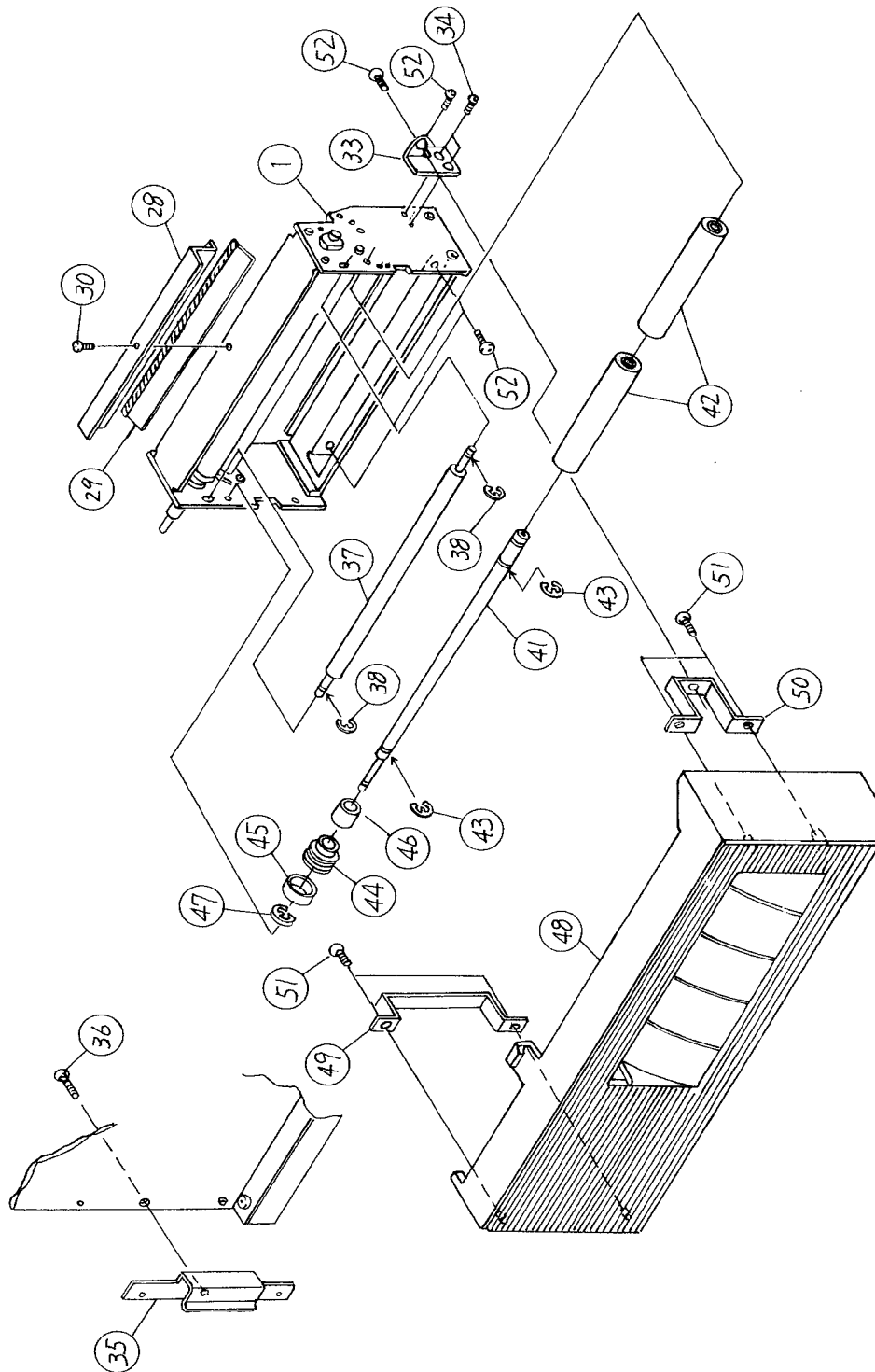

Cutter Assembly Option

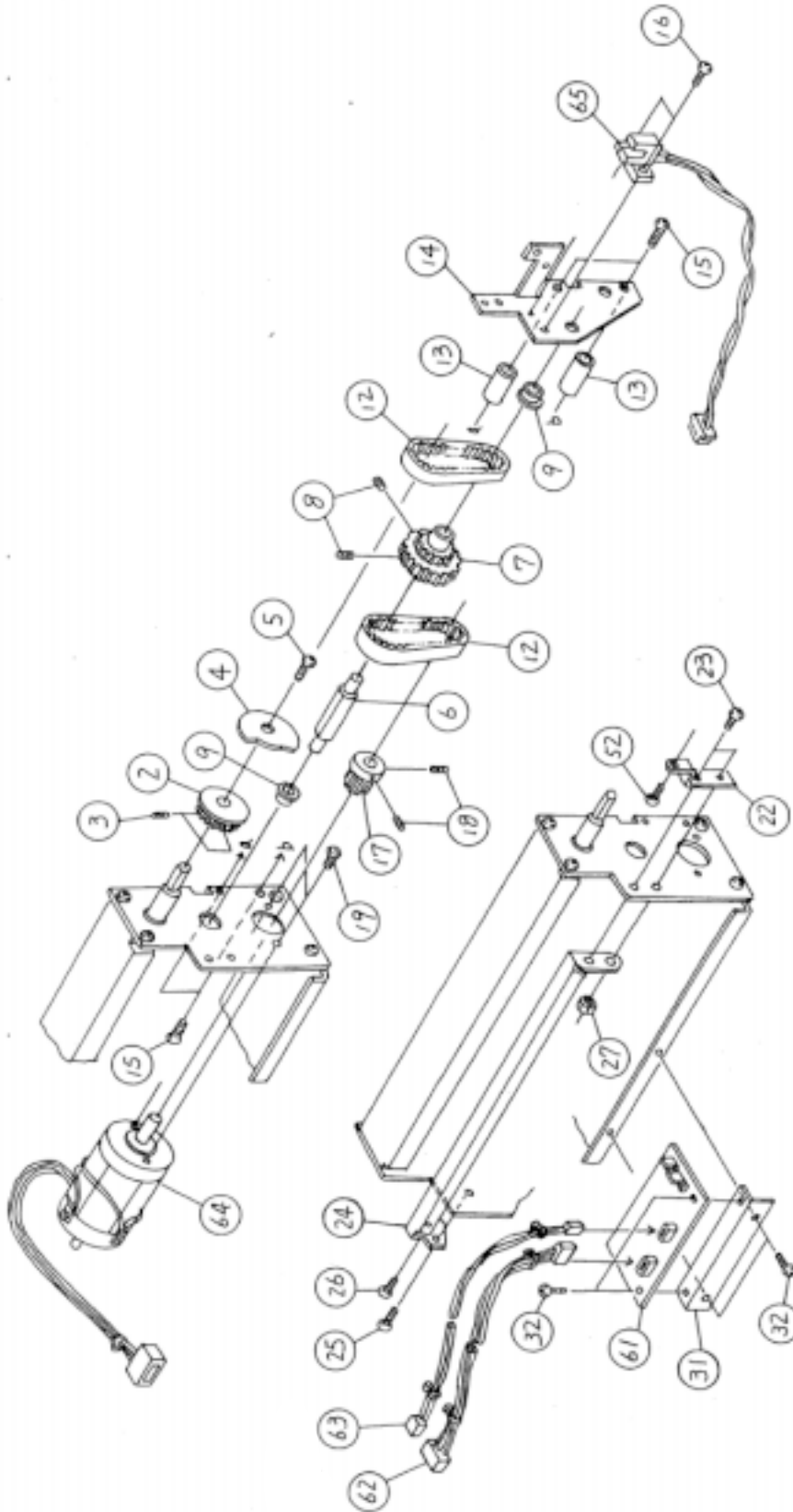

Cutter Assembly Option

NO.	CODE	DESCRIPTION	QTY
1	PR1720800	Cutter set	1
2	PR1691401	Cutter pulley	1
3	MJ1300424	W-point screw	2
4	PA1725500	Sensor slit	1
5	MD4300621	Pan head screw	1
6	PB0722200	Shaft (Idle gear)	1
7	PL1720700	Pulley	1
8	MJ1300424	W-point screw	2
9	PT1107030	Ball supporter	2
12	PU3112060	Timing belt	2
13	PB0722100	Post (Idle gear)	2
14	PA1725600	Sensor bracket	1
15	MD4300821	Pan head screw	4
16	MD3300621	Pan head screw	2
17	PL1720300	Motor pulley	1
18	MJ1300424	W-point screw	2
19	MD4300821	Pan head screw	2
22	PA1725700	Cover bracket (A)	1
23	MD4301021	Pan head screw	2
24	PA1728500	Cutter protect (B)	1
25	MD4300621	Pan head screw	1
26	MD3401021	Pan head screw	1
27	MT1300521	Hex nut	2
28	PA1726200	Cutter protect (A)	1
29	PA6720200	Cutter plate	1
30	MD3300621	Pan head screw	1

Cutter Assembly Option

NO.	CODE	DESCRIPTION	QTY
31	PA1726000	PCB bracket	1
32	MD3300621	Pan head screw	4
33	PA2720700	Cover Bracket (E)	1
34	MD4300621	Pan head screw	2
35	PA2720500	Cover BR(E)	1
36	MD4301021	Pan head screw	1
37	PB0722300	Feed roller (Cutter)	1
38	ND0020030	E-Ring	2
41	PB0722400	Shaft (Feed roller)	1
42	PR1720900	Roller (Cutter)	2
43	ND0050030	E-Ring	2
44	PE8721400	Pulley	1
45	PV9720700	Rubber-Ring	1
46	PB2720700	Collar	1
47	ND0020030	E-Ring	1
48	PR1721000	Cover (Cutter)	1
49	PA2720400	Cover Bracket (D)	1
50	PA2720800	Cover Bracket (G)	1
51	MH0300821	P tight screw	4
52	MD4301021	Pan head screw	5
61	RJ1723500	Cutter PCB set	1
62	RH1727501	CutterPower Cord Set	1
63	RH1727800	Cutter Cable Set	1
64	RH1722200	Cutter Motor with cord	1
65	RH1722300	Cutter sensor cord	1

10.11 PCMCIA Memory Option

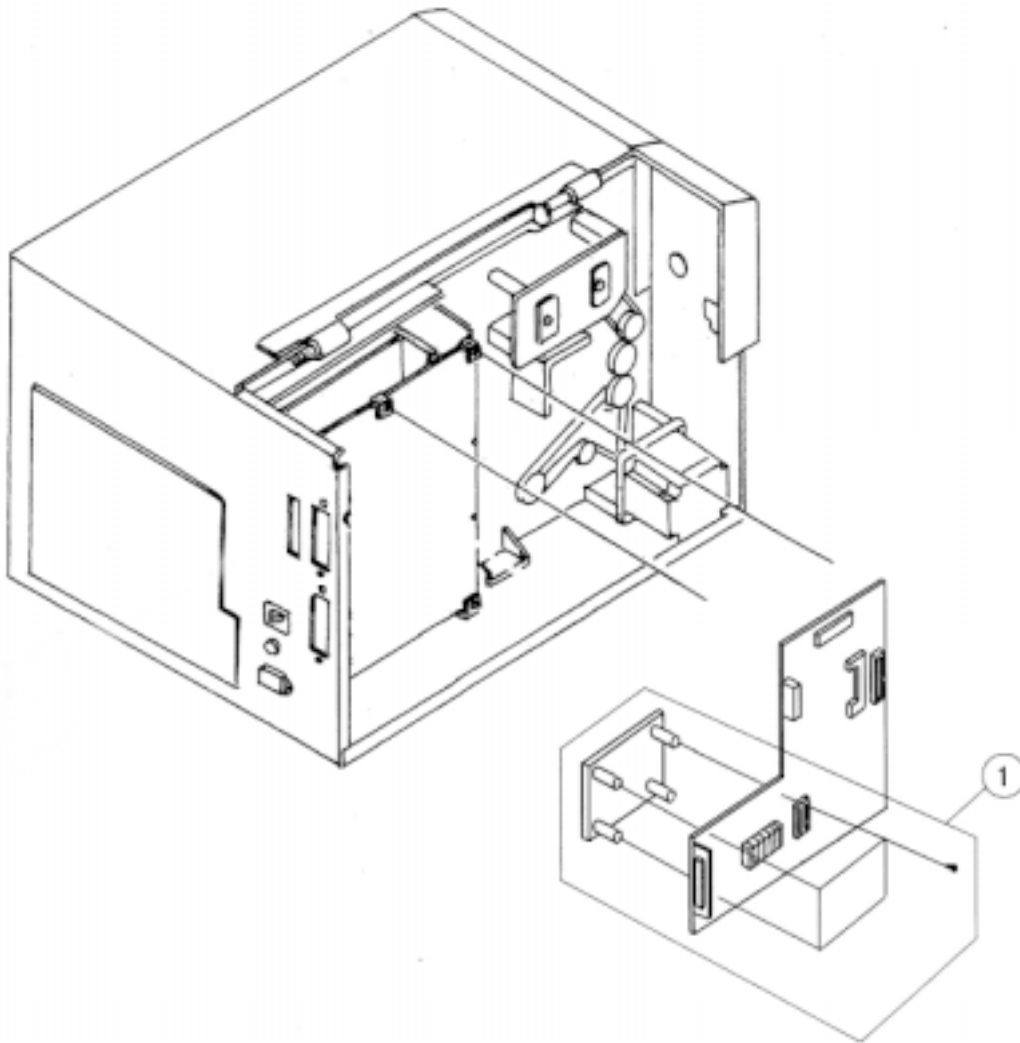

NO.	CODE	DESCRIPTION	QTY
1	RJ4770100	PCMCIA Memory Option	1

NOTE: PCMCIA Memory Card not included with the option.



Index

A

AC Fuse 1-3
 AC Power Input Connector 1-3
 Access Door 1-2, 1-4, 4-2
 Accessory (EXT) Connector 3-11
 Adjust Plate 5-7, 5-10
 Adjustment Spring 5-11
 Advisory LED'S 1-5
 All Clear Mode 2-36
 AutoOnline 2-13

B

Back-Feed Selection 2-5
 Backfeed Sequence Selection 2-4
 Bar Codes 1-15
 Base Cover Assembly 10-2
 Baud Rate Selection 2-2
 Bi-Directional Communications 3-10

C

Cable Requirements RS232 Serial Interface 3-7
 Calendar 2-15
 Calendar 9-24
 Cancel Print Job 2-12
 Card Format 2-24
 Centronics Parallel Interface 3-2
 Character Fonts 1-14
 Character Pitch 2-16
 Checking the Network Connect & Cabling 8-5
 Clear Cutter Counter 7-5
 Clear Dispenser Counter 7-4
 Clear EEPROM 7-6
 Clear Head Counters 7-3
 Components 1-7
 Configuration 2-1
 Counters HD DSP CUT LIFE 2-32
 Cover Plate 1-3
 Cover 1-5
 Cutter Assembly Option 10-39
 Cutter Unit 9-4

D

Data Streams RS232C Serial Interface 3-9
 DC Power Voltage Checks 4-3
 Default Setting Mode 2-34
 Differences CL608e and CL612e 1-1
 Dip Switch Settings 2-1
 Disk Plate 6-26
 Dispenser Assembly Option 10-32
 Dispenser Cover 6-38
 Dispenser Unit 9-6
 Display Panel Assembly 6-38
 Download User Defined Protocol Codes 2-37

E

Electrical Checks and Adjustments 4-1
 Electrical Specifications, Ethernet Interface 3-10
 Electrical Specifications, IEEE1284 Parallel Interface 3-4
 Electrical Specifications, RS232C Serial Interface 3-6
 Environment & Approvals 1-11
 Error LED 1-5
 Error Signals 3-13, 8-10
 Euro Code 2-30
 Ethernet Interface 3-2
 Exit Advanced Mode 2-16
 EXT Connector 1-3
 EXT Print Start Signal Selection 2-5
 External Accessory Connector 1-3
 External Signal Interface 2-5
 External Signal Type Selection 2-6
 Eye-Mark Adjustment 4-11
 Eye-Mark Sensors 1-9, 6-30

F

Factory Reset Procedure 9-23
 Factory Resets 7-1
 Factory Settings/Test Print 7-2
 Feed Key 1-5
 Feed Roller Adjustment (Label Tracking) 5-9
 Feed Roller Assembly 10-27
 Firmware Download 2-4
 Flash Memory Expansion Installation 9-19
 Flash Memory Module 6-6, 9-20
 Frame Assembly 10-11
 Fuses 6-8

G

General Printer Specifications 1-11
 General Specifications, Ethernet Interface 3-10
 General Specifications, RS232C Serial Interface 3-6
 General Specifications, USB Interface 3-10

H

Head Check Selection 2-3
 Head Latch Adjustment 5-12
 Head Latch Lever 1-8, 6-17
 Head Latch 1-4
 Head Pattern Examples 8-15
 Hex Dump Diagnostic Labels 8-17
 Hex Dump Mode 8-17, 2-38
 High level ("Eye-Mark" part) adjustment 4-11
 High level (paper part) adjustment 4-11

I

IEEE 1284 Parallel Interface 3-4, 8-2
Indexing Notch 6-5
Interface Board 4-3
Interface Card 6-3
Interface Option 10-31
Interface Slot 1-3
Interface Specifications 3-1
Interface Types 3-1
Intermittent Problems 8-6

K

KB Board 1-7

L

Label Cutter Kit Installation 9-2
Label Dispenser Installation 9-6
Label Gap Adjustment 4-10
Label Out Sensor 1-9
Label Sensor Selection 2-5
Label Supply Guide 1-4
Label Tear Off Plate 1-4
Lan Ethernet Interface Installation Problems 8-5
Lan Ethernet Interface 8-5
LCD Board 1-7
LCD Display Adjustment 4-15
LCD Display 1-5
LCD Panel, Counters Mode 2-32
LCD Panel, Download User Defined Protocol 2-37
LCD Panel, Firmware Download Mode 2-39
LCD Panel, Normal Mode 2-9
LCD Panel, Card Mode 2-17
LCD Panel Configuration 2-8
LCD Panel, Clear Non-Standard Protocol 2-37
LCD Panel, Maintenance Mode 2-35
LCD Panel, Test Print Mode 2-33
LCD Screen 1-5
Line Key 1-5
Low level adjustment 4-11

M

Main PC Board 6-8
Main PCB Assembly 10-30
Main PCB Board 4-3, 9-17
Main PCB Memory Frame 6-5, 9-19
Mechanical Adjustments 5-1
Media Hold Down Cover 6-30
Media Hold Down Unit 6-35
Media Hold Down 1-9
Media Knob 1-4
Memory Card Slot 1-3
Memory Module PCB 6-5
Multi Job Buffer 3-3

N

NetWare Troubleshooting 8-7
Notch/Gap and Eye-Mark Sensors 6-34
Notch/Gap Sensor 1-9, 6-30, 6-35
Notch/Gap Sensor Adjustment 5-13

O

Offset Label Stop Position Adjustment 4-12
Online LED 1-5
Operation Panel/Displays 1-5
Optional Accessories 1-10, 9-1

P

Paper End Switch 6-30, 6-33
Parity Selection 2-2
PCB Harness 6-28
PCMCIA Memory Expansion Installation 9-15
PCMCIA Memory Expansion Slot 1-3
PCMCIA Memory Option 10-43
Physical Characteristics 1-2
Pin Assignments, Accessory (EXT) Connector 3-11
Pin Assignments, IEEE1284 Cable End 3-5
Pin Assignments, RS232C Printer End 3-6
Pitch Offset Adjustment 2-10
Platen Roller 1-4
Platen 1-7, 6-17
Plug In Interface Card 1-8
Potentiometer Assignments & Adjustments 4-6
Potentiometers 1-6
Power LED 1-5
Power Supply 1-8, 4-1, 4-3, 6-9
Power Switch 1-3
Print Darkness Adjustment 4-16
Print Darkness Setting 2-9
Print Head Assembly 1-4, 10-18
Print Head Balance Adjustment 5-7
Print Head Position Adjustment 5-5
Print Head 1-7, 6-16
Print Offset 2-14
Print Position Adjustment 4-8
Print Quality Problems 8-11
Print Speed Adjustment 2-10
Printer Features 1-3
Printer Set up 2-3
Priority Setting LCD Command 2-31
Protocol Code Selection 2-4
Protocol Selection 2-2

R

Ramp Frame 6-32
Ramp Plate 6-32
Ready/Busy Flow Control 3-8

- Rear Panel 1-3
 - Receive Buffer Hex Dump 8-17
 - Receive Buffer Selection 2-3
 - Receive Buffer 3-3
 - Repeat Print 3-13
 - Replacing Notch/Gap and Eye-Mark Sensors 6-30
 - Replacing the Display Panel 6-37
 - Replacing the Fuses 6-7
 - Replacing the Keyboard 6-37
 - Replacing the Main Circuit Board 6-2
 - Replacing the Paper End Switch 6-30
 - Replacing the Platen 6-19
 - Replacing the Power Supply 6-9
 - Replacing the Print Head 6-16
 - Replacing the Ribbon Drive Clutch Washers 6-23
 - Replacing the Ribbon Motion Sensor 6-27
 - Replacing the Stepper Motor 6-12
 - Replacing the Timing Belts 6-13
 - Replacing the Top Half of the Notch/Gap Sensor 6-34
 - Reprint W/Feed 2-28
 - Resetting the Print Server 8-9
 - Rewind Clutch 5-3
 - Rewind Drive Spindle 6-24
 - Rewind Spindle 6-15
 - Rewinder Assembly 9-7
 - Ribbon Assembly 10-22
 - Ribbon Boss 6-26
 - Ribbon Clutch Adjustments 5-2
 - Ribbon Core 5-3
 - Ribbon Guide Plate 1-7, 6-17
 - Ribbon LED 1-5
 - Ribbon Motion Sensor 6-29
 - Ribbon Rewind Clutch Adjustment 5-4
 - Ribbon Rewind Spindle 1-4, 5-3, 6-24
 - Ribbon Roller Adjustment 5-8
 - Ribbon Sensor Adjustment 4-14
 - Ribbon Sensor Verification 4-13
 - Ribbon Sensor 1-8
 - ribbon supply spindle 1-4
 - Ribbon Unwind Clutch Adjustment 5-2
 - Ribbon Unwind Spindle 5-3, 1-4
 - Ribbon 1-10
 - RS232 Transmit/Receive Setting 2-2
 - RS232C (Serial) Interface 8-4
 - RS232C Interface Signals 3-8
 - RS232C Serial Interface 3-2
- S**
- Sample Test Labels 2-40
 - Sample Test Prints 7-7
 - Select Language 2-30
 - Sensor Locations 6-30
 - Sensor Type Selection 2-3
 - Sensors and Switches 1-8
 - Set Calendar 2-14, 9-24
 - Single Job Buffer 3-3
 - Software Default Settings 2-7
 - Spare Parts List 10-1
 - Standard Operation 3-12
 - Stay 5-6
 - Stepper Motor 1-7
 - Stop Bit Selection 2-2
 - Switch Selections 2-7
 - Switches and Sensors 1-4
- T**
- TCP/IP Troubleshooting 8-6
 - Test Point Chart 4-5
 - Test Print Mode 2-33
 - Test Print Mode Configuration 2-33
 - Test Print Size 2-34
 - Test Print 5-6
 - Timing Belt Tension Adjustment 5-11
 - Timing Belt 1-7
 - TP Test Module 4-4, 4-5
 - Troubleshooting Check List 8-2
 - Troubleshooting Tables 8-11
 - Troubleshooting 8-1
- U**
- Universal Serial Bus (USB) Interface 3-9, 8-4
 - Unwind Clutch 5-3
 - Unwind Drive Spindle 6-24, 5-3
 - USB Interface 3-2
- V**
- VR1 (Print) 1-6
 - VR2 (Offset) 1-6
 - VR3 (Pitch) 1-6
 - VR4 (Display) 1-6
- W**
- Washer, Oil-less 6-26
 - Windows 95/98 Peer-to-Peer Troubleshooting 8-9
 - Windows NT/LAN Server Troubleshooting 8-8
- X**
- X-On/X-Off Flow Control 3-9

Free Manuals Download Website

<http://myh66.com>

<http://usermanuals.us>

<http://www.somanuals.com>

<http://www.4manuals.cc>

<http://www.manual-lib.com>

<http://www.404manual.com>

<http://www.luxmanual.com>

<http://aubethermostatmanual.com>

Golf course search by state

<http://golfingnear.com>

Email search by domain

<http://emailbydomain.com>

Auto manuals search

<http://auto.somanuals.com>

TV manuals search

<http://tv.somanuals.com>