

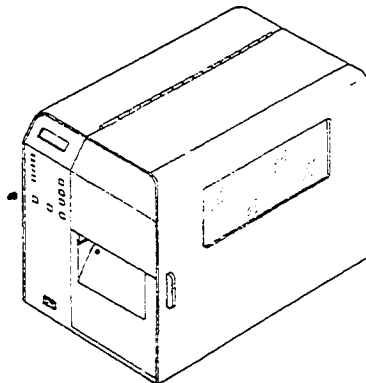

# M-8400

*Thermal Transfer / Direct Thermal  
Electronic Printer*



## Operator's Manual

*Second Edition*

**SATO America Inc.  
545 Weddell Drive  
Sunnyvale, CA 94089**

**Main Phone: (408) 745-1300  
Technical Support Hotline: (408) 745-1379  
Fax: (408) 745-1309**

**© Copyright 1992  
SATO America Inc.**

**Warning: This equipment complies with the requirements in Part 15 of FCC Rules for a Class A computing device. Operation of this equipment in a residential area may cause unacceptable interference to radio and TV reception requiring the operator to take whatever steps are necessary to correct the interference.**

**All rights reserved. No part of this document may be reproduced or issued to third parties in any form whatever without the express permission of SATO Corporation. The materials in these documents are provided for general information and are subject to change without notice. SATO Corporation assumes no responsibilities for any errors that may appear.**

# PREFACE

## M-8400 OPERATOR'S MANUAL

---

The M-8400 Operator's Manual contains basic information about the printer such as setup, installation, cleaning, and maintenance. It also contains complete instructions on how to use the operator panel to configure the printer. The following is a brief description of each section in this manual:

### SECTION 1: OVERVIEW

This section contains a discussion of the printer specifications and optional features.

### SECTION 2: INSTALLATION AND CONFIGURATION

This section contains instructions on how to unpack and set up the printer, load the labels and ribbon, and use the operator panel to configure the printer.

### SECTION 3: CLEANING AND MAINTENANCE

This section contains instructions on how to clean and maintain the printer.

### INDEX

## M-8400 PROGRAMMER AND TECHNICAL REFERENCE MANUAL

---

The M-8400 Programmer and Technical Reference Manual contains technical information about the printer's programming language and interface. The following is a brief description of each section in this manual:

### SECTION 1: M-8400 PROGRAMMING

This section introduces the SATO M-8400 printer programming language. It contains the commands that are used with the printer to produce labels with bar codes, alphanumeric data, and other graphics.

### SECTION 2: INTERFACE SPECIFICATIONS

This section contains the printer's interface specifications, which includes detailed information on how to properly interface your printer with your host system.

### SECTION 3: TROUBLESHOOTING

This section contains troubleshooting procedures to follow in the event that you have printer problems.

## **APPENDIXES**

Appendixes A through F contain the following information:

- Command codes quick reference chart
- Detailed bar code specifications
- Examples of custom-designed characters and custom graphics
- Instructions for setting the user default configuration
- Instructions for using the M-8400 optional features
- Character Tables

## **INDEX**

# Operator's Manual

## Table of Contents

---

### SECTION 1: PRINTER OVERVIEW

Introduction .....	1-1
General Printer Specifications .....	1-1
Optional Features .....	1-3

---

### SECTION 2: INSTALLATION AND CONFIGURATION

Introduction .....	2-1
Unpacking and Parts Identification .....	2-2
Setting Up the M-8400 .....	2-3
Loading Labels or Tags .....	2-4
Loading the Ribbon .....	2-6
Operator Panel .....	2-8
Printer Configuration .....	2-9
General Flowchart of M-8400 Configuration .....	2-10
User Mode .....	2-11
Password Protected Configuration Modes .....	2-16
Interface Mode .....	2-17
Service and Accessory Mode .....	2-21
<i>Label Sensor Adjustment</i> .....	2-23
<i>Setting the Sensor Threshold</i> .....	2-24
Counter Mode .....	2-32
Memory Card Mode .....	2-34
Test Print Mode .....	2-36
Watch Mode .....	2-41

---

### SECTION 3: CLEANING AND MAINTENANCE

Introduction .....	3-1
Adjusting the Print Quality (Darkness) .....	3-1
Cleaning the Print Head, Platen, and Rollers .....	3-2
Replacing the Print Head .....	3-4
Replacing the Fuse .....	3-6

---

### INDEX

# SECTION 1

## PRINTER OVERVIEW

### INTRODUCTION

---

The SATO M-8400 Thermal Transfer Printer is a complete, high-performance on-site labeling system. All printer parameters are user-programmable through the LCD and keypad. All popular bar codes and eight human-readable fonts are resident in memory, including a vector font, providing literally thousands of type styles and sizes.

The Operator's Manual will help you understand the basic operations of the printer such as setup, installation, configuration, cleaning, and maintenance.

The following information is presented in this section:

- General Printer Specifications
- Optional Features

### GENERAL PRINTER SPECIFICATIONS

---

<b>Printing Method</b>	Thermal Transfer and direct thermal.
<b>Printing Speed</b>	Up to 5 inches (125 mm) per second.
<b>Bar Code Symbology</b>	UPC-A, UPC-E, EAN-8, EAN-13, CODE 39, I 2/5, CODE 128, CODABAR, MSI, 2/5, CODE 93, UPC Bookland.
<b>PCS Value</b>	75% minimum.
<b>Bar Code Ratio</b>	1:2, 1:2.5, 1:3 or bar widths individually programmable.
<b>Human Readable Fonts</b>	Eight fonts including OCR-A and OCR-B representation and a vector font. American and European fonts, upper case and lower case with descenders plus memory available for custom fonts.
<b>Flexibility</b>	360 degree rotation of bar codes and text; character expansion horizontally and vertically; RAM storage for special characters; dot-addressable graphics; sequential numbering. Battery backed-up RAM storage for up to 8 formats and/or graphic images. Form overlay for high speed editing of complex formats.

<b>Sensing</b>	Adjustable stock sensor for die cut labels or tags. Reflective sensor for use with sensing marks. Automatic or setting of top of form. Continuous form printing possible.
<b>Media</b>	Die cut labels, plain paper face stock, SATO standard or equivalent. Tag stock, SATO standard or equivalent with punched feed slot for “see through” sensing. Tag caliper, .010 in. (0.25 mm). Maximum roll diameter, 8.6 in. (220 mm).
<b>Media Size</b>	Minimum – 1 inch (25 mm) W x .25 inch (6.35 mm) L. Maximum – 5 inches (125 mm) W x 20 inches (508 mm) L.
<b>Interface</b>	R232C (300 BPS – 19,200 BPS) Hardware Flow Control (DTR) Software Flow Control (X-ON/X-OFF) RS232 Bi-Directional (ENQ/Response) Parallel (Centronics compatible)
<b>Data Transmission</b>	ASCII.
<b>Dimensions</b>	10.4 inches (265 mm) W x 17 inches (435 mm) D x 13.5 inches (341 mm) H.
<b>Weight</b>	40 Lbs. (18kg).
<b>AC Power</b>	100V–115V (±10%) 220V (±10%) 50/60Hz (±1%) Idling, 50W Operating, 300W
<b>Environment</b>	Operating, 50–95°F (10–35°C) 15–85% RH, non-condensing Storage, 0–130°F (–20–55°C) Maximum, 90% RH, non-condensing
<b>Maximum Print Area</b>	4.1 inches (104 mm) W x 14 inches (360 mm) L
<b>Print Module (Dot Size)</b>	.005 inch (.125 mm) square (M8400/8) .0066 inch (.167 mm) square (M8400/6)
<b>Display</b>	LED indicators: on-line, media out, carbon out, error. LCD display for printer configuration and fault conditions.
<b>Approvals</b>	FCC Class A; UL.

## OPTIONAL FEATURES

---

<b>Label Cutter</b>	Internal attachment allowing control through programming to cut labels as they are printed at specified intervals.
<b>Label Dispenser</b>	Allows labels to peel off backing for immediate (on demand) application (one label at a time); resides within the printer.
<b>Label Rewinder</b>	External option that provides roll-to-roll rewind capabilities.
<b>Ribbon Saver</b>	Internal attachment that halts ribbon movement when excess “white space” is detected during printing and feeding of labels.
<b>Memory Module</b>	Internal daughterboard plus 128K RAM card for battery-backed storage of jobs and graphics.
<b>OPCB</b>	Internal daughterboard used in conjunction with the printer’s RS232 interface, providing enhanced label format storage and print spooler capabilities. Memory size options of 32K, 128K, and 256K Static RAM are available.
<b>Coax Interface</b>	Internal interface that emulates an IBM 3287-2 printer with a Standard Type A BNC Connector. Allows the standard M-8400 printer interfaces to remain operational.
<b>Twinax Interface</b>	Internal interface that emulates IBM 5224, 5225, 5256, or 4214 printers with auto-terminate / cable thru capabilities. Allows the standard M-8400 printer interfaces to remain operational.



## SECTION 2

# INSTALLATION AND CONFIGURATION

### INTRODUCTION

---

This section is provided to assist you in taking the M-8400 from the shipping container to the application environment.

The following information is presented in this section:

- Unpacking and Parts Identification
- Setting Up the M-8400
- Loading Labels or Tags
- Loading the Ribbon
- Operator Panel
- Printer Configuration
  - General Flowchart of M-8400 Configuration
  - User Mode
- Password-Protected Configuration Modes
  - Interface Mode
  - Service and Accessory Mode
  - Counter Mode
  - Memory Mode
  - Test Print Mode
  - Watch Mode

## UNPACKING AND PARTS IDENTIFICATION

---

Consider the following when unpacking the printer:

- Box stays right-side up
- Lift the printer out of the box carefully
- Remove the plastic covering from the printer
- If the printer has been stored in a cold environment, allow it to reach room temperature before powering on
- Set the printer on a solid, flat surface
- Inspect the container and printer for any signs of damage that may have occurred during shipping

*Note: The following illustration is representative only. Your printer may not be packed exactly as shown here, but the unpacking steps are similar. Your printer may be wrapped in plastic with styrofoam covering the corners.*

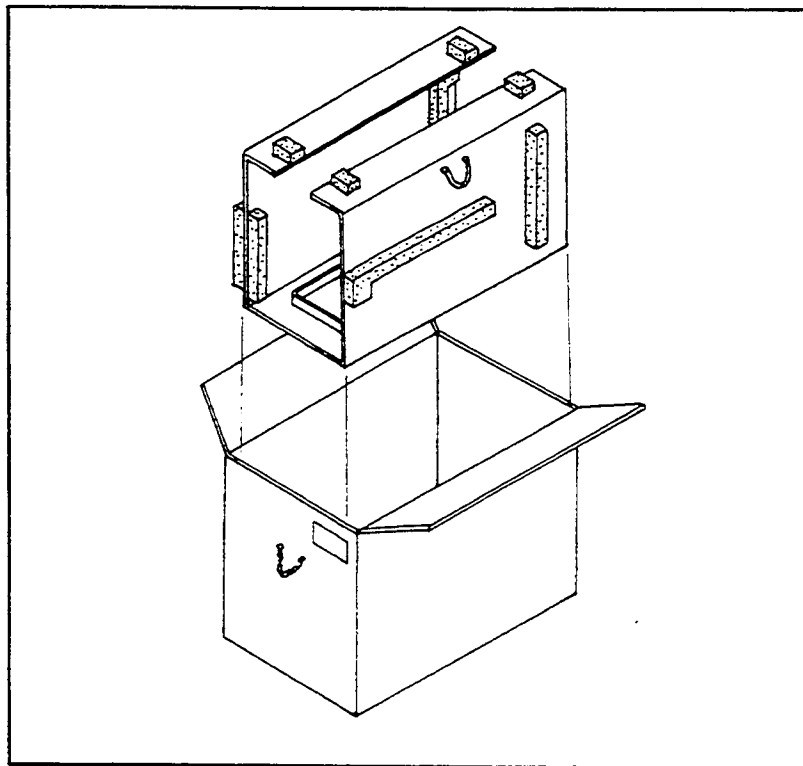

Verify that you have the following materials when unpacking:

- |  |  |
|--|--|
| <input type="checkbox"/> Printer           | <input type="checkbox"/> Operator's Manual / |
| <input type="checkbox"/> Power Cord        | Programmer and                               |
| <input type="checkbox"/> Extra Ribbon Core | Technical Reference                          |
|  | Manual                                       |

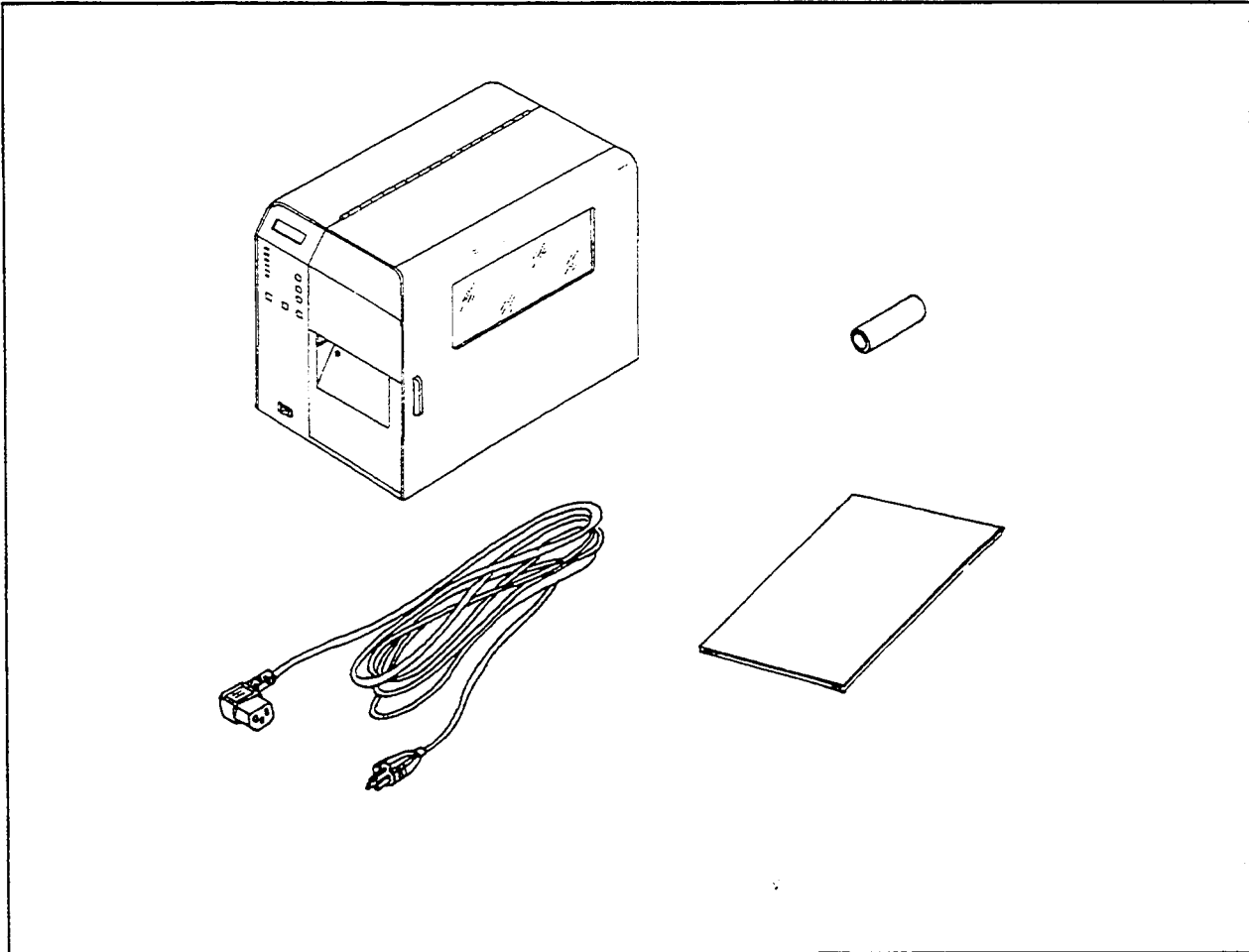

## SETTING UP THE M-8400

---

Consider the following when setting up the printer:

- Locate a solid flat surface to set the printer (the printer's footprint is 10.5 inches wide x 17 inches deep).
- The location should be near the host computer: maximum distance for RS232 cables is 50 feet; maximum distance for Centronics Parallel cables is 6 feet. Cables can be purchased locally, and their configuration will depend upon the host computer being used.

## LOADING LABELS OR TAGS

---

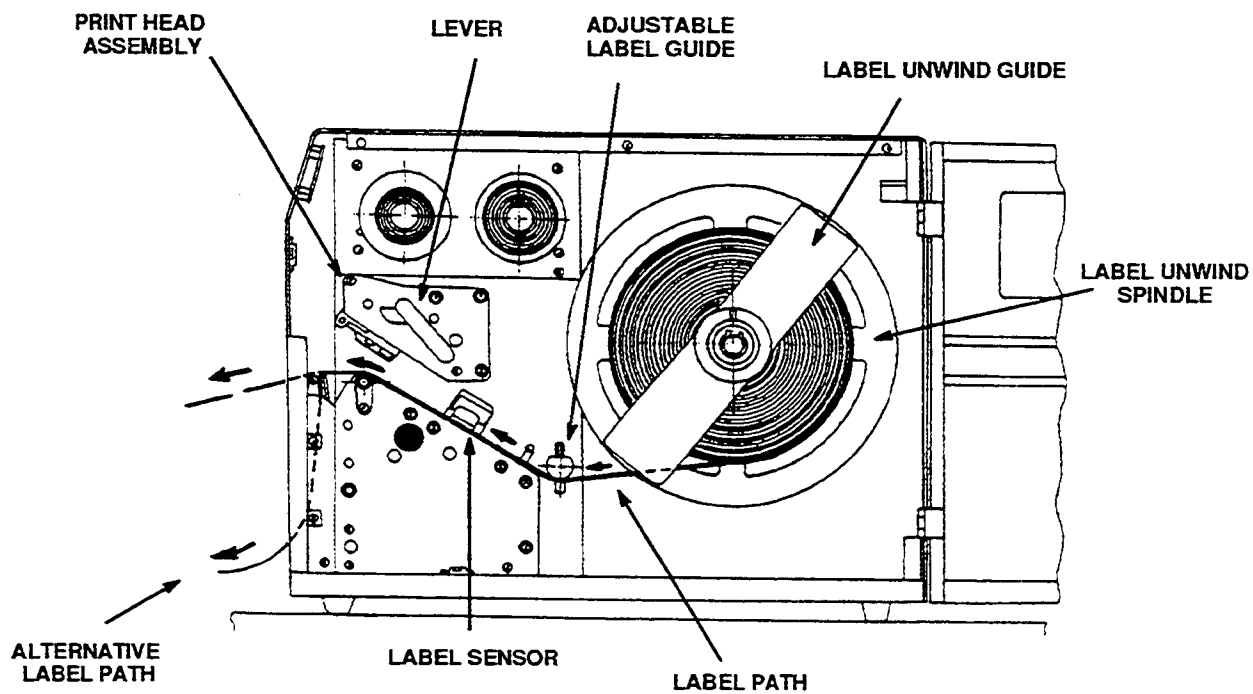

<b>Step</b>	<b>Action</b>
1	Open the side and top door.
2	Open the <b>PRINT HEAD ASSEMBLY</b> by turning the <b>LEVER</b> (on the side of the assembly) to the “head open” position.
3	Remove the <b>LABEL UNWIND GUIDE</b> from <b>LABEL UNWIND SPINDLE</b> .
4	<p>If using roll labels (or tags), load the roll onto the <b>LABEL UNWIND SPINDLE</b> so that the printed side of the label faces upward as it unwinds from the roll. Push the roll all the way to the inside of the printer, and replace the <b>LABEL UNWIND GUIDE</b>.</p> <p>If using fanfold labels or tags, set them on a flat surface behind the printer. Open the feed slot in the rear of the printer by removing two nuts inside the printer. Pass the labels (printed side up) through the slot and under the <b>LABEL UNWIND SPINDLE</b>.</p>
5	<p>Feed the labels under the <b>ADJUSTABLE LABEL GUIDE</b>, under the <b>LABEL SENSOR</b>, through the <b>PRINT HEAD ASSEMBLY</b>, and out the front of the printer.</p> <p>Inspect the labels through the path and verify that they match the <b>LABEL PATH</b> as in the diagram above. Set the <b>ADJUSTABLE LABEL GUIDE</b> to keep the labels against the inside of the printer.</p> <p><b>NOTE:</b> If the label dispenser option has been purchased, remove 6 to 8 inches of labels from the backing and feed the backing through the <b>ALTERNATE LABEL PATH</b> as shown in the diagram. For information on how to enable this option, see Mode S of the printer configuration (Section 2).</p>
6	If the ribbon is already loaded, close the <b>PRINT HEAD ASSEMBLY</b> by turning the <b>LEVER</b> to the “ <b>LABEL</b> ” or “ <b>TAG</b> ” position, based on what you have loaded.

## LOADING THE RIBBON

---

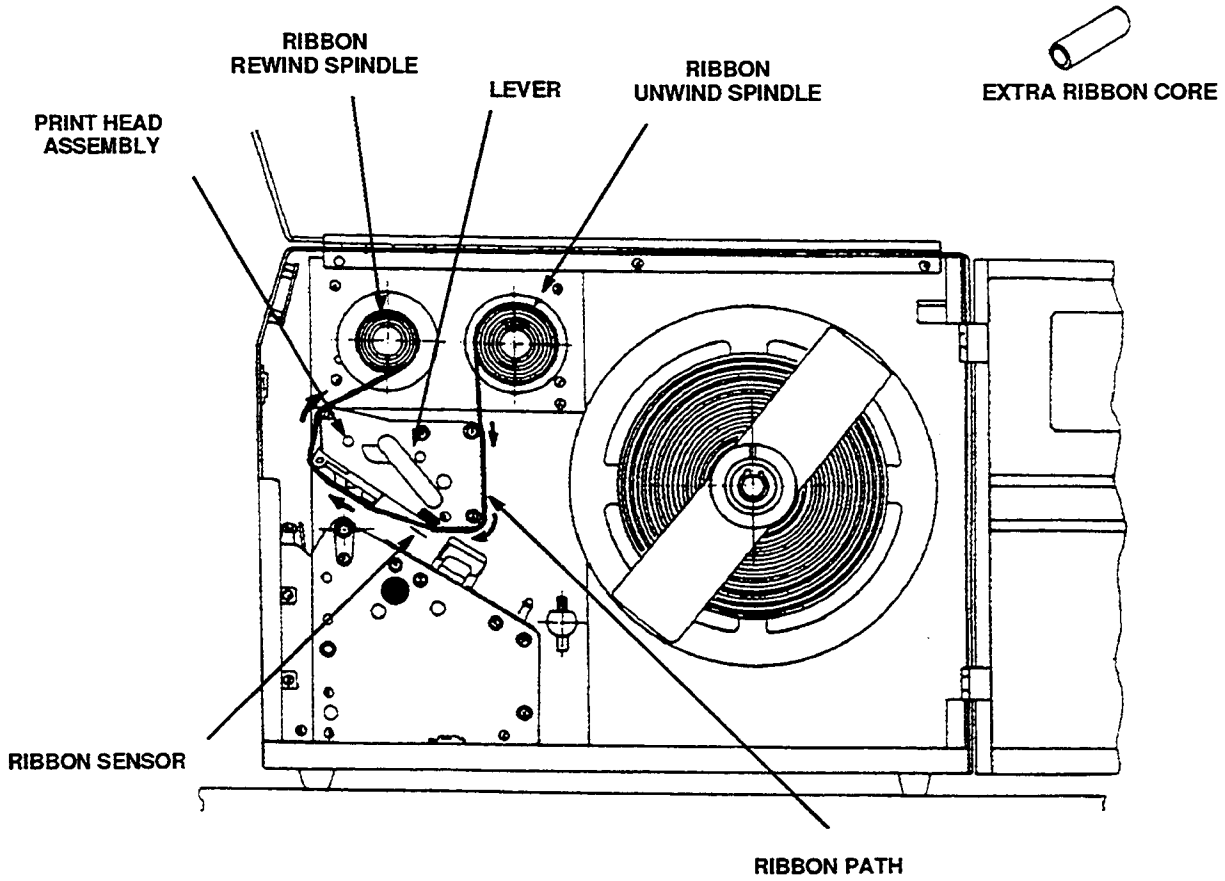

<b>Step</b>	<b>Action</b>
1	Open the side and top door.
2	Open the <b>PRINT HEAD ASSEMBLY</b> by turning the <b>LEVER</b> (on the side of the assembly) to the “head open” position.
3	Locate the <b>EXTRA RIBBON CORE</b> supplied with the printer. Place the core on the <b>RIBBON REWIND SPINDLE</b> , pushing it all the way to the inside of the spindle. <i>Note that the new empty core of each subsequent roll becomes the next rewind core.</i>
4	Load the ribbon onto the <b>RIBBON UNWIND SPINDLE</b> , also pushing it all the way to the inside of the spindle. The dull side of the ribbon should be facing down as it travels through the <b>PRINT HEAD ASSEMBLY</b> .
5	Feed the lead of the ribbon through the <b>RIBBON SENSOR</b> (located at the inside wall of the print head assembly area) through the <b>PRINT HEAD ASSEMBLY</b> , and up to the <b>RIBBON REWIND SPINDLE</b> . Ensure the ribbon goes between the <b>RIBBON SENSOR</b> and the metal bar directly beneath the sensor.
6	Load the ribbon behind and over the top of the <b>RIBBON REWIND SPINDLE</b> and tape it to the <b>EXTRA RIBBON CORE</b> (see diagram above). Ensure that it matches the <b>RIBBON PATH</b> in the diagram above.
7	Manually turn the ribbon onto the rewind spindle 1 to 2 turns to secure it.
8	If the labels are already loaded, close the <b>PRINT HEAD ASSEMBLY</b> by turning the <b>LEVER</b> to the “LABEL” or “TAG” position, based on what you have loaded.

**NOTE:** Run a test print to ensure the labels and ribbons were loaded correctly. See *Mode T of the printer configuration for instructions on how to run test prints (Page 2–37).*

## OPERATOR PANEL

This M-8400 operator panel consists of an LCD display, indicator lights, user-accessible keys, and adjustments. After you power on the printer (using the switch on the front of the printer), compare the operator panel on the printer to the diagram below. Familiarize yourself with the lights and keys as it will help you understand the configuration process.

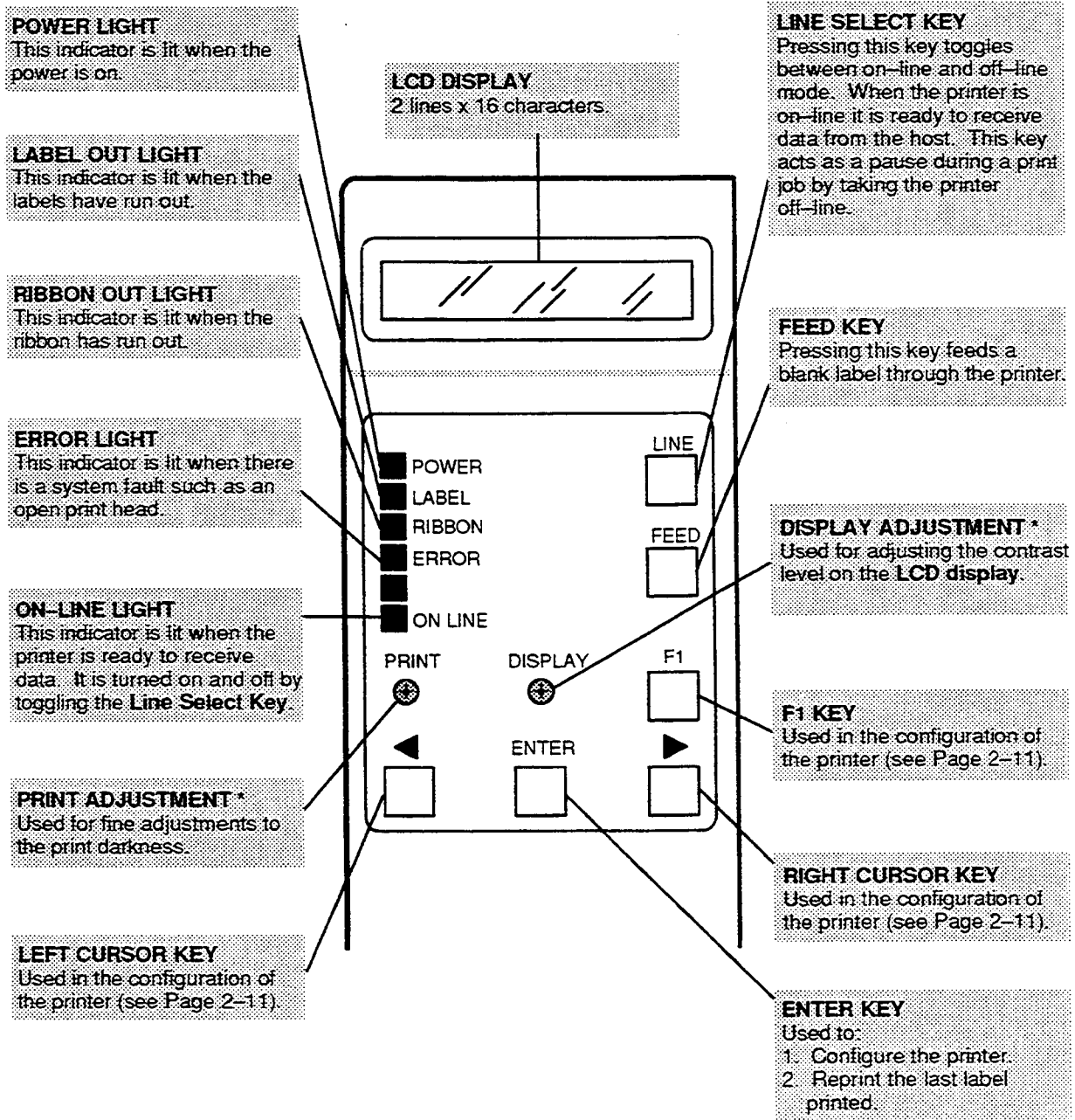

\* Use a small flathead screwdriver for these adjustments.



## PRINTER CONFIGURATION

The operator panel on the M-8400 is used to configure the printer, customizing it for your needs. For example, through the configuration you can specify how dark you would like the print to be or which optional features (such as a dispenser) are being used with the printer. These settings along with other configuration options provide wide flexibility in the possible ways to use the printer.

All of the optional features are grouped under certain modes, which are listed in the chart below. For instance, Mode U (User Mode) contains only the features that pertain to the user, whereas Mode S (Service Mode) contains features that may be used more by a technician. Modes I, S, C, M, T, and W cannot be accessed without a password, and are therefore considered as password-protected modes. Using the keys on the front panel, you will work your way down to the correct mode and then the various options of that mode.

**NOTE:** Before you begin with the printer configuration, please note that the Programmer and Technical Reference Manual contains a *Troubleshooting* section in the Appendix. If you have any problems with the printer, refer to this section.

Password Protected Configuration Modes						
Mode U	Mode I	Mode S	Mode C	Mode M	Mode T	Mode W
<b>User</b>	<b>Interface</b>	<b>Service</b>	<b>Counter</b>	<b>Memory</b>	<b>Test Print</b>	<b>Watch</b>
Print Darkness	Interface Type	Sensor	Head Counter	Copy Memory Card	Receive Buffer	Year
Print Speed	Receive Buffer Size	Pitch Detection Method	Cutter Counter	Set Card Type	Format Numbers	Month
Pitch Offset	Proto-Codes	Print Method	Lifetime Counter	Clear Memory Card	Stored Graphics	Day
		Carbon Saving	User Counter		Custom Designs	Hour
		Cutter			Head Pattern	Minute
		Dispenser			Built-in Fonts	
		Pitch Offset			Vector Fonts	
		VH Offset			Printer Setting	
		Head Check			Bar Codes	
		Loopback Test				
		SATO Defaults				
		User Defaults				
		External Signals				
		Password				

## General Flowchart Of M-8400 Configuration

Once the labels and ribbon are loaded and the printer is powered on, the LCD display appears as shown:



This quantity field displays the number of labels that are waiting to be printed. At this point, the printer is considered to be “on-line”, and the ON-LINE light should be lit. The printer must be off-line to begin configuration. To take the printer off-line, press LINE.

The following flowchart shows how the different modes can be accessed. It also shows how Mode U is accessed first, with the other modes requiring a password for access. Each shaded box represents the status of the operator panel’s LCD display, and the symbols between the large boxes represent the operator panel keys.

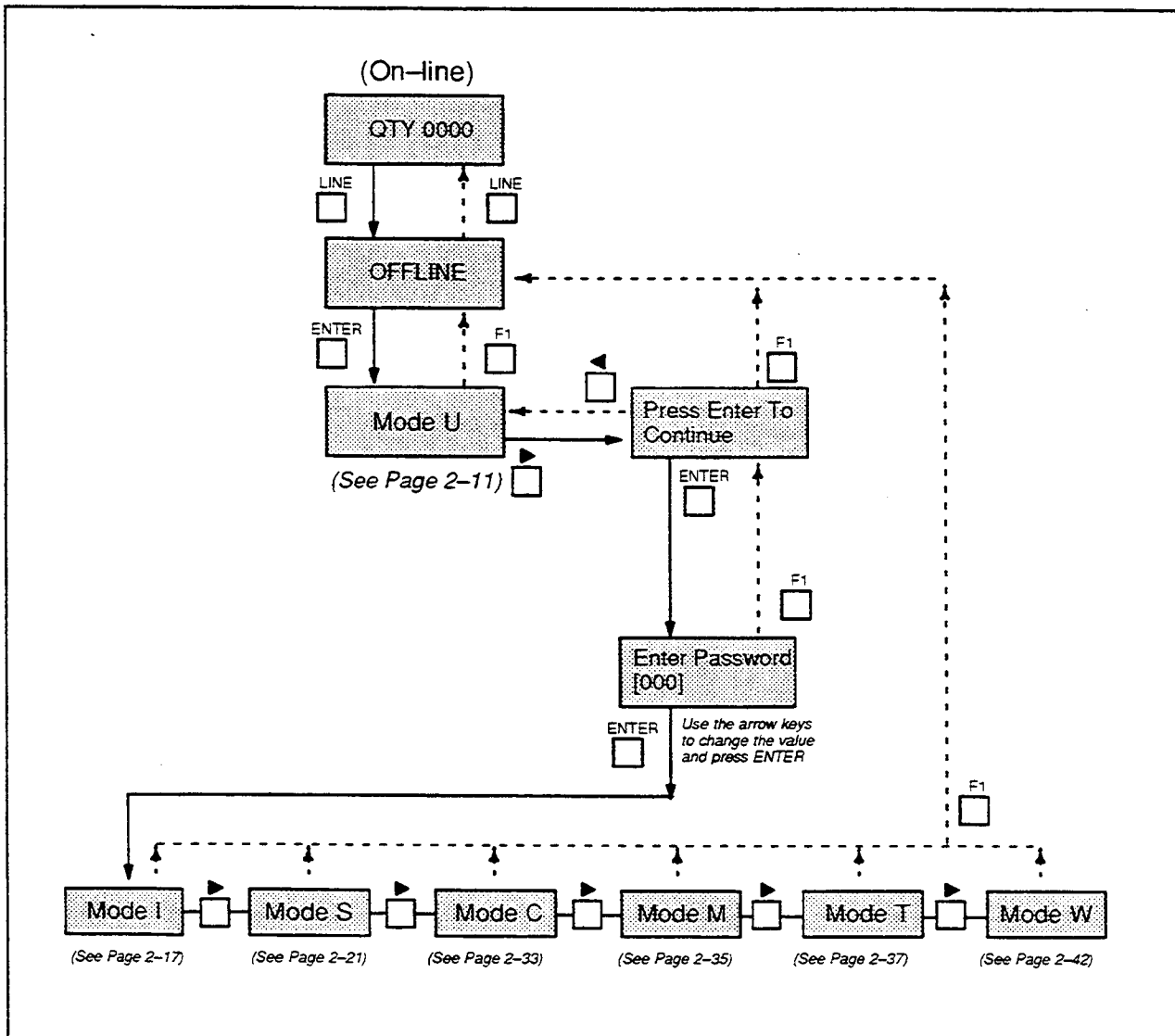

## User Mode

The following chart shows a general flow of the configuration for Mode U. Each shaded box represents the status of the operator panel's LCD display, and the symbols between the boxes represent the operator panel keys that, if pressed, will take you forward or backward in the configuration process. For more detailed instructions of this configuration, see Pages 2-12 through 2-15.

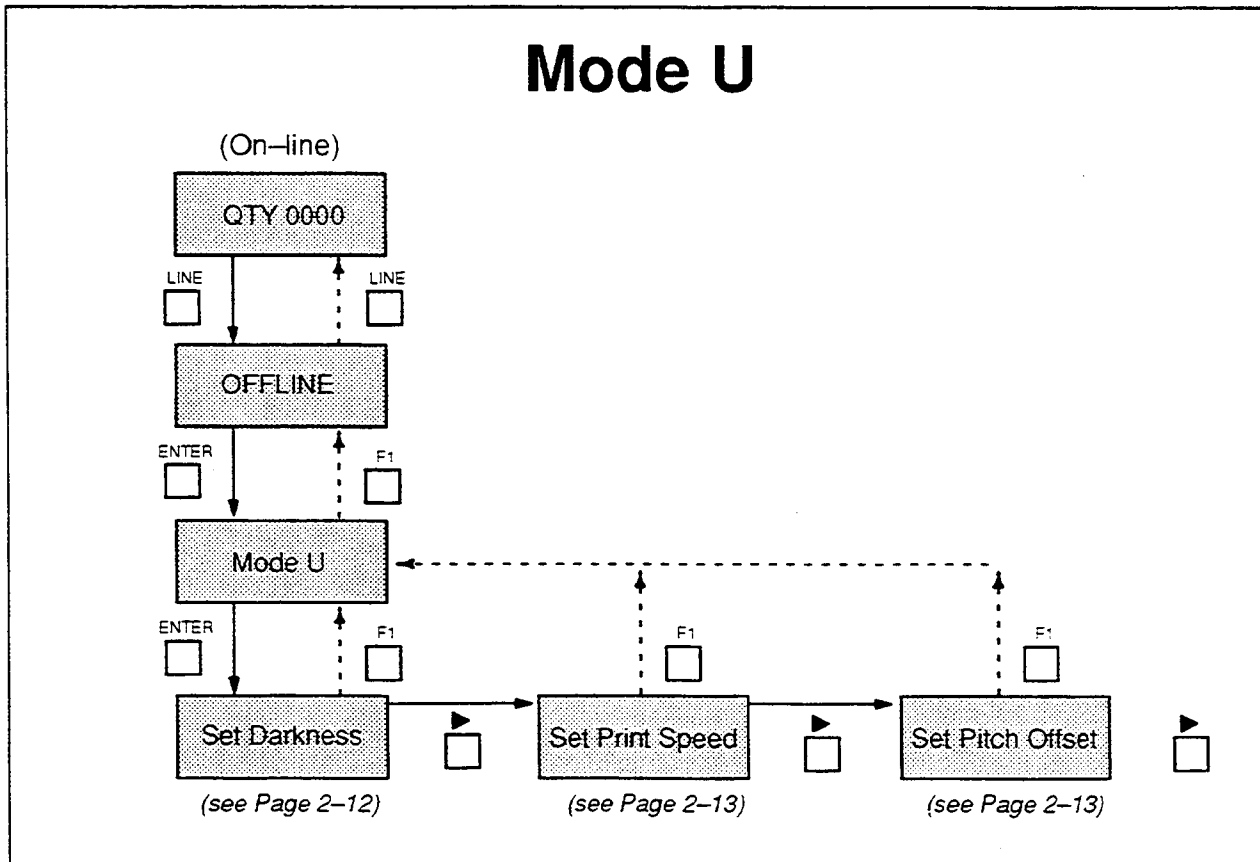

The ENTER key, arrow keys, and F1 key are used throughout the configuration process to proceed downward (i.e., forward), horizontally, or upward (i.e., backward) through the options and values. Basically, the keys are used as follows:



Used to select an option from the display and move down to the next menu level. Also used to set a value into the printer configuration.



Used to proceed horizontally (left or right) through a series of values, remaining on the same level until the desired value is displayed.



Used to proceed upward (i.e., backward) to a previous level.

## Mode U: Print Darkness

(from Page 2-11)

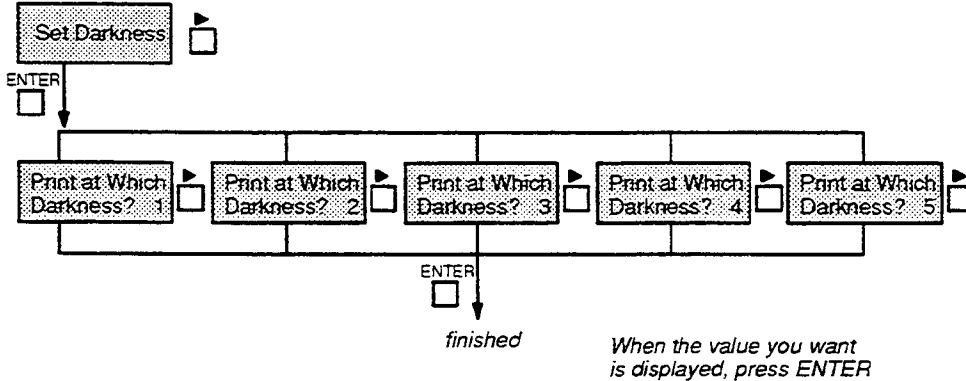

Option	Definition/Purpose	Values/Settings
<b>Print Darkness</b>	To set the darkness of the print on the label. <i>This option should provide adequate flexibility. If the darkness needs to be fine-tuned, you may use the adjustment on the operator panel.</i>	5 Darkest 4 3* 2 1 Lightest

\* SATO Factory Default

## Mode U: Print Speed & Pitch Offset

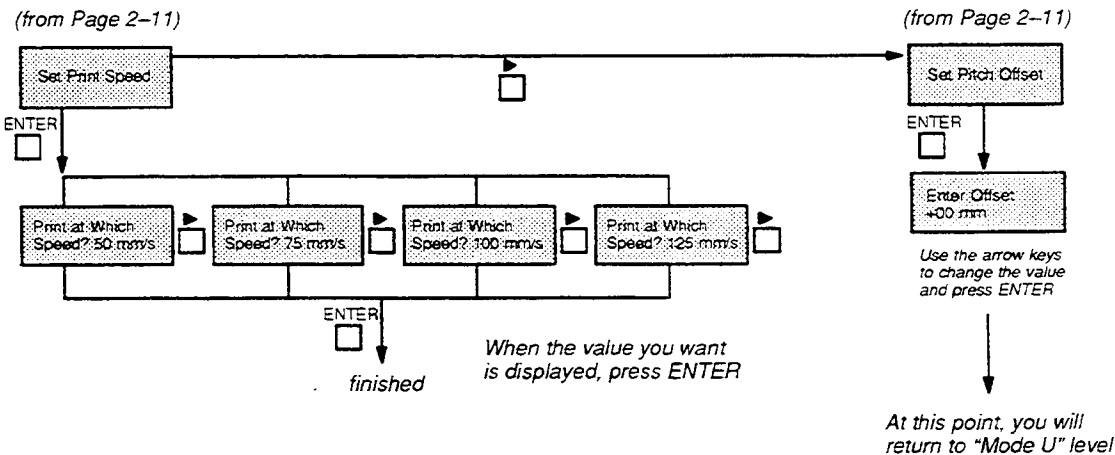











Option	Definition/Purpose	Values/Settings
<b>Print Speed</b>	To set the speed at which the labels are printed.	50 mm/sec (2 in/sec) 75 mm/sec (3 in/sec) 100 mm/sec (4 in/sec)* 125 mm/sec (5 in/sec)
<b>Pitch Offset</b>	<p>To adjust the positioning of the top of form forward/backward from the normal stop position under the print head.</p> <p>A positive pitch offset value moves the label's top edge out from the printer, thus advancing the starting print position into the label.</p> <p>A negative pitch offset value moves the label's top edge into the printer, thus backing up the starting print position towards the previous label.</p>	<p>+00 mm*</p> <p>(-50 mm to +50 mm)</p> <p>(If the scale is set to dots from Mode S, then the range is -400 dots to +400 dots)</p>

\* SATO Factory Default

## Detailed Mode U Configuration Instructions

The following chart takes you step by step through the front panel configuration for Mode U. Use this chart along with the diagrams and charts on pages 2–11 through 2–13 to understand the configuration process.













Panel Displays:	Press Key:	Comments
Qty 0000	LINE 	Printer is on-line. Pressing LINE takes the printer off-line, which enables you to begin configuring.
Offline	ENTER 	Once off-line, simply pressing ENTER takes you to the User Mode (Mode U). <i>To return to the on-line mode (above), press LINE here instead of ENTER.</i>
[Select a Mode] Mode U	ENTER or  	Press ENTER and progress into Mode U.  <i>You can also use the arrow keys to access Modes I, S, C, M, T, and W.</i>
<Mode U Options> Set Darkness	ENTER or  	This option is a primary adjustment for the darkness of print. Press ENTER to display darkness values.  <i>You can also use the arrow keys to move to another Mode U option. (Not shown here.)</i>
Print at Which Darkness? 3	ENTER or  	Here you can: <ol style="list-style-type: none"> <li>1. Use the arrow keys to move through the numbers 1 – 5 for values of print darkness (5 is the darkest; the SATO default is 3).</li> <li>2. When the value you want is displayed, press ENTER to set the darkness and move to the next Mode U option.</li> </ol>
<Mode U Options> Set Print Speed	ENTER or  	Press ENTER to display print speed values.  <i>You can also use the arrow keys to move to another Mode U option. (Not shown here.)</i>

Panel Displays:	Press Key:	Comments
<div style="border: 1px solid black; padding: 5px;">           Print at Which Speed? 100 mm/s         </div>	ENTER <input type="checkbox"/> or <input type="checkbox"/> <input type="checkbox"/>	Here you can: <ol style="list-style-type: none"> <li>1. Use the arrow keys to move through the numbers 50 – 125 mm/sec for values of print speed (the SATO default is 100).</li> <li>2. When the value you want is displayed, press ENTER to set the speed and move to the next Mode U option.</li> </ol>
<div style="border: 1px solid black; padding: 5px;">           &lt;Mode U Options&gt; Set Pitch Offset         </div>	ENTER <input type="checkbox"/> or <input type="checkbox"/> <input type="checkbox"/>	This option sets the positioning of the top of form forward or backward from the normal stop position under the print head. Press ENTER to display pitch offset values.  <i>You can also use the arrow keys to move to another Mode U option. (Not shown here.)</i>
<div style="border: 1px solid black; padding: 5px;">           Enter Offset +00mm         </div>	ENTER <input type="checkbox"/> or <input type="checkbox"/> <input type="checkbox"/>	Here you can: <ol style="list-style-type: none"> <li>1. Use the right arrow key to move through the positive numbers (which pushes label out from the printer) and the left arrow key to move through the negative numbers (which pulls or draws labels in from the printer).</li> <li>2. When the value you want is displayed, press ENTER to set the pitch offset and return to the Mode U prompt.</li> </ol>
<div style="border: 1px solid black; padding: 5px;">           [Select a Mode] Mode U         </div>	F1 <input type="checkbox"/>	Pressing F1 will return you to the OFFLINE display.  <i>Pressing F1 from any Mode U option will return you to the Mode U level.</i>
<div style="border: 1px solid black; padding: 5px;">           Offline         </div>	LINE <input type="checkbox"/>	Pressing LINE will return you to on-line status.
<div style="border: 1px solid black; padding: 5px;">           Qty 0000         </div>		The printer is ready to print. You have completed Mode U configuration.

## PASSWORD-PROTECTED CONFIGURATION MODES

### Detailed Instructions for Accessing Modes I, S, C, M, T, & W

The following chart takes you step by step through the front panel configuration for accessing Modes I, S, C, M, T and W. The instructions show you only how to access the first level of these modes. For further instructions on how to use the options of each mode, see the individual mode charts and diagrams on the following pages.

Panel Displays:	Press Key:	Comments
Qty 0000	LINE 	Printer is on-line. Pressing LINE takes the printer off-line, which enables you to begin configuring.
Offline	ENTER 	Once off-line, simply pressing ENTER takes you to the User Mode (Mode U). <i>To return to the on-line mode (above), press LINE here instead of ENTER.</i>
[Select a Mode] Mode U	  or ENTER 	Press the right arrow key and skip past Mode U.  <i>To access Mode U, you would use the ENTER key here.</i>
Press Enter to Continue	ENTER 	Press ENTER to progress into the password protected configuration modes.
Enter Password 000	  and ENTER 	Here you can: <ol style="list-style-type: none"> <li>1. Use the arrow keys to move through the numbers 000 – 999 until you reach the password number (SATO factory default is 000; password is set in Mode S).</li> <li>2. When the value you want is displayed, press ENTER to gain access to Modes I, S, C, M, T, and W.</li> </ol>
<Select a Mode> Mode I	  and ENTER 	Press the right arrow key skipping past Mode I, on to Mode S and so on. When you arrive at the mode you want to use to configure, press ENTER.



## Interface Mode

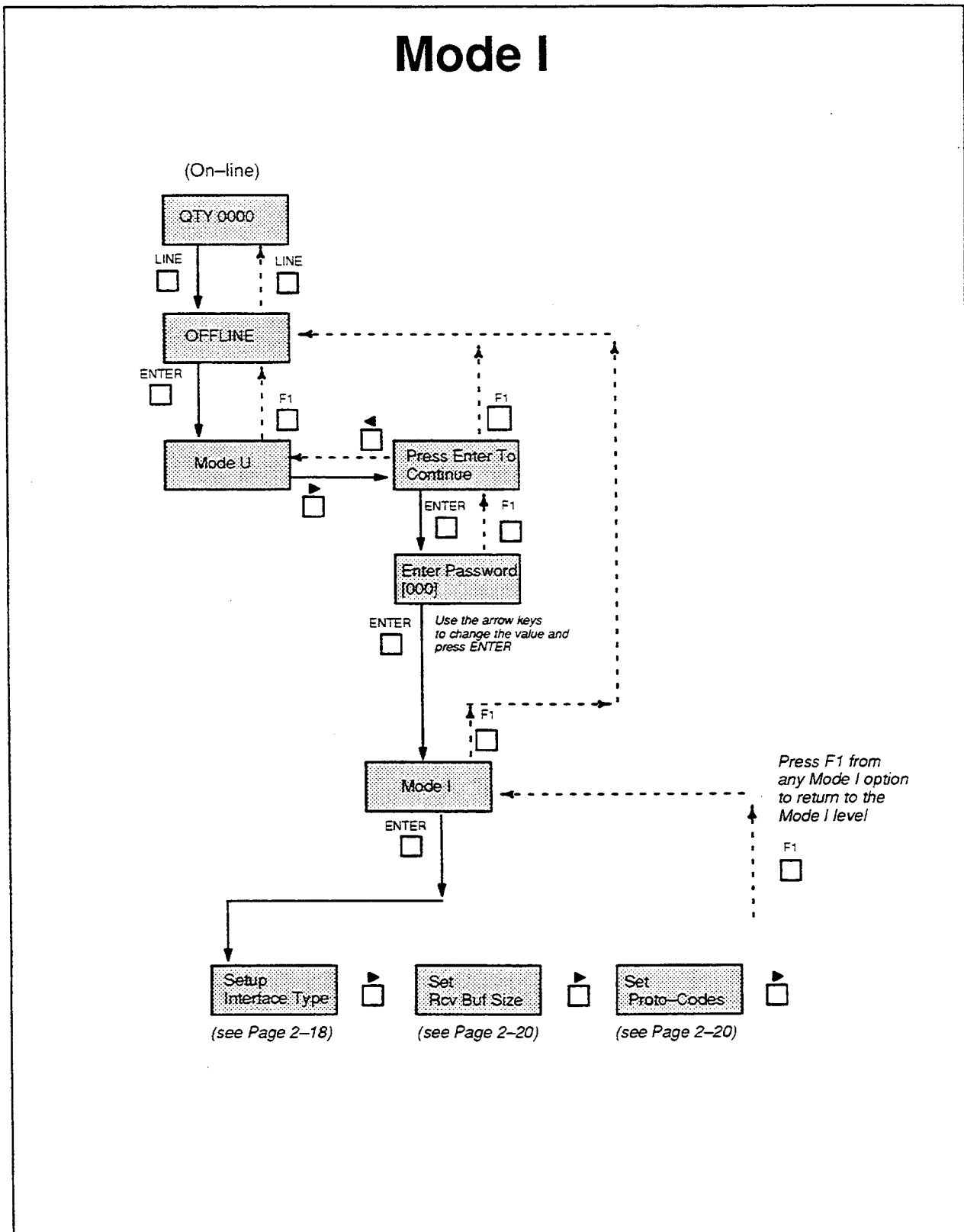

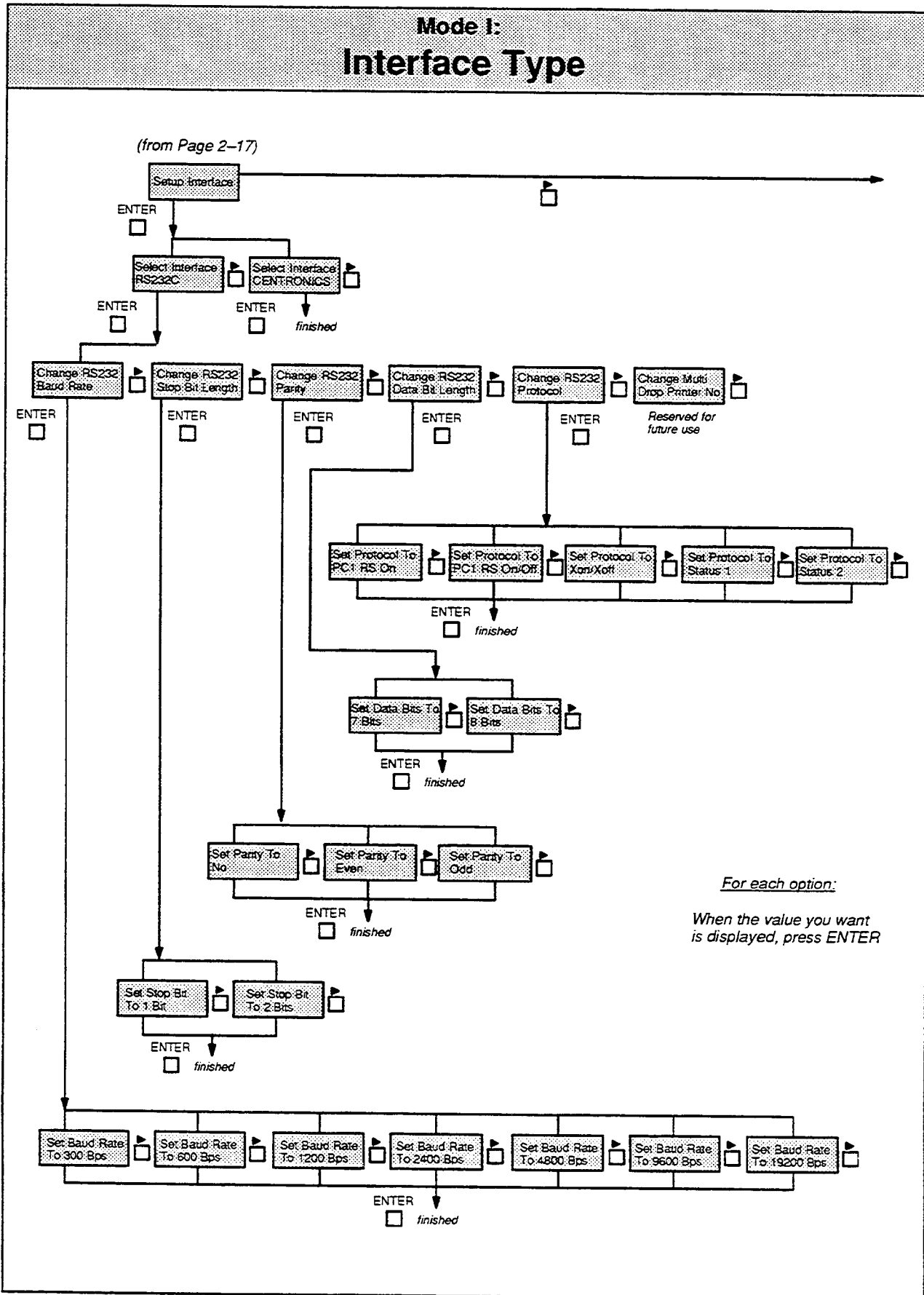

<b>Mode I: Interface Type</b>		
<b>Option</b>	<b>Definition/Purpose</b>	<b>Values/Settings</b>
<b>Interface</b>	<p>To indicate which interface will be used to communicate with your host computer.</p> <p>If RS232C is selected, you must set the following values:</p> <p>Baud Rate Stop Bit Parity Data Bit Protocol Multi-Drop Printer</p>	Centronics Parallel RS232C Serial*
		<b>If RS232C:</b>
		<b>Baud Rate Values:</b>
		300 Bps                      4800 Bps 600 Bps                      9600 Bps* 1200 Bps                      19200 Bps 2400 Bps
		<b>Stop Bit Values:</b>
		1Bit* 2 Bit
		<b>Parity Values:</b>
		No* Even Odd
<b>Data Bit Values:</b>		
7 Bits 8 Bits*		
<b>Protocol Values:</b>		
PC1 RS On* PC1 RS On/Off Xon/Xoff Status 1 – Reserved Status 2 – Bi-Directional		
<p><b>NOTE:</b> See the Programmer and Technical Reference Manual, Section 2 – Interface Specifications, for more details on RS232 protocols.</p>		
<b>Multi-Drop Printer Values:</b>		
<i>Reserved for future use.</i>		

\* SATO Factory Default

## Mode 1: Receive Buffer Size & Proto-Codes

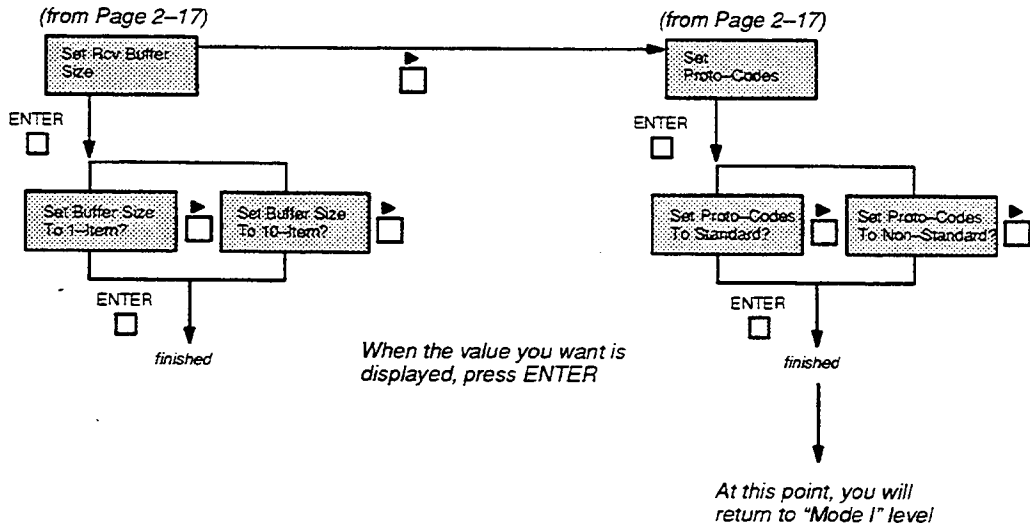

Option	Definition/Purpose	Values/Settings
<p><b>Receive Buffer Size</b></p>	<p>To indicate the size of the job buffer. A print job is defined by a Start command at the beginning and a Stop command at the end of a data block.</p>	<p><b>1-Item Buffer*</b> – The printer can process only one print job at a time and is busy until completion.  <b>10-Item Buffer</b> – Allows up to 10 print jobs to be sent in one data stream.</p>
<p><b>Proto-Codes</b></p>	<p>To select which Proto-Code set will be used in the data stream to the printer. <i>See the beginning of Section 1 of the Programmer and Technical Reference Manual for a list of each proto-code set.</i></p>	<p><b>Standard*</b>  <b>Non Standard</b></p>

\* SATO Factory Default

## Service and Accessory Mode

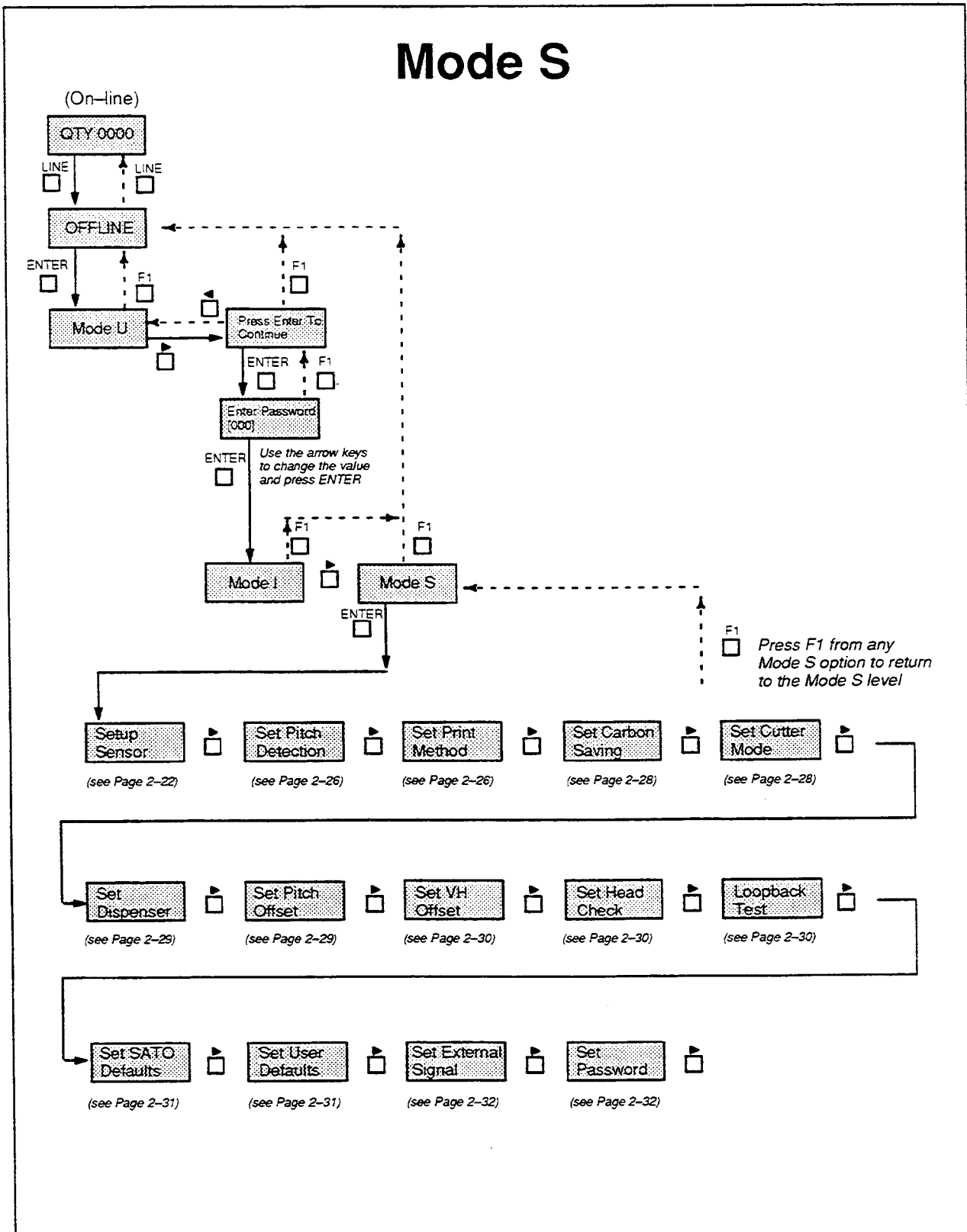

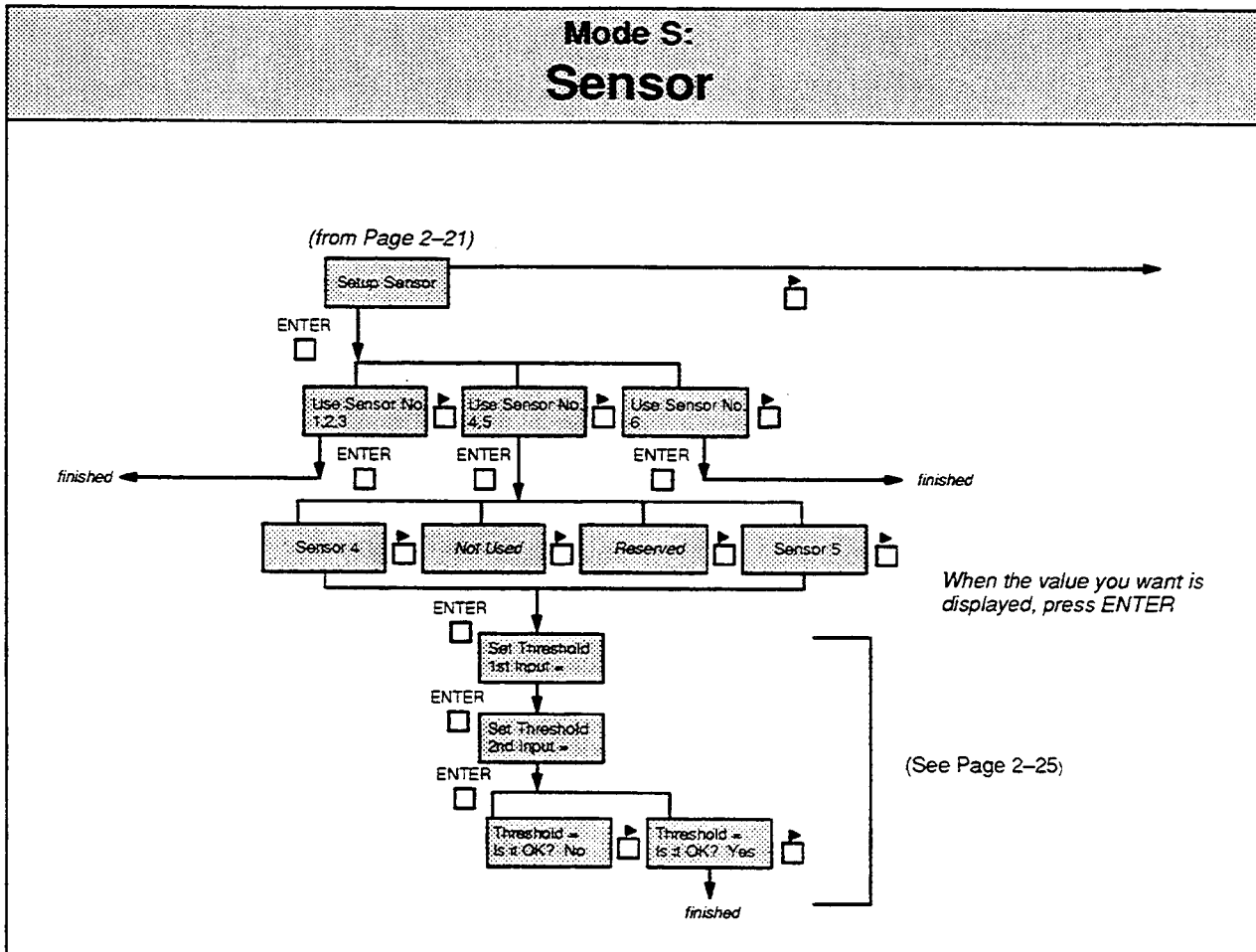

Option	Definition/Purpose	Values/Settings
<p><b>Sensor</b></p> <p>There are (6) individual label sensors available on the M-8400, of which (2) are currently used. Each sensor is used to detect the lead edge of the label or tag, in order to begin printing at the proper position. This option is used to select a sensor, then set the threshold for your labels.</p> <p><i>Note: You may need to position the sensor to find a notch or I-mark on your labels/tags. See Page 2-23, Label Sensor Adjustment.</i></p>		<p><b>1,2,3</b> Tag Hole / Notch  <b>4,5*</b> See-Thru &amp; Reflective  <b>6</b> Center Hole Sensor</p> <p>If 4,5:  <b>Sensor 4 (See-Thru)*</b> – For use with label backing or feed slots in tags  <b>Sensor 5 (Reflective)</b> – For use with I-marks on label or tag stock  <b>Not Used</b> – For continuous forms stock</p>
	<p>Once value 4 or 5 is selected, the threshold level is requested. For more information on this, see Page 2-25, <i>Setting the Sensor Threshold</i>.</p> <p><i>Note: When using sensors 1, 2, 3, or 6, it is not necessary to set threshold as for sensors 4 or 5. Sensors 1, 2, 3, or 6 are see-thru sensors primarily for use with tag stock having feed slots or tag holes in various positions.</i></p>	<p>If 4 or 5:  <b>1st Input</b> – Printer reads a voltage level based on what portion of the label is beneath the label sensor.  <b>2nd Input</b> – Printer reads a voltage level based on what portion of the label is beneath the label sensor.</p>
		<p>Is Threshold O.K.?  <b>No</b>  <b>Yes</b></p>

\* SATO Factory Default

## Label Sensor Adjustment

As mentioned, you may need to position the label sensor to match the position of your feed slots (notches) or I-marks on your labels/tags. The following diagrams below show the relative position of each sensor along the label sensor unit and its range of movement (values based on distance from inside edge of a tag or backing paper). To position the sensor(s), use the adjustment knob located outside and below the print head assembly area.

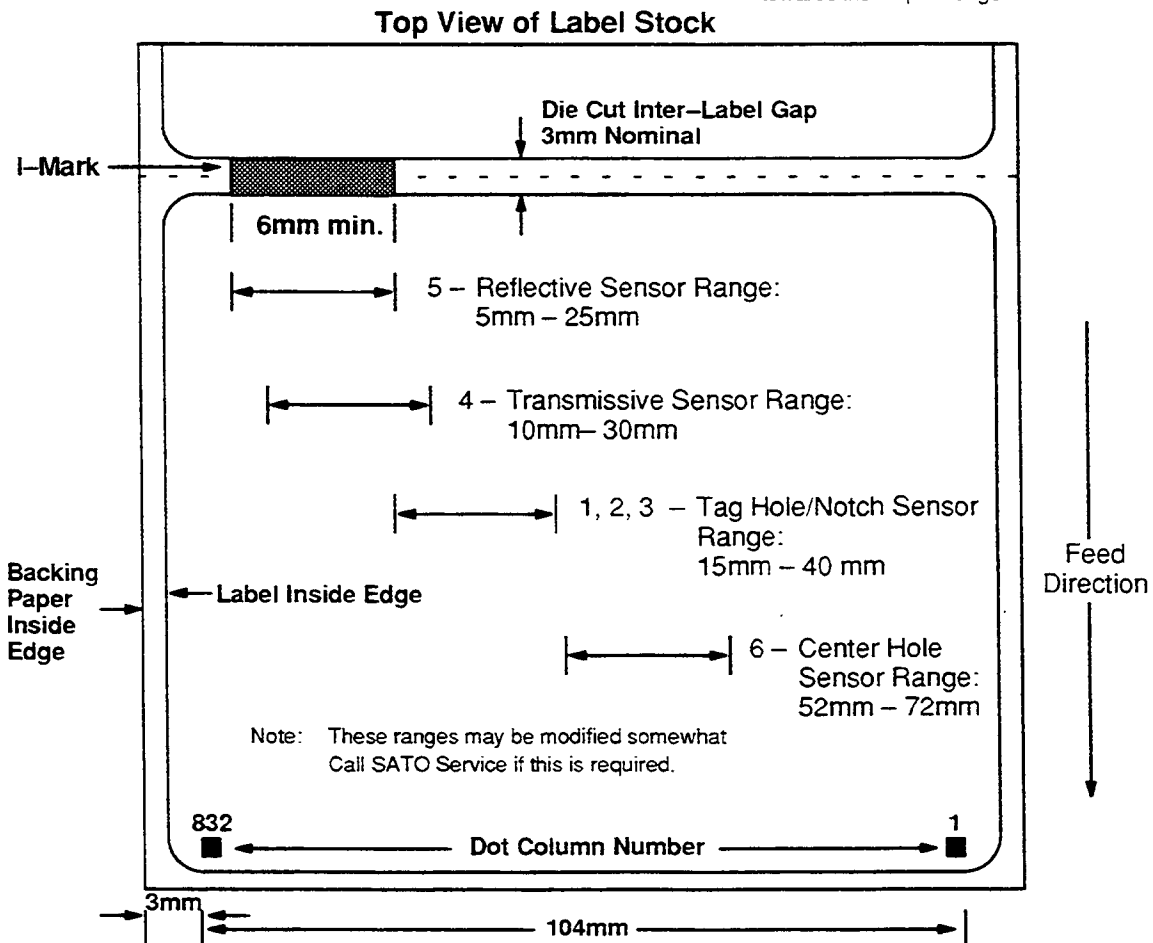
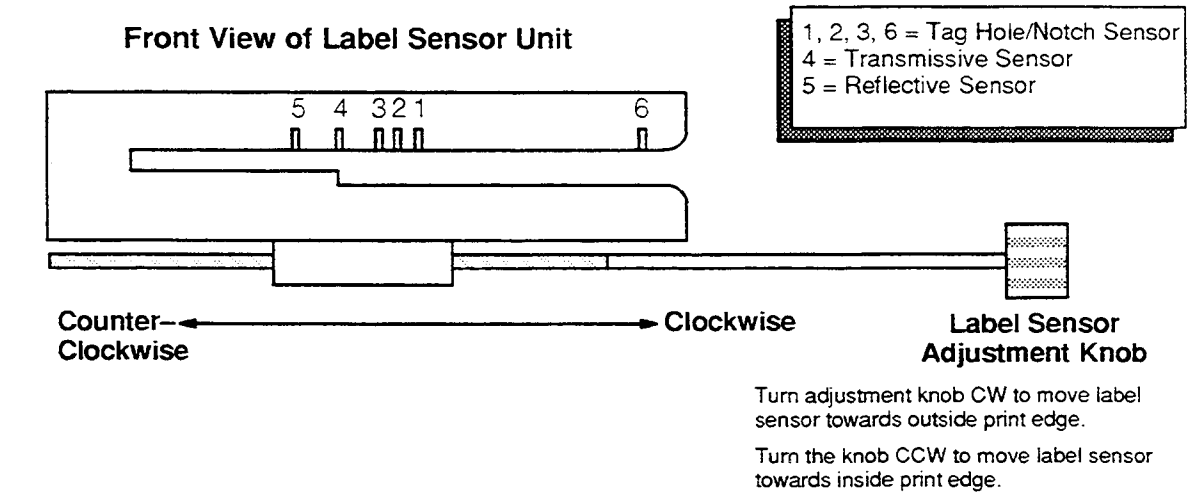

## Mode S: Setting the Sensor Threshold

---

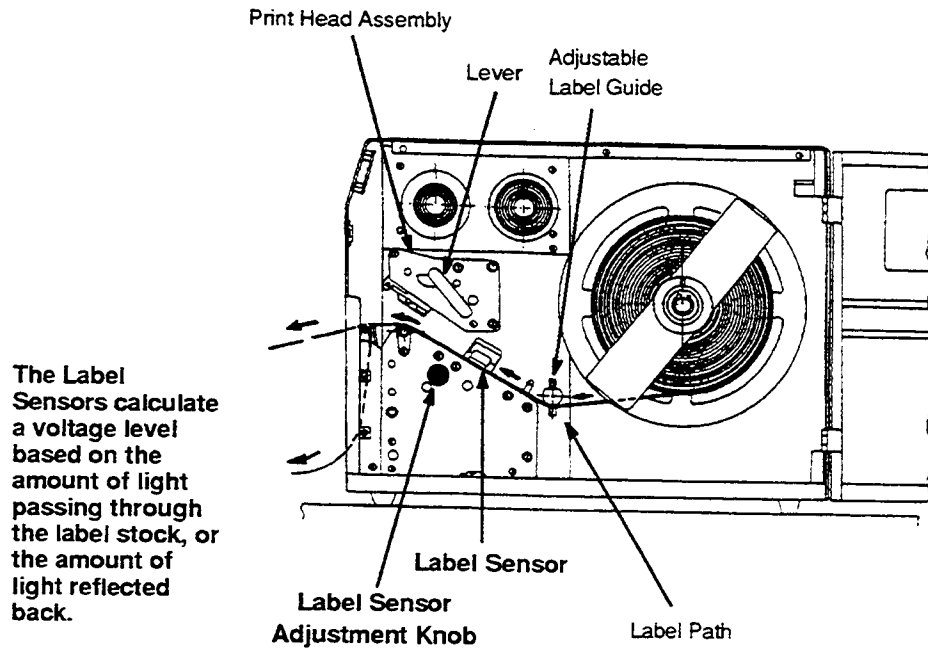

If Sensor 4 (See-Thru) or Sensor 5 (Reflective) is chosen during the use of the Sensor option in Mode S, a setting of threshold values will be required for the configuration. The printer will find a voltage level according to what part of the label is directly beneath the label sensor (see diagram above) at that time.

You will be required to move the label stock to different positions beneath the sensor to set the threshold. Use the following instruction chart to guide you through each step.



---

To Set Threshold 1st Input = 2.8V
--------------------------------------

When the printer requests a setting for the 1st input:

1. Open the print head assembly by turning its lever to the “head open” position, and follow these instructions:
2. Move the printable portion of the label stock directly under the sensor. (This should result in a voltage reading somewhere around 3.0V).
3. When the voltage value you want is displayed, press ENTER.

---

To Set Threshold 2nd Input = 0.2V
--------------------------------------

When the printer requests a setting for the 2nd input:

1. Move the label backing or tag hole portion of the label stock directly under the sensor. (This should result in a voltage reading something less than 1V).
2. When the voltage value you want is displayed, press ENTER.

---

Threshold = 1.5V Is it OK?      No
---------------------------------------

The printer will then calculate and display an average of the two voltage values. If the threshold value is correct, use the arrow keys to display a “Yes” and press ENTER to set the value. You are finished with the Sensor option. Close the print head assembly using its lever.

*Note: The threshold value resulting here should be nominally greater than 1.5V. If not, consistent feeding/printing cannot be maintained. A threshold less than 1.5V usually means either backing paper is too thick or stock is too thin, a problem in either case.*

---

## Mode S: Pitch Detection & Print Method

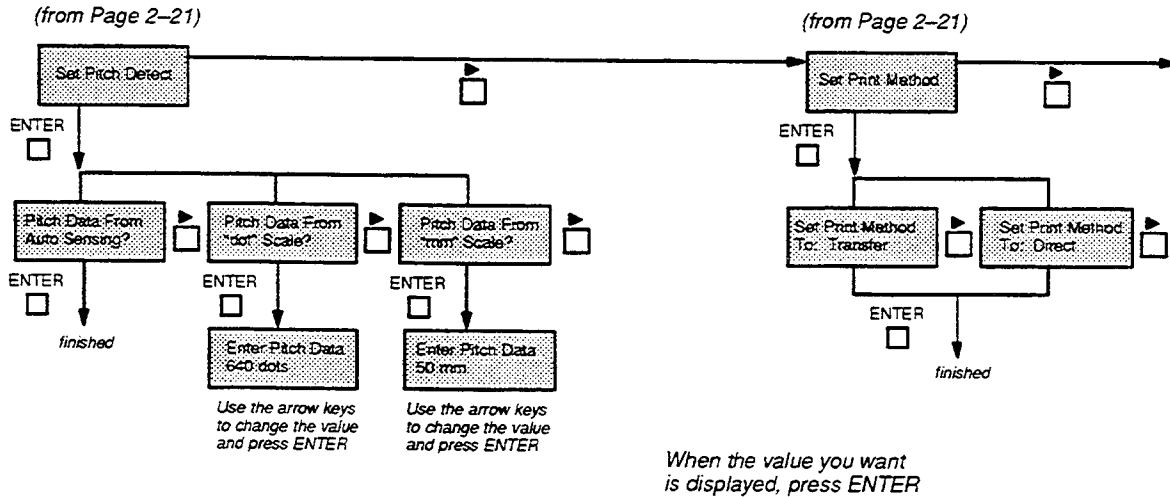

Option	Definition/Purpose	Values/Settings
<b>Pitch Detection</b>	To indicate the method by which the printer will determine the top of form.	<p><b>Auto-Sensing*</b> – The printer automatically determines label length. It will feed 2 or 3 labels each time the printer is powered on or label stock is changed.</p> <p><b>“dot” scale</b> – The label length will be determined by an entered dot value (see next page)</p> <p><b>“mm” scale</b> – The label length will be determined by an entered mm value (25.4mm per inch).</p> <p style="text-align: center;">If “dot” or “mm”:</p> <p><b>“dot” data</b> – (0000–2000) 0640 is the default value</p> <p><b>“mm” data</b> – (000–178) 050 is the default value</p>
<b>Print Method</b>	To indicate the method by which the labels or tags are printed. Printer makes adjustments in the amount of heat applied based on the method chosen.	<p><b>Thermal Transfer*</b> – Method of printing using a carbon-based ribbon on standard label or stock.</p> <p><b>Direct Thermal</b> – Method of printing using special paper that is heat sensitive. No ribbon is required.</p>

\* SATO Factory Default

## Dot Scale

When determining the label length using the dot scale method, begin by measuring from the leading edge of one label to the leading edge of the next label.

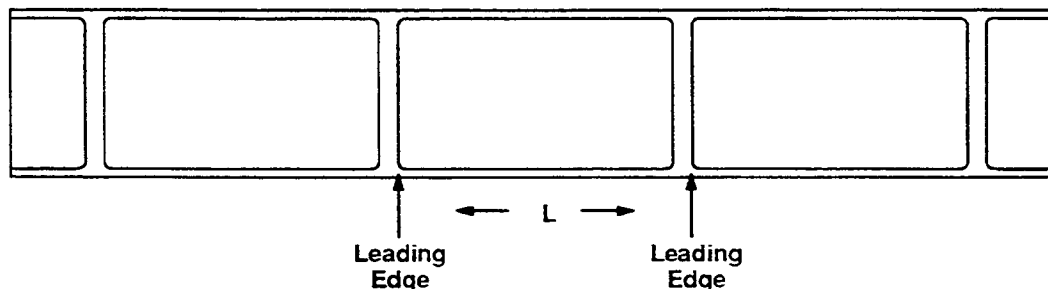

Step	Action
1	If the label length from one leading edge to the next leading edge is 3.15 inches or greater, set the dot scale to 640 dots (479 for the M-8400/6 printer).
2	If this length is less than 3.15 inches, use the following formula to determine the setting for the dot scale:

**Dot Scale Setting Formula:**  $(3.15 - N(L)) \times 203^*$

\* Use 152 instead of 203 if you have a M-8400/6 printer

**N** Number of whole labels (leading edge to leading edge) that will fit into 3.15 inches:  $N = (3.15 \div L) - \text{remainder}$   
**L** Label length from leading edge to leading edge (in inches)

### Example for Using Dot Scale Setting Formula

In this example, assume the label length from one leading edge to the next (**L**) is 1.25".

Step	Action
1	Calculate the number of whole labels ( <b>N</b> ) that will fit in 3.15 inches: $N = (3.15 \div 1.25) - \text{remainder}$ $N = 2.52 - \text{remainder}$ $N = 2.52 - .52 = 2$
2	Multiply the number of whole labels ( <b>2</b> ) by the label length from one leading edge to the next: $2 \times 1.25 = 2.5$ inches
3	Subtract the total in Step 2 from 3.15 inches: $3.15 - 2.5 = .65$ inches
4	Convert .65 inches to dots: $.65 \text{ inches} \times 203 \text{ dots/inch} = 132$ dots
5	Set the dot scale setting to <b>132</b>

## Mode S: Carbon Saving & Cutter

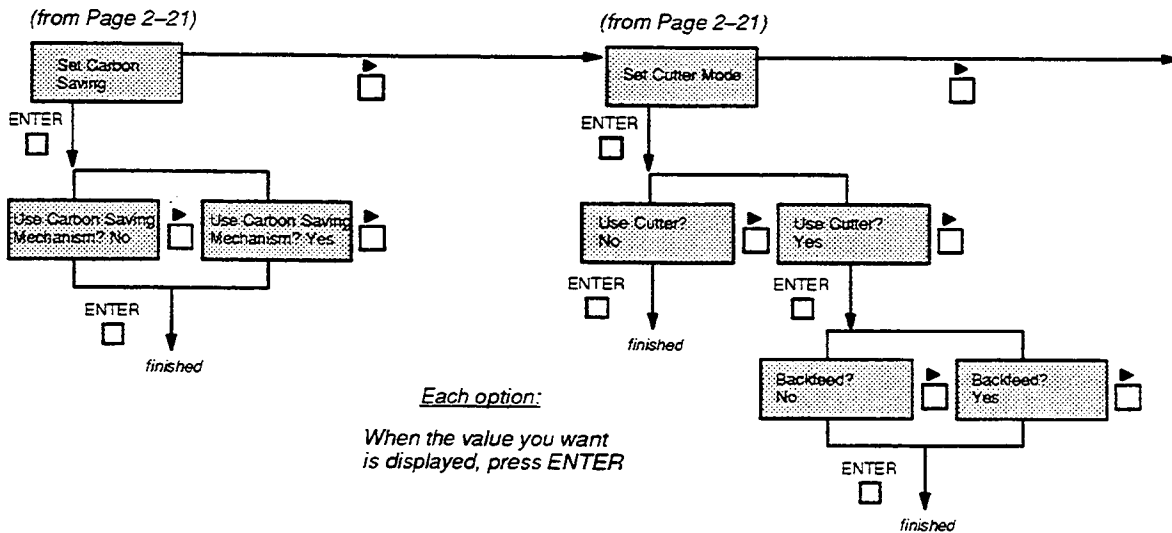

Option	Definition/Purpose	Values/Settings
<b>Carbon Saving</b>	To indicate the use of the ribbon (carbon) saver option.  <b>Note:</b> The M-8400 Ribbon Saver is an option to the printer and must be installed before enabling this feature. See the Programmer and Technical Reference Manual, Appendix E.	<b>No*</b> – Disables use of Ribbon Saver <b>Yes</b> – Enables use of Ribbon Saver
<b>Cutter Mode</b>	To indicate the use of the label cutter option.  <b>Note:</b> The M-8400 Cutter is an option to the printer and must be installed before enabling this feature. See the Programmer and Technical Reference Manual, Appendix E.	<b>No*</b> – Disables use of Cutter <b>Yes</b> – Enables use of Cutter
		If Yes, Backfeed?: <b>No</b> – Disables backfeed <b>Yes</b> – Enables backfeed

\* SATO Factory Default

## Mode S: Dispenser & Pitch Offset

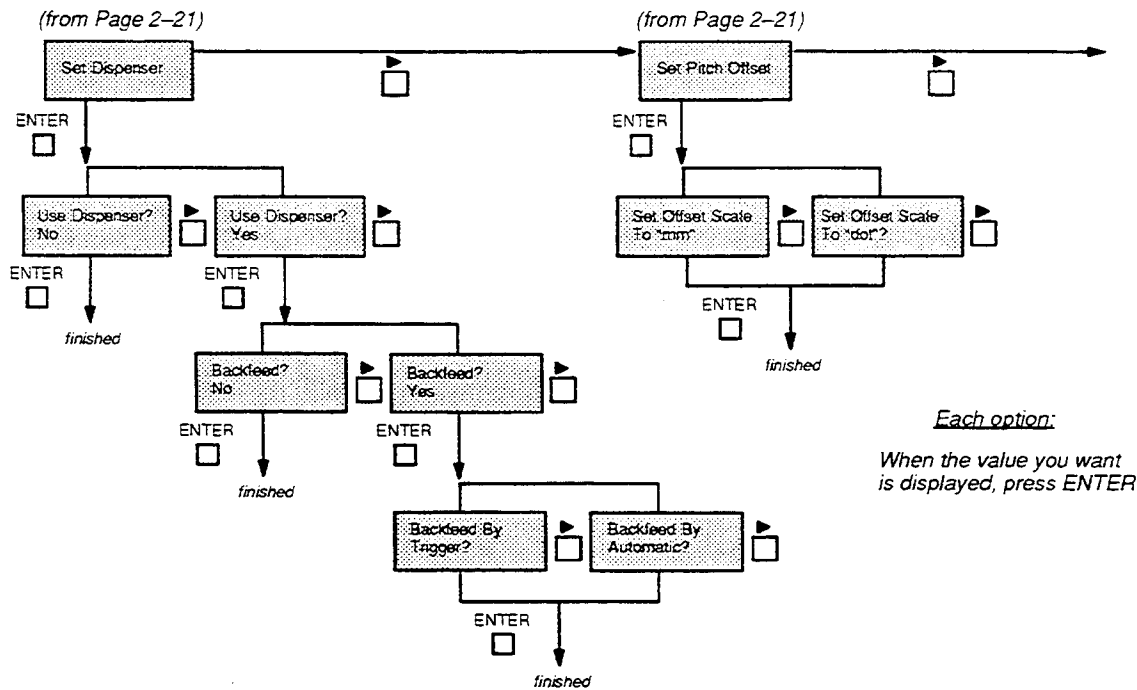

Option	Definition/Purpose	Values/Settings
<b>Dispenser</b>	<p>To indicate the use of the label dispenser option, which peels the backing from the labels for immediate placement.</p> <p><b>Note:</b> The M-8400 Dispenser is an option to the printer and must be installed before enabling this feature. See the Programmer and Technical Reference Manual, Appendix E.</p> <p>For more details on <b>Automatic Backfeed</b>, see Section 2 (Interface Specifications), of the Programmer and Technical Reference Manual.</p>	<p><b>No*</b> – Disables use of Dispenser  <b>Yes</b> – Enables use of Dispenser</p>
		<p style="text-align: center;">If yes, Backfeed?</p> <p><b>No</b> – Disables backfeed  <b>Yes</b> – Enables backfeed</p>
		<p style="text-align: center;">If yes:</p> <p><b>Trigger</b> – Backfeed and printing of next label is triggered by the removal of the current label  <b>Automatic</b> – Backfeed and printing of next label is based on a signal from an external device attached to the Accessory connector</p>
<b>Pitch Offset</b>	To indicate the type of scale for the pitch offset option in the User Mode (Mode U).	<p><b>“mm” scale*</b>  <b>“dot” scale</b></p>

\* SATO Factory Default

## Mode S: VH Offset, Head Check & Loopback Test

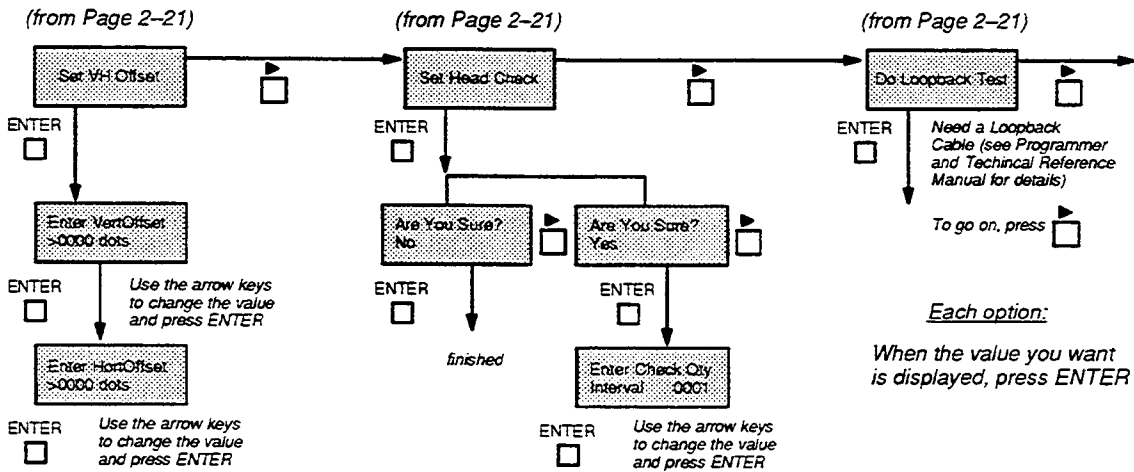

Option	Definition/Purpose	Values/Settings
<b>VH Offset</b>	To adjust the print area in both vertical and horizontal directions. This may be useful for various preprinted stock.	Vertical: 0000*–1424 Horizontal: 0000*–0832
<b>Head Check</b>	To allow the printer to monitor the print head for any problems. If this option is enabled, the user then must enter an interval of the number of labels printed between every print head check.	<b>No*</b> – Disables head check <b>Yes</b> – Enables head check
		If Yes: Check Interval: 0001* – 9999
<b>Loopback Test</b>	To check the printer's RS232 interface before attaching to the host. Must use a special connector. For more details, see Section 2, Interface Specifications, of the Programmer and Technical Reference Manual.	N/A

\* SATO Factory Default

## Mode S: SATO Defaults & User Defaults

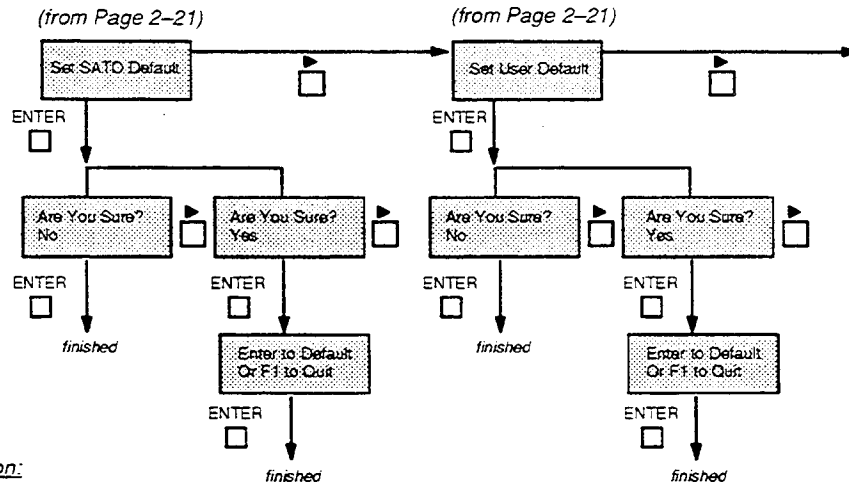

Each option:  
When the value you want is displayed, press ENTER

Option	Definition/Purpose	Values/Settings
<p><b>SATO Defaults</b></p>	<p>To set all current configuration options back to SATO <b>factory</b> defaults. <i>These are different from the user-programmed defaults in the next option.</i></p> <p><b>Note:</b> The SATO factory defaults are indicated by asterisks (*) throughout the configuration section.</p>	<p><b>No*</b> – Does not change current configuration  <b>Yes</b> – Resets configuration to factory default</p>
<p><b>User Defaults</b></p>	<p>To set all current configuration options to <b>user programmed</b> defaults. The User Default Configuration is a storage area on the printer used for holding a printer configuration designed especially for the end user's application environment. The user defaults can be stored by sending a short program to the printer (see the Programmer and Technical Reference Manual, Appendix D). The defaults can then be placed into the current configuration by selecting this option.</p>	<p><b>No*</b> – Does not change current configuration  <b>Yes</b> – Resets configuration to the user default</p>

\* SATO Factory Default

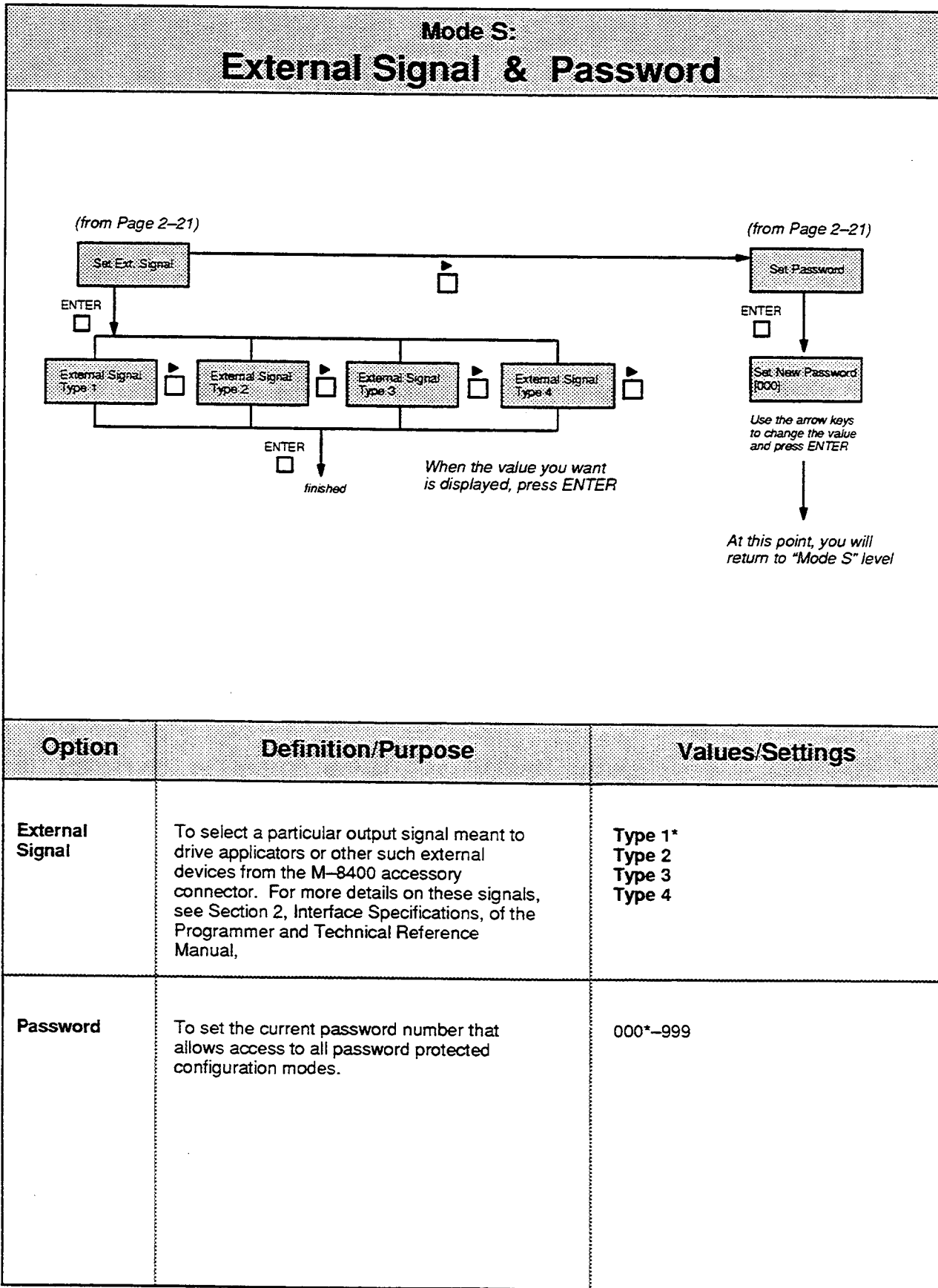

\* SATO Factory Default



## Counter Mode (A Display Only Mode)

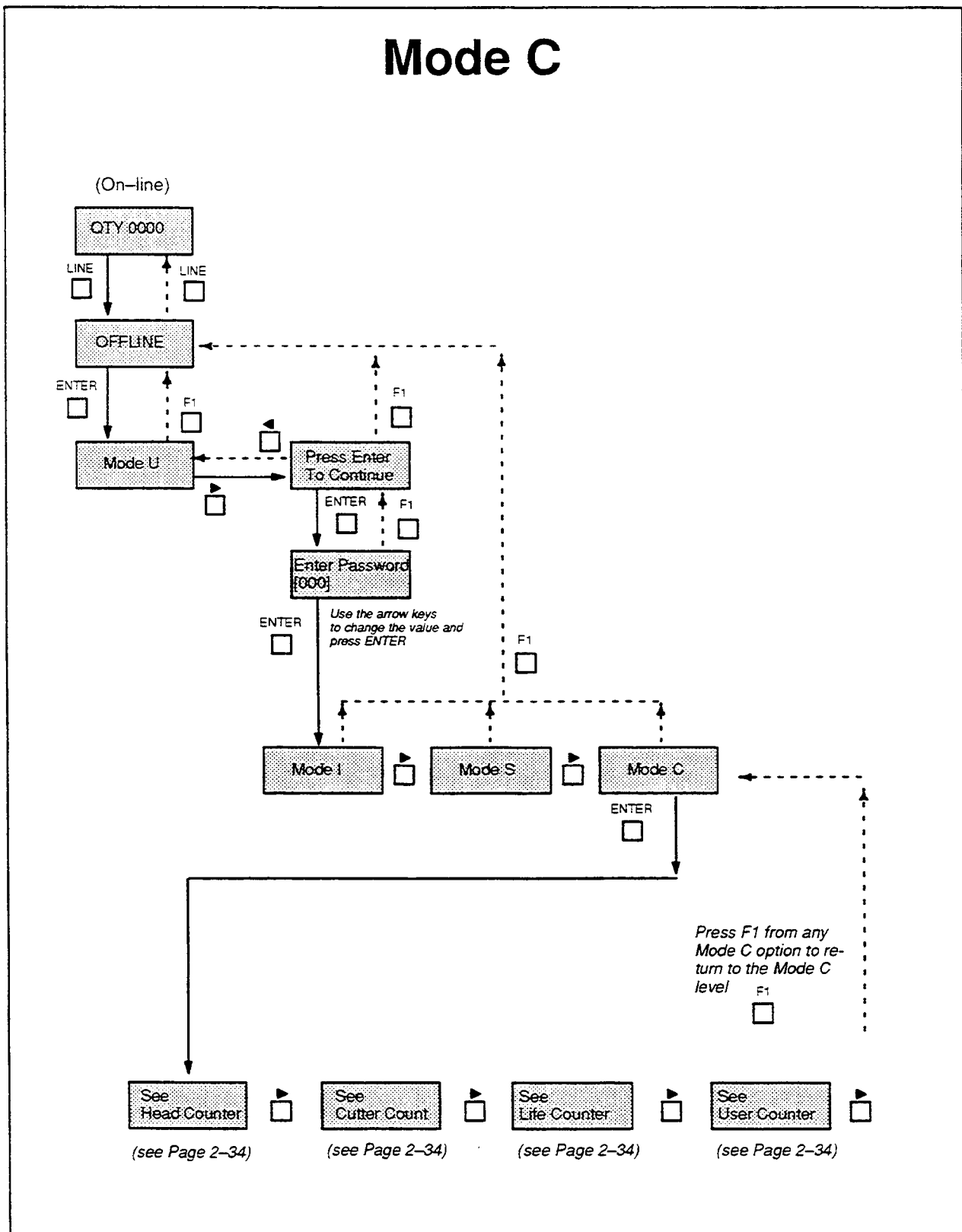

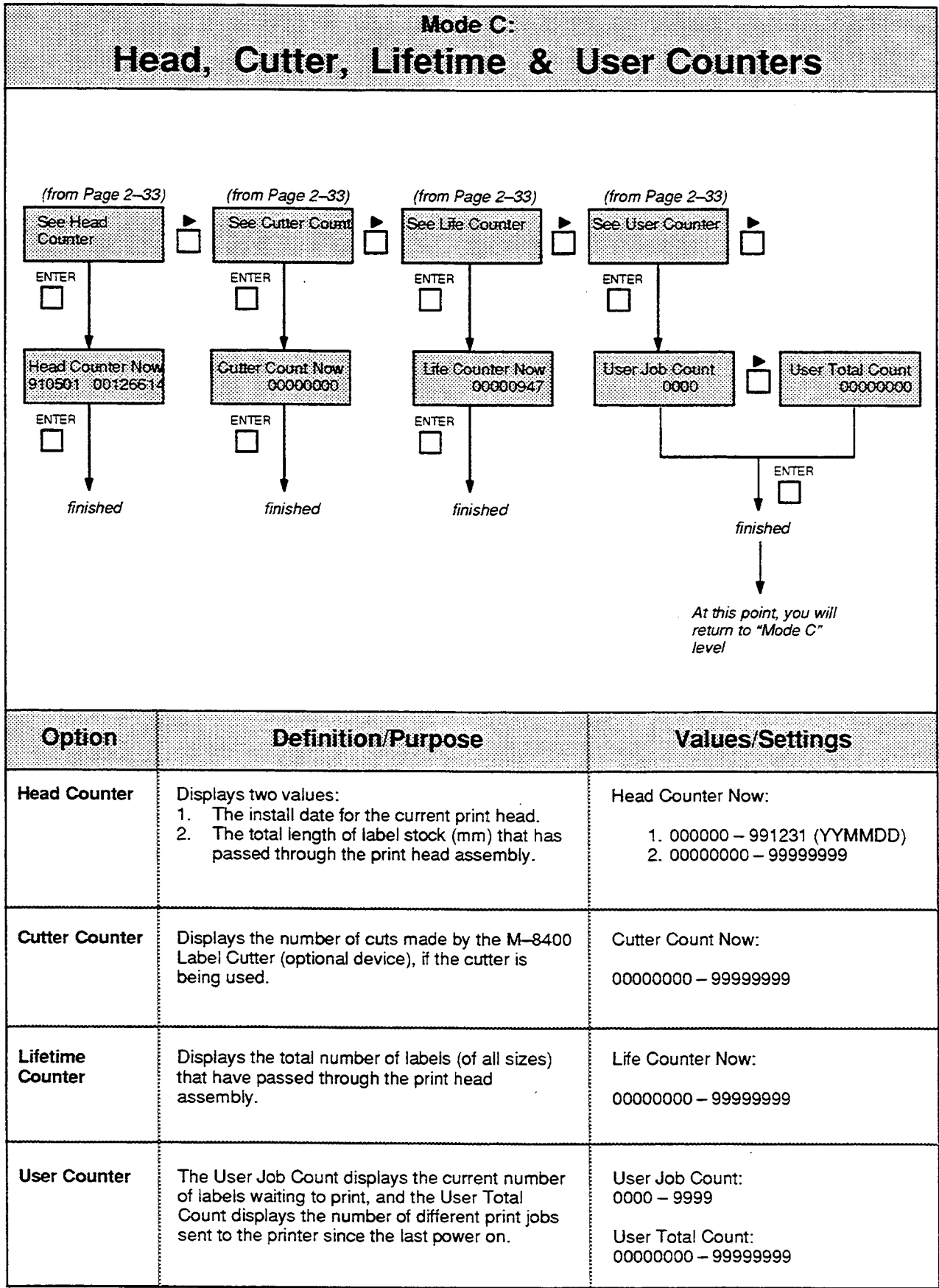

## Memory Card Mode

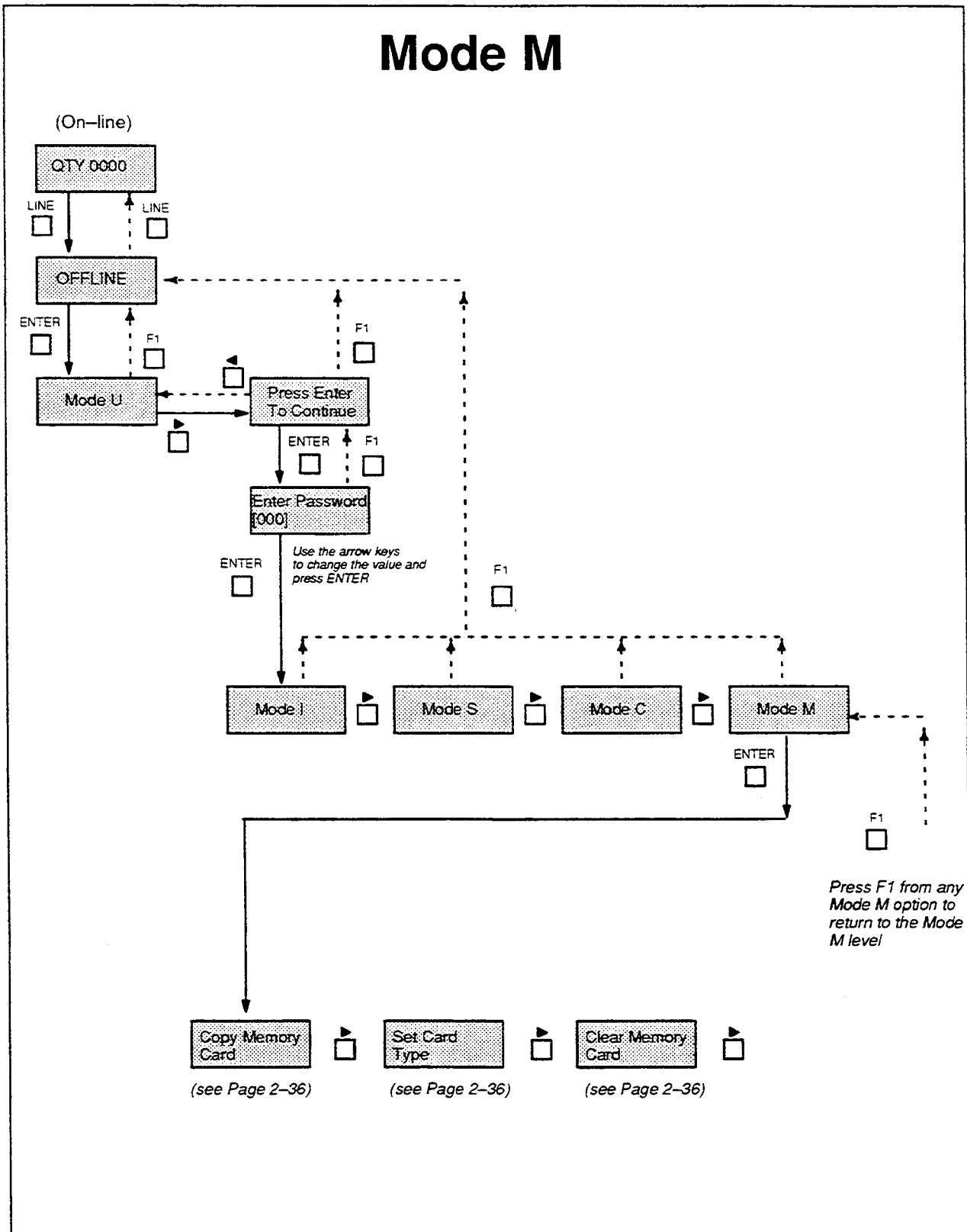

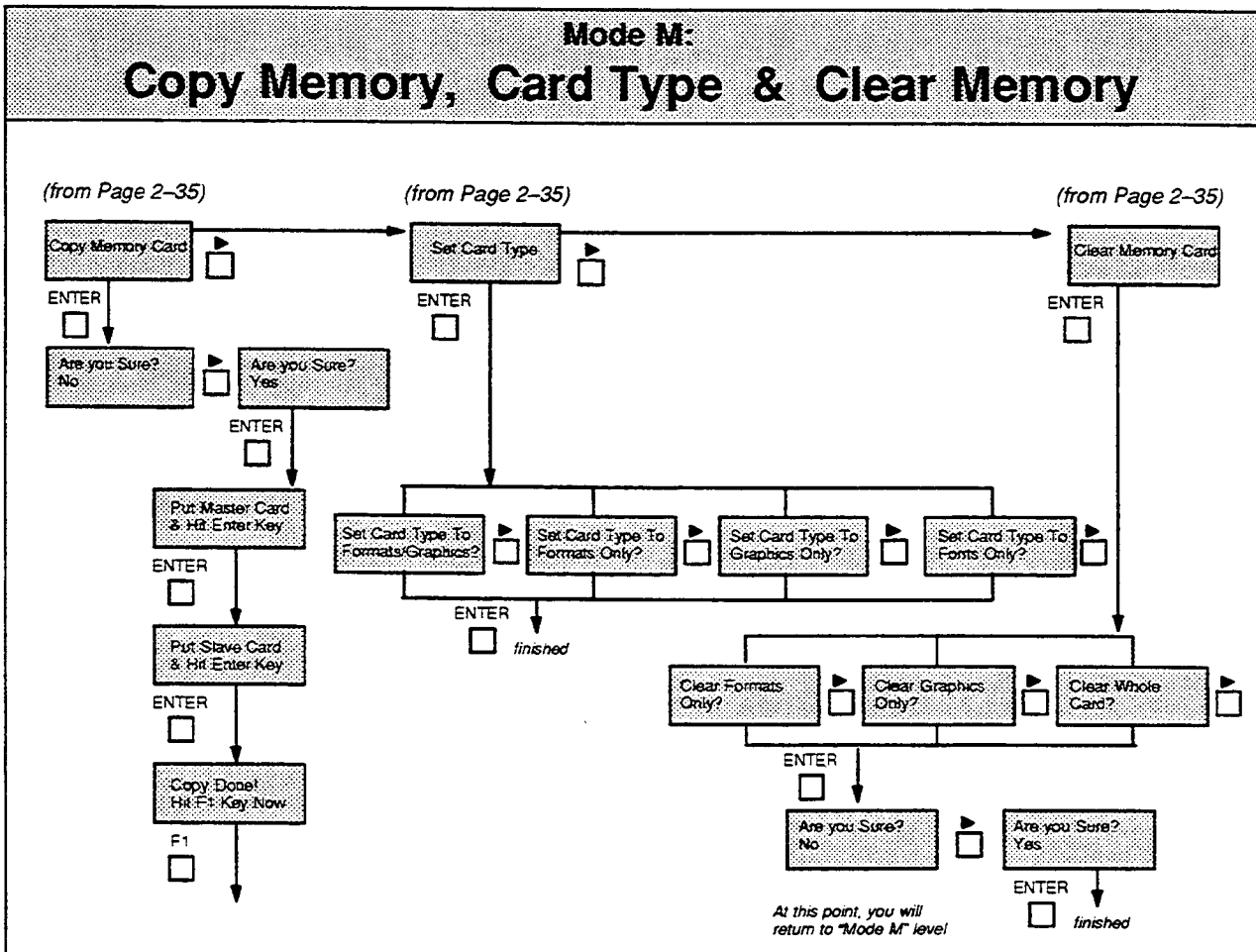

Option	Definition/Purpose	Values/Settings
<b>Copy Memory Card</b>	To allow data to be copied from one memory card to another.  <b>Note:</b> The M-8400 memory card is an optional feature used to provide additional storage for label formats, graphic images, or downloaded fonts.	<b>No*</b> – Does not select memory card copy <b>Yes</b> – Selects memory card copy
		If yes:  Load the master memory card, and press ENTER. Then load the blank memory card, and press ENTER.
<b>Set Card Type</b>	To indicate how the optional memory card will be formatted to properly store and recall data.	<b>Formats &amp; Graphics*</b> – Card used to store label formats and custom graphic images <b>Formats Only</b> – Stores label formats only <b>Graphics Only</b> – Stores graphic images only <b>Fonts Only</b> – Card used to store downloaded fonts
<b>Clear Memory Card</b>	To allow stored data to be cleared from the optional memory card.	<b>Clear Formats Only*</b> – Clears label format data <b>Clear Graphics Only</b> – Clears custom graphic images <b>Clear Whole Card</b> – Clears all stored data from card

\* SATO Factory Default

Test Print Mode

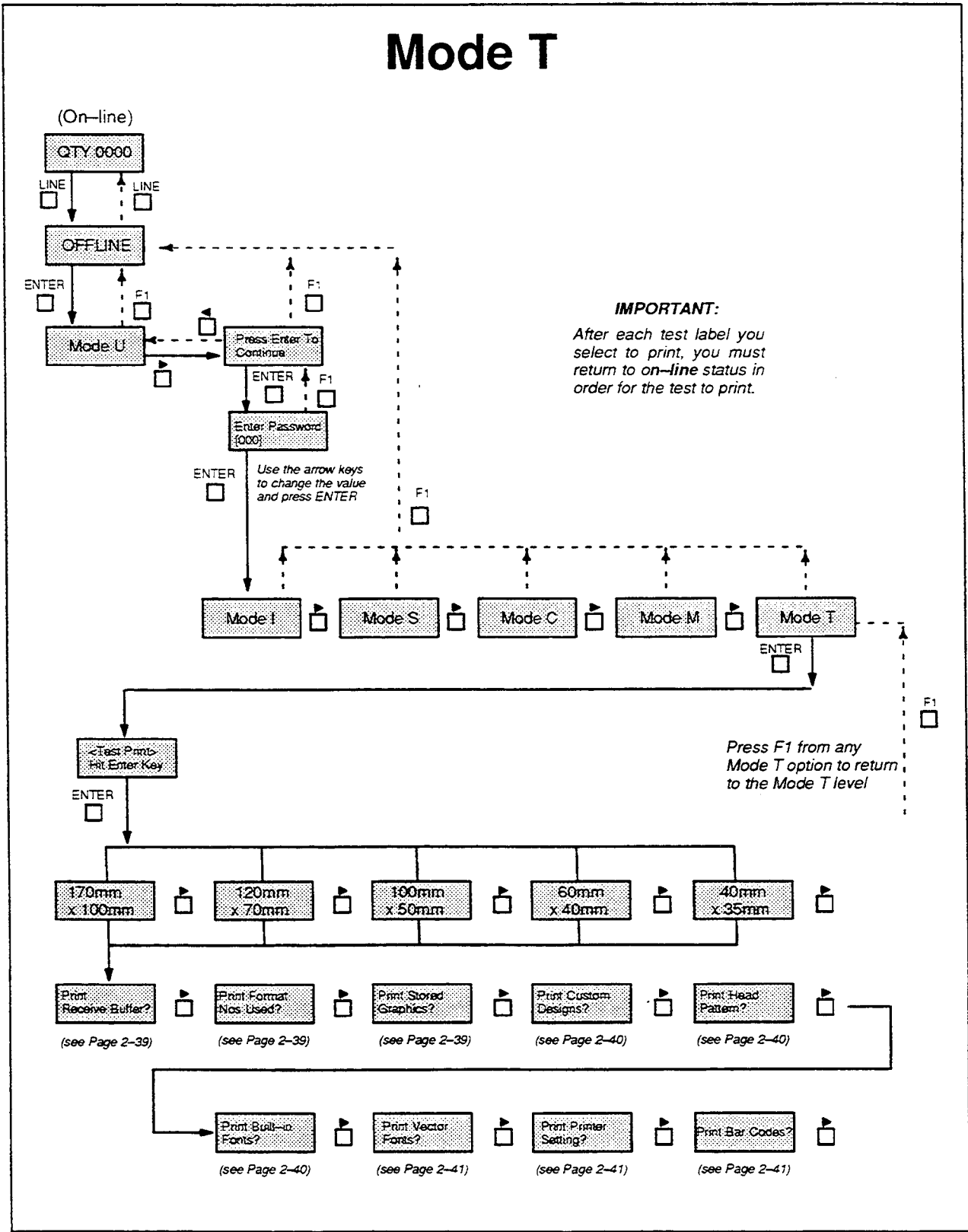

### Important Notes About Using Mode T

Mode T is not operational when using non-standard proto-codes. The printer must be set to Standard proto-codes (using Mode I) for these test print options to work properly. If your application currently uses the Non-standard proto-code set, temporarily set the proto-codes to Standard to use the test print options, then set the proto-codes back to Non-standard when you are finished testing.

The tests in this section are printed only when the printer is placed back on-line. In other words, after using a *single* Mode T option, you must return back to the on-line status (after each option) in order for the test to print. You can return to on-line status using the F1 keys first until the LCD displays “OFF-LINE”. Then press LINE, and your test should print. After the selected test print has completed, the printer is again able to process your normal print jobs.

**Mode T:  
Label Size**

(from Page 2-37)

```

graph TD
    A[170mm x 100mm] --- B[120mm x 70mm]
    B --- C[100mm x 50mm]
    C --- D[60mm x 40mm]
    D --- E[40mm x 35mm]
    C -- ENTER --> F[Test Print Options]
            
```

(see Page 2-39)

Option	Definition/Purpose	Values/Settings
(Label Size)	To indicate the size of the test print area on the label. Choose a size that will fit within the boundaries of your current label stock to avoid damaging the print head.	170mm x 100mm* – 7" length x 4" width 120mm x 70mm – 4.75" length x 2.75" width 100mm x 50mm – 4" length x 2" width 60mm x 40mm – 2.5" length x 1.75" width 40mm x 35mm – 1.75" length x 1.5" width

\* SATO Factory Default

**Mode T:**  
**Receive Buffer, Format Numbers & Stored Graphics**

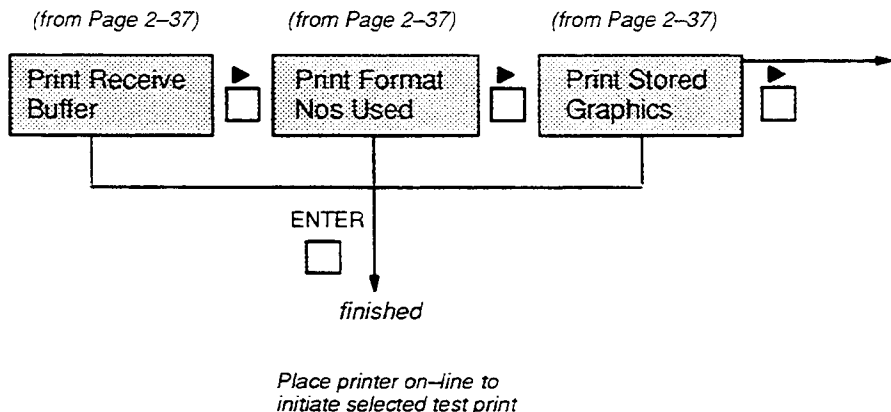

Option	Definition/Purpose	Values/Settings
<p><b>Receive Buffer</b></p>	<p>To allow you to receive a printout of the exact data received by the printer in hexadecimal format. This is equivalent to a "hex dump" and is typically used as a debugging tool. To use this option, select it here in the configuration, then put the printer back on-line. The quantity should display "0001" on the front panel. Send your data stream from your host in the normal fashion. The M-8400 should then print your data stream as a hexadecimal printout to be analyzed.</p> <p><b>Note 1:</b> Remember that the printer must be set for the <b>standard</b> proto-codes (Mode I) for this option to work properly.</p> <p><b>Note 2:</b> Sometimes the receive buffer will contain random characters, which print upon selecting this option. If this occurs, reselect this option and then send your data stream.</p> <p><b>Note 3:</b> This option must be reselected for each print job you want to analyze.</p>	<p>N/A</p>
<p><b>Format Numbers</b></p>	<p>To print the memory locations where jobs have been stored on the optional memory card.</p>	<p>N/A</p>
<p><b>Stored Graphics</b></p>	<p>To print all custom graphics that have been stored on the optional memory card.</p>	<p>N/A</p>

\* SATO Factory Default

**Mode T:**  
**Custom Designs, Head Pattern & Built-in Fonts**

(from Page 2-37)      (from Page 2-37)      (from Page 2-37)

```

graph TD
    A["(from Page 2-37)  
Print Custom Designs  
ENTER [ ]"] --> B["(from Page 2-37)  
Print Head Pattern  
ENTER [ ]"]
    B --> C["(from Page 2-37)  
Print Built-in Fonts  
ENTER [ ]"]
    B --> D["Enter Print Qty  
0001  
ENTER [ ]"]
    D --> E["finished"]
    A --> F["finished"]
    C --> G["finished"]
    
```

*Place printer on-line to initiate selected test print*

Option	Definition/Purpose	Values/Settings
Custom Designs	To print all custom characters that have been stored in memory.	N/A
Head Pattern	To print a test pattern using all of the print head elements. Also shows the printer's firmware level and the printer's current date/time.	Qty Required: 0001* – 9999
Built-in Fonts	To print a test pattern of the seven built-in printer fonts (U, S, M, OA, OB, WB, and WL).	N/A

\* SATO Factory Default



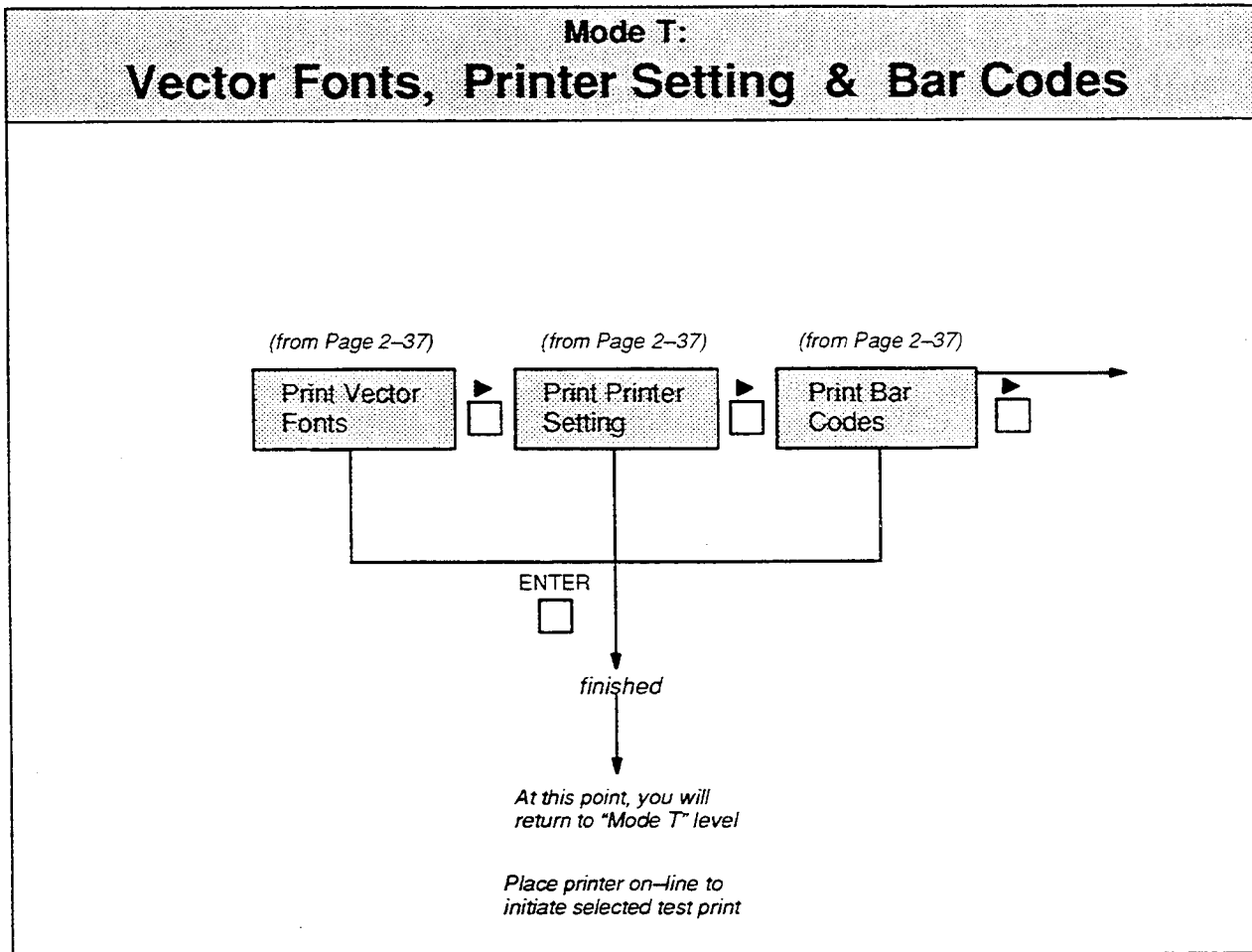

Option	Definition/Purpose	Values/Settings
Vector Fonts	To print a test pattern of the SATO vector font.	N/A
Printer Setting	To print a list of the current printer configuration settings.	N/A
Bar Codes	To print a sample of the bar code capabilities.	N/A

\* SATO Factory Default

## Watch Mode

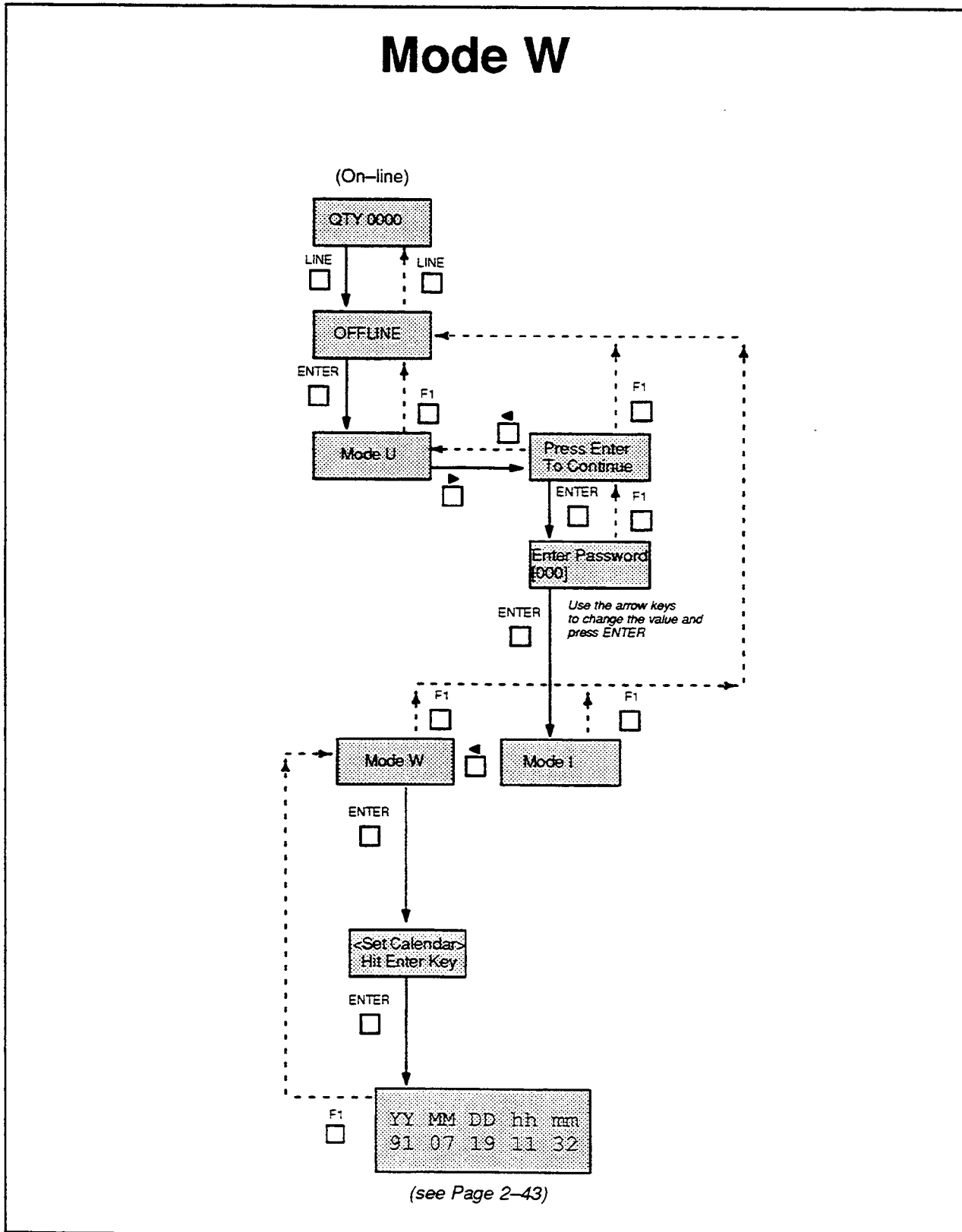

**Mode W:**  
**YY MM DD hh mm**

(from Page 2-42)

YY MM DD hh mm  
91 07 19 11 32



Press either arrow key to change the values for each unit: year, month, day, hour, and minute.



When the value you want for each unit is displayed, press Enter to set it and progress to the next unit.

After setting the last unit, you will return to "Mode W" level

Option	Definition/Purpose	Values/Settings
YY	To set the year on the printer's internal clock.	00 – 99
MM	To set the month on the printer's internal clock.	00 – 12
DD	To set the day on the printer's internal clock.	00 – 31
hh	To set the hour on the printer's internal clock.	00 – 23
mm	To set the minute on the printer's internal clock.	00 – 59

\* SATO Factory Default

## How to Enable Certain Printer Configuration Settings

When changing certain printer settings, it is required that the printer be repowered or label stock be fed in order for the new setting to be enabled (i.e., activated). The following chart displays which settings are affected by this requirement:

Mode	Setting	Requirement	
		Repower Printer	Feed a Label
U	Pitch Offset		X
I	Interface	X	
	Baud Rate	X	
	Stop Bits	X	
	Parity	X	
	Data Bit Length	X	
	Protocol	X	
	Multi-Drop Address	X	
	Receive Buffer Size	X	
	Proto-Codes	X	
S	Sensor		X
	Pitch Detect		X
	Print Method		X
	Ribbon Saver	X	
	Cutter Mode		X
	Dispenser		X
	Pitch Offset (mm, dot)		X
	VH Offset	X	
	SATO Default	X	
	User Default	X	
	Dispenser Backfeed		X

## SECTION 3

# CLEANING AND MAINTENANCE

### INTRODUCTION

---

The following information is presented in this section:

- Adjusting the Print Quality (Darkness)
- Cleaning the Print Head, Platen, and Rollers
- Replacing the Print Head
- Replacing the Fuse

### ADJUSTING THE PRINT QUALITY (DARKNESS)

---

One of the nice features of the SATO M-8400 is its high print quality. The M-8400 is equipped with a few different adjustments for print darkness. It is important to find a proper print darkness level based on your particular label and ribbon combination. The printed images should not be too light nor should the carbon “bleed”. The edges of each image should be crisp and defined.

There are two methods for setting the print darkness on the M-8400:

- (1) Through the printer configuration (Mode U)
- (2) Through software using the Print Darkness command code

The Set Print Darkness option under Mode U of the printer configuration allows a range of 5 values (1 is the lightest; 5 is the darkest). This is your primary adjustment for print quality and should provide you with enough flexibility in finding the proper darkness.

The Print Darkness command code provides control of the darkness on an individual label basis. For more details on this command, see Section 1 (M-8400 Programming) of the Programmer and Technical Reference Manual.

**Note:** Although it is rarely needed, in the event that you require more control in finding your darkness setting, you can use the print adjustment (identified as PRINT) on the operator (front) panel (see Section 1). Use a small flathead screwdriver, turning right for darker print and left for lighter print.

## CLEANING THE PRINT HEAD, PLATEN, AND ROLLERS

---

**Supplies needed:**

- SATO SA070 Cleaning Kit  
(or equivalent)

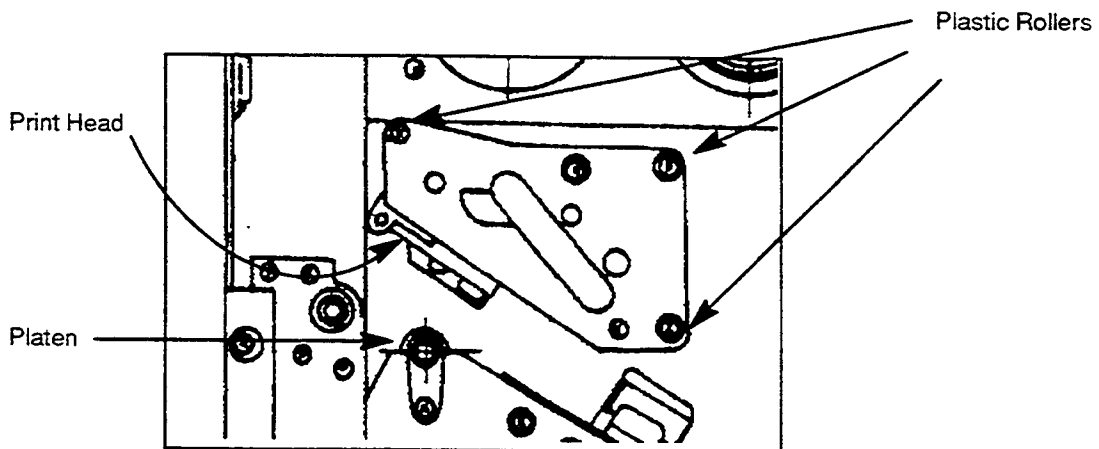
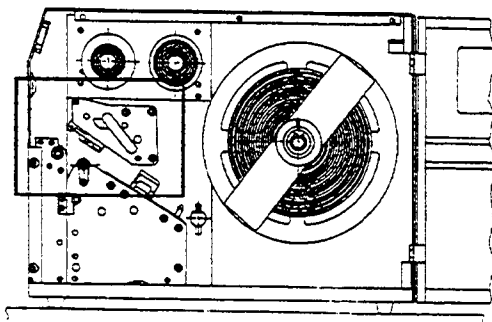

**Cleaning the Printhead**

<b><u>Step</u></b>	<b><u>Action</u></b>
1	Power off the printer.
2	Open the printer side and top doors.
3	Open the print head assembly using the lever on the side of the assembly.
4	Apply SATO Thermal Print Head Cleaner to a cotton swab.
5	The print head faces downward along the front edge of the assembly. Pass the end of the dampened swab along the entire width of the print head. (You may need to move the ribbon out of the way to accomplish this.)
6	Check for any black or adhesive on the swab after cleaning.
7	Repeat if necessary. The print head should be cleaned at least every time the ribbon is changed.

**Cleaning the Platen and Rollers**

<b><u>Step</u></b>	<b><u>Action</u></b>
1	Power off the printer.
2	Open the printer side and top doors.
3	Open the print head assembly using the lever on the side of the assembly.
4	Apply SATO Platen Cleaner to one of the clean wipes.
5	The platen is the rubber roller directly below the print head. It should be cleaned of any ribbon or label residue.
6	Note the (3) plastic rollers at the corners of the print head assembly and clean these as well.  (It may be necessary to temporarily move the ribbon to clean those areas.)
7	Repeat if necessary. The platen and rollers should be cleaned whenever foreign matter such as dust or adhesive is present.

## REPLACING THE PRINT HEAD

The print head on the M-8400 is a user-replaceable item. If it becomes damaged for any reason, it can be easily removed and replaced. Contact your local SATO representative for information on obtaining a new print head.

**Supplies needed:**

No. 2 Phillips Screwdriver (a magnetic tip is helpful)

<u>Step</u>	<u>Action</u>
1	Power off the printer.
2	Open the printer side and top doors.
3	Remove the label cover assembly by removing the securing screw from the assembly.

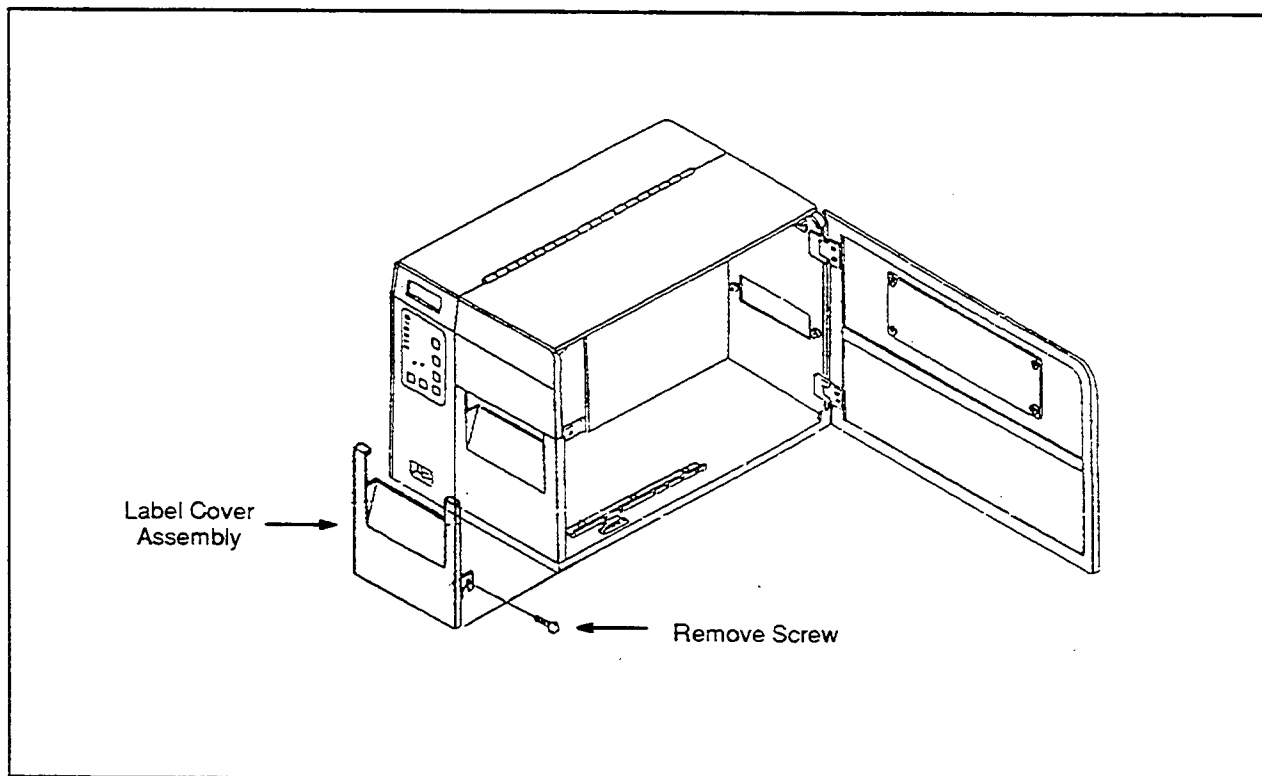



Step	Action
4	Open the print head assembly using the lever on the side of the assembly.
5	Remove the ribbon from the unwind spindle if necessary.
6	View the print head assembly from the front of the printer. Locate the first set of screws on the top of the assembly, from the front edge.
7	Unscrew these two screws and set them aside along with the corresponding positioning collars. (Before removing the positioning collars and screws, note the direction of the “dots” on the flat of each positioning collar. When the collars are replaced, they must be installed with the “dots” facing in the same direction as when they are removed.)
8	The print head should now be loosened from the top of the assembly by grasping it on either side, and carefully pulling it forward until it releases from the connector attached to its back edge. Set the print head aside. (Continued on the next page . . .)

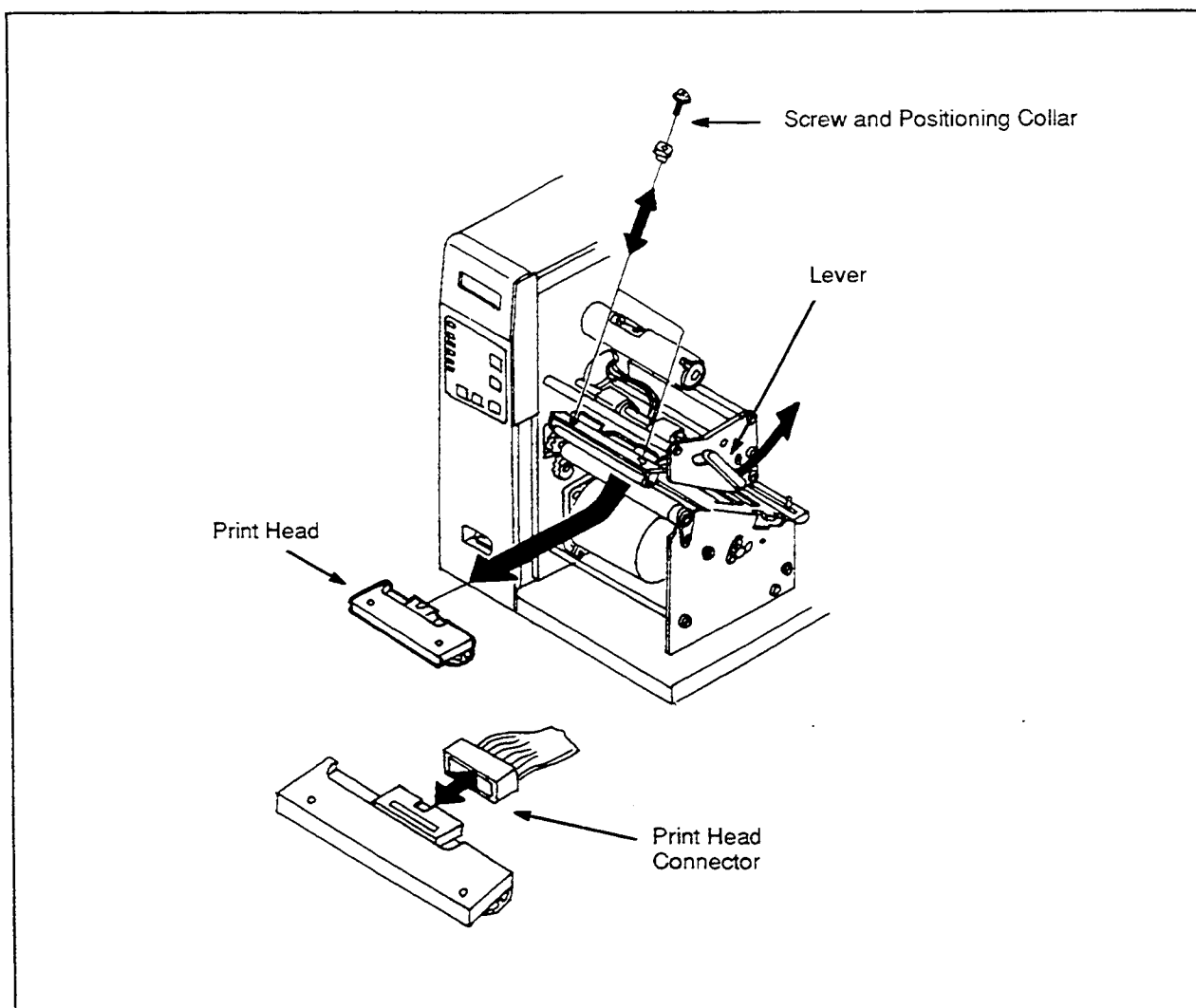

<u>Step</u>	<u>Action</u>
9	Carefully attach the new print head to the connector.  <b>NOTE: Be very careful not to scratch the printing surface of the print head when installing. Scratching the surface will cause permanent and irreparable damage!!</b>
10	Locate the screws and positioning collars and replace them through the top of the print head assembly, making sure the dots on the positioning collars are in the same orientation they were before they were removed. Re-secure the print head by tightening the screws.
11	Reattach the label cover that was removed in Step 3.

## REPLACING THE FUSE

---

### Supplies needed:

- 250V 3A Fuse

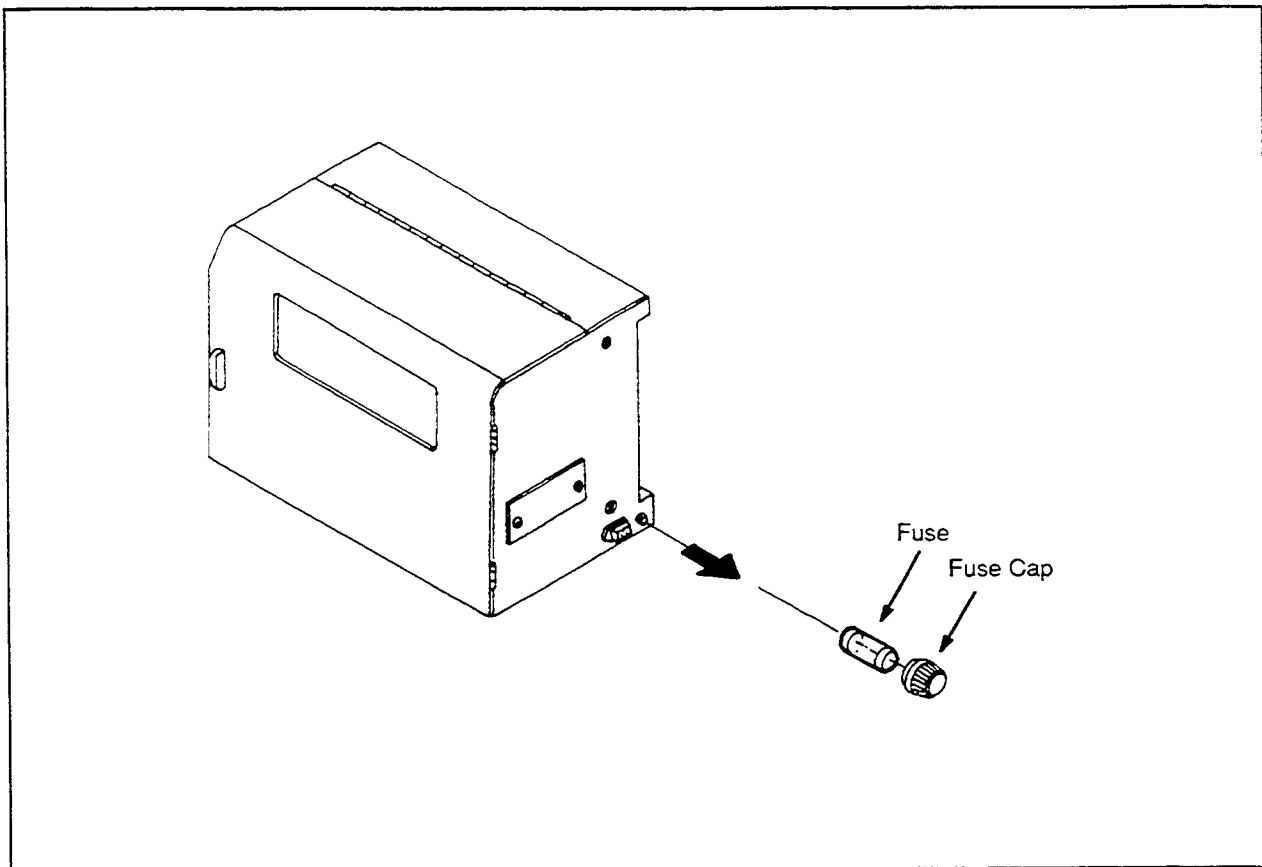

<b>Step</b>	<b>Action</b>
1	Power off the printer.
2	On the back of the printer, locate the fuse cap at the bottom right corner.
3	Unscrew the cap and remove the defective fuse.
4	Take (1) 250V 3A fuse and replace it into the cap.
5	Screw the cap back into the printer.

# INDEX

---

## A

Arrow Keys, Operator Panel, 2-8

## B

Bar Codes, Test Printing, 2-37, 2-41

Baud Rate, Setting the, 2-19

Built-in Fonts, Test Printing, 2-37, 2-40

## C

Carbon Saving, Setting the, 2-21, 2-28

Centronics Parallel, Mode I, 2-19

Character Codes, Setting the, 2-17

Cleaning and Maintenance, 3-1

Coax Interface, 1-3

Configuration, 2-9

Flowchart, 2-10

List of Modes, 2-9

Mode U, 2-14

Modes I, S, C, M, T & W, 2-16

Password Protected Modes

Counter, 2-33—2-34

Interface, 2-17—2-20

Memory Card, 2-35—2-36

Service and Accessory, 2-21—2-32

Test Print, 2-37—2-44

Watch (Time), 2-42

Counter Mode, Configuration, 2-9, 2-33—2-34

Cursor (Arrow) Keys, Operator Panel, 2-8

Custom Designs, Test Printing, 2-37, 2-40

Cutter, 1-3

Setting the, 2-21, 2-28

Cutter Count, Display, 2-33, 2-34

## D

Data Bits, Setting the, 2-19

Date/Time

Set Day, 2-42

Set Hour, 2-42

Set Minute, 2-42

Set Month, 2-42

Set Year, 2-42

Defaults

Returning to SATO, 2-21, 2-31

Returning to User, 2-21, 2-31

Direct Thermal Mode, 2-26

Dispenser, 1-3

Setting the, 2-21, 2-29

Display Adjustment, Operator Panel, 2-8

Dot Scale, Determining Label Length, 2-27

## E

Enter Key, Operator Panel, 2-8

Error Light, Operator Panel, 2-8

External Signal, Setting the, 2-21, 2-32

## F

F1 Key, Operator Panel, 2-8

Feed Key, Operator Panel, 2-8

Format Numbers Used, Test Printing, 2-37, 2-39

Fuse, Replacing the, 3-7

## H

Head Check, Setting the, 2-21, 2-30

Head Count, Display, 2-33, 2-34

Head Pattern, Test Printing, 2-37, 2-40

Hex Dump, 2-39

## I

- Installation and Configuration, 2-1
- Interface Mode, Configuration, 2-9, 2-17—2-20
- Interface Type, Setting the, 2-17, 2-18

## L

- Label Cutter, 1-3
  - Setting the, 2-21, 2-28
- Label Dispenser, 1-3
  - Setting the, 2-21, 2-29
- Label Out Light, Operator Panel, 2-8
- Label Rewinder, 1-3
- Label Sensor, Setting/Adjusting the, 2-22, 2-23
- Label Size
  - Test Print Mode, 2-37, 2-38
  - Test Printing, 2-38
- Labels and Ribbon, Loading the, 2-24—2-26
- Labels or Tags, Loading the, 2-4—2-5
- LCD Display, Operator Panel, 2-8
- Lifetime Count, Display, 2-33, 2-34
- Line Select Key, Operator Panel, 2-8
- Loopback Test, Running the, 2-21, 2-30

## M

- Memory Card
  - Clearing the, 2-35, 2-36
  - Copying, 2-35, 2-36
- Memory Card Mode, Configuration, 2-35—2-36
- Memory Card Type, Setting the, 2-35, 2-36
- Memory Mode, Configuration, 2-9
- Memory Module, 1-3
- Mode C, Configuration, 2-9, 2-33—2-34
- Mode I, Configuration, 2-9, 2-17—2-20
- Mode M, Configuration, 2-9, 2-35—2-36
- Mode S, Configuration, 2-9, 2-21—2-32
- Mode T
  - and Non-Standard Proto-Codes, 2-38
  - and On-line Status, 2-38
  - Configuration, 2-9, 2-37—2-44

- Mode U, Configuration, 2-11, 2-14
- Mode W, Configuration, 2-9, 2-42

## O

- On-line Light, Operator Panel, 2-8
- On-line/Off-line, Operator Panel, 2-8, 2-10
- OPCB, 1-3
- Operator Panel, 2-8
  - and Printer Configuration, 2-9

## P

- Parity, Setting the, 2-19
- Password, Setting or changing the, 2-21, 2-32
- Password Protected Configuration Modes, 2-16
  - See also Modes I, S, C, M, T & W
- Pitch Detection, Setting the, 2-21, 2-26
- Pitch Offset, Setting the, 2-11, 2-13, 2-21, 2-29
- Platen and Rubber Rollers, Cleaning the, 3-2—3-3
- Power Light, Operator Panel, 2-8
- Print Adjustment, Operator Panel, 2-8
- Print Darkness
  - Operator Panel, 2-8
  - Setting the, 2-11, 2-12
- Print Head
  - Cleaning the, 3-2—3-3
  - Replacing the, 3-4—3-6
- Print Method, Setting the, 2-21, 2-26
- Print Quality, Adjusting the, 3-1
- Print Speed, Setting the, 2-11, 2-13
- Printer
  - Cleaning and Maintenance, 3-1
  - Configuration, 2-9
  - General Specifications, 1-1—1-2
  - Operating Panel, 2-8
  - Optional Features, 1-3
  - Parts Identification, 2-3
  - Setting up the, 2-3
  - Unpacking the, 2-2
- Printer Setting, Test Printing, 2-37, 2-41
- Proto-Codes, Setting the, 2-17, 2-20
- Protocol Type, Setting the, 2-19

## R

Receive Buffer, Test Printing, 2-37, 2-39  
Receive Buffer Size, Setting the, 2-17, 2-20  
Rewinder, 1-3  
Ribbon, Loading the, 2-6—2-7  
Ribbon Out Light, Operator Panel, 2-8  
Ribbon Saver, 1-3  
    Setting the, 2-21, 2-28  
RS232C Serial, Mode I, 2-19

## S

SATO Defaults, Returning to, 2-21, 2-31  
Sensor, Setting the, 2-21, 2-22  
Service Mode, Configuration, 2-9, 2-21—2-32  
Specifications, 1-1—1-2  
Stop Bits, Setting the, 2-19  
Stored Graphics, Test Printing, 2-37, 2-39

## T

Test Print Mode, Configuration, 2-9, 2-37—2-44  
Test Printing  
    Bar Codes, 2-37, 2-41

Built-in Fonts, 2-37, 2-40  
Custom Designs, 2-37, 2-40  
Format Numbers Used, 2-37, 2-39  
Head Pattern, 2-37, 2-40  
Label Size, 2-38  
Printer Setting, 2-37, 2-41  
Receive Buffer, 2-37, 2-39  
Stored Graphics, 2-37, 2-39  
Vector Fonts, 2-37, 2-41  
Thermal Transfer Mode, 2-26  
Threshold, Setting the Sensor, 2-22  
Twinax Interface, 1-3

## U

User Count, Display, 2-33, 2-34  
User Defaults, Returning to, 2-21, 2-31  
User Mode, Configuration, 2-11, 2-14

## V

Vector Fonts, Test Printing, 2-37, 2-41  
VH Offset, Setting the, 2-21, 2-30

## W

Watch (Time) Mode, Configuration, 2-9, 2-42



# **M-8400**

## **Thermal Transfer Printer**

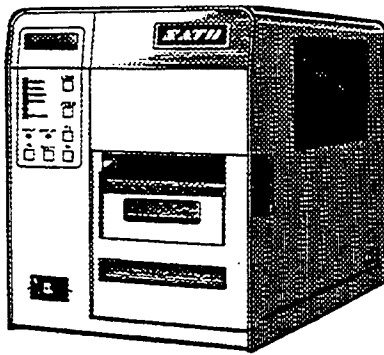

# **Operator's Manual & Programmer and Technical Reference Manual**

*Second Edition*

# PREFACE

## M-8400 OPERATOR'S MANUAL

---

The M-8400 Operator's Manual contains basic information about the printer such as setup, installation, cleaning, and maintenance. It also contains complete instructions on how to use the operator panel to configure the printer. The following is a brief description of each section in this manual:

### SECTION 1: OVERVIEW

This section contains a discussion of the printer specifications and optional features.

### SECTION 2: INSTALLATION AND CONFIGURATION

This section contains instructions on how to unpack and set up the printer, load the labels and ribbon, and use the operator panel to configure the printer.

### SECTION 3: CLEANING AND MAINTENANCE

This section contains instructions on how to clean and maintain the printer.

### INDEX

## M-8400 PROGRAMMER AND TECHNICAL REFERENCE MANUAL

---

The M-8400 Programmer and Technical Reference Manual contains technical information about the printer's programming language and interface. The following is a brief description of each section in this manual:

### SECTION 1: M-8400 PROGRAMMING

This section introduces the SATO M-8400 printer programming language. It contains the commands that are used with the printer to produce labels with bar codes, alphanumeric data, and other graphics.

### SECTION 2: INTERFACE SPECIFICATIONS

This section contains the printer's interface specifications, which includes detailed information on how to properly interface your printer with your host system.

### SECTION 3: TROUBLESHOOTING

This section contains troubleshooting procedures to follow in the event that you have printer problems.



---

## SECTION 1: M-8400 PROGRAMMING (continued)

Replace Data (Partial Edit) .....	1-59
Reverse Image .....	1-61
Rotation – Fixed Base Reference Point .....	1-63
Rotation – Moving Base Reference Point .....	1-65
Sequential Numbering .....	1-67
Start/Stop Label .....	1-69
Store Form Overlay .....	1-71
Store Print Job .....	1-72
Vector Font .....	1-73

---

## SECTION 2: INTERFACE SPECIFICATIONS

Introduction .....	2-1
M-8400 Interface Types .....	2-1
Using the Receive Buffer .....	2-1
RS232C Serial Interface .....	2-2
General Specifications .....	2-2
Electrical Specifications .....	2-2
Pin Assignments .....	2-2
Ready/Busy Protocol .....	2-4
X-ON/X-OFF Protocol .....	2-5
Bi-Directional Communication Protocol .....	2-7
Loop Back Test .....	2-9
Centronics Parallel Interface .....	2-10
Electrical Specifications .....	2-10
Accessory (EXT) Connector .....	2-11
Pin Assignments .....	2-11
External Output Signals .....	2-13

---

## SECTION 3: TROUBLESHOOTING

Initial Checklist .....	3-1
Using the Centronics Interface .....	3-2
Using the RS232C Interface .....	3-3
If the Password is Lost .....	3-4
Setting for Direct Thermal Mode .....	3-5

# Programmer and Technical Reference Manual

## Table of Contents

---

### SECTION 1: M-8400 PROGRAMMING

Introduction .....	1-1
What is the SATO M-8400 Programming Language? .....	1-1
Selecting Proto-Codes .....	1-1
If You Are Using BASIC .....	1-2
Understanding the M-8400 Print Area .....	1-3
Command Codes .....	1-7
Bar Codes .....	1-8
Bar Codes – Variable Ratio .....	1-10
Base Reference Point .....	1-14
Calendar Increment .....	1-16
Calendar Print .....	1-18
Calendar Set .....	1-20
Character Expansion .....	1-21
Character Pitch .....	1-23
Character Tables .....	1-25
Clear Printer Memory & Buffers .....	1-27
Continuous Forms Printing .....	1-28
Copy Image Area .....	1-29
Custom-Designed Characters .....	1-31
Custom Graphics .....	1-32
Custom Graphics – Battery Backed .....	1-33
Cutter Command .....	1-35
Expanded Print Length .....	1-37
Fonts U, S, M, OA, & OB .....	1-38
Fonts WB & WL .....	1-40
Form Feed .....	1-42
Journal Print .....	1-43
Lines and Boxes .....	1-45
Line Feed .....	1-47
Off-line .....	1-49
Print Darkness .....	1-50
Print Position – (Vertical and Horizontal) .....	1-51
Print Quantity .....	1-53
Print Speed Selection .....	1-54
Recall Form Overlay .....	1-55
Recall Print Job .....	1-56
Repeat Label .....	1-58

---

## SECTION 1: M-8400 PROGRAMMING (continued)

Replace Data (Partial Edit) .....	1-59
Reverse Image .....	1-61
Rotation – Fixed Base Reference Point .....	1-63
Rotation – Moving Base Reference Point .....	1-65
Sequential Numbering .....	1-67
Start/Stop Label .....	1-69
Store Form Overlay .....	1-71
Store Print Job .....	1-72
Vector Font .....	1-73

---

## SECTION 2: INTERFACE SPECIFICATIONS

Introduction .....	2-1
M-8400 Interface Types .....	2-1
Using the Receive Buffer .....	2-1
RS232C Serial Interface .....	2-2
General Specifications .....	2-2
Electrical Specifications .....	2-2
Pin Assignments .....	2-2
Ready/Busy Protocol .....	2-4
X-ON/X-OFF Protocol .....	2-5
Bi-Directional Communication Protocol .....	2-7
Loop Back Test .....	2-9
Centronics Parallel Interface .....	2-10
Electrical Specifications .....	2-10
Accessory (EXT) Connector .....	2-11
Pin Assignments .....	2-11
External Output Signals .....	2-13

---

## SECTION 3: TROUBLESHOOTING

Initial Checklist .....	3-1
Using the Centronics Interface .....	3-2
Using the RS232C Interface .....	3-3
If the Password is Lost .....	3-4
Setting for Direct Thermal Mode .....	3-5

# SECTION 1

## M-8400 PROGRAMMING

### INTRODUCTION

---

This section presents the commands that are used with the SATO M-8400 Printer to produce labels with logos, bar codes, and alphanumeric data.

The following information is presented in this section:

- What is the SATO M-8400 Programming Language?
- Selecting Proto-Codes
- If You Are Using BASIC
- Understanding the M-8400 Print Area
- Command Codes

### WHAT IS THE SATO M-8400 PROGRAMMING LANGUAGE?

---

A programming language for a printer may be a new concept for many computer programmers, but it is actually a fairly simple idea. The M-8400 language is really only a group of commands. The commands, which we refer to as Command Codes, contain non-printable ASCII characters (such as <STX>, <ETX>, <ESC>) and printable characters. These commands must be assembled into an organized block of code to be sent as one data stream to the printer, which in turn generates the desired label output. The programmer is free to use any programming language available on his/her computer system to send the data to the attached M-8400.

### SELECTING PROTO-CODES

---

Proto-Codes are special control characters that prepare the M-8400 to receive instruction. For example, the <ESC> character tells the printer that a command code will follow and the <ENQ> character asks for the printer status.

There are two different sets of Proto-Codes to choose from on the M-8400. Each set is made up of (6) special characters. The Standard Proto-Codes are non-printable characters, and the Non-Standard Proto-Codes are printable characters. The Non-Standard set may be useful on host computers using protocol converters or in any application where non-printable ASCII characters cannot be sent from the host. This manual uses the Standard Proto-Codes for all of its examples. See Mode I of the Printer Configuration in Section 2 of the M-8400 Operator's Manual for help in selecting the desired Proto-Code set for your application.

PROTO-CODES			
Control Character	Standard	Non-Standard	Description
STX	02H	7BH = {	Start of data – RS232, 10-job buffer
ETX	03H	7DH = }	End of data – RS232, 10-job buffer
ESC	1BH	5EH = ^	Command code to follow
NULL	00H	7EH = ~	Cutter command
ENQ	05H	40H = @	Get printer status – Bi-directional mode
CAN	18H	21H = !	Cancel print job – Bi-directional mode

## IF YOU ARE USING BASIC

---

It may be useful to test your M-8400 printer using a BASIC program on a PC. You may also write your actual production programs in BASIC. Whatever the reason, if you will be working in BASIC, some of the following hints may help you get started:

1. Set the WIDTH of the output device to 255 characters to avoid automatically sending CR and LF characters after every line.
2. If you are using the printer's RS232 interface, it is necessary to set the COM port on the PC such that the CTS and DSR signals will be ignored. Send your OPEN "COM" statement in the following way:

```
OPEN "COM1:9600, E, 7, 1, CS, DS" AS #1
```

3. You may help to minimize keystrokes and program size by assigning the ESC character to a string variable.

The following two examples in BASIC show use of the hints just provided. Both of these examples assumes use of the Standard Proto-Codes:

```
5   REM M-8400 Parallel Example
10  E$=CHR$(27)
20  WIDTH "LPT1:",255
30  LPRINT E$;"A";
40  LPRINT E$;"H400";E$;"V100";E$;"WL1SAT0";
50  LPRINT E$;"Q1";
60  LPRINT E$;"Z";
```

```

5   REM M-8400 RS232 Example
10  STX$=CHR$(2)
20  ETX$=CHR$(3)
30  E$=CHR$(27)
40  OPEN "COM1:9600,N,8,1,CS,DS" AS #1
50  PRINT #1,STX$;
60  PRINT #1,E$; "A";
70  PRINT #1,E$;"H400";E$;"V100";E$;"WL1SATO";
80  PRINT #1,E$;"Q1";
90  PRINT #1,E$;"Z";
100 PRINT #1,ETX$;

```

## UNDERSTANDING THE M-8400 PRINT AREA

The maximum print area available on the M-8400 is a width of 4.1" and a length of 7" (14" length is optional). Most of your label applications will not have labels this large, therefore, it is important to understand how to work with labels that do not use the entire print area. The goal is to help you avoid printing where no label exists, which may lead to print head damage (not to mention frustration, if you see no printed output on your label).

The diagram below illustrates the M-8400 print area and a sample 2" wide x 3" long label placed within this area. As can be seen, your label will be oriented against the inside left edge of the printer as viewed from the front of the M-8400. The normal base reference point is located at the H1, V1 position of the print area in the normal print orientation (no rotation).

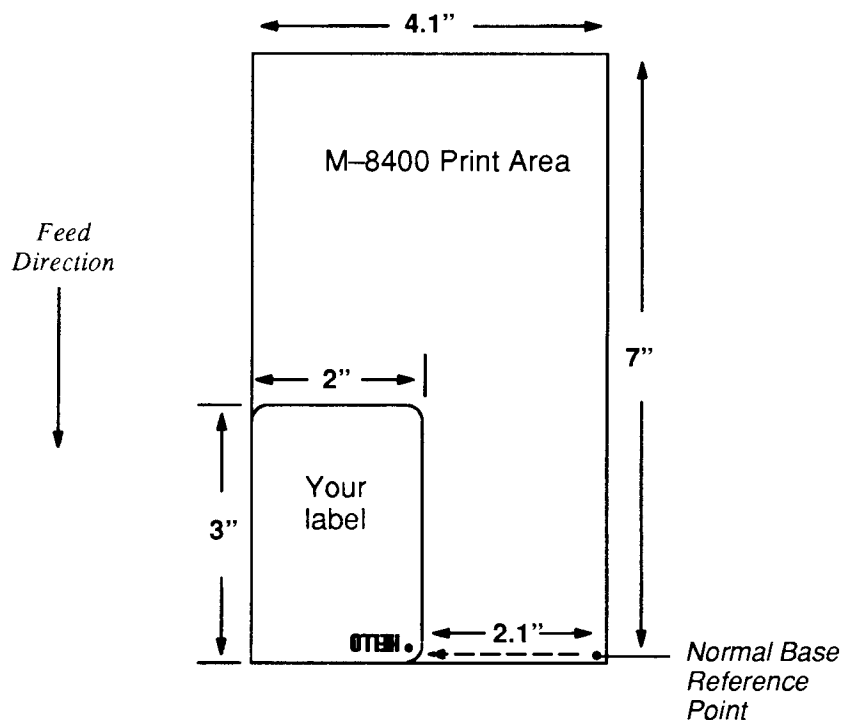

There are two methods available to make sure your printed output will appear correctly on your label. They are as follows:

1. Send the Base Reference Point command as part of your data to the printer to set a new base reference point for your label.

First, calculate the distance (in dots) from the normal base reference point to the closest edge of the label.

$$2.1 \times 25.4 \text{ mm/in} \times 8 \text{ dots/mm} = 427 \text{ dots}$$

Then issue the Base Reference Point command after the Start command in your data stream.

```
<ESC>A3H427V0001
```

2. Use the normal base reference point from the print area and use the horizontal position command for each field to properly locate it on the label.

Calculate the distance (in dots) from the normal base reference point to the closest edge of the label.

$$2.1 \text{ in} \times 25.4 \text{ mm/in} \times 8 \text{ dots/mm} = 427 \text{ dots}$$

Then each <ESC>H command would include 427 dots plus the necessary amount to place the field.

**NOTE:** Substitute 6 dots/mm in the calculation if using the M8400/6 printer.

## Adjusting Our Samples for Your Labels

---

The Command code subsection contains a sample label output for each command code. These samples reflect how the printed information would appear on a 4-inch wide label (see Figure A). If you want to test any of our sample label outputs, and you are using labels that are less than four inches wide (see Figure B), we suggest that you add the Base Reference Point command to the data stream in order for the images to print on your labels.

You must be careful not to print off the label surface. The addition of the Base Reference Point command to the sample data stream may help to adjust the print for your labels. See an example of this on the next two pages or refer to the Base Reference Point command (Page 1-14).

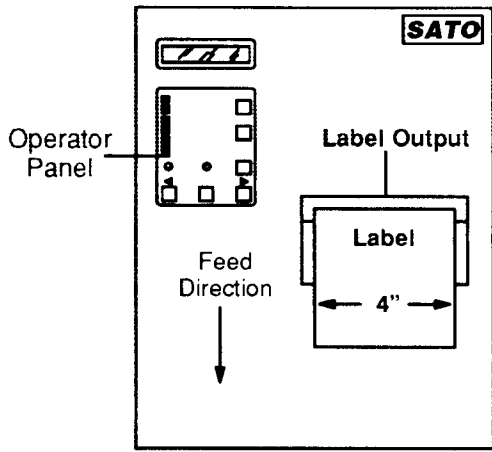

Figure A

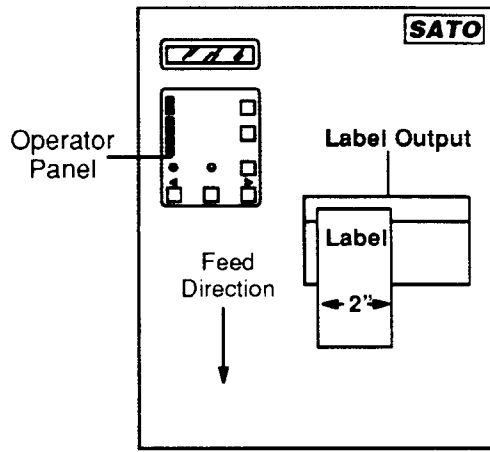
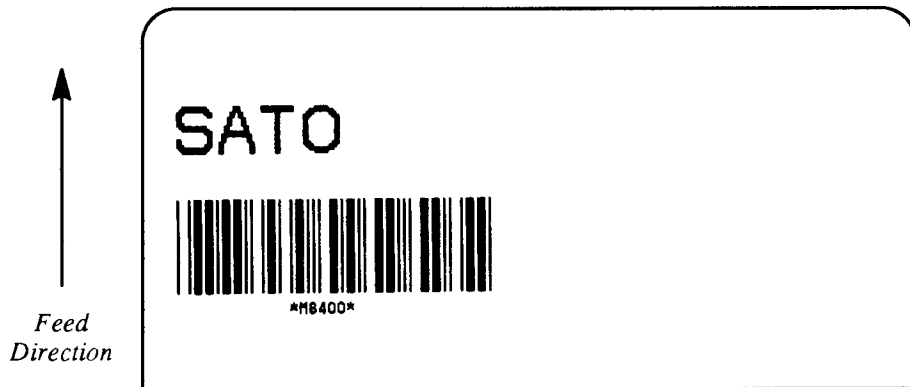

Figure B

For instance, the following illustrates a sample input data stream and output label assuming a 4-inch wide label:

```

<ESC>A
<ESC>H50<ESC>V100<ESC>L0303<ESC>MSATO
<ESC>H50<ESC>V200<ESC>B103100*M8400*
<ESC>H170<ESC>V310<ESC>L0101<ESC>S*M8400*
<ESC>Q1
<ESC>Z
    
```





If you are using a 2-inch wide label, the entire image may not appear on your label. By adding the following Base Reference Point command to the second line of the data stream, the base reference point will be changed, and the image will print on the narrower label:

```

<ESC>A
<ESC>A3H400V0001
<ESC>H50<ESC>V100<ESC>L0303<ESC>MSATO
<ESC>H50<ESC>V200<ESC>B103100*M8400*
<ESC>H170<ESC>V310<ESC>L0101<ESC>S*M8400*
<ESC>Q1
<ESC>Z
    
```

*Image is moved horizontally to the right 400 dots to print on a 2" label.*

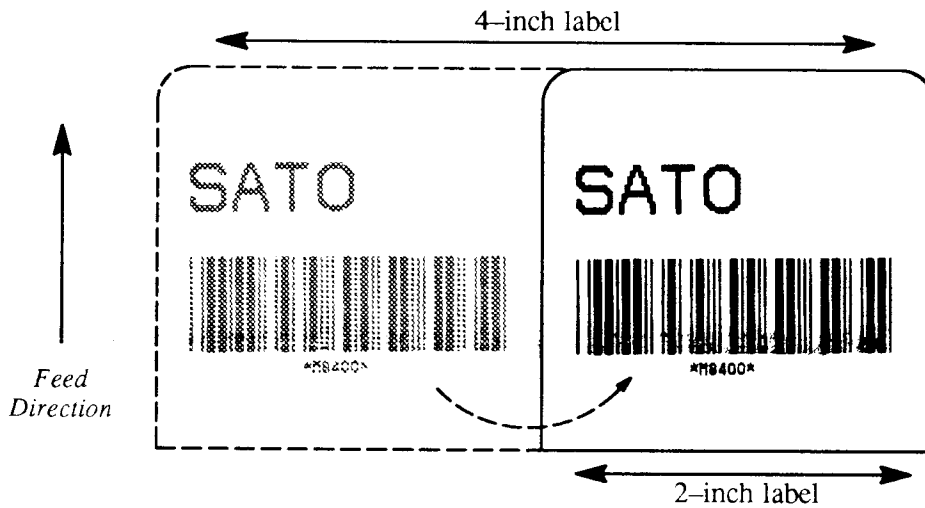

For more information on this, see the Base Reference Point Command (page 1-14).

## COMMAND CODES

---

The next portion of this section contains all the M-8400 printer command codes. The commands must be sent to the printer in an organized fashion in order for your labels to print.

The goal of this command section is twofold:

1. To explain the different commands and provide examples for the new M-8400 programmer.
2. To provide a detailed reference for the advanced M-8400 programmer.

Each command begins on a separate page with its own heading. A uniform layout is used to help you find key information about each command. For each command code in this section, there will be a sample input data stream to the printer and the expected printed output. By studying the examples, you can learn how to use the particular command within a whole block of printer code. **Note that these examples assume use of the Standard Proto-Codes, a parallel interface, and a 4-inch wide label.** Pay particular attention to the “Special Notes” with each command to learn other important information.

**Note:** Appendix A contains a *Command Code Quick Reference Chart*, which lists the codes alphabetically.

---

## Bar Codes

---

**Command Structure**

1:3 narrow/wide bar ratio: <ESC>**Babbccc**  
 2:5 narrow/wide bar ratio: <ESC>**BDabbccc**  
 1:2 narrow/wide bar ratio: <ESC>**Dabbccc**

**a** = Bar Code Symbol

- 0 Codabar
- 1 Code 39
- 2 Interleaved 2 of 5 (I 2/5)
- 3 UPC-A / EAN-13
- 4 EAN-8
- 5 Industrial 2 of 5
- 6 Matrix 2 of 5
- 7 *reserved*
- 8 *reserved*
- 9 Code 128
- A MSI
- B *reserved*
- C Code 93
- D *reserved*
- E UPC-E
- F Bookland
- G Code 128

**bb** = Number of dots (01–12) for narrow bar and narrow space

**ccc** = Bar height in dots (001–600)

**Example:** <ESC>**BD103200**

**Placement:** Immediately preceding data to be encoded

**Default:** None

**Command Function**

To print bar code images on a label. With this command, there are 13 different bar code symbologies available to be printed. Each of the bar codes is unique, and it is important to know the differences. See Appendix B for specific information on using each individual bar code symbol.

**How to Use****Input to Printer:**

```

<ESC>A
<ESC>H100<ESC>V100<ESC>B103100*CODE39*
<ESC>H260<ESC>V205<ESC>S*CODE39*
<ESC>H200<ESC>V300<ESC>D3021500012345678905
<ESC>H180<ESC>V400<ESC>S0<ESC>H400<ESC>S5
<ESC>H220<ESC>V450<ESC>S12345<ESC>H320<ESC>S67890
<ESC>Q1
<ESC>Z

```

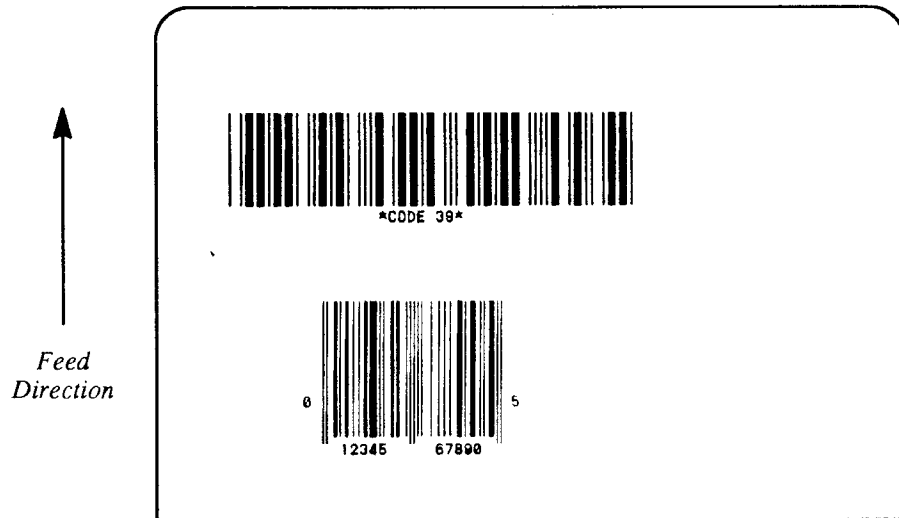
**Printer Output:****Special Notes**

- When using the <ESC>BD command, the narrow bars and spaces (elements) will be two times the width specified by the bb parameter. Wide elements will be five times the width specified by this parameter.
- UPC and EAN bar codes are not affected by the different types of narrow to wide ratios. Instead, the <ESC>D command adds descender bars to these codes where needed to meet UPC specifications.
- See Appendix B for more specific instructions and detailed information regarding individual bar code symbols.
- If you will be printing rotated bar codes, the actual printed height may vary from the specified bar height. See Appendix B for details.

---

## Bar Codes – Variable Ratio

---

### Command Structure

<ESC>**BT**abbccdee

- a** = Bar Code Symbol:  
0 Codabar  
1 Code 39  
2 Interleaved 2 of 5  
5 Industrial 2 of 5  
6 Matrix 2 of 5
- bb** = Narrow space in dots (01–99)  
**cc** = Wide space in dots (01–99)  
**dd** = Narrow bar in dots (01–99)  
**ee** = Wide bar in dots (01–99)

**Example:** <ESC>**BT101030103**

**Placement:** Following print position commands and preceding  
<ESC>BW

**Default:** None

### Command Function

To print a bar code with a ratio other than those specified through the standard bar code commands (B, BD, and D). This is done through individual control of each of the bar code elements (bars, spaces) as shown above. Remember that this command only applies to the 5 bar code types shown.

### How to Use

**Input to Printer:**

```
<ESC>A  
<ESC>H150<ESC>V100<ESC>BT104120412<ESC>BW01200*12345*  
<ESC>H350<ESC>V310<ESC>M*12345*  
<ESC>Q1  
<ESC>Z
```

*(Continued on next page...)*

**How to Use**

(...Continued from previous page)

**Printer Output:**

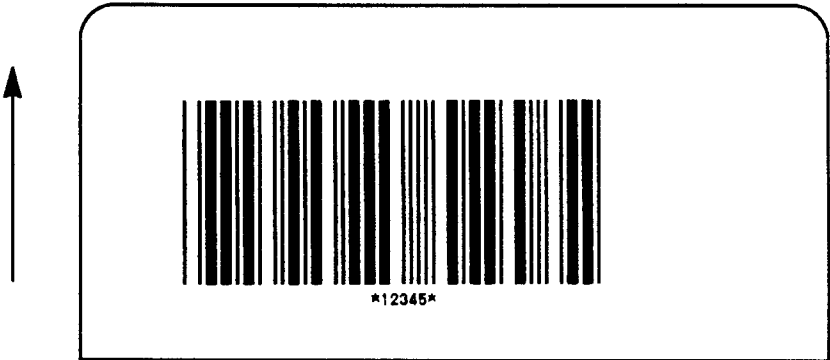

**Special Notes**

- This command must be immediately followed by the <ESC>BW command (see Page 1-12).
- With Interleaved 2 of 5, the total width of one narrow bar and one wide bar cannot exceed 82 dots.
- You may use only one variable ratio bar code per label.
- See Appendix B for more specific instructions and details regarding individual bar code symbols.

---

## Bar Codes – Variable Ratio (cont.)

---

### Command Structure

<ESC>**BW***aa**bbb*

**aa** = Expansion factor by which the width of all bars and spaces is increased (01–12)

**bbb** = Bar height by dot (004–600 dots)

**Example:** <ESC>**BW**02100

**Placement:** Immediately follows the <ESC>BT command and precedes data to be encoded

**Default:** None

### Command Function

This command works together with the <ESC>BT command to specify an expansion factor and the bar code height for the particular symbol being printed.

### How to Use

#### Input to Printer:

```
<ESC>A  
<ESC>H150<ESC>V100<ESC>BT101030103<ESC>BW02100*8400*  
<ESC>H150<ESC>V300<ESC>BT101030103<ESC>BW04200*8400*  
<ESC>Q1  
<ESC>Z
```

#### Printer Output:

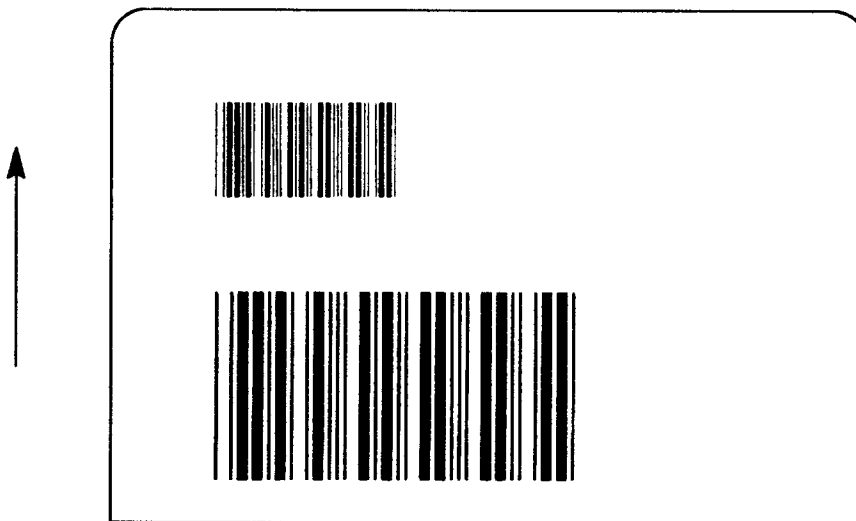

**Special Notes**

- This command must be preceded by the <ESC>BT command (see Page 1-10).
- If you will be printing rotated bar codes, the actual printed height may vary from the specified bar height. See Appendix B for details.



---

## Base Reference Point

---

### Command Structure

<ESC>**A3HaaaVbbbb**

**aaa** = Horizontal Print Offset (001 – 832 dots)

**bbbb** = Vertical Print Offset (0001 – 1424 dots)

**Example:** <ESC>**A3H100V0050**

**Placement:** Preceding all images that are based on the new base reference point

**Default:** Current VH offset setting in the printer configuration

### Command Function

To establish a new base reference point for the current label. The base reference point is the top left corner or “origin” from where all print position commands are based.

This command may be very helpful when using labels less than 4 inches wide to place images on the printable label surface. It may also be used to move images past preprinted fields on a label.

### How to Use

#### Input to Printer:

<ESC>A

<ESC>**A3H100V0100**

<ESC>H1<ESC>V1<ESC>L0202<ESC>MSATO M-8400

<ESC>H1<ESC>V100<ESC>B103100\*123456\*

<ESC>Q1

<ESC>Z

#### Printer Output:

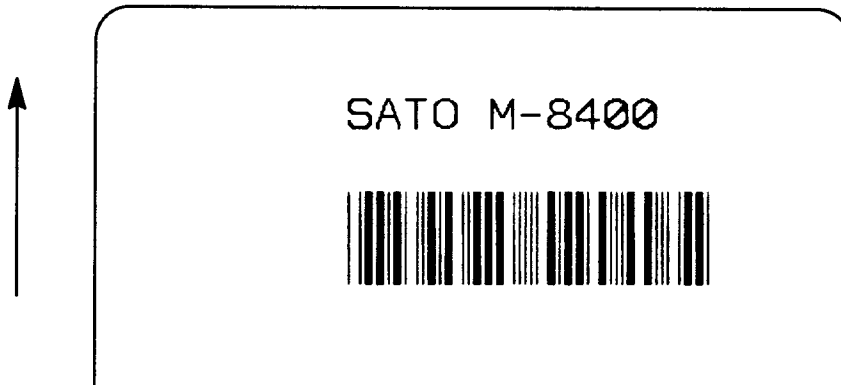

## Special Notes

- Use of this command will set the VH Offset setting of the printer configuration until a new Base Reference Point command is issued or the setting is changed from the operator panel. See Mode S of the Printer Configuration in Section 2 of the M-8400 Operator's Manual.
- This command may be used more than once in a print job.
- An alternative to using this command is to make changes to your current Horizontal and Vertical Positioning commands (see Page 1-51).

Example: Let's say the current base reference point is H=1, V=1 and you wish to move all the fields on your label downward vertically by 1/2" (100 dots). You could either (1) add the Base Reference Point command or (2) change all the vertical position commands by an additional 100 dots.

- For a more detailed example of the Base Reference Point command, see "Adjusting Our Samples for Your Labels" (Page 1-4).

---

## Calendar Increment

---

### Command Structure

<ESC>**WPab**

**a** = Y Years  
M Months  
D Days  
h Hours

**b** = Numeric data: Years (1-9), Months (01-99), Days (001-999),  
Hours (001-999)

**Example:** <ESC>**WPY3**

**Placement:** Anywhere within the data stream

**Default:** None

### Command Function

To add a value to the printer's current date and/or time, which may then be printed on the label. This command does not change the printer's internal clock setting.

### How to Use

#### Input to Printer:

<ESC>A

<ESC>H100<ESC>V100<ESC>WB1Current Date:

<ESC>WAMM/DD/YY

<ESC>**WPM06**

<ESC>H100<ESC>V200<ESC>WB1Expiration Date:

<ESC>WAMM/DD/YY

<ESC>Q1

<ESC>Z

#### Printer Output:



Current Date: 01/30/91

Expiration Date: 07/30/91

**Special Notes**

- You cannot increment the date or time past December 31, 1999.
- This command can only be used once per data stream.
- The printer's internal clock may be set through the operator panel (see Mode W of the Printer Configuration in Section 2 of the M-8400 Operator's Manual) or through the Calendar Set command (see Page 1-20).
- If a print quantity of more than one label per job is used, the same time and date will be on each label of the entire print job.

---

## Calendar Print

---

### Command Structure

<ESC>**WA (elements)**

**(elements)** = YY Year  
MM Month  
DD Day  
hh Hour  
mm Minute

**Example:** <ESC>**WAMM/DD/YY hh:mm**

**Placement:** Anywhere within the data stream

**Default:** None

### Command Function

To specify the printing of a date and/or time field from the printer's internal clock. This may be used to date/time stamp your labels.

### How to Use

#### Input to Printer:

```
<ESC>A  
<ESC>H100<ESC>V100<ESC>MThe current date is:  
<ESC>WB1<ESC>WAMM/DD/YY  
<ESC>H100<ESC>V200<ESC>MThe current time is:  
<ESC>WB1<ESC>WAhh:mm  
<ESC>Q1  
<ESC>Z
```

#### Printer Output:



```
The current date is: 12/20/90  
  
The current time is: 08:30
```

## Special Notes

- The date and time elements may be placed in any order for printing.
- Use a slash (/) to separate date elements and a colon (:) to separate time elements.
- The date/time elements will be printed using the current font if none is specified.
- The printer's internal clock may be set through the operator panel (see Mode W of the Printer Configuration in Section 2 of the M-8400 Operator's Manual) or through the Calendar Set command (see Page 1-20).

---

## Calendar Set

---

### Command Structure

<ESC>**WTaabbccdde**

**aa** = Year (01-99)  
**bb** = Month (01-12)  
**cc** = Day (01-31)  
**dd** = Hour (00-23)  
**ee** = Minute (00-59)

**Example:** <ESC>**WT9101311200**

**Placement:** Anywhere within the data stream

**Default:** None

### Command Function

To set the time and date of the M-8400's internal clock.

### How to Use

#### Input to Printer:

<ESC>A

<ESC>**WT9012250800**

<ESC>Z

#### Printer Output:

No printer output. Sets the current date to December 25, 1990 and the current time to 8:00 a.m. on the printer.

### Special Notes

- You can also set the internal clock through the operator panel (see Mode W of the Printer Configuration in Section 2 of the M-8400 Operator's Manual).

## Character Expansion

### Command Structure

<ESC>**L***aabb*

**aa** = Multiple to expand horizontally (01–12)

**bb** = Multiple to expand vertically (01–12)

**Example:** <ESC>**L0305**

**Placement:** Preceding the data to be expanded

**Default:** <ESC>L0101

### Command Function

To expand characters independently in both the horizontal and vertical directions. The command allows you to enlarge the base size of each font (except the vector font) up to 12 times in either direction. Expanded characters are typically used for added emphasis or for long distance readability.

### How to Use

#### Input to Printer:

<ESC>A

<ESC>H100<ESC>V100<ESC>MM-8400

<ESC>H100<ESC>V200<ESC>**L0203**<ESC>MM-8400

<ESC>H100<ESC>V300<ESC>**L0502**<ESC>MM-8400

<ESC>Q1

<ESC>Z

#### Printer Output:

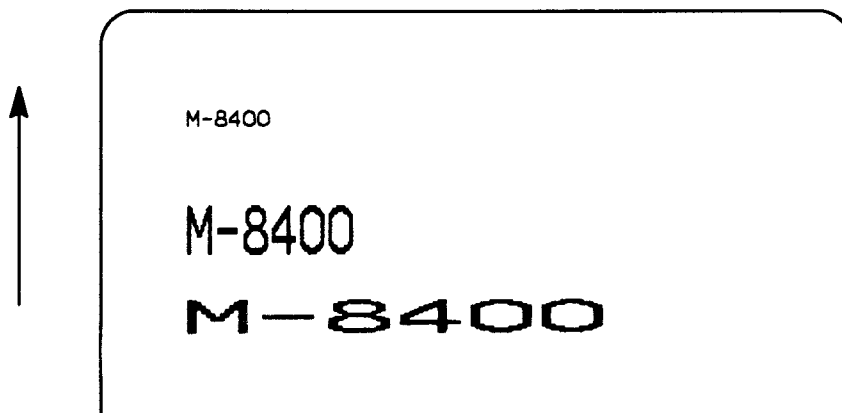



## Special Notes

- This command will expand the following fonts:
  - Fonts U, S, M, OA & OB (see Page 1-38)
  - Fonts WB & WL (see Page 1-40)
- This command will also affect the following commands:
  - Character Pitch (see Page 1-23)
  - Custom-Designed Characters (see Page 1-31)
- The Character Expansion value is in effect for the current print job until a new expansion command is specified.
- The Line and Box command, if used within the data stream, may return all subsequent text to the default expansion of 1 x 1. Therefore, either send the Character Expansion command before all printed data, or send Line and Box commands last, preceding <ESC>Q.

## Character Pitch

### Command Structure

<ESC>**Paa**

**aa** = Number of dots between characters (01-99)

**Example:** <ESC>**P03**

**Placement:** Preceding the text to be printed

**Default:** <ESC>P02

### Command Function

To designate the amount of spacing (in dots) between characters. This command provides a means of altering character spacing for label constraints or to enhance readability.

### How to Use

#### Input to Printer:

```
<ESC>A
<ESC>H100<ESC>V100<ESC>L0102<ESC>MM-8400
<ESC>P05<ESC>H100<ESC>V200<ESC>L0102<ESC>MM-8400
<ESC>P25<ESC>H100<ESC>V300<ESC>L0102<ESC>MM-8400
<ESC>Q1
<ESC>Z
```

#### Printer Output:

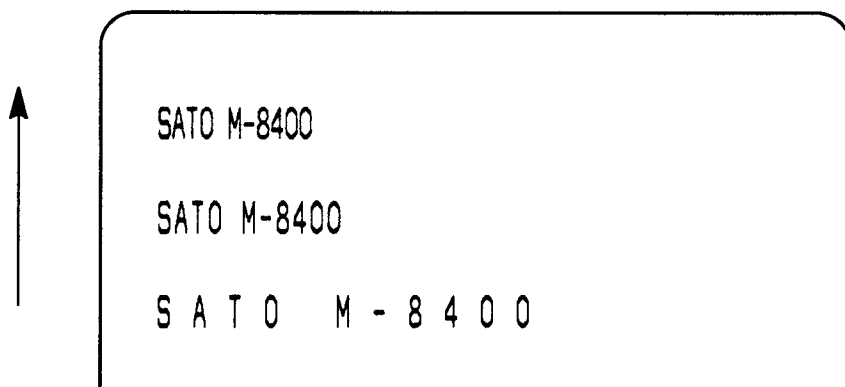

### Special Notes

- This command is affected by the Character Expansion command (see Page 1-21). The character pitch is actually the product of the current horizontal expansion multiple and the designated pitch value. Example:

```
<ESC>L0304  
<ESC>P03
```

$$\text{Pitch} = (03) \times (03) = 9 \text{ dots}$$

To avoid confusion, you may want to include the Character Expansion command and this command together in your program.

- This command affects Fonts U, S, M, OA & OB (see Page 1-38), Fonts WB & WL (see Page 1-40), and the Vector Font (see Page 1-73).
- Character Pitch will always revert to the default value unless it is specified before each new font command in the data stream.

---

## Character Tables

---

**Command Structure****<ESC>Wa**

**a** = 0 IBM 850 Character Table  
 1 – 7 SATO International Character Tables  
 8 *reserved*  
 9 SATO Character Table

**Example:** <ESC>**W1****Placement:** Anywhere within the data stream**Default:** <ESC>W0**Command Function**

To select one of the SATO International Character Tables.

**How to Use****Input to Printer:**

```
<ESC>A
<ESC>L0202
<ESC>H100<ESC>V100<ESC>MBackslash char "\
<ESC>H150<ESC>V200<ESC>W0Table 0: \
<ESC>H150<ESC>V300<ESC>W4Table 4: \
<ESC>H150<ESC>V400<ESC>W6Table 6: \
<ESC>Q1
<ESC>Z
```

**NOTE:** “\” represents the character 5C<sub>H</sub> in ASCII.*(Continued on the next page...)*

**How to Use**

*(Continued from previous page...)*

**Printer Output:**

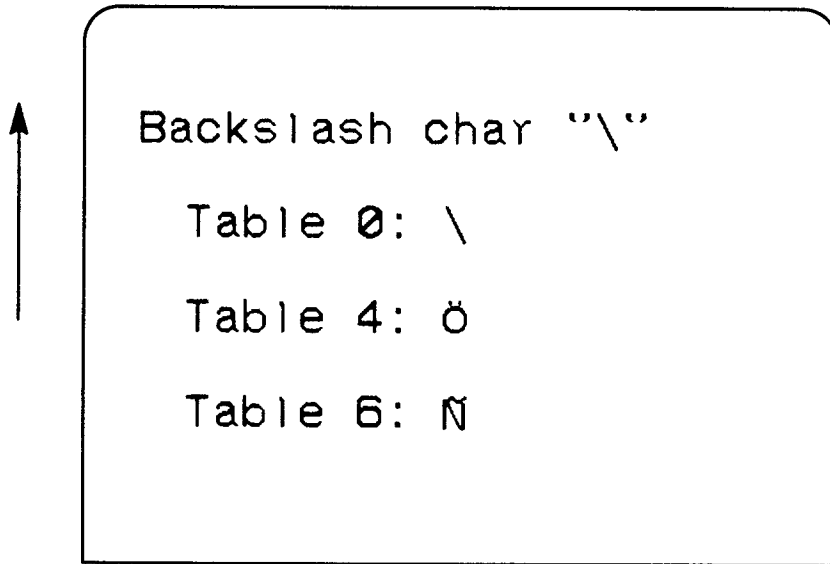

**Special Notes**

- The IBM 850 character table is the default table if this command is not specified in the data stream.
- See Appendix F for a description of each of the character tables available.

---

## Clear Printer Memory & Buffers

---

**Command Structure**

<ESC>**\***  To clear the receiving buffer and compiling buffer  
 <ESC>**\*T**  To clear the custom character memory  
 <ESC>**\* ,**  To clear formats stored in the memory card  
 <ESC>**\*&**  To clear the form overlay memory  
 <ESC>**\*G**  To clear graphics stored in the memory card  
 <ESC>**\*X**  To clear all of the above

**Example:** See above

**Placement:** In a separate data stream, immediately after <ESC>A and immediately before <ESC>Z

**Default:** None

**Command Function**

To clear individual memory or buffer areas of the M-8400.

**How to Use****Input to Printer:**

<ESC>A

<ESC>**\***

<ESC>Z

**Printer Output:**

No printer output. This example clears the receiving buffer and the compiling buffer.

---

---

## Continuous Forms Printing

---

### Command Function

The M-8400 locates the end of an adhesive label by sensing the backing between labels or through the use of an I-mark (black rectangle on the reverse side of the backing). It locates the end of a tag from a notch, I-mark, or a hole between tags.

If you will be using continuous labels or tags, the printer must be told to stop feeding in another manner. The length is determined by the position of the last printed image on the label or tag. The printer will stop feeding when this last field is finished printing. The length may be increased with printed spaces (20H) if necessary. **There is no command code to control label length.**

### Special Notes

- In the printer configuration, the option for Setup Sensor under Mode S (Sensors 4,5) **must** be set to “Not Used”. See Mode S of the Printer Configuration in Section 2 of the M-8400 Operator’s Manual for further information.

## Copy Image Area

### Command Structure

<ESC>**WDHaaaVbbbbXcccYdddd**

- aaa** = Horizontal position of the top left corner of the image area to be copied  
**bbbb** = Vertical position of the top left corner of the image area to be copied  
**ccc** = Horizontal length of the image area to be copied  
**dddd** = Vertical length of the image area to be copied

**Example:** <ESC>**WDH100V0050X600Y0400**

**Placement:** Anywhere within the data stream, after specifying the location of the duplicate image

**Default:** None

### Command Function

To copy an image from one location to another on the same label. This may be useful for duplicating individual fields or entire sections of the label with only one command.

### How to Use

#### Input to Printer:

```
<ESC>A
<ESC>H100<ESC>V100<ESC>E002<ESC>WL1
AAAAAAAAAAAAAAAA
BBBBBBBBBBBBBBBB
CCCCCCCCCCCCCCC
DDDDDDDDDDDDDD
<ESC>H200<ESC>V400<ESC>WDH150V0125X200Y0150
<ESC>Q1
<ESC>Z
```

*(Continued on next page...)*



**How to Use**

(...Continued from previous page)

**Printer Output:**

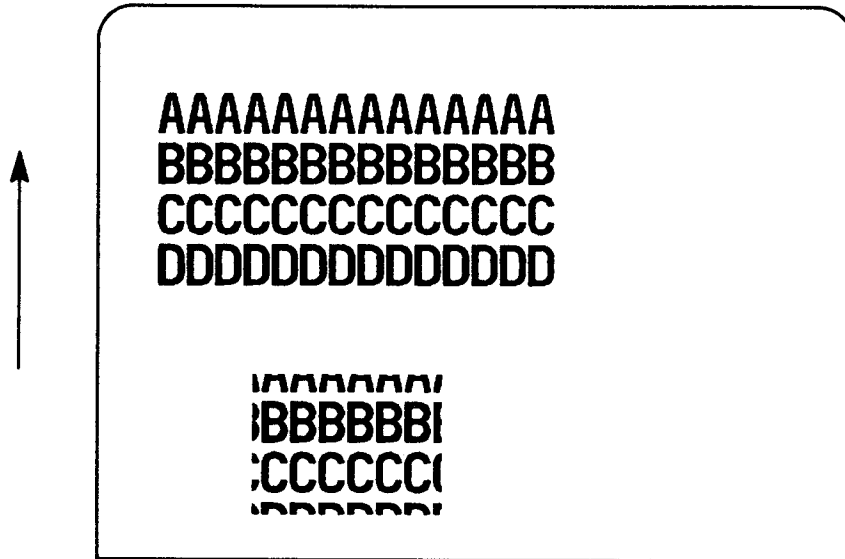

**Special Notes**

- Use the print position commands to locate the new area for the duplicate image.

---

## Custom-Designed Characters

---

### Command Structure

Store Command: <ESC>**TaHbb (data)**

Recall Command: <ESC>**KaH90bb**

**a** = 1 16x16 matrix  
2 24x24 matrix

**H** = Specifies a Hex data stream is to follow

**bb** = Memory location to store/recall the character. Valid memory locations are 21 hex to 52 hex

**(data)** = Hex data to describe the character

**Example:** See Appendix C

**Placement:** The Store command is typically sent in its own data stream to the printer, between the Start/Stop commands. The Recall command is sent in a secondary data stream to print the character, and follows any necessary position or size commands.

**Default:** None

### Command Function

To allow for the creation, storage, and printing of custom characters, such as special fonts or logos. Up to 50 individual characters may be stored in the custom character volatile memory.

### How to Use

See Appendix C for a detailed example.

### Special Notes

- When printing the custom character using the **Recall** command, the character is affected by the following commands:
  - Character Expansion (see Page 1-21)
  - Character Pitch (see Page 1-23)
  - Line Feed (see Page 1-47)
  - Rotation – Fixed Base Reference Point (see Page 1-63)
  - Rotation – Moving Base Reference Point (see Page 1-65)
- The characters are stored in volatile memory and thus must be reloaded if the printer power is lost.
- Do not use ASCII <CR> or <LF> characters (carriage return or line feed) as line delimiters within the graphic data or the actual image will not be printed as specified.

## Custom Graphics

### Command Structure

<ESC>**GHaaabbb (data)**

**H** = Specifies a Hex data stream is to follow  
**aaa** = Number of horizontal 8 x 8 blocks (001–104)  
**bbb** = Number of vertical 8 x 8 blocks  
 (001–177; 001–354 for 14" label)  
**(data)** = Hex data to describe the graphic image

**Example:** See Appendix C

**Placement:** May be placed anywhere within the data stream after the necessary position commands.

**Default:** None

### Command Function

To create and print custom graphics (logos, pictures, etc.) on a label. The graphic image may be printed along with other printed data to enhance label appearance or eliminate the need for preprinted label stock. Using a dot-addressable matrix, design the graphic image in 8 dot by 8 dot blocks, then send it in a hexadecimal format to the printer.

### How to Use

See Appendix C for a detailed example.

### Special Notes

- Do not use ASCII <CR> or <LF> characters (carriage return or line feed) as line delimiters within the graphic data or the actual image will not be printed as specified.
- A custom graphic cannot be enlarged by the Character Expansion command.
- A custom graphic is not affected by either of the Rotation commands. Therefore, always design and locate your graphic image to print in the appropriate orientation.
- Use the Expanded Print Length command (see Page 1–37) in your print job to select the 14-inch label length.
- To store graphic images in optional battery-backed memory cards, see the Custom Graphics – Battery Backed command (Page 1–33).

## Custom Graphics – Battery Backed

### Command Structure

Store Command: <ESC>**GIHaaabbbcc (data)**

Recall Command: <ESC>**GRcc**

**H** = Specifies a Hex data stream is to follow  
**aaa** = Number of horizontal 8 x 8 blocks (001 – 104)  
**bbb** = Number of vertical 8 x 8 blocks (001 – 177; 001–354 for 14" label)  
**cc** = Register number (01–99)  
**(data)** = Hex data to describe the graphic image

**Example:** See Appendix C

**Placement:** The Store command is typically sent in its own data stream to the printer, between the Start/Stop commands. The Recall command is sent in a secondary data stream to print the graphic, and follows any necessary position or size commands.

**Default:** None

### Command Function

To provide similar functionality to the Custom Graphic command (see Page 1–32), but allows for the graphic image to be stored in battery-backed memory.

Use the Store command to send the graphic data to the printer, which is held in the optional memory card, even if printer power is lost.

Use the Recall command any time you want to print a graphic image on one of your labels along with other printed data.

### How to Use

See Appendix C for a detailed example.

## Special Notes

- **You must have the optional memory card to use this command.** Call your SATO representative for more information.
- The memory card must be configured to store Formats/Graphics or Graphics Only. See Mode M of the Printer Configuration in Section 2 of the M-8400 Operator's Manual for configuration details.
- The maximum storage capacity is 124K bytes (8K bytes per block) when the memory card is set for Graphics Only.
- The graphic images currently stored on the memory card can be verified through Mode T of the Printer Configuration.
- If a data transmission error occurs, the printer will beep and display the message "CARD ERROR". You must then retransmit the image.
- Each graphic to be stored must be sent in its own data stream.

Example of **correct** data stream:

```
<ESC>A
<ESC>GIHaaabbb01 (DATA)
<ESC>Z

<ESC>A
<ESC>GIHaaabbb02 (DATA)
<ESC>Z
```

Example of **incorrect** data stream:

```
<ESC>A
<ESC>GIHaaabbb01 (DATA)
<ESC>GIHaaabbb02 (DATA)
<ESC>Z
```

- Do not use ASCII <CR> or <LF> characters (carriage return or line feed) as line delimiters within the graphic data or the actual image will not be printed as specified.

---

## Cutter Command

---

**Command Structure**

<ESC><NUL>**aa**

**aa** = Number of labels to print between each cut (00–99)

**Example:** <ESC><NUL>**02**

**Placement:** Following the Print Quantity command (<ESC>Q)

**Default:** <ESC><NUL>01 (if cutter enabled)

**Command Function**

To control the cutting of labels when using the optional SATO cutter unit with the M-8400 printer. This command allows the cutting of a multi-part tag or label at a specified interval within a print job.

**How to Use****Input to Printer:**

```
<ESC>A
<ESC>H100<ESC>V100<ESC>WB0123456
<ESC>H100<ESC>V150<ESC>WL1123456
<ESC>Q20
<ESC><NUL>02
<ESC>Z
```

**Printer Output:**

This set of commands will print **40** labels (20 x 2) with two labels printing between each cut.

## Special Notes

- **You must have the optional M-8402 Cutter to use this command.** Contact your SATO representative for more information.
- To use this command, the printer configuration must have the cutter option enabled. See Mode S of the Printer Configuration in Section 2 of the M-8400 Operator's Manual.
- If the cutter option has been enabled in the printer configuration and the cut value (aa) = 00, the cutter is inactive.
- The <NUL> represents the ASCII 00<sub>H</sub> character.
- When using the Cutter command, the total number of labels printed is the product of the cut value and the print quantity. For example, if the cut value is 02, and the print quantity is 20, then 40 labels will be printed.

## Expanded Print Length

<b>Command Structure</b>	<code>&lt;ESC&gt;<b>AX</b></code>	Sets the maximum print length to 14" (356 mm)
	<code>&lt;ESC&gt;<b>AR</b></code>	Resets the maximum print length to 7" (178 mm)
	<b>Example:</b>	See above.
	<b>Placement:</b>	Must follow the Start Code command (see Page 1-69)
	<b>Default:</b>	<code>&lt;ESC&gt;AR</code>

**Command Function** To double the maximum print length (in feed direction) for a label.

### How to Use

#### Input to Printer:

```

<ESC>A
<ESC>AX
<ESC>H100<ESC>V200<ESC>M123456
<ESC>H100<ESC>V1800<ESC>MABCDEF
<ESC>Q1
<ESC>Z

```

#### Printer Output:

If you are using 10-inch long labels, the above code would print "123456" one inch from the top of the label and "ABCDEF" nine inches from the top of the label.

### Special Notes

- AX is effective until AR is sent to reset the M-8400 to its standard print length, or until the printer is repowered.
- It may be helpful to use an independent data stream to specify the size of the maximum print area:
  - `<ESC>A<ESC>AX<ESC>Z` for 14"L (2848 dots)
  - `<ESC>A<ESC>AR<ESC>Z` for 7"L (1424 dots)
- This command cannot be used in conjunction with the Forms Overlay command (Page 1-71).



---

## Fonts U, S, M, OA & OB

---

### Command Structure

<ESC>**U**

<ESC>**S**

<ESC>**M**

<ESC>**OA**

<ESC>**OB**

**Example:** See above

**Placement:** Preceding the data to be printed

**Default:** <ESC>S

### Command Function

To print text images on a label. These are five of the built-in fonts available on the M-8400:

- U** 5W x 7L dot matrix (5 x 9 includes descenders)
- S** 8W x 12L dot matrix (8 x 15 includes descenders)
- M** 13W x 17L dot matrix (13 x 20 includes descenders)
- OA** OCR-A font with 22W x 32L dot matrix
- OB** OCR-B font with 21W x 30L dot matrix

### How to Use

#### Input to Printer:

<ESC>A

<ESC>H100<ESC>V100<ESC>**U**123456

<ESC>H100<ESC>V150<ESC>**S**123456

<ESC>H100<ESC>V200<ESC>**M**123456

<ESC>H100<ESC>V250<ESC>**OA**123456

<ESC>H100<ESC>V300<ESC>**OB**123456

<ESC>Q1

<ESC>Z

*(Continued on next page...)*

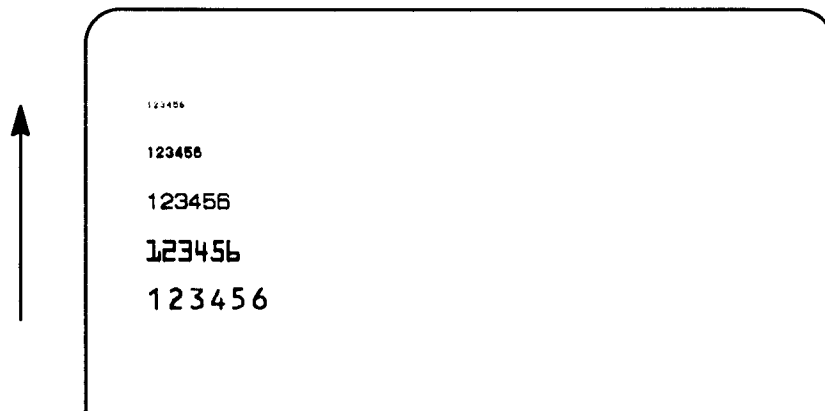
**How to Use***(...Continued from previous page)***Printer Output:****Special Notes**

- Characters may be enlarged through the use of the Character Expansion command (see Page 1-21).
- Character spacing may be altered through the use of the Character Pitch command (see Page 1-23). The default is 2 dots between characters. It is recommended to use a spacing of 5 dots for OCR-A and 1 dot for OCR-B.
- Once a font type is specified, all subsequent text will print in that style until another font is specified or until the end of the print job.
- You may also create custom characters or fonts. See the Custom-Designed Characters command (Page 1-31).
- The current character table selection may affect your text output. See the Character Tables command (Page 1-25).
- The Line and Box command, if used within the data stream, may return all subsequent text data to the default S font. Therefore, either send a Font command before all printed data, or send Line and Box commands last, preceding <ESC>Q.

---

## Fonts WB & WL

---

### Command Structure

Font WB:     <ESC>**WB***a*

Font WL:     <ESC>**WL***a*

**a** = 0     Disables auto-smoothing of font

      1     Enables auto-smoothing of font (see notes below)

**Example:**    <ESC>**WB1123456**

**Placement:**  Preceding the data to be printed

**Default:**    None (Font S is used if no font command is specified)

### Command Function

To print text images on a label. These are the two auto-smoothing fonts available on the M-8400:

**WB**    18W x 26L dot matrix (18 x 30 includes descenders)

**WL**    28W x 44L dot matrix (28 x 52 includes descenders)

### How to Use

#### Input to Printer:

```
<ESC>A
<ESC>H100<ESC>V100<ESC>WB0123456
<ESC>H100<ESC>V150<ESC>WL1123456
<ESC>L0303<ESC>H100<ESC>V200<ESC>WB0M-8400
<ESC>H100<ESC>V300<ESC>WB1M-8400
<ESC>L0101<ESC>H500<ESC>V325<ESC>M (Auto-Smooth)
<ESC>Q1
<ESC>Z
```

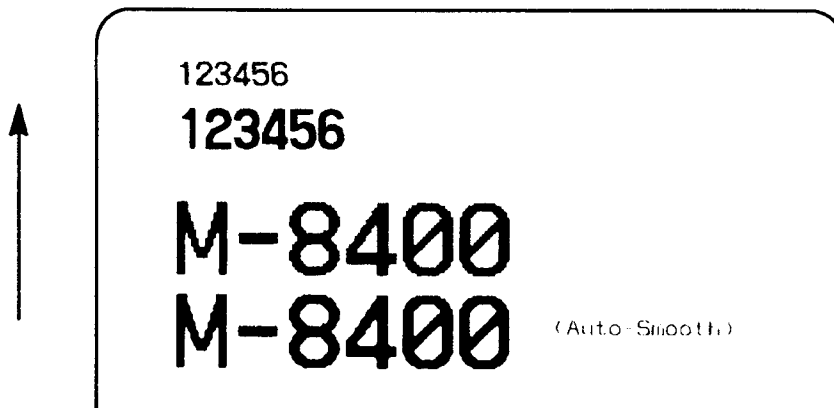
**Printer Output:****Special Notes**

- Auto-smoothing when enabled is only effective if the character expansion rate is at least (3) times in each direction.
- Characters may be enlarged through the use of the Character Expansion command (see Page 1-21).
- Character spacing may be altered through the use of the Character Pitch command (see Page 1-23).
- Once WB or WL is specified, all subsequent text will print as that type until another font is specified or until the end of the print job.
- The current character table selection may affect your text output. See the Character Tables command (Page 1-25).
- The Line and Box command, if used within the data stream, may return all subsequent text data to the default S font. Therefore, either send, a Font command before all printed data, or send Line and Box commands last, preceding <ESC>Q.

---

## Form Feed

---

### Command Structure

**<ESC>A (space) <ESC>Z**

**Example:** See above

**Placement:** Separate data stream sent to printer

**Default:** None

### Command Function

To print a blank tag or label, which is the equivalent of a “form feed”.

### How to Use

#### Input to Printer:

**<ESC>A**

**(space)**

**<ESC>Z**

#### Printer Output:

Blank label or tag.

---

## Journal Print

---

**Command Structure**<ESC>**J**

**Example:** See above  
**Placement:** Immediately following <ESC>A  
**Default:** None

**Command Function**

To print text in a line by line format on a label. By specifying this command, you automatically select Font S with a Character Expansion of <ESC>L0202. You also establish a base reference point of <ESC>H2<ESC>V2. The character pitch is 2 dots and the line gap is 16 dots. Simply issue an ASCII <CR> at the end of each text line.

**How to Use****Input to Printer:**

<ESC>A  
 <ESC>**J**  
 <CR>

With the Journal feature, you can <CR>  
 print text without using any <CR>  
 font commands or position commands. <CR>

<ESC>Q1  
 <ESC>Z

**Printer Output:**

With the Journal feature, you can  
 print text without using any  
 font commands or position commands.

**Special Notes**

- Journal mode assumes a minimum label width of 4.1 inches. Otherwise, you may print where there is no label and damage your print head.
- It is effective only for the current print job.

## Lines and Boxes

### Command Structure

Horizontal line: <ESC>**FWaaHb**

Vertical Line: <ESC>**FWccVd**

Box: <ESC>**FWaacchbVd**

**aa** = Width of horizontal line in dots (01–99)

**b** = Length of horizontal line in dots (1–832)

**cc** = Width of vertical line in dots (01–99)

**d** = Length of vertical line in dots (1–1424; 1–2848 for expanded labels)

**Example:** <ESC>**FW02H200**

**Placement:** Following the necessary positioning commands

**Default:** None

### Command Function

To print horizontal lines, vertical lines, and boxes as images on the label.

### How to Use

#### Input to Printer:

<ESC>A

<ESC>H100<ESC>V100<ESC>**FW02H100**

<ESC>H250<ESC>V100<ESC>**FW02V100**

<ESC>H300<ESC>V100<ESC>**FW0306H150V150**

<ESC>Q1

<ESC>Z

#### Printer Output:

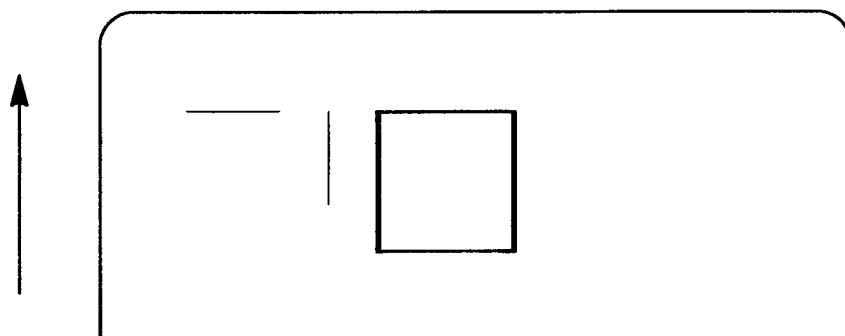



**Special Notes**

- It is recommended that all lines and boxes be specified in the normal print direction.

---

## Line Feed

---

**Command Structure****<ESC>Ea**

**a** = Number of dots (1–999) between the bottom of the characters on one line to the top of the characters on the next line

**Example:**     **<ESC>E5****Placement:**    Preceding the text that will use the line feed function**Default:**       None**Command Function**

To print multiple lines of the same character size without specifying a new print position for each line. With the Line Feed command, specify the number of dots you want between each line. Then, send an ASCII **<CR>** at the end of each line of text. The printer automatically identifies the size of the last character, moves down the number of dots specified, and begins printing the next line.

**How to Use****Input to Printer:****<ESC>A****<ESC>E10****<ESC>H100<ESC>V100<ESC>L0102<ESC>MLINE 1 DATA<CR>**

THIS IS LINE 2&lt;CR&gt;

AND THEN LINE 3

**<ESC>Q1****<ESC>Z****Printer Output:**

LINE 1 DATA  
THIS IS LINE 2  
AND THEN LINE 3

**Special Notes**

- This command can be used for text and for bar codes.
- It is effective only for the current data stream.
- When printing lines or boxes in the same data stream with the Line Feed command, the Lines and Boxes command should be specified last, preceding <ESC>Q.

---

## Off-Line

---

**Command Structure**

&lt;ESC&gt;@

**Example:** See above**Placement:** Anywhere in the print job between <ESC>A and <ESC>Z**Default:** None**Command Function**

To specify the printer to come to an **off-line** state. When used within a print job, the printer goes off-line after finishing the print job.

**How to Use****Input to Printer:**

&lt;ESC&gt;A

&lt;ESC&gt;@

&lt;ESC&gt;Z

**Printer Output:**

No printer output. The printer goes off-line.

**Special Notes**

- You must press the LINE key on the front panel to return the printer to an **on-line** status (see Operator Panel in Section 2 of the M-8400 Operator's Manual).
- Remember when using this command that if the print job specifies <ESC>Q10, all ten labels will print before the printer will go off-line.

---

## Print Darkness

---

### Command Structure

<ESC>**#Ea**

**a** = Print darkness value (1-5)

**Example:** <ESC>**#E2**

**Placement:** Must be placed immediately after <ESC>A and immediately before <ESC>Z in its own separate data stream

**Default:** As set in the printer configuration

### Command Function

To specify a new print darkness setting. This command allows software control of the darkness setting for unique media and ribbon combinations.

### How to Use

**Input to Printer:**

<ESC>A

<ESC>**#E4**

<ESC>Z

**Printer Output:**

No printer output.

### Special Notes

- This becomes the new setting in the printer configuration for all subsequent print jobs, unless changed.

---

## Print Position

---

**Command Structure**Horizontal Position: <ESC>**Ha**Vertical Position: <ESC>**Vb****a** = Number of dots horizontally from the base reference point  
(1 – max\*)**b** = Number of dots vertically from the base reference point  
(1 – max\*)

\* The maximum will be 832 dots across the width of a label and 1424 dots (2848 dots for expanded labels) down the length of a label.

**Example:** <ESC>**H20** <ESC>**V150****Placement:** Preceding any printed field description of lines/boxes, fonts, bar codes or graphics**Default:** <ESC>H1  
<ESC>V1**Command Function**

The Horizontal and Vertical commands specify the top left corner of a field on a label, using the current base reference point as an origin. They also establish a reference point for subsequent fields until the next horizontal and/or vertical print position command is issued.

**How to Use****Input to Printer:**

```
<ESC>A
<ESC>H300<ESC>V100<ESC>L0303<ESC>M123456
<ESC>H100<ESC>V450<ESC>B103100*123456*
<ESC>%3<ESC>H200<ESC>V200<ESC>L0101<ESC>M123456
<ESC>Q1
<ESC>Z
```

*(Continued on next page...)*

**How to Use**

(...Continued from previous page)

**Printer Output:**

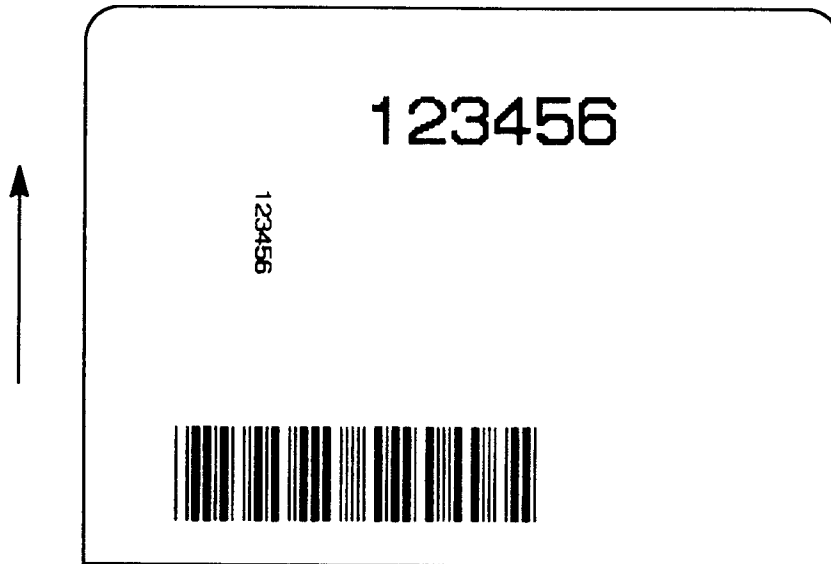

**Special Notes**

- The print position of a field is affected by both the <ESC>R and <ESC>A3 commands.
- The maximum print area is 832 dots W x 1424 dots L (4.1" x 7" or 104 mm x 178 mm). For print lengths over 7", use the Expanded Print Length command – <ESC>AX (see Page 1-37).
- If any part of an image is placed past 1424 dots for standard length and past 2848 dots for expanded length, that part of the image will be lost.
- If any part of an image is placed past 832 dots across the label, that part of the image will wrap around.
- **If you attempt to print where there is no paper, you may damage the print head.**

## Print Quantity

### Command Structure

<ESC>**Qa**

**a** = Total number of labels to print (1–9999)

**Example:** <ESC>**Q500**

**Placement:** Just preceding <ESC>Z , unless <ESC>NUL exists, then preceding that. This command must be present in every print job.

**Default:** None

### Command Function

To specify the total number of labels to print for a given job.

### How to Use

#### Input to Printer:

<ESC>A

<ESC>H100<ESC>V200<ESC>MSATO

<ESC>**Q50**

<ESC>Z

#### Printer Output:

50 labels with the SATO name.

### Special Notes

- To pause during a print job, you must press the LINE key on the Operator Panel.
- To cancel a print job, you must turn off the printer, or you may send the <CAN> code if using Bi-Directional RS232 mode.
- When used with Sequential Numbering (see Page 1–67), the Print Quantity value should be equal to the total number of labels to be printed.



---

## Print Speed Selection

---

### Command Structure

<ESC>**CSa**

**a** = Designates the speed selection  
1 = 2 in/sec (50 mm/sec)  
2 = 3 in/sec (75 mm/sec)  
3 = 4 in/sec (100 mm/sec)  
4 = 5 in/sec (125 mm/sec)

**Example:** <ESC>**CS1**

**Placement:** Must be placed immediately after <ESC>A and immediately before <ESC>Z in its own separate data stream

**Default:** As set in the printer configuration

### Command Function

To specify a unique print speed through software for a particular label. This allows flexibility in finding the best performance and quality for the particular label format, media, and ribbon. All subsequent labels will print at this speed unless the speed is changed with this command or through the Operator Panel.

### How to Use

**Input to Printer:**

<ESC>A

<ESC>**CS4**

<ESC>Z

**Printer Output:**

No printer output.

### Special Notes

- When using this command, the print speed will remain as specified while the printer remains powered on.
- To set the user default print speed, see Mode S of the Printer Configuration in Section 2 of the M-8400 Operator's Manual.

## Recall Form Overlay

### Command Structure

<ESC>/

**Example:** See above

**Placement:** Must be preceded by all other data and placed just before the Print Quantity command (<ESC>Q)

**Default:** None

### Command Function

To recall the label image from the form overlay memory for printing. With the Recall command, you may also print other images on the same label.

### How to Use

#### Input to Printer:

<ESC>A

<ESC>H100<ESC>V50<ESC>MMerge data with the image

<ESC>/

<ESC>Q1

<ESC>Z

#### Printer Output:

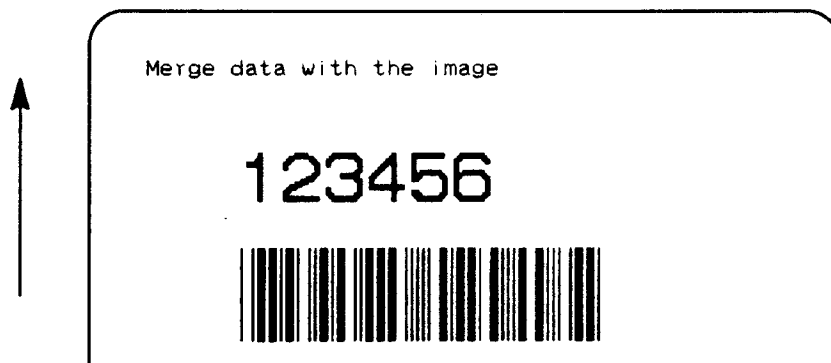

### Special Notes

- The overlay is stored using the Store Form Overlay command (see Page 1-71).

---

## Recall Print Job

---

### Command Structure

**<ESC>+aa**

**aa** = Job identification number  
01 – 07    Format 1 – Graphic 1  
01 – 15    Format 2 – Graphic 0

**Example:**    <ESC>+01  
**Placement:**    Anywhere within the data stream  
**Default:**    None

---

### Command Function

To recall a specified print job for printing from the battery-backed memory card. Within the Recall command, you may also print other images on the same label.

---

### How to Use

#### Input to Printer:

```
<ESC>A  
<ESC>+01  
<ESC>H100<ESC>V50<ESC>L0101<ESC>MRecalled Data  
<ESC>Q1  
<ESC>Z
```

#### Printer Output:

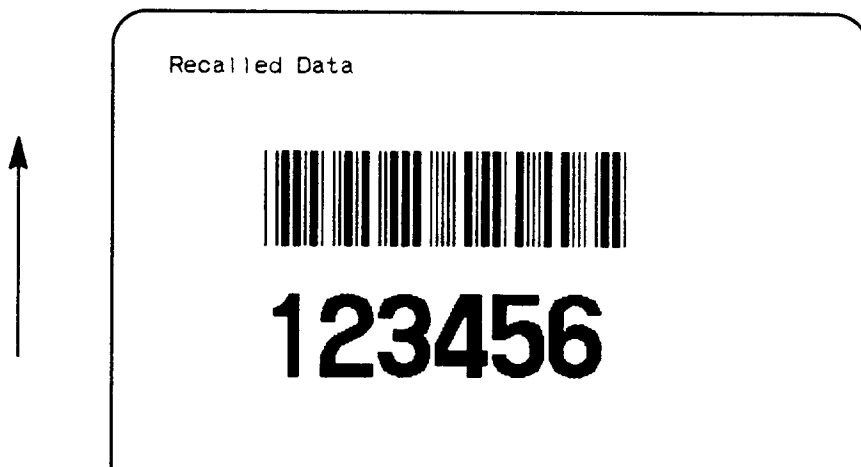

**Special Notes**

- **You must have the optional memory card to use this command.** Call your local SATO representative for more information.
- Use the Store Print Job command (see Page 1-72) to store jobs onto the battery-backed memory card.
- If a data transmission error occurs, the printer will beep and display the message “CARD ERROR”.

---

## Repeat Label

---

### Command Structure

<ESC>**C**

**Example:** See above

**Placement:** Must be placed immediately after <ESC>A and immediately before <ESC>Z in its own separate data stream

**Default:** None

### Command Function

To print a duplicate of the last label printed.

### How to Use

**Input to Printer:**

<ESC>A

<ESC>**C**

<ESC>Z

**Printer Output:**

A duplicate of the previous label.

### Special Notes

- This command will have no effect if the M-8400 was repowered since printing the previous label.

## Replace Data (Partial Edit)

### Command Structure

<ESC>0 (<ESC>zero)

**Example:** See above

**Placement:** Must follow <ESC>A and precede all other print data

**Default:** None

### Command Function

To replace a specified area of the previous label with new data. This command will cause the previous label to print along with any changes specified within the current data stream.

### How to Use

#### Label 1:

#### Input to Printer:

```
<ESC>A
<ESC>H100<ESC>V100<ESC>L0202<ESC>M123
<ESC>H100<ESC>V200<ESC>L0202<ESC>M456
<ESC>H100<ESC>V300<ESC>L0202<ESC>M789
<ESC>Q1
<ESC>Z
```

#### Printer Output:

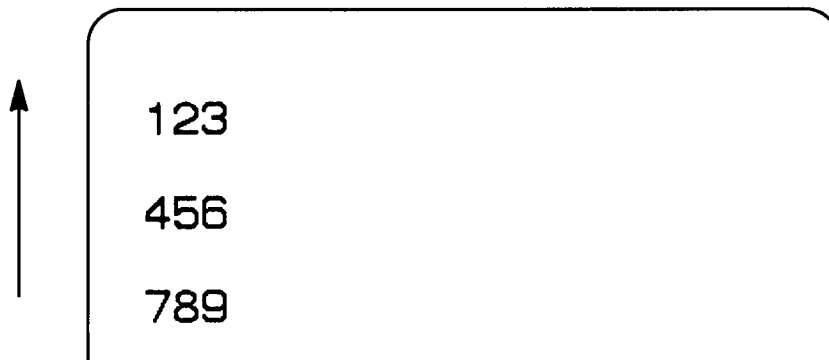

**How to Use**

(...Continued from previous page)

**Label 2:**

**Input to Printer:**

```
<ESC>A  
<ESC>0  
<ESC>H100<ESC>V200<ESC>L0202<ESC>MABC  
<ESC>Q1  
<ESC>Z
```

**Printer Output:**

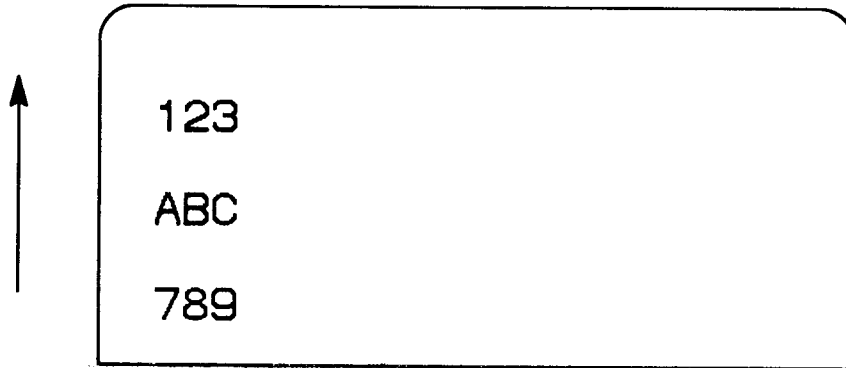

**Special Notes**

- Specify the exact same parameters for the image to be replaced as were specified in the original data stream, including rotation, expansion, pitch, etc. This will ensure that the new data will exactly replace the old image.
- This command will not function if the printer has lost power since the last label was printed.

## Reverse Image

### Command Structure

<ESC> (**a**, **b**)

**a** = Horizontal length in dots of reverse image area (8–832)

**b** = Vertical length in dots of reverse image area (8–999)

**Example:** <ESC> (**100**, **50**)

**Placement:** This command must be preceded by all other data and be placed just before <ESC>Q

**Default:** None

### Command Function

To reverse an image area from black to white and vice versa. Use the Print Position commands (<ESC>H and <ESC>V) to locate the top left corner of the reverse image area.

### How to Use

#### Input to Printer:

```
<ESC>A
<ESC>H100<ESC>V100<ESC>L0202<ESC>WB1REVERSE
<ESC>%3<ESC>H600<ESC>V100<ESC>L0202<ESC>WB1HALF
<ESC>H80<ESC>V80<ESC> (320, 90)
<ESC>H575<ESC>V80<ESC> (45, 200)
<ESC>Q1
<ESC>Z
```

#### Printer Output:

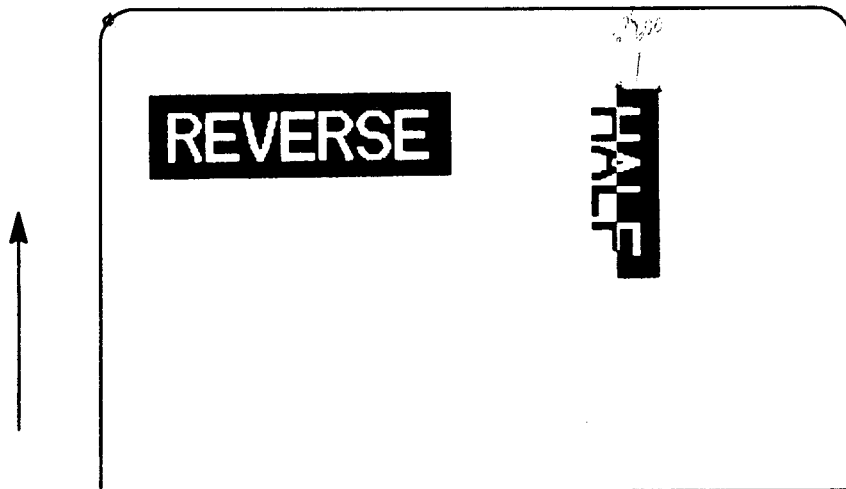



**Special Notes**

- A reverse image area is not affected by either of the rotation commands. Therefore, always assume the printer is in the normal print orientation when designing and sending the Reverse Image command.
- If using reverse images with the form overlay, place this command before the Form Overlay command in the data stream.

## Rotation – Fixed Base Reference Point

### Command Structure

<ESC>%a

- a = 0 Sets print to normal direction  
 1 Sets print to 90° counterclockwise  
 2 Sets print to 180° rotated (upside down)  
 3 Sets print to 270° counterclockwise (90° clockwise)

**Example:** <ESC>%3

**Placement:** Preceding any printed data to be rotated

**Default:** <ESC>%0

### Command Function

To rotate the print direction in 90 degree increments without changing the location of the base reference point. The diagram below illustrates the use of the <ESC>% command. Note that the entire M-8400 print area is shown, but your label will probably not be as large as the entire area.

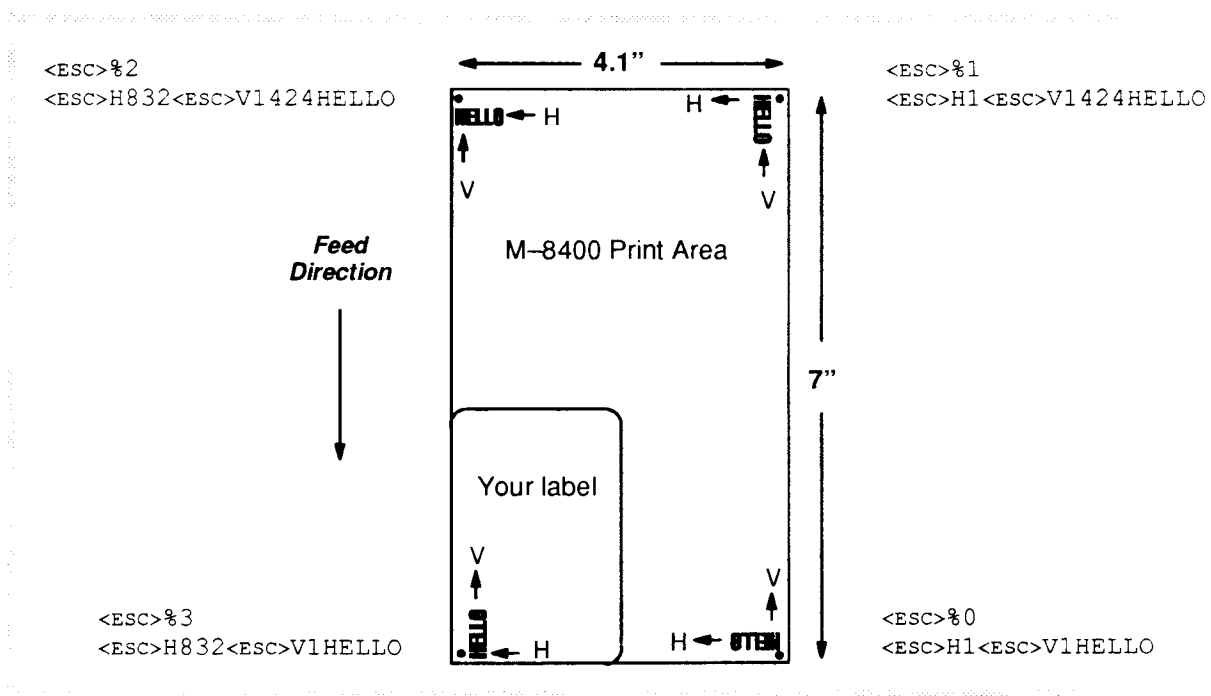

### How to Use

#### Input to Printer:

```
<ESC>A  
<ESC>%0<ESC>H100<ESC>V100<ESC>MNORMAL DIRECTION  
<ESC>%1<ESC>H200<ESC>V200<ESC>MONE  
<ESC>%2<ESC>H300<ESC>V300<ESC>MTWO  
<ESC>%3<ESC>H400<ESC>V400<ESC>MTHREE  
<ESC>Q1  
<ESC>Z
```

#### Printer Output:

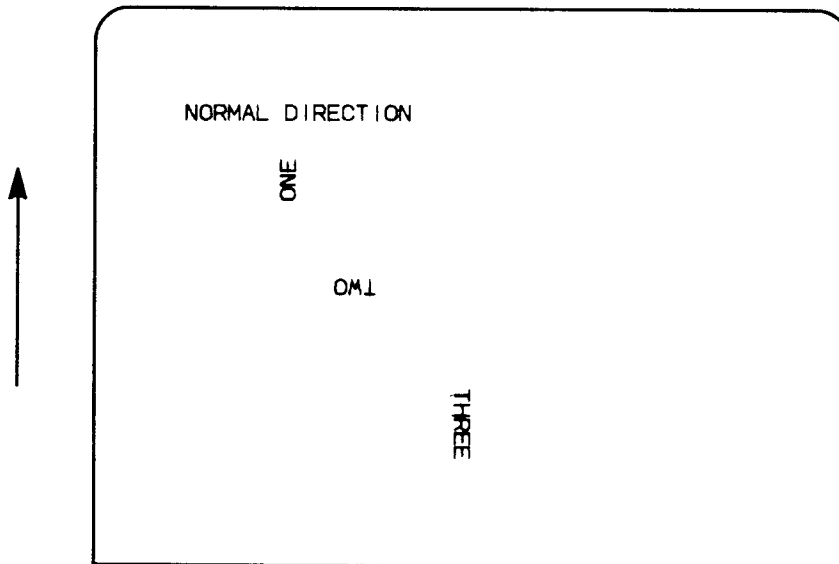

### Special Notes

- Do not combine the <ESC>% command and the <ESC>R command (see Page 1-65) in the same data stream.
- A custom graphic is not affected by the <ESC>% command. Therefore, always design and locate your graphic image to print in the appropriate orientation.

## Rotation – Moving Base Reference Point

**Command Structure**

Normal Direction:     <ESC>**N**  
 Rotated Direction:   <ESC>**R**

**Example:**        See above  
**Placement:**     Preceding any printed data to be rotated  
**Default:**        <ESC>N

**Command Function**

The <ESC>R command rotates the printing of all subsequent images in a print job by 90 degrees counterclockwise each time it is used. It also moves the base reference point to a different corner of the M-8400 print area.

The <ESC>N command returns to the original base reference point and returns printing to the normal orientation.

<ESC>N	Normal Direction
<ESC>N<ESC>R	90° CC Rotation
<ESC>N<ESC>R<ESC>R	180° Rotation (Upside Down)
<ESC>N<ESC>R<ESC>R<ESC>R	270° CC Rotation (90° C)

The diagram below illustrates the use of the <ESC>R command. Note that the entire M-8400 print area is shown, but your label will probably not be as large as the entire print area.

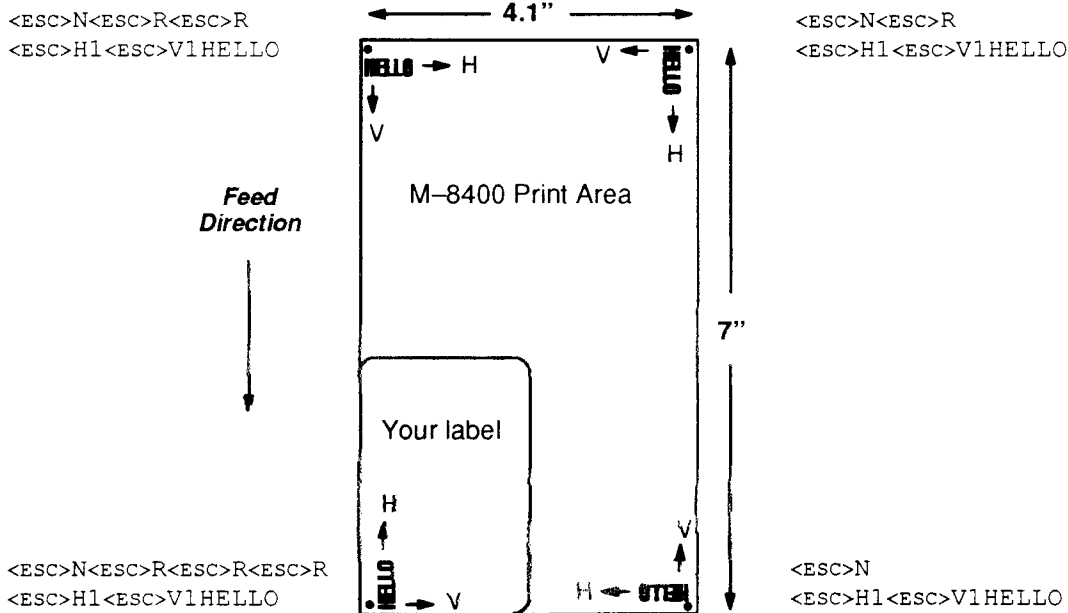

**How to Use**

**Input to Printer:**

```

<ESC>A
<ESC>N<ESC>H100<ESC>V10<ESC>MNORMAL ORIENTATION
<ESC>R<ESC>H700<ESC>V100<ESC>MONE ROTATION
<ESC>R<ESC>H100<ESC>V700<ESC>MTWO
<ESC>R<ESC>H100<ESC>V100<ESC>MTHREE
<ESC>R<ESC>H100<ESC>V100<ESC>MFOUR
<ESC>Q1
<ESC>Z
    
```

**Printer Output:**

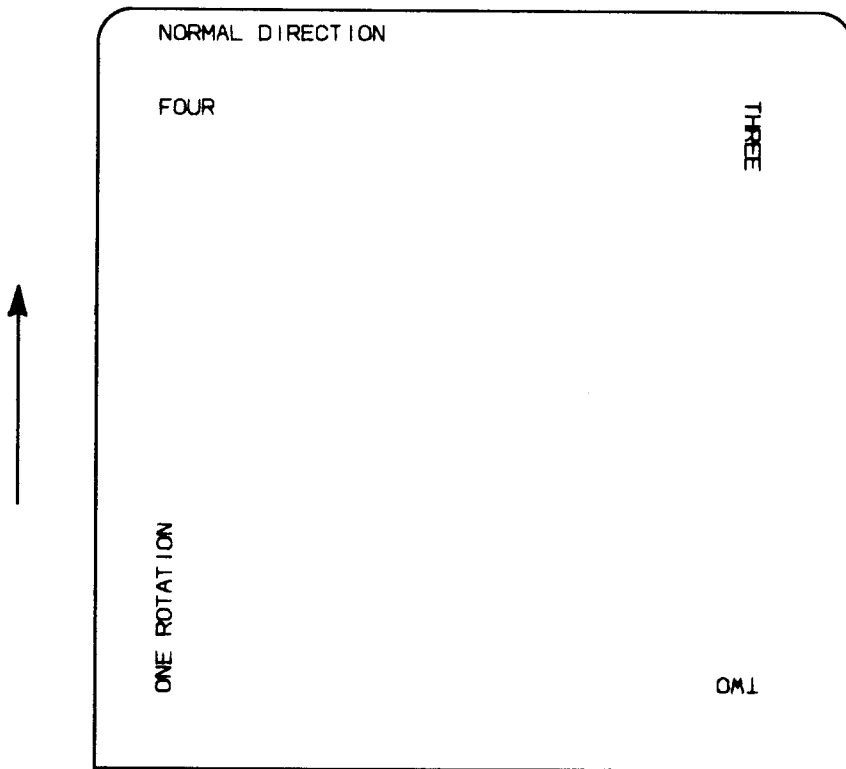

**Special Notes**

- Do not combine the <ESC>R command and the <ESC>% command (see Page 1-63) in the same data stream.
- A custom graphic is not affected by the <ESC>R command. Therefore, always design and locate your graphic image to print in the appropriate orientation.

## Sequential Numbering

### Command Structure

<ESC>**F**aaabccc

**aaa** = Number to repeat the same data (001–999)  
**b** = Plus or minus symbol (+ for increments; – for decrements)  
**ccc** = Value of step for sequence (001–999)

**Example:** <ESC>**F002–005**

**Placement:** Preceding the starting value to be incremented or decremented

**Default:** None

### Command Function

To allow the ability to print sequential fields (text, bar codes) where all incrementing is done within the printer. Up to eight different sequential fields can be specified per label. Sequencing is effective for up to 8–digit numeric data within each field.

### How to Use

#### Input to Printer:

```
<ESC>A
<ESC>H100<ESC>V100<ESC>L0101<ESC>MSERIAL NO:
<ESC>H150<ESC>V200<ESC>L0303<ESC>F001+002<ESC>M1001
<ESC>Q2
<ESC>Z
```

*(Continued on the next page...)*

**How to Use**

(...Continued from previous page)

**Printer Output:**

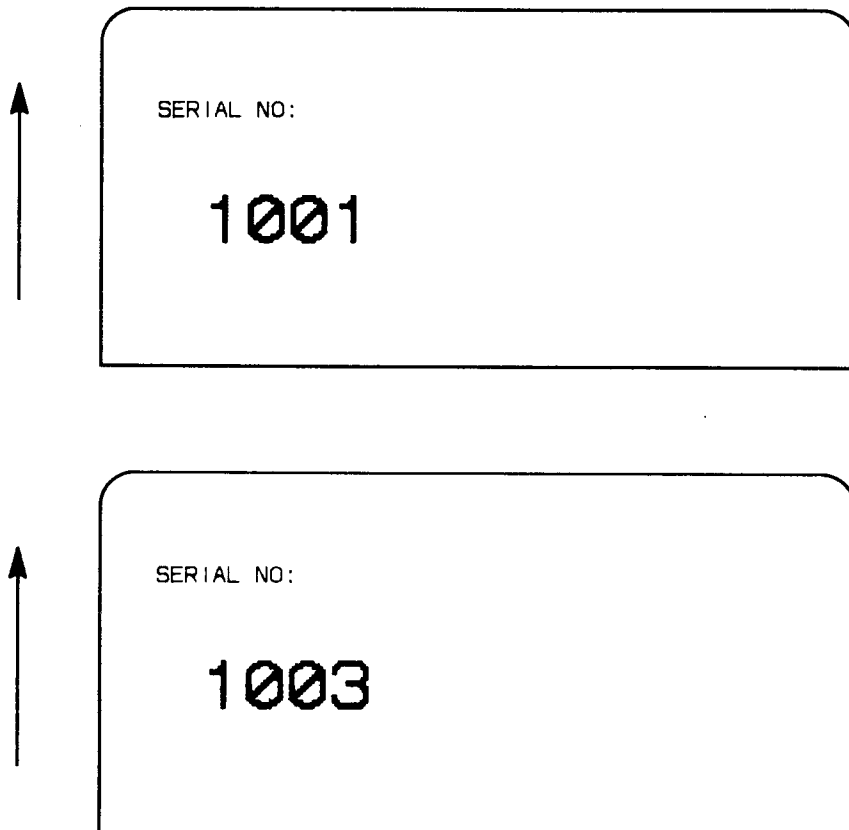

**Special Notes**

- The value specified for Print Quantity (see Page 1-53) should be equal to the number of different sequential values desired multiplied by the number of repeats specified.

Example: To print 2 sets each of the numbers 1001 – 1025 on separate labels, we need 50 total labels. The commands would be as follows:

```
<ESC>A  
<ESC>H100<ESC>V100<ESC>F002+001<ESC>M1001  
<ESC>Q50  
<ESC>Z
```

- It is necessary to specify the print position for each sequential field on a label.

---

## Start/Stop Label

---

**Command Structure**Start Command: <ESC>**A**Stop Command: <ESC>**Z****Example:** See above**Placement:** <ESC>A must precede data; <ESC>Z must follow data**Default:** None**Command Function**

For all print jobs, the Start command must precede the data, and the Stop command must follow. The print job will not run properly if these are not in place.

**How to Use****Input to Printer:**

```
<ESC>A
<ESC>H100<ESC>V100<ESC>L0303<ESC>MSATO
<ESC>H100<ESC>V200<ESC>B103100*M8400*
<ESC>H220<ESC>V310<ESC>L0101<ESC>S*M8400*
<ESC>Q1
<ESC>Z
```

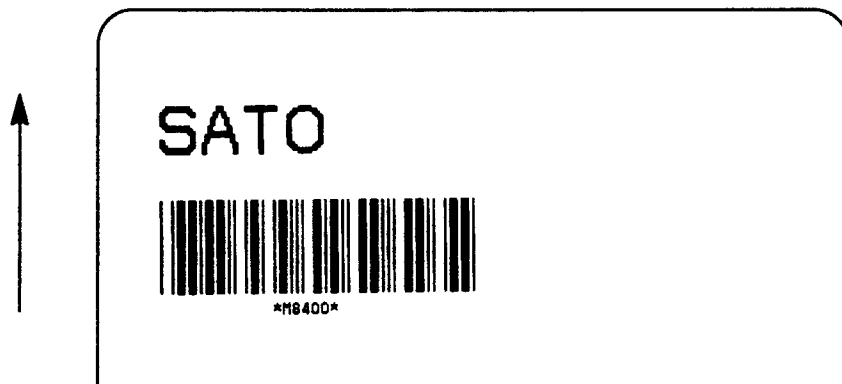
**Printer Output:**



**Special Notes**

- When using the RS232 Serial interface or the 10-job buffer with the Centronics Parallel interface, **<STX>** and **<ETX>** must frame the entire print job (see Section 2 – Interface Specifications).
- When using the 10-job buffer option, **<ESC>A** will only be used once, while **<ESC>Z** will end each of the 10 jobs (see Section 2 – Interface Specifications).

## Store Form Overlay

### Command Structure

<ESC>&

**Example:** See above

**Placement:** Must be preceded by all other data and placed just before the Stop command (<ESC>Z)

**Default:** None

### Command Function

To store a specified label image in the volatile form overlay memory. Only one label image may be stored in this memory area at a time. Form overlays are not compiled when they are called to be printed. Therefore, labels may print somewhat faster than if you are using the Print Job method.

### How to Use

#### Input to Printer:

```
<ESC>A
<ESC>H200<ESC>V150<ESC>L0303<ESC>M123456
<ESC>H200<ESC>V250<ESC>B103100*123456*
<ESC>&
<ESC>Z
```

#### Printer Output:

No output from this command. Above images will be stored in the form overlay image area. See the Recall Form Overlay command example (Page 1-55) to see the resulting printed output.

### Special Notes

- Remember that this storage is volatile. Therefore, if the printer loses power, the overlay must be sent again.
- The overlay is recalled using the Recall Form Overlay command (see Page 1-55).
- This form overlay memory should be cleared before trying to store another form. Use the <ESC>\* & command (see Page 1-27).
- To store multiple print jobs in battery-backed memory, use the Store/Recall Print Job commands (see Pages 1-72 and 1-56).
- This command cannot be used in conjunction with the Expanded Print Length command (Page 1-37).

## Store Print Job

**Command Structure**

<ESC>, **aa**

**aa** = Job identification number  
 01 – 07 Job 1 – Graphic 1  
 01 – 15 Job 2 – Graphic 0

**Example:** <ESC>, **01**

**Placement:** Must follow <ESC>A and precede all print data to be stored

**Default:** None

**Command Function**

To store a print job onto an optional memory card of the M-8400 printer. The memory card is battery-backed up and will not be affected by a loss of power. Up to eight individual jobs may be stored at a time and each job has a size limitation of 8K bytes.

**How to Use**

**Input to Printer:**

```
<ESC>A
<ESC>, 01
<ESC>H200<ESC>V150<ESC>B103100*123456*
<ESC>H200<ESC>V300<ESC>L0202<ESC>WL1123456
<ESC>Z
```

**Printer Output:**

No output from this command. Above images will be stored on the memory card. See the Recall Print Job command example (Page 1-56) for the resulting printed output.

**Special Notes**

- **You must have the optional memory card to use this command.** Call your local SATO representative for information.
- Use the Recall Print Job command (see Page 1-56) to recall jobs from the memory card for printing.
- The number of jobs currently stored on the memory card can be verified through the front panel operations.
- If a data transmission error occurs while sending the data, the printer will beep and display the message “CARD ERROR”.

## Vector Font

### Command Structure

Specify Vector Font: <ESC>\$**a, b, c, d**

Data for Vector Font: <ESC>\$=(**data**)

- a** = A Helvetica Bold (proportional spacing)
- B Helvetica Bold (fixed spacing)
- b** = Font width (24–512 dots\*)
- c** = Font height (24–512 dots\*)
- d** = Font variation (0–9) as follows:
  - 0 Standard
  - 1 Standard open (outlined)
  - 2 Gray (mesh) pattern 1
  - 3 Gray (mesh) pattern 2
  - 4 Gray (mesh) pattern 3
  - 5 Standard open, lt. shadow
  - 6 Standard open, dk. shadow
  - 7 Standard mirror image
  - 8 Italic
  - 9 Italic open (outlined)

\* The value range for b and c is dictated by the values chosen for a and d as shown in the following chart.

**Font Width and Height Ranges**

	a = A	a = B
<b>d = 0</b>	b or c = 24– <sup>435</sup> 512 dots	b or c = 24–470 dots
<b>d = 1–9</b>	b or c = 64– <sup>435</sup> 512 dots	b or c = 64–470 dots

- Example:** <ESC>\$**A, 100, 200, 0**<ESC>\$=**123456**
- Placement:** Immediately preceding data to be printed
- Default:** None (Font S is used if no font command is specified)

### Command Function

To specify printing of the unique SATO vector font. The vector font allows large characters to be printed with smooth, round edges. Each character is made of a number of vectors (or lines), and will require slightly more printer compiling time.

### How to Use

#### Input to Printer:

```
<ESC>A  
<ESC>H100<ESC>V100<ESC>$A,100,100,0<ESC>$=SATO  
<ESC>H100<ESC>V210<ESC>$=VECTOR FONT  
<ESC>H100<ESC>V300<ESC>$A,200,300,2<ESC>$=M-8400  
<ESC>Q1  
<ESC>Z
```

#### Printer Output:

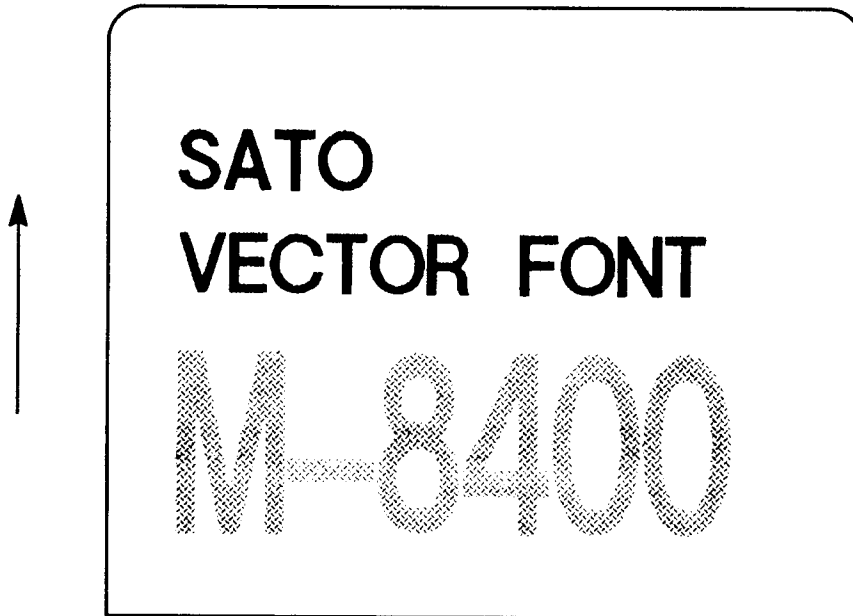

### Special Notes

- Once the vector font is specified, all subsequent text will print as that type until another font is specified or until the end of the print job.

## SECTION 2

# INTERFACE SPECIFICATIONS

### INTRODUCTION

---

This section presents the interface specifications for the M-8400. These specifications include detailed information on how to properly interface your printer with your host system.

The following information is presented in this section:

- M-8400 Interface Types
- Using the Receive Buffer
- RS232C Serial Interface
  - General Specifications
  - Electrical Specifications
  - Pin Assignments
  - Ready/Busy Protocol
  - X-ON/X-OFF Protocol
  - Bi-Directional Communication Protocol
  - Loop Back Test
- Centronics Parallel Interface
- Accessory (EXT) Connector

### M-8400 INTERFACE TYPES

---

In order to provide flexibility in communicating with a variety of host computer systems, the M-8400 comes standard with two interface types. The Centronics Parallel interface will probably be the most useful in communicating with IBM PCs and compatibles. The RS232C Serial interface allows connectivity to a number of other hosts. For instructions on how to properly configure your M-8400 for either of these interface types, see the Printer Configuration in Section 2 of the M-8400 Operator's Manual.

### USING THE RECEIVE BUFFER

---

The M-8400 has the ability to receive a data stream from the host in one of two ways. The receive buffer may be configured to accept one (1) print job at a time or up to ten (10) print jobs at a time. See Mode I of the Printer Configuration in Section 2 of the M-8400 Operator's Manual for instructions on how to set the receive buffer size.

- 1 Job Buffer**                      The printer receives and prints one job at a time. Each job must not exceed 8K bytes (not including graphic data).
  
- 10 Job Buffer**                    The printer receives up to 10 jobs at a time and starts printing after the receipt of the last job. Each job must not exceed 8K bytes (graphic data cannot be used when using a 10 job buffer).

**RS232C SERIAL INTERFACE**

---

**RS232C General Specifications**

---

- Asynchronous ASCII**    Half-duplex communication.
  
- Protocol**                      Ready/Busy (Pin 20, DTR Hardware Flow Control)  
                                       X-ON/X-OFF (Software Flow Control)  
                                       Bi-Directional Communication (ENQ/Response)
  
- Data Transmission Rate**    300, 600, 1200, 2400, 4800, 9600, and 19200 bps
  
- Character Breakdown**    – 1 start bit (Fixed)  
                                       – 7 or 8 data bits (Selectable)  
                                       – **Odd, Even, No Parity** (Selectable)  
                                       – 1 or 2 Stop Bits (Selectable)

**RS232C Electrical Specifications**

---

- Connector on Printer**    DB-25S (Female)
  
- Cable Required**            DB-25P (Male, Printer End, 50' Max Length). For cable configuration, refer to *Cable Requirements* appropriate to the RS232C protocol chosen.

**RS232C Pin Assignments**

---

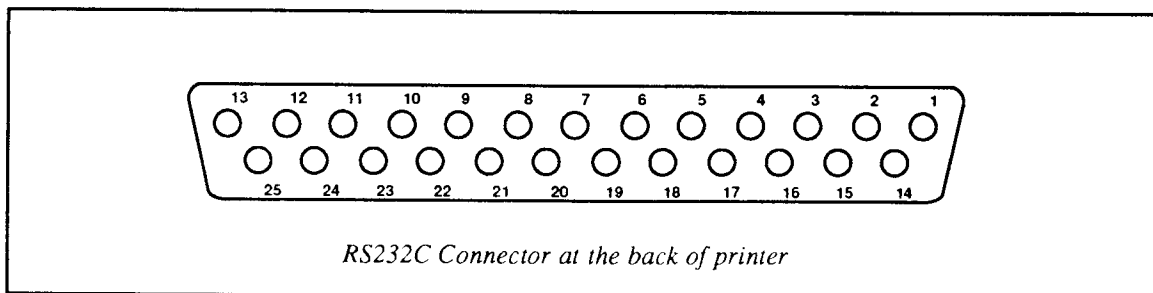

**Grounds:**

**Pin #1**                      **FG (Frame Ground)**

**Pin #7**                      **SG (Signal Ground)**

**Input Signals:**

**Pin #3**                      **RD (Receive Data)** Data to the printer from the host computer

**Pin #5**                      **CTS (Clear to Send)** When this line is high, the printer assumes that data is ready to be transmitted. The printer will not receive the data when this line is low. If you are not using this line as specified, tie it high (to Pin # 4).

**Pin #6**                      **DSR (Data Set Ready)** When this line is high, the printer will be ready to receive data. This line must be high before data is transmitted. For convenience, you can make a loop by combining Pin #4 and #5. Do not leave this line free (open).

**Output Signals:**

**Pin #2**                      **TD (Transmit Data)** Data from the printer to the host computer. Sends X-ON/X-OFF characters or status data (Bi-Directional Protocol).

**Pin #4**                      **RTS (Request to Send)** There are two possible ways to use the RTS signal, both of which apply to the Ready/Busy protocol. Refer to Section 3 (Mode I) to set RTS to do one of the following:

1. **PCI RS On** RTS is high when the printer is on, even during an error status (e.g., paper out, etc.).
2. **PCI RS On/Off** RTS is high and remains high unless either the print head is opened during a non-error condition (in this instance, RTS would return to high after the print head is closed and the printer is put back on-line) or an error condition occurs during printing (e.g., ribbon out, stock out).

**Pin #20**                      **DTR (Equipment Ready)** This signal applies to the Ready/Busy protocol. The printer is ready to receive data when this pin is high. It goes low during any of the following:

- Off-line
- During printing



## RS232C Ready/Busy Protocol

The Ready/Busy protocol is the hardware flow control method on the M-8400. By raising/lowering the voltage level on Pin #20 of the RS232 port, the printer notifies the host when it is ready to receive data. Pin #4 (RTS) and Pin #20 (DTR) are the important signals on the printer for this protocol. The host must be capable of supporting this flow control method for it to function properly.

### Cable Requirements

Host		Printer
FG	-----	1 FG (Frame Ground)
TD	----->	3 RD (Receive Data)
		4 RTS (Request to Send)
		5 CTS (Clear to Send)
		6 DSR (Data Set Ready)
*	<-----	20 DTR (Equipment Ready)
SG	-----	7 SG (Signal Ground)

\* This connection at the host side of the interface would depend upon the pin that is being used as the Ready/Busy signal by the driving software. Typically, on a PC, it would be either CTS (Pin #5) or DSR (Pin #6) on a 25-pin RS232 connector.

## Data Streams

Once the flow control method has been chosen for the RS232C interface, the data stream must be sent in a specific manner. The STX and ETX must now frame the data stream. For the 10 Job Buffer, note how the <ESC>A is only sent once.

Buffer Size	Data Stream
1 Job Buffer	<STX><ESC>A..Job#1..<ESC>Z<ETX>
10 Job Buffer	<STX><ESC>A..Job#1..<ESC>Z..Job#2.....<ESC>Z..Job#10..<ESC>Z<ETX>

*NOTE: All characters, including STX, ESC, and ETX, are in ASCII.*

## RS232C X-ON/X-OFF Protocol

X-ON/X-OFF flow control is used whenever hardware (Ready/Busy) flow control is not available or desirable. Instead of a voltage going high/low at Pin #20, characters representing "Printer Ready" (X-ON = ASCII 11H) or "Printer Busy" (X-OFF = ASCII 13H) are transmitted by the printer on Pin #2 (TD) to the host. In order for this protocol to function correctly, the host must be capable of supporting it. X-ON/X-OFF operates in a manner similar to the function of Pin #20 (DTR) as explained previously. When the printer is first powered up and goes on-line, an X-ON is sent out. When the printer receives a viable job, it sends out an X-OFF and begins printing. When it is done printing, it transmits an X-ON. When the printer is set on-line/off-line manually, the printer sends out X-ON/X-OFF. If an error occurs during the printing (paper out, ribbon out), the printer sends nothing, since the last character sent was X-OFF. When the error is cleared and the printer resumes printing, no X-ON is sent until the current job is completed and the printer is once again ready to receive the next job.

### Cable Requirements

Host		Printer
FG	-----	1 FG (Frame Ground)
RD	←-----	2 TD (Transmit Data)
TD	-----→	3 RD (Receive Data)
	┌-----	4 RTS (Request to Send)
	└-----	5 CTS (Clear to Send)
	┌-----	6 DSR (Data Set Ready)
	└-----	20 DTR (Data Terminal Ready)
SG	-----	7 SG (Signal Ground)

### Data Streams

The data streams for X-ON/X-OFF are constructed the same as they are for the Ready/Busy protocol.

Buffer Size	Data Stream
1 Job Buffer	<STX><ESC>A...Job#1...<ESC>Z<ETX>
10 Job Buffer	<STX><ESC>A...Job#1...<ESC>Z...Job#2.....<ESC>Z...Job#10...<ESC>Z<ETX>

NOTE: All characters, including STX, ESC, and ETX, are in ASCII.

**Note:** Since the printer will not buffer any characters after the X-OFF is issued, it may be necessary to transmit “pad” characters (approximately five capital X characters) after the <ETX> of each data stream to ensure the <STX> of the next data stream is not lost.

Example: <STX><ESC>A ...JOB#1<ESC>Z<ETX>XXXXX

## RS232C Bi-Directional Communication Protocol

This protocol allows two-way communication between the host computer and the printer, thus enabling the host to check printer status. When this protocol is selected, there is no busy signal from the printer (DTR, Pin #20, is always high). The host **must** request the complete status from the printer, including ready/busy. Whenever the host requests a printer status, it transmits ENQ to the printer and the printer will then respond with its status within 1 – 100 milliseconds. If printing, it will respond upon finishing the current label or tag, then resume printing. In order for this protocol to function properly, verify that Pins #6 (DSR) and # 5 (CTS) are held high, as shown on the previous page.

### Cable Requirements

The cable requirements are the same as those for X-ON/X-OFF. See page 2-6.

### Printer Status

The form of the status response from the printer will be:

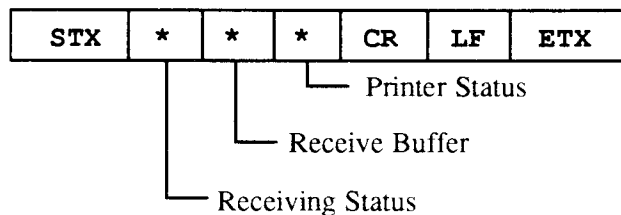

CR = Carriage Return  
 LF = Line Feed

The message is framed with STX/ETX.

The first character after STX gives the following **received message** status:

- 0 = Data stream received with no errors
- 1 = Error in data stream (e.g., interface error; data stream greater than 8K)

The second character after STX gives the state of the receiving buffer:

- 0 = Receive Buffer Empty
- 9 = Receive Buffer Full

The third character after STX gives the printer status:

- E = Print Head Open
- @ = Ribbon Out

- A = Paper Out
- B = Cutter Error (Jam, etc.)
- E = Print Head Open
- G = Print Head Element Failure
- 0 = Printer On-Line
- 1 = Printer Off-line

There is a certain priority given to this printer status as follows:

<u>Priority</u>		<u>Status</u>
1	E	= Print Head Open
2	@	= Ribbon Out
3	A	= Paper Out
4	G	= Print Head Element Failure
5	B	= Cutter Error

This priority is given so that if the head is open and there is a cutter error, only 45H will be sent back as a printer status, etc.

### Printer Ready/Busy

With the Bi-Directional protocol, as mentioned earlier, the host must request the complete printer status including ready/busy. When the host sends ENQ to the printer, and receives back the following message, the printer is ready to receive new data.

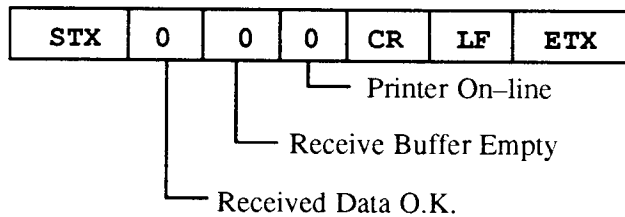

If the response to the ENQ is as follows, then the printer is busy.

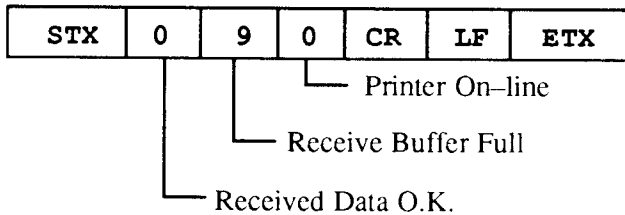

In effect, the receive buffer status defines whether the printer is ready to receive data or is busy printing.

The situation is similar when using the 10 job buffer. The receive buffer will show full when it receives ETX, whether ETX follows 3 jobs or 10 jobs. For example:

```
<STX><ESC>A--Job#1--<ESC>Z-----Job#2--<ESC>Z-----Job#3--<ESC>Z<ETX>
```

Once these three jobs are terminated by ETX and an ENQ is sent, the above “busy” message will be returned to the host.

**Software Reset Command**

A software reset or “cancel” command is available only in this Bi-Directional mode. This command allows the host computer to clear the job buffer of the current job being printed (1 job buffer in use). It clears the way for the printer to accept a new job or jobs. If the printer is printing, it will stop and clear the current job (1 job buffer).

In order to clear the buffer, the host transmits only the cancel command at any time:

**Standard**

CAN = 18H

**Non-standard**

CAN = 21H = !

This will reset the printer as described.

**RS232C Loop Back Test**

This serial loop back test is accessed from Mode S on the front panel and is intended to thoroughly exercise the RS232 serial port for correct operation. In order to perform this test, a single DB-25P serial connector configured as shown below is required.

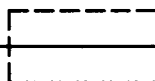
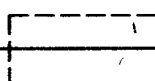
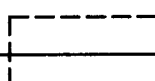
	<b>Printer</b>
	2 TD (Transmit Data) 3 RD (Receive Data)
	4 RTS (Request to Send) 5 CTS (Clear to Send)
	6 DSR (Data Set Ready) 20 DTR (Equipment Ready)

NOTE: Once this loop back test is initiated, it requires 7 minutes and 10 seconds to complete. If an error occurs during the test, the display will read “LOOP BACK

FAILED”. The test is completed successfully if ENTER or F1 is pressed and the printer comes out of loop back test mode.

This test will check all combinations of the following:

- A. Baud Rates: 300, 600, 1200, 2400, 4800, 9600, 19,200
- B. Parity: Odd, Even, None
- C. Data Bits: 7, 8
- D. Stop Bits: 1, 2
- E. The data transferred during the test will be the following ASCII characters:

8 bit data: 00 → FF<sub>H</sub>

7 bit data: 00 → 7F<sub>H</sub>

## CENTRONICS PARALLEL INTERFACE

---

### Centronics Electrical Specifications

---

**Connector on Printer** AMP 57-40360 (DDK) (Standard IBM Compatible Parallel Printer Connector)

**Cable Required** AMP 57-30360 (DDK) or Equivalent (Standard IBM Parallel Printer Cable, 6' Max Length)

#### Data Streams

Buffer Size	Data Stream
1 Job Buffer	<ESC>A..Job#1..<ESC>Z
10 Job Buffer	<STX><ESC>A..Job#1..<ESC>Z..Job#2.....<ESC>Z..Job#10..<ESC>Z<ETX>

*NOTE: All characters, including STX, ESC, and ETX are in ASCII.*

Note that for parallel communications, the STX and ETX characters are only required for the 10-Job Buffer Mode. However, in the 1 Job Buffer, if STX / ETX frame one data stream, these two control characters will be disregarded.

## ACCESSORY (EXT) CONNECTOR

The accessory (or EXT) connector on the M-8400 rear panel is intended for use with external printer accessories such as label rewinders or applicators. The 14-pin Centronics-type connector provides a choice of (4) different output signals along with various error conditions.

### Pin Assignments

#### Pin #1

**Label Out** The signal on Pins 1, 3, and 4 each have an open collector output (see Figure A). This pin normally measures +0.7V maximum when no error condition exists. If a label out occurs, the voltage will drop to 0V. To achieve a maximum of +5V, you must add a 1K, 1/4 W pull-up resistor between Pin 1 and Pin 13 (see Figure B). This will provide +5V for no error condition and 0V when there exists a label out condition.

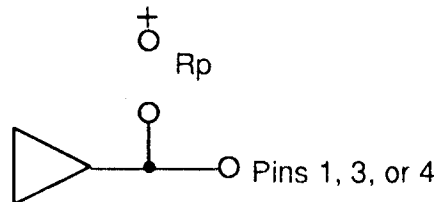

Figure A

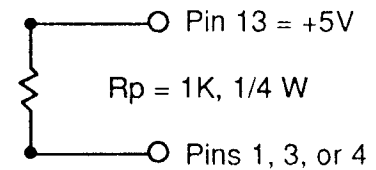

Figure B

#### Pin #2

**Signal Ground**

#### Pin #3

**Ribbon Out** Normally measures +0.7V maximum for no error condition, but will drop to 0V when a ribbon out condition exists. May be increased to a maximum of +5V for a no error condition (see Figure B).

#### Pin #4

**Head Open** Normally measures +0.7V maximum for no error condition, but will drop to 0V when a head open condition exists. May be increased to a maximum of +5V for a no error condition (see Figure B).



**Pin #5**

**Print Start** If a switch is connected between Pin 5 and Pin 14 (see Figure C), you will be able to control the ability of the M-8400 to print. When S1 is closed, the M-8400 will print. If S1 is left open, the M-8400 will not print.

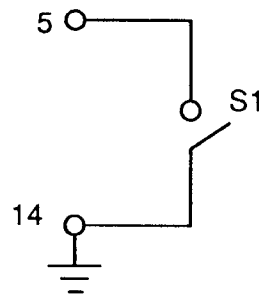

Figure C

**Pin #6**

**External Signal** This signal is used to drive an applicator or other external device requiring synchronization to the print cycle. Use a 1K, 1/4 W pull-up resistor to achieve a range from 0V to +5V. You may choose between different types of output signals from the Operator Panel. See Mode S of the Printer Configuration in Section 2 of the M-8400 Operator's Manual. The output signals are shown on the next page.

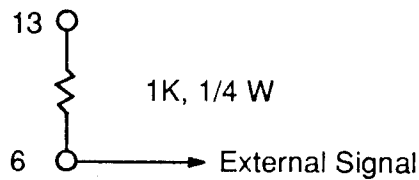

Figure D

**Pin #10**

**+12V**

**Pin #12**

**+24V** This signal is used to power the optional automatic label rewinder.

**Pin #13**

**+5V**

**Pin #14**

**Frame Ground**

### External Output Signals

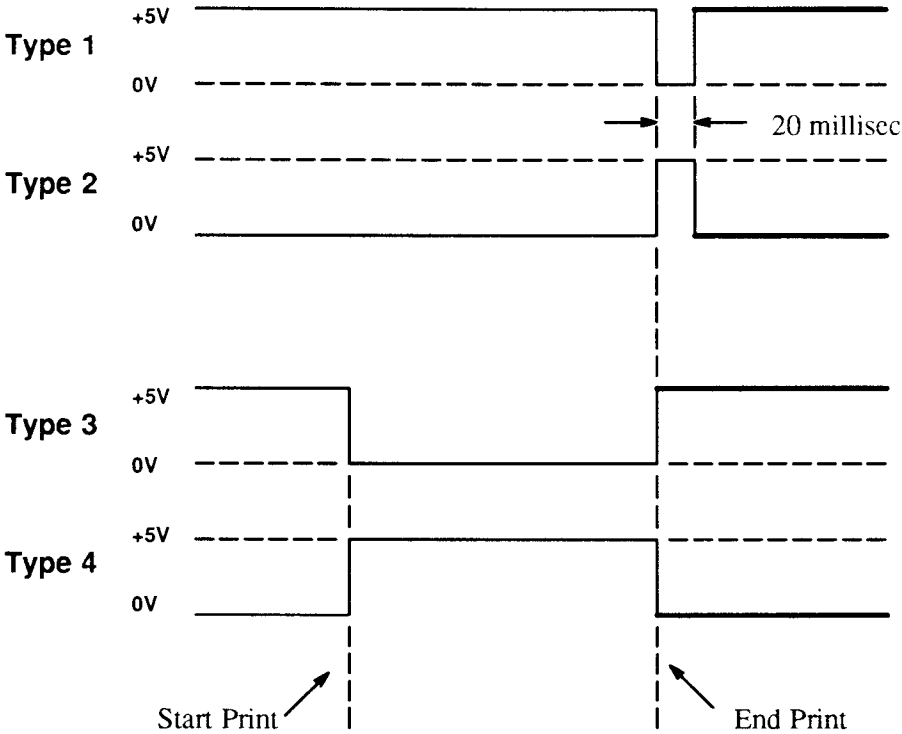

NOTE: +5V is available on the "EXT" connector at Pin 6 only if a 1KΩ pull-up resistor is installed as shown in Figure D on the previous page. Otherwise, the maximum voltage is 0.7V.

## SECTION 3 TROUBLESHOOTING

This section has been devised to help you if you are unable to produce output on the M-8400 printer. Use this section to make sure the basics have been checked before deciding you are unable to proceed any further. The section is divided into five parts:

- Initial Checklist
- Using the Centronics (Parallel) Interface
- Using the RS232C (Serial) Interface
- If the Password is Lost
- Setting for Direct Thermal Mode

### INITIAL CHECKLIST

1. Is the printer powered up and *on-line*?
2. Is the ERROR light on the front panel OFF? If this light is on, it may mean the print head assembly is open.
3. Are the LABEL and RIBBON lights on the front panel OFF? If these lights are on, labels/tags or ribbons may be loaded incorrectly. For instructions on how to load them correctly, see Section 2 of the M-8400 Operator's Manual.
4. Is the label sensor adjusted appropriately for the label/tag stock you're using? Make sure the sensor is mechanically adjusted to cover an I-Mark or feed slot if your stock has one or the other. Verify that you've chosen the appropriate sensor: Sensor 4 is used with label backing or feed slots in tags; Sensor 5 is used with I-Marks on labels or tags; "Not Used" is for continuous form labels. (See Mode S of the Printer Configuration in Section 2 of the M-8400 Operator's Manual.)
5. Make sure you've configured the appropriate interface type in Mode I, RS232C or CENTRONICS, consistent with the interface you're intending to use. (See Mode I of the Printer Configuration in Section 2 of the M-8400 Operator's Manual.)
6. If you've been changing the settings on the printer and cannot figure out what you may have done, you can always return to the SATO Factory Defaults or User Defaults from Mode S of the configuration. (See the Mode S *Factory Default option* and *User Default option* of the Printer Configuration in Section 2 of the M-8400 Operator's Manual.)

## USING THE CENTRONICS (PARALLEL) INTERFACE

---

1. Is the IBM parallel printer cable connected securely to your parallel port (DB-25S Female) on the PC and to the Centronics connector on the printer?
2. Is there more than one parallel port on your PC (LPT1:, LPT2:, etc.)? If so, make sure you are sending data out the correct port.
3. When you send the print job to the printer, and it does not respond, do you get an error message on your PC that says “Device Fault” or something similar?

This may mean that the computer doesn’t know the printer’s there. Verify that:

- A. Both ends of the cable are securely inserted into their respective connectors.
  - B. The printer is ON-LINE.
  - C. The cable is not defective. There are other things that can cause this error message on your computer, but at this stage, a defective cable may be one of the reasons.
4. When you send the print job to the printer and it does not respond, and there is no error message on the PC:

- A. Check your data stream for some of the basics. Is your job framed as follows?

```
<ESC>A--DATA--<ESC>Z
```

- B. Verify that you’ve included all required parameters in the data stream.
- C. Verify the following:
  - You have not typed a “0” (zero) for an “O” (letter) or vice-versa.
  - You have not missed any <ESC> characters where they are needed.
  - Your Proto-Codes are set for Standard or Non-Standard (Mode I) and your data stream is consistent with these.
- D. Verify that your Receive Buffer Size is configured for 1-Item or 10-Items and your data stream is consistent with this choice. Remember for the 10-Item Buffer, your data stream should look like:

```
<STX><ESC>A--JOB#1--<ESC>Z--JOB#2--<ESC>Z--JOB#10--<ESC>Z<ETX>
```

5. If you've checked all of the above and the printer still isn't printing, you may want to use the Print Receive Buffer feature (Hex Dump) to determine what (if anything) the printer is receiving from your host computer.
  - A. Select Mode T from the operator panel (see Section 2 of the Operator's Manual).
  - B. Choose the appropriate label size.
  - C. Choose "Print Receive Buffer"
  - D. Press ENTER.
  - E. Press F1.
  - F. Press LINE.
  - G. The printer display panel should show:

QTY 0001
-------------

The Centronics port is now listening for incoming data. Send your print job. The M-8400 will now print (only once) a Hex Dump of everything it received from the host computer. Each 2-digit Hex character represents a character the M-8400 received. It may be tedious, but now you can analyze and troubleshoot the data stream. If you need another Hex Dump, you'll need to repeat Steps A–G above. After printing the Hex dump, the M-8400 is ready to receive a print job in the normal printing mode.

**NOTE:** To use the Print Receive Buffer feature, the printer must be set for the Standard Proto-Code set. See Mode T of the Printer Configuration in the M-8400 Operator's Manual for more information.

6. While checking the Hex Dump printout, if you notice 0D 0A (Carriage Return and Line Feed) characters throughout, and you are using BASIC, you may need to add a statement to your program. The "WIDTH" statement helps to suppress these extra 0D 0A characters. See the beginning of Section 1 – M-8400 Programming for details on writing a program in BASIC.

If you're not programming in BASIC, check to see if you have an equivalent statement in the language you're using to suppress extra carriage returns and line feeds from your data being sent out to the printer. We want the data stream to be one complete line going to the printer.

## USING THE RS232C (SERIAL) INTERFACE

---

1. Is the RS232C Serial cable connected securely to your serial port on the PC (DB-25S Male or DB-9S Male) and to the RS232C connector on the printer?
2. Is the cable defective? At the very least, you should be using a "Null Modem Cable", which crosses pins in a specific manner. This should enable your M-8400 to print. But we recommend that you eventually use a cable built to the specifications as described in Section 2 – Interface Specifications.

3. Check for obvious errors in the data stream. Remember that all print jobs for serial data must be framed by an STX and ETX. Again, see Section 2 if necessary.
4. If after sending your job to the printer, it only “beeps” and displays a “framing error” message, you may have a configuration problem. There may be some inconsistencies with the Baud Rate, Parity, Data Bits, or Stop Bits in relation to your host computer. If you are confused as to what the printer’s current RS232 settings are, you may choose the SATO Defaults to achieve 9600 baud, no parity, 8 databits, and 1 stop bit. Then you may select Mode S from the front panel to change any of the parameters accordingly.
5. If you still are unable to get printer output, try the Print Receive Buffer feature as described in the above Centronics Interface Troubleshooting section or see Mode T of the Printer Configuration in the M-8400 Operator’s Manual. In this case, the M-8400 monitors its RS232C interface for incoming data.
6. From the Hex Dump, if you are seeing extra 0D 0A characters, and are using BASIC, refer to the beginning of the M-8400 Programming section. It provides hints for writing a SATO program in BASIC.

## IF THE PASSWORD IS LOST

---

If the password has been set to a value that has been forgotten or lost, the user will not be able to get past Mode U in the Printer Configuration. To find the current password or to change the password, do the following:

1. Take printer off-line.
2. Press ENTER to get to Mode U.
3. Press an arrow key to get to “Press Enter to Continue”.
4. Press ENTER.
5. At the prompt for “Enter Password”, enter 999.
6. Press ENTER twice.
7. At the second prompt for “Enter Password”, enter 001.
8. Proceed to Mode S options to view or change the current password.

For more information, see Mode S of the Printer Configuration in Section 2 of the M-8400 Operator’s Manual.

## SETTING FOR DIRECT THERMAL MODE

---

Since the default print method on the M-8400 is Thermal Transfer, the printer will be expecting a ribbon to be installed along with the label/tag stock. If a ribbon is not found, a Ribbon Error will be detected at the printer power-up, and you will not be able to change the configuration for Direct Thermal mode. To get into the printer configuration without a ribbon installed, you must do the following:

1. Power off the printer.
2. Press and hold LINE on the operator panel.
3. With the LINE key depressed, power on the printer.
4. When the printer beeps, release the LINE key.
5. The printer display should show "OFFLINE".
6. Proceed normally to Mode S and select "Set Print Method To: Direct".

For more information, see Mode S of the Printer Configuration in Section 2 of the M-8400 Operator's Manual.

**APPENDIXES**

**APPENDIX A: COMMAND CODES QUICK REFERENCE CHART**

Command Codes Quick Reference Chart ..... A-1

**APPENDIX B: BAR CODE SPECIFICATIONS**

Rotated Bar Codes ..... B-1  
 Bar Code Symbolologies ..... B-2  
     Codabar ..... B-2  
     Code 39 ..... B-3  
     Interleaved Two of Five (I 2/5) ..... B-4  
     UPC-A/EAN-13 ..... B-5  
     EAN-8 ..... B-7  
     Industrial Two of Five ..... B-8  
     Matrix Two of Five ..... B-9  
     Code 128 – Method 1 ..... B-10  
     MSI ..... B-11  
     Code 93 ..... B-11  
     UPC-E ..... B-12  
     Bookland (UPC Supplements) ..... B-13  
     Code 128 – Method 2 ..... B-15  
         Code 128 Character Table ..... B-17

**APPENDIX C: CUSTOM CHARACTERS AND GRAPHICS**

Custom-Designed Characters Example ..... C-1  
 Custom Graphics Example ..... C-4  
 Battery-Backed Custom Graphics Example ..... C-8

**APPENDIX D: SETTING THE USER DEFAULTS**

Setting the User Defaults ..... D-1

**APPENDIX E: USING THE M-8400 OPTIONAL FEATURES**

Ribbon Saver ..... E-1  
 Label Rewinder ..... E-2  
 Label Cutter ..... E-3  
 Label Dispenser ..... E-4

**APPENDIX F: CHARACTER TABLES**

Character Tables ..... F-1



## APPENDIX A

# COMMAND CODES QUICK REFERENCE CHART

---

This section contains a Quick Reference Chart of the M-8400 command codes, for use by those already somewhat familiar with the programming language. The codes are listed in alphabetical order by the first letter or symbol that follows the <ESC> control character (this assumes use of the Standard Proto-Code set). With each command code, you will find a brief description, the command structure, and a reference page for a full description of the command in Section 1.

Instruction	Description	Page
<ESC>:		
<b>A</b>	<b>Start code.</b> Begins all print jobs.	<b>1-69</b>
<b>A (space) &lt;ESC&gt;Z</b>	<b>Form Feed.</b> Creates a blank tag or label.	<b>1-42</b>
<b>AR</b>	<b>Expanded Print Length.</b> Resets the maximum print length to 7" (178mm) from the print length set by <ESC>AX.	<b>1-37</b>
<b>AX</b>	<b>Expanded Print Length.</b> Sets the maximum print length to 14" (356mm).	<b>1-37</b>
<b>A3HaaaVbbbb</b>	<b>Base Reference Point.</b> Establishes a new base reference point for the current label.  <b>aaa</b> = Horizontal Print Offset (001-832 dots) <b>bbbb</b> = Vertical Print Offset (0001-1424 dots)	<b>1-14</b>
<b>Babbccc</b>	<b>Bar Codes.</b> Prints a 1:3 ratio bar code.  <b>a</b> = 0 Codabar 1 Code 39 2 Interleaved 2 of 5 (I 2/5) 3 UPC-A / EAN-13 4 EAN-8 5 Industrial 2 of 5 6 Matrix 2 of 5 7 <i>reserved</i> 8 <i>reserved</i> 9 Code 128 A MSI B <i>reserved</i> C Code 93 D <i>reserved</i> E UPC-E F Bookland G Code 128  <b>bb</b> = Number of dots (01-12) for narrow bar and narrow space  <b>ccc</b> = Bar height in dots (001-600)	<b>1-8</b>

Instruction	Description	Page
<ESC>:		
<b>BDabbccc</b>	<b>Bar Codes.</b> Prints a 2:5 ratio bar code, except for UPC and EAN symbols, which are fixed width bar codes. <i>For values a, bb, and ccc, see instructions for &lt;ESC&gt;Babbccc.</i>	1-8
<b>BTabbccdde</b>	<b>Bar Codes – Variable Ratio.</b> Provides the ability to print a bar code with a ratio other than those specified through the standard bar code commands (B, BD, and D).  <b>a</b> = Bar code option: 0 Codabar 1 Code 39 2 Interleaved 2 of 5 5 Industrial 2 of 5 6 Matrix 2 of 5 <b>bb</b> = Narrow space in dots (01-99) <b>cc</b> = Wide space in dots (01-99) <b>dd</b> = Narrow bar in dots (01-99) <b>ee</b> = Wide bar in dots (01-99)	1-10
<b>BWaabbb</b>	<b>Bar Codes – Variable Ratio.</b> Works together with the <ESC>BT command to specify an expansion factor and the bar code height for the particular symbol being printed.  <b>aa</b> = Expansion factor by which the width of all bars and spaces is increased (01-12) <b>bbb</b> = Bar height by dot (004-600 dots)	1-12
<b>C</b>	<b>Repeat Label.</b> Prints a duplicate of the last label printed.	1-58
<b>CSa</b>	<b>Print Speed Selection.</b> Specifies a unique print speed through software for a particular label.  <b>a</b> = Designates the speed selection: 1 = 2 in/sec (50 mm/sec)      3 = 4 in/sec (100 mm/sec) 2 = 3 in/sec (75 mm/sec)      4 = 5 in/sec (125 mm/sec)	1-54
<b>Dabbccc</b>	<b>Bar Codes.</b> Prints 1:2 ratio bar code. For UPC and EAN bar codes, this will add descender bars. <i>For values a, bb, and ccc, see instructions for &lt;ESC&gt;Babbccc.</i>	1-8
<b>Ea</b>	<b>Line Feed.</b> Provides the ability to print multiple lines of the same character size without specifying a new print position for each line.  <b>a</b> = Number of dots (1-999) between the bottom of the characters on one line to the top of the characters on the next line	1-47

Instruction	Description	Page
<p>&lt;ESC&gt;:</p> <p><b>Faaabccc</b></p>	<p><b>Sequential Numbering.</b> Allows the printing of sequencing fields (text, bar codes) where all incrementing is done within the printer.</p> <p><b>aaa</b> = Number to repeat the same data (001–999)  <b>b</b> = Plus or minus symbol (+ for increments; – for decrements)  <b>ccc</b> = Value of step for sequence (001–999)</p>	1–67
<p><b>FWaaHb</b></p>	<p><b>Horizontal Line.</b> Prints a horizontal line.</p> <p><b>aa</b> = Width of the horizontal line in dots (01–99)  <b>b</b> = Length of horizontal line in dots (1–832)</p>	1–45
<p><b>FWaaccHbVd</b></p>	<p><b>Box.</b> Prints a box. <i>For values aa, b, cc, and d, see instructions for horizontal and vertical lines.</i></p>	1–45
<p><b>FWccVd</b></p>	<p><b>Vertical Line.</b> Prints a vertical line.</p> <p><b>cc</b> = Width of vertical line in dots (01–99)  <b>d</b> = Length of vertical line in dots (1–1424; 1–2848 for expanded labels)</p>	1–45
<p><b>GHaaabbb (data)</b></p>	<p><b>Custom Graphics.</b> Allows the creation and printing of graphic images using a dot–addressable matrix.</p> <p><b>H</b> = Specifies a Hex data stream is to follow  <b>aaa</b> = Number of horizontal 8 x 8 blocks (001–104)  <b>bbb</b> = Number of vertical 8 x 8 blocks (001–177; 001–354 for 14" label)  <b>(data)</b> = Hex data to describe the graphic image</p>	1–32
<p><b>GIHaaabbbcc (data)</b></p>	<p><b>Store Custom Graphics – Battery Backed Memory Card.</b> Stores a graphic image in the optional memory card to be called later for printing on a label.</p> <p><b>H</b> = Specifies a Hex data stream is to follow  <b>aaa</b> = Number of horizontal 8 x 8 blocks (001–104)  <b>bbb</b> = Number of vertical 8 x 8 blocks (001–177; 001–354 for 14" label)  <b>cc</b> = Register number (01–99)  <b>(data)</b> = Hex data to describe the graphic image</p>	1–33

Instruction	Description	Page
<p>&lt;ESC&gt;:</p> <p><b>GRcc</b></p>	<p><b>Recall Custom Graphics – Battery Backed Memory Card.</b> Recalls for printing the graphic image stored by the &lt;ESC&gt;GI command.</p> <p><b>cc</b> = Register number (01–99)</p>	1–33
<p><b>Ea</b></p>	<p><b>Horizontal Position.</b> Specifies a field's horizontal location from the current base reference point.</p> <p><b>a</b> = Number of dots horizontally from the base reference point (1–max*)  * The maximum will be 832 dots across the width of the label and 1424 dots (2848 dots for expanded labels) down the length of a label.</p>	1–51
<p><b>J</b></p>	<p><b>Journal Print.</b> Provides the ability to print text line by line.</p>	1–43
<p><b>KaH90bb</b></p>	<p><b>Recall Custom–Designed Characters.</b> Recalls for printing a custom character stored by the &lt;ESC&gt;Tabcc (data) command.</p> <p><b>a</b> = 1 16 x 16 matrix  2 24 x 24 matrix</p> <p><b>H</b> = Indicates that a hex data stream was stored</p> <p><b>bb</b> = Memory location where the character was stored. Valid locations are 21 hex to 52 hex.</p>	1–31
<p><b>Laabb</b></p>	<p><b>Character Expansion.</b> Expands characters in both directions.</p> <p><b>aa</b> = Multiple to expand horizontally (01–12)</p> <p><b>bb</b> = Multiple to expand vertically (01–12)</p>	1–21
<p><b>M</b></p>	<p><b>Font type.</b> Specifies the 13W x 17L dot matrix font (13 x 20 with descenders).</p>	1–38
<p><b>N</b></p>	<p><b>Rotation – Moving Base Reference Point.</b> Sets the original base reference point and returns printing to normal orientation.</p>	1–65
<p><b>OA</b></p>	<p><b>Font type.</b> Specifies the OCR–A font with 22W x 32L dot matrix.</p>	1–38
<p><b>OB</b></p>	<p><b>Font type.</b> Specifies the OCR–B font with 21W x 30L dot matrix.</p>	1–38

Instruction	Description	Page
<ESC>:		
<b>Paa</b>	<p><b>Character Pitch.</b> Designates the number of dots between characters</p> <p><b>aa</b> = Number of dots between characters (01–99)</p>	1–23
<b>Qa</b>	<p><b>Print Quantity.</b> Specifies the total number of labels to print.</p> <p><b>a</b> = Total number of labels to print for the job (1–9999)</p>	1–53
<b>R</b>	<p><b>Rotation – Moving Base Reference Point.</b> Rotates the printing of all subsequent images by 90° counterclockwise each time it is used. Also moves the base reference point.</p>	1–65
<b>S</b>	<p><b>Font type.</b> Specifies the 8W x 12L dot matrix font (8 x 15 with descenders).</p>	1–38
<b>TaHbb (data)</b>	<p><b>Store Custom–Designed Characters.</b> To create and store custom characters or images in the printer’s volatile memory. See &lt;ESC&gt;Kab90cc to recall the character for printing.</p> <p><b>a</b> = 1 16 x 16 matrix 2 24 x 24 matrix</p> <p><b>H</b> = Specifies a Hex data stream is to follow</p> <p><b>bb</b> = Memory location to store the character. Valid locations are 21 hex to 52 hex</p> <p><b>(data)</b> = Hex data to describe the character</p>	1–31
<b>U</b>	<p><b>Font type.</b> Specifies the 5W x 7L dot matrix font (5 x 9 with descenders).</p>	1–38
<b>Vb</b>	<p><b>Vertical Position.</b> Specifies a field’s vertical location from the current base reference point.</p> <p><b>b</b> = Number of dots vertically from the base reference point (1–max*) * The maximum will be 832 dots across the width of a label and 1424 dots (2848 for expanded labels) down the length of a label.</p>	1–51

Instruction	Description	Page
<p>&lt;ESC&gt;:</p> <p><b>Wa</b></p>	<p><b>Character Tables.</b> Specifies one of the ten SATO International Character Tables.</p> <p><b>a</b> = 0 IBM 850 Character Table  1-7 SATO International Character Tables  8 <i>reserved</i>  9 SATO Character Table</p>	1-25
<p><b>WA(elements)</b></p>	<p><b>Calendar Print.</b> Specifies the printing of a date and/or time field from the printer's internal clock.</p> <p><b>(elements)</b> = YY Year  MM Month  DD Day  hh Hour  mm Minute</p>	1-18
<p><b>WBa</b></p>	<p><b>Font type.</b> Specifies the 18W x 26 L dot matrix (including descenders) font (18 x 30 with descenders).</p> <p><b>a</b> = 0 Disables auto-smoothing of font  1 Enables auto-smoothing of font</p>	1-40
<p><b>WDHaaaVbbbb XcccYdddd</b></p>	<p><b>Copy Image Area.</b> To copy an image to another location of the label.</p> <p><b>aaa</b> = Horizontal position of the top left corner of image area  <b>bbbb</b> = Vertical position of the top left corner of image area  <b>ccc</b> = Horizontal length of image area  <b>dddd</b> = Vertical length of image area</p>	1-29
<p><b>WLa</b></p>	<p><b>Font type.</b> Specifies the 28W x 44L dot matrix font (28 x 52 with descenders).</p> <p><b>a</b> = 0 Disables auto-smoothing of font  1 Enables auto-smoothing of font</p>	1-40

Instruction	Description	Page
<p>&lt;ESC&gt;:</p> <p><b>WPab</b></p>	<p><b>Calendar Increment.</b> Specifies a value to be added to the printer's current date and/or time for printing.</p> <p><b>a</b> = Y Years M Months D Days h Hours</p> <p><b>b</b> = Numeric data: Years (1-9), Months (01-99), Days (001-999), Hours (001-999)</p>	1-16
<p><b>WTAabbccdee</b></p>	<p><b>Calendar Set.</b> To set the date and time in the printer's internal clock.</p> <p><b>aa</b> = Year (01-99) <b>bb</b> = Month (01-12) <b>cc</b> = Day (01-31) <b>dd</b> = Hour (00-23) <b>ee</b> = Minute (00-59)</p>	1-20
<p><b>Z</b></p>	<p><b>Stop code.</b> Ends all print jobs.</p>	1-69
<p><b>%a</b></p>	<p><b>Rotation – Fixed Base Reference Point.</b> Rotates printing in 90 degree increments without changing the base reference point.</p> <p><b>a</b> = 0 Sets print to normal direction 1 Sets print to 90° counterclockwise 2 Sets print to 180° rotated (upside down) 3 Sets print to 270° counterclockwise (90° clockwise)</p>	1-63
<p><b>§a, b, c, d</b></p>	<p><b>Vector font.</b> Specifies printing of the unique SATO vector font.</p> <p><b>a</b> = A Helvetica Bold (proportional spacing) B Helvetica Bold (fixed spacing)</p> <p><b>b</b> = Font width (24-512 dots*)</p> <p><b>c</b> = Font height (24-512 dots*)</p> <p><b>d</b> = Font variation (0-9) as follows:</p> <p>0 Standard 1 Standard open (outlined) 2 Gray (mesh) pattern 1 3 Gray (mesh) pattern 2 4 Gray (mesh) pattern 3 5 Standard open, lt. shadow 6 Standard open, dk. shadow 7 Standard mirror image 8 Italic 9 Italic open (outlined)</p> <p style="text-align: right;"><i>...Continued on next page...</i></p>	1-73



Instruction	Description	Page												
<ESC>:  ...Continued...	<p>* The value range for b and c is dictated by the values chosen for a and d as shown in the following chart.</p> <table border="1" data-bbox="391 499 1252 728"> <thead> <tr> <th colspan="3" data-bbox="391 499 1252 548">Font Width and Height Ranges</th> </tr> <tr> <th data-bbox="391 548 531 596"></th> <th data-bbox="531 548 886 596">a = A</th> <th data-bbox="886 548 1252 596">a = B</th> </tr> </thead> <tbody> <tr> <td data-bbox="391 596 531 661">d = 0</td> <td data-bbox="531 596 886 661">b or c = 24–512 dots</td> <td data-bbox="886 596 1252 661">b or c = 24–470 dots</td> </tr> <tr> <td data-bbox="391 661 531 728">d = 1–9</td> <td data-bbox="531 661 886 728">b or c = 64–512 dots</td> <td data-bbox="886 661 1252 728">b or c = 64–470 dots</td> </tr> </tbody> </table>	Font Width and Height Ranges				a = A	a = B	d = 0	b or c = 24–512 dots	b or c = 24–470 dots	d = 1–9	b or c = 64–512 dots	b or c = 64–470 dots	
Font Width and Height Ranges														
	a = A	a = B												
d = 0	b or c = 24–512 dots	b or c = 24–470 dots												
d = 1–9	b or c = 64–512 dots	b or c = 64–470 dots												
\$=(data)	Data for Vector font.	1-73												
#Ea	<b>Print Darkness.</b> Specifies a new print darkness setting.  <b>a</b> = Print darkness value (1–5)	1-50												
(a,b	<b>Reverse Image.</b> Reverses image from black to white and vice versa.  <b>a</b> = Horizontal length (in dots) of reverse image area (8–832) <b>b</b> = Vertical length (in dots) of reverse image area (8–999)	1-61												
,aa	<b>Store Print Job – Battery Backed Memory Card.</b> Stores a print job in the optional memory card to be called later for printing.  <b>aa</b> = Job identification number: 01 – 07    Job 1 – Graphic 1 01 – 15    Job 2 – Graphic 0	1-72												
+aa	<b>Recall Print Job – Battery Backed Memory Card.</b> Recalls for printing a print job stored in the optional memory card.  <b>aa</b> = Job identification number: 01 – 07    Job 1 – Graphic 1 01 – 15    Job 2 – Graphic 0	1-56												
&	<b>Store Form Overlay.</b> Stores a specified label image in the volatile form overlay memory.	1-71												

Instruction	Description	Page
<ESC>:		
/	<b>Recall Form Overlay.</b> Recalls the label image from the form overlay memory for printing.	1-55
0 (zero)	<b>Replace Data (Partial Edit).</b> Provides the ability to replace a specified area of the previous label with new data.	1-59
*	<b>Clear the Receiving Buffer and Compiling Buffer.</b>	1-27
*T	<b>Clear the Custom Character Memory.</b>	1-27
*,	<b>Clear Formats Stored in the Memory Card.</b>	1-27
*&	<b>Clear the Form Overlay Memory.</b>	1-27
*G	<b>Clear Graphics Stored in the Memory Card.</b>	1-27
*X	<b>Clear all buffers and memory areas.</b>	1-27
@	<b>Off-Line.</b> Signals the printer to go off-line after the completion of a print job.	1-49
<NUL>aa	<p><b>Cutter Command.</b> Controls the cutting of labels when using the optional SATO cutter unit.</p> <p><b>aa</b> = Number of labels to print between each cut (00-99)</p>	1-35

## APPENDIX B

# BAR CODE SPECIFICATIONS

This section contains detailed information on the printing of bar codes on your M-8400:

- Rotated Bar Codes
- Bar Code Symbolologies

### ROTATED BAR CODES

On the M-8400, "picket fence" bar codes (normal orientation or 180° rotation) will print at the height specified in the bar code command. For "ladder" bar codes, (90° or 270° rotation), the actual printed height of the bar code may not reflect the height specified in your bar code command. The following table shows the relationship between the specified bar code height and the actual printed height for 90° or 270° rotation.

#### HEIGHT FOR ROTATED (90° OR 270°) BAR CODES

SPECIFIED (DOTS)	ACTUAL (DOTS)	SPECIFIED (DOTS)	ACTUAL (DOTS)
001-015	16	304-319	320
016-031	32	320-335	336
032-047	48	336-351	352
048-063	64	352-367	368
064-079	80	368-383	384
080-095	96	384-399	400
096-111	112	400-415	416
112-127	128	416-431	432
128-143	144	432-447	448
144-159	160	448-463	464
160-175	176	464-479	480
176-191	192	480-495	496
192-207	208	496-511	512
208-223	224	512-527	528
224-239	240	528-543	544
240-255	256	544-559	560
256-271	272	560-575	576
272-287	288	576-591	592
288-303	304	592-600	600

## BAR CODE SYMBOLOGIES

### Codabar

#### Command Structure

1:3 ratio:      <ESC>**B0bbcccd (data) d**  
 2:5 ratio:      <ESC>**BD0bbcccd (data) d**  
 1:2 ratio:      <ESC>**D0bbcccd (data) d**

**bb**            = Width of narrow element in dots (01–12)  
**ccc**           = Bar height in dots (001–600)  
**d**              = Required Start and Stop character (A, B, C, or D)  
**(data)**       = Bar code data

**Codabar Character Set:**    0–9, –, \$, :, /, ., +  
    A, B, C, D (Start/Stop characters)

#### Codabar Density Table

Narrow/Wide Ratio	Value of 'bb'	Density (char/in)
1:3	01	16.9
1:3	02	8.5
2:5	01	9.2
1:2	02	10.2

#### Example

```
<ESC>H100<ESC>V100<ESC>B003100A$12345B
<ESC>H200<ESC>V205<ESC>$12345
```



## Code 39

---

### Command Structure

1:3 ratio:     <ESC>**B**1**bb****ccc**\* (**data**) \*  
 2:5 ratio:     <ESC>**BD**1**bb****ccc**\* (**data**) \*  
 1:2 ratio:     <ESC>**D**1**bb****ccc**\* (**data**) \*

**bb**         =   Width of narrow element in dots (01–12)  
**ccc**        =   Bar height in dots (001–600)  
**\***          =   Required Start and Stop character (asterisk)  
**(data)**     =   Bar code data

**Code 39 Character Set:**    0–9, A–Z, space, \$, %, +, –, ., /  
                               \* (Start/Stop character)

### Code 39 Density Table

Narrow/Wide Ratio	Value of 'bb'	Density (char/in)
1:3	01	12.7
1:3	02	6.4
2:5	01	7.0
1:2	01	15.6
1:2	02	7.8

### Example

```
<ESC>H100<ESC>V100<ESC>B103100*P1234-01*  

<ESC>H275<ESC>V205<ESC>MP1234-01
```



## Interleaved Two of Five (I 2/5)

---

### Command Structure

1:3 ratio:      <ESC>**B2bbccc (data)**  
 2:5 ratio:      <ESC>**BD2bbccc (data)**  
 1:2 ratio:      <ESC>**D2bbccc (data)**

**bb**            = Width of narrow element in dots (01–12)  
**ccc**           = Bar height in dots (001–600)  
**(data)**       = Bar code data (numeric); must be an even number of digits or else the printer will add a leading zero; start and stop code are provided by the printer

**I 2/5 Character Set:** 0–9 (numeric only)

### I 2/5 Density Table

Narrow/Wide Ratio	Value of 'bb'	Density (char/in)
1:3	01	22.6
1:3	02	11.3
2:5	01	12.7
1:2	02	14.5
1:2	03	9.7

### Example

```
<ESC>H95<ESC>V94<ESC>FW06H280
<ESC>H95<ESC>V200<ESC>FW06H280
<ESC>H100<ESC>V100<ESC>B20210012345678901234
<ESC>H100<ESC>V210<ESC>M12345678901234
```



## Notes

- To add horizontal guard bars to the top and bottom of the bar code, use the Line and Box command (see Page 1-45).

## UPC-A/EAN-13

---

### Command Structure

<ESC>**B3bbccc (data)**

<ESC>**D3bbccc (data)**

- bb** = Width of narrow element in dots (01-12)  
**ccc** = Bar height in dots (001-600)  
**(data)** = Bar code data (numeric); must be exactly 13 digits.

To select UPC-A, the first digit must be a zero followed by the 12 digits of UPC-A data. Otherwise, EAN-13 is assumed.

The second digit of the bar code data is the number system character (for UPC-A).

The last digit is a mod10 check digit, which must be supplied by the programmer. It can be determined by using the calculation below.

**UPC-A/EAN-13 Character Set:** 0-9 (numeric only)

### UPC-A/EAN-13 Density Table

Value of 'bb'	Density (char/in)
02	76% nominal
03	114% nominal

## Example

```
<ESC>H70<ESC>V220<ESC>OB0
<ESC>H390<ESC>V220<ESC>OB5
<ESC>H100<ESC>V100<ESC>D3032000012345678905
<ESC>OB 1234567890
```



## Notes

- To achieve 100% or 200% nominal densities, you must order the M-8400 with a 6 dot/mm print head.
- <ESC>D3 provides guide bars that extend longer than the rest of the bar code.

## Calculating the Mod10 Check Digit for UPC-A

If you wish to encode the UPC-A data "01234567890", follow these steps to find the proper check digit:

1. Starting from the left, sum all the characters in the odd positions (that is, first, third, fifth, and so on), the number system character being the first position.

Example:  $0 + 2 + 4 + 6 + 8 + 0 = 20$

2. Multiply the sum obtained in Step 1 by the number 3.

Example:  $20 \times 3 = 60$

3. Again starting from the left, sum all the characters in the even positions.

Example:  $1 + 3 + 5 + 7 + 9 = 25$

4. Add the product of Step 2 to the sum of Step 3.

Example:  $60 + 25 = 85$

5. The mod10 check value is the smallest number that when added to the sum of Step 4 produces a multiple of 10.

Example: If you add 5 to 85, the result is a multiple of 10. Therefore the check digit is 5.



6. Adding the leading zero for UPC-A data as specified, the bar code data should be specified as: 0012345678905.

## EAN-8

### Command Structure

<ESC>**B4bbccc (data)**

<ESC>**D4bbccc (data)**

**bb** = Width of narrow element in dots (01-03)  
**ccc** = Bar height in dots (001-600)  
**(data)** = Bar code data (numeric); must be exactly 8 digits.

**EAN-8 Character Set:** 0-9 (numeric only)

### EAN-8 Density Table

Value of 'bb'	Density (char/in)
02	76% nominal
03	114% nominal

### Example

```
<ESC>H70<ESC>V220<ESC>OB0
<ESC>H310<ESC>V220<ESC>OB5
<ESC>H100<ESC>V100<ESC>D40320040153476
<ESC>OB40153476
```



## Notes

- To achieve 100% or 200% nominal densities, you must order the M-8400 with a 6 dot/mm print head.
- <ESC>D4 provides guide bars that extend longer than the rest of the bar code.

## Industrial Two of Five

---

### Command Structure

1:3 ratio:     <ESC>**B5bbccc (data)**  
 2:5 ratio:     <ESC>**BD5bbccc (data)**  
 1:2 ratio:     <ESC>**D5bbccc (data)**

**bb**         =   Width of narrow element in dots (01–12)  
**ccc**         =   Bar height in dots (001–600)  
**(data)**      =   Bar code data (numeric); must be an even number of digits or else the printer will add a leading zero

**Industrial 2 of 5 Character Set:** 0–9 (numeric only)

### Example

```
<ESC>H95<ESC>V94<ESC>FW06H490
<ESC>H95<ESC>V200<ESC>FW06H490
<ESC>H100<ESC>V100<ESC>B5031001234567890
<ESC>H260<ESC>V210<ESC>M1234567890
```



## Notes

- To add horizontal guard bars to the top and bottom of the bar code, use the Line and Box command (see Page 1–45).

## Matrix Two of Five

---

### Command Structure

1:3 ratio:      <ESC>**B6bbccc (data)**  
 2:5 ratio:      <ESC>**BD6bbccc (data)**  
 1:2 ratio:      <ESC>**D6bbccc (data)**

**bb**            =   Width of narrow element in dots (01–12)  
**ccc**           =   Bar height in dots (001–600)  
**(data)**       =   Bar code data (numeric only); must be an even number of digits or else the printer will add a leading zero

**Matrix 2 of 5 Character Set:** 0–9 (numeric only)

### Example

```
<ESC>H95<ESC>V94<ESC>FW06H355
<ESC>H95<ESC>V200<ESC>FW06H355
<ESC>H100<ESC>V100<ESC>B6031001234567890
<ESC>H200<ESC>V210<ESC>M1234567890
```



### Notes

- To add horizontal guard bars to the top and bottom of the bar code, use the Line and Box command (see Page 1–45).

## Code 128 – Method 1

---

### Command Structure

<ESC>**B9bbcccdeff[eff...eff]**

- bb** = Width of narrow element in dots (01–12)
- ccc** = Bar height in dots (001–600)
- d** = Number of changes from subset to subset to be made (1–9)
- e** = Subset type (A, B, C)
- ff** = Number of data characters to be sent for subset type specified by “e” parameter  
*Note: Based on the number of subsets you select in parameter “d”, parameters “e” and “ff” must be repeated that many times.*
- (data)** = Bar code data (alphanumeric); number of characters must equal the sum of the “ff” parameters; data must be specified in same order as subsets are specified, and be legal characters for that subset type; maximum of **30** characters; Mod103 check digit supplied by printer.

**Code 128 Character Set:** See Code 128 Character Table on Page B–17.

### Code 128 Density Table

Value of 'bb'	Density (char/in)	
	Subsets A, B	Subset C
01	18.5	37.0
02	9.2	18.4
03	6.2	12.4

### Example

The following will select Subset A for the characters “AB”, Subset B for “789”, and Subset C for “123456”:

```
<ESC>H100<ESC>V100<ESC>B9031003A02B03C06AB789123456
<ESC>H240<ESC>V205<ESC>MAB789123456
```



## Notes

- When subset C is chosen, you must specify an even number of data characters because of its interleaved encodation method.
- The length of the bar code data must equal the sum of the “ff” parameters. Also, the order of the subsets must match the order the bar code data is specified.
- To encode ASCII control codes (unprintable characters), you must use Code 128 – Method 2 (see Page B–15).

## MSI

---

1:3 ratio:      <ESC>**B**Abbccc (data) d  
 2:5 ratio:      <ESC>**B**DAbbccc (data) d  
 1:2 ratio:      <ESC>**D**Abbccc (data) d

**bb**            = Width of narrow element in dots (01–12)  
**ccc**           = Bar height in dots (001–600)  
**(data)**       = Bar code data (numeric); maximum of 15 digits  
**d**              = Required check digit

**MSI Character Set:** 0–9 (numeric only)

## Code 93

---

1:3 ratio:      <ESC>**B**Cbbcccdd (data)

**bb**            = Width of narrow element in dots (01–12)  
**ccc**           = Bar height in dots (001–600)  
**dd**            = Length of data (number of digits)  
**(data)**       = Bar code data (alphanumeric); length must match value of parameter “dd”;  
 check digit is supplied by printer.

**Code 93 Character Set:** 0-9, A-Z, -, ., (space), \$, /, +, %

**Code 93 Density Table**

Narrow/Wide Ratio	Value of 'bb'	Density (char/in)
1:3	01	22.5
1:3	02	11.3
1:3	03	7.5

**Example**

```
<ESC>H100<ESC>V100<ESC>BC031001234ABCD
<ESC>H200<ESC>V205<ESC>M1234ABCD
```



**UPC-E**

---

```
<ESC>BEbbccc (data)
<ESC>DEbbccc (data)
```

- bb** = Width of narrow element in dots (01-03)
- ccc** = Bar height in dots (001-600)
- (data)** = Bar code data (numeric); must be exactly 6 digits

**UPC-E Character Set:** 0-9 (numeric only)

## UPC-E Density Table

Value of <b>bb</b>	Density (char/in)
02	76% nominal
03	114% nominal

### Example

```
<ESC>H70<ESC>V220<ESC>OB0
<ESC>H100<ESC>V100<ESC>DE03200123456
<ESC>P01<ESC>H110<ESC>V295<ESC>OB123456
```



### Notes

- To achieve 100% or 200% nominal densities, you must order the M-8400 with a 6 dot/mm print head.
- <ESC>DE provides guide bars that extend longer than the rest of the bar code.

## Bookland (UPC Supplements)

---

<ESC>**BFbbccc (data)**

**bb** = Width of narrow element in dots (01–03)  
**ccc** = Bar height in dots (001–600)  
**(data)** = Bar code data (numeric); must be exactly 2 or 5 digits

**Bookland Character Set:** 0–9 (numeric only)

### Bookland Density Table

Value of 'bb'	Density (char/in)
02	76% nominal
03	114% nominal

### Example

```

<ESC>H120<ESC>V220<ESC>OB0
<ESC>H150<ESC>V100<ESC>D3032220098277211236
<ESC>OB 9827721123
<ESC>H480<ESC>V100<ESC>OB21826
<ESC>H460<ESC>V135<ESC>BF0318921826
<ESC>H270<ESC>V620<ESC>OB0
<ESC>H300<ESC>V500<ESC>D3032220006338952608
<ESC>OB 0633895260
<ESC>H630<ESC>V500<ESC>OB24
<ESC>H610<ESC>V535<ESC>BF0318924

```





## Code 128 – Method 2

---

<ESC>**BGbbccdd (data)**

- bb** = Width of narrow element in dots (01–12)  
**ccc** = Bar height in dots (001–600)  
**dd** = Start code to specify initial subset of bar code data  
 >G Subset A Start code  
 >H Subset B Start code  
 >I Subset C Start code  
**(data)** = Includes bar code data and subset Shift codes; Shift codes are used to change the subset type within the bar code data  
 Shift codes:  
 >E Subset A Shift code  
 >D Subset B Shift code  
 >C Subset C Shift code

**Code 128 Character Set:** See Code 128 Character Table on Page B–17.

### Code 128 Density Table

Value of 'bb'	Density (char/in)	
	Subsets A, B	Subset C
01	18.5	37.0
02	9.2	18.4
03	6.2	12.4

### Example

The following will start in Subset A for the characters "AB", shift to Subset B for "789", then shift to Subset C for "123456":

```
<ESC>H100<ESC>V100<ESC>BG03100>GAB>D789>C123456
<ESC>H200<ESC>V205<ESC>MAB789123456
```



## Code 128 Character Table

VALUE	SUBSET A	SUBSET B	SUBSET C
0	SP	SP	00
1	!	!	01
2	"	"	02
3	#	#	03
4	\$	\$	04
5	%	%	05
6	&	&	06
7	'	'	07
8	(	(	08
9	)	)	09
10	*	*	10
11	+	+	11
12	,	,	12
13	-	-	13
14	.	.	14
15	/	/	15
16	0	0	16
17	1	1	17
18	2	2	18
19	3	3	19
20	4	4	20
21	5	5	21
22	6	6	22
23	7	7	23
24	8	8	24
25	9	9	25
26	:	:	26
27	;	;	27
28	<	<	28
29	=	=	29
30	>	>	30
31	?	?	31
32	@	@	32
33	A	A	33
34	B	B	34
35	C	C	35

## Code 128 Character Table

VALUE	SUBSET A	SUBSET B	SUBSET C
36	D	D	36
37	E	E	37
38	F	F	38
39	G	G	39
40	H	H	40
41	I	I	41
42	J	J	42
43	K	K	43
44	L	L	44
45	M	M	45
46	N	N	46
47	O	O	47
48	P	P	48
49	Q	Q	49
50	R	R	50
51	S	S	51
52	T	T	52
53	U	U	53
54	V	V	54
55	W	W	55
56	X	X	56
57	Y	Y	57
58	Z	Z	58
59	[	[	59
60	\	\	60
61	]	]	61
62	^	^	62
63	_	_	63
64	NUL >(space)	' >(space)	64
65	SOH >!	a >!	65
66	STX >"	b >"	66
67	ETX .#	c .#	67
68	EOT >\$	d >\$	68
69	ENQ >%	e >%	69
70	ACK >&	f >&	70

## Code 128 Character Table

VALUE	SUBSET A	SUBSET B	SUBSET C
71	BEL >'	g >'	71
72	BS >(	h >(	72
73	HT >)	i >)	73
74	LF >*	j *	74
75	VT >+	k >+	75
76	FF >,	l >,	76
77	CR >-	m >-	77
78	SO >.	n >.	78
79	SI >/	o >/	79
80	DLE >0	P >0	80
81	DC1 >1	q >1	81
82	DC2 >2	r >2	82
83	DC3 >3	s >3	83
84	DC4 >4	t >4	84
85	NAK >5	u >5	85
86	SYN >6	v >6	86
87	ETB >7	w >7	87
88	CAN >8	x >8	88
89	EM >9	y >9	89
90	SUB >:	z >:	90
91	ESC >;	{ >;	91
92	FS ><	><	92
93	GS >=	} >=	93
94	RS >>	~ >>	94
95	US >?	DEL >?	95
96	FNC3 >@	FNC3 >@	96
97	FNC2 >A	FNC2 >A	97
98	SHIFT >B	SHIFT >B	98
99	Subset C >C	Subset C >C	99
100	Subset B >D	FNC4 >D	Subset B >D
101	FNC4 >E	Subset A >E	Subset A >E
102	FNC1 >F	FNC1 >F	FNC1 >F
103	SUBSET A START CODE >G		
104	SUBSET B START CODE >H		
105	SUBSET C START CODE >I		

## How To Use Code 128 Character Table

The Code 128 Table lists 105 data values for the three subsets: A, B, and C. Each subset column displays either a single column of data or a double column of data.

- If the subset column displays a single column of data, that is the data to be entered to produce the desired output.
- If the subset column displays a double column of data, the first column contains the desired output, and the second column contains the actual characters to be entered.

For example, look at value 99 in the Code 128 Table:

- If you are currently using Subset A or Subset B, you can change to Subset C by encoding >C.

VALUE	SUBSET A	SUBSET B	SUBSET C
99	Subset C >C	Subset C >C	99
100	Subset B >D	FNC4 >D	Subset B >D
101	FNC4 >E	Subset A >E	Subset A >E
102	FNC1 >F	FNC1 >F	FNC1 >F

### Notes

- When Subset C is chosen, you must specify an even number of data positions because of its interleaved encodation method.
- ASCII Control Codes (unprintable characters) **pertain to Code 128 – Method 2 only.**

## APPENDIX C

# CUSTOM CHARACTERS AND GRAPHICS

### CUSTOM-DESIGNED CHARACTERS EXAMPLE

---

The following example is presented to help you understand the use of the Custom-Designed Characters command. It demonstrates the design and printing of an "arrow" in a 16 x 16 matrix.

**STEP 1:** Determine which matrix size to use:

- 16 dots x 16 dots
- 24 dots x 24 dots

**STEP 2:** Lay out a grid and draw the image on the grid.

- Each square represents one dot
- Blacken squares for each printed dot

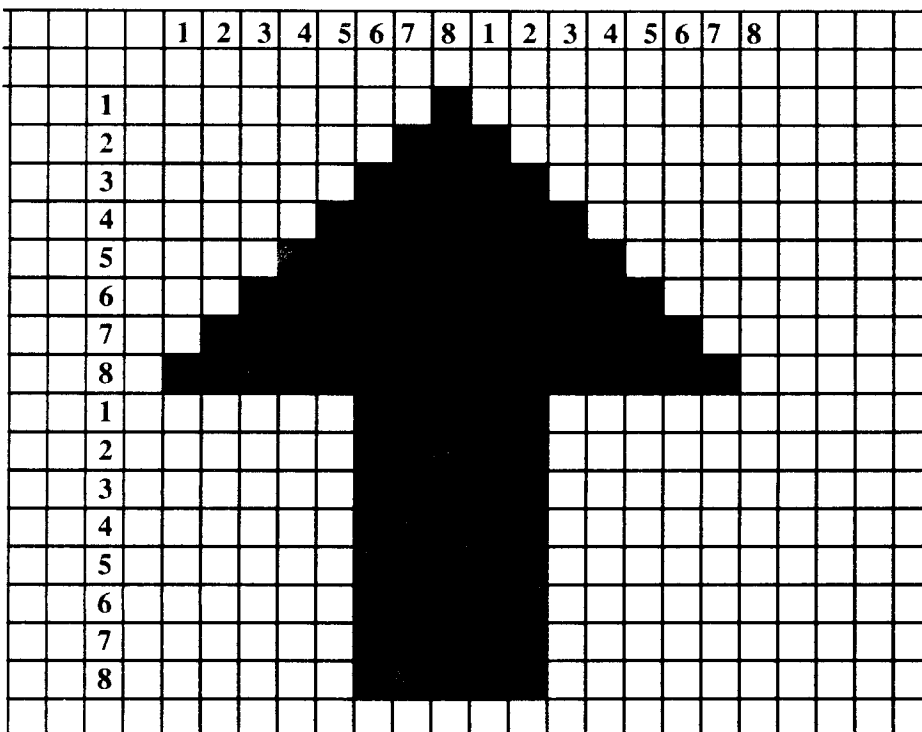

**STEP 3:** Transfer the image into a binary representation, and then into hexadecimal data.

<b>Binary:</b>		<b>Hex:</b>
00000001 00000000		01 00
00000011 10000000		03 80
00000111 11000000		07 C0
00001111 11100000		0F E0
00011111 11110000		1F F0
00111111 11111000		3F F8
01111111 11111100		7F FC
11111111 11111110		FF FE
00000111 11000000		07 C0
00000111 11000000		07 C0
00000111 11000000		07 C0
00000111 11000000		07 C0
00000111 11000000		07 C0
00000111 11000000		07 C0
00000111 11000000		07 C0
00000111 11000000		07 C0
00000111 11000000		07 C0

**STEP 4:** Store the custom character in the printer memory using the hexadecimal data stream in Step 3.

```

<ESC>A
<ESC>T1H3F
0100038007C00FE01FF03FF87FFCFFFE
07C007C007C007C007C007C007C0
<ESC>Z
    
```

**NOTE:** Do not use ASCII <CR> or <LF> characters (carriage return or line feed) as line delimiters within the graphic data or the actual image will not be printed as specified.

**STEP 5:** To recall the custom character from memory to be printed on the label, send the following code to the M-8400. Note that you can print other data as well. Also note how we expanded the size of our character with <ESC>L.

```

<ESC>A
<ESC>L0505<ESC>H150<ESC>V100<ESC>K1H903F
<ESC>L0505<ESC>H600<ESC>V100<ESC>K1H903F
<ESC>L0303<ESC>H125<ESC>V250<ESC>MTHIS SIDE UP!
<ESC>Q1
<ESC>Z
    
```



Printer Output:

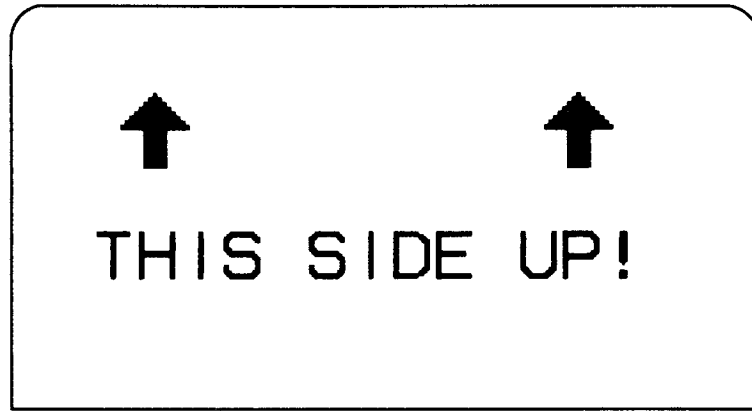

## CUSTOM GRAPHICS EXAMPLE

---

The following example is presented to help you understand the use of the Custom Graphics command. It demonstrates the design and printing of a "diskette" in a 48 x 48 matrix.

**STEP 1:** Determine the matrix size of the graphic. It must be in 8 dot x 8 dot blocks. The example here has 6 blocks horizontally and 6 blocks vertically.

**STEP 2:** Lay out a grid and draw the image on the grid:

- Each square represents one dot
- Blacken squares for each printed dot

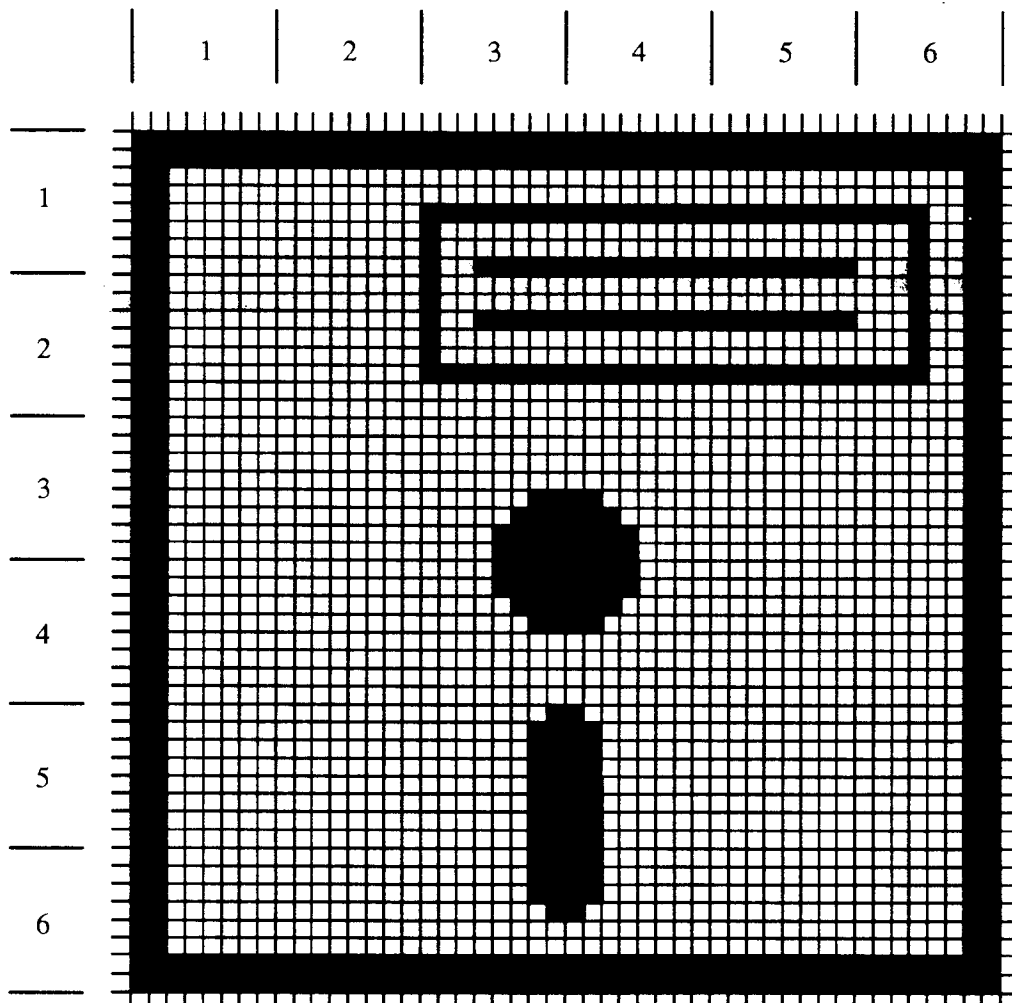

**STEP 3:** Transfer the image into binary representation, and then into hexadecimal data.

**Binary:**

```

1  11111111 11111111 11111111 11111111 11111111 11111111
2  11111111 11111111 11111111 11111111 11111111 11111111
3  11000000 00000000 00000000 00000000 00000000 00000011
4  11000000 00000000 00000000 00000000 00000000 00000011
5  11000000 00000000 11111111 11111111 11111111 11110011
6  11000000 00000000 10000000 00000000 00000000 00010011
7  11000000 00000000 10000000 00000000 00000000 00010011
8  11000000 00000000 10011111 11111111 11111111 00010011
1  11000000 00000000 10000000 00000000 00000000 00010011
2  11000000 00000000 10000000 00000000 00000000 00010011
3  11000000 00000000 10011111 11111111 11111111 00010011
4  11000000 00000000 10000000 00000000 00000000 00010011
5  11000000 00000000 10000000 00000000 00000000 00010011
6  11000000 00000000 11111111 11111111 11111111 11110011
7  11000000 00000000 00000000 00000000 00000000 00000011
8  11000000 00000000 00000000 00000000 00000000 00000011
1  11000000 00000000 00000000 00000000 00000000 00000011
2  11000000 00000000 00000000 00000000 00000000 00000011
3  11000000 00000000 00000000 00000000 00000000 00000011
4  11000000 00000000 00000000 00000000 00000000 00000011
5  11000000 00000000 00000011 11000000 00000000 00000011
6  11000000 00000000 00000111 11100000 00000000 00000011
7  11000000 00000000 00001111 11110000 00000000 00000011
8  11000000 00000000 00001111 11110000 00000000 00000011
1  11000000 00000000 00001111 11110000 00000000 00000011
2  11000000 00000000 00001111 11110000 00000000 00000011
3  11000000 00000000 00000111 11100000 00000000 00000011
4  11000000 00000000 00000011 11000000 00000000 00000011
5  11000000 00000000 00000000 00000000 00000000 00000011
6  11000000 00000000 00000000 00000000 00000000 00000011
7  11000000 00000000 00000000 00000000 00000000 00000011
8  11000000 00000000 00000000 00000000 00000000 00000011
1  11000000 00000000 00000001 10000000 00000000 00000011
2  11000000 00000000 00000011 11000000 00000000 00000011
3  11000000 00000000 00000011 11000000 00000000 00000011
4  11000000 00000000 00000011 11000000 00000000 00000011
5  11000000 00000000 00000011 11000000 00000000 00000011
6  11000000 00000000 00000011 11000000 00000000 00000011
7  11000000 00000000 00000011 11000000 00000000 00000011
8  11000000 00000000 00000011 11000000 00000000 00000011
1  11000000 00000000 00000011 11000000 00000000 00000011
2  11000000 00000000 00000011 11000000 00000000 00000011
3  11000000 00000000 00000011 11000000 00000000 00000011
4  11000000 00000000 00000001 10000000 00000000 00000011
5  11000000 00000000 00000000 00000000 00000000 00000011
6  11000000 00000000 00000000 00000000 00000000 00000011
7  11111111 11111111 11111111 11111111 11111111 11111111
8  11111111 11111111 11111111 11111111 11111111 11111111

```

**Hex:**

```

1   FF FF FF FF FF FF
2   FF FF FF FF FF FF
3   C0 00 00 00 00 03
4   C0 00 00 00 00 03
5   C0 00 FF FF FF F3
6   C0 00 80 00 00 13
7   C0 00 80 00 00 13
8   C0 00 9F FF FF 13
1   C0 00 80 00 00 13
2   C0 00 80 00 00 03
3   C0 00 9F FF FF 13
4   C0 00 80 00 00 13
5   C0 00 80 00 00 13
6   C0 00 FF FF FF F3
7   C0 00 00 00 00 03
8   C0 00 00 00 00 03
1   C0 00 00 00 00 03
2   C0 00 00 00 00 03
3   C0 00 00 00 00 03
4   C0 00 00 00 00 03
5   C0 00 03 C0 00 03
6   C0 00 07 E0 00 03
7   C0 00 0F F0 00 03
8   C0 00 0F F0 00 03
1   C0 00 0F F0 00 03
2   C0 00 0F F0 00 03
3   C0 00 07 E0 00 03
4   C0 00 03 C0 00 03
5   C0 00 00 00 00 03
6   C0 00 00 00 00 03
7   C0 00 00 00 00 03
8   C0 00 00 00 00 03
1   C0 00 01 80 00 03
2   C0 00 03 C0 00 03
3   C0 00 03 C0 00 03
4   C0 00 03 C0 00 03
5   C0 00 03 C0 00 03
6   C0 00 03 C0 00 03
7   C0 00 03 C0 00 03
8   C0 00 03 C0 00 03
1   C0 00 03 C0 00 03
2   C0 00 03 C0 00 03
3   C0 00 03 C0 00 03
4   C0 00 01 80 00 03
5   C0 00 00 00 00 03
6   C0 00 00 00 00 03
7   FF FF FF FF FF FF
8   FF FF FF FF FF FF

```

**STEP 4:** Using the hex data, send the following code to print the graphic image as designed:

```

<ESC>A
<ESC>H100<ESC>V100
<ESC>GH006006
FFFFFFFF FFFFFFFF C0000000003
C0000000003 C000FFFFFF3 C0008000013
C0008000013 C0009FFFFFF13 C0008000013
C0008000013 C0009FFFFFF13 C0008000013
C0008000013 C0009FFFFFF3 C0000000003
C0000000003 C0000000003 C0000000003
C0000000003 C0000000003 C00003C00003
C00007E00003 C0000FF00003 C0000FF00003
C0000FF00003 C0000FF00003 C00007E00003
C00003C00003 C00000000003 C00000000003
C00000000003 C00000000003 C00001800003
C00003C00003 C00003C00003 C00003C00003
C00003C00003 C00003C00003 C00003C00003
C00003C00003 C00003C00003 C00003C00003
C00003C00003 C00001800003 C00000000003
C00000000003 FFFFFFFF FFFFFFFF
<ESC>H200<ESC>V100<ESC>WB1PLEASE PLACE YOUR DISKETTES
<ESC>H200<ESC>V150<ESC>WB1IN A SAFE PLACE !!
<ESC>Q1
<ESC>Z

```

**NOTE:** Spaces in the example above are for emphasis only. Spaces must not be encoded within the graphic portion of the printer data stream. Also do not use ASCII <CR> or <LF> characters (carriage return or line feed) as line delimiters within the graphic data or the actual image will not be printed as specified.

**Printer Output:**

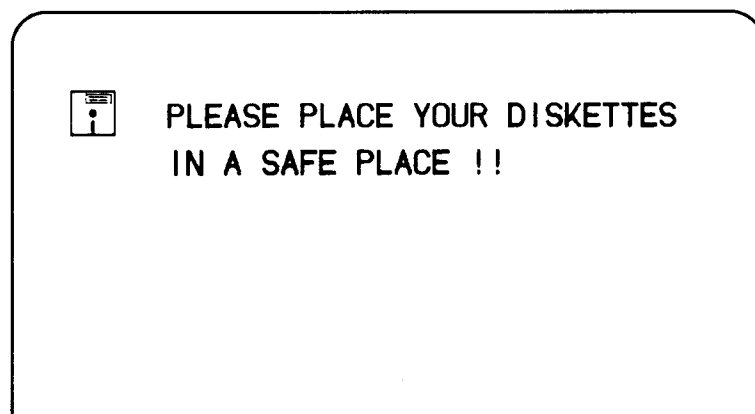

## BATTERY-BACKED CUSTOM GRAPHICS EXAMPLE

The following description will refer to the same image as designed in the Custom Graphics example (see Page C-4). The difference is that two (2) data streams must be sent to the printer (as opposed to one) for printer output.

**STEPS 1, 2, and 3** are the same steps followed for the Custom Graphics Example (see Page C-4).

**STEP4:** Using hex data, send the following code to store the graphic image on the optional memory card:

```
<ESC>A
<ESC>GIH00600601
FFFFFFFFFFFF FFFFFFFFFF C0000000003
C0000000003 C000FFFFFFFF3 C0008000013
C0008000013 C0009FFFFFF13 C0008000013
C0008000013 C0009FFFFFF13 C0008000013
C0008000013 C0009FFFFFF3 C0000000003
C0000000003 C0000000003 C0000000003
C0000000003 C0000000003 C00003C00003
C00007E00003 C0000FF00003 C0000FF00003
C0000FF00003 C0000FF00003 C00007E00003
C00003C00003 C00000000003 C00000000003
C00000000003 C00000000003 C00001800003
C00003C00003 C00003C00003 C00003C00003
C00003C00003 C00003C00003 C00003C00003
C00003C00003 C00003C00003 C00003C00003
C00003C00003 C00001800003 C00000000003
C00000000003 FFFFFFFFFF FFFFFFFFFF
<ESC>Z
```

**STEP 5:** Send the following code to recall the graphic image from the optional memory card and generate printer output:

```
<ESC>A
<ESC>H100<ESC>V100<ESC>GR01
<ESC>H200<ESC>V100<ESC>WB1PLEASE PLACE YOUR DISKETTES
<ESC>H200<ESC>V150<ESC>WB1IN A SAFE PLACE !!
<ESC>Q1
<ESC>Z
```

**NOTE:** Spaces in the example above are for emphasis only. Spaces must not be encoded within the graphic portion of the printer data stream. Also do not use ASCII <CR> or <LF> characters (carriage return or line feed) as line delimiters within the graphic data or the actual image will not be printed as specified.

**Printer Output:**



## APPENDIX D

# SETTING THE USER DEFAULTS

This section contains information on creating a data stream to send to the printer, which sets the User Defaults on the M-8400 printer. The User Defaults depend on the application and allow you to maintain desirable settings on the printer if the configuration is accidentally changed. The User Default data stream begins with a unique command code followed by 48 fields of data as explained below.

**User Default Command Code.** The following command tells the M-8400 that you will be sending User Default information: `<ESC>#G,`

**1. Pitch Offset (8 positions).** On the M-8400, the length (pitch) of a label is either detected automatically by the printer or is entered by the user. Once the pitch is known, the Pitch Offset allows you to adjust this value for unique label stock considerations. It may be adjusted in a positive or negative direction, based on the value you select for the Pitch Offset Scale (#28). If you choose the "mm scale", the offset has a range of  $\pm 50$  mm. If you instead choose the "dot scale", the offset has a range of 0 – 2000 dots. Following is a breakdown on how to find this offset value:

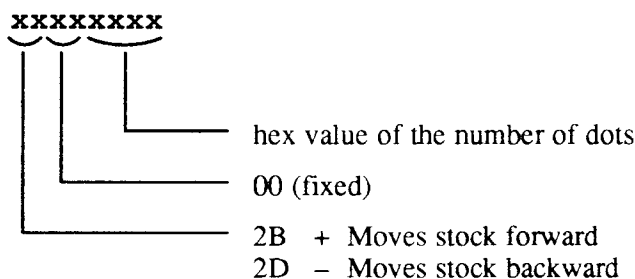

Example 1: If you need a Pitch Offset of -38 mm

$$\begin{aligned}
 (-38 \text{ mm}) (8 \text{ dots/mm}) &= -304 \text{ dots} \\
 &= -130_{\text{H}} \text{ dots}
 \end{aligned}$$

Pitch Offset = 2D000130



**Example 2:** If you need a Pitch Offset of 1 1/4 inch:

(1.25 in) (25.4 mm/in) = 31.75 mm  
(31.75 mm) (8 dots/mm) = 254 dots  
= FD<sub>H</sub> dots

Pitch Offset = 2B0000FD

## 2. Sensor Type

- 00 = Reflective Sensor (for use with I-Mark)
- 01 = See-thru Sensor (for use with Backing Paper or Feed-Slot)
- 02 = Sensor not used (for Continuous Form Printing)
- 03 = Reserved (Do Not Use)

*Note: See also #21 (Pitch Size-mm), #26 (Pitch Detection) and #27 (Pitch Size – dots)*

## 3. Printer Mode

- 00 = Thermal Transfer
- 01 = Direct Thermal

## 4. Fixed 00

## 5. Ribbon Saver Installed

- 00 = No
- 01 = Yes

**6. Memory Card Configuration (2 positions).** This informs the printer how the optional memory card is configured.

- 00 = Formats & Graphics (1:1)
- 01 = Formats Only
- 02 = Graphics Only
- 03 = Fonts Only

## 7. Cutter Installed

- 00 = No
- 01 = Yes

## 8. Fixed 00

**9. Dispenser Installed**

00 = No  
01 = Yes

**10. Receive Buffer Size**

00 = 1 Job Buffer  
01 = 10 Job Buffer

**11. Interface Type**

00 = Serial  
01 = Parallel

**12. Baud Rate (Serial Interface)**

00 = 300 Baud  
01 = 600  
02 = 1,200  
03 = 2,400  
04 = 4,800  
05 = 9,600  
06 = 19,200

**13. Stop Bits (Serial Interface)**

00 = 1 Stop Bit  
01 = 2 Stop Bits

**14. Parity (Serial Interface)**

00 = None  
01 = Even  
02 = Odd

**15. Data Bits (Serial Interface)**

00 = 8 Data Bits  
01 = 7 Data Bits

### 16. Flow Control (Serial Interface)

- 00 = PC1 RS On (Ready/Busy)
- 01 = PC1 RS On/Off (Ready/Busy)
- 02 = X-On/X-Off
- 03 = Status 1 (Reserved, Do Not Use)
- 04 = Status 2 (Bi-Directional)

*Note: See Section 2 – Interface Specifications for details on these protocols.*

### 17. Head Check

- 00 = Disabled
- 01 = Enabled

*Note: See also #24 (Head Check Interval Quantity)*

### 18. Print Darkness

- 00 = 1 (light)
- 01 = 2
- 02 = 3
- 03 = 4
- 04 = 5 (dark)

### 19. Print Speed

- 00 = 50 mm/sec (2 in/sec)
- 01 = 75 mm/sec
- 02 = 100 mm/sec
- 03 = 125 mm/sec (5 in/sec)

### 20. Fixed 00

**21. Pitch Size – mm (4 positions).** This field allows you to define the pitch (length) of your label to the printer. It is used when the Pitch Detection value (#26) is set to “00 – mm Scale”. Measure the pitch, convert this number to dots, and then send the Hex value of the number of dots. The allowable range is 0 – 178 mm.

Example: If the label pitch is measured as 3 inches

$$\begin{aligned}(3 \text{ in}) (25.4 \text{ mm/in}) &= 76.2 \text{ mm} \\ (76.2 \text{ mm}) (8 \text{ dots/mm}) &= 609 \text{ dots} \\ &= 261_{\text{H}} \text{ dots}\end{aligned}$$

Pitch Size = 0261

*Note: If your pitch is greater than 178 mm, use 178 mm as the value in your calculations.*

**22. Vertical Offset (4 positions).** This field and the Horizontal Offset field allow the entire print area of the label to be moved to “fine tune” for tolerances in preprinted labels, etc. The allowable range is 0 – 178 mm (0–1424 dots).

Example: If you need a Vertical Offset of 1/2 inch

$$\begin{aligned}(0.5 \text{ in}) (25.4 \text{ mm/in}) &= 12.7 \text{ mm} \\ (12.7 \text{ mm}) (8 \text{ dots/mm}) &= 102 \text{ dots} \\ &= 66_{\text{H}} \text{ dots}\end{aligned}$$

Vertical Offset = 0066

**23. Horizontal Offset (4 positions).** The allowable range is 0 – 104 mm (0 – 832 dots). Calculate the value as shown for the Vertical Offset field.

**24. Head Check Interval Quantity (4 positions).** If Head Check (#17) is enabled, this field provides the ability to choose how often the print head is checked after a specified number of labels. The allowable values for the number of labels are: 0001 – 9999

**25. Password (4 positions).** This field allows you to set a password for allowing users into the Password Protected Configuration Modes. The allowable values are: 0000 – 0999.

**26. Pitch Detection**

00 = mm Scale Detection

Upon power up, the Pitch Size value entered in field #21 is used to move the label to the top of form.

01 = Auto Detection

Upon power up, the printer will pass 2–3 labels (to automatically measure the pitch) and stop at the top of form.

02 = Dot Scale Detection

Upon power up, the Pitch Size value entered in field #27 is used to move the label to the top of form.

**27. Pitch Size – dots (4 positions).** This field allows you to define the pitch (length) of your label to the printer. It is used when the Pitch Detection value (#26) is set to “02 – dot Scale”. Measure the label pitch, convert this number to dots, and then send the Hex value of the number of dots. The allowable range is 0 – 1424 dots.

Example: If the label pitch is measured as 4 inches

$$\begin{aligned} (4 \text{ in}) (25.4 \text{ mm/in}) &= 101.6 \\ (101.6 \text{ mm}) (8 \text{ dots/mm}) &= 813 \text{ dots} \\ &= 32D_H \text{ dots} \end{aligned}$$

Pitch Size = 032D

**28. Pitch Offset Scale**

00 = mm

01 = Dots

**29. Fixed 00**

**30. I-Mark Threshold Voltage (2 positions).** When using stock with an I-Mark and the Reflective Sensor selected in field #2, this is the Sensor Threshold voltage input. To determine the value of this voltage, go to Mode S via the front panel; select “Setup Sensor” from the Mode S options, then select “Reflective”. It will show “1st Threshold = x.x V”. Move the stock until the I-Mark is beneath the sensor. You will know this because you’ll see a jump in the voltage shown on the display. Press ENTER. Move the I-Mark out from beneath the Sensor. The display reads “2nd Threshold = x.x V”. Press ENTER. The threshold voltage then appears. Make note of it. Cursor to “yes” and press ENTER. Now, in order to enter this voltage into the Data Stream you’ll need to make a simple calculation.

Suppose you measured the threshold voltage as 2.3 V. Multiply this value by 51 and find the hex value of the result. This is the input value for this field.

$$\begin{aligned} 2.3 \times 51 &= 117.3 \\ &= 75 \text{ (Hex)} \end{aligned}$$

Voltage = 75

**31. Gap Threshold Voltage (2 positions).** When using stock with label backing or a feed slot and the See-Thru Sensor selected in field #2, this is the Sensor Threshold voltage input. Find the threshold voltage in the same way as shown in #30 (I-Mark Threshold Voltage), except select "See-Thru" as the sensor type from the front panel.

**32. Fixed (8 positions)** 2B000000

**33. Fixed (8 positions)** 2B000000

**34. External Output Signal (2 positions).** This signal is available as an output to drive an applicator or some external accessory requiring a signal synchronized to the print cycle. Four types of signals are available at the "EXT" connector on the printer rear panel.

*See the Accessory Connector of the Interface Specifications in Section 2.*

- 00 = Type 1 Signal
- 01 = Type 2 Signal
- 02 = Type 3 Signal
- 03 = Type 4 Signal

**35. Cutter Backfeed**

- 00 = No
- 01 = Yes

**36. Dispenser Backfeed**

- 00 = No
- 01 = Yes

**37. Backfeed Generated By:**

- 00 = Trigger (Dispenser Attached)
- 01 = Automatic (Cutter Attached)

**38. Multi-drop Printer Address.** *Reserved for future use.*

Fixed (4 positions) 3030

**39. – 47.** Defines individual characters of the Standard or Non-Standard Proto-Codes..**39. STX**

02 = STX	(Standard)
7B = {	(Non-Standard)

**40. ETX**

03 = ETX	(Standard)
7D = }	(Non-Standard)

**41. ESC**

1B = ESC	(Standard)
5E = ^	(Non-Standard)

**42. NUL**

00 = NUL	(Standard)
7E = ~	(Non-Standard)

**43. ENQ**

05 = ENQ	(Standard)
40 = @	(Non-Standard)

**44. CAN**

18 = CAN	(Standard)
21 = !	(Non-Standard)

**45. X-ON**

11 = DC1 (both sets)

**46. X-OFF**

13 = DC3 (both sets)

**47. Proto-Codes.** This field defines whether the Standard or Non-Standard Proto-Codes are being used.

00 = Standard  
01 = Non-Standard

**48. User Check Sum (2 positions).** The final 2 positions of the data stream must be a check sum of all the data being sent. It is calculated by taking the summation of the Hex values of each position from fields 1 through 47. Although fields #24 and #25 are decimal values, treat them as if they were hexadecimal values for this calculation. If the result of the summation is greater than 2 digits, use the two right-most digits as the User Check Sum (i.e., if the result is 019C, use 9C).

Example:

After determining the value for each of the fields 1 – 47, you may have the following data:

```

2+B+0+0+0+0+0+0+0+1+0+0+0+0+0+0
+0+0+0+0+0+0+0+0+0+0+0+0+0+1+0+5+0+0
+0+0+0+0+0+0+0+0+0+0+2+0+2+0+0+0+4
+B+0+0+0+0+0+0+0+0+0+0+0+0+0+1+0+0
+0+0+0+1+0+1+9+0+0+0+0+0+0+7+2+7+2
+2+B+0+0+0+0+0+0+2+B+0+0+0+0+0+0
+0+0+0+0+0+0+0+0+3+0+3+0+0+2+0+3
+1+B+0+0+0+5+1+8+1+1+1+3+0+0 = 8A (Hex)

```

The User Check Sum value is 8A (Hex). Thus, the last 2 positions of the data stream will be 8A.



## APPENDIX E

# USING THE M-8400 OPTIONAL FEATURES

---

This section contains instructions for using the following M-8400 optional features:

- Ribbon Saver
- Label Rewinder
- Label Cutter
- Label Dispenser

### RIBBON SAVER

---

The ribbon saver consists of internal mechanisms and special firmware that enables the printer to halt ribbon movement where gaps occur between print fields within the label or tag. These gaps or “white space” areas are automatically detected by the intelligence of the ribbon saver. The white space must be a continuous linear area of non-printing, though it may contain preprinted information such as a company name or logo.

#### Operator Setup

The following steps should be taken to set up the ribbon saver:

<u>Step</u>	<u>Action</u>
1	Have the ribbon saver installed. (Must be factory installed.)
2	The printer must be configured to use the ribbon saver option. See “Carbon Saving” under Mode S of the printer configuration in Section 2 of the Operator’s Manual.
3	Load the ribbon as detailed in Section 2 of the Operator’s Manual.
4	Load the labels as detailed in Section 2 of the Operator’s taking into account the following differences: <ul style="list-style-type: none"> <li>– You <b>must</b> open the cover (rear of label sensor) over the secondary platen before feeding.</li> <li>– You <b>must</b> close this cover before printing. This secondary roller feeds labels/tags when there is “white space” detected.</li> </ul>
5	The printer and ribbon saver are ready for use.

## General Operation

The ribbon saver will now operate without further user intervention. Based on the format of your data stream, the ribbon saver will look for a minimum of 0.8 inches of “white space”, and if detected, temporarily lifts the print head and halts ribbon movement. (This operation can be viewed if the side and top printer doors are open.)

## LABEL REWINDER

---

The rewinder is an external unit that allows for labels or tags to be rewound in rolls up to 8.5 inches. It derives its power directly from the printer’s EXT connector using a built-in cable. The rewinder provides the ability to rewind labels/tags from the printer and subsequently be unwound for later use with applicators.

### Installation

<b>Step</b>	<b>Action</b>
1	Using a No. 2 Phillips screwdriver, remove the two screws and plate covering the EXT connector at the rear of the printer.
2	Position the rewinder at the front of the printer and align it with the label slot. (The rewind wheel/spindle should be positioned away from the printer.)
3	Connect the built-in cable from the rewinder to the EXT connector at the rear of the printer.
4	On the rewinder, remove the metal clamp from the rewind spindle.
5	Feed the lead end of the label stock under the first spindle and onto the rewind spindle. Feed the label stock around the spindle once, then replace the metal clamp over the label stock. Wind another revolution to ensure the labels are secure on the spindle.
6	Select the REWIND option on the rewinder, then set the power switch to ON. (The printer must be powered ON for the rewinder to function).

### Removing and Unwinding the Roll

As labels are printed, tension from the rewinder should keep the label stock taut as it wraps onto the rewind spindle.

To remove the roll from the spindle, first set the power switch OFF. Remove the metal clamp, then remove the rewound roll of labels.

To unwind for using with an applicator, first set the power switch OFF. Attach the lead edge of the labels from the rewind spindle to the applicator entry point. Select the WIND option on the rewinder, and when ready to begin, set the power switch to ON.

## LABEL CUTTER

---

The label cutter consists of an internal mechanism that will cut labels or tags as they exit the printer. The cutter can be used to print labels of various lengths using continuous form label/tag stock or to easily separate labels when there is no perforation at the label gap.

### Operator Setup

The following steps should be taken to set up the label cutter:

<u>Step</u>	<u>Action</u>
1	Install the label cutter, following the instructions provided with the unit. Installation time is approximately 20 minutes.
2	Power on the printer.
3	The printer must be configured to use the Label Cutter option. See “Cutter” under Mode S of the Printer Configuration in Section 2 of the Operator’s Manual.
4	Also, if you are using continuous form label/tag stock, set the sensor to “Not Used” in Mode S of the Printer Configuration.
5	Open the print head assembly and feed the lead edge of the labels/tags into the cutter assembly and out between the plastic and metal rollers.  NOTE: Although the cutting blade is fairly well guarded, be careful as you feed labels into the cutter area. You may want to have the printer powered OFF at this point.
6	Close the print head assembly and place the printer on-line.
7	The label cutter is ready for use.

### General Operation

The data stream to be sent to the printer may need to be altered to add the Cutter Command. If this command is not used, the cutter will default to cut after every label assuming it has been enabled in the printer configuration. For more details, see the Cutter Command in Section 2 of this manual. As labels are printed, they will be cut based on your use of this cutter command.

## 16. Flow Control (Serial Interface)

- 00 = PC1 RS On (Ready/Busy)
- 01 = PC1 RS On/Off (Ready/Busy)
- 02 = X-On/X-Off
- 03 = Status 1 (Reserved, Do Not Use)
- 04 = Status 2 (Bi-Directional)

*Note: See Section 2 – Interface Specifications for details on these protocols.*

## 17. Head Check

- 00 = Disabled
- 01 = Enabled

*Note: See also #24 (Head Check Interval Quantity)*

## 18. Print Darkness

- 00 = 1 (light)
- 01 = 2
- 02 = 3
- 03 = 4
- 04 = 5 (dark)

## 19. Print Speed

- 00 = 50 mm/sec (2 in/sec)
- 01 = 75 mm/sec
- 02 = 100 mm/sec
- 03 = 125 mm/sec (5 in/sec)

## 20. Fixed 00

**21. Pitch Size – mm (4 positions).** This field allows you to define the pitch (length) of your label to the printer. It is used when the Pitch Detection value (#26) is set to “00 – mm Scale”. Measure the pitch, convert this number to dots, and then send the Hex value of the number of dots. The allowable range is 0 – 178 mm.

Example: If the label pitch is measured as 3 inches

$$\begin{aligned}(3 \text{ in}) (25.4 \text{ mm/in}) &= 76.2 \text{ mm} \\ (76.2 \text{ mm}) (8 \text{ dots/mm}) &= 609 \text{ dots} \\ &= 261_{\text{H}} \text{ dots}\end{aligned}$$

Pitch Size = 0261

*Note: If your pitch is greater than 178 mm, use 178 mm as the value in your calculations.*

**22. Vertical Offset (4 positions).** This field and the Horizontal Offset field allow the entire print area of the label to be moved to “fine tune” for tolerances in preprinted labels, etc. The allowable range is 0 – 178 mm (0–1424 dots).

Example: If you need a Vertical Offset of 1/2 inch

$$\begin{aligned}(0.5 \text{ in}) (25.4 \text{ mm/in}) &= 12.7 \text{ mm} \\ (12.7 \text{ mm}) (8 \text{ dots/mm}) &= 102 \text{ dots} \\ &= 66_{\text{H}} \text{ dots}\end{aligned}$$

Vertical Offset = 0066

**23. Horizontal Offset (4 positions).** The allowable range is 0 – 104 mm (0 – 832 dots). Calculate the value as shown for the Vertical Offset field.

**24. Head Check Interval Quantity (4 positions).** If Head Check (#17) is enabled, this field provides the ability to choose how often the print head is checked after a specified number of labels. The allowable values for the number of labels are: 0001 – 9999

**25. Password (4 positions).** This field allows you to set a password for allowing users into the Password Protected Configuration Modes. The allowable values are: 0000 – 0999.

**26. Pitch Detection**

00 = mm Scale Detection

Upon power up, the Pitch Size value entered in field #21 is used to move the label to the top of form.

01 = Auto Detection

Upon power up, the printer will pass 2–3 labels (to automatically measure the pitch) and stop at the top of form.

02 = Dot Scale Detection

Upon power up, the Pitch Size value entered in field #27 is used to move the label to the top of form.

**27. Pitch Size – dots (4 positions).** This field allows you to define the pitch (length) of your label to the printer. It is used when the Pitch Detection value (#26) is set to “02 – dot Scale”. Measure the label pitch, convert this number to dots, and then send the Hex value of the number of dots. The allowable range is 0 – 1424 dots.

Example: If the label pitch is measured as 4 inches

$$\begin{aligned} (4 \text{ in}) (25.4 \text{ mm/in}) &= 101.6 \\ (101.6 \text{ mm}) (8 \text{ dots/mm}) &= 813 \text{ dots} \\ &= 32D_H \text{ dots} \end{aligned}$$

Pitch Size = 032D

**28. Pitch Offset Scale**

00 = mm

01 = Dots

**29. Fixed 00**

**30. I-Mark Threshold Voltage (2 positions).** When using stock with an I-Mark and the Reflective Sensor selected in field #2, this is the Sensor Threshold voltage input. To determine the value of this voltage, go to Mode S via the front panel; select “Setup Sensor” from the Mode S options, then select “Reflective”. It will show “1st Threshold = x.x V”. Move the stock until the I-Mark is beneath the sensor. You will know this because you’ll see a jump in the voltage shown on the display. Press ENTER. Move the I-Mark out from beneath the Sensor. The display reads “2nd Threshold = x.x V”. Press ENTER. The threshold voltage then appears. Make note of it. Cursor to “yes” and press ENTER. Now, in order to enter this voltage into the Data Stream you’ll need to make a simple calculation.

Suppose you measured the threshold voltage as 2.3 V. Multiply this value by 51 and find the hex value of the result. This is the input value for this field.

$$\begin{aligned} 2.3 \times 51 &= 117.3 \\ &= 75 \text{ (Hex)} \end{aligned}$$

Voltage = 75

**31. Gap Threshold Voltage (2 positions).** When using stock with label backing or a feed slot and the See-Thru Sensor selected in field #2, this is the Sensor Threshold voltage input. Find the threshold voltage in the same way as shown in #30 (I-Mark Threshold Voltage), except select "See-Thru" as the sensor type from the front panel.

**32. Fixed (8 positions)** 2B000000

**33. Fixed (8 positions)** 2B000000

**34. External Output Signal (2 positions).** This signal is available as an output to drive an applicator or some external accessory requiring a signal synchronized to the print cycle. Four types of signals are available at the "EXT" connector on the printer rear panel.

*See the Accessory Connector of the Interface Specifications in Section 2.*

- 00 = Type 1 Signal
- 01 = Type 2 Signal
- 02 = Type 3 Signal
- 03 = Type 4 Signal

**35. Cutter Backfeed**

- 00 = No
- 01 = Yes

**36. Dispenser Backfeed**

- 00 = No
- 01 = Yes

**37. Backfeed Generated By:**

- 00 = Trigger (Dispenser Attached)
- 01 = Automatic (Cutter Attached)

**38. Multi-drop Printer Address.** *Reserved for future use.*

Fixed (4 positions) 3030

**39. – 47.** Defines individual characters of the Standard or Non-Standard Proto-Codes..**39. STX**

02 = STX           (Standard)  
 7B = {            (Non-Standard)

**40. ETX**

03 = ETX           (Standard)  
 7D = }            (Non-Standard)

**41. ESC**

1B = ESC           (Standard)  
 5E = ^            (Non-Standard)

**42. NUL**

00 = NUL           (Standard)  
 7E = ~            (Non-Standard)

**43. ENQ**

05 = ENQ           (Standard)  
 40 = @            (Non-Standard)

**44. CAN**

18 = CAN           (Standard)  
 21 = !            (Non-Standard)

**45. X-ON**

11 = DC1 (both sets)

**46. X-OFF**

13 = DC3 (both sets)



**47. Proto-Codes.** This field defines whether the Standard or Non-Standard Proto-Codes are being used.

00 = Standard  
01 = Non-Standard

**48. User Check Sum (2 positions).** The final 2 positions of the data stream must be a check sum of all the data being sent. It is calculated by taking the summation of the Hex values of each position from fields 1 through 47. Although fields #24 and #25 are decimal values, treat them as if they were hexadecimal values for this calculation. If the result of the summation is greater than 2 digits, use the two right-most digits as the User Check Sum (i.e., if the result is 019C, use 9C).

Example:

After determining the value for each of the fields 1 – 47, you may have the following data:

```

2+B+0+0+0+0+0+0+0+1+0+0+0+0+0+0
+0+0+0+0+0+0+0+0+0+0+0+0+1+0+5+0+0
+0+0+0+0+0+0+0+0+0+0+2+0+2+0+0+0+4
+B+0+0+0+0+0+0+0+0+0+0+0+0+1+0+0
+0+0+0+1+0+1+9+0+0+0+0+0+7+2+7+2
+2+B+0+0+0+0+0+0+2+B+0+0+0+0+0+0
+0+0+0+0+0+0+0+0+3+0+3+0+0+2+0+3
+1+B+0+0+0+5+1+8+1+1+1+3+0+0 = 8A (Hex)

```

The User Check Sum value is 8A (Hex). Thus, the last 2 positions of the data stream will be 8A.

**Example in BASIC**

```

10 E$ = CHR$(27)
20 OPEN "COM1:9600,N,8,1,CS,DS" AS #1
30 PRINT #1, CHR$(2);
40 PRINT #1, E$;"A";
50 PRINT #1, E$;"#G,"
60 PRINT #1, "2B000000"; 'Pitch Offset (8)
70 PRINT #1, "01"; 'Sensor Type (2)
80 PRINT #1, "00"; 'Printer Mode (2)
90 PRINT #1, "00"; 'Fixed (2)
100 PRINT #1, "00"; 'Ribbon Saver (2)
110 PRINT #1, "00"; 'Memory Card (2)
120 PRINT #1, "00"; 'Cutter (2)
130 PRINT #1, "00"; 'Fixed (2)
140 PRINT #1, "00"; 'Dispenser (2)
150 PRINT #1, "00"; 'Receive Buffer Size (2)
160 PRINT #1, "01"; 'Interface Type (2)
170 PRINT #1, "05"; 'Baud Rate (2)
180 PRINT #1, "00"; 'Stop Bits (2)
190 PRINT #1, "00"; 'Parity (2)
200 PRINT #1, "00"; 'Data Bits (2)
210 PRINT #1, "00"; 'Flow Control (2)
220 PRINT #1, "00"; 'Head Check (2)
230 PRINT #1, "02"; 'Print Darkness (2)
240 PRINT #1, "02"; 'Print Speed (2)
250 PRINT #1, "00"; 'Fixed (2)
260 PRINT #1, "04B0"; 'Pitch Size - mm (4)
270 PRINT #1, "0000"; 'Vert Offset (4)
280 PRINT #1, "0000"; 'Horz Offset (4)
290 PRINT #1, "0001"; 'Head Check Interval Qty (4)
300 PRINT #1, "0000"; 'Password (4)
310 PRINT #1, "01"; 'Pitch Detection Method (2)
320 PRINT #1, "0190"; 'Pitch Size - dots (4)
330 PRINT #1, "00"; 'Pitch Offset Scale (2)
340 PRINT #1, "00"; 'Fixed (2)
350 PRINT #1, "72"; 'I-Mark Threshold Voltage (2)
360 PRINT #1, "72"; 'Gap Threshold Voltage (2)
370 PRINT #1, "2B000000"; 'Fixed (8)
380 PRINT #1, "2B000000"; 'Fixed (8)
390 PRINT #1, "00"; 'External Output Signal (2)
400 PRINT #1, "00"; 'Cutter Backfeed (2)
410 PRINT #1, "00"; 'Dispenser Backfeed (2)
420 PRINT #1, "00"; 'Backfeed Generated By (2)
430 PRINT #1, "3030"; 'Multi-Drop Printer Address (4)
440 PRINT #1, "02"; 'STX (2)

```

```

450 PRINT #1, "03";      ' ETX (2)
460 PRINT #1, "1B";     ' ESC (2)
470 PRINT #1, "00";     ' NUL (2)
480 PRINT #1, "05";     ' ENQ (2)
490 PRINT #1, "18";     ' CAN (2)
500 PRINT #1, "11";     ' X-ON (2)
510 PRINT #1, "13";     ' X-OFF (2)
520 PRINT #1, "00";     ' Proto-Codes (2)
530 PRINT #1, "8A";     ' User Check Sum (2)
540 PRINT #1, E$; "Z";
550 PRINT #1, CHR$(3);

```

Although the above example assumes use of the RS232C Serial interface, either interface type can be used to send this data stream. Upon sending the data stream, you should see no reaction on the printer.

**IMPORTANT:** After sending the User Default data stream, the settings are stored in a battery-backed memory area on the printer. To make these settings effective, you must place them into the printer's current configuration by selecting the "Set User Default" option from Mode S of the Printer Configuration (see Section 2 of the M-8400 Operator's Manual). This process will change the current configuration to the settings sent in your User Default data stream. This also is the method to bring back your desired User settings if the current configuration is accidentally changed.

## APPENDIX E

# USING THE M-8400 OPTIONAL FEATURES

---

This section contains instructions for using the following M-8400 optional features:

- Ribbon Saver
- Label Rewinder
- Label Cutter
- Label Dispenser

### RIBBON SAVER

---

The ribbon saver consists of internal mechanisms and special firmware that enables the printer to halt ribbon movement where gaps occur between print fields within the label or tag. These gaps or “white space” areas are automatically detected by the intelligence of the ribbon saver. The white space must be a continuous linear area of non-printing, though it may contain preprinted information such as a company name or logo.

#### Operator Setup

The following steps should be taken to set up the ribbon saver:

<u>Step</u>	<u>Action</u>
1	Have the ribbon saver installed. (Must be factory installed.)
2	The printer must be configured to use the ribbon saver option. See “Carbon Saving” under Mode S of the printer configuration in Section 2 of the Operator’s Manual.
3	Load the ribbon as detailed in Section 2 of the Operator’s Manual.
4	Load the labels as detailed in Section 2 of the Operator’s taking into account the following differences: <ul style="list-style-type: none"> <li>– You <b>must</b> open the cover (rear of label sensor) over the secondary platen before feeding.</li> <li>– You <b>must</b> close this cover before printing. This secondary roller feeds labels/tags when there is “white space” detected.</li> </ul>
5	The printer and ribbon saver are ready for use.

## General Operation

The ribbon saver will now operate without further user intervention. Based on the format of your data stream, the ribbon saver will look for a minimum of 0.8 inches of “white space”, and if detected, temporarily lifts the print head and halts ribbon movement. (This operation can be viewed if the side and top printer doors are open.)

## LABEL REWINDER

---

The rewinder is an external unit that allows for labels or tags to be rewound in rolls up to 8.5 inches. It derives its power directly from the printer’s EXT connector using a built-in cable. The rewinder provides the ability to rewind labels/tags from the printer and subsequently be unwound for later use with applicators.

### Installation

<u>Step</u>	<u>Action</u>
1	Using a No. 2 Phillips screwdriver, remove the two screws and plate covering the EXT connector at the rear of the printer.
2	Position the rewinder at the front of the printer and align it with the label slot. (The rewind wheel/spindle should be positioned away from the printer.)
3	Connect the built-in cable from the rewinder to the EXT connector at the rear of the printer.
4	On the rewinder, remove the metal clamp from the rewind spindle.
5	Feed the lead end of the label stock under the first spindle and onto the rewind spindle. Feed the label stock around the spindle once, then replace the metal clamp over the label stock. Wind another revolution to ensure the labels are secure on the spindle.
6	Select the REWIND option on the rewinder, then set the power switch to ON. (The printer must be powered ON for the rewinder to function).

### Removing and Unwinding the Roll

As labels are printed, tension from the rewinder should keep the label stock taut as it wraps onto the rewind spindle.

To remove the roll from the spindle, first set the power switch OFF. Remove the metal clamp, then remove the rewound roll of labels.

To unwind for using with an applicator, first set the power switch OFF. Attach the lead edge of the labels from the rewind spindle to the applicator entry point. Select the WIND option on the rewinder, and when ready to begin, set the power switch to ON.

## LABEL CUTTER

---

The label cutter consists of an internal mechanism that will cut labels or tags as they exit the printer. The cutter can be used to print labels of various lengths using continuous form label/tag stock or to easily separate labels when there is no perforation at the label gap.

### Operator Setup

The following steps should be taken to set up the label cutter:

<u>Step</u>	<u>Action</u>
1	Install the label cutter, following the instructions provided with the unit. Installation time is approximately 20 minutes.
2	Power on the printer.
3	The printer must be configured to use the Label Cutter option. See “Cutter” under Mode S of the Printer Configuration in Section 2 of the Operator’s Manual.
4	Also, if you are using continuous form label/tag stock, set the sensor to “Not Used” in Mode S of the Printer Configuration.
5	Open the print head assembly and feed the lead edge of the labels/tags into the cutter assembly and out between the plastic and metal rollers.  NOTE: Although the cutting blade is fairly well guarded, be careful as you feed labels into the cutter area. You may want to have the printer powered OFF at this point.
6	Close the print head assembly and place the printer on-line.
7	The label cutter is ready for use.

### General Operation

The data stream to be sent to the printer may need to be altered to add the Cutter Command. If this command is not used, the cutter will default to cut after every label assuming it has been enabled in the printer configuration. For more details, see the Cutter Command in Section 2 of this manual. As labels are printed, they will be cut based on your use of this cutter command.

## LABEL DISPENSER

---

The label dispenser is an internal mechanism to the printer that provides the ability to print in a “demand mode”. When the dispenser is installed and configured for operation, the printer dispenses one label at a time, peeling the backing from the label, which allows for immediate application to the product by the operator.

### Operator Setup

The following steps should be taken to set up the label dispenser:

<b>Step</b>	<b>Action</b>
1	Install the label dispenser following the directions provided with the unit. Installation time is approximately 20 minutes.
2	Power on the printer.
3	The printer must be configured to use the label dispenser option. See “Dispenser” under Mode S of the Printer Configuration in Section 2 of the Operator’s Manual.
4	Remove one or two of the lead labels from the backing paper.
5	Open the label dispenser by lifting up its front panel and swinging open the unit such that the knurled roller is easily seen.
6	Open the print head assembly and feed the lead of the backing paper through the print area in the normal manner.
7	At the label exit area, feed the backing paper down and behind the knurled roller, then out the lower exit of the label dispenser.
8	Close the front panel of the label dispenser until it locks into place and again is flush with the front of the printer.
9	Close the print head assembly and place the printer on-line.
10	The label dispenser is ready for use.

### General Operation

Send your data stream in the normal manner to the printer. Labels should print one at a time, even if your print quantity command requests more than one label. As labels are printed and presented for the operator to remove, the backing paper will continue to feed out the dispenser’s lower exit path. If the dispenser’s backfeed option has been set to TRIGGER in the printer configuration, the next label will print only after removing the current label from the label exit path. (You may also control the printing of the next label with an external device attached to the printer’s EXT connector. Contact a SATO representative for more information on this method.)

*Note: The label dispenser will function only if it has been turned on through the configuration process.*

## APPENDIX F CHARACTER TABLES

This section shows the character tables selectable on the SATO M-8400. These tables reflect the various characters and symbols available to print on your labels. You will find 9 International Character Tables listed, with each applying to the fonts U, S, M, WB, WL, and the Vector Font. If you do not use the character table command in your data stream to the printer, the printer assumes use of the IBM 850 Character Table (which is the printer default). For more information on the Character Table command, see Page 1-25.

Also in this section you will find the character tables for fonts OA and OB.

How to read the table:   4CH = L  
                              62H = b

IBM 850 Character Table														
	2	3	4	5	6	7	8	9	A	B	C	D	E	F
0	0	@	P	'	p	Ç	É	á	ö	ó	-			
1	!	1	A	Q	a	q	ü	æ	í	Ð	β	±		
2	"	2	B	R	b	r	é	Æ	ó	ê	ô	=		
3	#	3	C	S	c	s	â	ô	ú	Ë	ò	%		
4	\$	4	D	T	d	t	ä	ö	ñ	È	ö			
5	%	5	E	U	e	u	à	ò	Ñ	Á	õ	§		
6	&	6	F	V	f	v	å	û	ä	Û	ä	í	μ	÷
7	'	7	G	W	g	w	ç	ù	è	À	Û	î		
8	(	8	H	X	h	x	ê	ÿ	ç	@	ï	°		
9	)	9	I	Y	i	y	ë	ö	@		Ú	"		
A	*	:	J	Z	j	z	è	Ü	¬		Û	·		
B	+	;	K	[	k	{	ï	ø	½		Ù	'		
C	,	<	L	\			î	£	¼		Ý	³		
D	-	=	M	]	m	}	ì	Ø	i	ø	Ý	²		
E	.	>	N	^	n	~	Ä	x	«	¥	ì	-		
F	/	?	O	_	o		Å	f	»					



Character Table 1

	2	3	4	5	6	7	8	9	A	B	C	D	E	F
0	0	@	P	'	p	Ç	É	á	ø	ó	-			
1	!	1	A	Q	a	q	ü	æ	í	Ð	β	±		
2	"	2	B	R	b	r	é	Æ	ó	ê	ô	=		
3	£	3	C	S	c	s	â	ô	ú	ë	ò	¼		
4	\$	4	D	T	d	t	ä	ö	ñ	è	ö			
5	%	5	E	U	e	u	à	ò	Ñ	Á	ö	§		
6	&	6	F	V	f	v	â	û	æ	Ä	ä	í	μ	÷
7	'	7	G	W	g	w	ç	ù	ø	À	Ã	î		
8	(	8	H	X	h	x	ê	ÿ	ï	©	ï	°		
9	)	9	I	Y	i	y	ë	ö	®	ú	ü			
A	*	:	J	Z	j	z	è	ü	¬	û	ü			
B	+	;	K	[	k	{	ï	ø	½	ù	í			
C	,	<	L	\	l		î	£	¼	ý	³			
D	-	=	M	]	m	}	ì	Ø	ì	ç	ý	²		
E	.	>	N	^	n	~	Ä	x	«	¥	ì	'		
F	/	?	O	_	o		Å	f	»					

Character Table 2

	2	3	4	5	6	7	8	9	A	B	C	D	E	F
0	0	§	P	'	p	ç	É	á	ø	ó	-			
1	!	1	A	Q	a	q	ü	æ	í	Đ	β	±		
2	"	2	B	R	b	r	é	Æ	ó	ê	ô	=		
3	#	3	C	S	c	s	â	ô	ú	ë	ò	¼		
4	\$	4	D	T	d	t	ä	ö	ñ	è	ö			
5	%	5	E	U	e	u	à	ò	Ñ	Á	õ	§		
6	&	6	F	V	f	v	â	û	æ	Á	ã	í	μ	÷
7	'	7	G	W	g	w	ç	ù	æ	À	Ã	î		
8	(	8	H	X	h	x	ê	ÿ	ç	©	ï	°		
9	)	9	I	Y	i	y	ë	ö	®	ú	ü			
A	*	:	J	Z	j	z	è	ü	¬	û	·			
B	+	;	K	Ä	k	ä	ï	ø	½	ù	¹			
C	,	<	L	Ö	l	ö	î	£	¼	ý	³			
D	-	=	M	Ü	m	ü	ì	ø	í	ç	²			
E	.	>	N	^	n	β	Ä	x	«	¥	ì	´		
F	/	?	O	_	o	Å	f	»						

Character Table 3

	2	3	4	5	6	7	8	9	A	B	C	D	E	F
0	O	à	P	ë	p	ç	É	á	ø	ó	-			
1	!	1	A	Q	a	q	ü	æ	í	Ð	±			
2	"	2	B	R	b	r	é	Æ	ó	ê	ô	=		
3	#	3	C	S	c	s	â	ô	ú	Ë	ò	%		
4	\$	4	D	T	d	t	ä	ö	ñ	È	ö			
5	%	5	E	U	e	u	à	ò	Ñ	Á	ö	§		
6	&	6	F	V	f	v	å	û	ä	Â	ã	í	μ	÷
7	'	7	G	W	g	w	ç	ù	ø	À	Ã	î		
8	(	8	H	X	h	x	ê	ÿ	ç	ï	°			
9	)	9	I	Y	i	y	ë	ö	ø	Ú	°			
A	*	:	J	Z	j	z	è	ü	°	Û	°			
B	+	;	K	ï	k	é	ï	ø	½	Ü	'			
C	,	<	L	ç	l	ù	î	£	¼	Ý	³			
D	-	=	M	û	m	è	ì	Ø	ï	Ý	²			
E	.	>	N	î	n	ê	Ä	x	«	¥	ì	'		
F	/	?	O	ô	o	Å	f	»						

## Character Table 4

	2	3	4	5	6	7	8	9	A	B	C	D	E	F
0	0	É	P	é	p	Ç	É	á	ø	ó	-			
1	!	1	A	Q	a	q	ü	æ	í	Ð	β	±		
2	"	2	B	R	b	r	é	Æ	ó	é	ô	=		
3	#	3	C	S	c	s	â	ô	ú	ë	ò	¾		
4	\$	4	D	T	d	t	ä	ö	ñ	è	ö			
5	%	5	E	U	e	u	à	ò	Ñ	Á	ö	§		
6	&	6	F	V	f	v	â	û	æ	Ä	ä	í	μ	÷
7	'	7	G	W	g	w	ç	ù	ø	À	Ã	î		
8	(	8	H	X	h	x	ê	ÿ	ı	ı	ı	ı	ı	ı
9	)	9	I	Y	i	y	ë	ö	®	ú	ü			
A	*	:	J	Z	j	z	è	ü	ı	ü	ı			
B	+	;	K	Ä	k	ä	ı	ø	½	ü	ı			
C	,	<	L	Ö	l	ö	î	£	¼	ý	³			
D	-	=	M	Å	m	å	ı	Ø	ı	ç	ı	²		
E	.	>	N	Ü	n	ü	Ä	x	«	¥	ı	ı		
F	/	?	O	_	o		Å	f	»					

### Character Table 5

	2	3	4	5	6	7	8	9	A	B	C	D	E	F
0	O	Ä	P	ä	p	ç	É	é	á	ø	ó	-		
1	!	1	A	Q	a	q	ü	æ	í	ð	β	±		
2	"	2	B	R	b	r	é	Æ	ó	ê	ô	=		
3	#	3	C	S	c	s	â	ô	ú	ë	ò	%		
4	\$	4	D	T	d	t	ä	ö	ñ	è	ö			
5	%	5	E	U	e	u	à	ò	Ñ	Á	ø	§		
6	&	6	F	V	f	v	â	û	ä	ã	í	μ	÷	
7	'	7	G	W	g	w	ç	ù	ä	ã	î			
8	(	8	H	X	h	x	ê	ÿ	¿	ï	°			
9	)	9	I	Y	i	y	ë	ö	®	ú	¨			
A	*	:	J	Z	j	z	è	ü	¬	û	·			
B	+	;	K	Æ	k	æ	ï	ø	½	ù	'			
C	,	<	L	Ø	l	ø	î	£	¼	ý	³			
D	-	=	M	Å	m	å	ì	Ø	ì	ø	ý	²		
E	.	>	N	Ü	n	ü	Ä	x	«	¥	ì	'		
F	/	?	O	_	o		Å	f	»		'			

Character Table 6

	2	3	4	5	6	7	8	9	A	B	C	D	E	F
0	0	@	P	'	p	Ç	É	á	ø	ó	-			
1	!	1	A	Q	a	q	ü	æ	í	Ð	β	±		
2	"	2	B	R	b	r	é	Æ	ó	ê	ô	=		
3	#	3	C	S	c	s	â	ô	ú	È	ò	¾		
4	\$	4	D	T	d	t	ä	ö	ñ	è	ö			
5	%	5	E	U	e	u	à	ò	Ñ	Á	õ	§		
6	&	6	F	V	f	v	å	û	æ	Â	ã	í	μ	÷
7	'	7	G	W	g	w	ç	ù	ø	À	Ã	î		
8	(	8	H	X	h	x	ê	ÿ	ç	ï	°			
9	)	9	I	Y	i	y	ë	ö	®	ú	¨			
A	*	:	J	Z	j	z	è	ü	¬	û	·			
B	+	;	K	[	k	]	ï	ø	½	ù	'			
C	,	<	L	Ñ	l	ñ	î	£	¼	ý	³			
D	-	=	M	]	m	}	ì	Ø	ì	ÿ	²			
E	.	>	N	^	n	~	Ä	x	«	¥	ì	'		
F	/	?	O	_	o		À	f	»					

### Character Table 7

	2	3	4	5	6	7	8	9	A	B	C	D	E	F
0	0	@	P	'	p	ç	É	á	ø	ó	-			
1	!	1	A	Q	a	q	ü	æ	í	α	β	±		
2	"	2	B	R	b	r	é	Æ	ó	β	Ê	ô	=	
3	#	3	C	S	c	s	â	ô	ú	σ	Ë	ò	¾	
4	\$	4	D	T	d	t	ä	ö	ñ	μ	È	ö		
5	%	5	E	U	e	u	à	ò	Ñ	Á	τ	ö	§	
6	&	6	F	V	f	v	å	û	æ	Â	ð	í	μ	÷
7	'	7	G	W	g	w	ç	ù	ø	À	ω	î		
8	(	8	H	X	h	x	ê	ÿ	¿	Ø	ï	°		
9	)	9	I	Y	i	y	ë	ö	®	ε	Ú	''		
A	*	:	J	Z	j	z	è	ü	¬	Ω	Û	·		
B	+	;	K	Γ	k	π	ï	ø	½	±	Ü	'		
C	,	<	L	Δ	l	Σ	î	£	¼	²	Ý	³		
D	-	=	M	θ	m	φ	ì	ø	³	Ý	²			
E	.	>	N	Λ	n	Ψ	Ä	x	«	¥	ì	'		
F	/	?	O	Ξ	o	À	f	»						

Character Table 9

	2	3	4	5	6	7	8	9	A	B	C	D	E	F
0	0	@	P	'	p	ç	É	á	ø	ó	-			
1	!	1	A	Q	a	q	ü	æ	í	Ð	±			
2	"	2	B	R	b	r	é	Æ	ó	Ê	Ô	=		
3	#	3	C	S	c	s	â	ô	ú	Ë	Ò	%		
4	\$	4	D	T	d	t	ä	ö	ñ	È	Ö			
5	%	5	E	U	e	u	à	ò	Ñ	Á	Ï	§		
6	&	6	F	V	f	v	â	û	ä	Ã	í	µ	÷	
7	'	7	G	W	g	w	ç	ù	ø	À	Ã	î		
8	(	8	H	X	h	x	ê	ÿ	ç	©	ï	°		
9	)	9	I	Y	i	y	ë	ö	®	Ú	ü			
A	*	:	J	Z	j	z	è	ü	¬	Û	·			
B	+	;	K	[	k	{	ï	ø	½	Ü	'			
C	,	<	L	\	l		î	£	¼	Ý	³			
D	-	=	M	]	m	}	ì	Ø	ì	ÿ	²			
E	.	>	N	^	n	~	Ä	×	«	¥	ì	'		
F	/	?	O	_	o		À	f	»		'			



Font OA Character Table

	2	3	4	5	6	7	8	9	A	B	C	D	E	F
0	0	P												
1	L	A	Q											
2	2	B	R											
3	3	C	S											
4	\$	4	D	T										
5	5	E	U											
6	6	F	V											
7	7	G	W											
8	8	H	X											
9	9	I	Y											
A			J	Z										
B			K											
C			L											
D			M											
E	.	>	N											
F	/		O											

## Font OB Character Table

	2	3	4	5	6	7	8	9	A	B	C	D	E	F
0		0	@	P										
1	!	1	A	Q										
2	"	2	B	R										
3	#	3	C	S										
4	\$	4	D	T										
5	%	5	E	U										
6	&	6	F	V										
7	'	7	G	W										
8	(	8	H	X										
9	)	9	I	Y										
A	*	:	J	Z										
B	+	;	K	S <sub>2</sub>										
C	,	<	L	¥										
D	-	=	M											
E	.	>	N											
F	/	?	O											

# INDEX

---

## A

- Accessory Connector, 2–11
  - Output Signals, 2–13
  - Pin Assignments, 2–11
- Applicators, 2–11, 2–12

## B

- BASIC, 1–2, D–10
- Bar Codes, 1–8
  - Detailed Specifications, B–2
  - Rotated, B–1
- Bar Codes – Variable Ratio, 1–10, 1–12
- Base Reference Point, 1–3, 1–6, 1–14
- Battery Backed Custom Graphics, 1–33, C–8
- Bookland, B–13

## C

- Calendar Increment, 1–16
- Calendar Print, 1–18
- Calendar Set, 1–20
- Centronics Parallel Interface, 2–10
  - Accessory (EXT) Connector, 2–11
  - External Output Signals, 2–13
  - Pin Assignments, 2–11
  - Troubleshooting, 3–2
- Character Expansion, 1–21
- Character Pitch, 1–23
- Character Tables, 1–25, F–1
- Clear Printer Memory & Buffers, 1–27
- Codabar, B–2

- Code 128
  - Character Table, B–17
  - Method 1, B–10
  - Method 2, B–15
- Code 39, B–3
- Code 93, B–11
- Command Codes, 1–7
  - Quick Reference Chart, A–1
- Continuous Forms Printing, 1–28
- Control Characters, 1–1
- Copy Image Area, 1–29
- Custom Graphics, 1–32
  - Appendix Example, C–4
- Custom Graphics – Battery Backed, 1–33
  - Appendix Example, C–8
- Custom-Designed Characters, 1–31
  - Appendix Example, C–1
- Cutter, E–3
- Cutter Command, 1–35

## D

- Direct Thermal Mode Setting, Troubleshooting, 3–5
- Dispenser, E–3

## E

- EAN–13, 1–9, B–5, B–6
- EAN–8, 1–9, B–7
- Edit Label, 1–59
- Enlarged Text. *See* Character Expansion
- EXT Connector. *See* Accessory Connector
- Expanded Print Length, 1–37

## F

Fonts U, S, M, OA & OB, 1-38  
Fonts WB & WL, 1-40  
Form Feed, 1-42  
Form Overlay, 1-55, 1-71

## H

Horizontal Position, 1-51

## I

Industrial Two of Five, B-8  
Interface Types, 2-1  
Interleaved Two of Five (I 2/5), 1-11,  
B-4

## J

Journal Print, 1-43

## L

Label Applicators, 2-11  
Label Cutter, E-3  
Label Dispenser, E-3  
Label Rewinder, 2-11, E-2  
Line Feed, 1-47  
Lines and Boxes, 1-45  
Loop Back Test, 2-9

## M

Matrix Two of Five, B-9  
Mod10 Check Digit, B-6  
Moving Reference Point, 1-65  
MSI, B-11

## O

OCR-A, 1-38

OCR-B, 1-38  
Off-Line, 1-49  
Optional Features, Using the E-1

## P

Password Lost, Troubleshooting, 3-4  
Print Area, 1-3  
Print Darkness, 1-50  
Print Direction - Rotation, 1-65  
Print Position, 1-51  
Print Quantity, 1-53  
Print Speed Selection, 1-54  
Programming Language, 1-1  
Proto-Codes, 1-1

## Q

Quantity. *See* Print Quantity

## R

Recall Form Overlay, 1-55  
Recall Print Job, 1-56  
Receive Buffer, 2-1  
Repeat Label, 1-58  
Replace Data, 1-59  
Reverse Image, 1-61  
Rewinder, 2-11, E-2  
Ribbon Saver, E-1  
Rotation  
    Bar Codes, B-1  
    Fixed Base Ref Point, 1-63  
    Moving Base Ref Point, 1-65  
RS232C Serial Interface, 2-2  
    Bi-Directional Communication Protocol, 2-7  
    Electrical Specifications, 2-2  
    General Specifications, 2-2  
    Loop Back Test, 2-9  
    Pin Assignments, 2-2  
    Ready/Busy Protocol, 2-4  
    Troubleshooting, 3-3  
    X-ON/X-OFF Protocol, 2-5

## S

Sequential Numbering, 1-67  
Smooth Fonts. *See* Fonts Wb, Wl &  
Vector Font  
Start/Stop Label, 1-69  
Store Form Overlay, 1-71  
Store Print Jobs, 1-72

## T

Troubleshooting, 3-1  
Centronics Interface, 3-2  
Direct Thermal Mode, 3-5  
Initial Checklist, 3-1  
Password Lost, 3-4

RS232C Interface, 3-3

Typestyles. *See* Fonts

## U

UPC Supplements. *See* Bookland  
UPC-A, 1-9, B-5  
UPC-E, 1-9, B-12  
User Defaults, Setting the, D-1

## V

Vector Font, 1-73  
Vertical Position, 1-51

## Free Manuals Download Website

<http://myh66.com>

<http://usermanuals.us>

<http://www.somanuals.com>

<http://www.4manuals.cc>

<http://www.manual-lib.com>

<http://www.404manual.com>

<http://www.luxmanual.com>

<http://aubethermostatmanual.com>

Golf course search by state

<http://golfingnear.com>

Email search by domain

<http://emailbydomain.com>

Auto manuals search

<http://auto.somanuals.com>

TV manuals search

<http://tv.somanuals.com>