



SBC-6020 Users Manual

Digital Enhanced Cordless Telephone



In case of difficulties, visit our service center at www.sbctelephones.com or call **800-400-5156**

Table Of Contents

Contents		
Introduction	2	
Welcome	2	
DECT Technology	2	
Features.....	3	
Quick Reference	4	
Terminology	4	
Symbols On The LCD	4	
Key Descriptions.....	4	
Parts Checklist	5	
Controls & Functions	6	
Handset and Base Functions & Controls	6	
Connection Diagram	7	
Getting Started	8	
Powering On and Off the Handset	8	
Access to Ringer Menu.....	9	
Ring mode setting for handset	9	
Volume setting for handset	10	
Adjusting the earpiece volume	10	
Melody setting for handset.....	11	
Ring mode setting for base	11	
Volume setting for base	12	
Melody setting for base.....	12	
Setting the date and the time	13	
Setting the area code.....	13	
Setting keypad tones.....	14	
Setting the backlighting of LCD display.....	14	
Setting the language.....	14	
Prefix Dialing	15	
Flash	16	
Inter-digit pause.....	16	
Register to Base	17	
Telephone Operation	20	
Making and receiving calls	20	
Out of range indication	21	
Call duration time	21	
Answering a call	22	
Repeat one of the last 10 dialed numbers.....	22	
Holding with on-hold music	23	
Microphone muting	23	
Transferring a call.....	24	
Call conferencing	24	
Using the intercom.....	25	
Room monitoring.....	26	
Paging a handset	27	
Call Waiting.....	27	
Caller ID	27	
Phone book	28	
Caller ID (CID).....	32	
Voice Mail Waiting Indicator (VMWI)	33	
Alarm Clock.....	34	
Appointment function	35	
Deregister the Handset.....	38	
Call Blocking.....	38	
Factory Reset	39	
Troubleshooting	40	
Precautions	41	
Specifications	41	
Warranty	42	
FCC Information	43	
Index	44	

NOTE!

IMPORTANT: Allow the handsets to charge for at least 12 hours before using the phone for the first time. The fully charged phone should offer 8 hours of continuous talk time.

Welcome

Thank you for purchasing this 1.9 GHz Digital Cordless phone. Your phone is equipped with a fully functional phone book, alarm, caller ID, and the ability to use additional handsets. It has an elegant design and is simple to use.

This user's guide is designed to familiarize you with your cordless telephone. We strongly recommend you read the guide before using your phone.

DECT Technology

Your phone uses the new Digital Enhanced Cordless Telecommunications (DECT) Technology. This allows for better cordless communications in residential, corporate, and public environments.

DECT offers higher quality speech and enhanced security. You will experience a low risk of radio interference because your phone will continually search for the best radio channels, while in standby mode and on a call. Phone calls will be encrypted for maximum call security. And radio transmission is optimized for maximum battery life. In addition, this new technology works well with equipment from different manufacturers, such as handsets.

Features

- Phone book with 100 locations (up to 15 digits for names & 25 digits for numbers)
- Area code
- Back light (both on LCD and keypad)
- Call timer (displays the length of communication)
- Call blocking
- Pre-dialing
- Last number redial (for up to 10 numbers)
- Hands-free in the handset with local echo suppression
- Access to the functions through Soft Keys
- Caller ID*
- Caller ID* list : stores last 40 calls
- Handset power off
- Microphone mute
- Hold music
- Low battery warning beep
- Battery monitoring (3 levels : empty, half, full)
- Range of use: 300 meters outside and 50 meters inside
- 65,000 color LCD display
- PABX access code
- Adjustable volume on handset receiver or speaker
- Handset ringer melody programmable for internal and external calls (13 melodies)
- Handset ringer volume programmable for internal and external calls (9 volume levels)
- Base station ringer melody (9 melodies)
- Base station ringer volume (9 levels)
- Internal call between handsets while on an external call
- Transfer an external call to another handset
- Conference calling
- Incoming call waiting signal during intercom calls
- Room monitoring
- Multiple handset feature (up to 5 handsets)
- Multiple base feature (up to 4 bases)
- Alarm
- Appointment (annual / monthly / daily)
- Multi-language
- Paging from base to handset
- Internal antenna
- AAA rechargeable battery
- Battery charging time: 16 hours standard charging method
- Battery life: about 60 hours for standby and 8 hours for talk

**requires subscription to Caller ID service from your telephone company*

***requires subscription to Voice Mail service from your telephone company*







Terminology

Standby Mode - The mode your phone is in when you're not on a call. The phone is ready to accept a new action.









Talk Mode - The mode your phone is in when you're on a call. Some of the Soft Keys will not be available when in this mode.

Soft Keys - Soft Keys appear on the LCD screen of the handsets directly below the LCD. The functions of these keys change based on the mode (standby or talk) or menu.

Symbols On The LCD

-  Hands Free Mode
-  Off-hook Mode
-  Battery Charge Status
- INT Internal Call
- EXT External Call
-  Conference Call
-  Alarm or Appointment is Set
-  External Ring Disabled

Key Descriptions

-  Current functions & display keys
-  Redial key (also Flash function)
-  Talk key (press briefly)
-  Hands Free key (hold down)
- Control keys:
-  Up: Caller ID List
-  Down: Phone Book Menu
-  Talk off key or one menu level back (press briefly)
-  Power on/off or Return to idle state (hold down)
-  *^{INT} Internal call key (hold down * key)

Parts Checklist

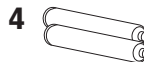
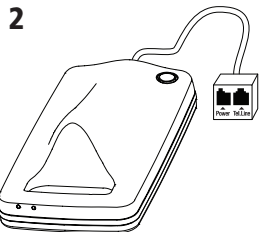

1. This user's guide
2. Base unit
3. Handset
4. 2 rechargeable batteries
5. Power adapter
6. Telephone line cord

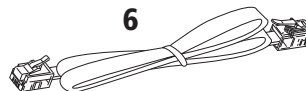
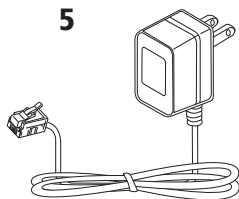

Handset and Base Functions & Controls

1. Ear piece (speaker)
2. LCD
3. Navigation Key Up
4. Soft Key 1
5. Soft Key 2
6. Talk On
7. Talk Off
8. Navigation Key Down
9. Number Keys
10. * Key (Press and hold for Internal Call)
11. Microphone
12. Page handset(s)
13. Charging LED
14. Visual Ringer LED

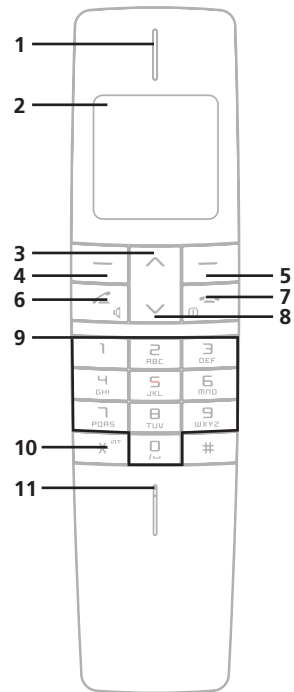
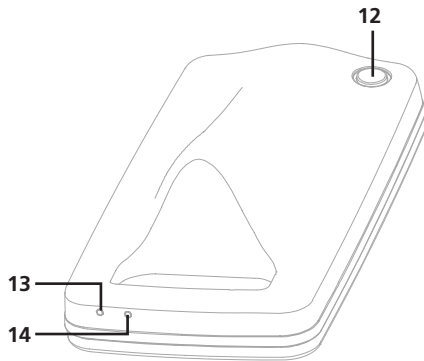

Connection Diagram

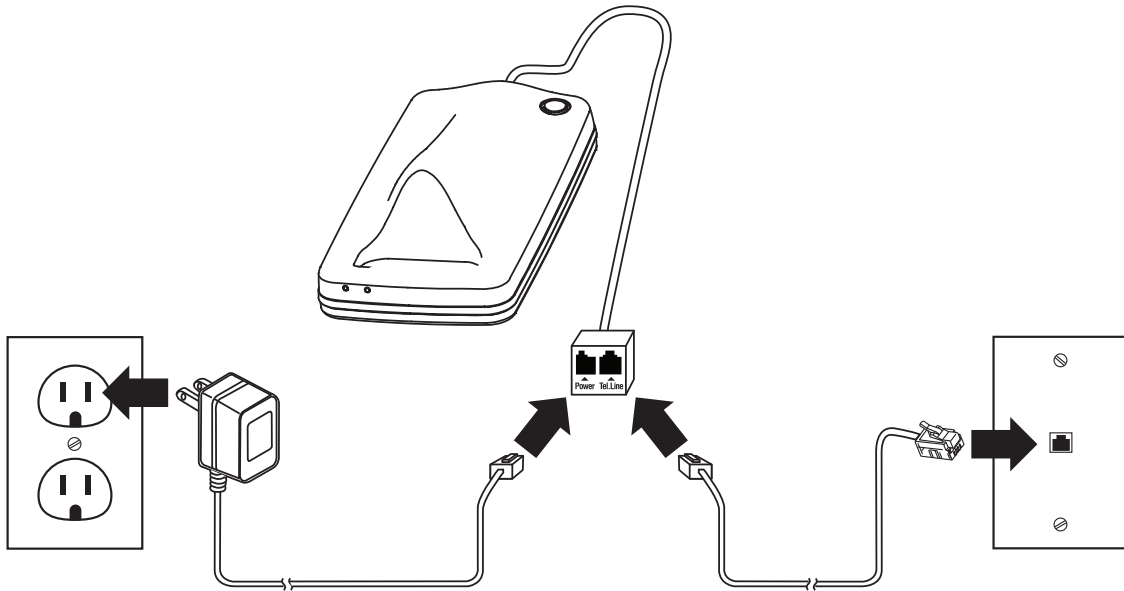

Getting Started

Powering On and Off the Handset

Power Off

To turn off the handset:

1. Press the  key for 2 seconds.

After the validation melody, the handset will be switched off.

Power On



To turn on the handset:

1. Press the  key while in the power off state.





The handset will turn on. It will search for the base station and the handset LCD will display "Searching". After locating the base, the initial screen is displayed on the handset LCD.

Access to Ringer Menu

You can customize the ring tone you hear for incoming calls through the handset and the base.





1. Press the **Menu** key (Soft Key 1 ) . Choose the *"Ringer"* Menu using the \wedge or \vee keys.
2. Press the **Back** key (Soft Key 2 ) or the Ⓜ key to return to the previous menu. And press the ⏪ key to return to standby mode.

Ring mode setting for handset

1. Go to the *"Ringer"* menu. Press the **OK** key (Soft Key 1 ) .
2. Choose *"Incoming Call"* . Press the **OK** key (Soft Key 1 ) .
3. Choose *"Ring Mode"* . Press the **OK** key (Soft Key 1 ) .
4. Browse through the ring modes. Press the **OK** key (Soft Key 1 ) to select the desired ring mode:
 - a. *"Standard"*: Standard Ring mode.
 - b. *"Disable"*: Ring tone is disabled.
 - c. *"Ring After #"*: Select from 1 ring to 4 rings
5. Press the **OK** key (Soft Key 1 ) . The ring tone you selected is enabled.

Volume setting for handset



You also can set the volume for the melody.

1. Go to *"Ringer"* menu. Press the **OK** key (Soft Key 1 )
2. Choose *"Incoming Call"*. Press the **OK** key (Soft Key 1 )
3. Choose *"Volume"*. Press the **OK** key (Soft Key 1 )
. The display will show the previously stored volume level.4. Choose from volumes 1 through 9. Press the **OK** key (Soft Key 1 ) to confirm.

Adjusting the earpiece volume





You can change the listening volume at any point during a conversation.

While on a phone call:





1. Press the **Options** key (Soft Key 1 )
. Then, use the \wedge or \vee keys to choose *"Ear Volume"*.2. Press the **OK** key (Soft Key 1 )
.3. Press the \wedge or \vee keys to choose the appropriate ear volume: 1-5.
4. Press the **OK** key (Soft Key 1 )
.

Melody setting for handset

You can choose from 13 different ring melodies for the handset.





1. Go to the *"Ringer"* menu. Press the **OK** key (Soft Key 1 )
2. Choose *"Incoming Call"*. Press the **OK** key (Soft Key 1 )
3. Choose *"Melody"*. Press the **OK** key (Soft Key 1 )
4. Choose from melodies 1 through 13. Press the **OK** key (Soft Key 1 ) to confirm.

Ring mode setting for base

1. Go to the *"Base Settings"* menu. Press the **OK** key (Soft Key 1 )
2. Choose *"Base Ring Tone"*. Press the **OK** key (Soft Key 1 )
3. Choose *"Ring Mode"*. Press the **OK** key (Soft Key 1 )
4. Browse through the ring modes. Press the **OK** key (Soft Key 1 ) to select the desired ring mode:
 - a. *"Standard"*: Standard Ring mode.
 - b. *"Disable"*: Ring tone is disabled.
 - c. *"Ring After #"*: Select from 1 ring to 4 rings
5. Press the **OK** key (Soft Key 1 ) . The ring tone you selected is enabled.





Volume setting for base

You also can set the volume for the melody.

1. Go to *"Base Settings"* menu. Press the **OK** key (Soft Key 1 )
2. Choose *"Base Ring Tone"*. Press the **OK** key (Soft Key 1 )
3. Choose *"Volume"*. Press the **OK** key (Soft Key 1 )
. The display will show the previously stored volume level.4. Choose from volumes 1 through 9. Press the **OK** key (Soft Key 1 ) to confirm.





Melody setting for base

You can choose from 9 different ring melodies.

1. Go to the *"Base Settings"* menu. Press the **OK** key (Soft Key 1 )
2. Choose *"Base Ring Tone"*. Press the **OK** key (Soft Key 1 )
3. Choose *"Melody"*. Press the **OK** key (Soft Key 1 )
4. Choose from melodies 1 through 9. Press the **OK** key (Soft Key 1 ) to confirm.



Setting the date and the time

You can set the date and time. The clock is in 24-hour mode.



1. Go to the *"HS Settings"* Menu. Choose *"Set Clock"*.
2. Press the **OK** key (Soft Key 1 ). Enter the month, day and year.
3. Press the **OK** key (Soft Key 1 ). Enter the hours and minutes.
4. Press the AM/PM key (Soft Key 2 ). Choose the desired option.
5. Press the **OK** key (Soft Key 1 ) to confirm.

Setting the area code

You can enter your home area code to indicate which phone numbers are local calls.



1. Go to the *"HS Settings"* menu. Press the **OK** key (Soft Key 1 ).
2. Choose *"Set Area Code"*. Press the **OK** key (Soft Key 1 ).
3. Enter the area code. Press the **OK** key (Soft Key 1 ) to confirm.

Setting keypad tones

1. Go to the *"HS Settings"* menu. Press the **OK** key (Soft Key 1 )
2. Choose *"Keypad Tones"*. Press the **OK** key (Soft Key 1 )
3. Choose *"On"* to enable this function and choose *"Off"* to disable the function. Press the **OK** key (Soft Key 1 )



Setting the backlighting of LCD display

You can choose to turn the LCD backlight on or off while in standby mode.

1. Go to the *"HS Settings"* menu. Press the **OK** key (Soft Key 1 )
2. Choose *"Backlighting"*. Press the **OK** key (Soft Key 1 
 - a. Choose *"Standard"* to turn on backlighting for 30 seconds.
 - b. Choose *"Enable"* to always turn on backlighting.

Setting the language



The handset can display menus and information in either English or Spanish. To set the language:

1. Go to the *"HS Settings"* menu. Press the **OK** key (Soft Key 1 )
2. Choose *"Language"*. Press the **OK** key (Soft Key 1 )
3. Choose either English or Spanish. Press the **OK** key (Soft Key 1 ) to confirm.



Prefix Dialing

If the telephone is connected to a PABX, you can set the code to access an external line (usually 0 or 9). This gives the possibility to insert a pause between dialing the access code and the phone number.

To enable this prefix dialing:

1. Go to the **"Base Settings"** menu. Press the **OK** key (Soft Key 1 )
2. Choose **"Prefix Dialing"**. Press the **OK** key (Soft Key 1 )
3. Insert the desired external access number (1 digit). Press the **OK** key (Soft Key 1 ) to confirm.

To disable prefix dialing:

1. Go to the **"Base Settings"** menu. Press the **OK** key (Soft Key 1 )
2. Choose **"Prefix Dialing"**. Press the **OK** key (Soft Key 1 )
3. Delete the external access number. Press the **OK** key (Soft Key 1 ) to confirm.

When prefix dialing is set, the prefix automatically will be added to phone numbers in the Phone Book, Received Calls, and Missed Calls.

Flash



While on a call, you may want to transfer the call to someone else connected to the same PABX. This can be done by using the flash function.

- Press the **Flash** key (Soft Key 2 ) or press and hold the # key for 2 seconds during an external call.

The base station will then transmit a FLASH signal to the line.

Inter-digit pause

Some phone numbers require you to dial additional digits a few seconds after entering the phone number. You can insert a 3-second pause while in pre-dialing mode.

1. Enter the first set of numbers.
2. Press the ^ key and a "-" will be inserted. Alternatively, you can press the **Options** key (Soft Key 1 ) and choose the item *"Insert Pause"*.
3. Enter the number you want to dial, and press the  key to start a call.

Register to Base

In multi-handset mode, you may need to switch the base to which a handset is assigned. Up to four assignments are possible. You can set based selection manually or automatically.

Register an optional handset

1. Press and hold down the button on the base for 5 seconds or until the base begin to give out a confirmation tone.
2. Go into the *"HS setting"* menu of the handset and press the \wedge or \vee keys until the *"Register to BS"* is selected. Press the **OK** key (Soft Key 1 \square) and select the base number (from 1 to 4) where the handset should be registered by using the \wedge or \vee keys.
3. Press the **OK** key (Soft Key 1 \square). The handset now searches for the base. When it finds the signal, the Base Identification Code is displayed.
4. Press the **OK** key (Soft Key 1 \square) and insert the PIN code (default 1590). Press the **OK** key (Soft Key 1 \square) to confirm.

Register a handset on a secondary base

The procedure is the same as previously shown in "Register an optional handset". At the end of this procedure, the base will assign the number to the handset automatically.

If the base where you want to register a handset is a different model,

NOTE!

When registering an optional handset or registering a handset on a secondary base, you must know the PIN code of the base where the handset will be registered.

use the instructions of this base to place it in registration mode.

When you need to register a different handset on the base of your telephone, you can place it in registration mode by pressing and holding the key on the base for 5 seconds or until it gives out a confirmation tone. Then, follow the specified registration procedure for the other handset.

Manual selection of a base



This function is used to select one specific base among the ones to which the handset is already assigned. This selection will not change automatically when the handset loses synchronization with the base.

1. Go to the *"HS Settings"* Menu and choose *"Switch Base"*. The display now shows the currently selected base's number.
2. Use the \wedge or \vee keys to select the base. Press the OK key (Soft Key 1). The handset tries to search for the selected base.
3. Press the **OK** key (Soft Key 1 ) to confirm once the base is located.

Automatic base search

This function is used to enable the automatic base selection mode. Automatic selection means that every time the handset loses synchronization with the current base, it will look for another one automatically from its list of bases.

Once enabled, the automatic selection remains active until the next manual selection or the next assignment.



1. Go to the **"HS Settings"** Menu. Choose **"Switch Base"**. The display will show the current base's number.
2. Choose **"Automatic"** by using the navigation key.
3. Press the **OK** key (Soft Key 1 ). The handset will start the search for the base that has the strongest signal. Then, the handset will show the number of the base with the strongest signal.
4. Press the **OK** key (Soft Key 1 ) to confirm.

Telephone Operation

Making and receiving calls



There are two ways to make a phone call – manually or using pre-dialing mode.

Make a call in talk mode

1. When the handset is in standby mode, press the  key and listen for the dial tone. Then, dial the destination phone number.
2. During the call, you will see the call duration time on the display.
3. To terminate the call, press the  key.

Make a call in pre-dialing mode

You can enter the destination number before entering talk mode. In pre-dialing mode, it's possible to make corrections if you enter an incorrect destination number. With the unit in standby mode, follow this procedure:

1. Enter the destination number.
2. Press the **Delete** key (Soft Key 2 ) to erase the last inserted number or press more than once to erase more numbers.
3. Press the  key to erase all the numbers and return to standby mode.
4. Press the  key to start the call.

Out of range indication

The cordless system uses special digital signal processing to ensure maximum range for your call. If you go out of base range during a conversation, the handset begins to give out an acoustic signal. To avoid dropping your call, approach the base until the acoustic signal ends.



If you go out of range while in standby mode, the display will show *"Out of Range"*.

Call duration time

The call duration time appears on the LCD after making or receiving a call. This function starts 5 seconds after the beginning of a conversation and ends 3 seconds after the call is complete. The time is shown in minutes and seconds (mm : ss).







Answering a call

When you receive an incoming call, both the base and the handset ring. Also, the LCD will display **“External”**. Press the  key or the **Accept** key (Soft Key 1 ) to answer the call. To end the call, press the  key or put the handset on the base.

Repeat one of the last 10 dialed numbers



The phone stores the last 10 numbers that have been dialed. To retrieve one of those numbers, start in standby mode:

1. Press the **Redial** key (Soft Key 2 ). The display will show the last dialed numbers.
2. Choose the destination number using the  or  keys.
3. Press the  key to start the call.
4. Press the **Options** key (Soft Key 1 ). From here, you'll have 4 options:
 - Choose the **“Details”** option to see the full list of recently dialed numbers.
 - Choose the **“Save”** option to store the number to the phone book.
 - Choose the **“Delete”** option to delete the number from the Redial list.
 - Chose the **“Call”** option to dial.

Holding with on-hold music

You can place the other party on hold at any point during the call. The other party will hear hold music on their end.



After placing the other party on hold, the handset LCD will display **"Hold"**. While on a phone call:

1. Press the **Options** key (Soft Key 1 ) and use the \wedge or \vee keys to choose **"Hold"**.
2. Press the **OK** key (Soft Key 1 )
3. Press the **Disable** key (Soft Key 2 ) to return from holding mode.

Microphone muting





You can mute your end of the conversation at any point during the call. The other party will hear silence on their end.

After muting the call, the handset LCD will show **"Muted"**. While on a phone call:

1. Press the **Options** key (Soft Key 1 ) and use the \wedge or \vee keys to choose **"Mute"**.
2. Press the **OK** key (Soft Key 1 )
3. Press the **Disable** key (Soft Key 2 ) to get out of mute mode.





Transferring a call

In a multi-handset configuration, it is possible to transfer a call from one handset to another. To transfer an external call between handsets:

1. Press the **Option** key (Soft Key 1 ) and choose *"Internal Call"*.
2. Select the desired handset's number and press the **OK** key (Soft Key 1 )
3. Press the  key or **Accept** key (Soft Key 1 ) on the called handset to answer the call.
4. To transfer the external call, press the  key on the calling handset.

Call conferencing

An external call can be conferenced with another handset during a conversation. The procedure is similar to that for transferring a call.

1. Press the **Option** key (Soft Key 1 ) and choose *"Internal Call"*.
2. Select the desired handset's number and press the **OK** key (Soft Key 1 )
3. Press the  key or **Accept** key (Soft Key 1 ) on the called handset to answer the call.
4. Press the **Option** key (Soft Key 1 ) and choose *"Conference"*.
5. The external call is connected to both of the handsets and the con-

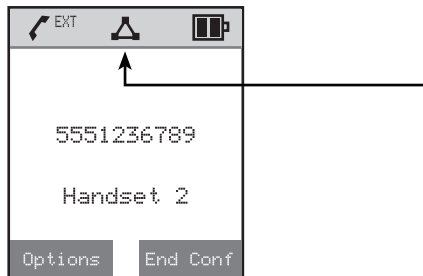

ference conversation is enabled. The display will show:



6. Press the **EXT** key on one of the two handsets to transfer the call completely to the other handset.

Using the intercom

In a multi-handset configuration, it is possible to make an internal call between two handsets. To make an internal call:



1. Press and hold the ***INT** key.
2. Select the handset's number and press the **OK** key (Soft Key 1 .
3. The called handset begins to ring and will flash the **INT** icon. Press the **EXT** key or **Accept** key (Soft Key 1 ) to answer.
4. Press the **EXT** key on both of the handsets to end the conversation.

Room monitoring

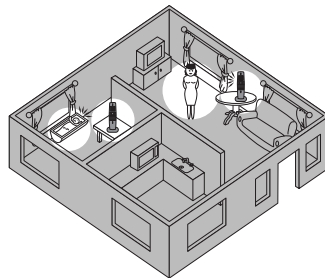
You can monitor another room as long as two handsets are registered to the same base. For example, you could monitor a child by placing one handset in your room and another handset in the child's room.



To enable this function:



1. Go to the *"HS Settings"* menu. Press the **OK** key (Soft Key 1 ).
2. Choose *"Room Monitor"*. Press the **OK** key (Soft Key 1 ).
3. Choose *"On"* to enable the function and choose *"Off"* to disable the function. Press the **OK** key (Soft Key 1 ).

To use this function, enable the function on one handset and place it in another room. Try placing an internal call to that handset. To stop the room monitoring, press the  key.





Paging a handset

If you misplace the handset, you can use the paging function to find it again. To use the paging function, push the button on the base. The handset will ring for 20 seconds. To stop the ringing, push the same button on the base. Or, you can press the  key on the handset.

Call Waiting

If during an internal conversation, an external call comes in, the telephone will make an acoustic warning in the earpiece and the display will blink with the *EXT* symbol. To finish the internal conversation, press the  key and wait for the ring. Then, press the  key to answer the call.

Caller ID

1. To go to the Caller ID List, press the **Menu** key (Soft Key 1 ). Choose the *"Caller ID List"*. Press the **OK** key (Soft Key 1 ) to see the *"Caller ID List"*.
2. Use the  or  keys to browse the list.
3. Press the **Options** key (Soft Key 1 ). From here, you will have several options:
 - a. Choose *"Details"* to show the date, time, and telephone number of the call (only if this kind of information is available). The user can change the dial number format prior to starting a call by pressing the Format key.

- b. Choose **"Save"** to store this entry to your phone book.
- c. Choose **"Delete"** to delete the entry from the Caller ID list.
- d. Choose **"Call"** to dial the phone number.

Phone book

Your phone is featured with a phone book that has the capacity to store up to 40 different name and number entries. The phone book feature allows you to copy entries from one handset to another or from the base to the handsets without manually having to re-enter names and numbers.







Storing an entry

The phone has an alphanumeric phone book that can store 100 names and numbers. Names can be up to 15 characters long and phone numbers can be up to 25 digits.

Every numeric key has additional characters available which you can use when storing names and numbers in the phone book:



KEY	Number of times to press the key								
	1	2	3	4	5	6	7	8	9
1	@	.	,	?	1	l	-	&	/
2	A	B	C	2	a	b	c	Á	É
3	D	E	F	3	d	e	f	É	é
4	G	H	I	4	g	h	i	í	ï
5	J	K	L	5	j	k	l	ó	ú
6	M	N	O	6	m	n	o	Ó	ú
7	P	Q	R	7	p	q	r	ó	ú
8	T	U	V	8	t	u	v	Û	ü
9	W	X	Y	9	w	x	y	z	z
0	/	-	£	€	0	\$:	:	/



To store an entry in the phone book, start in standby mode:

1. Press the **Menu** key (Soft Key 1 ) and use the \wedge or \vee keys to choose the **Phone Book** icon. Press the \wedge or \vee keys to choose **"Add Entry"**.
2. Press the **OK** key (Soft Key 1 )
3. After the character insertion, press the **OK** key (Soft Key 1 )
4. During the character insertion, press the **Delete** key (Soft Key 2 ) to erase the last character.
5. Press the **OK** key (Soft Key 1 ) to enter the telephone number.
6. Enter the new telephone number.
7. Press the **Options** key (Soft Key 1 )
 - a. Choose the **"Save"** item to save the entry.
 - b. Choose the **"VIP Ringer"** item to select a ring melody. The phone will play this melody when someone calls from this phone number.

Viewing entries





You can also display a number from the phone book without dialing it.

1. Press the **Menu** key (Soft Key 1 ) and use the \wedge or \vee keys to choose the **Phone Book** icon. Press the **OK** key (Soft Key 1 )
2. Choose **"Find"**.









3. Enter one or more characters for the entry you are trying to find. Press the **Find** key (Soft Key 1 ) .
4. Select the required entry.
5. Press the **Options** key (Soft Key 1 ) and choose the *"Dial Number"*. Press the  key and the number will be dialed.

Calling an entry

Once a name and number are saved in the phone book, you can search for and dial that number directly.

1. Press the **Menu** key (Soft Key 1 ) and use the \wedge or \vee keys to choose the *Phone Book* icon. Choose *"Find"*.
2. Press the **OK** key (Soft Key 1 ) .
3. Enter the first letter of the name that you want to find. Press the **Find** key (Soft Key 1 ) . You will be able to see all the names that have been stored in the phone book that begin with the letter you entered. The names will be listed in alphabetical order.
4. Select the name that you want to dial.
5. Press the  key or the **Call** key (Soft Key 2 ) to dial the number.

Editing an entry



1. Press the **Menu** key (Soft Key 1 ) and use the \wedge or \vee keys to choose the *Phone Book* icon and the **OK** key (Soft Key 1 ). Choose *"Find"*.
2. Find the entry that you want to modify.
3. Press the **Options** key (Soft Key 1 .
4. Choose *"Edit Entry"*.
5. Press the **OK** key (Soft Key 1 ). Change the name, if necessary.
6. Press the **OK** key (Soft Key 1 ). Change the telephone number, if necessary.
7. Press the **Options** key (Soft Key 1 .
8. Choose *"Save"* to save the entry.
9. Choose *"Modify Melody"* to assign a different melody to the entry.
10. Press the **OK** key (Soft Key 1 .
11. Choose the melody.
12. Press the **OK** key (Soft Key 1 ) to save the selected melody.
13. Choose *"Save"* and press the **OK** key (Soft Key 1 ) to save your changes.

NOTE!

IMPORTANT: Once the phone book entries are deleted, they cannot be recovered.

Deleting an entry

If you enter a duplicate name and number or no longer want to save an entry, you can delete it from the phone book.



1. Press the **Menu** key (Soft Key 1 ) and use the \wedge or \vee keys to choose the **Phone Book** icon. Choose **"Delete"**.
2. Press the **OK** key (Soft Key 1 .
3. Press the **OK** key (Soft Key 1 ) again to delete all the entries.

Caller ID (CID)**Calling a Caller ID number**

1. To show the last 10 numbers that were dialed, press the **Menu** key (Soft Key 1 ) and use the \wedge or \vee keys to choose the **Call List** icon.
2. Choose the **"Redial List"**.
3. Use the \wedge or \vee keys to look through the redial list.
4. Press the **Options** key. From here, you will have several options:
 - a. Choose **"Save"** to store the number to the phone book.
 - b. Choose **"Delete"** to delete the number from the redial list.
5. Press the \swarrow key to dial the phone number.

Deleting a Caller ID number

You can delete the names and numbers from the Caller ID, Redial, and Missed Calls lists at any time.

1. Press the **Menu** key (Soft Key 1 ) and use the \wedge or \vee keys to choose the **Call List** icon.
2. Choose **"Delete All"**.
3. Press the **OK** key (Soft Key 1 ). From here, you will have the option to delete one or all of the call lists.
 - a. Choose **"Caller ID List"** to delete the received calls list.
 - b. Choose **"Missed Calls"** to delete the missed calls list.
 - c. Choose **"Redial List"** to delete the dialed calls list.
 - d. Choose **"All Calls"** to delete all 3 of the call lists (Caller ID, Missed, and Dialed).

NOTE!

IMPORTANT: Once a call list deleted, it cannot be recovered.

Voice Mail Waiting Indicator (VMWI)

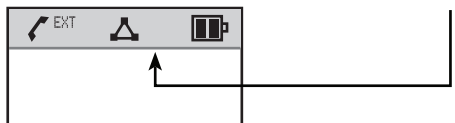

If you subscribe to a Voice Mail service provided by your local telephone company and you have a voice mail message, the display will show:



Alarm Clock



Setting the alarm

You can use your handset as an alarm.

1. To go to the Alarm menu, press the Menu key (Soft Key 1 ). Select **"Alarm Clock"**. Press the **OK** key (Soft Key 1 ).
2. Choose **"Alarm"**. Press the **OK** Key (Soft Key 1 ).

Activating the alarm clock

Once activated, the alarm clock will ring at the same time every day. When the alarm is set, you will see a  icon on the LCD display.

1. Go to the **"Alarm Clock"** menu. Choose **"On"**. Press the **OK** key (Soft Key 1 ).
2. Enter the alarm time in hours and minutes. Press the **OK** key (Soft Key 1 ) to confirm.

Deactivating the alarm clock

1. Go to the **"Alarm Clock"** Menu. Choose **"Off"**. Press the **OK** key (Soft Key 1 ).





Turning off the alarm call



When the alarm clock goes off, the handset will ring and the word **"Alarm"** will blink for approximately 20 seconds. To turn it off, press any key on the handset.

Appointment function

The alarm clock also can be used to set appointments.





Setting the appointment

1. Go into the *“Alarm Clock”* menu and press the **OK** Key (Soft Key 1 ). Choose *“Appointment”*. Press the **OK** Key (Soft Key 1 ). *“No appointment set”* will appear on the LCD display.
2. Press the **Set** Key (Soft Key 1 ). Choose from *“Daily”*, *“Monthly”*, or *“Annual”*.
3. Set the date and time as appropriate:
 - a. Daily: time
 - b. Monthly: day and time
 - c. Annual: day/month and time
4. Press the **OK** Key (Soft Key 1 ).
5. Enter the text for the appointment. (See the *“Storing an Entry”* section in *“Phone Book Functions”* to locate letters and other characters.) After inserting a character, wait a second before inserting the next character. Press the **Delete** key to erase the last character.
6. Press the **OK** Key (Soft Key 1 ) once you have entered all of your text for the appointment.

7. Press the **Enable** key (Soft Key 2 ) to make the appointment active.
8. Press the  key to exit the menu.



Modifying the date of the appointment



Once you have entered an appointment, you can change the date and time.

1. Go into the *“Alarm Clock”* menu and press the **OK** key (Soft Key 1 ). Choose *“Appointment”*.
2. Press the **OK** key (Soft Key 1 ). The current appointment setting is displayed.
3. Press the **Options** key (Soft Key 1 ). Choose *“Modify Date”*. The current date and time are displayed.
4. Change the date and time as needed. Press the **OK** key (Soft Key 1 .

Modifying the subject of the appointment





Once you have entered an appointment, you can change the appointment text.

1. Go into the *“Alarm Clock”* menu and press the **OK** key (Soft Key 1 ). Choose *“Appointment”*.
2. Press the **OK** key (Soft Key 1 ). The current appointment setting is displayed.

3. Press the **Options** key (Soft Key 1 ). Choose *“Modify Subject”*. The current subject is displayed.
4. Change the subject as needed. Press the **OK** key (Soft Key 1 ).



Deleting the appointment

Once you have entered an appointment, you can delete it from the Alarm Clock memory.

1. Go into the *“Alarm Clock”* menu and press the **OK** key (Soft Key 1 ). Choose *“Appointment”*.
2. Press the **OK** key (Soft Key 1 ). The current appointment setting is displayed.
3. Press the **Options** key (Soft Key 1 ). Choose *“Delete”*. *“Delete the appointment?”* is shown on the LCD display.
4. Press the **OK** key (Soft Key 1 ). The current appointment setting is deleted.



Viewing the subject of the appointment

You can view the subject of an appointment that has been set.

1. Go into the *“Alarm Clock”* menu and press the **OK** key (Soft Key 1 ). Choose *“Appointment”*.
2. Press the **OK** key (Soft Key 1 ). The current appointment setting is displayed.

NOTE!





It is not possible to deregister the handset that you use to perform this operation.

3. Press the **Options** key (Soft Key 1 ). Choose *“View Subject”*.
4. Press the **OK** key (Soft Key 1 ). The subject is displayed.

Deregister the Handset



You can deregister one or more handsets previously assigned to the same base.

To deregister a handset:



1. Go to the *“Base Settings”* menu. Press the **OK** key (Soft Key 1 ).
2. Choose *“Deregister HS”*. Press the **OK** key (Soft Key 1 ).
3. Choose the handset you would like to deregister. Press the **OK** key (Soft Key 1 ). The display will show *“Deregister Handset n ?”*, where *n* is the handset number.
4. Press the **OK** key (Soft Key 1 ) to confirm.

Call Blocking

You can block up to 5 locations with up to 5 digits. It is possible to specify the number and handset that cannot make a call to that prefix.

1. Go to the *“Base Settings”* menu. Press the **OK** key (Soft Key 1 ).
2. Choose *“Call Blocking”*. Press the **OK** key (Soft Key 1 ). The display will show *“Prefix 1: _”* or the stored blocking number.
 - a. Note: When you delete the stored blocking number and



press the **OK** key (Soft Key 1 ) , the call blocking function is disabled.

3. Insert the new blocked number or go to the next blocking location and enter a new blocked number.
4. Press the **OK** key (Soft Key 1 ) to confirm. The display will show "*Handset n*", where *n* is the stored handset number.
5. Choose the handset that will be blocked from calling that prefix.
6. Press the **OK** key (Soft Key 1 ) to confirm.

The call blocking function will be enabled and it would not be possible to make a call to the stored, blocked number.

Factory Reset

The Reset operation allows the user to reset all the customized settings including the phone book and the received caller ID list. To execute the reset with the handset in standby mode:

1. Go into the "*HS Settings*" menu. Press the **OK** key (Soft Key 1 ) .
2. Choose "*Factory Reset*". Press the **OK** key (Soft Key 1 ) . "*Are you sure ?*" is displayed on the LCD.
3. Press the **OK** key (Soft Key 1 ) to confirm.

Troubleshooting

Problem	Solution
If the phone does not work, check all of the following:	<ul style="list-style-type: none"> • Make sure the batteries are installed properly in the handset and that the battery plug is firmly clicked into place • Make sure the AC adapter is plugged into the wall and that the outlet is not controlled by a wall switch • Make sure the telephone line cord is plugged into the phone and into the wall jack • Make sure your battery is charged
If you hear static on the line:	<ul style="list-style-type: none"> • Move closer to the base • Move away from metal objects or electrical items that may cause interference
If you cannot hear the phone ringing when a call comes in:	<ul style="list-style-type: none"> • Check that the ringer is turned on • Move closer to the base • Phone may not be properly registered to the base. To re-register, see "Register to base" on page 17.

Specifications

Frequency Range	1.920 ~ 1.930GHz
RF Channel	5 Channels
Max Output Power	20.8 dBm
TDMA slot per frame	24 slot
Modulation	GFSK
Speech Encoding	ADPCM (32Kbps)

Precautions

1. Read and understand all instructions in the user's guide. Observe all markings on the product.
2. Avoid using the telephone during a thunderstorm.
3. Do not use the telephone in the vicinity of a gas leak.
4. Do not use this product near water.
5. If this phone does not operate normally, read the "Troubleshooting" section in the user's guide.
6. Replace batteries only as describe in the user's guide.

This product has a one-year over the counter warranty. For any inquiries after the warranty period, please contact IntelliTouch at (800) 400-5156. Hours are from 8:00 a.m. to 5:00 p.m. PST, Monday through Friday or visit www.sbctelephones.com.



In case of difficulties, visit our service center at www.sbctelephones.com or call **800-400-5156**

© 2006 Intellitouch
All rights Reserved
SBC is a trademark of AT&T Knowledge Ventures, L.P.
Licensed to IntelliTouch
Printed in China

FCC Information

1. This equipment complies with Part 68 of the FCC rules and the requirements adopted by the ACTA. On bottom of this equipment is a label that contains, among other information, a product identifier in the format US: 7TNW400BITC60202. If requested, this number must be provided to the telephone company.
2. An applicable certification jacks Universal Service Order Code (USOC) for the equipment is provided (i.e., RJ11C) in the packaging with each piece of approved terminal equipment.
3. A plug and jack used to connect this equipment to the premise wiring and telephone network must comply with the applicable FCC Part 68 rules and requirements adopted by the ACTA. A compliant telephone cord and modular plug is provided with this product. It is designed to be connect to a compatible modular jack that is also compliant. See installation instructions for details.
4. The REN is used to determine the number of devices that may be connected to telephone line. Excessive RENs on a telephone line may result in the device's not ringing in response to an incoming call. In most but not all areas, the sum of RENs should not exceed five (5.0). To be certain of the number of devices that may be connected to a line, as determined by the total RENs, contact the local telephone company. [For products approved after July 23,2001, the REN for this product is part of the product identifier that has the format US: 7TNW400BITC60202. The digits represented by ## are the REN without a decimal point (e.g., 03 is a REN of 0.3). For earlier products, the REN is separately shown on the label.]
5. If this equipment causes harm to the telephone network, the telephone company will notify you in advance that temporary discontinuance of service may be required. But if advance notice isn't practical, the telephone company will notify the customer as soon as possible. Also, you will be advised of your right to file a complaint with the FCC if you believe it is necessary.
6. The telephone company may make changes in its facilities, equipment, operations or procedures that could affect the operation of the equipment. If this happens, the telephone company will provide advance notice in order for you to make necessary modifications to maintain uninterrupted service.
7. Please follow instructions for repairing if any (e.g. battery replacement section); otherwise do not alternate or repair any parts of device except specified.
8. Connection to party line service is subject to state tariffs. Contact the state public utility commission, public service commission or corporation commission for information.
9. Should you experience trouble with this equipment, please contact:

IntelliTouch

**5160 Carroll Canyon Road
San Diego, CA 92121-1775**

Customer Service: (800)296-3084 8 a.m. To 5 p.m. PST, Monday through Friday

CAUTION:

To maintain compliance with the FCC's RF exposure guidelines, place the base unit at least 20cm from nearby persons.

Symbols

1.9 GHz 2, 41

A

AAA 3
 Accept 22, 24, 25
 access code 3, 15
 acoustic 21, 27
 Adjustable 3
 Alarm 3, 4, 34, 35, 36, 37
 antenna 3
 Appointment 3, 4, 35, 36, 37
 Automatic 18, 19

B

backlighting 14
 base 40
 batteries 40, 41
 battery 2, 3, 40, 43
 Blocking 38

C

Call duration 21
 Caller ID 3, 4, 27, 28, 32, 33
 Call Waiting 27
 channels 41
 CID 32
 Clock 13, 34, 35, 36, 37
 code 3, 13, 15, 17
 conferenced 24
 conferencing 24
 Connection 7, 43
 conversation 10, 21, 23, 24, 25, 27
 cord 5, 40, 43
 cordless 2, 21

D

date 13, 27, 35, 36
 DECT 2
 Delete 15, 20, 22, 28, 29,
 32, 33, 35, 37
 Deleting 32, 33, 37
 Deregister 38
 duration 20, 21

E

earpiece 10, 27
 external 3, 15, 16, 24, 27

F

Flash 4, 16
 frequency range 41

H

handset 40
 Hold 3, 23
 hours 2, 3, 13, 34

I

Incoming 3, 9, 10, 11
 Inter-digit 16
 intercom 3, 25
 internal 3, 25, 26, 27

K

keypad tones 14

L

language 3, 14
 LED 6
 levels 3

M

melodies 3, 11, 12
 Microphone 3, 6, 23
 Missed 15, 33
 Mode 4, 9, 11
 mode 4
 Modify 31, 36, 37
 modulation 41
 monitoring 3, 26

N

Navigation Key 6
 NiCad 5

O

Options 10, 16, 22, 23, 27, 29,
 30, 31, 32, 36, 37, 38

Index**P**

PABX 3, 15, 16
 Paging 3, 27
 pause 15, 16
 phone 2, 4, 40, 41
 PIN 17
 power adapter 5
 Prefix 15, 38

R

radio channels 2
 range 21
 rechargeable 3, 5
 Redial 4, 22, 32, 33
 Register 17, 40
 Repeat 22
 Reset 39
 Ringer 6, 9, 10, 11, 29
 ring tone 9, 11

S

sensitivity 41
 signal 3, 16, 17, 19, 21
 soft key 4
 Soft Keys 3, 4
 soft keys 4
 standby 4, 8
 static 40
 subject 36, 37, 38, 43

T

Talk 4, 6
 talk 4
 talk mode 4
 telephone line 5
 time 2
 Transfer 3
 Transferring 24

V

Visual Ringer 6
 VMWI 1, 33

W

wall jack 40
 warning 3, 27

Free Manuals Download Website

<http://myh66.com>

<http://usermanuals.us>

<http://www.somanuals.com>

<http://www.4manuals.cc>

<http://www.manual-lib.com>

<http://www.404manual.com>

<http://www.luxmanual.com>

<http://aubethermostatmanual.com>

Golf course search by state

<http://golfingnear.com>

Email search by domain

<http://emailbydomain.com>

Auto manuals search

<http://auto.somanuals.com>

TV manuals search

<http://tv.somanuals.com>