

ECD-T1550

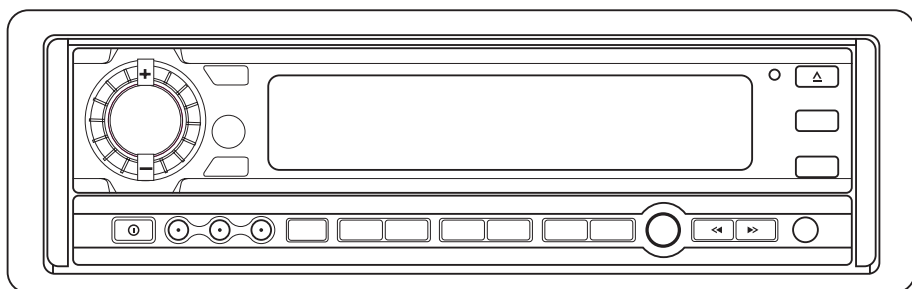

- **PLL Synthesizer Stereo Radio**
- **Digital Compact Disc Player**
- **Automatic Memory Storing**
- **Motorized Hidden Panel**
- **Preset Equalization**
- **Auxiliary Input Jack**
- **Credit Card Remote Control**
- **Multi-Color LCD**
- **Plays CD-R/RW discs**

CONTENTS

Installation.....	3	Repeating the same track.....	11
Take out screw before installation ...	3	Playing all tracks in random.....	11
DIN Front-Mount (Method A).....	3	Ejecting a disc.....	11
Installing the unit.....	3	Disc notes.....	11
Removing the unit.....	4	Specification.....	12
DIN Rear-Mount (Method B).....	5	Trouble shooting.....	13
Using the front panel.....	6		
Wiring Connection.....	7		
Operation.....	8		
Switching on/off the unit.....	9		
Faceplate release	9		
Sound adjustment	9		
Loudness	9		
Set the clock.....	9		
Mute	9		
Equalization	9		
Liquid crystal display.....	9		
Flashing LED	9		
Remote sensor	9		
Reset function	9		
Radio operation	10		
Switching to radio mode.....	10		
Selecting the frequency band	10		
Selecting station	10		
Local/distant	10		
Automatic memory storing& program scanning	10		
Station storing.....	10		
Mono/stereo.....	10		
CD operation	10		
Switching to CD mode.....	10		
Selecting tracks.....	11		
Pausing playing.....	11		
Previewing all tracks	11		

INSTALLATION

Notes:

- Choose the mounting location where the unit will not interfere with the normal activity of the driver.
- Before finally installing the unit, connect the wiring temporarily and make sure it is all connected up properly. Test to see if the system is working properly.
- Use only the parts included with the unit to ensure proper installation. The use of unauthorized parts can cause malfunctions.
- Consult with your nearest dealer if installation requires the drilling of holes or other modifications of the vehicle.
- Install the unit where it does not get in the driver's way and cannot injure the passenger if there is a sudden stop.
- If installation angle exceeds 30° from horizontal, the unit might not give its optimum performance.

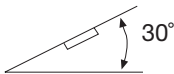

- Avoid installing the unit where it would be subject to high temperature, such as direct sunlight, hot air from the heater, or where it would be subject to dust, dirt or excessive vibration.

DIN FRONT/REAR-MOUNT

This unit can be properly installed either from "Front" (conventional DIN Front-mount) or "Rear" (DIN Rear-mount installation, utilizing threaded screw holes at the sides of the unit chassis). For details, refer to the following illustrated installation methods.

TAKE OUT SCREW BEFORE INSTALLATION

Before install the unit, please remove the two screws.

Take out screw before installation

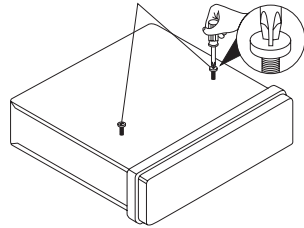

DIN FRONT-MOUNT (Method A) Installation Opening

This unit can be installed in any dashboard having an opening as show below:

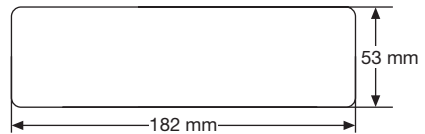

Installing the unit

Be sure you test all connections first, and then follow these steps to install the unit.

1. Make sure the ignition is turned off, and then disconnect the cable from the vehicle battery's negative (-) terminal.
2. Disconnect the wire harness and the antenna.
3. The two supplied keys release tabs inside the unit's sleeve so you can remove it. Insert the keys as far as they will go (with the notches facing up) into the appropriate slots at the middle left and right sides of the unit. Then slide the sleeve off the back of the unit.

INSTALLATION

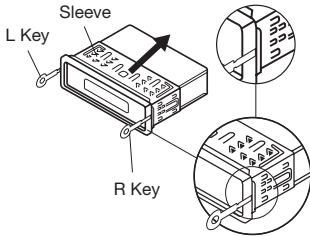

4. Mount the sleeve by inserting the sleeve into the opening of the dashboard and bend open the tabs located around the sleeve with a screwdriver. Not all tabs will be able to make contact, so examine which ones will be most effective. Bend open the appropriate tabs behind the dashboard to secure the sleeve in place.

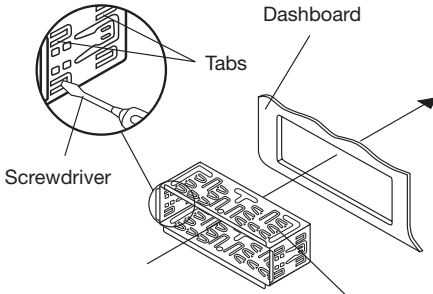

5. Reconnect the wire harness and the antenna and be careful not to pinch any wires or cables.
6. Slide the unit into the sleeve until it locks into place.
7. To further secure the unit, use the supplied metal strap to secure the back of the unit in place. Use the supplied hardware (Hex Nut (M5mm) and Spring Washer) to attach one end of the strap to the mounting bolt on the back of the unit. If necessary, bend the metal strap to fit your vehicle's mounting area. Then use the supplied hardware (Tapping Screw (5x25mm) and Plain Washer) to attach the other end of

metal strap to a solid metal part of the vehicle under the dashboard. This strap also helps ensure proper electrical grounding of the unit.

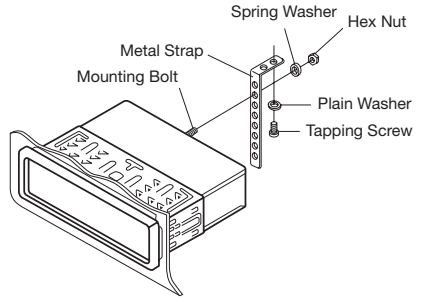

8. Reconnect the cable to the vehicle battery's negative (-) terminal.

Removing the unit

1. Make sure the ignition is turned off, then disconnect the cable from the vehicle battery's negative (-) terminal.
2. Remove the metal strap attached the back of the unit (if attached).
3. Insert the release frame key into the groove at the right side of the frame, then prize out to remove the frame. (You can also use the key to remove the frame from the left side.)

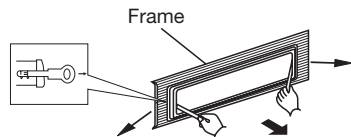

4. After releasing the frame, insert the release unit keys supplied with the accessory into the grooves at both sides of the unit as shown in figure until they click. Pulling the keys makes it possible to remove the unit from the dashboard.

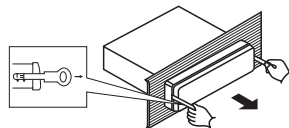

INSTALLATION

DIN REAR-MOUNT (Method B)

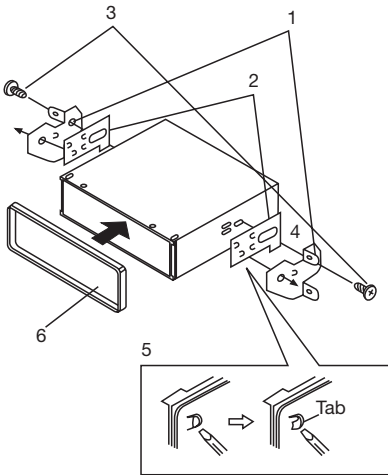

1. Factory-installed radio bracket
2. Car radio mounting bracket
3. Screw
4. After aligning the car radio mounting bracket with the factory-installed radio bracket, tighten the screws (M5x4mm) at 2 places on each side.
5. When fixing factory-installed radio bracket with the screws, use a standard-tipped screwdriver to pry the tabs of the car radio mounting bracket to make them fit into the holes in the factory-installed radio bracket.
6. Movable panel frame

USING THE FRONT PANEL

1. When the ignition key is switched to "ACC ON", the panel of the unit will change from State 1 to State 2 (see below), the hidden panel will turn up.

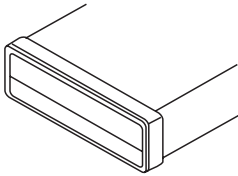

State 1

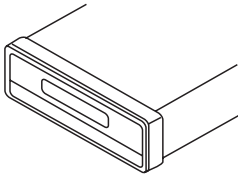

State 2

2. Press \odot (power) button to turn on the unit. Then press \triangle (eject) button, the panel will turn down to horizontal position (see State 3).

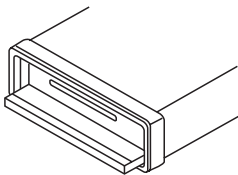

State 3

3. Insert a disc in the disc slot, the panel will automatically turn up to State 2. Press \triangle (eject) button again, the panel will turn down to eject the disc. If you don't insert a disc in again, the panel will automatically turn up after 10 seconds. If you don't want to wait, press \triangle (eject) button, the panel will also turn up.
4. When the ignition key is switched to "ACC OFF", and there is no portable audio player connected to the unit through the AUX IN jack, the front panel will change from State 2 to State 1.
If there is a portable audio player connected to the unit through the AUX IN jack, the front panel will remain State 2, when the key is switched to "ACC OFF".

WIRING CONNECTION

4 x 50W System

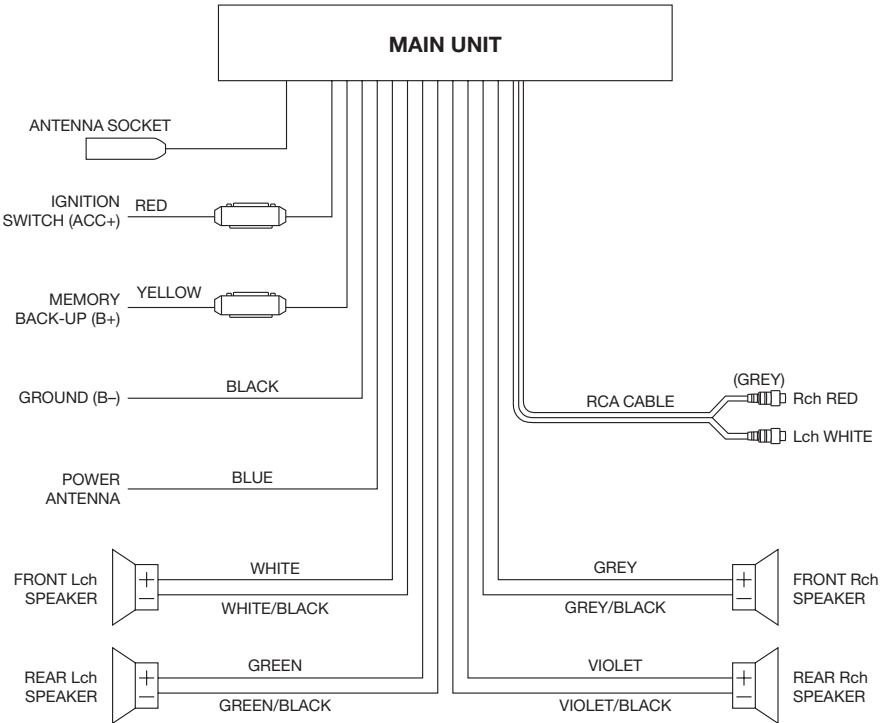

OPERATION

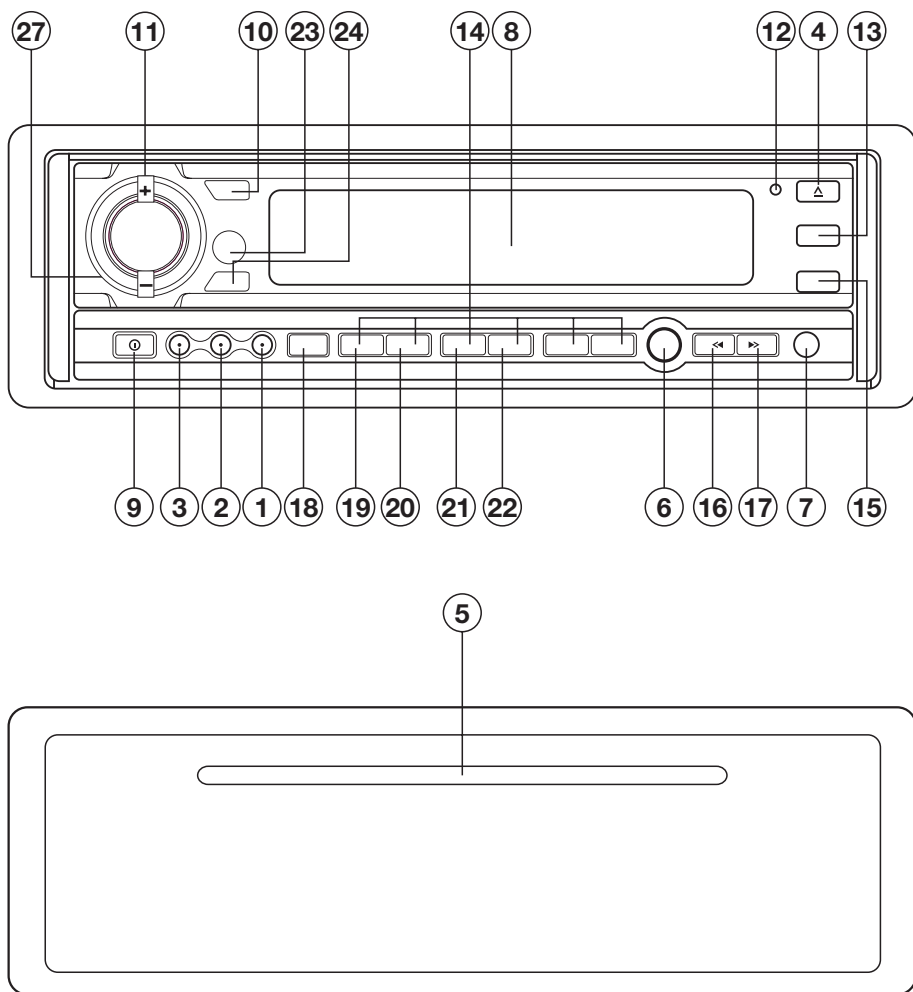

OPERATION

SWITCHING ON/OFF THE UNIT

When the hidden panel turns up (in State 2), switch the unit on by pressing any button (except Δ button (4)). When system is on, press \cup (9) to turn the unit off.

SOUND ADJUSTMENT

Press **SEL** button (10) to select the desired adjustment mode. The adjustment mode will change in the following order:

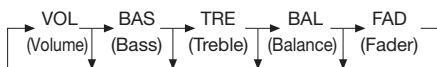

By pressing **VOLUME+** button (11) or **VOLUME-** button (27), it is possible to adjust the desired sound quality.

BEEP ADJUSTMENT

Press **SEL** button (10) and hold for more than 2 seconds until "BEEP" appears on display.

Press **VOLUME+** button (11) or **VOLUME-** button (27) as follows:

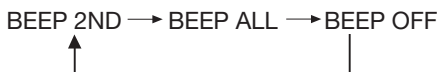

- BEEP 2ND mode:
The beep is only generated when all allowed double function button is pressed long (several seconds). e.g. When preset button is pressed. When **BND/LOU** button (13) is pressed. When **AMS** button (18) is pressed.
- BEEP ALL mode:
The beep is generated when every button is pressed.
- BEEP OFF mode:
The beep is disabled.

SET THE CLOCK

Press the **DSP** button (15), the clock is shown on the LCD display. Then hold down the button until the clock flashes. Then press the **MANU/SKIP** button (17) to change hours or **MANU/SKIP** button (16) to change minutes.

MUTE

Press **MUT** button (2) to mute down the sound instantly. If any button (except Δ button (4)) is pressed in the mute state, the mute mode is released.

EQUALIZATION

Press **EQ** button (24) to turn on equalization function and to select desired audio mode. There are five kinds of mode as below:



LIQUID CRYSTAL DISPLAY

Exhibit current frequency and activated functions on the display (8).

AUXILIARY INPUT

The unit can be connected to a portable audio player through the **AUX IN** jack (7). Note : The face plate will not close when something is plugged in the **AUX** in jack.

REMOTE SENSOR

Point the remote control handset to the remote sensor IR (23). Press the function keys on the handset to control the system.

RESET FUNCTION

RESET button (12) can be activated with either a ballpoint pen or thin metal object. The **RESET** button is to be activated for the following reasons:

- Initial installation of the unit when all wiring is completed.
- All the function buttons do not operate.
- Error symbol on the display.

OPERATION

RADIO OPERATION

• SWITCHING TO RADIO MODE

Press MOD button (6) shortly to select radio mode, the radio mode appears in the display together with the memory band and frequency.

• SELECTING THE FREQUENCY BAND

At radio mode, press BND/LOUD button (13) shortly to select the desired band.

The reception band will change in the following order:

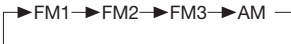

• STATION SELECTION

Press **MANU/SKIP** $\rightarrow\rightarrow$ button(17) or **MANU/SKIP** $\leftarrow\leftarrow$ -button(16) shortly to activate automatic seek function.

Press for several seconds until “**MANUAL**” appears on the display, the manual tuning mode is selected. If both buttons are not pressed for several seconds, they will return to seek tuning mode and “**AUTO**” appears on the display.

• LOCAL/DISTANT

Press **LOC** button (3) to select between local and distant stations. Local setting for reception of strong station, and a distant setting for reception of weaker stations. This function is in effect during AUTO SEEK operation.

• AUTOMATIC MEMORY STORING & PROGRAM SCANNING

- Automatic Memory Storing
Press **AMS** button (18) for several seconds, the radio searches from the current frequency and checks the signal strength until one cycle search is finished. The six strongest stations will be stored into the corresponding preset number button.
- Program Scanning
Press **AMS** button (18) shortly to scan preset station stored in memory.

• STATION STORING

Press any one of the preset buttons (14) (M1 to M6) to select a station which had been stored in the memory. Press this button for several seconds (until 2'nd beeps come out) to store current station in that preset button.

• MONO/STEREO

Press **MON** button (1) to select mono or stereo mode. You can sometimes improve reception of distant stations by selection mono operation.

CD OPERATION

• SWITCHING TO CD MODE

If there is no CD inserted in the player :
When the front panel is in State 2 and the unit is on, press **EJECT** button (4), the panel will change into State 3 and display the disc slot (5). Gently insert the CD with the printed side on top into the CD compartment until you feel some resistance. The CD is drawn into the player automatically and the panel will automatically turn up. CD playback begins.

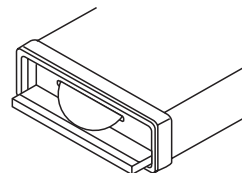

OPERATION

If a CD is already inserted in the player:
Keep pressing **MOD** button (**6**) shortly until the CD mode display appears.

• SELECTING TRACKS

Press **MANU/SKIP<<** -button (**16**) or **MANU/SKIP>>** button(**17**) to move to the previous track or the following track. Track number shows on display. Hold **MANU/SKIP<<** -button (**16**) or **MANU/SKIP>>** button (**17**) to fast reverse or fast forward. CD play starts when you release the button.

• PAUSING PLAYING

Press **PAU** button (**19**) to pause CD player. Press it again to resume play.

• PREVIEWING ALL TRACKS

Press **SCN** button (**20**) to play first several seconds of each track on the current disc. Press it again to stop intro and listen to track.

• REPEATING THE SAME TRACK

Press **RPT** button(**21**) to continuously repeat the same track. Press it again to stop repeat.

• PLAYING ALL TRACKS IN RANDOM

Press **SHF** button (**22**) to play all tracks on CD in random order. Press again to cancel the function.

• EJECTING A DISC

When the front panel is in State 2 and there is a disc in the disc slot, Press **△** button (**4**), the panel will turn down and eject the disc from the disc slot (**5**).

Note : When you first play a CD and when whichever track is playing,press M5 button or M6 button,the unit will search the disc again and start to play the first track.Later,there is no function of pressing M5 button or M6 button.

DISC NOTES

A. Notes on discs:

- Attempting to use non-standard shape discs (e.g. square, start, heart) may damage the unit. Be sure to use round shape CD discs only for this unit.
- Do not stick paper or tape etc., onto the label side or the recording side of any discs, as it may cause a malfunction.
- Dirt, dust, scratches and warping discs will cause misoperation.

B. Notes on CD-Rs (recordable CDs)/CD-RWs (rewritable CDs):

- Be sure to use discs with following marks only for the unit to play:



- The unit cannot play a CD-R and CD-RW that is not finalized. (Please refer to the manual of your CD-R/CD-RW recorder or CD-R/CD-RW software for more information on finalization process).
- Depending on the recording status, conditions of the disc and the equipment used for the recording, some CD-Rs/CD-RWs may not be played on this unit. (See *)
- * To have more reliable play back, please see following recommendations:
 - a. Use CD-RWs with speed 1x to 4x and write with speed 1x to 2x.
 - b. Use CD-Rs with speed 1x to 8x and write with speed 1x to 2x.
 - c. Do not play a CD-RW which has been written for more than 5 times.

SPECIFICATION

GENERAL

Power Supply Requirements	: DC 12 Volts, Negative Ground
Chassis Dimensions	: 178 (W) x 165 (D) x 50 (H)
Tone Controls	
- Bass (at 100 Hz)	: ± 10 dB
- Treble (at 10 KHz)	: ± 10 dB
Maximum Output Power	: 4 x 50 Watts
Current Drain	: 15 Ampere (max.)

CD PLAYER

Signal to Noise Ratio	: More than 55 dB
Channel Separation	: More than 45 dB
Frequency Response	: 40 Hz - 18 KHz

RADIO

	: FM
Frequency Coverage	: 87.5 to 107.9
IF	: 10.7 MHz
Sensitivity (S/N=30dB)	: 4 μ V
Stereo Separation	: >25dB

	: AM
Frequency Coverage	: 530 to 1710 kHz
IF	: 450 kHz
Sensitivity (S/N=20dB)	: 36 dBu

TROUBLE SHOOTING

Before going through the check list, check wiring connection. If any of the problems persist after check list has been made, consult your nearest service dealer.

Symptom	Cause	Solution
No power.	The car ignition switch is not on.	If the power supply is properly connected to the car accessory circuits, but the engine is not moving, switch the ignition key to "ACC".
	The fuse is blown.	Replace the fuse.
Disc cannot be loaded or ejected.	Presence of CD disc inside the player.	Remove the disc in the player, then put a new one.
	Inserting the disc in reverse direction.	Insert the compact disc with the label facing upward.
	Compact disc is extremely dirty or defective disc.	Clean the disc or try to play a new one.
	Temperature inside the car is too high.	Cool off or until the ambient temperature return to normal.
	Condensation.	Leave the player off for an hour or so, then try again.
No sound.	Volume is in minimum.	Adjust volume to a desired level.
	Wiring is not properly connected.	Check wiring connection.
Sound skips.	The installation angle is more than 30 degrees.	Adjust the installation angle less than 30 degrees.
	The disc is extremely dirty or defective disc.	Clean the compact disc, then try to play a new one.
The operation keys do not work.	The built-in microcomputer is not operating properly due to noise.	Press the RESET button. Front panel is not properly fixed into its place.
The radio does not work. The radio station automatic selection does not work.	The antenna cable is not connected.	Insert the antenna cable firmly.
	The signals are too weak.	Select a station manually.

SANYO MOBILE AUDIO MODEL ECD-T1550 LIMITED WARRANTY

OBLIGATIONS

In order to obtain warranty service, the product must be delivered to and picked up from an Authorized Sanyo Factory Service Center at the user's expense, unless specifically stated otherwise in this warranty. The names and addresses of Authorized Sanyo Service Centers may be obtained by calling the toll-free number listed below.

For product operation, authorized service center referral, service assistance or problem resolution, call
CUSTOMER INFORMATION 1-800-421-6382
Weekdays 8:00 AM - 5:00 PM Pacific Time

THIS WARRANTY IS VALID ONLY ON SANYO PRODUCTS PURCHASED AND USED IN THE UNITED STATES OF AMERICA.

THIS WARRANTY APPLIES ONLY TO THE ORIGINAL RETAIL USER, AND DOES NOT APPLY TO PRODUCTS USED FOR ANY INDUSTRIAL, PROFESSIONAL OR COMMERCIAL PURPOSE. THE ORIGINAL DATED BILL OF SALE OR SALES SLIP MUST BE SUBMITTED TO THE AUTHORIZED SANYO SERVICE CENTER AT THE TIME WARRANTY SERVICE IS REQUESTED. Subject to the OBLIGATIONS above and EXCLUSIONS below, SANYO FISHER COMPANY (SFC) warrants this SANYO product against defects in materials and workmanship for the periods specified below. SFC will repair or replace (at its option) the product and any of its parts which fail to conform to this warranty with new or reconditioned products or parts. The warranty period commences on the date the product was first purchased at retail.

LABOR	PARTS
1 YEAR	1 YEAR

EXCLUSIONS

This warranty does not cover (A) the adjustment of customer-operated controls as explained in the appropriate model's instruction manual, or (B) the repair of any product whose serial number has been altered, defaced or removed.

This warranty does not apply to the cabinet or cosmetic parts, knobs or routine maintenance. This warranty does not apply to the elimination of car static or motor noise, correction of antenna problems, or damage to compact discs, speakers, accessories or vehicle electrical systems. This warranty does not apply to repairs or replacements necessitated by any cause beyond the control of SFC including, but not limited to, any malfunction, defect or failure caused by or resulting from unauthorized service or parts, improper maintenance, operation contrary to furnished instructions, shipping or transit accidents, modification or repair by the user, abuse, misuse, neglect, accident, incorrect power line voltage, fire, flood or other Acts of God, or normal wear and tear. The foregoing is in lieu of all other express warranties and SFC does not assume or authorize any party to assume for it any other obligation or liability.

THE DURATION OF ANY WARRANTIES WHICH MAY BE IMPLIED BY LAW (INCLUDING THE WARRANTIES OF MERCHANTABILITY AND FITNESS) IS LIMITED TO THE TERM OF THIS WARRANTY IN NO EVENT SHALL SFC BE LIABLE FOR SPECIAL, INCIDENTAL OR CONSEQUENTIAL DAMAGES ARISING FROM OWNERSHIP OR USE OF THIS PRODUCT, OR FOR ANY DELAY IN THE PERFORMANCE OF ITS OBLIGATIONS UNDER THIS WARRANTY DUE TO CAUSES BEYOND ITS CONTROL.

SOME STATES DO NOT ALLOW LIMITATIONS ON HOW LONG AN IMPLIED WARRANTY LASTS AND/OR DO NOT ALLOW THE EXCLUSION OR LIMITATION OF CONSEQUENTIAL DAMAGES, SO THE ABOVE LIMITATIONS AND EXCLUSIONS MAY NOT APPLY TO YOU.

THIS WARRANTY GIVES YOU SPECIFIC LEGAL RIGHTS. YOU MAY HAVE OTHER RIGHTS, WHICH VARY FROM STATE TO STATE.

For your protection in the event of theft or loss of this product, please fill in the information below for your own personal records.

Model No. _____ Serial No. _____
Located on back or bottom side of unit)

Date of Purchase _____ Purchase Price _____

Where Purchased _____



21605 Plummer Street
Chatsworth, CA91311

ECD-T1443. Issue Number 1.

Free Manuals Download Website

<http://myh66.com>

<http://usermanuals.us>

<http://www.somanuals.com>

<http://www.4manuals.cc>

<http://www.manual-lib.com>

<http://www.404manual.com>

<http://www.luxmanual.com>

<http://aubethermostatmanual.com>

Golf course search by state

<http://golfingnear.com>

Email search by domain

<http://emailbydomain.com>

Auto manuals search

<http://auto.somanuals.com>

TV manuals search

<http://tv.somanuals.com>