

SANYO

INSTRUCTION MANUAL

VPC-C1EX VPC-C1

Digital Movie

Xacti

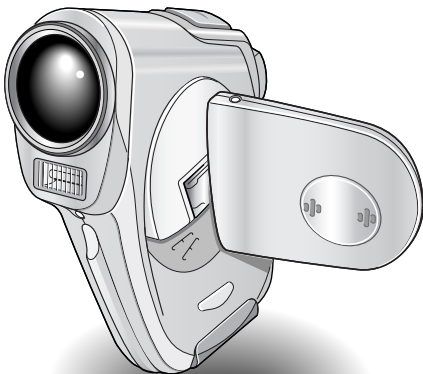

Important note

This manual explains how to safely operate the VPC-C1EX and VPC-C1. Any information regarding only one of these products will be labeled as such.

Please read these instructions carefully before using the camera. Make sure to read and understand the section "USING YOUR CAMERA SAFELY AND CORRECTLY" on pages 7 to 24. Keep this manual in a safe place for later reference.

Download from www.Softmanuals.com. All Manuals Search And Download.

Warning

TO PREVENT THE RISK OF FIRE OR ELECTRIC SHOCK, DO NOT EXPOSE THIS APPLIANCE TO RAIN OR MOISTURE

FOR AMERICAN USERS

- This equipment has been tested and found to comply with the limits for a Class B digital device, pursuant to Part 15 of the FCC Rules. These limits are designed to provide reasonable protection against harmful interference in a residential installation. This equipment generates, uses and can radiate radio frequency energy and, if not installed and used in accordance with the instructions, may cause harmful interference to radio communications. However, there is no guarantee that interference will not occur in a particular installation. If this equipment does cause harmful interference to radio or television reception, which can be determined by turning the equipment off and on, the user is encouraged to try to correct the interference by one or more of the following measures:
 - Reorient or relocate the receiving antenna.
 - Increase the separation between the equipment and receiver.
 - Connect the equipment into an outlet on a circuit different from that to which the receiver is connected.
 - Consult the dealer or an experienced radio/TV technician for help.
- Changes or modifications not expressly approved by the party responsible for compliance could void the user's authority to operate the equipment.

FC Tested to Comply with FCC Standards
FOR HOME OR OFFICE USE

The FCC logo is included in the rating that can be found inside the battery case.

Declaration of Conformity

Model number : VPC-C1
Trade Name : SANYO
Responsible party: SANYO FISHER COMPANY
Address : 21605 Plummer Street, Chatsworth, California 91311
Telephone No. : (818) 998-7322

This device complies with Part 15 of the FCC Rules. Operation is subject to the following two conditions:

- (1) this device may not cause harmful interference, and
- (2) this device must accept any interference received, including interference that may cause undesired operation.

FOR CANADIAN USERS

- This Class B digital apparatus complies with Canadian ICES-003.

Conformity to EC Directives

- This unit complies with EC Directives 89/336/EEC and 73/23/EEC.
- The rating plate can be found inside the set after the battery cover and battery are removed.



OUTLINE OF OPERATION

To help you get started enjoying using your camera right away, given below is an outline of the fundamental operation, from setup to shooting to playback.

SETUP

- (1) Connect the AC adapter/charger (page 128).
- (2) Install the battery pack and SD Memory Card*¹ in the camera (page 35, 36).

CAUTION

- This camera uses an SD Memory Card instead of photographic film to record images. Be sure to install the SD Memory Card before operating the camera. A 128MB SD Memory Card is supplied with this camera.
- Be sure to format the SD Memory Card with this camera before using it. A card that is not formatted using the camera may limit your full use of all the camera's capabilities.

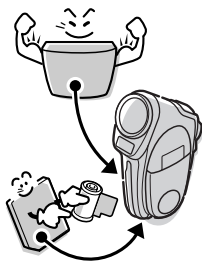

SHOOTING

- (1) Turn on the camera (page 37).
- (2) Take photos in the BASIC operation mode*².
 - In the BASIC mode, it's easy to take great photos right away.
 - To switch the menu mode, see page 42.
 - For shooting video clips, see page 47.
 - For shooting still photos, see page 48.



PLAYBACK

- (1) View your photos in the BASIC operation mode (page 64).
Playback as well is easy in the BASIC mode.

*1: About the SD Memory Card
In this manual, the SD Memory Card is referred to as "card".

*2: Shooting in the BASIC mode
For recording and viewing images, your camera has two modes to choose from. In the BASIC mode, only the basic camera functions are used. In the EXPERT mode, you have full access to all the camera's functions.

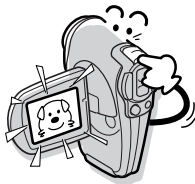

Symbols used in this manual

- HINT** Points that may prove useful when using the camera.
- NOTE** Points giving some extended instructions or special points to pay attention to.
- CAUTION** Points that require special attention.
- (page xx)** Refer to the page indicated for detailed information.

You may find the answers to questions or problems concerning camera operation in the sections "COMMONLY ASKED QUESTIONS" (page 149) and "TROUBLESHOOTING" (page 157).

CONTENTS

OUTLINE OF OPERATION	1
USING YOUR CAMERA SAFELY AND CORRECTLY	7
CHECKING THE INCLUDED ACCESSORIES	25
GETTING THE MOST OUT OF YOUR CAMERA.	27

■ PREPARATION

PARTS NAMES	31
CHARGING THE BATTERY PACK	34
INSTALLING THE BATTERY PACK AND CARD	35
TURNING THE POWER ON AND OFF.	37
OPERATION BUTTONS	40
SWITCHING THE MENU MODE	42
BEFORE TAKING PICTURES.	44

BASIC MODE

■ SHOOTING

CAPTURING IMAGES	47
ABOUT THE BASIC MODE SHOOTING SETTING SCREEN ..	52
CHANGING THE SHOOTING SETTINGS	55
OTHER SHOOTING FUNCTIONS	58

■ PLAYBACK

VIEWING IMAGES	64
ABOUT THE BASIC MODE PLAYBACK SETTING SCREEN ..	68
OTHER PLAYBACK FUNCTIONS	70

EXPERT MODE

■ SHOOTING

ABOUT THE EXPERT MODE SHOOTING SETTING SCREEN	78
VIDEO IMAGE QUALITY	81
FOCUS	82
FLICKER-REDUCTION FUNCTION	83
ISO SENSITIVITY	84
WHITE BALANCE SETTING	85
EXPOSURE CORRECTION	86

■ PLAYBACK

ABOUT THE EXPERT MODE PLAYBACK SETTING SCREEN.	87
ROTATE IMAGE	89
EDITING VIDEO CLIPS	90
PRINT SETTINGS (STILL IMAGES ONLY)	98

OPTION SETTINGS

■ CAMERA SETTINGS

ABOUT THE OPTION SETTING SCREEN	105
GUIDANCE FUNCTIONS	107
OPERATIONAL SOUNDS SETTING	108
USB FUNCTION SETTING	110
FILE NO. RESET FUNCTION	111
DATE AND TIME SETTING	114
SCREEN LANGUAGE	117
TV SYSTEM SETTING	118
POWER SAVE SETTING	119
RESETTING THE CAMERA SETTINGS	121
FORMATTING A CARD	122
CHECKING THE REMAINING CARD MEMORY	124
CHECKING THE REMAINING BATTERY PACK CHARGE. . .	126

■ OTHER DEVICES AND CONNECTIONS

DOCKING STATION	128
CABLE ADAPTER	138
CONNECTING TO A PRINTER	139

■ APPENDICES

COMMONLY ASKED QUESTIONS	149
TROUBLESHOOTING	157
SPECIFICATIONS	163

USING YOUR CAMERA SAFELY AND CORRECTLY

CAMERA WARNING

- **If the camera makes a strange noise, emits a strange odor, or if smoke comes out from it, immediately turn off the power and remove the battery pack.**
- If the camera is used under these conditions, it may cause a fire or electric shock. Immediately turn off the digital camera, remove the battery pack, and wait to make sure no more smoke comes from the camera. Then take it to the dealer for service. Do not try to repair or open the camera yourself.
- **Do not modify or open the cabinet**
- High voltage circuits are inside, and there is a high risk of fire or electric shock if they are touched. Any internal check, setting, or repair should be performed by the dealer.
- **Do not use while driving**
- Do not capture images, play back images, or watch the LCD monitor while driving a vehicle. Doing so may cause an accident.
- Be careful where you put down the camera inside an automobile. During sudden stops or turns it may fall behind the brake pedal and prevent braking.
- **Be aware of your surroundings when using the camera**
- Pay close attention to your surroundings when using the camera. Failure to do so may lead to an accident or injury.
- When using the camera while walking, be very careful of your surroundings and especially the traffic to avoid accidents.
- Do not use the camera inside an airplane or elsewhere where its use may be restricted.



WARNING

■ Do not get the camera wet

- This camera is not water-resistant. Do not allow it to get wet, as doing so may cause a fire or electric shock.
- Do not use the camera in a bathroom.
- If the camera gets wet, immediately turn it off and remove the battery pack. Then take it to a dealer for repair. Using the camera after it has become wet may cause a fire, electric shock, or other accident.



■ Do not use during a storm

- To avoid the risk of being struck by lightning, do not use the camera during a thunderstorm. In particular, if used in an open field, you have an increased chance of being struck by lightning. Quickly seek refuge in a place that will protect you from lightning.



■ Do not place on an unstable surface

- The camera may fall, resulting in damage to the camera or injury.
- If the camera has fallen and its body is damaged, turn it off, remove the battery pack, and take it to the dealer for repair. Using the camera after its body has been damaged may cause a fire or electric shock.



■ Do not look through the camera into the sun

- Do not look through the camera at the sun or any other strong source of light. Doing so may seriously injure your eyes.

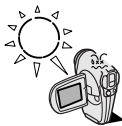

■ Do not use the flash close to a person's face

- To prevent possible eye injury, do not use the flash near a person's face (especially young children or babies). If the flash is used close to a person's opened eyes, there is a risk that it may damage that person's eyesight.



USING YOUR CAMERA SAFELY AND CORRECTLY

WARNING

■ Do not use where there is risk of explosion

- Do not use the camera in a location where there is explosive gas, or any other flammable material in the air. Doing so may cause a fire or an explosion.



■ Keep the camera out of the reach of children

- The following may happen if children play with the camera:
 - They may wrap the strap around their neck and suffocate.
 - They may swallow the battery pack or other small parts. In such a case, consult a physician immediately.
 - They may damage their eyesight if the flash goes off too close to their eyes.
 - They may get hurt by the camera.



CAUTION

■ Cautions when carrying the camera

- Do not walk around holding the camera by the handstrap. It may hit other objects and get damaged. When walking around, hold the camera in your hand or place it in a pocket.
- Be careful not to drop the camera or subject it to strong shocks.
- Make sure direct sunlight does not hit the camera lens, as that may damage the internal parts. When not using the camera, be sure to always turn it off and close the lens cover.



■ If the camera is not going to be used for a long period of time

- For safety's sake, remove the battery pack from the camera. This will prevent any possible excess heat or leakage of battery fluid that may result in injuries or damage to nearby objects. (Note that when the battery pack is removed for a long period, the time and date settings will be cleared.)



CAUTION

■ Cautions during use and storage

- This camera is a precision instrument. When using or storing the camera, make sure to avoid the following locations to avoid damage.
 - Places in direct sunlight
 - Places where humidity and temperature are high
 - Places that may get wet
 - Places close to an air conditioner or heater
 - Inside a car
 - Places where there is dust and dirt
 - Places where there is a fire burning
 - Places where volatile products are stored
 - Places subject to vibration



Operating environment:

- | | |
|---------------|--|
| • Temperature | 0°C to 40°C (operation)
-20 to 60°C (storage) |
| • Humidity | 30 to 90% (operation, no condensation)
10 to 90% (storage, no condensation) |

USING YOUR CAMERA SAFELY AND CORRECTLY

DOCKING STATION AND AC ADAPTER/ CHARGER DANGER

■ Do not recharge battery packs that are not Li-ion battery packs (Model DB-L20)

- Do not recharge a battery pack other than the supplied Li-ion battery pack (DB-L20). Recharging a dry-cell battery or other type of rechargeable battery may cause excess heat, combustion, or leakage, and cause a fire, injuries, burns, or damage to nearby objects.



■ Use a 100 to 240 V AC power supply

- If used with a power supply other than the one specified, it may cause a fire or electric shock. The power cord is rated for 125 V AC. Therefore, if you plan to use the docking station and/or the AC adapter/charger in a region with a different voltage, it may be necessary to replace the power cord with one that can be used in that location. For details, please see page 168.



■ Do not disassemble or modify

- It is dangerous to touch the inside. Doing so may cause a fire or electric shock.
- Do not use as a direct current generator.



■ Do not get the docking station or AC adapter/ charger wet

- Make sure they do not get wet, as doing so may cause a fire or electric shock.
- Do not use the camera in a bathroom.
- If the docking station or AC adapter/charger gets wet, immediately unplug it from the power outlet and remove the battery pack. Then contact the place of purchase. If used while wet, it may cause a fire, electric shock, or an accident.



DANGER

■ Cautions when plugging in

- Securely plug the power cord all the way into the power outlet. If the docking station or AC adapter/charger is used with the power cord not fully plugged in, heat may be generated and cause a fire.
- Do not use if the power cord is damaged or cannot be correctly plugged into the power outlet. Using in this condition may cause a fire or electric shock.
- Do not allow dust, etc., to build up on the power cord or power outlet. A build-up of dust may cause a short circuit or generate heat and cause a fire.
- When unplugging the power cord, be sure to hold the plug part and slowly pull it out of the power outlet. Pulling the cord portion may damage the power cord and cause a fire or electric shock.



■ Do not pull on the power cord to unplug it

- Do not leave the power cord plugged into the power outlet while the other end is not plugged into the docking station or AC adapter/charger. The loose end can cause electrocution if touched with wet hands or if handled by children.
- Use only the supplied power cord. If a different power cord is used, it may be rated for a different current load, and that may cause a fire.
- The supplied power cord is for exclusive use with the devices supplied with your camera. Do not use it with other devices, as doing so may cause a fire or electric shock.
- Do not use a bundled power cord, as the heat generated may cause a fire.
- When using an extension cord, make sure that the total wattage of the connected devices does not exceed the rated value of the extension cord. If the power load exceeds the rated value, it may cause a fire.



DANGER

■ Keep out of the reach of children

- Children may place the battery pack or other small components in their mouth or perform some other such unforeseeable action. If swallowed, consult a physician immediately.



■ If smoke or a strange odor is emitted, or if strange noises are heard, immediately unplug the power cord from the power outlet

- If used under these conditions, it may cause a fire or electric shock.
- If strange conditions such as these occur, immediately unplug the device, remove the battery pack, and wait to make sure no more smoke is emitted. Then contact the place of purchase. Do not try to repair or open the device yourself.



■ Do not handle with wet hands

- Handling the docking station or AC adapter/charger with wet hands may cause an electric shock.

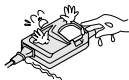

■ Do not use during a storm

- Do not touch the docking station, AC adapter/charger or power cord while it is plugged into a power outlet during a thunderstorm. Doing so may cause an electric shock.



CAUTION

■ Do not damage the power cord

- Do not place heavy objects on the power cord. Do not place the power cord near a heat source. Do not excessively bend the power cord, modify it, or secure it with staples. Doing so may damage the power cord and cause a fire or electric shock.
- If the power cord is damaged, or if it does not plug properly into the docking station, AC adapter/charger or wall outlet, contact the place of purchase.



■ Do not place on an unstable surface

- The camera may fall, resulting in damage to the camera or injury.
- If it falls and the body is damaged, remove the battery pack and contact the place of purchase. If used while damaged, it may cause a fire, electric shock, or other damage.



■ Operating and storage conditions

- Do not use close to a heat source (close to a stove or heater) or leave it exposed to direct sunlight.

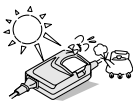

Operating environment:

- | | |
|---------------|---|
| • Temperature | 0 to 40°C (charging)
-20 to 60°C (storage) |
| • Humidity | 20 to 80%
(charging and storage) |

LI-ION BATTERY PACK (DB-L20)

DANGER

This camera uses a Li-ion battery pack (Model DB-L20).

- **If there is leaking, discoloration, change of shape, rise in temperature, damaged exterior, strange odor or any other abnormal condition, immediately discontinue use and remove the battery pack from the camera, taking care to keep it well away from fire.**



- Continued use of the battery pack under any of these conditions may result in fire, injury, explosion or other serious damage.
- If battery fluid is leaking, placing the battery pack in close proximity to a fire or other heat source may ignite the battery fluid and result in fire, damage, eruption of battery fluid, or smoke fumes.

- **Do not transform, take apart, or modify.**

- Safety mechanisms and protective devices have been in incorporation in the battery pack for the purpose of preventing danger. Any modification, by transforming, disassembling, or directly soldering to it, etc., will defeat these safety devices and possibly cause the battery pack to catch fire, explode, or leak or spew battery fluid.



- **Do not connect the (+) and (-) terminals with a wire or other metal implement. Do not carry loose or keep with necklaces, hairpins, etc.**

- Doing so may result in a short circuit, high voltage flow, fire, explosion, leaking or spewing battery fluid, or heat generation. Metal such as a wire or necklace, etc. may cause heat to be generated.



- **Do not throw the battery pack in the fire or subject it to heat**

- Doing so may cause the insulation to melt, damage the gas discharge valve and safety mechanisms, or ignite the battery fluid, resulting in fire or explosion.



DANGER

■ Do not drop, hit, or submit the battery pack to strong shocks

- If the safety mechanisms and protective devices are broken, an abnormal chemical reaction may occur inside the battery pack, or cause the battery pack to catch fire, explode, leak or spew battery fluid, or generate heat.



■ Do not allow the battery pack to come into contact with fresh or salt water, or allow the terminals to become wet.

- If the safety mechanisms and protective devices are damaged by corrosion, an abnormal chemical reaction may occur inside the battery pack, or cause the battery pack to catch fire, explode, leak or spew battery fluid, or generate heat.



■ Operating and storage conditions

- Temperature when using or recharging: 0 to 40°C
- Do not use, recharge, store or leave the battery pack near fire or inside a car exposed to the hot sun, etc. (locations in which the temperature reaches 60°C or higher).
- At high temperatures, the safety mechanisms and protective devices inside the battery pack may be damaged by corrosion, causing an abnormal chemical reaction to occur, or cause the battery pack to catch fire, explode, leak or spew battery fluid, or generate heat. If the safety mechanisms and protective devices are damaged, the battery pack will become unusable. An environment with extremely high or low temperatures will cause the battery capacity to deteriorate and shorten the usable time, and may even shorten the battery life.
- Avoid storing the battery pack with it near full charge. It is recommended to store the battery pack when it is near fully discharged.
- If the battery pack is completely discharged, it may become unable to be recharged again. To avoid this, charge the battery pack for at least five minutes every six months.
- Storage temperature: -10°C to 30°C
When not using the battery pack, remove it from the camera and store at 0°C to 30°C in a place with no condensation.
- Humidity: 10% to 90% (no condensation)

DANGER

■ Use only the supplied docking station and AC adapter/charger

- If another charger is used, the battery pack may be overcharged, or recharged with an abnormal voltage, causing an abnormal chemical reaction to occur, or cause the battery pack to catch fire, explode, leak or spew battery fluid, or generate heat.

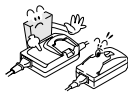

■ Use the battery pack only in the specified device

- If the battery pack is used in a device other than that specified, it may cause an abnormal voltage flow, or cause the battery pack to catch fire, explode, leak or spew battery fluid, or generate heat.



■ Do not peel or damage the outer case

- Damaging the outer case, inserting nails, hitting with a hammer, stepping on the battery pack, etc. may cause a short circuit inside the battery pack or cause the battery pack to catch fire, explode, leak or spew battery fluid, or generate heat.



■ If the battery pack is leaking and the electrolyte gets on your skin or clothing, immediately rinse with clean water

- If the electrolyte gets into your eyes, you risk losing your eyesight. Immediately rinse your eyes with clean, running water, and seek medical attention right away. Any electrolyte that comes into contact with your skin or clothing may harm your skin. Immediately rinse the area with clean, running water.



■ Insert the battery pack correctly, as specified

- When installing the battery pack in the charger or camera, pay attention to the indicated polarity (+ and -), and insert it correctly.
- If the battery pack is installed with the wrong orientation, it may cause an abnormal chemical reaction while in the charger, an abnormal voltage flow when it is used, or cause the battery pack to catch fire, explode, leak or spew battery fluid, or generate heat.



WARNING

■ Always stop the recharging after the prescribed recharge time, even if the battery pack is not fully charged

- If you continue to recharge the battery pack, it may cause the battery pack to catch fire, explode, leak or spew battery fluid, or generate heat.



■ Keep out of the reach of children

- They may handle the battery pack in an unforeseeable manner that results in damage.



CAUTION

■ Charge the battery pack before using it

- Always recharge the battery pack before using it for the first time, or when using it after it has been kept in storage for a long time. During recharging, the battery pack may be warm. This is normal and does not indicate a malfunction.



■ Note concerning the battery pack after use

- The battery pack may be warm immediately after the camera is used. If removing the battery pack, turn off the camera and allow the battery pack to cool down before removing it.



■ Recycling the battery pack

- To conserve the environment and for efficient use of natural resources, please discharge the used battery pack, cover the (+) and (-) terminals with tape and recycle the insulated battery pack.
- If disposing of the battery pack as unburnable trash, please follow all applicable regulations of your area.



Concerning the accessories

WARNING

■ Cautions concerning the use of the AC adapter/charger

- Use only the supplied docking station and AC adapter/charger with your camera. Do not use a docking station or AC adapter/charger other than the ones indicated here, designed for specific use with your camera.
- If a docking station or AC adapter/charger other than the ones specified is used, it may damage the camera and cause a fire or electric shock.

■ Cautions concerning the card

- Immediately after use, the card will be very hot. Before removing the card, turn off the camera and wait for the temperature to cool down.
- Keep out of the reach of children. Young children may put the media in their mouth and choke or cause some other unexpected injury or accident.

CONCERNING THE LITHIUM BATTERY (CR2025)

WARNING

■ Cautions concerning the CR2025 battery

- A CR2025 lithium battery is used for the remote control. Do not use a battery other than the CR2025 lithium battery.
- Install the battery with the (+) and (-) terminals correctly oriented as indicated. If the battery is placed in the wrong orientation, it may cause a fire, overheating, or rupturing.
- Do not recharge, short circuit, disassemble, modify, heat, or place the battery in a fire. Doing so may cause a fire, overheating, or rupturing.
- Do not hold the battery with metal tweezers or a similar tool. Doing so may cause a short circuit leading to a fire, overheating, or rupturing.
- Do not perform soldering on the battery or use, store, or leave it near a fire, under direct sunlight, in a hot car, or other high temperature location.
- Do not use the battery if it is leaking.
- If the electrolyte gets into your eyes, you risk losing your eyesight. Do not rub your eyes, wash them immediately with clean water, and seek medical attention right away. If electrolyte gets on your skin or clothing, it may cause irritation. Immediately wash with clean water.
- Keep the battery out of the reach of children. If the battery is accidentally swallowed, contact a physician immediately. It may cause poisoning or suffocation.
- When disposing of batteries, make sure to follow all applicable regulations.
- When disposing of the lithium battery, place tape on its positive (+) and negative (-) terminals to prevent shorting. Do not mix the lithium battery with other batteries. Doing so may cause a fire or rupturing.

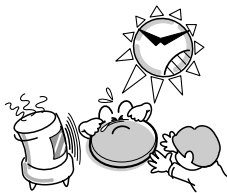

FOR CORRECT USE OF YOUR CAMERA

■ Cautions before capturing important images

- Before capturing important images, make sure that the camera is operating properly and in condition to capture the image properly.
- Sanyo Electric shall not be held responsible for any losses that result from images that could not be recorded, are erased, destroyed, or damaged in any way due to a problem with the camera, any of its accessories, or its software.

■ Caution concerning copyrights

- The images you capture with your camera are for your own private use; any other use may violate the rights of copyrights owners.

■ Cautions when cleaning the camera

Cleaning procedure

- ❶ Turn off the camera and remove the battery pack.
- ❷ Remove the dirt with a soft cloth.

If the camera is extremely dirty,

- ❸ Wipe with a soft cloth moistened with a mild detergent diluted with water and wrung dry.

Caution

- Do not use benzene or thinner products to clean the camera. Doing so may cause deformation, discoloration, or paint peeling. When using a chemically treated cloth, carefully read its instructions and warnings.
- Do not spray insecticides or volatile sprays on the camera. Do not let rubber or vinyl objects contact the camera for a long period. They may cause deformation, discoloration, or paint peeling.

■ **Caution concerning the battery pack**

- Periodically clean with a dry cloth the terminals (contacts) of the batteries. Do not touch the battery terminals with your bare hands. Doing so will allow contaminants from your hands to adhere to the terminals and oxidize, increasing the contact resistance. If the contact resistance increases, the usable life of the batteries will diminish.

■ **Caution when cleaning the lens**

- If the lens gets dirty, use a commercially available air blower or a cleaning cloth for photographic equipment to clean it.

■ **When not using the camera for a long period**

- Remove the battery pack. However, when the battery pack is removed for a long time, the camera functions may begin to not work properly. Periodically reinstall the battery pack and check the camera functions.
- If the battery pack is left in the camera, a small amount of power is still used even if the camera is turned off. If the battery pack is left in the camera for a long period, it may become completely discharged and lose its ability to be recharged again.

■ **Cautions concerning condensation**

- Using the camera with condensation inside it may damage the camera.

If condensation seems likely to form

- Place the camera in a plastic bag and seal it, and then wait until the camera has reached the ambient temperature.

Be careful of condensation under the following conditions

- When moving the camera suddenly from a cold place to a warm place.
- When the ambient temperature changes drastically, such as when a heater is turned on to quickly heat the room.
- When the camera is placed in the path of cool air from an air conditioner.
- When the camera is placed in a location of high humidity.

FOR CORRECT USE OF YOUR CAMER (continued)

■ Caution concerning undesired interference

- The camera may create undesired interference if used close to a television or radio. To avoid this type of interference, make sure the cores on the supplied cables are not removed.

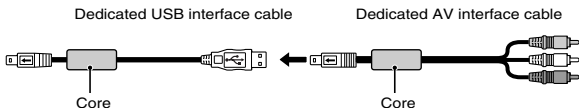

■ Caution concerning magnetism

- Do not place credit cards, bank cards, floppy disks, or other items that may be damaged by magnetic fields near the speaker. Data may be lost or the magnetic strips on cards may be damaged.



■ Cautions concerning data storage

- It is recommended that any important data be copied onto a separate media (such as a hard disk, MO disk, or CD-R disk).
- Stored data may be lost (or corrupted) in cases such as those listed below. Sanyo Electric will not be held responsible for any damage or lost profits arising from the loss of data.
 - If the card is used incorrectly.
 - If the card is not inserted correctly into the camera.
 - If the card is subjected to electrical or mechanical shocks or other forces.
 - If the card is removed from the camera or if the camera is turned off during reading or writing operations.
 - If the card has reached the end of its usable life.

■ Cautions when handling the cards

- The cards are precision devices. Do not bend, drop, or subject them to strong forces or shocks.
- Avoid using or storing the cards in places with extremely high or low temperatures, subject to direct sunlight, in a completely closed vehicle, near air conditioners or heaters, or in humid or dusty locations.
- Avoid using or storing the cards in locations where strong static electrical charges or electrical noise can be easily generated.
- Do not allow the edges of the cards to become contaminated with foreign materials. Gently wipe away any contamination with a soft, dry cloth.
- Do not carry the cards in trouser pockets, as the cards may become damaged when you sit down or make other movements that may apply forces.
- Before using a new card or a card that was used in other equipment, be sure to format it using the camera (see "FORMATTING A CARD" on page 122).
- When buying commercially available products, carefully read the instructions and warnings that come with the card.

■ Caution concerning high temperatures

- During shooting, when the internal temperature of the camera becomes high, the  icon will appear on the LCD monitor. When the  icon appears, it is still possible to capture and play back images for a while. However, if the temperature rises further, it will become impossible to record (although playback will still be possible). In this case, discontinue shooting as soon as possible, and wait until the temperature falls before using the camera again.
- Note that particularly when shooting video clips, soon after the  icon appears, the remaining shooting time indication will appear, and when that figure becomes 0, further shooting is impossible.

CHECKING THE INCLUDED ACCESSORIES

- Handstrap: 1

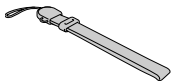

- Software: 2 CD-ROM

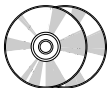

- Li-ion battery pack (battery pack): 1

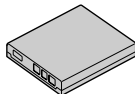

- Docking station: 1



- AV cable: 1

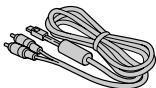

- USB interface cable: 1

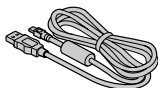

- Remote control unit: 1

A lithium battery (CR2025) is installed at the time of purchase.

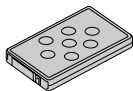

- Lens cap: 1

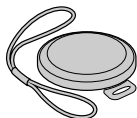

- Cable adapter: 1

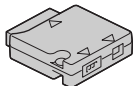

- AC adapter/charger and power cord: 1

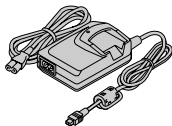

- Soft case: 1

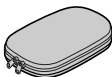

● **SD Memory Card (128MB): 1**

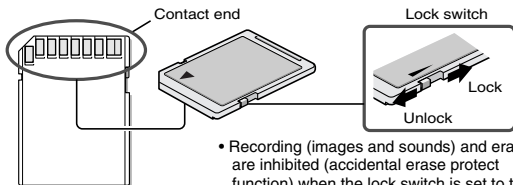

- Recording (images and sounds) and erasing are inhibited (accidental erase protect function) when the lock switch is set to the LOCK position.
- The card is normally used with the lock switch set to the unlocked position.

■ **Handstrap**

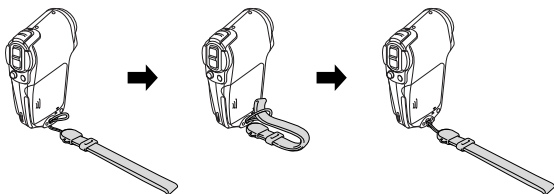

■ **Lens cap**

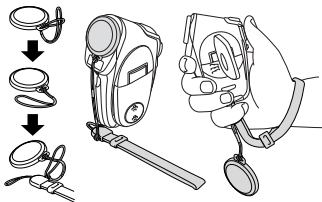

■ **Soft case**

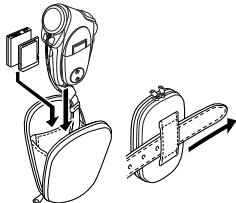

When not using the camera, keep it in the soft case for protection.

Media cards that can be used with this camera

The type of card that can be inserted into and used with this camera is:

- SD Memory Card

GETTING THE MOST OUT OF YOUR CAMERA

Your digital movie camera can not only record video clips, you can also take still photos and make audio recordings. For example, you can snap a still image while shooting a video clip, or make just an audio recording. In addition, by using the supplied docking station, it's easy to hook up your camera to a TV or computer.

Shooting video clips (page 47)

You expect your camera to record great quality still photos, but you can record 640x480-pixel video clips as well. The maximum 30-frames-per-second shooting speed guarantees beautiful, flowing movies for you to enjoy. Another bonus is the capability to record small file sizes that are perfect for uploading to Internet websites.

Capture still shots while recording a video clip (page 49)

Suppose that while you're recording a video clip, there's a scene you'd like to keep as a still photo. Your camera makes it possible to record the still photo without interrupting the video clip recording.

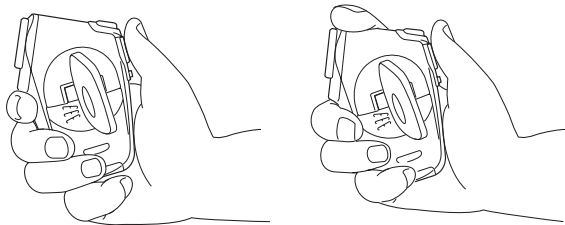

Twin menus for easy operation (page 42)

The novice photographer will have no problem taking beautiful pictures, thanks to the BASIC mode easy menu. All the settings necessary to capture the picture you want are easily and quickly set up. Of course, the EXPERT mode menu is available for the experienced photographer, providing full control over detailed camera settings.

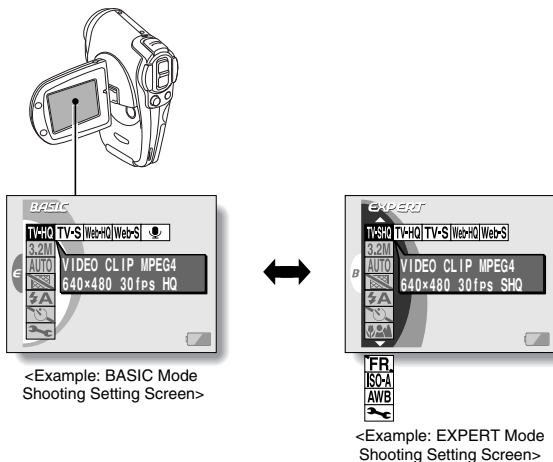

GETTING THE MOST OUT OF YOUR CAMERA

Movable monitor for any shooting angle

The movable LCD monitor lets you shoot from any angle. Hold the camera high to get a great view of a parade, or swivel the monitor around to snap a photo of yourself.

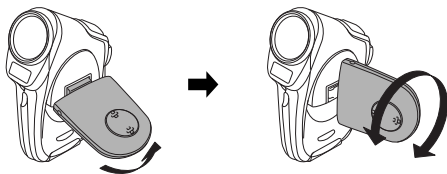

Docking station for easy connection

The docking station simplifies those complicated connections to your TV or computer. Just set the camera in the docking station, and you can view your photos on your TV or computer right away. The remote control unit makes it even more convenient.

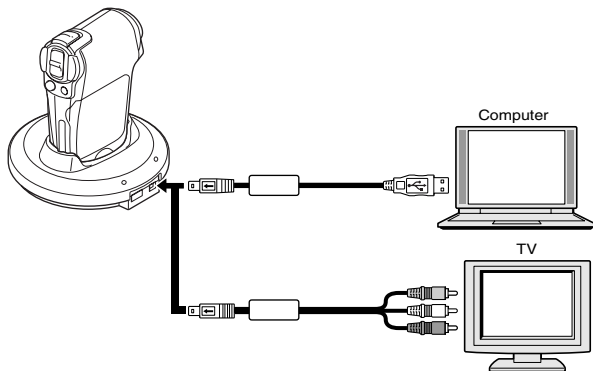

PARTS NAMES

Front

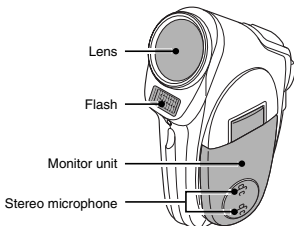

<To open the monitor unit>

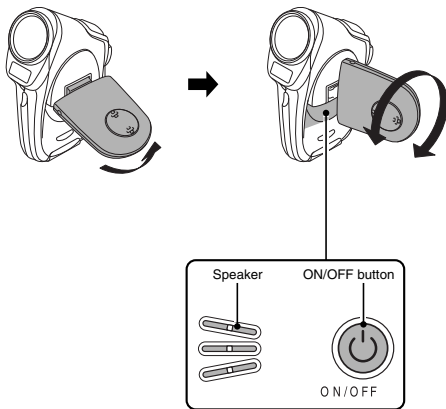

Rear

Multi-indicator

- **Lit**

- Green:** USB interface connection
(PC connection mode)

- Red:** USB interface connection
(PictBridge mode)
Charge the flash

- Orange:** AV cable connection

- **Flashing**

- Green:** Power save mode

- Red (long interval):** During self-timer
photography

- Red (short interval):** Accessing the card,
battery charge error

Still image shooting button

Main switch

Video clip recording button

Zoom switch

MENU button

Battery slot cover

Bottom

LCD monitor

SET button

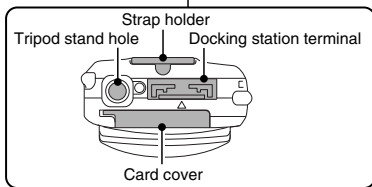

PARTS NAMES

Docking station

Front

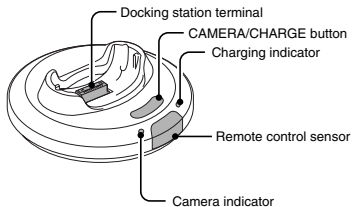

Rear

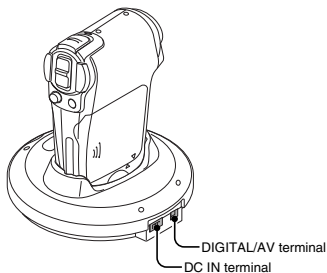

Cable adapter

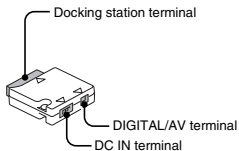

CHARGING THE BATTERY PACK

The battery pack is not charged at the time of purchase and therefore needs to be charged before use. In addition, if the battery charge becomes low while you are using the camera, it is recommended to recharge it as soon as possible.

1 Connect the AC adapter/charger to a power outlet.

- Use the supplied power cord for connecting.

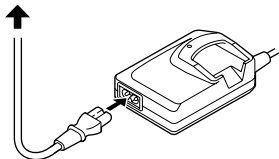

2 Insert the battery pack into the AC adapter/charger.

- Set it in the battery slot.
- Be sure the battery pack is correctly oriented when setting it in the charger.
- Charging begins. During charging, the charging indicator lights red.
- When the battery pack is completely charged, the charging indicator turns off.
- Charging will take approximately 90 minutes.

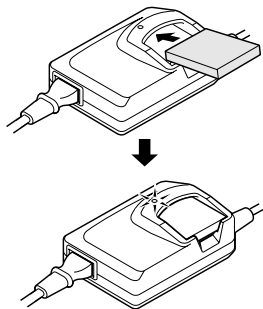

3 When the battery pack is fully charged, remove it from the AC adapter/charger.

- After removing the battery pack, unplug the power cord from the power outlet.

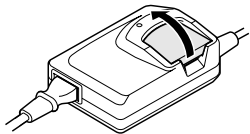

INSTALLING THE BATTERY PACK AND CARD

The card can be used after it has been formatted with the camera (page 122). Make sure that the battery pack polarity (+ and -) and the card orientation are correct.

Install the battery pack

1 Open the battery cover on the side.

- Open the battery cover by lightly pressing it and sliding it towards the rear.

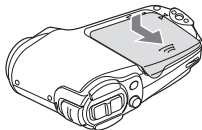

2 Insert the battery pack.

- Firmly push it all the way in.
- Match the [▲] mark on the battery with the [▲] mark on the camera.

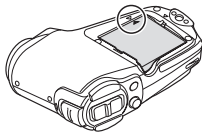
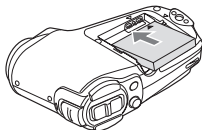

<To remove the battery pack>

- Raise the battery pack and pull it out.

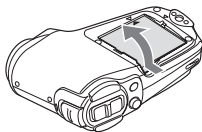

3 Close the battery cover.

- Match the [▲] marks, and slide the cover towards the front to close it.
- At the time of purchase the battery pack is not charged. Be sure to install a fully charged battery pack in the camera (page 34).

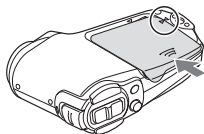

Install the card

1 Open the card cover on the bottom of the camera.

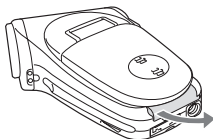

2 Insert the card.

- Firmly insert the card until it clicks into place.
- To remove the card, press it down, and then release. The card will protrude slightly, and you can then pull it out.

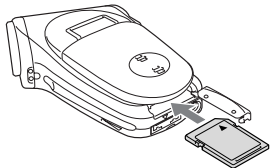

3 Close the card cover.

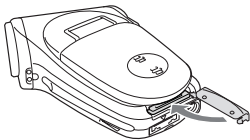

CAUTION

- Do not attempt to forcefully remove the card.

TURNING THE POWER ON AND OFF

Turning on the camera

1 Set the main switch.

To shoot pictures:

Set to [REC].

To play back images:

Set the [PLAY].

2 Open the monitor unit.

3 Press the ON/OFF button for about 1 second.

- The camera turns on, and an image appears on the LCD monitor.

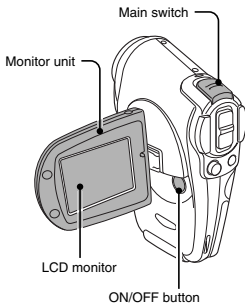

Turning on the camera when the power save (sleep) function is active

In order to preserve battery pack power, the power save (sleep) function will automatically turn off the camera after one minute of no use during shooting, or five minutes of no use during playback (factory-preset setting).

- When the power save function is active, you can restore the power by any of the following methods:
 - Move the main switch.
 - Press the ON/OFF button.
 - Press the MENU button.
 - Press the SET button.
- After the power save function has been active for about 1 hour, the camera will switch to the standby mode. In this case, you can restore the power by pressing the ON/OFF button, or by closing and then opening the monitor unit.
- When the AC adapter/charger is connected, the power save function will become active about 10 minutes after the camera is turned on (factory-preset setting).
- When the camera is connected to a computer or printer, it does not change to the power save mode. In this case, the power save function becomes active after about 12 hours.
- The user can specify the time elapsed before the power save function is activated (page 119).
- When the camera is connected to a computer or printer, it does not change to the power save mode. In this case, the power save function becomes active after about 12 hours.

TURNING THE POWER ON AND OFF

Turning off the camera

- 1 Press the ON/OFF button for about 1 second.

- The camera turns off.

HINT

To immediately activate the power save function

- Press the ON/OFF button briefly to activate the power save function.

About the standby mode

- To turn off the camera only briefly, you can close the monitor unit to put the camera in the standby mode. The standby mode uses almost no power. When the monitor unit is opened again, the camera turns on immediately and you are ready to shoot or view images without any delay.

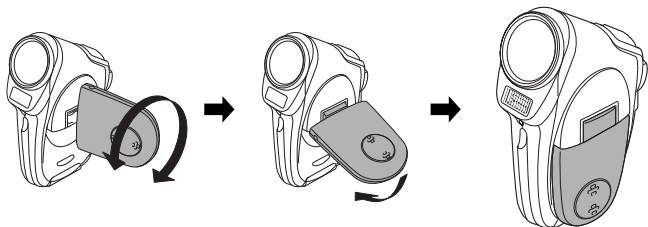

Note

If the icon appears...

- When a picture is taken, the date and time it was captured is recorded with it. When the date and time cannot be recorded with the image because the date and time have not yet been set (page 114), the  icon appears. To have the date and time recorded with images, please make this setting before capturing images.

OPERATION BUTTONS

The procedures to change the camera settings, choose images, etc., are performed by using the SET button to control the LCD monitor display. This operation is used very frequently, so it is best to become familiar with it right away.

1 Turn on the camera (page 37).

2 Press the MENU button.

- The Menu Screen appears.

<Select the icon above or below>

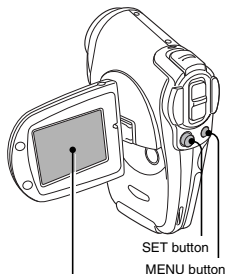

To select the icon above, toggle the SET button up.

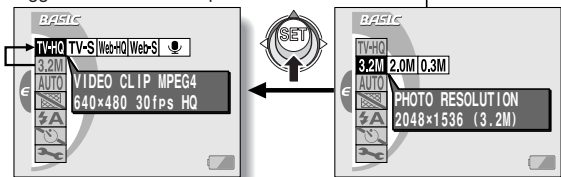

To select the icon below, toggle the SET button down.

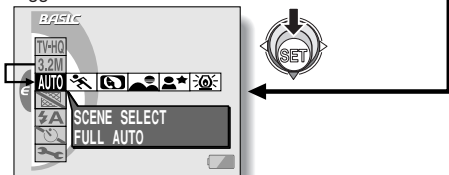

OPERATION BUTTONS

<Select the icon to the left or right>

To select the icon to the right, toggle the SET button to the right.

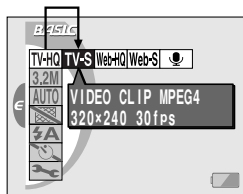

To select the icon to the left, toggle the SET button to the left.

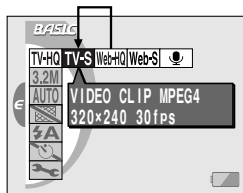

<Actuate the selected icon>

Press the SET button. The selected icon moves to the left end of the lineup.



SWITCHING THE MENU MODE

Switch from the BASIC mode menu to the EXPERT mode menu, or vice versa, depending on how you wish to use your camera.

1 Turn on the camera (page 37).

2 Press the MENU button.

- The Menu Screen (the Shooting Setting Screen or the Playback Setting Screen) appears.

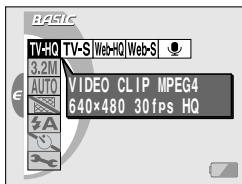

<Example: BASIC Mode Shooting Setting Screen>



<Example: BASIC Mode Playback Setting Screen>

SWITCHING THE MENU MODE

3 Toggle the SET button to the left.

- The screen to select the menu mode appears.

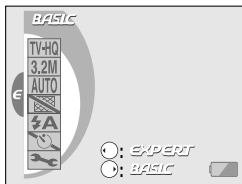

<Example: Shooting mode>

4 Toggle the SET button to the left again.

- The menu mode switches from one mode to the other.



<Example: EXPERT Mode Shooting Setting Screen>



<Example: EXPERT Mode Playback Setting Screen>

BEFORE TAKING PICTURES

For best results

Hold the camera securely, keeping your elbow close to your body and making sure the camera is stable.

Correct hold



Incorrect hold



A finger is blocking the lens or flash.

Make sure that the lens and flash are not blocked by your fingers or the handstrap.

HINT

- Images captured in the still image shooting mode can be rotated when they are played back (page 89). Note that video clips cannot be rotated while they are being played back.
- When the still image shooting button is pressed halfway, the image in the LCD monitor may waver vertically. This is the result of internal image processing and is not a malfunction. This wavering is not recorded and will not affect your images in any way.
- When the optical zoom is used or when the autofocus is operating, the image may appear to waver, but this is not a malfunction.

BEFORE TAKING PICTURES

Using the autofocus

The autofocus will work in almost all situations; however, there are certain conditions that may cause the autofocus function to not work properly. If the autofocus function is not working properly, set the focus range to capture images (page 82).

■ Conditions that may cause incorrect focus

The following examples are some of the situations where the autofocus function may not work.

- **Subjects with low contrast, very bright subjects at the center of the image or dark subjects or locations**

Use the focus-lock function to lock the focus on an object with contrast at the same distance as the desired subject.

- **Subjects without vertical lines**

Use the focus-lock function to lock the focus on the subject while holding the camera vertically.

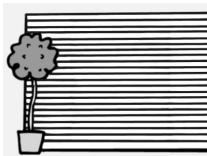

The following examples are some of the situations where the autofocus function may work, but not as desired.

- **When both near and far objects are present**

Use the focus-lock function to lock the focus on an object at the same distance as the desired subject, then reposition the camera to compose the picture.



- **Fast-moving subjects**

Use the focus-lock function to lock the focus on an object at the same distance as the desired subject, then reposition the camera to compose the picture.



Hints for taking pictures

Muting the operation sounds

- The operation sounds that are generated, for example, when the still image shooting button, MENU button or SET button is pressed, as well as the audio guidance when you switch the mode, can be muted (page 108).

Where is the image and audio data saved?

- All the image and sound data is recorded on the card installed in the camera.

Taking pictures in backlight conditions...



- When taking pictures with the light coming from behind the subject, due to the characteristics of the lens, light lines or ghost patterns (flare phenomenon) may appear in the captured image. In this situation, it is recommended that you avoid taking pictures with the subject lit from behind.

While the image data is being recorded...

- The multi-indicator will light red while the image is being written to the memory. Another image can be captured only after the red light turns off. However, even when the multi-indicator is lit red, depending on the camera's internal memory remaining capacity, in some cases the next image can be captured about 2 seconds after shooting.

CAPTURING IMAGES

Recording video clips

- 1 Turn on the camera (page 37).
- 2 Set the main switch to REC.
- 3 Press the video clip recording button [] to start recording.
 - Recording begins. During shooting,  appears in the LCD monitor.
 - It is not necessary to continue pressing the video clip recording button while shooting.
- 4 End the recording.
 - Press the video clip recording button again to stop recording.

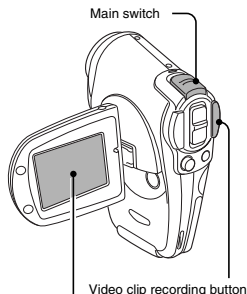

Note

Focus lock during video clip recording

- The autofocus can be set to a fixed focus during video clip recording if you toggle the SET button up. When the autofocus is fixed, the  icon appears on the LCD monitor.

Capturing still images

1 Turn on the camera (page 37).

2 Set the main switch to REC.

3 Press the still image shooting button [] to capture the image.

- ① Press the still image shooting button halfway.
 - The autofocus operates, and the image is focused (focus lock).

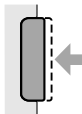

② Continue to gently press the still image shooting button all the way.

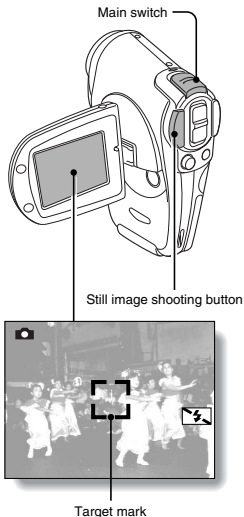
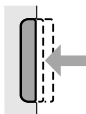

- The shutter releases and the image is captured.
- You can view the captured image on the LCD monitor by keeping the still image shooting button depressed when you capture the image.



CAPTURING IMAGES

Shoot a still image while recording a video clip

You can capture a still image while you are recording a video clip.

- 1** Turn on the camera (page 37).
- 2** Set the main switch to REC.
- 3** Press the video clip recording button [] to begin recording.
- 4** When you see a scene you'd like to capture as a still image, press the still image shooting button [].
- 5** End the recording.
 - Press the video clip recording button to stop recording.

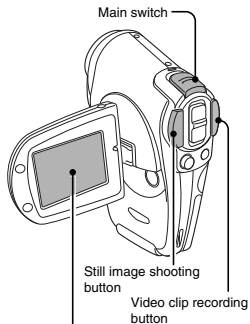

Note

About the target mark

- The target mark indicates the position which is currently focused. If the target mark does not appear, or if it appears at a position that is different from the point you wish to focus, you can refocus, for example, by changing the shooting angle.
- The large target mark appears when the camera focuses on a wide area in the center of the screen.

HINT

Shoot a still image while recording a video clip

- If you press the still image shooting button while recording a video clip, the frame is also saved as a still image. Note, however, that in this case the flash will not operate.
- If the still image resolution is set to a setting other than **0.3M**, and you press the still image shooting button while recording a video clip, the displayed image stops briefly and then returns to video clip recording after the still image is captured.

Note

- The data for a video clip is very large. Therefore, be aware that if the video clip is uploaded to a computer to be played back, the computer may not be able to play back the video fast enough, making it appear jerky. (The video will always be displayed properly on the LCD monitor or a television.)
- Depending on the card, shooting may end even before the possible shooting time indicated on page 167.

CAPTURING IMAGES

AUDIO RECORDING

You can make audio recordings with your camera.

1 Select the audio recording icon  from the recording mode menu, and press the SET button.

- The camera changes to the audio recording mode.

2 Press the video clip recording button .

- Recording begins.
- To end the recording, press the video clip recording button again.

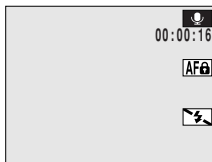

<Screen during audio recording>

ABOUT THE BASIC MODE SHOOTING SETTING SCREEN

For shooting in the BASIC mode, you can change the video clip image quality and still image resolution settings, as well as modify the shooting settings for various functions. These settings are performed on the BASIC Mode Shooting Setting Screen.

Display the BASIC Mode Shooting Setting Screen

1 Turn on the camera (page 37).

2 Set the main switch to REC.

3 Press the MENU button.

- The Menu Screen appears.

4 Set the camera to the BASIC mode (page 42)

- The BASIC Mode Shooting Setting Screen appears.
- To cancel the BASIC Mode Shooting Setting Screen, press the MENU button.

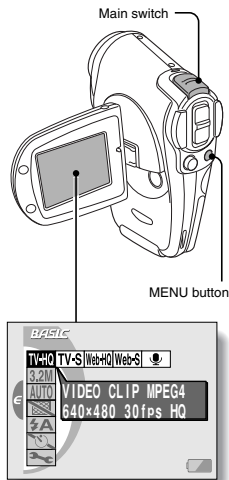

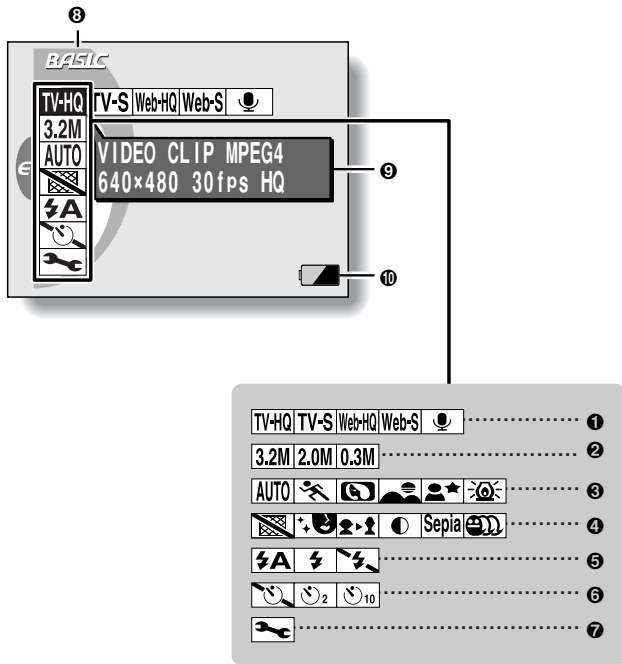

ABOUT THE BASIC MODE SHOOTING SETTING SCREEN

BASIC Mode Shooting Setting Screen





1 Video clip menu (page 55)

: Record at 640 x 480 pixels, 30 frames per second

: 320 x 240 pixels, 30 frames per second

: 320 x 240 pixels, 15 frames per second

: 176 x 144 pixels, 15 frames per second

: Make an audio recording

2 Photo resolution menu (page 56)

: 2048 x 1536-pixel resolution icon (3,200,000 pixels)

: 1600 x 1200-pixel resolution icon (2,000,000 pixels)

: 640 x 480-pixel resolution icon (300,000 pixels)

3 Scene select menu (page 58)

: Full auto icon

: Sports icon

: Portrait icon

: Landscape icon

: Night view icon

: Lamp icon

4 Filter menu (page 59)

: No filter

: Cosmetic filter on

: Slim filter on

: Monochrome filter on

: Sepia filter on

: Ghost filter on

5 Flash menu (page 60)

: Automatic flash mode

: Forced flash mode

: Flash off mode

6 Self-timer menu (page 62)

: Self-timer off

: Self-timer on (2 seconds)

: Self-timer on (10 seconds)

7 Option icon (page 105)

Displays the Option Setting Screen.

8 Menu mode display (page 42)

9 Help display (page 107)

10 Remaining battery power (page 126)

- When you specify multiple functions that cannot be simultaneously enabled, the function which was last set becomes the active setting, and the other settings accordingly change automatically.

CHANGING THE SHOOTING SETTINGS

In the BASIC mode, you can change the monitor brightness, the video clip image quality and the still image resolution settings.

Video clip image quality setting

When it comes to video clips, a larger number of pixels and a higher the frame rate means better image quality and smoother playback. On the other hand, the file size becomes large and uses more memory. Set the image quality to a setting that's right for your purpose, whether for home viewing on a TV or for showing on the Internet, for example.

-
- 1** Display the BASIC Mode Shooting Setting Screen (page 52), and select the video clip menu.

 : Record at 640 x 480 pixels, 30 frames per second

 : Record at 320 x 240 pixels, 30 frames per second

 : Record at 320 x 240 pixels, 15 frames per second

 : Record at 176 x 144 pixels, 15 frames per second

 : Make an audio recording

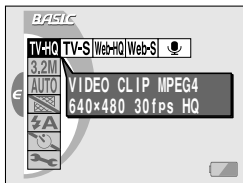

-
- 2** Select the desired icon from the video clip menu, and press the SET button.

- This completes the video clip image quality setting.

Still image resolution setting

By setting the still image resolution (pixels) to a higher setting, image detail is enhanced for a smoother, finer picture. However, the file size also becomes large and uses more memory. Select the resolution setting that suits your purpose.

1 Display the BASIC Mode Shooting Setting Screen (page 52), and select the photo resolution menu.

3.2M : 2048 x 1536-pixel resolution

(3.2M)

2.0M : 1600 x 1200-pixel resolution

(2M)

0.3M : 640 x 480-pixel resolution

(0.3M)

The numbers in parentheses () refer to the approximate number of pixels in the image (units: megapixels).

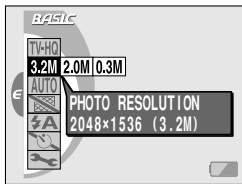

2 Select the desired icon from the photo resolution menu, and press the SET button.

- This completes the still image resolution setting.

CHANGING THE SHOOTING SETTINGS

Adjusting the brightness of the LCD monitor (when shooting)

The brightness of the LCD monitor during shooting can be adjusted. Adjust the brightness when it is difficult to see the LCD monitor image due to ambient lighting. In addition, in very bright surroundings, such as outdoors on a sunny day, you can turn the backlight OFF to preserve battery power.

1 With the Shooting Setting Screen not shown, toggle the SET button down for at least 1 second.

- The Monitor Brightness Screen appears.
- You can also access the Monitor Brightness Screen from the Shooting Screen by pressing and holding the SET button downwards.

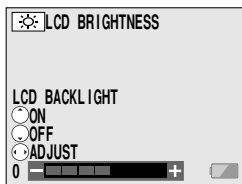

2 Toggle the SET button to the left or right to adjust the brightness, and press the SET button.







- This completes the LCD monitor brightness setting, and you are returned to the Shooting Screen.

OTHER SHOOTING FUNCTIONS

Scene Select feature

You can select from various preset settings (aperture, shutter speed, etc.) for specific shooting conditions.

1 Display the BASIC Mode Shooting Setting Screen (page 52), and select the scene select menu.

-  : The camera makes settings suitable for the surrounding conditions.
-  : Capture a split-second image of a fast-moving subject.
-  : Enhance the 3D feeling of the subject by blurring the background.
-  : For beautiful shots of distant scenery.
-  : Photograph the subject while keeping the background night scenery.
-  : Increase the sensitivity when taking pictures.

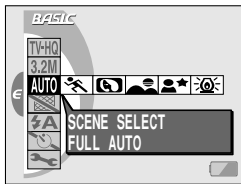

2 Select the desired icon from the scene select menu, and press the SET button.

- This completes the scene select function setting.

3 Take the picture.



For video clip recording, see page 47.

For still image shooting, see page 48.

To return to normal photography, select  from the scene select menu, and press the SET button.

OTHER SHOOTING FUNCTIONS







Note

- When capturing images using the lamp  or night view  setting, use a tripod or other method to stabilize the camera.

Filter feature

The filter feature changes the aperture and shutter speed settings, as well as the color tones, to apply unique effects to the photographed image.

-
- 1 Display the BASIC Mode Shooting Screen (page 52), and select the filter menu.

-  : No filter
-  : Skin tones are enhanced in close-up shots (cosmetic filter).
-  : Change the vertical-horizontal proportions of the subject (slim filter).
-  : Snap black-and-white photos (monochrome filter).
-  : Create a sepia-tone photo (sepia filter).
-  : A radiant effect is added to the subject (ghost filter).

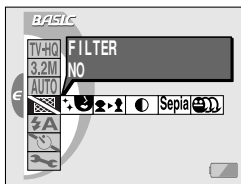

-
- 2 Select the desired icon from the filter menu, and press the SET button.

- This completes the filter setting.

-
- 3 Take the picture.

For video clip recording, see page 47.

For still image shooting, see page 48.

- To return to normal photography, select  from the filter menu, and press the SET button.

Using the flash

The flash is used not only for taking pictures where there is insufficient light, but also when the subject is in shade or in backlight conditions. Your camera has three modes of operation (automatic flash mode, forced flash mode, and flash off mode). The flash is available only when shooting still images.

1 Display the BASIC Mode Shooting Setting Screen (page 52), and select the flash menu.

- : The camera will detect the subject brightness and use the flash only when required. In a backlight situation, if only the center of the image is very dark, the flash will operate to compensate (auto flash).
- : The flash will operate with every image captured regardless of the conditions. Use this setting under backlight conditions, when the subject is in shade, under fluorescent lighting conditions, etc. (forced flash).
- : The flash will not operate even in dark situations. Use this setting when capturing an image in a location where flash photography is prohibited, or when shooting a night landscape scene (flash off).

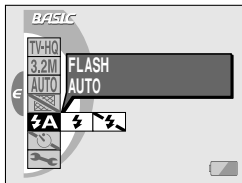

2 Select the desired icon from the flash menu, and press the SET button.

- This completes the flash setting.

OTHER SHOOTING FUNCTIONS

3 Take the picture.

For video clip recording, see page 47.

For still image shooting, see page 48.

- To return to normal photography, select  from the flash menu, and press the SET button.

Using the zoom

Your camera has two zoom functions: **optical zoom and digital zoom.**

1 Point the camera lens at the subject.

2 Press [T] or [W] on the zoom switch to compose the desired image.

[T]: Zoom in on the subject.

[W]: Zoom out.

- When the zoom switch is pressed, the zoom bar appears on the LCD monitor.
- When the optical zoom factor is at maximum, zooming stops temporarily. When [T] on the zoom switch is pressed again, the mode changes to the digital zoom mode and zooming continues (if digital zooming is enabled).

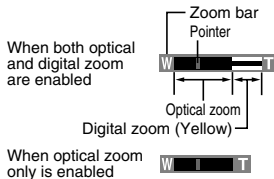
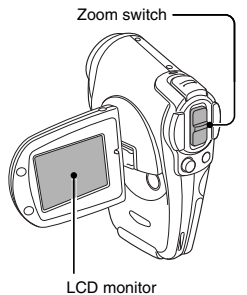



3 Take the picture.

For video clip recording, see page 47.

For still image shooting, see page 48.

Self-timer photography

- 1 Display the BASIC Mode Shooting Setting Screen (page 52), and select the self-timer menu.**

-  : Turns off the self-timer function.
-  : Turns on the self-timer function. The image is captured about 2 seconds after the video clip recording button or still image shooting button is pressed.
-  : Turns on the self-timer function. The image is captured about 10 seconds after the video clip recording button or still image shooting button is pressed.

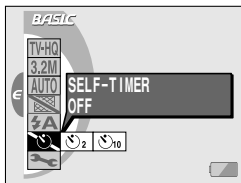

- 2 Select the desired icon from the self-timer menu, and press the SET button.**

This completes the self-timer setting.

- 3 Take the picture.**

For video clip recording, see page 47.
For still image shooting, see page 48.

OTHER SHOOTING FUNCTIONS

HINT

To pause or cancel the self-timer function...

- If the video clip recording button or still image shooting button is pressed again before the image is captured, the self-timer countdown temporarily stops. Press the video clip recording button or still image shooting button one more time to restart the self-timer.
- To cancel self-timer photography, select the  icon from the self-timer menu, and press the SET button.

When is selected...

- When the video clip recording button or still image shooting button is pressed, the illumination light and the multi-indicator will blink for about 10 seconds, and then the image is captured. Also, 4 seconds before the shutter releases, the indication below appears on the LCD monitor.
- If you swivel the monitor unit towards, the self-timer indication will be visible to the subject.

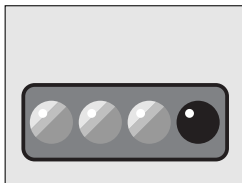

VIEWING IMAGES

1 Turn on the camera (page 37), and set the main switch to **PLAY**.

- If the main switch is set to **PLAY** after a video clip was recorded, the last recorded video clip is displayed.
- If the main switch is set to **PLAY** after a still image was captured, the last recorded still image is displayed.

2 Select the image you wish to view.

To display the previous image, toggle the SET button to the left.

To display the next image, toggle the SET button to the right.

3 Play back a video clip.

Follow these steps to play back a video clip.

Normal playback

- Press the SET button.

Pause

- While the video clip is playing, toggle the SET button up. To resume playback, press the SET button.

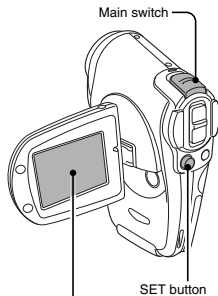

<Example: After video clip recording>



<Example: After still image shooting>

VIEWING IMAGES

To play back one image at a time (single-frame step)

- **During forward playback**

After pausing playback, toggle the SET button to the right.
For slow playback, press and hold the SET button to the right.

- **During reverse playback**

After pausing playback, toggle the SET button to the left.
For slow reverse playback, press and hold the SET button to the left.

To accelerate playback

- **15x fast forward playback**

During normal playback, toggle the SET button to the right.

- **30x fast forward playback**

During 15x playback, toggle the SET button to the right.

- During fast forward playback, the audio is not heard.
- If you toggle the SET button to the left, the images are played back in reverse (the audio is not played back).

- **Return to normal playback speed**

Press the SET button.

JOG playback

JOG playback lets you display the previous frame or next frame, as well as search for a particular frame during playback.

1 In the video clip playback stop or pause mode, toggle the SET button up.

- The JOG Playback Screen appears.

Fast forward:

Toggle the SET button to the right.

Rewind:

Toggle the SET button to the left.

Playback:

Press the SET button.

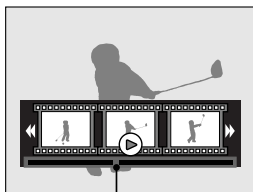

Position of currently displayed frame

2 Toggle the SET button down.

- You are returned to the Playback Screen.

Convenient 9-image display playback

1 Turn on the camera (page 37), and set the main switch to PLAY.

- If the main switch is set to PLAY after a video clip was recorded, the last recorded video clip is displayed.
- If the main switch is set to PLAY after a still image was captured, the last recorded still image is displayed.

2 Press [W] () on the zoom switch.

- The 9-image display appears.

3 Select the image to play back.

- Toggle the SET button up, down, left or right to move the orange frame to the desired image, and press the SET button. Instead of pressing the SET button, you can press [T] () on the zoom switch to show the image full screen.

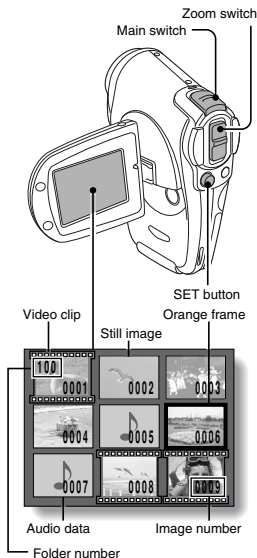

Note

- The 9-image multi-playback display can also be accessed by selecting  on the BASIC Mode Playback Setting Screen.

VIEWING IMAGES

Audio data playback

A  mark indicates an image for which audio data was also recorded.

Playback

Press the SET button.

Pause

During playback, toggle the SET button up.

Stop playback

During playback, toggle the SET button down.

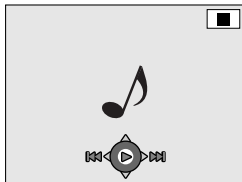

Magnifying (zooming in) the image

1 Display the image that you want to magnify.

- For a video clip, pause playback at the place you want to magnify.

2 Press [T] () on the zoom switch.

- Magnification is enabled.
- The image is magnified, and the central portion of image is displayed.
- Toggle the SET button to view different parts of the magnified image.

To magnify:

Press [T] () on the zoom switch.

To return to normal size:

Press [W] () on the zoom switch.

Magnification indication



HINT

The magnified portion of the image can be saved as a separate image.

- Press the still image shooting button. The magnified portion is saved as a new still image.

ABOUT THE BASIC MODE PLAYBACK SETTING SCREEN

The BASIC mode playback settings are performed on the BASIC Mode Playback Setting Screen.

Display the BASIC Mode Playback Setting Screen

- 1** Turn on the camera (page 37).
- 2** Set the main switch to **PLAY**.
- 3** Press the **MENU** button.
 - The Menu Screen appears.
- 4** Set the camera to the **BASIC** mode (page 42)
 - The BASIC Mode Playback Setting Screen appears.
 - To cancel the BASIC Mode Playback Setting Screen, press the **MENU** button.

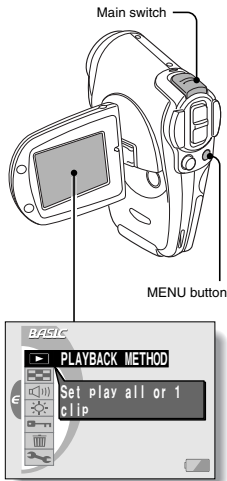

ABOUT THE BASIC MODE PLAYBACK SETTING SCREEN

BASIC Mode Playback Setting Screen



1 Playback method setting (page 70)

- Select continuous playback or single-frame playback.

2 Multi-playback (page 66)

- Display images in the 9-frame multi-display format.

3 Volume control (page 71)

- Adjust the playback volume for video clips and audio data.

4 Monitor brightness (page 72)

- Adjust the brightness of the LCD monitor backlight.

5 Data protect setting (page 73)

- Protect data from accidental erasure.

6 Erase (page 75)

- Delete images from the card memory.

7 Option icon (page 105)

- Displays the Option Setting Screen.

8 Menu mode display (page 42)

9 Help display (page 107)

10 Remaining battery power (page 126)

OTHER PLAYBACK FUNCTIONS

Playback mode

Images can be viewed continuously (slideshow playback) or you can choose to show single images.

1 Display the **BASIC Mode Playback Setting Screen** (page 68).

2 Select the playback method icon , and press the **SET** button.

- The Playback Mode Screen appears.

1 CLIP:

Display only the selected image.

PLAY ALL:

Play back images in slideshow fashion.

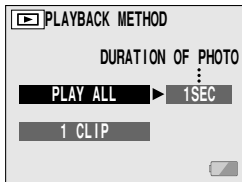

3 Select the desired playback mode, and press the **SET** button.

<PLAY ALL>

- The screen to set the time that each image is displayed appears.
- ❶ Toggle the **SET** button up or down to specify the time that each image is shown.
- ❷ Press the **SET** button.
- The display time is set, and you are returned to the BASIC Mode Playback Setting Screen.

<1 CLIP>

- The camera is set to display only the image you select, and you are returned to the BASIC Mode Playback Setting Screen.

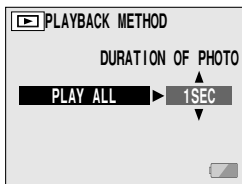

OTHER PLAYBACK FUNCTIONS

Volume control

Adjust the volume of video clip and audio data playback.

1 Display the **BASIC Mode Playback Setting Screen** (page 68).

2 Select the volume icon , and press the **SET** button.

- The volume control bar appears.

3 Toggle the **SET** button left or right to set to the desired volume, and press the **SET** button.

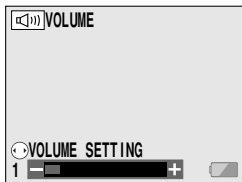

Monitor brightness (playback)

Adjust the brightness of the camera's LCD monitor display during playback. Use this adjustment when the monitor image is difficult to view because of ambient lighting.

In addition, in very bright surroundings, such as outdoors on a sunny day, you can turn the backlight OFF to preserve battery power.

-
- 1** Display the BASIC Mode Playback Setting Screen (page 68).

-
- 2** Select the LCD brightness icon , and press the SET button.
 - The brightness control bar appears.
 - You can also access the Monitor Brightness Screen from the Shooting Screen by pressing and holding the SET button downwards.

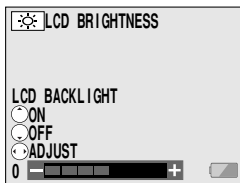

-
- 3** Toggle the SET button left or right to adjust the LCD monitor brightness, and press the SET button.
 - The brightness is set, and you are returned to the BASIC Mode Playback Setting Screen.

OTHER PLAYBACK FUNCTIONS

Image protect mode (prevent accidental erasure)

1 Display the data that you want to protect from accidental erasure, and display the BASIC Mode Playback Setting Screen (page 68).

2 Select the protect icon , and press the SET button.

- “LOCK?” appears.
- If the protect mode has already been enabled for the data, then “UNLOCK?” appears.

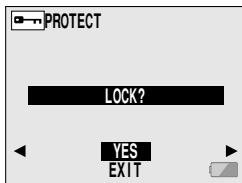

3 Toggle the SET button up or down to select “YES”, and press the SET button.

- The protect mode is set for the data.
- The protect mark  indicates that the data is locked.
- To return to the BASIC Mode Playback Setting Screen, press the MENU button.

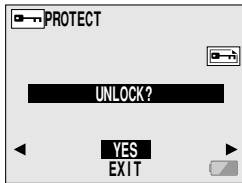

CAUTION

- Even if the protect mode is set for certain data files, they will be erased if the card is reformatted.

HINT

To select a different image in steps 2 and 3...

- Toggle the SET button to the left or right.

To cancel the protect mode for an image...

- Display the desired data and repeat steps 1 to 3. The protect mark  will disappear and the protect mode is canceled.

OTHER PLAYBACK FUNCTIONS

Erasing data

You can erase data that is stored on the card if you no longer need it. You can erase the data one at a time, or all at once.

-
- 1 Display the **BASIC Mode Playback Setting Screen** (page 68).

-
- 2 Select the erase icon , and press the **SET** button.

- The Erase Mode Screen appears.

ONE ERASE:

Erases one data at a time.

ERASE ALL:

Erases all the data from the card.

EXIT:

Returns to the BASIC Mode Playback Setting Screen.

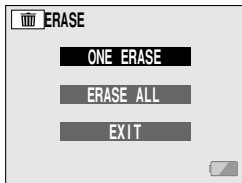

-
- 3 Toggle the **SET** button up or down to select the erase mode, and press the **SET** button.

- The Erase Confirmation Screen appears.

<ONE ERASE>

- Toggle the SET button to the left or right to select the data you wish to erase.

<ERASE ALL>

- Toggle the SET button to the left or right confirm the data to erase.

4 Toggle the SET button up or down to select “YES”, and press the SET button.

<ONE ERASE>

- The currently displayed image is deleted.
- To erase other data, select the data, and press the SET button.
- To return to the BASIC Mode Playback Setting Screen, press the MENU button.

<ERASE ALL>

- The Erase Confirmation Screen again appears. To erase the data, select “YES”, and press the SET button. When data erase is completed, “NO IMAGE” is shown.

CAUTION

- Data which is protected from accidental erase cannot be erased. To erase protected data, set the protect setting for the data to off (page 73), and then follow the data erase procedure.

OTHER PLAYBACK FUNCTIONS

Displaying image data (Information Screen)

On the Information Screen you can check what the settings were when an image was captured.

1 Display the desired image.

2 Press the MENU button for at about 2 seconds.

- The Playback Information Screen appears.
- If the MENU button is pressed again, the Playback Information Screen is exited.

- 1 Video clip mode settings
- 2 Remaining card memory
- 3 Image or sound number
- 4 Protect setting
- 5 File size
- 6 Shooting or recording time
- 7 Remaining battery charge
- 8 Date and time of image
- 9 Photo resolution setting

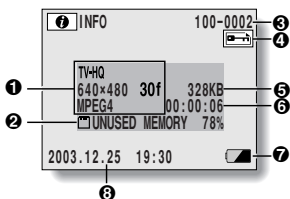

<Video clip playback mode>

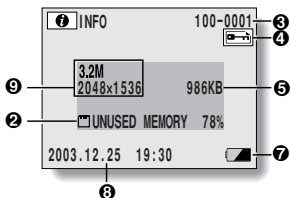

<Still image playback mode>

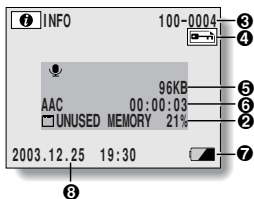

<Audio data playback mode>

ABOUT THE EXPERT MODE SHOOTING SETTING SCREEN

Compared to the BASIC mode, the EXPERT mode allows you much more control over the various shooting settings. These settings are performed on the EXPERT Mode Shooting Setting Screen.

Display the EXPERT Mode Shooting Setting Screen

- 1 Turn on the camera (page 37).**
- 2 Set the main switch to REC.**
- 3 Press the MENU button.**
 - The Menu Screen appears.
- 4 Set the camera to the EXPERT mode (page 42)**
 - The EXPERT Mode Shooting Setting Screen appears.
 - To cancel the EXPERT Mode Shooting Setting Screen, press the MENU button.

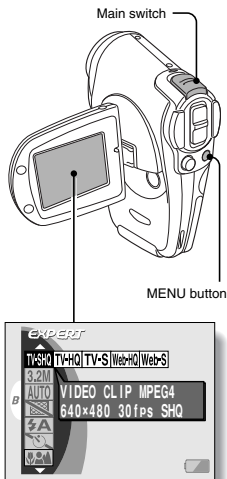

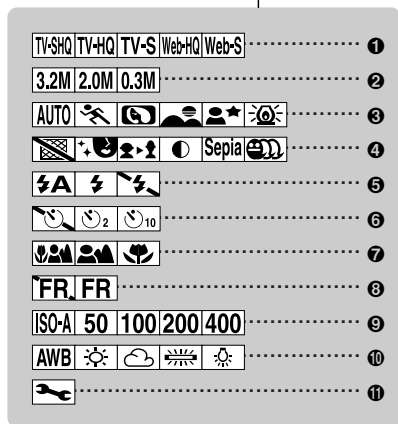
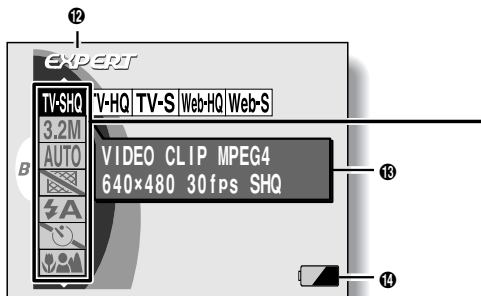

ABOUT THE EXPERT MODE SHOOTING SETTING SCREEN

EXPERT Mode Shooting Setting Screen





❶ Video clip menu (page 81)

: 640 x 480 pixels, 30 frames per second, low compression

: 640 x 480 pixels, 30 frames per second

: 320 x 240 pixels, 30 frames per second

: 320 x 240 pixels, 15 frames per second

: 176 x 144 pixels, 15 frames per second

❷ Photo resolution menu (page 56)

: 2048 x 1536-pixel resolution icon (3,200,000 pixels)

: 1600 x 1200-pixel resolution icon (2,000,000 pixels)

: 640 x 480-pixel resolution icon (300,000 pixels)

❸ Scene select menu (page 58)

: Full auto icon

: Sports icon

: Portrait icon

: Landscape icon

: Night view icon

: Lamp icon

❹ Filter menu (page 59)

: No filter

: Cosmetic filter on

: Slim filter on

: Monochrome filter on

: Sepia filter on

: Ghost filter on

❺ Flash menu (page 60)

: Automatic flash mode

: Forced flash mode

: Flash off mode

❻ Self-timer menu (page 62)

: Self-timer off

: Self-timer on (2 seconds)

: Self-timer on (10 seconds)

❼ Focus menu (Page 82)

: Wide end: 10 cm to infinity
Tele end: 80 cm to infinity

: 80 cm to infinity

: 2 cm to 60 cm

❽ Flicker-reduction menu (page 83)

: Flicker-reduction function off icon.

: Flicker-reduction function on icon.

❾ ISO sensitivity menu (Page 84)

: Auto sensitivity (ISO50 to 200)

: ISO50 icon.

: ISO100 icon.

: ISO200 icon.

: ISO400 icon.

❿ White balance menu (page 85)

: Auto white balance icon.

: Sunny icon.

: Cloudy icon.

: Fluorescent lighting icon.

: White (incandescent) light icon.

⓫ Option icon (page 105)

- Displays the Option Setting Screen.

⓬ Menu mode display (page 42)

⓭ Help display (page 107)

⓮ Remaining battery power (page 126)

- When you specify multiple functions that cannot be simultaneously enabled, the function which was last set becomes the active setting, and the other settings accordingly change automatically.

VIDEO IMAGE QUALITY

For high image quality and smooth video clip playback, a larger number of pixels and high frame rate is selected. A lower compression rate setting produces even more beautiful images. However, the file size becomes large and uses more memory, set the image quality to a setting that's right for your purpose.

1 Display the EXPERT Mode Shooting Setting Screen (page 78), and select the video clip menu.

- TV-SHQ** : Record at 640 x 480 pixels, 30 frames per second, low compression
- TV-HQ** : Record at 640 x 480 pixels, 30 frames per second
- TV-S** : Record at 320 x 240 pixels, 30 frames per second
- Web-HQ** : Record at 320 x 240 pixels, 15 frames per second
- Web-S** : Record at 176 x 144 pixels, 15 frames per second





2 Select the desired icon from the video clip menu, and press the SET button.

- This completes the video clip image quality setting.

FOCUS

1 Display the EXPERT Mode Shooting Setting Screen (page 78), and select the focus menu.

- When shooting a subject at a medium to far distance, by setting the focus range to , you will find it both easier and faster to focus.

 : Wide end: 10 cm to infinity
Tele end: 80 cm to infinity
(Total)

 : 80 cm to infinity (Normal)

 : 2 cm to 60 cm (Super Macro)

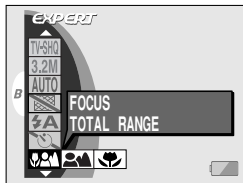





2 Select the desired icon from the focus menu, and press the SET button.

- This completes the focus range setting.

Note

About the scene select function and focus range settings

- The scene select function changes to **AUTO** when the focus range is set to  or .
- Even if you set the focus range to  or , it changes to  when the scene select function is set to anything other than **AUTO**.

About focus range in the BASIC mode

- In the BASIC mode, the focus range setting is automatically set to . When the distance between the camera and the subject is short, the focus range automatically changes to the macro setting.

FLICKER-REDUCTION FUNCTION

The flicker-reduction setting reduces the flicker that results when filming video clips under fluorescent lights and the like where the background lighting pulsates at the frequency of the power supply. The flicker-reduction setting is set for a frequency of 50 Hz.

-
- 1** Display the **EXPERT Mode Shooting Setting Screen (page 78)**, and select the flicker-reduction menu.

[FR OFF] : Turns off the flicker-reduction setting.

[FR] : Turns on the flicker-reduction setting.

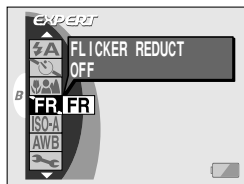

-
- 2** Select the **[FR]** icon from the flicker-reduction menu, and press the **SET** button.

- This completes the flicker-reduction setting.

HINT

- If the flicker-reduction setting is used outdoors on a very bright day, a halation effect may occur.

ISO SENSITIVITY

With the initial settings, the ISO sensitivity is automatically set according to the brightness of the subject. However, the ISO sensitivity can be set to a fixed setting.

-
- 1 Display the EXPERT Mode Shooting Setting Screen (page 78), and select the ISO sensitivity menu.**

ISO-A : Sets the ISO sensitivity automatically (equivalent to ISO50 to 200 (Video clip shooting mode: ISO200 to 800)).

50 : Sets the sensitivity to ISO50 equivalent (Video clip shooting mode: ISO200).

100 : Sets the sensitivity to ISO100 equivalent (Video clip shooting mode: ISO400).

200 : Sets the sensitivity to ISO200 equivalent (Video clip shooting mode: ISO800).

400 : Sets the sensitivity to ISO400 equivalent (Video clip shooting mode: ISO1600).

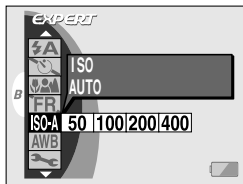

-
- 2 Select the desired icon from the ISO sensitivity menu and press the SET button.**

- This completes the ISO sensitivity setting.

HINT

- By setting a higher ISO sensitivity, you can set higher shutter speeds and capture images in darker locations, but noise in the captured images may increase.

WHITE BALANCE SETTING

This camera automatically adjusts the white balance under most lighting conditions. However, if you want to specify the lighting conditions or change the overall tone of the image, the white balance can be manually set.

1 Display the EXPERT Mode Shooting Setting Screen (page 78), and select the white balance menu.

AWB : The camera will make the white balance adjustment automatically based on the natural and artificial light conditions. This is the setting used in the auto mode.

 : For shooting outside on a sunny day.

 : For shooting outside on a cloudy day.

 : For shooting inside under fluorescent lighting.

 : For shooting inside under incandescent lighting.

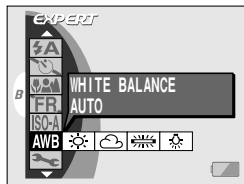

2 Select the desired icon from the white balance menu, and press the SET button.

HINT

To cancel the white balance setting

- Perform step 1, select **AWB**, and then press the SET button.

EXPOSURE CORRECTION

When capturing images, you can make the image lighter or darker.

1 Set the main switch to REC, and set the camera to the EXPERT shooting mode (page 78).

- To exit the EXPERT Mode Shooting Setting Screen, press the MENU button.

2 When the EXPERT Mode Shooting Setting Screen is not shown, toggle the SET button to the left or right.

- The exposure correction bar appears.

3 Toggle the SET button to the left or right to adjust the exposure.

- To cancel the exposure correction bar, press the MENU button.
- The exposure setting numerical value is shown at the left end of the exposure bar. The exposure can be set to a value from -1.8EV to $+1.8\text{EV}$.

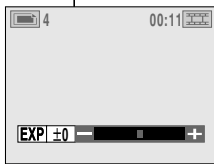
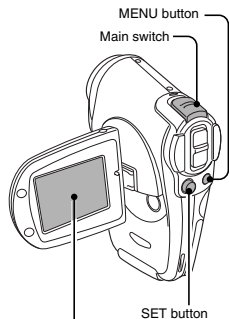

HINT

The exposure correction setting is canceled in the following cases:

- When the pointer is set to the center position.
- After the menu mode is changed.
- When the main switch is set to [PLAY].
- After the power is turned off.

ABOUT THE EXPERT MODE PLAYBACK SETTING SCREEN

The EXPERT mode playback settings are performed on the EXPERT Mode Playback Setting Screen.

Display the EXPERT Mode Playback Setting Screen

- 1 Turn on the camera (page 37).**
- 2 Set the main switch to [PLAY].**
- 3 Press the MENU button.**
 - The Menu Screen appears.
- 4 Set the camera to the EXPERT mode (page 42)**
 - The EXPERT Mode Playback Setting Screen appears.
 - To cancel the EXPERT Mode Playback Setting Screen, press the MENU button.

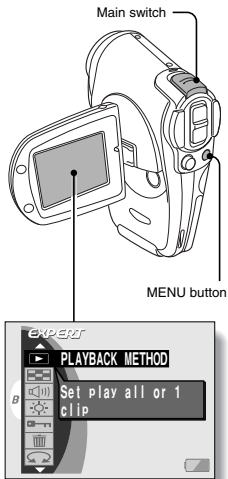

EXPERT MODE PLAYBACK SETTING SCREEN

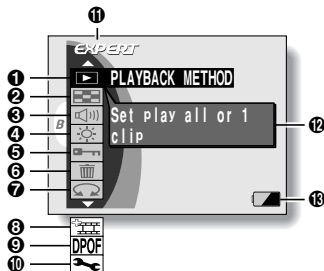

❶ Playback method setting (page 70)

- Select continuous playback or single-frame playback.

❷ Multi-playback (page 66)

- Display images in the 9-frame multi-display format.

❸ Volume control (page 71)

- Adjust the video clip and audio data playback volume.

❹ Monitor brightness (page 72)

- Adjust the brightness of the camera's LCD monitor display.

❺ Data protect setting (page 73)

- Protect data from accidental erasure.

❻ Erase (page 75)

- Delete images from the card memory.

❼ Rotate image (page 89)

- Rotate still images.

❽ Video clip edit (page 90)

- Edit video clips.

❾ Print settings (page 98)

- Set the DPOF settings.

❿ Option icon (page 105)

- Display the Option Setting Screen.

⓫ Menu mode display (page 42)

⓬ Help display (page 107)

⓭ Remaining battery power (page 126)

ROTATE IMAGE

Captured still images can be rotated to the correct orientation for viewing.



-
- 1** Display the **EXPERT Mode Playback Setting Screen** (page 87).

-
- 2** Select the rotate icon , and press the **SET** button.
 - The Rotate Image Screen appears.

 : Rotates image clockwise 90 degrees.

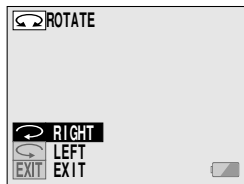
 : Rotates image counterclockwise 90 degrees.



-
- 3** Select the rotate right icon  or rotate left icon , and press the **SET** button.
 - Each time the SET button is pressed, the image is rotated another 90 degrees.

EDITING VIDEO CLIPS

You can delete (“cut”) the first part or the last part of a video clip. You can choose anywhere in the video clip as the cutting point.

You can also join two video clips together and save them as one separate clip (“joining”).

Note

Warning concerning the battery pack remaining charge

- During the editing of lengthy video clips, the time to process the large amount of data can become quite long. To avoid problems caused by the battery pack becoming depleted in the middle of video clip editing, before starting to edit be sure that a sufficiently charged battery pack is installed in the camera, or connect the AC adapter/charger.
- It is recommended that a computer be used to edit long video clips.

Procedure to save part of a video clip as a separate clip

Play the video clip, and pause playback at the point you want to cut.



Select whether to delete the portion before the cut point or after the cut point.



Delete the specified portion.

- The specified portion is deleted.



- The original video clip is not affected. (You can also choose to erase the original video clip when the new clip is saved.)



EDITING VIDEO CLIPS

Procedure to join two video clips

Display the video clip that will come first.



Select the video clip that you wish to append (join).



Join the video clips. (Press the SET button.)

- The two video clips are saved together as a separate video clip.



- The original video clip is not affected. (You can also choose to erase the original video clip when the new clip is saved.)

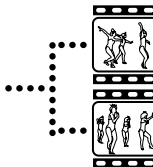

Note

Caution when editing video clips

- When editing video clips, do not move the main switch. If you move the main switch while editing video clips, not only will the editing not be properly completed, but the original video clip may also be erased.
- By repeating the clipping and joining procedures, you can create exactly the video clip you like. Note, however, that as the number or size of the video clips increases, the card memory may become full, making it impossible to edit the video clips. (The "CARD FULL" message will appear.) In this case, you will need to free some of the memory on the card either by deleting data that are no longer necessary (page 75), or by performing the procedure to erase the original video clip(s) (page 94, 97).

Deleting part of a video clip

1 Display the video clip you wish to edit.

2 Display the scene you wish to delete.

- Specify whether you wish to delete the portion from the beginning of the video clip up to the selected scene, or the portion from the selected scene to the end of the video clip.

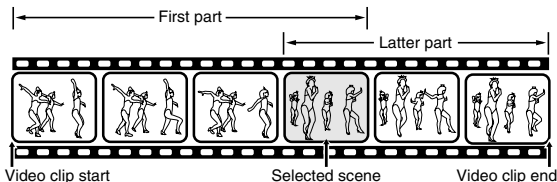

- To select the desired scene quickly, you can use a combination of the fast-forward (or reverse) playback, pause, and image-by-image playback functions (page 64).
- The actual cut point may be slightly before or after the displayed scene.

3 Display the EXPERT Mode Playback Setting Screen (page 87).



EDITING VIDEO CLIPS

- 4** Select the edit video icon , and press the SET button.

- The Edit Video Screen appears.



- 5** Toggle the SET button up or down to select the portion you wish to delete.

DELETE 1ST PART:

Delete the first part of the video clip.

DELETE 2ND PART:

Delete the latter part of the video clip.



- 6** Press the SET button.

- A screen appears for you to confirm whether or not you want to save the original video clip.



7 Select whether you want the original video clip to be erased when clipping is executed.

YES:

The original video clip is saved.

NO:

The original video clip is not saved.

8 Press the SET button.

- If “YES” was selected, the edited video clip is saved as a new video clip.
- If “NO” was selected, the edited video clip is saved as a new video clip, and the original video clip is erased.
- To return to the Playback Setting Screen, press the MENU button, or select the **EXIT** icon and press the SET button.

Note

- If the original video clip is protected, even if you select “NO” in step 7 and 8 and press the SET button, the original video clip will not be erased. If you want it to be erased, you will need to first remove the protection.

EDITING VIDEO CLIPS

Joining two video clips

- 1** Display the first video clip.

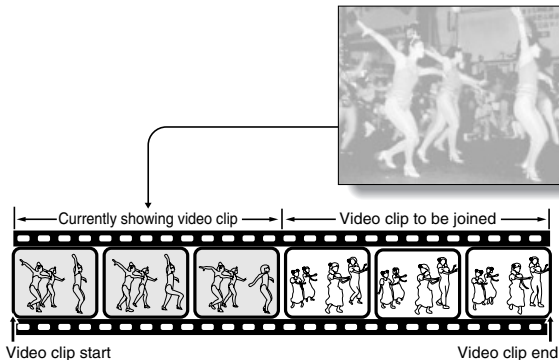

- 2** Display the EXPERT Mode Playback Setting Screen (page 87).

- 3** Select the edit video icon , and press the SET button.
- The Edit Video Screen appears.

- 4** Select the join icon .



5 Press the **SET** button.

- The 9-image playback display for video clips appears.

6 Toggle the **SET** button to move the orange frame to the video clip that you wish to join.

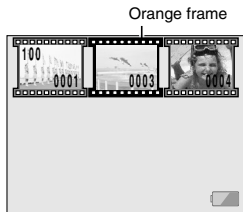

7 Press the **SET** button.

8 Select whether you want the original video clip to be erased when clipping is executed.

YES:

The original video clips are saved.

NO:

The original video clips are not saved.



Confirmation screen for saving the original video clip

EDITING VIDEO CLIPS

9 Press the SET button.

- The two video clips are saved together as a separate video clip.
- If “NO” was selected in step 8, the original video clips are erased when the joined video clip is saved.
- Press the MENU button, or select the  icon and press the SET button, to return to the Playback Setting Screen.

Extracting a still image from a video clip

While video clip playback is paused, you save a still image of the paused scene.

1 Display the frame (paused) you wish to save as a single still image.

2 Select the edit video icon from the EXPERT Mode Playback Setting Screen, and press the SET button.

- The Edit Video Screen appears.

3 Select the save frame icon , and press the SET button.

- The frame that is currently displayed is saved as a still image.

Note

- If the original video clip is protected, even if you select “YES” in step 8 and press the SET button, the original video clip will not be erased. If you want it to be erased, you will need to first remove the protection.

PRINT SETTINGS (STILL IMAGES ONLY)

In addition to using your printer to print out still images captured with your camera, as with conventional film, you can have prints made at shops offering digital print services. Moreover, this camera is DPOF-compatible, so you can use the camera to specify the number of prints, whether or not the date is displayed on the print, and also to specify an index print.

Display the Print Settings Screen

1 Display the **EXPERT Mode Playback Setting Screen** (page 87).

2 Select the print settings icon **DPOF**, and press the **SET** button.

- The Print Settings Screen appears.

ALL IMAGES:

The specified print settings apply to all the still images on the card.

EACH IMAGE:

The print settings are specified for each individual image.

INDEX:

All the still images are printed as miniature images (thumbnail images), several images on one print.

ALL CLEAR:

Clear all the print settings. This cannot be selected if no print settings have been made for the image.

EXIT:

Return to the Still Image Playback Setting Screen.



PRINT SETTINGS (STILL IMAGES ONLY)

HINT

- To print with a printer or have the digital print service shop print out a still image from a video clip, you must first save it (save frame) as a still image.

HINT

About the DPOF format

- DPOF (Digital Print Order Format) is a print order format. You can connect your camera to a DPOF-compatible printer to produce your prints. You can also set the print settings for the desired images, and then have the reserved images printed automatically.

About the finished prints

- Images that have been rotated will be printed in their original orientation.
- The quality of the print output will differ depending on the print service and printer used.

Specifying date imprinting and print quantities

You can specify print settings for each individual image (EACH IMAGE), or apply the print settings to all the images on the card (ALL IMAGES).

1 Display the Print Settings Screen (page 98).

2 Select EACH IMAGE or ALL IMAGES.

ALL IMAGES:

The set print settings are applied only to the image currently displayed.

EACH IMAGE:

The set print settings are applied to all the still images on the card.

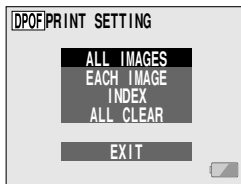

3 Press the SET button.

- The Date/Number Print Screen appears.
- If EACH IMAGE was selected, toggle the SET button to the left or right to display the desired image to print.
- Under "SETTINGS" the settings that are currently active for the displayed image are shown. You can toggle the SET button to the left or right to confirm the print settings for each image.

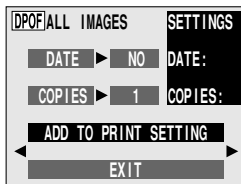

PRINT SETTINGS (STILL IMAGES ONLY)

- 4** Specify whether the date is displayed on the print, and the number of prints.

<Specifying dated prints>

- 1 Toggle the SET button up or down to select "DATE".
- 2 Press the SET button.
 - The Print Date Screen appears.
- 3 Toggle the SET button up or down to select the desired option.

YES:

Print the date.

NO:

Do not print the date.

- 4 Press the SET button.
 - You are returned to the Date/Number Print Screen.

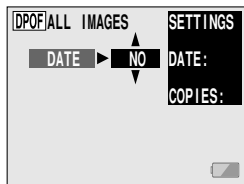

<Specifying the number of prints>

- 1 Toggle the SET button up or down to select "COPIES".
- 2 Press the SET button.
 - The Print Number Screen appears.
- 3 Toggle the SET button up or down to specify the number of prints.
 - Toggle the SET button up or down until the desired number of prints is displayed.
- 4 Press the SET button.
 - You are returned to the Date/Number Print Screen.

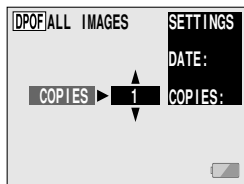

5 Select “ADD TO PRINT SETTINGS” and press the SET button.

- The Confirm Print Settings Screen appears.

If the print settings are correct:

Select “EXIT”, and press the SET button.

If the print settings were changed:

Select “MODIFY PRINT SETTING”, and press the SET button.

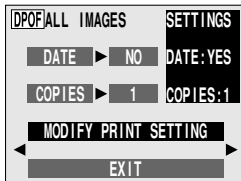

Index print

Printing out many small images on one sheet is called an “index print.” This is convenient for use as a list of the images you have captured.

1 Display the Print Settings Screen (page 98).

2 Select “INDEX”.

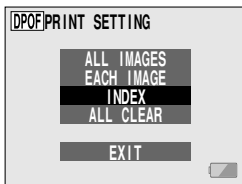

PRINT SETTINGS (STILL IMAGES ONLY)

3 Press the SET button.

- The Index Print Screen appears.

YES:

Specify an index print copy.

EXIT:

Discontinue the setting procedure, and return to the Print Setting Screen.

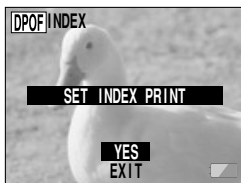

4 Select "YES", and press the SET button.

- This completes the setting for the index print. You are returned to the Print Settings Screen.

Changing the print settings

1 Follow steps 1 to 4 on page 100 and 101.

2 Select "MODIFY PRINT SETTING", and press the SET button.

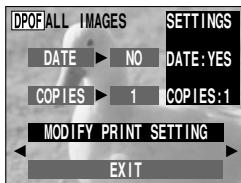

Clearing all the print settings

Delete the print settings for all images.

-
- 1 Display the Print Settings Screen (page 98).**
-



- 2 Select "ALL CLEAR".**
-

- 3 Press the SET button.**
 - The Confirm All Clear Screen appears.

YES:

Clear the print settings for all images.

EXIT:

Cancel the clear procedure and return to the Print Settings Screen.

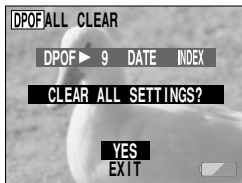

- 4 Select "YES", and press the SET button.**
 - All the print settings are cleared and you are returned to the Print Settings Screen.

ABOUT THE OPTION SETTING SCREEN

The Option Setting Screen is used to adjust various camera settings and is common to both the BASIC and EXPERT modes.

To display the Option Setting Screen

1 Turn on the camera (page 37).

2 Press the **MENU** button.

- The Menu Screen appears.

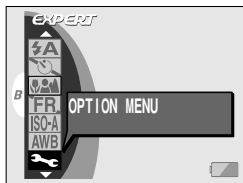

3 Select the option icon , and press the **SET** button.

- The Option Setting Screen appears.
- To cancel the Option Setting Screen and return to the Menu Screen, press the MENU button.

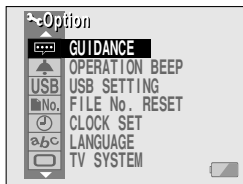

Option Setting Screen

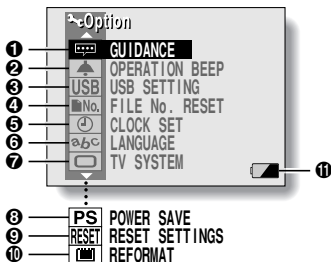

❶ Guidance setting (page 107)

- Set the help display and audio guide on or off.

❷ Operation sounds setting (page 108)

- Adjust the operation sounds produced when the camera's buttons are pressed.

❸ USB setting (page 110)

- Specify whether a printer or a computer is connected.

❹ File number reset (page 111)

- Select the file number reset function.

❺ Date and time setting (page 114)

- Set the camera's internal clock.

❻ Screen language (page 117)

- Select the language in which the LCD monitor messages are displayed.

❼ TV system setting (page 118)

- Select the type of video signal that is output from the camera's DIGITAL/AV terminal.

❸ Power save function (page 119)

❹ Reset camera settings (page 121)

- Reset the camera to the factory-preset settings.

❺ Card reformat (page 122)

- Use the camera to reformat the memory card.

❻ Remaining battery power (page 126)

GUIDANCE FUNCTIONS

You can set whether or not the help display is shown on the LCD monitor, and whether the audio guide giving verbal operation instructions is enabled.

1 Display the Option Setting Screen (page 105).

2 Select the guidance icon , and press the SET button.

- The Guidance Setting Screen appears.

HELP DISP:

Enable or disable the HELP messages display.

AUDIO GUIDE:

Adjust the volume of the audio guide. When set to "OFF", the audio guide is muted.

EXIT:

Cancel the setting mode, and return to the Option Setting Screen.

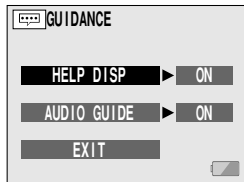

3 Toggle the SET button up or down to select the desired setting, and press the SET button.

- The setting screen for the selected parameter appears.
- Toggle the SET button up or down to change the setting for the parameter, and press the SET button.

OPERATIONAL SOUNDS SETTING

This setting allows you to set whether or not a confirming audio signal sounds when the operation buttons (still image shooting button, SET button, MENU button, etc.) are pressed.

1 Display the Option Setting Screen (page 105).

2 Select the BEEP icon , and press the SET button.

- The Operation Sounds Setting Screen appears.

TURN ON/OFF:

Mute or enable the sound that is produced when the power is turned on or off.

SHUTTER:

Select the sound that is produced when the still image shooting button is pressed, or when a photo is taken using the self-timer.

KEY SW:

Select the sound that is produced when the SET button, MENU button, etc. are pressed.

EXIT:

Return to the Option Setting Screen.

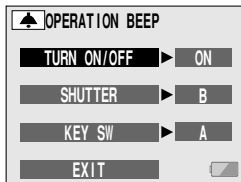

OPERATIONAL SOUNDS SETTING

3 Toggle the SET button up or down to select the desired setting, and press the SET button.

<If TURN ON/OFF is selected>

- The screen to turn the operation sounds on or off appears.
- Toggle the SET button up or down to select the desired setting, and press the SET button.

ON:

Activates the operational sounds when the camera is turned on or off.

OFF:

Deactivates the operational sounds when the camera is turned on or off.

<If SHUTTER or KEY SW is selected>

- The screen to select the operation sounds appears.
- Select from 8 different sounds (A to H).
- You can press the still image shooting button to preview the selected operation sound.
- If "OFF" is selected, no sound is produced.
- Toggle the SET button up or down to select the desired setting, and press the SET button.

HINT

- If you keep the MENU button pressed and turn on the power, the screen to set whether the operation sounds are enabled or disabled appears at once. You may find this a convenient procedure to switch the setting in places you do not want the operation sounds to be audible. If the operational sound is set to "OFF", the audio guide is also muted.

USB FUNCTION SETTING

Perform the USB setting when the dedicated USB interface cable is used to connect your camera to another device. Two modes are available for the USB connection function. The PC connection mode is selected when the camera is connected to a computer and used as a card reader. Select the PictBridge mode when the camera is connected to a printer.

1 Display the Option Setting Screen (page 105).

2 Select the USB setting icon , and press the SET button.

- The USB Setting Screen appears.

CARD READER:

PC connection mode setting (page 129)

PICTBRIDGE:

PictBridge mode setting (page 139)

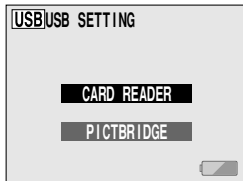

3 Select the correct mode for your purpose, and press the SET button.

Note

- When the CARD READER mode is set and the camera is connected to a computer, the multi-indicator lights green.
- When the PICTBRIDGE mode is set and the camera is connected to a printer, the multi-indicator lights red.

FILE NO. RESET FUNCTION

If a reformatted card is used, the file name (image number) of the captured image automatically begins from 0001. If the card is subsequently reformatted, or if a different reformatted card is used, the file names again begin from 0001. This is because the file number reset function is set to ON, and consequently it results in more than one card containing images with the same numbers. By setting the file number reset function to OFF, even if the card is reformatted or the card is replaced with another card, the consecutive numbering of file names continues from the last number recorded by the camera.

<File number reset function ON>

	File name (image number)
Card A	0001, 0002 0012, 0013

Replace card



Card B	0001, 0002 0012, 0013
--------	-----------------------------

<File number reset function OFF>

	File name (image number)
Card A	0001, 0002 0012, 0013

Replace card



Card B	00014, 00015 0025, 0026
--------	-------------------------------

- If Card B already has image data in it when it replaces Card A, file names are assigned as follows.
 - When the highest image number on Card B (before replacing) is lower than the highest image number on Card A: the file name of the next recorded image continues from last file name recorded on Card A.

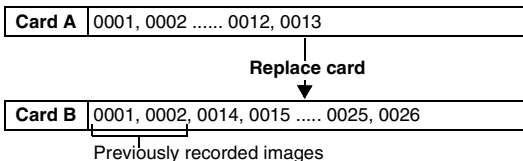

- When the highest image number on Card B (before replacing) is higher than the highest image number on Card A: the file name of the next recorded image continues from last file name recorded on Card B.



FILE NO. RESET FUNCTION

- 1** Display the Option Setting Screen (page 105).

- 2** Select the file number reset icon .

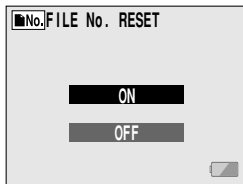

- 3** Press the SET button.
 - The File Number Reset Screen appears.

ON:
The file number reset function is on.

OFF:
The file number reset function is off.

- 4** Select “OFF”, and press the SET button.
 - The file number reset function is deactivated.

Note

- Until the file number reset function is turned ON, consecutive file names are assigned. It is recommended that the file number reset function be returned to ON at the end of each photography session.

DATE AND TIME SETTING

The camera will record the date and time an image or audio recording is taken so that you can display them during playback. Therefore, before capturing images, make sure the correct date and time are set.

Example: To set the clock to 7:30 p.m. on December 23, 2003

1 Display the Option Setting Screen (page 105).

-
- 2** Select the clock set icon , and press the SET button.
- The Clock Set Screen appears.
 - The current date and time settings are shown.
 - Follow the procedures below to enable or disable the date display during playback, to set the display format for the date, and to set the date and time.
 - To return to the Option Setting Screen, press the MENU button, or select "EXIT" and press the SET button.

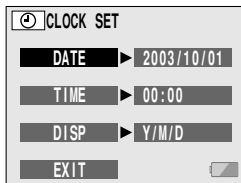

DATE AND TIME SETTING

3 Set the date.

- 1 Select "DATE".
- 2 Press the SET button.
 - The Set Date Screen appears.
- 3 Set the date to "2003/12/23".
 - The date is set in the following order: Set the year → Set the month → Set the day.
 - Toggle the SET button left or right to select year, month or day. Toggle the SET button up or down to increase or decrease the number.
- 4 Press the SET button.

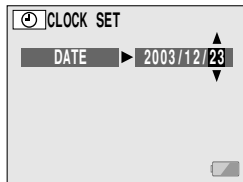

4 Set the clock.

- 1 Select "TIME".
- 2 Press the SET button.
 - The Set Time Screen appears.
- 3 Set the time to "19:30".
 - The time is set in the following order: Set the hour → Set the minute.
 - A 24-hour clock is used for the time display.
- 4 Press the SET button.

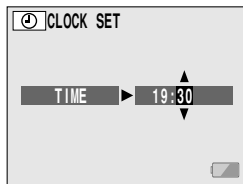

5 Set the order in which the date is displayed during playback.

- 1 Select "DISP".
- 2 Press the SET button.
 - The Set Date Format Screen appears.
- 3 Toggle the SET button up or down.

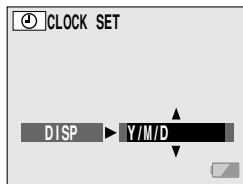

- Toggle the SET button up to change the displayed date order as follows:

→ year/month/day → month/day/year → day/month/year → DISP OFF (no display) →

Toggle the SET button down to change it in the reverse order.

- If “DISP OFF” is selected, the date the image was captured is not shown during playback.
- ④ Press the SET button.

6 Select “EXIT”, and press the SET button.

- The date and time setting is completed, and you are returned to the Option Setting screen.

Note

- Under normal conditions, while the battery pack is being replaced, an internal battery will maintain the date and time settings. However, there is a small chance the settings may be lost. (The backup will last for about 7 days.) It is recommended to check that the date and time settings are still correct after replacing the battery pack and before shooting or recording of any type (follow steps 1 and 2).

To correct the date and time settings

- After steps 1 and 2, select the line of the setting that you want to change, press the SET button, and follow the steps in the respective paragraphs above to change the setting.

SCREEN LANGUAGE

You can set the LCD monitor of your camera to display the messages in any one of nine languages.

1 Display the Option Setting Screen (page 105).

2 Select the language icon , and press the SET button.

- The Language Screen appears.
日本語: Select for Japanese.
ENGLISH: Select for English.
FRANCAIS: Select for French.
DEUTSCH: Select for German.
ESPAÑOL: Select for Spanish.
ITALIANO: Select for Italian.
한국어: Select for Korean.
中文(繁): Select for Chinese (traditional).
中文(简): Select for Chinese (simplified).

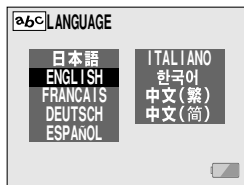

3 Select the desired language, and press the SET button.

- You are returned to the Option Setting Screen.

HINT

- In the shooting mode, if you press and hold the MENU button, the screen in step 2 appears, allowing you to set the screen language.

TV SYSTEM SETTING

This setting is to specify the type of image signal that is output from the camera's DIGITAL/AV terminal.

-
- 1** Display the Option Setting Screen (page 105).

-
- 2** Select the TV system icon , and press the SET button.

- The TV System Setting Screen appears.

NTSC:

Output NTSC video signals

PAL:

Output PAL video signals

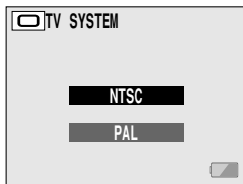

-
- 3** Select the appropriate TV system, and press the SET button.

Note

- If the TV system setting is not correct for the connected TV, you will not be able to view the images on the TV.

When set to “PAL” and connected to a TV

Shooting: Images are displayed on the LCD monitor only and do not appear on the TV.

Playback: Images are displayed on the TV only and do not appear on the LCD monitor.

POWER SAVE SETTING

Your camera has a “power save” function whereby the power automatically turns off after a specified period of inactivity. The power save function works to conserve the battery pack power when the camera is not being used, or to prevent the battery pack from dying if the camera has accidentally been left on. You can specify the elapsed time (standby time) before the power save function is activated.

1 Display the Option Setting Screen (page 105).

2 Select the power save icon [PS], and press the SET button.

- The Power Save Setting Screen appears.

BATT/CAM:

Set the standby time for the shooting modes when the battery pack is used.

BATT/PB:

Set the standby time for the playback modes when the battery pack is used.

EXT.PWR/CAM.PB:

Set the standby time for the shooting and playback modes when using an AC power source.

EXIT:

Return to the Option Setting Screen.

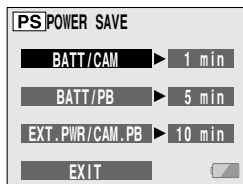

3 Select the desired option.

4 Press the **SET** button.

- The Set Standby Time Screen appears.

5 Toggle the **SET** button up or down to set the standby time.

Up:

Increases the standby time.

Down:

Decreases the standby time.

6 Press the **SET** button.

- The standby time is set, and you are returned to the Power Save Setting Screen.

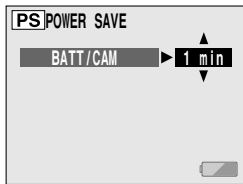

<Example: When "BATT/
CAM" is selected>

RESETTING THE CAMERA SETTINGS

Reset the camera to the factory-preset settings.

1 Display the Option Setting Screen (page 105).

2 Select the reset settings icon , and press the SET button.

- The Reset Settings Screen appears.

YES:

Reset to the factory-preset settings.

NO:

Do not change the settings, and return to the Option Setting Mode Screen.

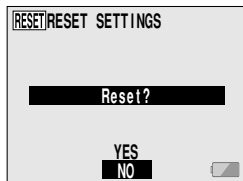

3 Select “YES”, and press the SET button.

- The camera settings are reset to the factory-preset settings.

HINT

- Note that the following settings do not change with this procedure:
 - Date and time setting
 - Language setting
 - TV system setting

FORMATTING A CARD

The supplied card must be formatted with this camera. In addition, a card must be formatted with this camera:

- After purchasing, when used for the first time, or
 - If it was formatted using a personal computer or another digital camera.
- The card cannot be reformatted if the lock switch is set to the "LOCK" position. Proceed with the reformat procedure after setting the lock switch to the unlocked position (page 26).

1 Display the Option Setting Screen (page 105).

-
- ## 2 Select the reformat icon , and press the SET button.
- The Reformat Screen appears.
 - In normal use, a total format is not necessary. However, in case a card error occurs even after normal formatting, executing a total reformat may resolve the problem.

FORMAT:

A normal reformatting is executed.

FULL FORMAT:

The entire card is scanned and reformatted. (When there is little battery power remaining, this setting cannot be selected.)

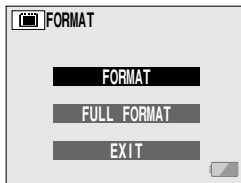

FORMATTING A CARD

3 Select the desired format option, and press the SET button.

4 Select "YES".

5 Press the SET button.

- Reformatting begins.
- During reformatting, "REFORMAT" and "DO NOT POWER OFF" are shown on the LCD monitor.

CAUTION

Caution during reformatting

- Do not turn off the power to the camera or eject the card during reformatting.

Reformatting erases the data

- When a card is reformatted, all data recorded on the card is erased. Protected data (page 73) is also erased, so before reformatting a card, any data you want to keep should be copied to your personal computer's hard disk or other storage medium.

HINT

To cancel reformatting

- In step 4, select "EXIT", and press the SET button.

CHECKING THE REMAINING CARD MEMORY

You can check how many images can be captured and how much recording time is available on the card. For a table showing the maximum number of images and recording time for specific cards, please see "Possible No. of Images/Possible Shooting Time/Possible Recording Time" on page 167.

Checking the remaining number of images and video recording time

1 Set the main switch to REC, and turn on the power (page 37).

- The remaining number of images appears in the upper left of the LCD monitor.
- The remaining video recording time appears in the upper right of the LCD monitor.
- The remaining number of images and video recording time will differ depending on the resolution and compression settings.
- When the remaining number of images or the remaining video recording time is "0", you cannot capture any more images. To capture more images, either install a new card, or save the images to a computer (page 129) and then erase them (page 75) from the card.
- When the remaining number of images or the remaining video recording time is "0", it may be possible to capture a few more images by setting a lower resolution setting (pages 55, 56), or selecting a different compression setting.

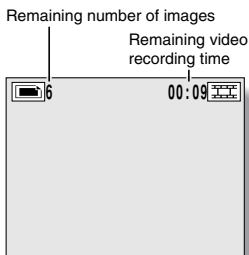

<Still image shooting mode>

CHECKING THE REMAINING CARD MEMORY

For audio data

1 Display the Audio Data Information Screen (page 77).

- The remaining card memory is shown.

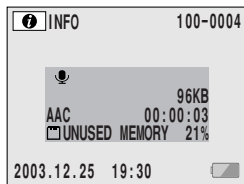





CHECKING THE REMAINING BATTERY PACK CHARGE

When using the battery pack, the remaining battery pack charge can be checked on the LCD monitor. Make sure to check this indicator before capturing an image. For an indication of the possible length of time for battery pack operation, see page 166.

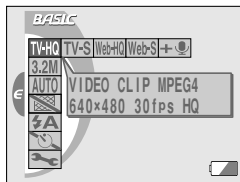
1 Display a Shooting or Playback Setting Screen (pages 52, 68, 78, 87).

- The battery pack remaining charge indicator appears in the lower right corner of the LCD monitor.
- Due to the battery pack characteristics, when the ambient temperature is low,  may appear early for an incorrect indication of the remaining charge. Also, depending on the conditions of use of the camera or the ambient conditions (temperature, etc.), the indicated remaining charge may change. Therefore, this indication can only be used as a general approximation of the remaining charge.



Battery pack remaining charge indicator	Battery pack remaining charge indicator
	Approx. full.
	Power is low.
	It will soon be impossible to capture or play back images.
	If this icon flashes when the still image shooting button or video clip recording button is pressed, images cannot be captured. Recharge the battery pack.

CHECKING THE REMAINING BATTERY PACK CHARGE

HINT

- If any data is present, you can also check the remaining battery pack charge on the Playback Screen.
- Use only the supplied or separately sold battery pack in this camera.
- Battery life may differ even among battery packs of the same type.
- Depending on the usage of the camera (such as the number of times the flash is used, the use of the LCD monitor, etc.) or the ambient temperature (temperatures below 10°C) the number of images that can be saved on a fully charged battery pack will vary greatly.

Note

- It is recommended that you prepare an extra battery pack(s) when taking pictures at a wedding or while traveling, for example, so you don't miss capturing images of important moments due to the battery pack power running out. The same is recommended for taking photos in cold environments. (In a ski area, for example, the battery pack can be kept warm in your pocket until ready to use.)

DOCKING STATION

Set your camera in the supplied docking station to recharge the battery pack as well as for easy connection to a computer, printer or TV. A remote control unit is provided for even easier operation of your docked camera (playback only).

CAUTION

Gently connect and disconnect the cable

- When connecting and disconnecting the cable, please do so with a gentle touch. Exerting a strong pull on the cable or connector may damage them.

Connecting the docking station

Connect the AC adapter/charger

Use the supplied AC adapter/charger to connect the DC IN terminal on the docking station to a power outlet.

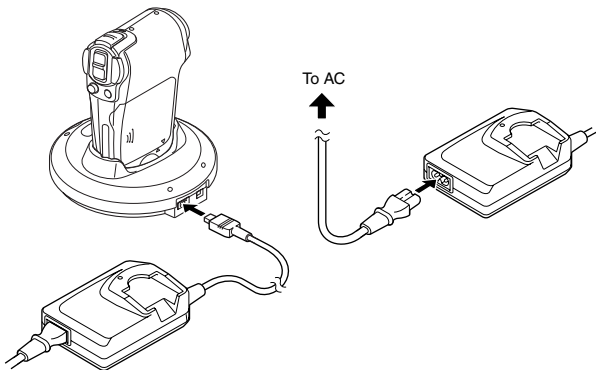

DOCKING STATION

Connect to another device

<To connect to a computer or printer>

Use the supplied USB interface cable to connect the DIGITAL/AV terminal of the docking station to the USB terminal of a computer or printer.

- Connect the dedicated USB interface cable to your computer's USB connector. Do not connect it to the USB port on your monitor or keyboard, or to the USB hub. Be especially careful when installing the driver software. In some instances, it may not be possible to correctly install the driver software.
- Please refer to the included Sanyo Software Pack instruction manual for information regarding operating your camera from a computer.

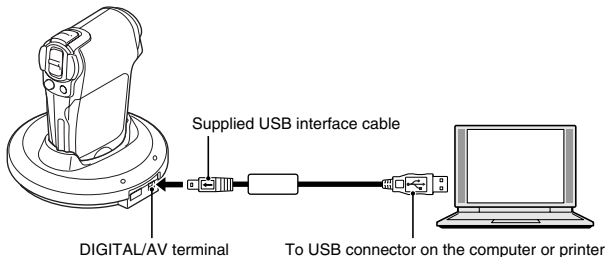

<To connect to a TV>

Use the supplied AV cable to connect the DIGITAL/AV terminal of the docking station to the audio and video terminals of a TV.

- After connecting the camera to the television, set the TV input switch to VIDEO input.
- The remote control unit can be used for playback.
- The playback method is the same as when viewing images on the LCD monitor.
- The same playback procedure as when playing back with the camera is used to play back audio recordings as well.

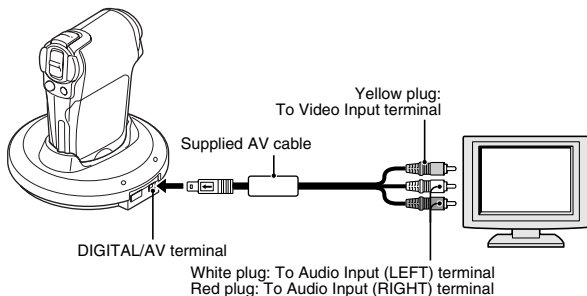

Data file formats

The format of the files saved on the card and the method in which the file names are determined are explained below.

Type of data	Data format	File name structure
Still image data	JPEG	File name begins with SANY. Extension is ".jpg". SANY****.jpg
Video clip data	MPEG-4	File name begins with VCLP. Extension is ".mp4". VCLP****.mp4*
Audio recording data	MPEG-4 Audio (AAC compression)	File name begins with SUND. Extension is ".m4a". SUND****.m4a*

*Consecutive numbers assigned in the order the data was saved.

DOCKING STATION

Configuration of directories for the stored data

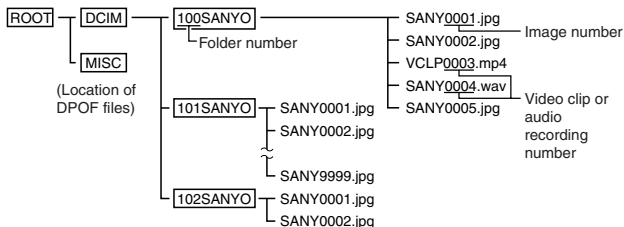

* Up to 9999 files can be stored in folder 100SANYO. If more files are made, a folder named 101SANYO is created, and they will be stored in there. New folders will then be named in sequence, i.e., 102SANYO, 103SANYO, etc.

Note

About video clip data recorded with this camera

- You can use Apple's QuickTime 6.1 or later version to play back video clips on a computer. Playback may also be possible using other software that supports the ISO standard MPEG-4 (AAC audio). QuickTime6.3 for Windows and Macintosh is supplied with the included CD-ROM (Sanyo Software Pack).

About audio data recorded with this camera

- If you change the extension (.m4a) of audio data files to ".mp4", playback may be possible using software that supports the ISO standard MPEG-4 (AAC audio).

About file names when the card is replaced...

- If the file number reset function is set to off, even when the card is replaced, consecutive numbering of folder numbers and file names continues from the previously installed card (page 111).

CAUTION

If you intend to view the images on the camera, do not use a computer to rewrite the card data.

- If the folders, file names, or their configuration is modified using a personal computer, it will be impossible to play back the data using the camera, and the camera may not operate properly.

Set the camera in the docking station

1 Close the camera's monitor unit, and set it in the docking station.

- Note the camera's orientation and the position of the docking station terminals, and insert the camera firmly.
- Recharging begins as soon as the camera is set in the docking station.
- During charging, the charging indicator lights red. When charging is complete, the charging indicator lights green.
- If there is a battery malfunction or if the camera is incorrectly set in the docking station, the charging indicator flashes red, and the docked camera's multi-indicator flashes red. Set the camera in the docking station correctly.

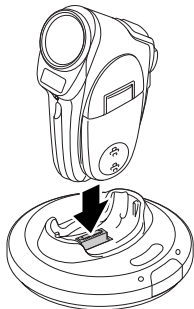

Preparing and using the remote control unit

Use the supplied remote control unit to play back data from the docked camera.

Prepare the remote control unit

The remote control unit comes with the battery already installed at the time of purchase.

1 Pull out and remove the protective battery insulating sheet.

- The remote control unit becomes operative when the insulating sheet is removed.

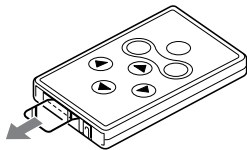

DOCKING STATION

How to use the remote control unit

The remote control unit can be used at an angle that is displaced 15 degrees horizontally from the remote control sensor on the front of the docking station, at a distance of up to 7 meters.

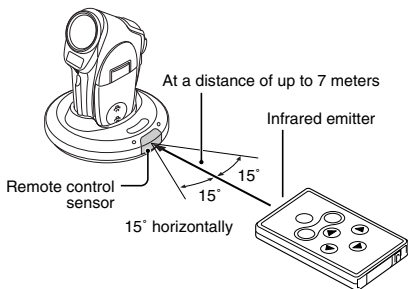

CAUTION

- If the remote control unit is operated in sunlight or under inverter lighting, the remote control receiving range may become shorter. This is a characteristic of the infrared remote control unit and is not a defect. To avoid this malfunction when operating the remote control unit, take care to shield the remote control sensor from strong light.

<Remote control unit button operation>

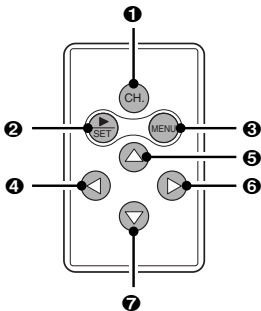

❶ CH (channel)

- Switch the remote control code (page 136).

❷ SET

- Same operation as the camera's SET button.

❸ MENU

- Same operation as the camera's MENU button.

❹ [◀]

- Works the same as toggling the camera's SET button to the left.

❺ [▲]

- Works the same as toggling the camera's SET button up.

❻ [▶]

- Works the same as toggling the camera's SET button to the right.

❼ [▼]

- Works the same as toggling the camera's SET button down.

DOCKING STATION

Replacing the remote control unit battery

The life of the lithium battery will depend on your use of the remote control unit, but as a general guideline, it will require replacement about once a year. Follow the steps below to replace the CR2025 Lithium battery (sold commercially).

1 Pull out the battery holder from the remote control unit.

- Push in the tab to release the battery holder, and then pull it out.

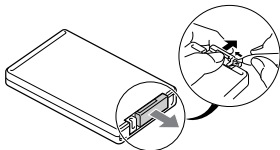

2 Remove the battery.

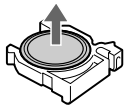

3 Insert a new battery (CR2025) in the holder.

- Wipe the new battery with a soft, dry cloth, and then insert it with the (+) mark facing upward.

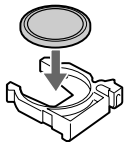

4 Reinsert the battery holder in the remote control unit.

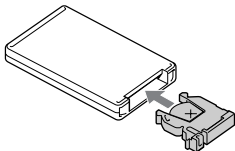

Changing the remote control code

The remote control unit will also work with other Sanyo cameras that can be operated by infrared remote control. When more than one camera is present, it is recommended to change the remote control code to ensure that only the intended camera operates when the remote control unit is used. The remote control code is set to "RC CODE 1" at the time of purchase.

<Changing the remote control code from "RC CODE 1" to "RC CODE 2">

1 Aim the infrared emitter at the remote control sensor on the docking station.

2 Hold down the CH button and press the [▲] button for about 3 seconds.

3 Press a button on the remote control unit and check that the camera is receiving correctly.

- The remote control codes are retained even if the batteries in the remote control unit and camera are replaced.
- If the remote control codes for the remote control unit and the camera do not match, the remote control unit cannot be used to operate the camera.

DOCKING STATION

<Resetting the remote control code to “RC CODE 1”>

- 1** Aim the infrared emitter at the remote control sensor on the docking station.
 - 2** Hold down the CH button and press the [▼] button for about 3 seconds.
-

Select the image to play back.

- 1** Connect the docking station to a TV, and set the camera in the docking station.
 - 2** Press the CAMERA/CHARGE button to turn on the camera lamp.
-

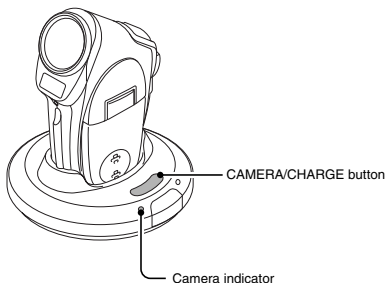

- 3** Set the TV input switch to VIDEO input.
 - If the camera is set to the playback mode, the Playback Screen appears on the TV monitor. The playback method is the same as when viewing images on the LCD monitor.
-

CABLE ADAPTER

When not using the docking station, you can connect the camera to a computer, printer, TV or AC adapter/charger, etc, using the supplied adapter.

-
- 1 Attach the adapter to the docking station terminals on the bottom of the camera.**

-
- 2 Various devices can be connected to the adapter terminals**

DC IN terminal:

Connect the supplied AC adapter/charger.

DIGITAL/AV terminal:

Connect to a computer, printer or TV.

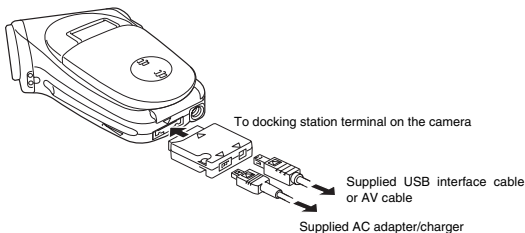

Note

The remote control unit cannot be used.

- Unlike when using the camera in the docking station, when the adapter is connected, the remote control unit cannot be used to operate the camera. To play back data from the camera, use the operation buttons on the camera.

The battery cannot be recharged.

- When recharging the battery pack that is installed in the camera, set the camera in the docking station. To recharge the battery pack without using the docking station, remove the battery pack from the camera and set it in the AC adapter/charger to recharge it.

CONNECTING TO A PRINTER

Your camera supports the PictBridge function. By connecting the camera directly to a PictBridge-enabled printer, the camera's LCD monitor can be used to select images and initiate printing.

Print preparations

- 1** Install the card containing the images you want to print in the camera.
- 2** Use the supplied docking station or adapter to connect the camera to the printer (pages 132 and 138).

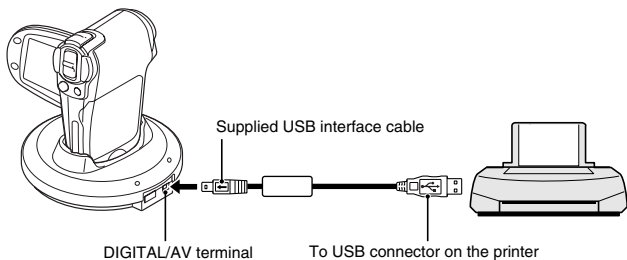

<Using the docking station>

- Set the camera in the docking station, and press the CAMERA/CHARGE button to turn on the camera indicator.
- When the connections are complete, turn on the printer, and confirm that the camera's multi-indicator is lit red. When the multi-indicator is lit green, it is not possible to print.

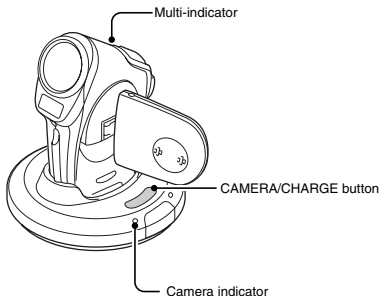

<Using the cable adapter>

- After attaching the cable adapter, set the camera's main switch to PLAY.

WARNING

Do not turn off the power to the printer while it is connected.

- If the power to the printer is turned off while it is connected, the camera may not operate correctly. If the camera does not operate correctly, disconnect the USB interface cable, turn off the camera, and then reconnect the cable.

CONNECTING TO A PRINTER

3 The PictBridge printing mode is activated.

- The camera switches to the PictBridge printing mode, and the PictBridge Screen appears.

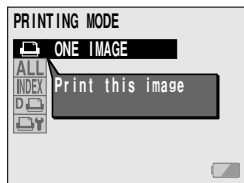

CAUTION

- During PictBridge printing, the camera's button operation response is slower.
- If the camera is powered by batteries for printing, make sure that the remaining battery charge is sufficient.

To select one image and print it (one image)

Procedure to select one still image and print it.

-
- 1** Complete the printing setup (page 139).

-
- 2** Select the choose one image icon , and press the SET button.
 - The screen to select images for printing appears.

-
- 3** Toggle the SET button to the left or right to display the image you wish to print.
 - Specify the image to print.

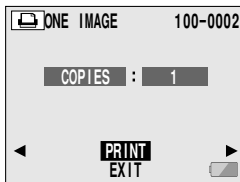

CONNECTING TO A PRINTER

4 Specify the number of prints.

- 1 Select "COPIES", and press the SET button.
- 2 Toggle the SET button up or down to specify the number of prints.
- 3 Press the SET button.
 - "PRINT" is selected.

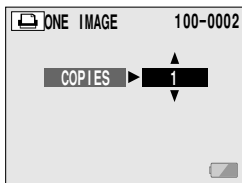

5 Press the SET button.

- Printing begins.

Note

To cancel printing

- During printing, toggle the SET button down.
 - The Confirm Cancel Printing Screen appears.
- Select "YES", and press the SET button.
 - If "NO" is selected and the SET button is pressed, printing resumes.

To print all the images (all images)

Print all of the images on the card.

-
- 1 Complete the printing setup (page 139).

-
- 2 Select the print all images icon **ALL**, and press the SET button.
 - The Print All Images Screen appears.

-
- 3 Select "PRINT", and press the SET button.
 - Printing begins.

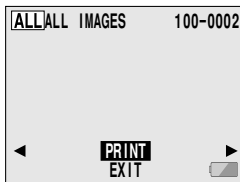

Note

Printing is not possible if there are more than 999 still images in the card.

- Delete unwanted images before printing.

CONNECTING TO A PRINTER

Thumbnail prints (index)

Make an index print of all the images on the card.

-
- 1** Complete the printing setup (page 139).

 - 2** Select the index print icon , and press the SET button.
 - The Index Print Screen appears.

 - 3** Select “PRINT”, and press the SET button.
 - Printing begins.

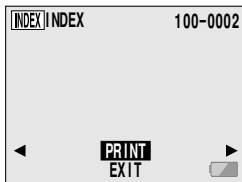

To print the images that are set to print (print reserved images)

Procedure to print all the images that are set to print.

-
- 1** Make the print settings (page 98), and complete the printing setup (page 139).

-
- 2** Select the print reserved images icon , and press the SET button.
- The Confirm Print Images Screen appears.

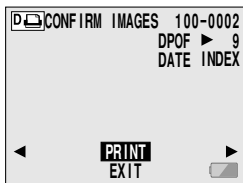

-
- 3** Select "PRINT", and press the SET button.
- Printing begins.
 - Printing begins about 1 minute after the SET button is pressed.
 - During printing, the remaining number of images to be printed is shown on the LCD monitor.

HINT

- In step 2, if you toggle the SET button to the left or right, you can confirm the images that are set to print and their DPOF settings.

CONNECTING TO A PRINTER

To change the printer settings and print images (change printer settings)

Images are printed according to settings specified by the camera, such as paper type, size, layout, printing quality, etc.

-
- 1 Complete the printing setup (page 139).

-
- 2 Select the change printer settings icon , and press the SET button.

- The Printer Settings Screen appears.

MEDIA TYPE:

Specify the type of paper used for printing.

PAPER SIZE:

Specify the size of paper used for printing.

LAYOUT:

Specify how the images are to be arranged on the paper.

QUALITY:

Select the print quality for the images.

DATE STAMP:

Print the date the photo was taken.

EXIT:

Return to the Printing Mode Screen.

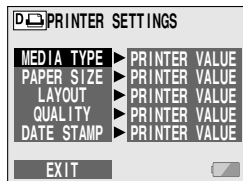

3 Adjust the printer settings.

- ❶ Toggle the SET button up or down to select a printer setting parameter, and press the SET button.
 - The screen to set the selected parameter appears.
- ❷ Toggle the SET button up or down to adjust the setting, and press the SET button.
 - The selected parameter is set, and you are returned to the Printer Settings Screen.
 - Follow the same procedure to adjust the other parameters, as desired.
 - The contents of the settings that can be made for each parameter will differ depending on the printer.

<When “PRINTER VALUE” is selected>

- The images will be printed according to the settings specified on the printer side.

4 Select “EXIT”, and press the SET button.

- You are returned to the Printing Mode Screen.

Note

- The printer setting parameters will differ depending on the printer that is connected.
- To use printer functions which do not appear on your camera's Printer Settings Screen, select “PRINTER SETTINGS”.
- If a function set by the camera is not available in the printer, the camera's printer settings will automatically change to “PRINTER SETTINGS”.









COMMONLY ASKED QUESTIONS









If you have a question about the camera operation, you might find the answer in this compilation of commonly asked questions.

	Question	Cause	Action
Power	Why doesn't the power turn on?	Due to cold temperatures, the battery pack temporarily lost its power.	Place the camera in your pocket to warm it up before using it.
	Why is the battery pack consumed so quickly even after it was fully recharged?	The ambient temperature is very low.	Keep the battery pack in an environment of 10 to 40°C.
	Why doesn't recharging end?	The battery pack life has expired.	Replace with a new battery pack. If this is not effective, consult your dealer.
	Why does the  icon appear?	The remaining battery pack power is low.	Use the supplied AC adapter/charger, or replace the battery pack with a fully charged one.
	While the flash is recharging, why does the LCD monitor suddenly turn off?	Battery pack power is low, activating the function that momentarily turns off the LCD monitor.	Not a malfunction. When the flash is fully charged, the LCD monitor will turn on again.

	Question	Cause	Action
Shoot- ing	Why does the multi-indicator light red?	Recorded data is being saved on the card.	Not a malfunction. Wait until the multi-indicator turns off.
	Why doesn't the flash operate?	The camera has determined that the image is bright enough and the flash is not necessary.	Not a malfunction. Capture the image; the camera will determine when the flash is necessary.
	Are the settings retained even after the camera is turned off?	—	All settings except the self-timer and the exposure correction are retained even after the camera is turned off.
	Which resolution setting should I use?	—	Select the resolution setting according to the intended use: <u>3.2M</u> : Appropriate for printing letter-size or larger, and for printing a close-up of part of a photo (trimming). <u>2.0M</u> : For printing standard photo (photo service) sizes. <u>0.3M</u> : For photos displayed on a web page, or sent as e-mail attachments.

COMMONLY ASKED QUESTIONS

	Question	Cause	Action
Shooting	What is the difference between the digital zoom and the optical zoom?	—	Because shooting with the optical zoom uses the optics of a physical lens, you can shoot without losing minute details in the image. The digital zoom, on the other hand, works by magnifying a portion of the image that hits the CCD sensor and may produce a coarser image.
	How can I get the distant view into focus?	—	Set the scene select function to the landscape  mode when photographing.
	The video clip I shot outdoors is completely white.	—	Set the flicker-reduction setting to off  .
	Why does the resolution setting automatically change to  when the scene select function is set to  or the filter is set to  .	The resolution setting is fixed at  when the scene select function is set to  or the filter is set to  .	Not a malfunction.

	Question	Cause	Action
Shooting	Why does the flash setting automatically change to  when the scene select function is set to  or the filter is set to  ?	The flash setting is fixed at  when the scene select function is set to  or the filter is set to  .	Not a malfunction.
	Why doesn't the digital zoom work when the filter is set to  or  ?	The digital zoom is deactivated in these filter modes.	Not a malfunction.
LCD monitor Monitor	When used in cold weather, why does the image seem to leave traces as it moves?	Condition due to the liquid crystals.	Not a malfunction. Spots that appear in the LCD monitor only appear in the monitor and will not be recorded with the images.
	Why does the displayed image contain some red, blue and green dots, or black spots are visible?		
Viewing images	Why is the image too bright?	The subject was too bright.	When capturing an image, devise a way to compensate for a bright subject, for example, by changing the shooting angle.

COMMONLY ASKED QUESTIONS

	Question	Cause	Action
Viewing images	Why is the image out of focus?	The focus is not locked properly.	Hold the camera correctly and slowly press the still image shooting button halfway to lock the focus. Then press the still image shooting button all the way to capture the image.
	Why is a part of the image missing?	The image was captured at close range.	When capturing an image at close range, compose the image using the LCD monitor.
	Why is there no image (ⓧ is shown)?	This may happen when trying to play back images stored on a card from a different digital camera.	Play back images that were recorded on a card using this camera.
	Why do vertical stripes appear?	If a bright subject is shot in the video clip shooting mode, vertical stripes may appear on the LCD monitor or in the image.	Not a malfunction.
	Why isn't the magnified image clear?	Due to the characteristics of the camera, magnified images appear less clear.	Not a malfunction.

	Question	Cause	Action
Viewing images	Why isn't the captured image clear?	The image was captured using the digital zoom.	Not a malfunction.
	Can I play back image and sound data that I edited using my computer?	—	We cannot guarantee the accurate playback of data that has been edited using a computer.
	Why is there a motor-like sound during video clip playback?	The sound of the camera's mechanical action was recorded.	Not a malfunction.
Connecting to a TV	Why is there no sound?	The volume on the TV is set to the minimum.	Adjust the volume on the TV.
		The volume of the camera is set to 0.	Increase the playback volume of the camera.
Printing	Why does a message appear during PictBridge printing?	There is a problem with the printer.	Please refer to the instruction manual for your printer.
Image editing	The "CAN NOT EDIT VIDEO" message appears.	You have attempted to join video clips having different resolutions or frame rates.	Select video clips that have the same resolution or frame rates.

COMMONLY ASKED QUESTIONS

	Question	Cause	Action
Misc.	Why is a noise heard from a nearby TV or radio during battery recharging?	Electromagnetic waves are emitted from the AC adapter/charger.	Move the AC adapter/charger further away from the TV or radio when recharging batteries.
	Why does the "CARD FULL" message appear?	There is no more available memory on the card.	Erase unnecessary data. Use a card that has more memory available.
	Why does the "CARD IS PROTECTED" message appear?	The lock switch on the card is in the locked (protect) position.	Move the lock switch to the unlocked position.
	Why can't the camera be operated?	A temporary internal circuitry problem may be the cause.	Remove the battery pack from the camera, wait a few minutes, then reinstall the battery pack and try again.
	Can I use my camera abroad?	—	When the camera is connected to a TV, you can switch the camera's video output to NTSC or PAL. If you have questions about using the AC adapter/charger and power cord abroad, please consult with a dealer near you for advice.

	Question	Cause	Action
Misc.	Why does the "SYSTEM ERROR" message appear?	A problem has occurred within the camera or card.	<p>Check the following items</p> <ol style="list-style-type: none"> ① Remove the card and then install it again. ② Remove the batteries and then install them again. ③ Install a different card. <p>If "SYSTEM ERROR" still appears after performing the above steps, then take the camera to the dealer for service.</p>

TROUBLESHOOTING

Before taking your camera to the repair shop, check the following table for a possible solution to the problem.

CAMERA

	Problem	Cause	Action	Reference page
Power	No power.	The battery pack is dead.	Recharge the battery pack, or replace with a new battery pack.	34, 35
		The battery pack has not been inserted correctly.	Reinsert the battery pack, making sure to orient it correctly.	
	The camera turns off by itself.	The power save function is operating.	Press one of the operation buttons once.	38
	The camera is set in the docking station, but it does not recharge.		If a battery pack is set in the AC adapter/charger, the battery pack in the AC adapter/charger is recharged first, after which the battery pack in the camera starts to recharge. To speed up recharging of a battery pack, set it in the AC adapter/charger.	—

	Problem	Cause	Action	Reference page
Shoot- ing	An image is not captured when the still image shooting button or video clip recording button is pressed.	The power is not turned on.	When the power save function is active, after pressing one of the buttons to turn on the camera, if the shooting power is off, press the ON/OFF button to turn it on.	38
	An image is not captured when the still image shooting button or video clip recording button is pressed.	The maximum number of images that can be captured or the maximum video clip recording time has been reached.	Install a new card.	36
			Erase the images that are not necessary. Save the images to separate media, then erase all the images from the card.	75, 129
	The flash does not operate.	The flash off mode is selected.	Set the flash to automatic flash mode or forced flash mode.	60
	The flash does not operate.	The battery pack is dead.	Recharge the battery pack, or replace with a new battery pack.	34, 35
		The lamp mode  is active.	Set to a different mode.	58
A warning tone (beep-beep-beep) sounds, and it is not possible to take a picture using the self-timer.	The battery pack is consumed.	Install a sufficiently recharged battery pack.	34, 35	

TROUBLESHOOTING

	Problem	Cause	Action	Reference page
Shooting	When zooming in or out, the zoom movement stops momentarily.	The optical zoom has moved to the maximum magnification position.	Not a malfunction. Release the zoom switch, and press it again.	61
	There is noise in the captured image.	The ISO sensitivity setting is too high.	Set the ISO sensitivity to a lower setting.	84
LCD monitor	No playback image appears.	The main switch is not set to PLAY.	Set the main switch to PLAY.	64
Viewing images	The image is too dark.	The flash was blocked by a finger or other object.	Hold the camera correctly, and make sure the flash is not obstructed.	44
		The subject was too far away.	Capture the image in the range of operation of the flash.	165
		The subject was lit from behind.	Use the forced flash mode.	60
			Use the exposure correction function.	86
		There is not enough light.	Adjust the ISO sensitivity setting.	84
	The video clip picture is flickering.	The video clip was filmed under fluorescent lighting.	Set the flicker-reduction setting to on.	83
	The image is too bright.	The forced flash mode is selected.	Select a different flash mode.	60
		The subject was too bright.	Use the exposure correction function.	86
		The ISO sensitivity setting is incorrect.	Set the ISO sensitivity to ISO-A .	84

	Problem	Cause	Action	Reference page
Viewing images	The image is not in focus.	The subject is too close to the camera.	Select the correct focus setting for your needs.	82
		The focus setting is not correct.		
		The camera moved when the still image shooting button was pressed.	Hold the camera correctly and slowly press the still image shooting button halfway to lock the focus. Then press the still image shooting button all the way to capture the image.	44, 48
		The focus is not locked properly.		
	The colors of the images captured indoors are not correct.	The lens is dirty.	Clean the lens.	22
		This is due to ambient lighting.	Capture the image using the forced flash mode.	60
	A part of the image is missing.	The white balance setting is incorrect.	Set the white balance setting correctly.	85
		The handstrap or a finger was blocking the lens or lens opening.	Hold the camera correctly, and make sure the lens is not obstructed.	44
	"NO IMAGE" is shown.	There is no recorded data for the selected playback mode.	Play back after capturing images or making audio recordings.	47
	During audio playback, there is no sound.	The volume setting on the camera is too low.	Select the volume icon  and adjust the volume.	71

TROUBLESHOOTING

	Problem	Cause	Action	Reference page
Connecting to a TV	No image or sound.	The digital camera is not correctly connected to the TV.	Follow the instructions to make the connection correctly.	130
		The TV input is not set correctly.	Set the input on the TV to "VIDEO".	
		The TV system setting is not correct.	Set to the correct TV system.	118
	There is no sound.	The volume setting on the camera is too low.	Select the volume icon  and adjust the volume.	71
	The edge of the image is cut off.	This is a characteristic of the TV.	Not a malfunction.	129
Image editing	You cannot edit or rotate an image.	The protect mode is set.	Cancel the protect mode.	73
Misc.	The "NO CARD" message appears.	No card is inserted.	Turn off the power and insert a card.	36
	The "PROTECTED" message appears and the data cannot be erased.	You have attempted to erase data that is protected from accidental erasure.	Set the protect setting for the data to OFF.	73
	The audio guide does not sound.	The audio guide setting is set to "OFF".	Set the audio guide setting to "ON".	107, 109





DOCKING STATION

	Problem	Cause	Action	Reference page
Remote control unit	The remote control unit does not seem to work.	The remote control unit is aimed at the TV (not at the docking station).	Aim the remote control unit at the remote control sensor on the docking station (within a range of about 30 degrees horizontally from the docking station).	132 – 136
		Something is obstructing the space between the remote control unit and the remote control sensor on the docking station.	Remove or move the obstructing object.	
		The remote control unit battery is consumed.	Replace with a new battery.	
		The remote control unit battery is not correctly inserted.	Take care that the (+) and (-) poles are correctly oriented.	
		The remote control unit is too far from the remote control sensor on the docking station.	Operate the remote control unit from a position up to 7 meters from the docking station.	
		The remote control codes for the remote control unit and the docking station are different.	Change the remote control code.	136

SPECIFICATIONS

Camera

Type	Digital movie (recording and playback)
Recorded image file format	Still images: JPEG format (DCF, DPOF, Exif 2.2 compliant) Note: Designed mainly by the Japan Electronics and Information Technology Industries Association (JEITA), DCF (Design rules for camera file system) is standard for digital still camera image files to provide interoperability between digital photography devices for the images stored on removable memory cards. However, it is not guaranteed that all devices will support the DCF standard. Video clips: Conforms to ISO-standard MPEG-4 format Audio: MPEG-4 audio (AAC compression) 48 kHz sampling rate, 16-bit stereo format
Data storage media	SD Memory Card
Camera effective number of pixels	Approx. 3,200,000 pixels
Image sensor	1/2.7-inch CCD Virtual number of pixels: Approx. 3,340,000 pixels, interlace scan, primary color filter
Recording resolution	2,048 x 1,536 pixels (still images only) 1,600 x 1,200 pixels (still images only) 640 x 480 pixels 320 x 240 pixels (video clips only) 176 x 144 pixels (video clips only)
Video clip frame rate	30 fps, 15 fps

Data compression (video clips only)	 : 640 x 480 pixels, 30 fps: 3 Mbps  : 640 x 480 pixels, 30 fps: 2 Mbps  : 320 x 240 pixels, 30 fps: 640 kbps  : 320 x 240 pixels, 15 fps: 384 kbps  : 176 x 144 pixels, 15 fps: 256 kbps * The 30 fps frame rate of this camera is 29.97 fps, and the 15 fps frame rate is 29.97/2.	
White balance	Full-auto TTL, manual setting possible	
Lens	Optical 5.8x zoom lens	f=5.8 mm to 33.8 mm (35 mm film camera conversion f=38 mm to 220 mm) Autofocus, 8 groups, 11 elements (including two with three aspheric surfaces) Galvanometer iris Internal ND filter
Aperture	Open F=3.5 (Wide) to 3.7 (Tele) Smallest F=8.0 (Wide) to 8.4 (Tele)	
Exposure control type	Programmable AE Exposure correction available from the Shooting Setting Screen (0±1.8EV in 0.3EV steps)	
Light-measuring mode	Multi-section measuring	
Range	Total mode: 10 cm to infinity (Wide end) 80 cm to infinity (Tele end) Normal mode: 80 cm to infinity Super Macro mode: 2 cm to 60 cm (Wide end only)	
Digital zoom	For shooting: 1x to approx. 10x For playback: 1x to 32x (varies with resolution)	

SPECIFICATIONS

Shutter Speed	Still image shooting mode: 1/2 to 1/2,000 sec. (During flash: 1/30 to 1/60 sec.) Video clip shooting mode: 1/30 to 1/10,000 sec.	
Sensitivity	Still image shooting mode: Auto (equivalent to ISO50 to 200)/equivalent to ISO50, ISO100, ISO200, and ISO400 (switchable from Shooting Setting Screen) (Maximum ISO sensitivity up to 1600 variation: when scene select function is set to lamp ) Video clip shooting mode: Auto (equivalent to ISO200 to 800)/equivalent to ISO200, ISO400, ISO800, and ISO1600 (switchable from Shooting Setting Screen)	
LCD monitor	1.5-inch low-temperature polysilicon TFT color liquid crystal display, translucent Approx. 110,000 pixels (Frame coverage: Approx. 100% when the AV cable is not connected)	
Flash working range	GN = 3 (Approx. 10 cm to 1.2 m (Wide) Approx. 80 cm to 1.1 m (Tele)	
Flash modes	Auto-flash, forced flash, flash off	
Focus	TTL-type AF	
Self-timer	2-second delay, 10-second delay	
Time/date	Recorded with image data	
Ambient environment	Temperature	0 to 40°C (operation), -20 to 60°C (storage)
	Humidity	30 to 90% (operating, no condensation) 10 to 90% (storage, no condensation)
Power supply	Battery pack	Li-ion battery pack (DB-L20) x 1
Dimensions (excluding protrusions)	69 (W) x 108 (H) x 34 (D) mm (Maximum dimensions) Volume: Approx. 149 cc	
Weight	Approx. 155 g (Only the camera (without battery pack and card))	

Camera connectors

DIGITAL/AV (communication/ sound and image output) terminal	Regrouped jack	
	Audio output	265 mVrms (-9 dBs), 12 k Ω or less, stereo
	Video output	1.0 Vp-p, 75 Ω unbalanced, sync negative, composite video, NTSC color TV system/PAL TV system (switchable from the Option Setting Screen)
	USB	USB 2.0 (Full speed)
DC IN (external DC power input) terminal	DC 4.7 V (for exclusive use with the supplied AC adapter/charger)	

Battery pack operation

Shooting	Video clip recording mode 60 minutes: Recorded in TV-S mode (320x240 pixels, 30 fps)
	Still image shooting mode 160 images: LCD monitor on, images captured at 20-second intervals, and flash used 1 in 3 times
Playback	130 minutes: LCD monitor on, continuous playback

- Until battery pack runs out when using a fully charged battery pack at a 20°C ambient temperature.
- The operation time may vary depending on the conditions of the battery pack and the conditions of use. Especially when used at temperatures below 10°C, the battery pack operation time is drastically reduced.

SPECIFICATIONS

Possible No. of Images/Possible Shooting Time/Possible Recording Time

The table shows the possible number of images, the possible shooting time, and the possible recording time for the supplied 128MB SD Memory Card, and for the commercially available 512MB/16MB SD Memory Card.

Shooting/ recording mode	Reso- lution setting	SD Memory Card		
		128MB	512 MB	16 MB
Still image mode	3.2M	122 images	491 images	14 images
	2.0M	195 images	785 images	22 images
	0.3M	978 images	3,920 images	112 images
Video clip mode	TV-SHQ	5 min. 14 sec.	21 min. 2 sec.	35 sec.
	TV-HQ	7 min. 37 sec.	30 min. 39 sec.	52 sec.
	TV-S	20 min. 10 sec.	1 hr. 21 min.	2 min. 18 sec.
	Web-HQ	29 min. 11 sec.	2 hr. 3 min.	3 min. 31 sec.
	Web-S	37 min. 36 sec.	2 hr. 42 min.	4 min. 36 sec.
Sound recording mode	—	2 hr. 9 min.	8 hr. 40 min.	14 min. 27 sec.

- Even with cards of the same capacity, the amount of data that can actually be stored may differ depending on the card brand, etc.
- The continuous shooting time for each video clip will differ depending, for example, on the card capacity, environmental conditions (temperature and shooting conditions, etc.).

Docking station

Part number	PDS-C1	
Power supply	DC 4.7 V	
Rated output	DC 4.2 V/4.7 V	
Compatible batteries	Supplied or separately sold Li-ion battery pack (DB-L20)	
Ambient environment	Temperature	0 to 40°C (recharge), -20 to 60°C (storage)
	Humidity	10 to 85% (no condensation)
Dimensions	94 (W) x 35.5 (H) x 94 (D) mm	
Weight	Weight (without power cord) Approx. 74 g	
Power cord rated value	AC 125 V, 3 A	

- When using the supplied AC adapter/charger abroad, the power cord may need to be replaced in accordance with local requirements. Please contact your local dealer for details.

Remote control unit

Part number	BRC-C1
Power supply	Lithium battery (CR2025)
Dimensions	35 (W) x 56.6 (H) x 6.5 (D) mm
Weight	Approx. 15 g (including battery)

SPECIFICATIONS

Supplied AC adapter/charger

Part number	VAR-AL20	
Power supply	AC 100 V to 240 V, 50/60 Hz, 0.27 A to 0.17 A, 23 VA to 32 VA	
Rated output	DC 4.2 V, 0.6 A (charging) DC 4.7 V, 2.0 A (DC output)	
Compatible battery	Supplied or sold separately Li-ion battery pack DB-L20	
Ambient environment	Temperature	0 to 40°C (operation), -20 to 60°C (storage)
	Humidity	20 to 80% (no condensation)
Dimensions	60 (W) x 33 (H) x 90 (D) mm	
Weight	Approx. 175 g	

Supplied Li-ion battery pack

Part number	DB-L20	
Voltage	3.7 V	
Rated output	720 mAh	
Ambient environment	Temperature	0 to 40°C (during use, recharged) -10 to 30°C (storage)
	Humidity	10 to 90% (no condensation)
Dimensions	39.4 (W) x 6.0 (H) x 35.5 (D) mm	
Weight	Approx. 19 g	

Supplied SD Memory Card

Memory capacity		128MB
Ambient environment	Temperature	0 to 55°C
	Humidity	20 to 85%
Dimensions		32 (H) x 24 (W) x 2.1 (D) mm
Weight		Approx. 2 g

SPECIFICATIONS

Others

Apple, Macintosh and QuickTime are trademarks or registered trademarks of Apple Computer Inc.

Windows and Windows NT are registered trademarks of Microsoft Corporation. All other company and product names are registered trademarks or trademarks of their respective owners.

Caution

- It is forbidden to copy this manual, whole or in part, without prior written permission.
- All images and illustrations given in this manual are for explanation purposes and may differ slightly from that of the actual product. Also, actual specifications are subject to change without prior notice and therefore may differ from the contents of this manual.
- Sanyo Electric shall not be held responsible for any problems resulting from the use of this camera.
- Sanyo Electric declines all responsibility for damages due to improper use of the camera, failure to adhere to the instructions given in this manual, or repairs or changes done by those other than a technician authorized by the manufacturer.
- Sanyo Electric shall not be held responsible for any damage caused by optional devices or consumable items used with the camera other than those supplied with the camera or those specified by Sanyo Electric.
- Sanyo Electric shall not be held responsible for any losses or loss of revenue resulting from the loss of data caused by the malfunction, or the repairing of a malfunction, of the camera.
- The images captured with this camera will differ in quality from pictures taken with a standard film camera.

MEMO

A series of horizontal dashed lines providing a template for writing a memo.

Printed on recycled paper

1AG6P1P1704--

SX610EX (100K) (P)

The SANYO logo consists of the word "SANYO" in a bold, sans-serif font. The letter "Y" is stylized with several vertical lines of varying lengths passing through it, creating a sense of motion or a digital signal.

SANYO Electric Co., Ltd.
Downloaded from www.Somanuals.com. All Manuals Search and Download.

Free Manuals Download Website

<http://myh66.com>

<http://usermanuals.us>

<http://www.somanuals.com>

<http://www.4manuals.cc>

<http://www.manual-lib.com>

<http://www.404manual.com>

<http://www.luxmanual.com>

<http://aubethermostatmanual.com>

Golf course search by state

<http://golfingnear.com>

Email search by domain

<http://emailbydomain.com>

Auto manuals search

<http://auto.somanuals.com>

TV manuals search

<http://tv.somanuals.com>