

# TECHNICAL DATA & SERVICE MANUAL

# SANYO

FILE NO.

XH2442 / CH2442    KH2442 / CH2442  
XH3642 / CH3642    KH3642 / CH3642  
XH4242 / CH4242

TH2442 / CH2442    UH2442 / CH2442  
TH3642 / CH3642    UH3642 / CH3642  
TH4242 / CH4242

## SPLIT SYSTEM AIR CONDITIONER

INDOOR MODEL No.	PRODUCT CODE No.
XH2442	854 017 11
XH3642	854 017 12
XH4242	854 017 13
TH2442	854 017 14
TH3642	854 017 15
TH4242	854 017 16
KH2442	854 017 07
KH3642	854 017 08
UH2442	854 017 19
UH3642	854 017 20

OUTDOOR MODEL No.	PRODUCT CODE No.
CH2442	854 017 21
CH3642	854 017 22
CH4242	854 017 23

### Indoor Unit

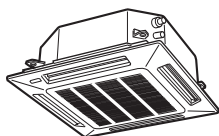

XH2442

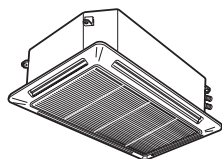

XH3642  
XH4242

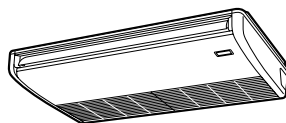

TH2442  
TH3642  
TH4242

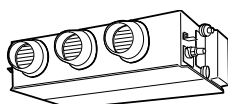

UH2442

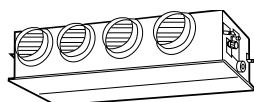

UH3642

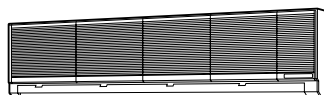

KH2442  
KH3642

### Outdoor Unit

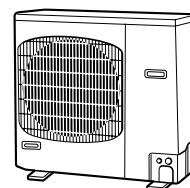

CH2442

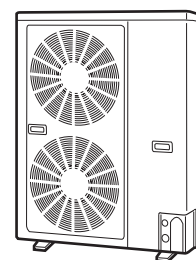

CH3642  
CH4242

Section

1

2

3

4

5

## Important

### Please Read Before Starting

This air conditioning system meets strict safety and operating standards. As the installer or service person, it is an important part of your job to install or service the system so it operates safely and efficiently.

**For safe installation and trouble-free operation, you must :**

- Carefully read this instruction booklet before beginning.
- Follow each installation or repair step exactly as shown.
- Observe all local, state, and national electrical codes.
- Pay close attention to all warning and caution notices given in this manual.



**WARNING**

This symbol refers to a hazard or unsafe practice which can result in severe personal injury or death.



**CAUTION**

This symbol refers to a hazard or unsafe practice which can result in personal injury or product or property damage.

### If Necessary, Get Help

These instructions are all you need for most installation sites and maintenance conditions. If you require help for a special problem, contact our sales/service outlet or your certified dealer for additional instructions.

### In Case of Improper Installation

The manufacturer shall in no way be responsible for improper installation or maintenance service, including failure to follow the instructions in this document.

## SPECIAL PRECAUTIONS

### When Wiring



**ELECTRICAL SHOCK CAN CAUSE SEVERE PERSONAL INJURY OR DEATH. ONLY A QUALIFIED, EXPERIENCED ELECTRICIAN SHOULD ATTEMPT TO WIRE THIS SYSTEM.**

- Do not supply power to the unit until all wiring and tubing are completed or reconnected and checked.
- Highly dangerous electrical voltages are used in this system. Carefully refer to the wiring diagram and these instructions when wiring. Improper connections and inadequate grounding can cause **accidentally injury or death**.
- **Ground the unit** following local electrical codes.
- Connect all wiring tightly. Loose wiring may cause overheating at connection points and a possible fire hazard.

### When Transporting

Be careful when picking up and moving the indoor and outdoor units. Get a partner to help, and bend your knees when lifting to reduce strain on your back. Sharp edges or thin aluminum fins on the air conditioner can cut your fingers.

### When Installing

#### ...In a Room

Properly insulate any tubing run inside a room to prevent "sweating" that can cause dripping and water damage to walls and floors.

#### ...In Moist or Uneven Locations

Use a raised concrete pad or concrete blocks to provide a solid, level foundation for the outdoor unit. This prevents water damage and abnormal vibration.

#### ...In an area with High Winds

Securely anchor the outdoor unit down with bolts and a metal frame. Provide a suitable air baffle.

#### ...In a Snowy Area (for Heat Pump-type Systems)

Install the outdoor unit on a raised platform that is higher than drifting snow. Provide snow vents.

### When Connecting Refrigerant Tubing

- Ventilate the room well, in the event that refrigerant gas leaks during the installation. Be careful not to allow contact of the refrigerant gas with a flame as this will cause the generation of poisonous gas.
- Keep all tubing runs as short as possible.
- Use the flare method for connecting tubing.
- Apply refrigerant lubricant to the matching surfaces of the flare and union tubes before connecting them, then tighten the nut with a torque wrench for a leak-free connection.
- Check carefully for leaks before starting the test run.

#### NOTE

Depending on the system type, liquid and gas lines may be either narrow or wide. Therefore, to avoid confusion the refrigerant tubing for your particular model is specified as either "narrow" or "wide" rather than as "liquid" or "gas".

### When Servicing

- Turn the power OFF at the main power box (mains) before opening the unit to check or repair electrical parts and wiring.
- Keep your fingers and clothing away from any moving parts.
- Clean up the site when installation is finished. Check that no metal scraps or bits of wiring have been left inside the unit.



**CAUTION**

- Ventilate any enclosed areas when installing or testing the refrigeration system. Contact of refrigerant gas with fire or heat can produce poisonous gas.
- Confirm after installation that no refrigerant gas is leaking. If the gas comes in contact with a burning stove, gas water heater, electric room heater or other heat source, it can cause the generation of poisonous gas.

# WHO SHOULD USE THIS MANUAL

This service manual is made to assist the service technician apply his knowledge and training to this model air conditioner. This manual is written both for **experienced service persons** and **those who are new** to air conditioning service. To help those with less experience or who are new to this kind of unit we have included more explanations of basic procedures in simple language than is usual in some service manuals. The **experienced technician** will of course find he knows many of these things already and can go directly to the procedures and information he needs; the less experienced technician will better understand what to do even before he arrives on the job, and therefore be better able to work by himself as well as assist the more experienced technician.

## TABLE OF CONTENTS

<b>1. SPECIFICATIONS</b> .....	I - 1
1-1 Unit Specifications .....	I - 2
1-2 Major Component Specifications .....	I - 12
(A) Indoor Units .....	I - 12
(B) Outdoor Units .....	I - 22
1-3 Other Component Specifications .....	I - 25
1-4 Dimensional Data .....	I - 38
(A) Indoor Units .....	I - 38
(B) Outdoor Units .....	I - 47
1-5 Refrigerant Flow Diagram .....	I - 49
1-6 Operating Range .....	I - 50
1-7 Cooling Capacity .....	I - 51
1-8 Heating Capacity .....	I - 71
1-9 Performance Charts.....	I - 72
1-10 Noise Criterion Curves.....	I - 90
1-11 Increasing the Fan Speed.....	I - 95
1-12 Air throw Distance Chart.....	I - 96
1-13 Installation Instructions .....	I - 99
<b>2. PROCESSES AND FUNCTIONS</b> .....	II - 1
2-1 Room Temperature Control .....	II - 2
2-2 Cold Draft Prevention (Heating Cycle).....	II - 4
2-3 Automatic Fan Speed (Indoor Unit) .....	II - 5
2-4 Outdoor Fan Speed Control .....	II - 6
2-5 Freeze Prevention (Cooling) .....	II - 7
2-6 Condensing Temperature Control (Cooling) .....	II - 8

2-7	Overload Protection (Heating) .....	II - 9
2-8	Discharge Temperature Control (Cooling and Heating) .....	II - 10
2-9	Auto. Mode for Automatic Heating/Cooling Switching .....	II - 11
2-10	Defrosting Control, Outdoor Heat Exchanger Coil (Heating) .....	II - 13
2-11	4-Way Valve, Solenoid Control .....	II - 14
2-12	Automatic Restart after Power Interruption .....	II - 15
2-13	Electronic Expansion Control Valve .....	II - 16
2-14	Compressor Discharge Gas Temperature .....	II - 16
2-15	Compressor Current Detection Circuit .....	II - 17
2-16	Electronic Expansion Valve .....	II - 18
2-17	Voltage Detection Control .....	II - 19
<b>3.</b>	<b>ELECTRICAL DATA</b> .....	<b>III - 1</b>
3-1	Indoor Unit (Electric Wiring Diagram, Schematic Diagram) .....	III - 2
3-2	Outdoor Unit (Electric Wiring Diagram, Schematic Diagram) .....	III - 12
<b>4.</b>	<b>SERVICE PROCEDURES</b> .....	<b>IV - 1</b>
4-1	Troubleshooting .....	IV - 2
4-2	Checking the Electrical Components .....	IV - 30

# 1. SPECIFICATIONS

1-1	Unit Specifications .....	I - 2
	4-Way Air Discharge Semi-concealed Type .....	I - 2
	Ceiling Mounted Type .....	I - 5
	Concealed Duct Type .....	I - 8
	Wall-Mounted Type .....	I - 10
1-2	Major Component Specifications .....	I - 12
	(A) Indoor Units .....	I - 12
	(B) Outdoor Units .....	I - 22
1-3	Other Component Specifications .....	I - 25
	4-Way Air Discharge Semi-concealed Type .....	I - 25
	Ceiling Mounted Type .....	I - 28
	Concealed Duct Type .....	I - 31
	Wall-Mounted Type .....	I - 33
	Outdoor Units .....	I - 35
1-4	Dimensional Data .....	I - 38
	(A) Indoor Units .....	I - 38
	4-Way Air Discharge Semi-concealed Type .....	I - 38
	Ceiling Mounted Type .....	I - 40
	Concealed Duct Type .....	I - 42
	Wall-Mounted Type .....	I - 45
	(B) Outdoor Units .....	I - 47
1-5	Refrigerant Flow Diagram .....	I - 49
1-6	Operating Range .....	I - 50
1-7	Cooling Capacity .....	I - 51
1-8	Heating Capacity .....	I - 71
1-9	Performance Charts .....	I - 72
	(1) Operating Current .....	I - 72
	(2) Operating Pressure .....	I - 84
1-10	Noise Criterion Curves .....	I - 90
1-11	Increasing the Fan Speed .....	I - 95
1-12	Air throw distance chart .....	I - 96
1-13	Installation Instructions .....	I - 99
	Tubing Length .....	I - 99
	SELECTING THE INSTALLATION SITE .....	I - 100
	ELECTRICAL WIRING .....	I - 104
	Electrical characteristics .....	I - 108

1-1 Unit Specifications

MODEL No.		Indoor Unit		XH2442			
		Outdoor Unit		CH2442			
<b>POWER SOURCE</b>				230 - 208 V / 1 Phase / 60 Hz			
<b>PERFORMANCE</b>				<b>Cooling</b>		<b>Heating</b>	
Capacity*	(17°F)**	BTU / h	24,000	23,400	25,000 16,400	24,300 15,800	
Moisture removal (High)		Pints / h	8.6	8.4	—		
Air circulation (H / M / L)	230 V	cu.ft. / min.	710 / 530 / 450				
S.E.E.R. (H.S.P.F.)		BTU / Wh	10.0	10.2	(7.0)	(7.0)	
<b>ELECTRICAL RATINGS</b>							
Voltage rating		VAC	230	208	230	208	
Available voltage range		VAC	187 - 253				
Running amperes		A	11.2	11.6	11.7	12.3	
Power input*	(17°F)**	W	2,450	2,350	2,500 2,150	2,450 2,020	
Maximum overcurrent protection		A	25				
<b>FEATURES</b>							
Controls			Microprocessor				
Low ambient control			Built-in 0°F				
Fan speeds Indoor / Outdoor			3 and Automatic control / 3 (Auto)				
Optional Wired Remote Controller (Timer)			RCS-SH80UG (72-hour ON / OFF)				
Optional Wireless Remote Controller (Timer)			RCS-SH80UA. WL / RCS-BH80UA. WL (72-hour ON / OFF)				
Air deflection	Horizontal / Vertical		— / Automatic				
Air filter			Washable, easy access, long life filter (2,500 hr)				
Operation sound	Indoor - Hi / Me / Lo	dB - A	38 / 35 / 31				
	Outdoor - Hi	dB - A	53				
Refrigerant control			Electronic Expansion Control Valve				
<b>REFRIGERANT PIPING</b>							
Limit of piping length		ft. (m)	165 (50)				
Limit of piping length at shipment		ft. (m)	100 (30)				
Limit of elevation difference between the two units		ft. (m)	Outdoor unit is higher than indoor unit: 165 (50) Outdoor unit is lower than indoor unit: 100 (30)				
Refrigerant piping	Narrow pipe	in. (mm)	1 / 4 (6.35)				
Flare pipe type	Wide pipe	in. (mm)	3 / 4 (19.05)				
<b>DIMENSIONS &amp; WEIGHT</b>				Indoor unit		Outdoor unit	
Unit dimensions	Height	in. (mm)	12-1/8	(380)	28-15/16	(735)	
	Width	in. (mm)	30-9/16	(776)	37-1/32	(940)	
	Depth	in. (mm)	30-9/16	(776)	13-3/8	(340)	
Net weight		lbs. (kg)	49	(22)	157	(71)	
Indoor grille dimensions PNR-XHS2432	Height	in. (mm)	3-1/16	(78)	—	—	
	Width	in. (mm)	33-27/32	(860)	—	—	
	Depth	in. (mm)	33-27/32	(860)	—	—	
Net weight		lbs. (kg)	11	(5)	—	—	
Indoor / Outdoor unit Package dimensions	Height	in. (mm)	13-5/16	(338)	32-17/32	(826)	
	Width	in. (mm)	32-7/8	(835)	40	(1,016)	
	Depth	in. (mm)	33-9/32	(845)	16-3/8	(416)	
Shipping weight		lbs. (kg)	57	(26)	170	(77)	
Shipping volume		cu.ft. (m³)	8.4	(0.238)	12.3	(0.349)	
Indoor grille Package dimensions PNR-XHS2432	Height	in. (mm)	4-3/32	(104)	—	—	
	Width	in. (mm)	37-15/16	(964)	—	—	
	Depth	in. (mm)	39-11/32	(999)	—	—	
Shipping weight		lbs. (kg)	18	(8)	—	—	
Shipping volume		cu.ft. (m³)	3.5	(0.100)	—	—	

DATA SUBJECT TO CHANGE WITHOUT NOTICE

Cooling :

Rating conditions (\*) : Room temperature 80 °F DB / 67 °F WB, Ambient temperature 95 °F DB / 75 °F WB

Heating :

Rating conditions (\*) : Room temperature 70 °F DB / 60 °F WB, Ambient temperature 47 °F DB / 43 °F WB

Low temp conditions (\*\*): Room temperature 70 °F DB / 60 °F WB, Ambient temperature 17 °F DB / 15 °F WB

1-1 Unit Specifications

MODEL No.		Indoor Unit		XH3642			
		Outdoor Unit		CH3642			
<b>POWER SOURCE</b>				230 - 208 V / 1 Phase / 60 Hz			
<b>PERFORMANCE</b>				Cooling		Heating	
Capacity*	(17°F)**	BTU / h	34,500	33,500	37,500 25,000	36,500 23,500	
Moisture removal (High)		Pints / h	10.5	10.6	—		
Air circulation (H / M / L)	230 V	cu.ft. / min.	1,050 / 840 / 720				
S.E.E.R. (H.S.P.F.)		BTU / Wh	10.7	11.0	(7.0)	(7.0)	
<b>ELECTRICAL RATINGS</b>							
Voltage rating		VAC	230	208	230	208	
Available voltage range		VAC	187 - 253				
Running amperes		A	15.4	15.8	18.2	19.3	
Power input*	(17°F)**	W	3,350	3,200	3,850 3,150	3,750 2,950	
Maximum overcurrent protection		A	40				
<b>FEATURES</b>							
Controls			Microprocessor				
Low ambient control			Built-in 0°F				
Fan speeds Indoor / Outdoor			3 and Automatic control / 3 (Auto)				
Optional Wired Remote Controller (Timer)			RCS-SH80UG (72-hour ON / OFF)				
Optional Wireless Remote Controller (Timer)			RCS-SH80UA. WL / RCS-BH80UA. WL (72-hour ON / OFF)				
Air deflection	Horizontal / Vertical		— / Automatic				
Air filter			Washable, easy access, long life filter (2,500 hr)				
Operation sound	Indoor - Hi / Me / Lo	dB - A	44 / 37 / 33				
	Outdoor - Hi	dB - A	56				
Refrigerant control			Electronic Expansion Control Valve				
<b>REFRIGERANT PIPING</b>							
Limit of piping length		ft. (m)	165 (50)				
Limit of piping length at shipment		ft. (m)	100 (30)				
Limit of elevation difference between the two units		ft. (m)	Outdoor unit is higher than indoor unit: 165 (50) Outdoor unit is lower than indoor unit: 100 (30)				
Refrigerant piping Flare type	Narrow pipe	in. (mm)	3 / 8 (9.52)				
	Wide pipe	in. (mm)	3 / 4 (19.05)				
<b>DIMENSIONS &amp; WEIGHT</b>				Indoor unit		Outdoor unit	
Unit dimensions	Height	in. (mm)	14-1/2	(368)	48-5/8	(1,235)	
	Width	in. (mm)	41-31/32	(1,066)	37-1/32	(940)	
	Depth	in. (mm)	30-9/16	(776)	13-3/8	(340)	
Net weight		lbs. (kg)	60	(27)	203	(92)	
Indoor grille dimensions PNR-XHS2432	Height	in. (mm)	3-1/16	(78)	—		
	Width	in. (mm)	45-9/32	(1,150)	—		
	Depth	in. (mm)	33-27/32	(860)	—		
Net weight		lbs. (kg)	15	(7)	—		
Indoor / Outdoor unit Package dimensions	Height	in. (mm)	14-1/2	(368)	52-7/32	(1,326)	
	Width	in. (mm)	44-9/32	(1,125)	40	(1,016)	
	Depth	in. (mm)	33-9/32	(845)	16-3/8	(416)	
Shipping weight		lbs. (kg)	71	(32)	227	(103)	
Shipping volume		cu.ft. (m³)	12.4	(0.35)	19.8	(0.56)	
Indoor grille Package dimensions PNR-XHS2432	Height	in. (mm)	4-3/32	(104)	—		
	Width	in. (mm)	49-1/2	(1,257)	—		
	Depth	in. (mm)	39-11/32	(999)	—		
Shipping weight		lbs. (kg)	22	(10)	—		
Shipping volume		cu.ft. (m³)	4.6	(0.131)	—		

DATA SUBJECT TO CHANGE WITHOUT NOTICE

Cooling :

Rating conditions (\*) : Room temperature 80 °F DB / 67 °F WB, Ambient temperature 95 °F DB / 75 °F WB

Heating :

Rating conditions (\*) : Room temperature 70 °F DB / 60 °F WB, Ambient temperature 47 °F DB / 43 °F WB

Low temp conditions (\*\*): Room temperature 70 °F DB / 60 °F WB, Ambient temperature 17 °F DB / 15 °F WB

## 1-1 Unit Specifications

MODEL No.		Indoor Unit		XH4242			
		Outdoor Unit		CH4242			
<b>POWER SOURCE</b>				230 - 208 V / 1 Phase / 60 Hz			
<b>PERFORMANCE</b>				Cooling		Heating	
Capacity*	(17°F)**	BTU / h	42,000	40,000	44,000 28,000	42,000 26,000	
Moisture removal (High)		Pints / h	14.4	14.0	—		
Air circulation (H / M / L)	230 V	cu.ft. / min.	1,050 / 840 / 720				
S.E.E.R. (H.S.P.F.)		BTU / Wh	10.4	10.4	(7.0)	(7.0)	
<b>ELECTRICAL RATINGS</b>							
Voltage rating		VAC	230	208	230	208	
Available voltage range		VAC	187 - 253				
Running amperes		A	20.6	21.0	21.7	22.2	
Power input*	(17°F)**	W	4,200	4,100	4,450 3,700	4,350 3,550	
Maximum overcurrent protection		A	45				
<b>FEATURES</b>							
Controls		Microprocessor					
Low ambient control		Built-in 0°F					
Fan speeds Indoor / Outdoor		3 and Automatic control / 3 (Auto)					
Optional Wired Remote Controller (Timer)		RCS-SH80UG (72-hour ON / OFF)					
Optional Wireless Remote Controller (Timer)		RCS-SH80UA. WL / RCS-BH80UA. WL (72-hour ON / OFF)					
Air deflection		Horizontal / Vertical		— / Automatic			
Air filter		Washable, easy access, long life filter (2,500 hr)					
Operation sound	Indoor - Hi / Me / Lo Outdoor - Hi	dB - A dB - A	45 / 38 / 34 56				
Refrigerant control		Electronic Expansion Control Valve					
<b>REFRIGERANT PIPING</b>							
Limit of piping length		ft. (m)	165 (50)				
Limit of piping length at shipment		ft. (m)	100 (30)				
Limit of elevation difference between the two units		ft. (m)	Outdoor unit is higher than indoor unit: 165 (50) Outdoor unit is lower than indoor unit: 100 (30)				
Refrigerant piping Flare type	Narrow pipe Wide pipe	in. (mm) in. (mm)	3 / 8 (9.52) 3 / 4 (19.05)				
<b>DIMENSIONS &amp; WEIGHT</b>				Indoor unit		Outdoor unit	
Unit dimensions	Height	in. (mm)	14-1/2	(368)	48-5/8	(1,235)	
	Width	in. (mm)	41-31/32	(1,066)	37-1/32	(940)	
	Depth	in. (mm)	30-9/16	(776)	13-3/8	(340)	
Net weight		lbs. (kg)	60	(27)	203	(92)	
Indoor grille dimensions PNR-XHS2432	Height	in. (mm)	3-1/16	(78)	—		
	Width	in. (mm)	45-9/32	(1,150)	—		
	Depth	in. (mm)	33-27/32	(860)	—		
Net weight		lbs. (kg)	15	(7)	—		
Indoor / Outdoor unit Package dimensions	Height	in. (mm)	14-1/2	(368)	52-7/32	(1,326)	
	Width	in. (mm)	44-9/32	(1,125)	40	(1,016)	
	Depth	in. (mm)	33-9/32	(845)	16-3/8	(416)	
Shipping weight		lbs. (kg)	71	(32)	227	(103)	
Shipping volume		cu.ft. (m³)	12.4	(0.35)	19.8	(0.56)	
Indoor grille Package dimensions PNR-XHS2432	Height	in. (mm)	4-3/32	(104)	—		
	Width	in. (mm)	19-1/2	(1,257)	—		
	Depth	in. (mm)	39-11/32	(999)	—		
Shipping weight		lbs. (kg)	22	(10)	—		
Shipping volume		cu.ft. (m³)	4.6	(0.131)	—		

DATA SUBJECT TO CHANGE WITHOUT NOTICE

Cooling :

Rating conditions (\*) : Room temperature 80 °F DB / 67 °F WB, Ambient temperature 95 °F DB / 75 °F WB

Heating :

Rating conditions (\*) : Room temperature 70 °F DB / 60 °F WB, Ambient temperature 47 °F DB / 43 °F WB

Low temp conditions (\*\*): Room temperature 70 °F DB / 60 °F WB, Ambient temperature 17 °F DB / 15 °F WB



1-1 Unit Specifications

MODEL No.		Indoor Unit		TH2442			
		Outdoor Unit		CH2442			
<b>POWER SOURCE</b>				230 - 208 V / 1 Phase / 60 Hz			
<b>PERFORMANCE</b>				Cooling		Heating	
Capacity*	(17°F)**	BTU / h	22,400	21,600	25,400 15,700	25,000 15,000	
Moisture removal (High)		Pints / h	8.0	7.9	—		
Air circulation (H / M / L)	230 V	cu.ft. / min.	550 / 490 / 460				
S.E.E.R. (H.S.P.F.)		BTU / Wh	10.0	10.0	(7.0)	(7.0)	
<b>ELECTRICAL RATINGS</b>							
Voltage rating		VAC	230	208	230	208	
Available voltage range		VAC	187 - 253				
Running amperes		A	10.7	11.3	11.7	12.9	
Power input*	(17°F)**	W	2,350	2,280	2,550 2,070	2,500 2,040	
Maximum overcurrent protection		A	25				
<b>FEATURES</b>							
Controls		Microprocessor					
Low ambient control		Built-in 0°F					
Fan speeds Indoor / Outdoor		3 and Automatic control / 3 (Auto)					
Optional Wired Remote Controller (Timer)		RCS-SH80UG (72-hour ON / OFF)					
Optional Wireless Remote Controller (Timer)		RCS-SH80UA. WL / RCS-BH80UA. WL (72-hour ON / OFF)					
Air deflection		Horizontal / Vertical	Manual / Automatic				
Air filter		Washable, easy access					
Operation sound	Indoor - Hi / Me / Lo Outdoor - Hi	dB - A dB - A	40 / 38 / 36 53				
Refrigerant control		Electronic Expansion Control Valve					
<b>REFRIGERANT PIPING</b>							
Limit of piping length		ft. (m)	165 (50)				
Limit of piping length at shipment		ft. (m)	100 (30)				
Limit of elevation difference between the two units		ft. (m)	Outdoor unit is higher than indoor unit: 165 (50) Outdoor unit is lower than indoor unit: 100 (30)				
Refrigerant piping Flare type	Narrow pipe Wide pipe	in. (mm) in. (mm)	1 / 4 (6.35) 3 / 4 (19.05)				
<b>DIMENSIONS &amp; WEIGHT</b>				Indoor unit		Outdoor unit	
Unit dimensions	Height	in. (mm)	7-15/32	(190)	28-15/16	(735)	
	Width	in. (mm)	51-3/16	(1,300)	37-1/32	(940)	
	Depth	in. (mm)	26-3/8	(670)	13-3/8	(340)	
Indoor grille dimensions	Height	in. (mm)	9-7/16	(240)	32-17/32	(826)	
	Width	in. (mm)	54-19/32	(1,387)	40	(1,016)	
	Depth	in. (mm)	29-31/32	(761)	16-3/8	(416)	
Net weight		lbs. (kg)	60	(27)	157	(71)	
Shipping weight		lbs. (kg)	77	(35)	170	(77)	
Shipping volume		cu.ft. (m³)	8.9	(0.253)	12.3	(0.349)	

DATA SUBJECT TO CHANGE WITHOUT NOTICE

Cooling :

Rating conditions (\*) : Room temperature 80 °F DB / 67 °F WB, Ambient temperature 95 °F DB / 75 °F WB

Heating :

Rating conditions (\*) : Room temperature 70 °F DB / 60 °F WB, Ambient temperature 47 °F DB / 43 °F WB

Low temp conditions (\*\*): Room temperature 70 °F DB / 60 °F WB, Ambient temperature 17 °F DB / 15 °F WB

## 1-1 Unit Specifications

MODEL No.		Indoor Unit		TH3642			
		Outdoor Unit		CH3642			
<b>POWER SOURCE</b>		230 - 208 V / 1 Phase / 60 Hz					
<b>PERFORMANCE</b>				<b>Cooling</b>		<b>Heating</b>	
Capacity*	(17°F)**	BTU / h	34,000	33,000	40,000 25,000	39,000 24,000	
Moisture removal (High)		Pints / h	10.7	10.8	—		
Air circulation (H / M / L)	230 V	cu.ft. / min.	1,100 / 930 / 750				
S.E.E.R. (H.S.P.F.)		BTU / Wh	10.4	10.7	(7.3)	(7.3)	
<b>ELECTRICAL RATINGS</b>							
Voltage rating		VAC	230	208	230	208	
Available voltage range		VAC	187 - 253				
Running amperes		A	15.1	15.7	18.2	19.6	
Power input*	(17°F)**	W	3,350	3,170	3,950 3,000	3,890 2,900	
Maximum overcurrent protection		A	40				
<b>FEATURES</b>							
Controls			Microprocessor				
Low ambient control			Built-in 0°F				
Fan speeds Indoor / Outdoor			3 and Automatic control / 3 (Auto)				
Optional Wired Remote Controller (Timer)			RCS-SH80UG (72-hour ON / OFF)				
Optional Wireless Remote Controller (Timer)			RCS-SH80UA. WL / RCS-BH80UA. WL (72-hour ON / OFF)				
Air deflection	Horizontal / Vertical		Manual / Automatic				
Air filter			Washable, easy access				
Operation sound	Indoor - Hi / Me / Lo	dB - A	46 / 42 / 37				
	Outdoor - Hi	dB - A	56				
Refrigerant control			Electronic Expansion Control Valve				
<b>REFRIGERANT PIPING</b>							
Limit of piping length		ft. (m)	165 (50)				
Limit of piping length at shipment		ft. (m)	100 (30)				
Limit of elevation difference between the two units		ft. (m)	Outdoor unit is higher than indoor unit: 165 (50) Outdoor unit is lower than indoor unit: 100 (30)				
Refrigerant piping Flare type	Narrow pipe	in. (mm)	3 / 8 (9.52)				
	Wide pipe	in. (mm)	3 / 4 (19.05)				
<b>DIMENSIONS &amp; WEIGHT</b>				Indoor unit		Outdoor unit	
Unit dimensions	Height	in. (mm)	9-7/16	(240)	48-5/8	(1,235)	
	Width	in. (mm)	62-1/32	(1,575)	37-1/32	(940)	
	Depth	in. (mm)	26-3/8	(670)	13-3/8	(340)	
Indoor grille dimensions	Height	in. (mm)	12-15/32	(317)	52-7/32	(1,326)	
	Width	in. (mm)	66-1/16	(1,678)	40	(1,016)	
	Depth	in. (mm)	31-1/16	(789)	16-3/8	(416)	
Net weight		lbs. (kg)	90	(41)	203	(92)	
Shipping weight		lbs. (kg)	104	(47)	227	(103)	
Shipping volume		cu.ft. (m <sup>3</sup> )	14.8	(0.42)	19.8	(0.56)	

DATA SUBJECT TO CHANGE WITHOUT NOTICE

Cooling :

Rating conditions (\*) : Room temperature 80 °F DB / 67 °F WB, Ambient temperature 95 °F DB / 75 °F WB

Heating :

Rating conditions (\*) : Room temperature 70 °F DB / 60 °F WB, Ambient temperature 47 °F DB / 43 °F WB

Low temp conditions (\*\*): Room temperature 70 °F DB / 60 °F WB, Ambient temperature 17 °F DB / 15 °F WB

1-1 Unit Specifications

MODEL No.		Indoor Unit		TH4242			
		Outdoor Unit		CH4242			
<b>POWER SOURCE</b>				230 - 208 V / 1 Phase / 60 Hz			
<b>PERFORMANCE</b>				Cooling		Heating	
Capacity*	(17°F)**	BTU / h	42,000	40,000	44,000 28,000	42,000 26,000	
Moisture removal (High)		Pints / h	14.8	14.3	—		
Air circulation (H / M / L)	230 V	cu.ft. / min.	1,100 / 930 / 750				
S.E.E.R. (H.S.P.F.)		BTU / Wh	10.0	10.4	(7.0)	(7.0)	
<b>ELECTRICAL RATINGS</b>							
Voltage rating		VAC	230	208	230	208	
Available voltage range		VAC	187 - 253				
Running amperes		A	20.6	21.3	21.7	22.5	
Power input*	(17°F)**	W	4,300	4,200	4,450 3,700	4,350 3,550	
Maximum overcurrent protection		A	45				
<b>FEATURES</b>							
Controls		Microprocessor					
Low ambient control		Built-in 0°F					
Fan speeds Indoor / Outdoor		3 and Automatic control / 3 (Auto)					
Optional Wired Remote Controller (Timer)		RCS-SH80UG (72-hour ON / OFF)					
Optional Wireless Remote Controller (Timer)		RCS-SH80UA. WL / RCS-BH80UA. WL (72-hour ON / OFF)					
Air deflection		Horizontal / Vertical	Manual / Automatic				
Air filter		Washable, easy access					
Operation sound	Indoor - Hi / Me / Lo Outdoor - Hi	dB - A dB - A	47 / 43 / 38 56				
Refrigerant control		Electronic Expansion Control Valve					
<b>REFRIGERANT PIPING</b>							
Limit of piping length		ft. (m)	165 (50)				
Limit of piping length at shipment		ft. (m)	100 (30)				
Limit of elevation difference between the two units		ft. (m)	Outdoor unit is higher than indoor unit: 165 (50) Outdoor unit is lower than indoor unit: 100 (30)				
Refrigerant piping Flare type	Narrow pipe Wide pipe	in. (mm) in. (mm)	3 / 8 (9.52) 3 / 4 (19.05)				
<b>DIMENSIONS &amp; WEIGHT</b>				Indoor unit		Outdoor unit	
Unit dimensions	Height	in. (mm)	9-7/16	(240)	48-5/8	(1,235)	
	Width	in. (mm)	62-1/32	(1,575)	37-1/32	(940)	
	Depth	in. (mm)	26-3/8	(670)	13-3/8	(340)	
Indoor grille dimensions	Height	in. (mm)	12-15/32	(317)	52-7/32	(1326)	
	Width	in. (mm)	66-1/16	(1,678)	40	(1,016)	
	Depth	in. (mm)	31-1/16	(789)	16-3/8	(416)	
Net weight		lbs. (kg)	90	(41)	203	(92)	
Shipping weight		lbs. (kg)	104	(47)	227	(103)	
Shipping volume		cu.ft. (m³)	14.8	(0.42)	19.8	(0.56)	

DATA SUBJECT TO CHANGE WITHOUT NOTICE

Cooling :

Rating conditions (\*) : Room temperature 80 °F DB / 67 °F WB, Ambient temperature 95 °F DB / 75 °F WB

Heating :

Rating conditions (\*) : Room temperature 70 °F DB / 60 °F WB, Ambient temperature 47 °F DB / 43 °F WB

Low temp conditions (\*\*): Room temperature 70 °F DB / 60 °F WB, Ambient temperature 17 °F DB / 15 °F WB

1-1 Unit Specifications

MODEL No.		Indoor Unit		UH2442			
		Outdoor Unit		CH2442			
<b>POWER SOURCE</b>				230 - 208 V / 1 Phase / 60 Hz			
<b>PERFORMANCE</b>				<b>Cooling</b>		<b>Heating</b>	
Capacity*	(17°F)**	BTU / h	24,000	23,400	27,000 16,200	26,500 15,500	
Moisture removal (High)		Pints / h	8.4	7.7	—		
Air circulation (H / M / L)	230 V	cu.ft. / min.	670 / 530 / 460				
External Static Pressure		in.Aq (Pa)	0.2 (49) : at shipment / 0.4 (100) : using jumper cable				
S.E.E.R. (H.S.P.F.)		BTU / Wh	10.0	10.0	(7.0)	(7.0)	
<b>ELECTRICAL RATINGS</b>							
Voltage rating		VAC	230	208	230	208	
Available voltage range		VAC	187 - 253				
Running amperes		A	11.5	12.1	12.0	12.5	
Power input*	(17°F)**	W	2,550	2,480	2,650 2,080	2,550 1,960	
Maximum overcurrent protection		A	25				
<b>FEATURES</b>							
Controls			Microprocessor				
Low ambient control			Built-in 0°F				
Fan speeds Indoor / Outdoor			3 and Automatic control / 3 (Auto)				
Optional Wired Remote Controller (Timer)			RCS-SH80UG (72-hour ON / OFF)				
Optional Wireless Remote Controller (Timer)			RCS-BH80UA. WL (72-hour ON / OFF)				
Air deflection		Horizontal / Vertical	— / —				
Air filter			Optional				
Operation sound	Indoor - Hi / Me / Lo Outdoor - Hi	dB - A dB - A	34 / 30 / 27 : at shipment / 38 / 34 / 30 : using jumper cable 53				
Refrigerant control			Electronic Expansion Valve				
<b>REFRIGERANT PIPING</b>							
Limit of piping length		ft. (m)	165 (50)				
Limit of piping length at shipment		ft. (m)	100 (30)				
Limit of elevation difference between the two units		ft. (m)	Outdoor unit is higher than indoor unit: 165 (50) Outdoor unit is lower than indoor unit: 100 (30)				
Refrigerant piping Flare type	Narrow pipe Wide pipe	in. (mm) in. (mm)	1 / 4 (6.35) 3 / 4 (19.05)				
<b>DIMENSIONS &amp; WEIGHT</b>				Indoor unit		Outdoor unit	
Unit dimensions	Height	in. (mm)	12-7/32	(310)	28-15/16	(735)	
	Width	in. (mm)	39-3/8	(1,000)	37-1/32	(940)	
	Depth	in. (mm)	24-13/16	(630)	13-3/8	(340)	
Net weight		ibs. (kg)	1-1/4	(32)	32-17/32	(826)	
Package dimensions	Height	in. (mm)	14-3/32	(358)	40	(1,016)	
	Width	in. (mm)	46-7/8	(1,191)	16-3/8	(416)	
	Depth	in. (mm)	30-13/16	(1,191)	157	(71)	
Shipping weight		lbs. (kg)	82	(37)	170	(77)	
Shipping volume		cu.ft. (m³)	11.8	(0.334)	12.3	(0.349)	

DATA SUBJECT TO CHANGE WITHOUT NOTICE

Cooling :

Rating conditions (\*) : Room temperature 80 °F DB / 67 °F WB, Ambient temperature 95 °F DB / 75 °F WB

Heating :

Rating conditions (\*) : Room temperature 70 °F DB / 60 °F WB, Ambient temperature 47 °F DB / 43 °F WB

Low temp conditions (\*\*): Room temperature 70 °F DB / 60 °F WB, Ambient temperature 17 °F DB / 15 °F WB

## 1-1 Unit Specifications

MODEL No.		Indoor Unit		UH3642			
		Outdoor Unit		CH3642			
<b>POWER SOURCE</b>				<b>230 - 208 V / 1 Phase / 60 Hz</b>			
<b>PERFORMANCE</b>				<b>Cooling</b>		<b>Heating</b>	
Capacity*	(17°F)**	BTU / h	34,500	33,000	37,500 25,000	36,500 24,000	
Moisture removal (High)		Pints / h	10.0	9.9	—		
Air circulation (H / M / L)	230 V	cu.ft. / min.	1,060 / 920 / 750				
External Static Pressure		in.Aq (Pa)	0.24 (59) : at shipment / 0.38 (94) : using jumper cable				
S.E.E.R. (H.S.P.F.)		BTU / Wh	10.3	10.5	(7.0)	(7.0)	
<b>ELECTRICAL RATINGS</b>							
Voltage rating		VAC	230	208	230	208	
Available voltage range		VAC	187 - 253				
Running amperes		A	15.1	15.7	18.2	19.6	
Power input*	(17°F)**	W	3,350	3,170	3,780 3,000	3,760 2,900	
Maximum overcurrent protection		A	40				
<b>FEATURES</b>							
Controls			Microprocessor				
Low ambient control			Built-in 0°F				
Fan speeds Indoor / Outdoor			3 and Automatic control / 3 (Auto)				
Optional Wired Remote Controller (Timer)			RCS-SH80UG (72-hour ON / OFF)				
Optional Wireless Remote Controller (Timer)			RCS-SH80UA. WL / RCS-BH80UA. WL (72-hour ON / OFF)				
Air deflection	Horizontal / Vertical		— / —				
Air filter			Optional				
Operation sound	Indoor - Hi / Me / Lo Outdoor - Hi	dB - A dB - A	38 / 33 / 31 : at shipment / 42 / 38 / 33 : using jumper cable 56				
Refrigerant control			Electronic Expansion Valve				
<b>REFRIGERANT PIPING</b>							
Limit of piping length		ft. (m)	165 (50)				
Limit of piping length at shipment		ft. (m)	100 (30)				
Limit of elevation difference between the two units		ft. (m)	Outdoor unit is higher than indoor unit: 165 (50) Outdoor unit is lower than indoor unit: 100 (30)				
Refrigerant piping Flare type	Narrow pipe Wide pipe	in. (mm) in. (mm)	3 / 8 (9.52) 3 / 4 (19.05)				
<b>DIMENSIONS &amp; WEIGHT</b>				<b>Indoor unit</b>		<b>Outdoor unit</b>	
Unit dimensions	Height	in. (mm)	12-7/32	(310)	48-5/8	(1,235)	
	Width	in. (mm)	58-9/32	(1,480)	37-1/32	(940)	
	Depth	in. (mm)	24-13/16	(630)	13-3/8	(340)	
Package dimensions	Height	in. (mm)	14-3/32	(358)	52-7/32	(1,326)	
	Width	in. (mm)	65-25/32	(1,671)	40	(1,016)	
	Depth	in. (mm)	30-13/16	(783)	16-3/8	(416)	
Net weight		ibs. (kg)	104	(47)	203	(92)	
Shipping weight		lbs. (kg)	115	(52)	227	(103)	
Shipping volume		cu.ft. (m <sup>3</sup> )	16.5	(0.468)	19.8	(0.56)	

DATA SUBJECT TO CHANGE WITHOUT NOTICE

Cooling :

Rating conditions (\*) : Room temperature 80 °F DB / 67 °F WB, Ambient temperature 95 °F DB / 75 °F WB

Heating :

Rating conditions (\*) : Room temperature 70 °F DB / 60 °F WB, Ambient temperature 47 °F DB / 43 °F WB

Low temp conditions (\*\*): Room temperature 70 °F DB / 60 °F WB, Ambient temperature 17 °F DB / 15 °F WB

1-1 Unit Specifications

MODEL No.		Indoor Unit		KH2442			
		Outdoor Unit		CH2442			
<b>POWER SOURCE</b>				230 - 208 V / 1 Phase / 60 Hz			
<b>PERFORMANCE</b>				Cooling		Heating	
Capacity*	(17°F)**	BTU / h	22,000	21,000	25,000 16,000	24,300 15,300	
Moisture removal (High)		Pints / h	7.1	6.8	—		
Air circulation (H / M / L)	230 V	cu.ft. / min.	540 / 460 / 380				
S.E.E.R. (H.S.P.F.)		BTU / Wh	10.0	10.0	(7.0)	(7.0)	
<b>ELECTRICAL RATINGS</b>							
Voltage rating		VAC	230	208	230	208	
Available voltage range		VAC	187 - 253				
Running amperes		A	10.3	10.9	11.3	12.2	
Power input*	(17°F)**	W	2,300	2,220	2,500 2,100	2,430 2,070	
Maximum overcurrent protection		A	25				
<b>FEATURES</b>							
Controls		Microprocessor					
Low ambient control		Built-in 0°F					
Fan speeds Indoor / Outdoor		3 and Automatic control / 3 (Auto)					
Optional Wired Remote Controller (Timer)		RCS-SH80UG (72-hour ON / OFF)					
Optional Wireless Remote Controller (Timer)		RCS-BH80UA. WL (72-hour ON / OFF)					
Air deflection		Horizontal / Vertical	Manual / Automatic				
Air filter		Washable, easy access					
Operation sound	Indoor - Hi / Me / Lo Outdoor - Hi	dB - A dB - A	45 / 42 / 40 53				
Refrigerant control		Electronic Expansion Control Valve					
<b>REFRIGERANT PIPING</b>							
Limit of piping length		ft. (m)	165 (50)				
Limit of piping length at shipment		ft. (m)	100 (30)				
Limit of elevation difference between the two units		ft. (m)	Outdoor unit is higher than indoor unit: 165 (50) Outdoor unit is lower than indoor unit: 100 (30)				
Refrigerant piping Flare type	Narrow pipe Wide pipe	in. (mm) in. (mm)	1 / 4 (6.35) 3 / 4 (19.05)				
<b>DIMENSIONS &amp; WEIGHT</b>				Indoor unit		Outdoor unit	
Unit dimensions	Height	in. (mm)	14-9/16	(370)	28-15/16	(735)	
	Width	in. (mm)	49-7/32	(1,250)	37-1/32	(940)	
	Depth	in. (mm)	8-9/32	(210)	13-3/8	(340)	
Indoor grille dimensions	Height	in. (mm)	18-3/16	(462)	32-17/32	(826)	
	Width	in. (mm)	52-23/32	(1,339)	40	(1,016)	
	Depth	in. (mm)	10-11/32	(263)	16-3/8	(416)	
Net weight		lbs. (kg)	40	(18)	157	(71)	
Shipping weight		lbs. (kg)	51	(23)	170	(77)	
Shipping volume		cu.ft. (m³)	5.8	(0.163)	12.3	(0.349)	

DATA SUBJECT TO CHANGE WITHOUT NOTICE

Cooling :

Rating conditions (\*) : Room temperature 80 °F DB / 67 °F WB, Ambient temperature 95 °F DB / 75 °F WB

Heating :

Rating conditions (\*) : Room temperature 70 °F DB / 60 °F WB, Ambient temperature 47 °F DB / 43 °F WB

Low temp conditions (\*\*): Room temperature 70 °F DB / 60 °F WB, Ambient temperature 17 °F DB / 15 °F WB

## 1-1 Unit Specifications

MODEL No.		Indoor Unit		KH3642			
		Outdoor Unit		CH3642			
<b>POWER SOURCE</b>				230 - 208 V / 1 Phase / 60 Hz			
<b>PERFORMANCE</b>				Cooling		Heating	
Capacity*	(17°F)**	BTU / h	33,000	32,000	40,000 25,000	39,000 24,000	
Moisture removal (High)		Pints / h	10.6	10.6	—		
Air circulation (H / M / L)	230 V	cu.ft. / min.	830 / 710 / 590				
S.E.E.R. (H.S.P.F.)		BTU / Wh	10.3	10.5	(7.6)	(7.6)	
<b>ELECTRICAL RATINGS</b>							
Voltage rating		VAC	230	208	230	208	
Available voltage range		VAC	187 - 253				
Running amperes		A	14.9	15.5	17.8	19.1	
Power input*	(17°F)**	W	3,290	3,120	3,860 3,000	3,810 2,900	
Maximum overcurrent protection		A	40				
<b>FEATURES</b>							
Controls		Microprocessor					
Low ambient control		Built-in 0°F					
Fan speeds Indoor / Outdoor		3 and Automatic control / 3 (Auto)					
Optional Wired Remote Controller (Timer)		RCS-SH80UG (72-hour ON / OFF)					
Optional Wireless Remote Controller (Timer)		RCS-BH80UA.WL (72-hour ON / OFF)					
Air deflection		Horizontal / Vertical	Manual / Automatic				
Air filter		Washable, easy access					
Operation sound	Indoor - Hi / Me / Lo Outdoor - Hi	dB - A dB - A	48 / 44 / 40 56				
Refrigerant control		Electronic Expansion Control Valve					
<b>REFRIGERANT PIPING</b>							
Limit of piping length		ft. (m)	165 (50)				
Limit of piping length at shipment		ft. (m)	100 (30)				
Limit of elevation difference between the two units		ft. (m)	Outdoor unit is higher than indoor unit: 165 (50) Outdoor unit is lower than indoor unit: 100 (30)				
Refrigerant piping Flare type	Narrow pipe Wide pipe	in. (mm) in. (mm)	3 / 8 (9.52) 3 / 4 (19.05)				
<b>DIMENSIONS &amp; WEIGHT</b>				Indoor unit		Outdoor unit	
Unit dimensions	Height	in. (mm)	14-9/16	(370)	48-5/8	(1,235)	
	Width	in. (mm)	59-1/16	(1,500)	37-1/32	(940)	
	Depth	in. (mm)	9-7/16	(240)	13-3/8	(340)	
Indoor grille dimensions	Height	in. (mm)	18-3/16	(462)	52-7/32	(1,326)	
	Width	in. (mm)	62-9/16	(1,589)	40	(1,016)	
	Depth	in. (mm)	11-5/8	(295)	16-3/8	(416)	
Net weight		lbs. (kg)	73	(33)	203	(92)	
Shipping weight		lbs. (kg)	90	(41)	227	(103)	
Shipping volume		cu.ft. (m <sup>3</sup> )	7.7	(0.217)	19.8	(0.56)	

DATA SUBJECT TO CHANGE WITHOUT NOTICE

Cooling :

Rating conditions (\*) : Room temperature 80 °F DB / 67 °F WB, Ambient temperature 95 °F DB / 75 °F WB

Heating :

Rating conditions (\*) : Room temperature 70 °F DB / 60 °F WB, Ambient temperature 47 °F DB / 43 °F WB

Low temp conditions (\*\*): Room temperature 70 °F DB / 60 °F WB, Ambient temperature 17 °F DB / 15 °F WB

**1-2 Major Component Specifications**

**(A) Indoor Unit**

<b>MODEL No.</b>		<b>XH2442</b>	
<b>Source</b>		<b>230 - 208 VAC / 1 phase / 60 Hz</b>	
<b>Remote controller (Option)</b>		RCS - SH80UA, WL	
<b>Controller P. C. B Ass'y</b>		CR - TH2442	
<b>Control circuit fuse</b>		250 VAC, 3 A	
<b>Fan (Number ... diameter)</b>	in. (mm)	Turbo (1...17-7/16 (443))	
<b>Fan motor</b>			
Model		SFG6X - 41D6P	
Source		230 - 208 V / 1 phase / 60 Hz	
No. of pole ... r.p.m. (230 V, High)	rpm	6 ... 464	
Nominal output	W	40	
Coil resistance (Ambient temperature 68 °F)	Ω	BRW - WHT : 170.3 , ORG - YEL : 43.2 WHT - VLT : 18.1 , WHT - PNK : 83.5 VLT - ORG : 43.2 , YEL - BLK : 60.2	
<b>Safety device</b>			
Operating temperature	Open °F	266 ± 14.4	
	Close °F	174.2 ± 27	
Run capacitor	VAC, μF	440 V , 4.5 μF	
<b>Electronic expansion valve</b>			
Coil		DKV - MOZS726E	
Coil resistance (at 20°C)	Ω	ORG - GRY : 46 , YEL - GRY : 46 RED - GRY : 46 , BLK - GRY : 46	
Valve body		IKV - 24D18	
<b>Heat exchanger</b>			
Coil		Aluminum plate fin / Copper tube	
Rows ... Fins per inch		2 ... 14.9	
Face area	ft. <sup>2</sup> (m <sup>2</sup> )	3.69 (0.343)	
<b>Panel</b>			
Model No.		PNR - XH2442	
Auto louver motor		MT8 - 3C	
Auto louver motor ... Rated	V, W, rpm	240 VAC , 3 W , 3 rpm	
Coil resistance (Ambient temperature 77 °F)	Ω	16.430 Ω ± 8 %	

DATA SUBJECT TO CHANGE WITHOUT NOTICE



**1-2 Major Component Specifications**

**(A) Indoor Unit**

<b>MODEL No.</b>		<b>XH3642</b>	
<b>Source</b>		<b>230 - 208 VAC / 1 phase / 60 Hz</b>	
<b>Remote controller (Option)</b>		RCS - SH80UA, WL	
<b>Controller P. C. B Ass'y</b>		CR - TH2442	
<b>Control circuit fuse</b>		250 VAC, 3 A	
<b>Fan (Number ... diameter)</b>	in. (mm)	Turbo (1...17-7/16 (443))	
<b>Fan motor</b>			
Model		SFG6X - 81A6P	
Source		230 - 208 V / 1 phase / 60 Hz	
No. of pole ... r.p.m. (230 V, High)	rpm	6 ... 467	
Nominal output	W	60	
Coil resistance (Ambient temperature 68 °F)	Ω	BRW - WHT : 75.1 , ORG - YEL : 27.4 WHT - VLT : 6.7 , VLT - PNK : 42.7 VLT - ORG : 20.6 , YEL - BLK : 58.0	
<b>Safety device</b>			
Operating temperature	Open °F	266 ± 14.4	
	Close °F	174.2 ± 27	
Run capacitor	VAC, μF	440 V , 5 μF	
<b>Electronic expansion valve</b>			
Coil		EKV - MOZS742E	
Coil resistance (at 20°C)	Ω	ORG - GRY : 46 , YEL - GRY : 46 RED - GRY : 46 , BLK - GRY : 46	
Valve body		HKV - 30D27	
<b>Heat exchanger</b>			
Coil		Aluminum plate fin / Copper tube	
Rows ... Fins per inch		2 ... 14.9	
Face area	ft. <sup>2</sup> (m <sup>2</sup> )	8.20 (0.762)	
<b>Panel</b>			
Model No.		PNR - XH3642	
Auto louver motor		MT8 - 3C	
Auto louver motor ... Rated	V, W, rpm	240 VAC , 3 W , 3 rpm	
Coil resistance (Ambient temperature 77 °F)	Ω	16.430 Ω ± 8 %	

DATA SUBJECT TO CHANGE WITHOUT NOTICE



**1-2 Major Component Specifications**

**(A) Indoor Unit**

<b>MODEL No.</b>		<b>XH4242</b>	
<b>Source</b>		<b>230 - 208 VAC / 1 phase / 60 Hz</b>	
<b>Remote controller (Option)</b>		RCS - SH80UA, WL	
<b>Controller P. C. B Ass'y</b>		CR - TH2442	
<b>Control circuit fuse</b>		250 VAC, 3 A	
<b>Fan (Number ... diameter)</b>	in. (mm)	Turbo (1...17-7/16 (443))	
<b>Fan motor</b>			
Model		SFG6X - 81A6P	
Source		230 - 208 V / 1 phase / 60 Hz	
No. of pole ... r.p.m. (230 V, High)	rpm	6 ... 506	
Nominal output	W	60	
Coil resistance (Ambient temperature 68 °F)	Ω	BRW - WHT : 75.1 , ORG - YEL : 27.4 WHT - VLT : 6.7 , VLT - PNK : 42.7 VLT - ORG : 20.6 , YEL - BLK : 58.0	
<b>Safety device</b>			
Operating temperature	Open °F	266 ± 14.4	
	Close °F	174.2 ± 27	
Run capacitor	VAC, μF	440 V , 6 μF	
<b>Electronic expansion valve</b>			
Coil		EKV - MOZS742E	
Coil resistance (at 20°C)	Ω	ORG - GRY : 46 , YEL - GRY : 46 RED - GRY : 46 , BLK - GRY : 46	
Valve body		HKV - 30D27	
<b>Heat exchanger</b>			
Coil		Aluminum plate fin / Copper tube	
Rows ... Fins per inch		2 ... 14.9	
Face area	ft. <sup>2</sup> (m <sup>2</sup> )	8.20 (0.762)	
<b>Panel</b>			
Model No.		PNR - XH3642	
Auto louver motor		MT8 - 3C	
Auto louver motor ... Rated	V, W, rpm	240 VAC , 3 W , 3 rpm	
Coil resistance (Ambient temperature 77 °F)	Ω	16.430 Ω ± 8 %	

DATA SUBJECT TO CHANGE WITHOUT NOTICE

**1-2 Major Component Specifications**

**(A) Indoor Unit**

<b>MODEL No.</b>		<b>TH2442</b>	
<b>Source</b>		<b>230 - 208 V / 1 phase / 60 Hz</b>	
<b>Remote controller (Option)</b>		RCS - SH80UA, WL	
<b>Controller P. C. B Ass'y</b>		CR - TH2442	
<b>Control circuit fuse</b>		250 V, 3 A	
<b>Fan (Number ... diameter)</b>	in. (mm)	Centrifugal (4 ... 5-1/8(130))	
<b>Fan motor</b>			
Model		SR4X - 51A6P	
Source		230 - 208 V / 1 phase / 60 Hz	
No. of pole ... r.p.m. (230 V, High)	rpm	1,179	
Nominal output	W	31	
Coil resistance (Ambient temperature 68 °F)	Ω	BRW - WHT : 111.0 , ORG - YEL : 16.7 WHT - VLT : 35.4 , BLK - PNK : 23.9 VLT - ORG : 13.4 , YEL - BLK : 136.6	
<b>Safety device</b>			
Operating temperature	Open °F	266 ± 14.4	
	Close °F	174.2 ± 27	
Run capacitor	VAC, μF	440 V , 1.5 μF	
<b>Electronic refrigerant control valve</b>			
Solenoid control model		DKV - MOZS582E0	
Coil resistance (Ambient temperature 68 °F)	Ω	ORG - GRY : 46 , YEL - GRY : 46 RED - GRY : 46 , BLK - GRY : 46	
Solenoid control valve model		IKV - 24D18	
<b>Heat exchanger</b>			
Coil		Aluminum plate fin / Copper tube	
Rows ... Fins per inch		3 ... 14.9	
Face area	ft. <sup>2</sup> (m <sup>2</sup> )	1.81 (0.168)	
<b>Auto louver motor</b>			
Model No.		MT8 - 3C	
Auto louver motor ... Rated	V, W, rpm	240 VAC , 3 W , 3 rpm	
Coil resistance (Ambient temperature 77 °F)	Ω	16,430 Ω ± 8 %	

DATA SUBJECT TO CHANGE WITHOUT NOTICE



**1-2 Major Component Specifications**

**(A) Indoor Unit**

<b>MODEL No.</b>		<b>TH3642</b>	
<b>Source</b>		<b>230 - 208 V / 1 phase / 60 Hz</b>	
<b>Remote controller (Option)</b>		RCS - SH80UA, WL	
<b>Controller P. C. B Ass'y</b>		CR - TH2442	
<b>Control circuit fuse</b>		250 V, 3 A	
<b>Fan (Number ... diameter)</b>	in. (mm)	Centrifugal (4 ... 5-29/32(150))	
<b>Fan motor</b>			
Model		KFG4X - 101C6P	
Source		230 - 208 V / 1 phase / 60 Hz	
No. of pole ... r.p.m. (230 V, High)	rpm	4 ... 1,040	
Nominal output	W	100	
Coil resistance (Ambient temperature 68 °F)	Ω	BRW - WHT : 61.05 , ORG - YEL : 13.23 WHT - VLT : 9.955 , YEL - BLK : 19.25 VLT - ORG : 9.576 , BLK - PNK : 10.81	
<b>Safety device</b>			
Operating temperature	Open °F	266 ± 14.4	
	Close °F	174.2 ± 27	
Run capacitor	VAC, μF	440 V, 4 μF	
<b>Electronic expansion valve</b>			
Coil		EKV - MOZS584E0	
Coil resistance (Ambient temperature 68 °F)	Ω	ORG - GRY : 46 , YEL - GRY : 46 RED - GRY : 46 , BLK - GRY : 46	
Valve body		HKV - 30D24	
<b>Heat exchanger</b>			
Coil		Aluminum plate fin / Copper tube	
Rows ... Fins per inch		3 ... 14.9	
Face area	ft. <sup>2</sup> (m <sup>2</sup> )	3.51 (0.326)	
<b>Auto louver motor</b>			
Model No.		MT8 - 3C	
Auto louver motor ... Rated	V, W, rpm	240 VAC, 3 W, 3 rpm	
Coil resistance (Ambient temperature 77 °F)	Ω	16,430 Ω ± 8 %	

DATA SUBJECT TO CHANGE WITHOUT NOTICE

1-2 Major Component Specifications

(A) Indoor Unit

<b>MODEL No.</b>		<b>TH4242</b>	
<b>Source</b>		<b>230 - 208 V / 1 phase / 60 Hz</b>	
<b>Remote controller (Option)</b>		RCS - SH80UA, WL	
<b>Controller P. C. B Ass'y</b>		CR - TH2442	
<b>Control circuit fuse</b>		250 V, 3 A	
<b>Fan (Number ... diameter)</b>	in. (mm)	Centrifugal (4 ... 5-29/32(150))	
<b>Fan motor</b>			
Model		KFG4X - 101C6P	
Source		230 - 208 V / 1 phase / 60 Hz	
No. of pole ... r.p.m. (230 V, High)	rpm	4 ... 1,099	
Nominal output	W	100	
Coil resistance (Ambient temperature 68 °F)	Ω	BRW - WHT : 61.05 , ORG - YEL : 13.23 WHT - VLT : 9.955 , YEL - BLK : 19.25 VLT - ORG : 9.576 , BLK - PNK : 10.81	
<b>Safety device</b>			
Operating temperature	Open °F	266 ± 14.4	
	Close °F	174.2 ± 27	
Run capacitor	VAC, μF	440 V , 5 μF	
<b>Electronic expansion valve</b>			
Coil		EKV - MOZS584E0	
Coil resistance (Ambient temperature 68 °F)	Ω	ORG - GRY : 46 , YEL - GRY : 46 RED - GRY : 46 , BLK - GRY : 46	
Valve body		HKV - 30D27	
<b>Heat exchanger</b>			
Coil		Aluminum plate fin / Copper tube	
Rows ... Fins per inch		3 ... 14.9	
Face area	ft. <sup>2</sup> (m <sup>2</sup> )	3.51 (0.326)	
<b>Auto louver motor</b>			
Model No.		MT8 - 3C	
Auto louver motor ... Rated	V, W, rpm	240 VAC , 3 W , 3 rpm	
Coil resistance (Ambient temperature 77 °F)	Ω	16,430 Ω ± 8 %	

DATA SUBJECT TO CHANGE WITHOUT NOTICE



**1-2 Major Component Specifications**

**(A) Indoor Unit**

<b>MODEL No.</b>		<b>UH2442</b>	
<b>Source</b>		<b>230 - 208 V / 1 phase / 60 Hz</b>	
<b>Remote controller (Option)</b>		RCS - BH80UA, WL	
<b>Controller P. C. B Ass'y</b>		CR - TH2442	
<b>Control circuit fuse</b>		250 V, 3 A	
<b>Fan (Number ... diameter)</b>	in. (mm)	Centrifugal (4 ... 5-29/32(150))	
<b>Fan motor</b>			
Model		KFG4X - 71B6P	
Source		230 - 208 V / 1 phase / 60 Hz	
No. of pole ... r.p.m. (230 V, High)	rpm	4 ... 920	
Nominal output	W	100	
Coil resistance (Ambient temperature 68 °F)	Ω	BRW - WHT : 74.7 , ORG - YEL : 9.59 WHT - VLT : 19.1 , YEL - BLK : 10.52 VLT - ORG : 10.5 , BLK - PNK : 21.72	
<b>Safety device</b>			
Operating temperature	Open °F	266 ± 14.4	
	Close °F	174.2 ± 27	
Run capacitor	VAC, μF	440 V , 5 μF	
<b>Electronic expansion valve</b>			
Coil		DKV - MOZS697E0	
Coil resistance (Ambient temperature 68 °F)	Ω	ORG - GRY : 46 , YEL - GRY : 46 RED - GRY : 46 , BLK - GRY : 46	
Valve body		IKV - 24D12	
<b>Heat exchanger</b>			
Coil		Aluminum plate fin / Copper tube	
Rows ... Fins per inch		3 ... 14.9	
Face area	ft. <sup>2</sup> (m <sup>2</sup> )	2.03 (0.189)	

DATA SUBJECT TO CHANGE WITHOUT NOTICE

**1-2 Major Component Specifications**

**(A) Indoor Unit**

<b>MODEL No.</b>		<b>UH3642</b>	
<b>Source</b>		<b>230 - 208 V / 1 phase / 60 Hz</b>	
<b>Remote controller (Option)</b>		RCS - BH80UA, WL	
<b>Controller P. C. B Ass'y</b>		CR - TH2442	
<b>Control circuit fuse</b>		250 V, 3 A	
<b>Fan (Number ... diameter)</b>	in. (mm)	Centrifugal (4 ... 5-29/32(150))	
<b>Fan motor</b>			
Model		KFG4X - 141A6P	
Source		230 - 208 V / 1 phase / 60 Hz	
No. of pole ... r.p.m. (230 V, High)	rpm	4 ... 940	
Nominal output	W	100	
Coil resistance (Ambient temperature 68 °F)	Ω	BRW - WHT : 39.9 , ORG - YEL : 9.37 WHT - VLT : 6.91 , YEL - BLK : 8.86 VLT - ORG : 11.4 , BLK - PNK : 14.3	
<b>Safety device</b>			
Operating temperature	Open °F	266 ± 14.4	
	Close °F	174.2 ± 27	
Run capacitor	VAC, μF	440 V , 5 μF	
<b>Electronic expansion valve</b>			
Coil		DKV - MOZS698E0	
Coil resistance (Ambient temperature 68 °F)	Ω	ORG - GRY : 46 , YEL - GRY : 46 RED - GRY : 46 , BLK - GRY : 46	
Valve body		HKV - 30D27	
<b>Heat exchanger</b>			
Coil		Aluminum plate fin / Copper tube	
Rows ... Fins per inch		3 ... 12.7	
Face area	ft. <sup>2</sup> (m <sup>2</sup> )	3.32 (0.308)	

DATA SUBJECT TO CHANGE WITHOUT NOTICE



**1-2 Major Component Specifications**

**(A) Indoor Unit**

<b>MODEL No.</b>		<b>KH2442</b>	
<b>Source</b>		<b>230 - 208 V / 1 phase / 60 Hz</b>	
<b>Remote controller (Option)</b>		RCS - BH80UA, WL	
<b>Controller P. C. B Ass'y</b>		CR - TH2442	
Control circuit fuse		250 V, 3 A	
<b>Fan</b>		Cross-flow	
Number ... Dia. and length	in. (mm)	1 ... O.D. 4-1/3 (110), L39 (990)	
<b>Fan motor</b>			
Model		UF4Q - 31A6P	
Source		230 - 208 V / 1 phase / 60 Hz	
No. of pole ... r.p.m. (230 V, High)	rpm	4 ... 1,276	
Nominal output	W	30	
Coil resistance (Ambient temperature 68 °F)	Ω	BRW - WHT : 197.2 , ORG - YEL : 59.1 WHT - VLT : 41.4 , YEL - PNK : 48.8 VLT - ORG : 22.2 ,	
<b>Safety device</b>			
Operating temperature	Open °F	248 ± 9	
	Close °F	171 ± 27	
Run capacitor	VAC, μF	440 V , 1.8 μF	
<b>Electronic refrigerant control valve</b>			
Solenoid control model		DKV - MOZS582E0	
Coil resistance (Ambient temperature 68 °F)	Ω	ORG - GRY : 46 , YEL - GRY : 46 RED - GRY : 46 , BLK - GRY : 46	
Solenoid control valve model		IKV - 24D11	
<b>Heat exchanger</b>			
Coil		Aluminum plate fin / Copper tube	
Rows ...		3 ... 12.7	
Face area	ft. <sup>2</sup> (m <sup>2</sup> )	2.57 (0.24)	
<b>Louver Motor</b>			
Model		M2EA24ZA01	
Rating		208 to 230 V, 60 Hz	
No. of pole ... rpm		8 ... 3	
Output	W	2.5	
Coil resistance (Ambient temperature 68 °F)	kΩ	16.45 ± 8 %	

DATA SUBJECT TO CHANGE WITHOUT NOTICE

1



1-2 Major Component Specifications

(A) Indoor Unit

<b>MODEL No.</b>		<b>KH3642</b>	
<b>Source</b>		<b>230 - 208 V / 1 phase / 60 Hz</b>	
<b>Remote controller (Option)</b>		RCS - BH80UA, WL	
<b>Controller P. C. B Ass'y</b>		CR - TH2442	
Control circuit fuse		250 V, 3 A	
<b>Switch Ass'y</b>		SW - KHS2432	
<b>Fan</b>		Cross-flow	
Number ... Dia. and length	in. (mm)	1 ... O.D. 4-13/18 (120), L46 (1,170)	
<b>Fan motor</b>			
Model		SFG4Q - 41B6P	
Source		230 - 208 V / 1 phase / 60 Hz	
No. of pole ... r.p.m. (230 V, High)	rpm	4 ... 1,273	
Nominal output	W	50	
Coil resistance (Ambient temperature 68 °F)	Ω	GRY - WHT : 122.3 , ORG - YEL : 23.03 WHT - VLT : 15.98 , YEL - PNK : 9.272 VLT - ORG : 11.93 ,	
Safety device			
Operating temperature	Open °F	266 ± 14.4	
	Close °F	174.2 ± 26	
Run capacitor	VAC, μF	440 V, 4 μF	
<b>Electronic expansion valve</b>			
Coil		EKV - MOZS557E0	
Coil resistance (Ambient temperature 68 °F)	Ω	ORG - GRY : 46 , YEL - GRY : 46 RED - GRY : 46 , BLK - GRY : 46	
Valve body		HKV - 30D26	
<b>Heat exchanger</b>			
Coil		Aluminum plate fin / Copper tube	
Rows ... Fins per inch		3 ... 12.7	
Face area	ft. <sup>2</sup> (m <sup>2</sup> )	3.23 (0.3)	
<b>Louver Motor</b>			
Model		M2EA24ZA01	
Rating		208 to 230 V, 60 Hz	
No. of pole ... rpm		8 ... 3	
Output	W	2.5	
Coil resistance (Ambient temperature 68 °F)	kΩ	16.45 ± 8 %	

DATA SUBJECT TO CHANGE WITHOUT NOTICE



1-2 Major Component Specifications

(B) Outdoor Unit

<b>MODEL No.</b>		<b>CH2442</b>	
<b>Source</b>		<b>230 - 208 VAC / 1 phase / 60 Hz</b>	
<b>Controller P.C.B. Ass'y</b>		CR - CH2442 (Microprocessor)	
Control circuit fuse		250 VAC, 3 A	
<b>Compressor</b>		Rotary (Hermetic)	
Model		C - 2R160H6T	
Source		230 - 208 VAC / 1 phase / 60 Hz	
Nominal output	W	1,700	
Compressor oil	cc	800	
Coil resistance (Ambient temperature 77 °F)	Ω	C - R : 0.885 , C - S : 1.773	
Safety device		Internal type	
Overload relay models		—	
Operating temperature	Open °F	297 ± 9	
	Close °F	198 ± 20	
Operating ampere (at 77 °F)	A	—	
Run capacitor	VAC, μF	400 VAC, 40 μF	
Crank case heater	VAC, W	230 VAC, 30 W	
<b>Refrigerant amount charged at shipment</b>	lbs. (kg)	R22 : 6.17 (2.8)	
<b>High pressure switch</b>		ACB - 1UB11	
Set pressure	OFF lb/in <sup>2</sup> (kg/cm <sup>2</sup> )	426.6 <sup>29.44</sup> / <sub>7.11</sub> (30 <sup>2.0</sup> / <sub>0.5</sub> )	
	ON lb/in <sup>2</sup> (kg/cm <sup>2</sup> )	341.3 ± 28.44 (24 ± 2.0)	
<b>Fan</b>		Propeller	
Number...diameter	in. (mm)	1 ... 18 - 3/32 (460)	
<b>Fan speeds</b>		2 (AUTO)	
<b>Fan motor</b>		KFC6T - 91D6P	
Source		230 - 208 VAC / 1 phase / 60 Hz	
No. of pole ..... rpm (230 V, High)		6 ... 879	
Nominal output	W	110	
Coil resistance (Ambient temperature 68 °F)	Ω	BRN - WHT : 67.14 , VLT - YEL : 11.42 WHT - VLT : 64.85 , YEL - PNK : 10.60	
Safety device		Internal type	
Operating temperature	Open °F	248 ± 9	
	Close °F	171 ± 27	
Run capacitor	VAC, μF	440 VAC, 4 μF	
<b>Heat exchange</b>		Aluminum plate fin / Copper tube	
Coil		Aluminum plate fin / Copper tube	
Rows ..... Fins per inch		2 ... 14.1	
Face area	ft. <sup>2</sup> (m <sup>2</sup> )	6.78 (0.63)	

DATA SUBJECT TO CHANGE WITHOUT NOTICE

1

1-2 Major Component Specifications

(B) Outdoor Unit

<b>MODEL No.</b>		<b>CH3642</b>	
<b>Source</b>		<b>230 - 208 VAC / 1 phase / 60 Hz</b>	
<b>Controller P.C.B. Ass'y</b>		CR - CH2442 (Microprocessor)	
Control circuit fuse		250 V, 3 A	
<b>Compressor</b>		Rotary (Hermetic)	
Model		C - R221H6R	
Source		230 - 208 VAC / 1 phase / 60 Hz	
Nominal output	W	2,200	
Compressor oil	cc	1,500	
Coil resistance (Ambient temperature 77 °F)	Ω	C - R : 0.549 , C - S : 1.525	
Safety device		Internal type	
Overload relay models		—	
Operating temperature	Open °F	320 ± 9	
	Close °F	189 ± 20	
Operating ampere (at 77 °F)	A	—	
Run capacitor	VAC, μF	400 VAC, 40 μF	
Crank case heater	VAC, W	230 VAC, 30 W	
<b>Refrigerant amount charged at shipment</b>	lbs. (kg)	R22 : 8.82 (4.0)	
<b>High pressure switch</b>		ACB - 1UB11	
Set pressure	OFF lb/in <sup>2</sup> (kg/cm <sup>2</sup> )	426.6 ± 28.44 (30 ± 2.0)	
	ON lb/in <sup>2</sup> (kg/cm <sup>2</sup> )	341.3 ± 28.44 (24 ± 2.0)	
<b>Fan</b>		Propeller	
Number...diameter	in. (mm)	2 ... 18 - 3/32 (460)	
<b>Fan speeds</b>		2 (AUTO)	
<b>Fan motor</b>		KFC6T - 91D6P × 2	
Model		KFC6T - 91D6P × 2	
Source		230 - 208 V / 1 phase / 60 Hz	
No. of pole ..... rpm (230 V, High)		6 ... 879	
Nominal output	W	110 × 2	
Coil resistance (Ambient temperature 68 °F)	Ω	BRN - WHT : 67.14 , VLT - YEL : 11.42 WHT - VLT : 64.85 , YEL - PNK : 10.60	
Safety device		Internal type	
Operating temperature	Open °F	248 ± 9	
	Close °F	171 ± 27	
Run capacitor	VAC, μF	440 VAC, 4 μF × 2	
<b>Heat exchange</b>		Aluminum plate fin / Copper tube	
Coil		Aluminum plate fin / Copper tube	
Rows ..... Fins per inch		2 ... 14.1	
Face area	ft. <sup>2</sup> (m <sup>2</sup> )	11.63 (1.08)	

DATA SUBJECT TO CHANGE WITHOUT NOTICE



1-2 Major Component Specifications

(B) Outdoor Unit

<b>MODEL No.</b>		<b>CH4242</b>	
<b>Source</b>		<b>230 - 208 V / 1 phase / 60 Hz</b>	
<b>Compressor</b>		Scroll (Hermetic)	
Model		ZR47KC - PFV	
Source		230 - 208 V / 1 phase / 60 Hz	
Nominal output	W	4,270	
Compressor oil	cc	1,240	
Coil resistance (Ambient temperature 77 °F)	Ω	R - W : 0.475 , S - W : 1.850	
Safety device		Internal type	
Overload relay models		—	
Operating temperature	Open °F	320 ± 9	
	Close °F	189 ± 20	
Operating ampere (at 77 °F)	A	—	
Run capacitor	VAC, μF	400 V, 50 μF	
<b>Refrigerant amount charged at shipment</b>	lbs. (kg)	R22 : 9.7 (4.4)	
<b>High pressure switch</b>		ACB - 1UB11	
Set pressure	OFF kg/cm <sup>2</sup>	30 ± <sub>0.5</sub> <sup>2.0</sup>	
	ON kg/cm <sup>2</sup>	24 ± 2.0	
<b>Fan</b>		Propeller	
Number...diameter	in. (mm)	1 ... 18-3/32 (460)	
<b>Fan speeds</b>		2 (AUTO)	
<b>Fan motor</b>			
Model		KFC6T - 91D6P × 2	
Source		230 - 208 V / 1 phase / 60 Hz	
No. of pole ... rpm (230 V, High)	rpm	6 ... 879	
Nominal output	W	110 × 2	
Coil resistance (Ambient temperature 68 °F)	Ω	BRW - WHT : 67.14 , VLT - YEL : 11.42 WHT - VLT : 64.85 , YEL - PNK : 10.60	
Safety device			
Operating temperature	Open °F	248 ± 9	
	Close °F	171 ± 27	
Run capacitor	VAC, μF	440 V, 4 μF × 2	
<b>Heat exchanger</b>			
Coil		Aluminum plate fin / Copper tube	
Rows ... Fins per inch		2 ... 12.7	
Face area	ft. <sup>2</sup> (m <sup>2</sup> )	11.63 (1.08)	

DATA SUBJECT TO CHANGE WITHOUT NOTICE

1-3 Other Component Specifications

(A) Indoor Unit

<b>MODEL No.</b>		<b>XH2442</b>	
<b>Power Transformer</b>		ATR – II224A	
Rated	Primary	220 VAC, 60 Hz	
	Secondary	BRN - BRN : 14 V, 0.45 A, RED - RED : 14 V, 0.3 A	
	Capacity	—	
Coil resistance (Ambient temprature 77 °F)	Ω	WHT - WHT : 61.0 , RED - RED : 1.37 BRN - BRN : 0.97 , ORG - ORG : 3.16	
Thermistor cut off temperature	°F	277	
<b>Thermistor (Coil sensor) : TH2, 3</b>		PBC - 41E - S14	
Coil resistance	kΩ	14 °F : 23.7 , 41 °F : 12.1 23 °F : 18.8 , 50 °F : 9.7 32 °F : 15.0 , 59 °F : 8.0	
<b>Thermistor (Room sensor) : TH1</b>		KTEC - 35 - S6	
Coil resistance	kΩ	32 °F : 16.5 , 104 °F : 2.7 41 °F : 12.8 , 113 °F : 2.2 50 °F : 10.0 , 122 °F : 1.8 68 °F : 6.3 , 131 °F : 1.5 86 °F : 4.0 ,	
<b>Drain pump</b>		PJV - 1428AU	
Rated		230 / 208 VAC, 12.5 W	
<b>Float switch</b>		FS - 0218 - 102	
MAX Rated (Contact rated)		50 W, DC 5V, 0.1 mA	
<b>Solenoid control valve or coil</b>			
Solenoid control valve		IKV - 24D18	
Solenoid coil		DKV - MOZS726E	
Synchronized Motor		MT8 - 3C	



**1-3 Other Component Specifications**

**(A) Indoor Unit**

<b>MODEL No.</b>		<b>XH3642</b>	
<b>Power Transformer</b>		ATR – IIK224A	
Rated	Primary	220 VAC, 60 Hz	
	Secondary	BRN - BRN : 14 V, 0.45 A, RED - RED : 14 V, 0.3 A	
	Capacity	—	
Coil resistance (Ambient temprature 77 °F)	Ω	WHT - WHT : 61.0 , BRN - BRN : 0.97 ,	RED - RED : 1.37 ORG - ORG : 3.16
Thermistor cut off temperature	°F	277	
<b>Thermistor (Coil sensor) : TH2, 3</b>		PBC - 41E - S14	
Coil resistance	kΩ	14 °F : 23.7 , 23 °F : 18.8 , 32 °F : 15.0 ,	41 °F : 12.1 50 °F : 9.7 59 °F : 8.0
<b>Thermistor (Room sensor) : TH1</b>		KTEC - 35 - S6	
Coil resistance	kΩ	32 °F : 16.5 , 41 °F : 12.8 , 50 °F : 10.0 , 68 °F : 6.3 , 86 °F : 4.0 ,	104 °F : 2.7 113 °F : 2.2 122 °F : 1.8 131 °F : 1.5
<b>Drain pump</b>		PJV - 1428AU	
Rated		230 / 208 VAC, 12.5 W	
<b>Float switch</b>		FS - 0218 - 102	
MAX Rated (Contact rated)		50 W, DC 5V, 0.1 mA	
<b>Solenoid control valve or coil</b>			
Solenoid control valve		HKV - 30D27	
Solenoid coil		EKV - MOZS742E	
Synchronized Motor		MT8 - 3C	

DATA SUBJECT TO CHANGE WITHOUT NOTICE

1-3 Other Component Specifications

(A) Indoor Unit

<b>MODEL No.</b>		<b>XH4242</b>	
<b>Power Transformer</b>		ATR – IIK224A	
Rated	Primary	220 VAC, 60 Hz	
	Secondary	BRN - BRN : 14 V, 0.45 A, RED - RED : 14 V, 0.3 A	
	Capacity	—	
Coil resistance (Ambient temprature 77 °F)		Ω	WHT - WHT : 61.0 , RED - RED : 1.37 BRN - BRN : 0.97 , ORG - ORG : 3.16
Thermistor cut off temperature		°F	277
<b>Thermistor (Coil sensor) : TH2, 3</b>		PBC - 41E - S14	
Coil resistance		kΩ	14 °F : 23.7 , 41 °F : 12.1 23 °F : 18.8 , 50 °F : 9.7 32 °F : 15.0 , 59 °F : 8.0
<b>Thermistor (Room sensor) : TH1</b>		KTEC - 35 - S6	
Coil resistance		kΩ	32 °F : 16.5 , 104 °F : 2.7 41 °F : 12.8 , 113 °F : 2.2 50 °F : 10.0 , 122 °F : 1.8 68 °F : 6.3 , 131 °F : 1.5 86 °F : 4.0 ,
<b>Drain pump</b>		PJV - 1428AU	
Rated		230 / 208 VAC, 12.5 W	
<b>Float switch</b>		FS - 0218 - 102	
MAX Rated (Contact rated)		50 W, DC 5V, 0.1 mA	
<b>Solenoid control valve or coil</b>			
Solenoid control valve		HKV - 30D27	
Solenoid coil		EKV - MOZS742E	
Synchronized Motor		MT8 - 3C	

DATA SUBJECT TO CHANGE WITHOUT NOTICE



1-3 Other Component Specifications

(A) Indoor Unit

<b>MODEL No.</b>		<b>TH2442</b>	
<b>Power Transformer</b>		ATR – IIK244B	
Rated	Primary	AC 220 V, 60 Hz	
	Secondary	BRN - BRN : 14 V / 0.55 A, RED - RED : 14 V / 0.3 A	
	Capacity	—	
Coil resistance (Ambient temprature 77 °F)	Ω	WHT - WHT : 48.0 , BRN - BRN : 0.45 ,	RED - RED : 0.89 ORG - ORG : 2.05
Thermistor cut off temperature	°F	277	
<b>Thermistor (Coil sensor)</b>		PBC - 41E - S14	
Coil resistance	kΩ	14 °F : 23.7	59 °F : 8.0
		23 °F : 18.8	68 °F : 6.5
		32 °F : 15.0	86 °F : 4.4
		41 °F : 12.1	104 °F : 3.1
		50 °F : 9.7	113 °F : 2.6
<b>Thermistor (Room or coil sensor)</b>		PBC - 41E - S14	
Coil resistance	kΩ	32 °F : 16.5	104 °F : 2.7
		41 °F : 12.8	113 °F : 2.2
		50 °F : 10.0	122 °F : 1.8
		68 °F : 6.3	131 °F : 1.5
		86 °F : 4.0	
<b>Electronic expansion valve</b>			
Valve body	IKV - 24D18		
Coil	EKV - MOZS582E0		
Synchronized Motor		MT8 - 3C	

DATA SUBJECT TO CHANGE WITHOUT NOTICE



**1-3 Other Component Specifications**

**(A) Indoor Unit**

<b>MODEL No.</b>		<b>TH3642</b>	
<b>Power Transformer</b>		ATR – IIK244B	
Rated	Primary	AC 220 V, 60 Hz	
	Secondary	BRN - BRN : 14 V / 0.55 A, RED - RED : 14 V / 0.55 A	
	Capacity	—	
Coil resistance (Ambient temprature 77 °F)	Ω	WHT - WHT : 48.0 , RED - RED : 0.89 BRN - BRN : 0.45 , ORG - ORG : 2.05	
Thermistor cut off temperature	°F	277	
<b>Thermistor (Coil sensor)</b>		PBC - 41E - S14	
Coil resistance	kΩ	14 °F : 23.7 , 59 °F : 8.0 23 °F : 18.8 , 68 °F : 6.5 32 °F : 15.0 , 86 °F : 4.4 41 °F : 12.1 , 104 °F : 3.1 50 °F : 9.7 , 113 °F : 2.6	
<b>Thermistor (Room or coil sensor)</b>		PBC - 41E - S42	
Coil resistance	kΩ	32 °F : 16.5 , 104 °F : 2.7 41 °F : 12.8 , 113 °F : 2.2 50 °F : 10.0 , 122 °F : 1.8 68 °F : 6.3 , 131 °F : 1.5 86 °F : 4.0 ,	
<b>Electronic expansion valve</b>			
Valve body		HKV - 30D24	
Coil		EKV - MOZS584E0	
Synchronized Motor		MT8 - 3C	

DATA SUBJECT TO CHANGE WITHOUT NOTICE



**1-3 Other Component Specifications**

**(A) Indoor Unit**

<b>MODEL No.</b>		<b>TH4242</b>	
<b>Power Transformer</b>		ATR – IIK244B	
Rated	Primary	AC 220 V, 60 Hz	
	Secondary	BRN - BRN : 14 V / 0.55 A, RED - RED : 14 V / 0.3 A	
	Capacity	—	
Coil resistance (Ambient temprature 77 °F)	Ω	WHT - WHT : 48.0 , BRN - BRN : 0.45 ,	RED - RED : 0.89 ORG - ORG : 2.05
Thermistor cut off temperature	°F	277	
<b>Thermistor (Coil sensor)</b>		PBC - 41E - S14	
Coil resistance	kΩ	14 °F : 23.7	59 °F : 8.0
		23 °F : 18.8	68 °F : 6.5
		32 °F : 15.0	86 °F : 4.4
		41 °F : 12.1	104 °F : 3.1
		50 °F : 9.7	113 °F : 2.6
<b>Thermistor (Room or coil sensor)</b>		KTEC - 35 - S6	
Coil resistance	kΩ	32 °F : 16.5	104 °F : 2.7
		41 °F : 12.8	113 °F : 2.2
		50 °F : 10.0	122 °F : 1.8
		68 °F : 6.3	131 °F : 1.5
		86 °F : 4.0	
<b>Electronic expansion valve</b>			
Valve body	HKV - 30D27		
Coil	EKV - MOZS584E0		
Synchronized Motor		MT8 - 3C	

DATA SUBJECT TO CHANGE WITHOUT NOTICE

**1-3 Other Component Specifications**

**(A) Indoor Unit**

<b>MODEL No.</b>		<b>UH2442</b>	
<b>Power Transformer</b>		ATR – IIK244B	
Rated	Primary	AC 220 V, 60 Hz	
	Secondary	BRN - BRN : 14 V / 0.55 A, RED - RED : 14 V / 0.3 A	
	Capacity	—	
Coil resistance (Ambient temprature 77 °F)	Ω	WHT - WHT : 48.0 , BRN - BRN : 0.45 ,	RED - RED : 0.89 ORG - ORG : 2.05
Thermistor cut off temperature	°F	277	
<b>Thermistor (Coil sensor)</b>		PBC - 41E - S36	
Coil resistance	kΩ	14 °F : 23.7 , 23 °F : 18.8 , 32 °F : 15.0 , 41 °F : 12.1 , 50 °F : 9.7 ,	59 °F : 8.0 68 °F : 6.5 86 °F : 4.4 104 °F : 3.1 113 °F : 2.6
<b>Thermistor (Room or coil sensor)</b>		KTEC - 35 - S42	
Coil resistance	kΩ	32 °F : 16.5 , 41 °F : 12.8 , 50 °F : 10.0 , 68 °F : 6.3 , 86 °F : 4.0 ,	104 °F : 2.7 113 °F : 2.2 122 °F : 1.8 131 °F : 1.5
<b>Electronic expansion valve</b>			
Valve body		HKV - 30D16	
Coil		EKV - MOZS559E0	

DATA SUBJECT TO CHANGE WITHOUT NOTICE



**1-3 Other Component Specifications**

**(A) Indoor Unit**

<b>MODEL No.</b>		<b>UH3642</b>	
<b>Power Transformer</b>		ATR – IIK244B	
Rated	Primary	AC 220 V, 60 Hz	
	Secondary	BRN - BRN : 14 V / 0.55 A, RED - RED : 14 V / 0.3 A	
	Capacity	—	
Coil resistance (Ambient temprature 77 °F)	Ω	WHT - WHT : 48.0 , BRN - BRN : 0.45 ,	RED - RED : 0.89 ORG - ORG : 2.05
Thermistor cut off temperature	°F	277	
<b>Thermistor (Coil sensor)</b>		PBC - 41E - S36	
Coil resistance	kΩ	14 °F : 23.7 ,	59 °F : 8.0
		23 °F : 18.8 ,	68 °F : 6.5
		32 °F : 15.0 ,	86 °F : 4.4
		41 °F : 12.1 ,	104 °F : 3.1
		50 °F : 9.7 ,	113 °F : 2.6
<b>Thermistor (Room or coil sensor)</b>		KTEC - 35 - S85	
Coil resistance	kΩ	32 °F : 16.5 ,	104 °F : 2.7
		41 °F : 12.8 ,	113 °F : 2.2
		50 °F : 10.0 ,	122 °F : 1.8
		68 °F : 6.3 ,	131 °F : 1.5
		86 °F : 4.0 ,	
<b>Electronic expansion valve</b>			
Valve body	HKV - 30D16		
Coil	EKV - MOZS559E0		

DATA SUBJECT TO CHANGE WITHOUT NOTICE

**1-3 Other Component Specifications**

**(A) Indoor Unit**

<b>MODEL No.</b>		<b>KH2442</b>	
<b>Power Transformer</b>		ATR – IIK244B	
Rated	Primary	AC 220 V, 60 Hz	
	Secondary	BRN - BRN : 14 V / 0.55 A, RED - RED : 14 V / 0.3 A	
	Capacity	—	
Coil resistance (Ambient temprature 77 °F)	Ω	WHT - WHT : 48.0 , BRN - BRN : 0.45 ,	RED - RED : 0.89 ORG - ORG : 2.05
Thermistor cut off temperature	°F	277	
<b>Thermistor (Coil sensor)</b>		PBC - 41E - S4	
Coil resistance	kΩ	14 °F : 23.7 , 23 °F : 18.8 , 32 °F : 15.0 , 41 °F : 12.1 , 50 °F : 9.7 ,	59 °F : 8.0 68 °F : 6.5 86 °F : 4.4 104 °F : 3.1 113 °F : 2.6
<b>Thermistor (Room or coil sensor)</b>		KTEC - 35 - S6	
Coil resistance	kΩ	32 °F : 16.5 , 41 °F : 12.8 , 50 °F : 10.0 , 68 °F : 6.3 , 86 °F : 4.0 ,	104 °F : 2.7 113 °F : 2.2 122 °F : 1.8 131 °F : 1.5
<b>Solenoid control valve or coil</b>			
Solenoid control valve		IKV - 24D11	
Solenoid coil		DKV - MOZS582E0	
Synchronized Motor		M2EA24ZA01	

DATA SUBJECT TO CHANGE WITHOUT NOTICE



**1-3 Other Component Specifications**

**(A) Indoor Unit**

<b>MODEL No.</b>		<b>KH3642</b>	
<b>Power Transformer</b>		ATR – II244B	
Rated	Primary	AC 220 V, 60 Hz	
	Secondary	BRN - BRN : 14 V / 0.55 A, RED - RED : 14 V / 0.3 A	
	Capacity	—	
Coil resistance (Ambient temprature 77 °F)	Ω	WHT - WHT : 48.0 , BRN - BRN : 0.45 ,	RED - RED : 0.89 ORG - ORG : 2.05
Thermistor cut off temperature	°F	277	
<b>Thermistor (Coil sensor)</b>		PBC - 41E - S4	
Coil resistance	kΩ	14 °F : 23.7 ,	59 °F : 8.0
		23 °F : 18.8 ,	68 °F : 6.5
		32 °F : 15.0 ,	86 °F : 4.4
		41 °F : 12.1 ,	104 °F : 3.1
		50 °F : 9.7 ,	113 °F : 2.6
<b>Thermistor (Room or coil sensor)</b>		KTEC - 35 - S6	
Coil resistance	kΩ	32 °F : 16.5 ,	104 °F : 2.7
		41 °F : 12.8 ,	113 °F : 2.2
		50 °F : 10.0 ,	122 °F : 1.8
		68 °F : 6.3 ,	131 °F : 1.5
		86 °F : 4.0 ,	
<b>Electronic expansion valve</b>			
Valve body	HKV - 30D24		
Coil	EKV - MOZS557E0		
Switch Assy's	SW - KHS2432		
Synchronized Motor	M2EA24ZA01		

DATA SUBJECT TO CHANGE WITHOUT NOTICE



1-3 Other Component Specifications

(B) Outdoor Unit

<b>MODEL No.</b>		<b>CH3642</b>	
<b>Compressor Motor Magnetic Contactor</b>		FC - 1SUL	
Coil rated		240 VAC, 60 Hz	
Coil resistance (at 68 °F)	Ω	588 ± 10 %	
Contact rated (Main)		240 VAC, 26 A	
Contact rated (Auxiliary)		240 VAC, 3 A	
<b>Power Relay</b>		HH62S	
Coil rated		240 VAC, 60 Hz	
Coil resistance (at 77 °F)	kΩ	17.2	
Contact rated		220 VAC, 5 A	
<b>Power Transformer</b>		ATR - I65C	
Rated			
Primary		220 VAC, 60 Hz	
Secondary		14 V, 0.4 A	
Capacity		5.6 VA	
Coil resistance (at 73 °F)	Ω	WHT – WHT : 395.5 , BRN – BRN : 2.19	
Thermal cut off temperature	°F	266	
<b>Thermistor (Coil sensor) : TH6, 7</b>		PBC - 41E - S4 , PBC - 41E - S36	
Coil resistance	kΩ	14 °F : 23.7 , 50 °F : 9.7 23 °F : 18.8 , 68 °F : 6.5 32 °F : 15.0 , 86 °F : 4.4 41 °F : 12.1 , 104 °F : 3.1 113 °F : 2.6	
<b>Thermistor (Comp. discharge gas sensor) : TH8</b>		PTC - 51H - S1	
Coil resistance	kΩ	140 °F : 13.8 , 194 °F : 5.1 158 °F : 9.7 , 212 °F : 3.8 167 °F : 8.2 , 230 °F : 2.8 176 °F : 7.0 , 248 °F : 2.2 185 °F : 5.9 , 266 °F : 1.7	
<b>Solenoid control valve or coil</b>			
Solenoid control valve		V 389100	
Solenoid coil		LB 59005	
<b>Thermistor (PTC)</b>		TDK – 101YV	
Rated			
Max. voltage		400 VAC	
Max. ampere		11.5 A	
Resistance (at 77 °F)	Ω	100 <sup>+30</sup> <sub>-20</sub> %	

DATA SUBJECT TO CHANGE WITHOUT NOTICE

1







1-4 Dimensional data

Indoor unit : 4-Way Air Discharge Semi-concealed Type

36, 42 Type

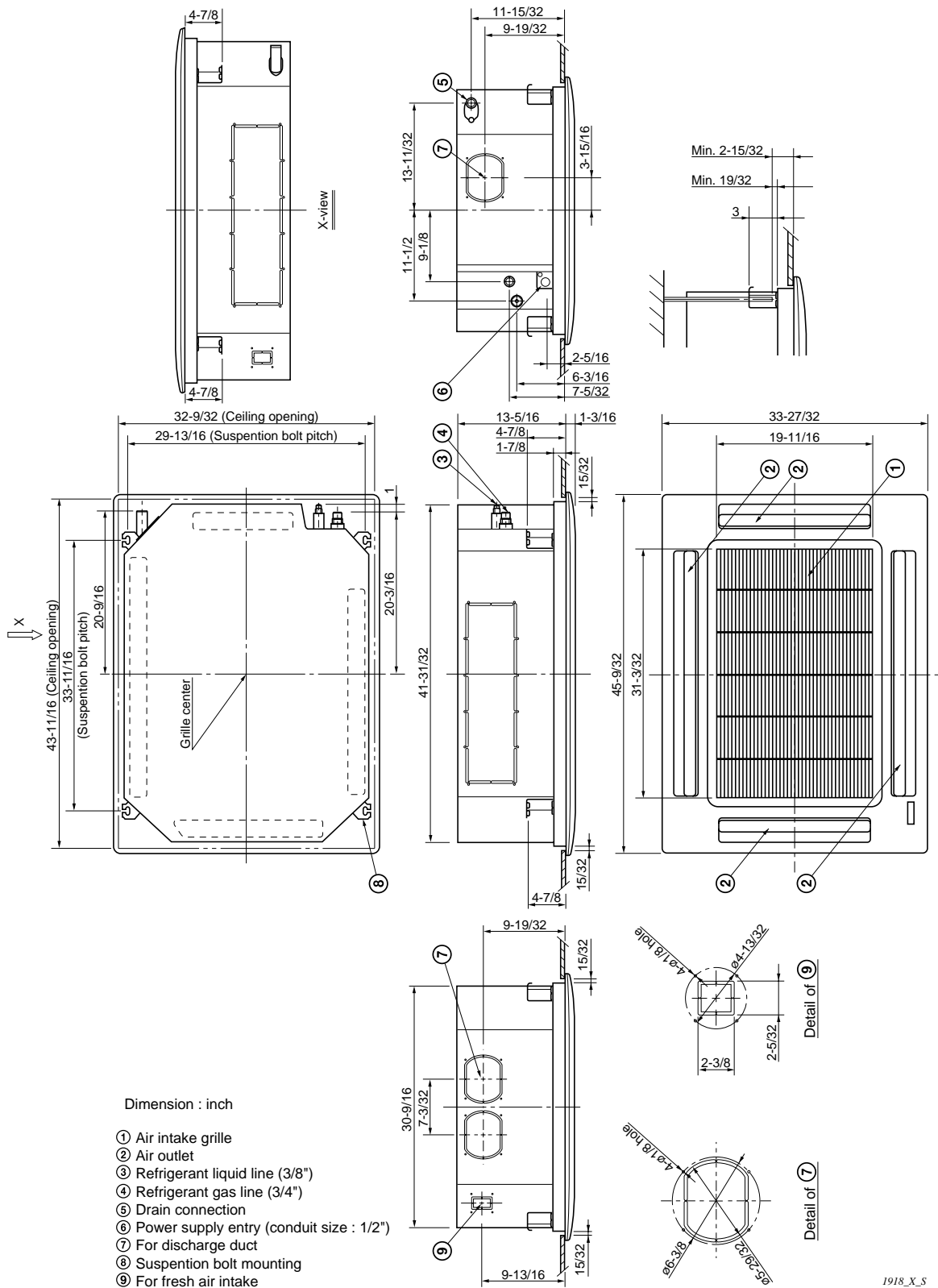

## 1-4 Dimensional data

### Indoor unit : Ceiling Mounted Type

#### 24 Type

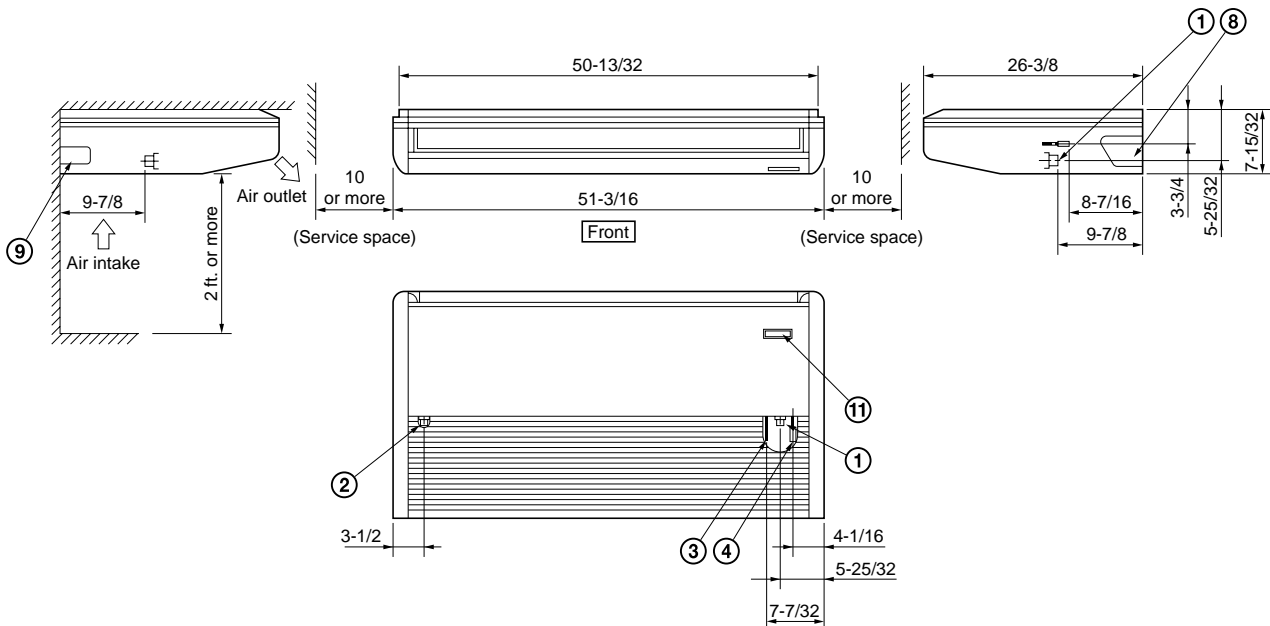
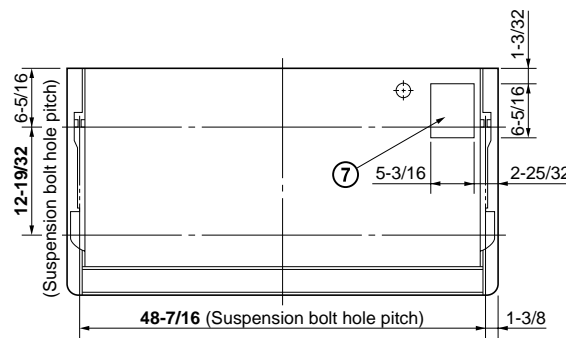
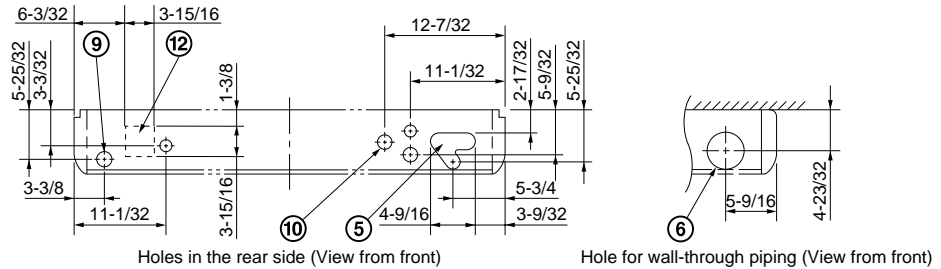

Dimension : inch

- ① Drain connection
- ② Drain connection for left side
- ③ Refrigerant liquid line (1/4") Flare connection
- ④ Refrigerant gas line (3/4") Flare connection
- ⑤ Hole for rear side refrigerant tubing
- ⑥ Hole for through-the-wall refrigerant tubing (ø3-15/16" hole)
- ⑦ Hole for fresh air intake (Knockout hole)
- ⑧ Hole for right side refrigerant tubing (Knockout hole)
- ⑨ Hole for left side drain connection (Knockout hole)
- ⑩ Hole for power supply (Conduit size 1/2")
- ⑪ Infrared rays receiver for wireless remote controller
- ⑫ Cutting position for fresh air intake

1919\_THS\_1

SM830082

## 1-4 Dimensional data

### Indoor unit : Ceiling Mounted Type

### 36, 42 Type

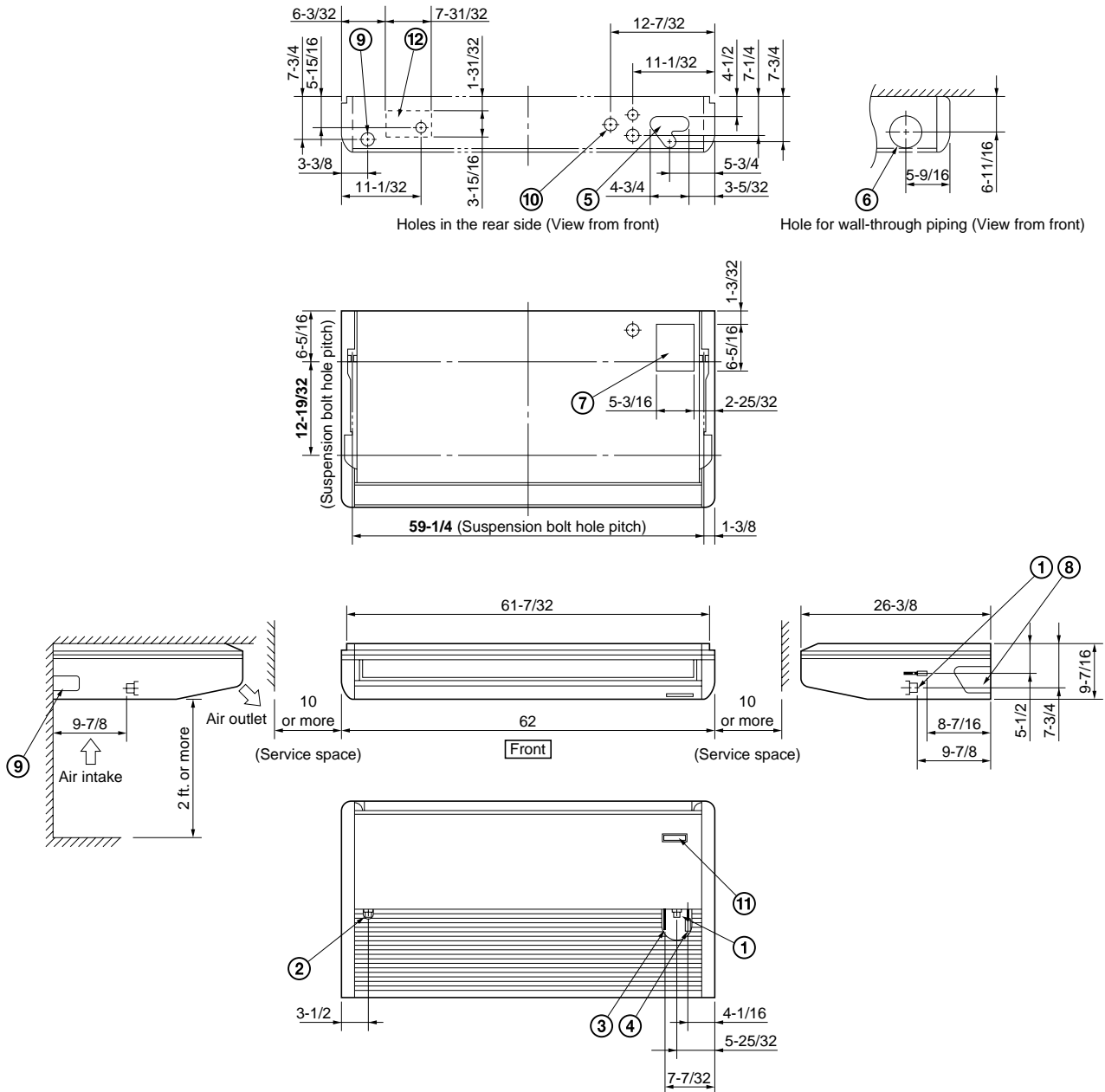

Dimension : inch

- ① Drain connection
- ② Drain connection for left side
- ③ Refrigerant liquid line (3/8") Flare connection
- ④ Refrigerant gas line (3/4") Flare connection
- ⑤ Hole for rear side refrigerant tubing
- ⑥ Hole for through-the-wall refrigerant tubing (ø3-15/16" hole)
- ⑦ Hole for fresh air intake (Knockout hole)
- ⑧ Hole for right side refrigerant tubing (Knockout hole)
- ⑨ Hole for left side drain connection (Knockout hole)
- ⑩ Hole for power supply (Conduit size 1/2")
- ⑪ Infrared rays receiver for wireless remote controller
- ⑫ Cutting position for fresh air intake

1920\_TS\_1

SM830082

1-4 Dimensional data

Indoor unit : Concealed Duct Type

24 Type

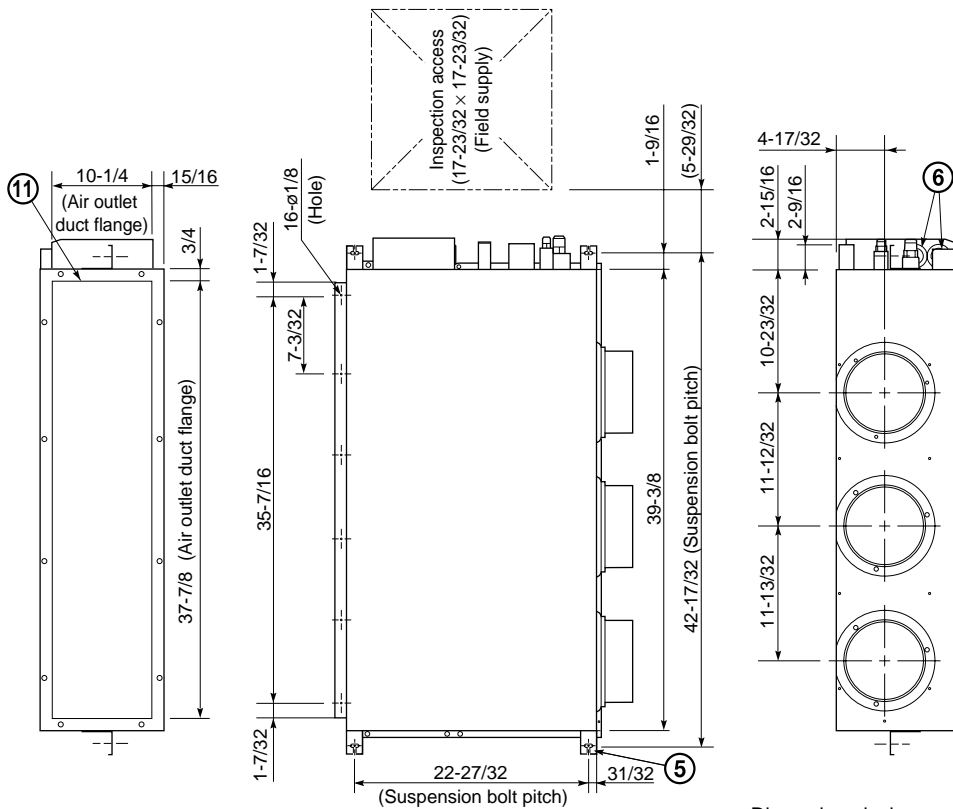
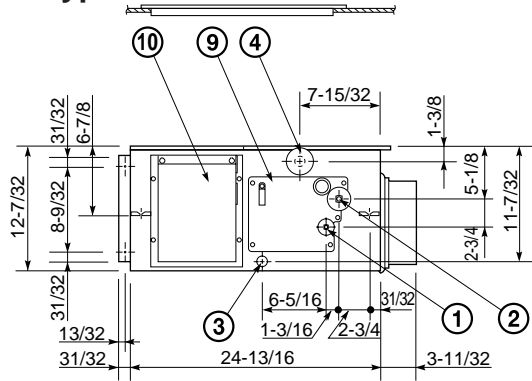

Dimension : inch

- ① Refrigerant liquid line  $\phi 3/8$  (narrow tube)  
(Use the tube connector)
- ② Refrigerant gas line  $\phi 5/8$  (wide tube)
- ③ Upper drain port (O.D. 1-1/4)
- ④ Bottom drain port (O.D. 1-1/32)
- ⑤ Suspension lug
- ⑥ Power supply inlet (conduit size 1/2")
- ⑦ Fresh air intake port ( $\phi 5-29/32$ )
- ⑧ Flange for the flexible air outlet duct ( $\phi 7-7/8$ )
- ⑨ Tube cover
- ⑩ Electrical component box
- ⑪ Flange for the air intake duct  
(option or field supply)

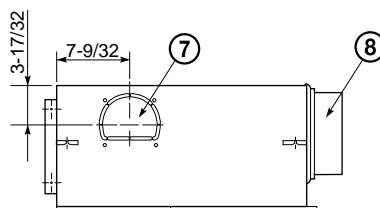

1914\_U\_1

1-4 Dimensional data

Indoor unit : Concealed Duct Type

36 Type

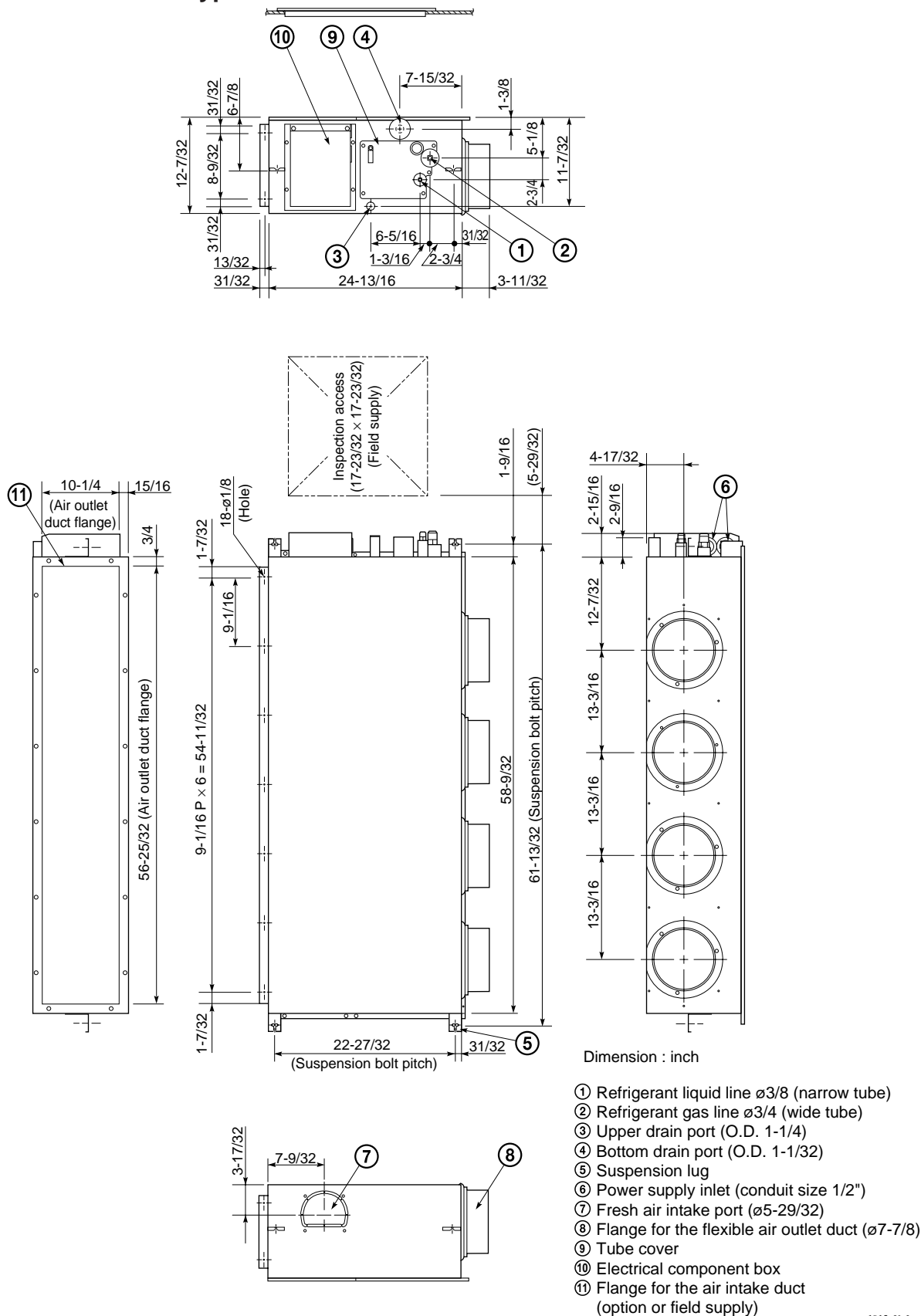

- ① Refrigerant liquid line ø3/8 (narrow tube)
- ② Refrigerant gas line ø3/4 (wide tube)
- ③ Upper drain port (O.D. 1-1/4)
- ④ Bottom drain port (O.D. 1-1/32)
- ⑤ Suspension lug
- ⑥ Power supply inlet (conduit size 1/2")
- ⑦ Fresh air intake port (ø5-29/32)
- ⑧ Flange for the flexible air outlet duct (ø7-7/8)
- ⑨ Tube cover
- ⑩ Electrical component box
- ⑪ Flange for the air intake duct (option or field supply)

1915\_U\_1

SM830082

1-4 Dimensional data

Indoor unit : Concealed Duct Type

■ Flange for the air intake duct (Field supply)  
: For Concealed Duct Type

Thickness more than T1/16 inch

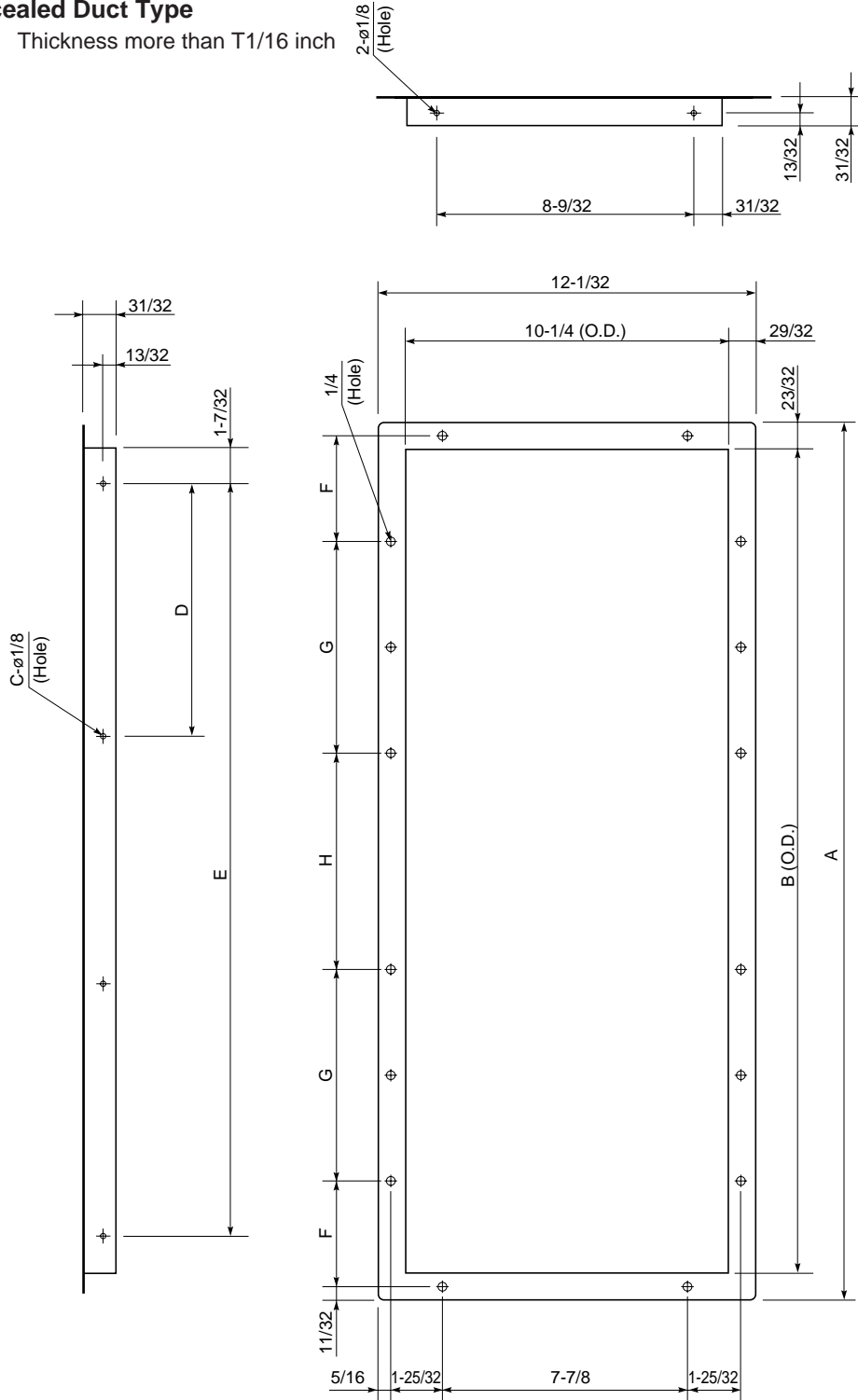

2118\_U\_1 (mm)

	A	B	C	D	E	F	G	H	I
12, 18 type	27-15/32	26-1/16	5/32	7-7/8	3 × 7-7/8P = 23-5/8	6-11/16	—	13-3/4	15/32
24 type	39-9/32	37-7/8	1/4	7-3/32	5 × 7-3/32 = 35-7/16	4-23/32	9-21/32 (9-21/32 × 1)	9-27/32	5/8
36 type	58-3/16	56-25/32	9/32	9-1/16	6 × 9-1/16 = 54-11/32	4-23/32	19-9/32 (9-21/32 × 2)	9-7/16	25/32



# 1. Specifications

## 1-4 Dimensional data

Indoor unit : Wall Mounted Type

24 Type

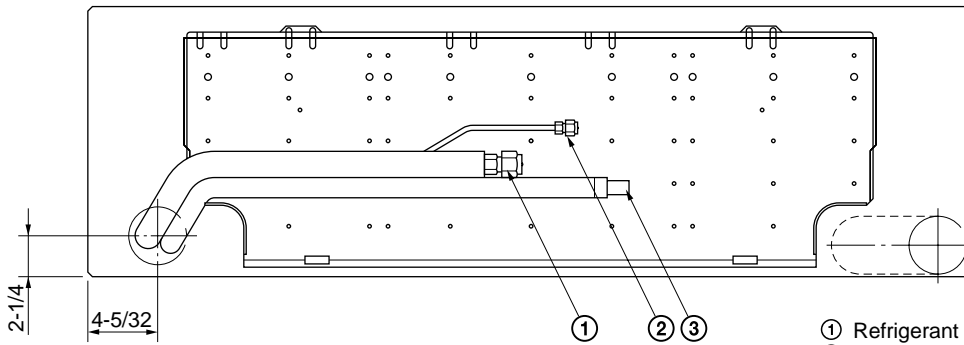
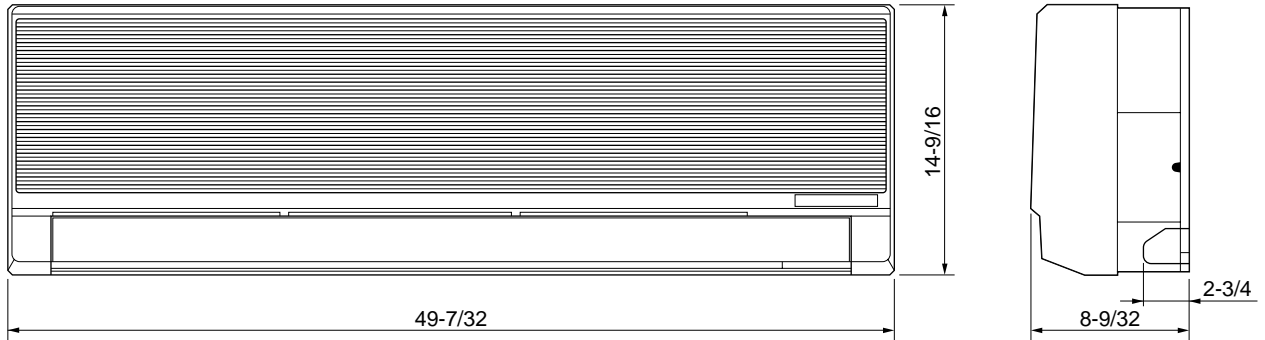

- ① Refrigerant gas line (wide tubing:  $\varnothing 3/4$ )
- ② Refrigerant liquid line (narrow tubing:  $\varnothing 1/4$ )
- ③ Drain hose OD  $1\text{-}1/4$

Dimension : inch

1911\_X\_S



# 1. Specifications

## 1-4 Dimensional data

Indoor unit : Wall Mounted Type

36 Type

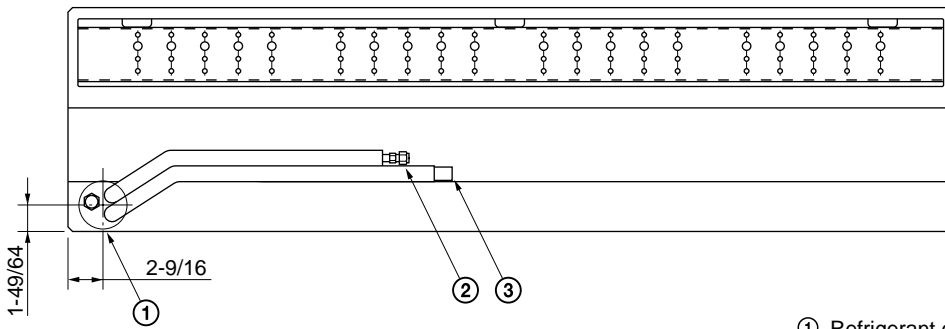
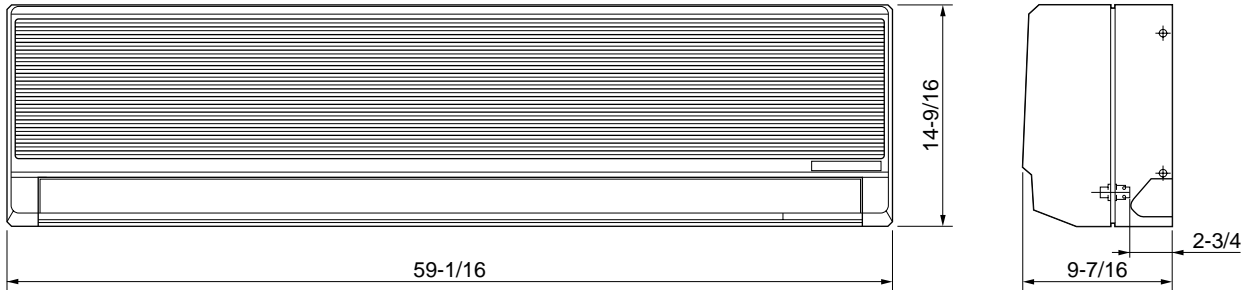

- ① Refrigerant gas line (wide tubing  $\frac{3}{4}$ " )
- ② Refrigerant liquid line (narrow tubing  $\frac{3}{8}$ " )
- ③ Drain hose OD  $1\frac{1}{4}$

Dimension : inch

1912\_X\_S

1

## 1-4 Dimensional Data

### (B) Outdoor Unit: CH2442

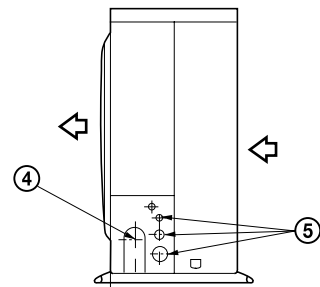
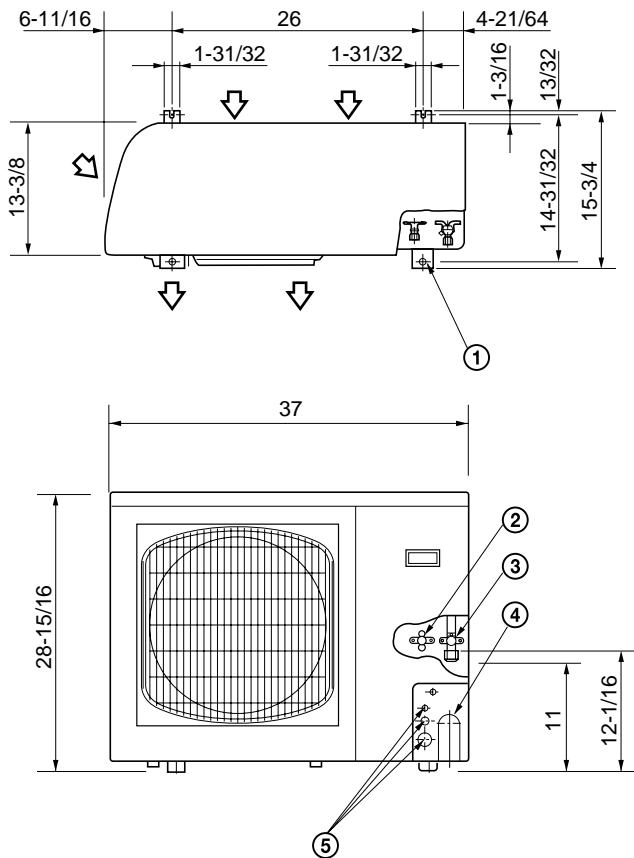

Dimension : inch

- ① Hole for anchor bolt (4- $\phi$ 1/2)
- ② Refrigerant tube joint (narrow tube)  
Flare connection 1/4 in (6.35 mm)
- ③ Refrigerant tube joint (wide tube)  
Flare connection 3/4 in (19.05 mm)
- ④ Refrigerant tubing inlet
- ⑤ Power supply inlet

2179\_THS\_I

**1-4 Dimensional Data**

**(B) Outdoor Unit: CH3642, CH4242**

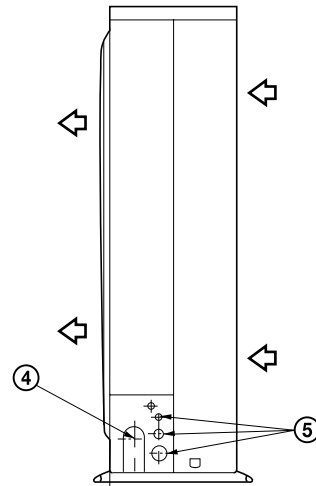
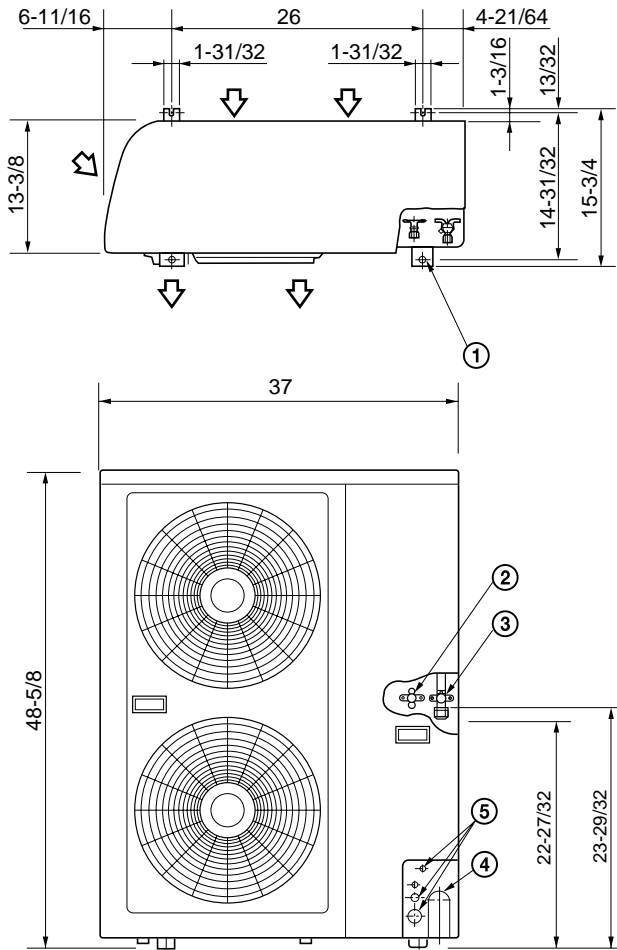

Dimension : inch

- ① Hole for anchor bolt (4- $\phi$ 13)
- ② Refrigerant tube joint (narrow tube)  
Flare connection 3/8 in (9.52 mm)
- ③ Refrigerant tube joint (wide tube)  
Flare connection 3/4 in (19.05 mm)
- ④ Refrigerant tubing inlet
- ⑤ Power supply inlet

1581\_C\_S

1-5 Refrigerant Flow Diagram

Outdoor Unit: CH2442

Indoor Unit: 24 Type

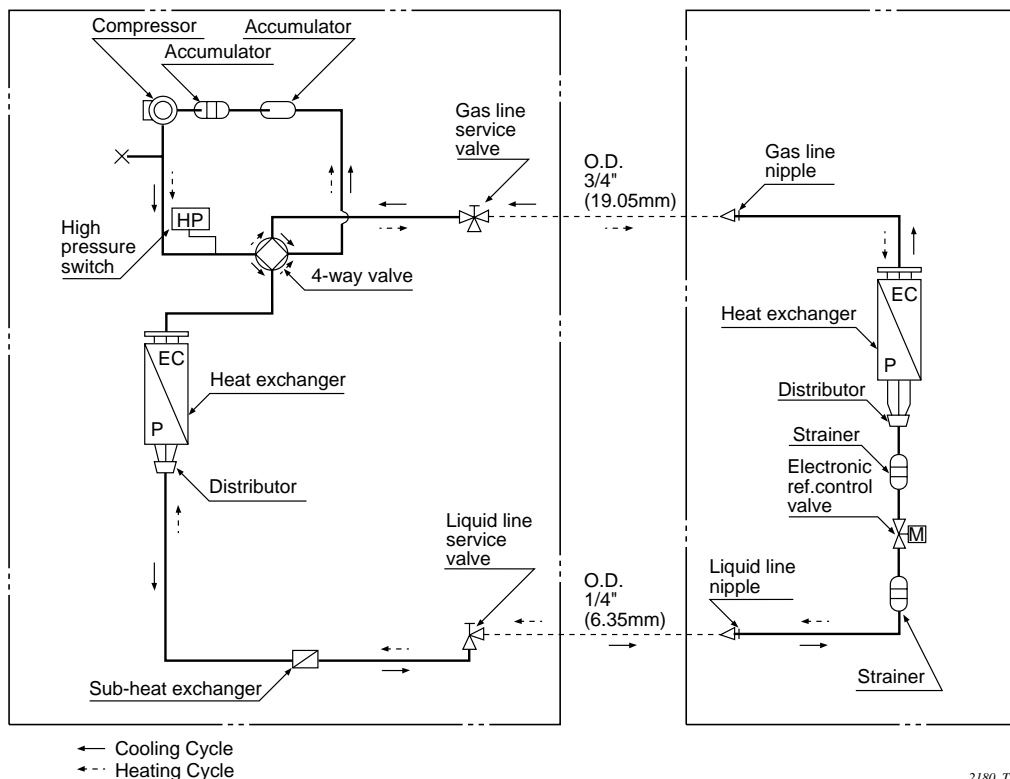

Outdoor Unit: CH3642

Indoor Unit: 36 Type

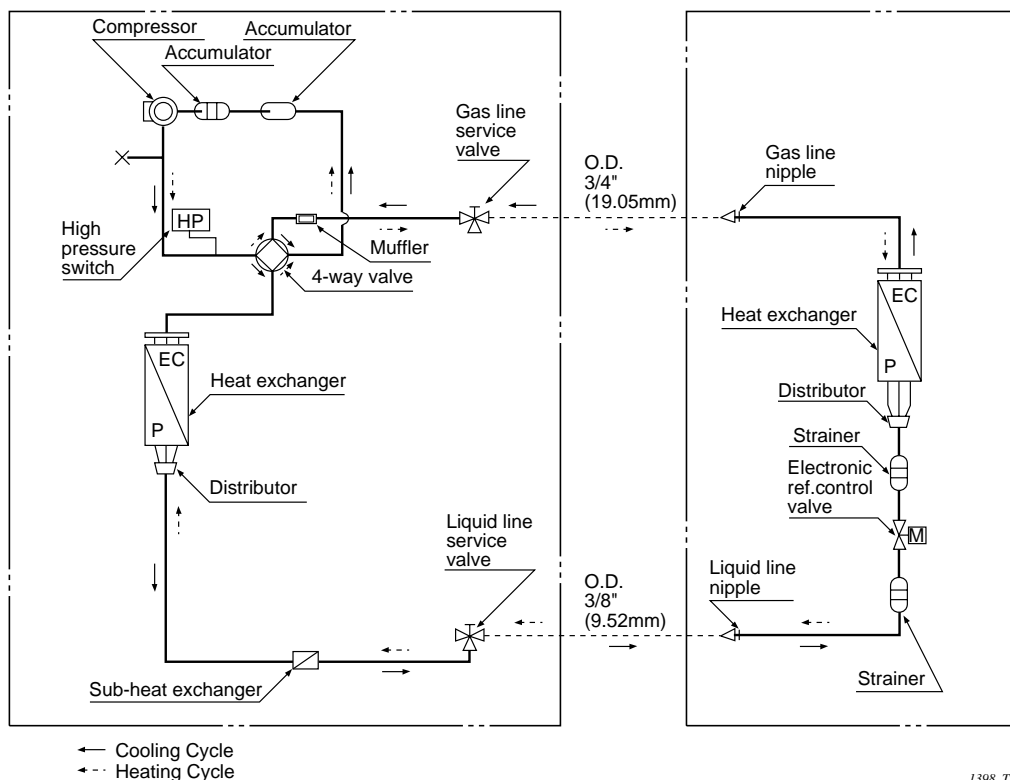

1-5 Refrigerant Flow Diagram

Outdoor Unit: CH4242

Indoor Unit: 42 Type

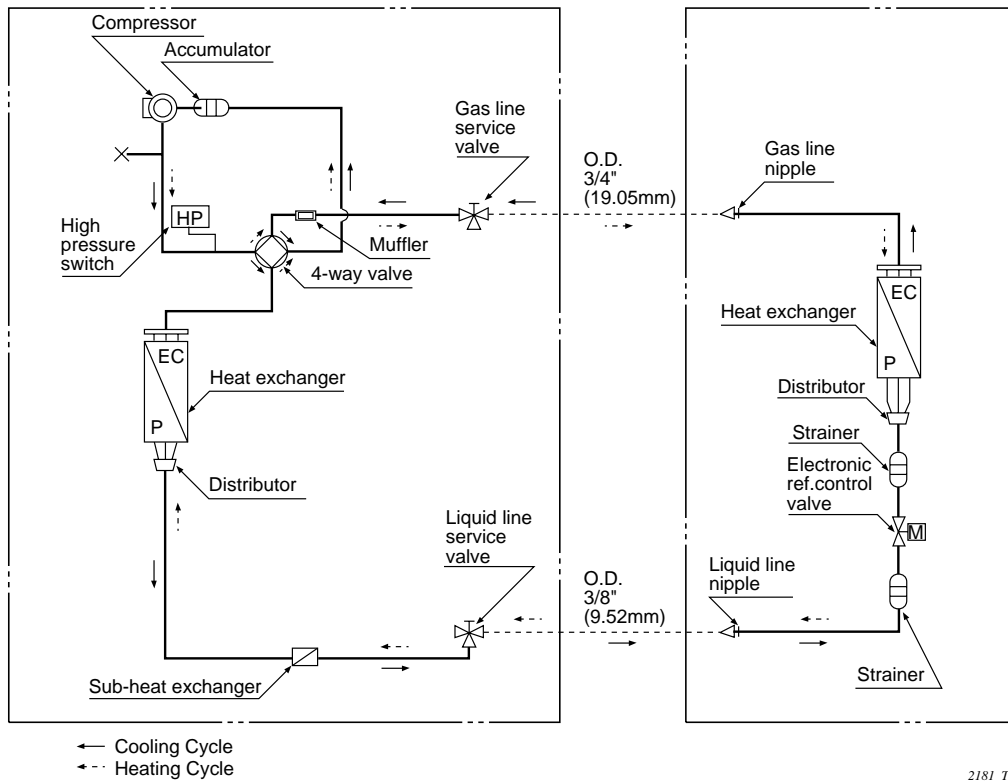

1-6 Operating Range

	Temperature	Indoor Air Intake	Outdoor Air Intake
Cooling	Maximum	95 °F DB, 71 °F WB	115 °F DB
	Minimum	67 °F DB, 57 °F WB	0 °F DB
Heating	Maximum	80 °F DB, 67 °F WB	75 °F DB, 65 °F WB
	Minimum	-DB / -WB	17 °F DB / 15 °F WB

1-7 Cooling Capacity

Indoor Unit: XH2442 Outdoor Unit: CH2442

• 230V / 1 phase / 60Hz

RATING CAPACITY :		24,000 BTU/h		AIR FLOW RATE:		540 CFM	
EVAPORATOR		CONDENSER					
ENT.TEMP.°F(°C)		AMBIENT TEMP °F(°C)					
WB	DB		75 (23.9)	85 (29.4)	95 (35.0)	105 (40.6)	115 (46.1)
59 (15.0)		TC	24,310	23,140	21,790	20,280	18,600
		CI	1.71	1.86	2.03	2.26	2.49
	72(22.2)	SHC	16,680	16,020	15,280	14,470	13,600
	76(24.4)	SHC	18,480	17,820	17,080	16,270	15,400
	80(26.7)	SHC	20,360	19,700	18,960	18,150	17,280
	84(28.9)	SHC	22,160	21,500	20,760	19,950	18,600
	88(31.1)	SHC	23,960	23,140	21,790	20,280	18,600
63 (17.2)		TC	25,220	24,100	22,900	21,530	20,040
		CI	1.72	1.89	2.06	2.29	2.52
	72(22.2)	SHC	14,330	13,750	13,140	12,460	11,750
	76(24.4)	SHC	16,130	15,550	14,940	14,260	13,550
	80(26.7)	SHC	18,010	17,430	16,820	16,140	15,430
	84(28.9)	SHC	19,810	19,230	18,620	17,940	17,230
	88(31.1)	SHC	21,610	21,030	20,420	19,740	19,030
67 (19.4)		TC	26,180	25,150	# 24,000	22,730	21,340
		CI	1.74	1.9	2.08	2.32	2.55
	72(22.2)	SHC	11,960	11,470	10,940	10,360	9,750
	76(24.4)	SHC	13,760	13,270	12,740	12,160	11,550
	80(26.7)	SHC	15,640	15,150	14,620	14,040	13,430
	84(28.9)	SHC	17,440	16,950	16,420	15,840	15,230
	88(31.1)	SHC	19,240	18,750	18,220	17,640	17,030
71 (21.7)		TC	27,580	26,620	25,580	24,460	23,210
		CI	1.76	1.92	2.11	2.35	2.59
	72(22.2)	SHC	9,650	9,230	8,790	8,330	7,820
	76(24.4)	SHC	11,450	11,030	10,590	10,130	9,620
	80(26.7)	SHC	13,330	12,910	12,470	12,010	11,500
	84(28.9)	SHC	15,130	14,710	14,270	13,810	13,300
	88(31.1)	SHC	16,930	16,510	16,070	15,610	15,100
75 (23.9)		TC	28,130	27,220	26,260	25,150	23,980
		CI	1.79	1.96	2.14	2.38	2.63
	76(24.4)	SHC	8,850	8,500	8,130	7,720	7,290
	80(26.7)	SHC	10,730	10,380	10,010	9,600	9,170
	84(28.9)	SHC	12,530	12,180	11,810	11,400	10,970
	88(31.1)	SHC	14,330	13,980	13,610	13,200	12,770

TC :Total Cooling Capacity (BTU/h)  
 SHC:Sensible Heat Capacity (BTU/h)  
 CI :Compressor Input (kW)

Rating conditions are

:Outdoor Ambient Temp.95° FDB  
 :Indoor Unit Entering Air Temp.80° FDB/67° FWB



# 1. Specifications

## Indoor Unit: XH2442 Outdoor Unit: CH2442

• 208V / 1 phase / 60Hz

RATING CAPACITY :		23,400 BTU/h		AIR FLOW RATE:		510 CFM	
EVAPORATOR		CONDENSER					
ENT.TEMP.°F(°C)		AMBIENT TEMP °F(°C)					
WB	DB		75 (23.9)	85 (29.4)	95 (35.0)	105 (40.6)	115 (46.1)
59 (15.0)		TC	23,700	22,560	21,250	19,770	18,140
		CI	1.75	1.92	2.09	2.33	2.56
	72(22.2)	SHC	16,220	15,570	14,840	14,040	13,190
	76(24.4)	SHC	17,930	17,280	16,560	15,760	14,910
	80(26.7)	SHC	19,730	19,080	18,350	17,550	16,700
	84(28.9)	SHC	21,440	20,790	20,060	19,270	18,140
	88(31.1)	SHC	23,160	22,510	21,250	19,770	18,140
63 (17.2)		TC	24,590	23,490	22,320	20,990	19,540
		CI	1.77	1.94	2.12	2.36	2.6
	72(22.2)	SHC	13,970	13,390	12,790	12,130	11,430
	76(24.4)	SHC	15,680	15,110	14,510	13,840	13,140
	80(26.7)	SHC	17,470	16,900	16,300	15,640	14,940
	84(28.9)	SHC	19,190	18,610	18,010	17,350	16,650
	88(31.1)	SHC	20,900	20,330	19,730	19,070	18,360
67 (19.4)		TC	25,530	24,520	# 23,400	22,160	20,800
		CI	1.79	1.96	2.14	2.39	2.63
	72(22.2)	SHC	11,700	11,220	10,690	10,130	9,520
	76(24.4)	SHC	13,410	12,930	12,410	11,840	11,230
	80(26.7)	SHC	15,210	14,720	14,200	13,630	13,030
	84(28.9)	SHC	16,920	16,440	15,910	15,350	14,740
	88(31.1)	SHC	18,640	18,150	17,630	17,060	16,450
71 (21.7)		TC	26,890	25,950	24,940	23,840	22,630
		CI	1.81	1.98	2.17	2.42	2.67
	72(22.2)	SHC	9,480	9,070	8,640	8,180	7,680
	76(24.4)	SHC	11,200	10,790	10,360	9,890	9,400
	80(26.7)	SHC	12,990	12,580	12,150	11,690	11,190
	84(28.9)	SHC	14,700	14,300	13,860	13,400	12,900
	88(31.1)	SHC	16,420	16,010	15,580	15,120	14,620
75 (23.9)		TC	27,420	26,540	25,600	24,520	23,380
		CI	1.84	2.01	2.2	2.46	2.71
	76(24.4)	SHC	8,700	8,360	8,000	7,590	7,170
	80(26.7)	SHC	10,490	10,150	9,790	9,380	8,960
	84(28.9)	SHC	12,210	11,870	11,500	11,100	10,670
	88(31.1)	SHC	13,920	13,580	13,220	12,810	12,390

TC :Total Cooling Capacity (BTU/h)

SHC:Sensible Heat Capacity (BTU/h)

CI :Compressor Input (kW)

Rating conditions are

:Outdoor Ambient Temp.95° FDB

:Indoor Unit Entering Air Temp.80° FDB/67° FWB



# 1. Specifications

## Indoor Unit: XH3642 Outdoor Unit: CH3642

• 230V / 1 phase / 60Hz

RATING CAPACITY :		34,500 BTU/h		AIR FLOW RATE:			980 CFM	
EVAPORATOR		CONDENSER						
ENT.TEMP.°F(°C)		AMBIENT TEMP °F(°C)						
WB	DB		75 (23.9)	85 (29.4)	95 (35.0)	105 (40.6)	115 (46.1)	
59 (15.0)		TC	34,950	33,260	31,330	29,150	26,740	
		CI	2.32	2.53	2.76	3.06	3.36	
	72(22.2)	SHC	25,700	24,850	23,890	22,840	21,700	
	76(24.4)	SHC	29,070	28,220	27,260	26,210	25,070	
	80(26.7)	SHC	32,590	31,740	30,790	29,150	26,740	
	84(28.9)	SHC	34,950	33,260	31,330	29,150	26,740	
	88(31.1)	SHC	34,950	33,260	31,330	29,150	26,740	
63 (17.2)		TC	36,260	34,640	32,910	30,950	28,810	
		CI	2.34	2.57	2.8	3.11	3.42	
	72(22.2)	SHC	21,580	20,830	20,050	19,170	18,230	
	76(24.4)	SHC	24,950	24,200	23,420	22,540	21,600	
	80(26.7)	SHC	28,480	27,730	26,940	26,060	25,130	
	84(28.9)	SHC	31,850	31,100	30,310	29,430	28,500	
	88(31.1)	SHC	35,220	34,470	32,910	30,950	28,810	
67 (19.4)		TC	37,640	36,160	# 34,500	32,670	30,670	
		CI	2.36	2.59	2.83	3.14	3.45	
	72(22.2)	SHC	17,450	16,820	16,130	15,380	14,570	
	76(24.4)	SHC	20,820	20,190	19,500	18,750	17,940	
	80(26.7)	SHC	24,340	23,710	23,020	22,270	21,470	
	84(28.9)	SHC	27,710	27,080	26,390	25,640	24,840	
	88(31.1)	SHC	31,080	30,450	29,760	29,010	28,210	
71 (21.7)		TC	39,640	38,260	36,780	35,160	33,360	
		CI	2.39	2.62	2.87	3.19	3.5	
	72(22.2)	SHC	13,330	12,800	12,240	11,630	10,960	
	76(24.4)	SHC	16,700	16,170	15,610	15,000	14,330	
	80(26.7)	SHC	20,220	19,690	19,130	18,520	17,860	
	84(28.9)	SHC	23,590	23,060	22,500	21,890	21,230	
	88(31.1)	SHC	26,960	26,430	25,870	25,260	24,600	
75 (23.9)		TC	40,430	39,120	37,740	36,160	34,470	
		CI	2.43	2.66	2.91	3.23	3.55	
	76(24.4)	SHC	12,270	11,820	11,350	10,810	10,250	
	80(26.7)	SHC	15,800	15,340	14,870	14,330	13,770	
	84(28.9)	SHC	19,170	18,710	18,240	17,700	17,140	
		88(31.1)	SHC	22,540	22,080	21,610	21,070	20,510

TC :Total Cooling Capacity (BTU/h)

SHC:Sensible Heat Capacity (BTU/h)

CI :Compressor Input (kW)

Rating conditions are

:Outdoor Ambient Temp.95° FDB

:Indoor Unit Entering Air Temp.80° FDB/67° FWB



# 1. Specifications

## Indoor Unit: XH3642 Outdoor Unit: CH3642

• 208V / 1 phase / 60Hz

RATING CAPACITY :		33,500 BTU/h		AIR FLOW RATE:			880 CFM	
EVAPORATOR		CONDENSER						
ENT.TEMP.°F(°C)		AMBIENT TEMP °F(°C)						
WB	DB		75 (23.9)	85 (29.4)	95 (35.0)	105 (40.6)	115 (46.1)	
59 (15.0)		TC	33,940	32,290	30,420	28,310	25,960	
		CI	2.21	2.41	2.62	2.96	3.3	
	72(22.2)	SHC	24,520	23,670	22,730	21,690	20,560	
	76(24.4)	SHC	27,600	26,750	25,810	24,760	23,630	
	80(26.7)	SHC	30,810	29,960	29,020	27,980	25,960	
	84(28.9)	SHC	33,890	32,290	30,420	28,310	25,960	
	88(31.1)	SHC	33,940	32,290	30,420	28,310	25,960	
63 (17.2)		TC	35,210	33,630	31,960	30,050	27,970	
		CI	2.23	2.44	2.66	3	3.35	
	72(22.2)	SHC	20,720	19,970	19,200	18,330	17,400	
	76(24.4)	SHC	23,790	23,050	22,270	21,400	20,470	
	80(26.7)	SHC	27,010	26,260	25,490	24,620	23,690	
	84(28.9)	SHC	30,080	29,340	28,560	27,690	26,760	
	88(31.1)	SHC	33,160	32,410	31,640	30,050	27,970	
67 (19.4)		TC	36,550	35,110	# 33,500	31,720	29,780	
		CI	2.25	2.46	2.69	3.04	3.38	
	72(22.2)	SHC	16,900	16,270	15,590	14,840	14,050	
	76(24.4)	SHC	19,970	19,350	18,660	17,920	17,120	
	80(26.7)	SHC	23,190	22,560	21,880	21,130	20,340	
	84(28.9)	SHC	26,260	25,640	24,950	24,210	23,410	
	88(31.1)	SHC	29,340	28,710	28,030	27,280	26,490	
71 (21.7)		TC	38,490	37,150	35,710	34,140	32,390	
		CI	2.27	2.49	2.73	3.08	3.43	
	72(22.2)	SHC	13,100	12,570	12,010	11,410	10,750	
	76(24.4)	SHC	16,180	15,650	15,090	14,490	13,830	
	80(26.7)	SHC	19,390	18,860	18,300	17,700	17,040	
	84(28.9)	SHC	22,470	21,940	21,380	20,780	20,120	
	88(31.1)	SHC	25,540	25,010	24,450	23,850	23,190	
75 (23.9)		TC	39,260	37,990	36,650	35,110	33,470	
		CI	2.31	2.53	2.77	3.13	3.48	
	76(24.4)	SHC	12,060	11,610	11,150	10,610	10,060	
	80(26.7)	SHC	15,280	14,830	14,360	13,830	13,270	
	84(28.9)	SHC	18,350	17,900	17,440	16,900	16,350	
	88(31.1)	SHC	21,430	20,980	20,510	19,980	19,420	

TC :Total Cooling Capacity (BTU/h)

SHC:Sensible Heat Capacity (BTU/h)

CI :Compressor Input (kW)

Rating conditions are

:Outdoor Ambient Temp.95° FDB

:Indoor Unit Entering Air Temp.80° FDB/67° FWB

# 1. Specifications

## Indoor Unit: XH4242 Outdoor Unit: CH4242

• 230V / 1 phase / 60Hz

RATING CAPACITY :		42,000 BTU/h		AIR FLOW RATE:			980 CFM	
EVAPORATOR		CONDENSER						
ENT.TEMP.°F(°C)		AMBIENT TEMP °F(°C)						
WB	DB		75 (23.9)	85 (29.4)	95 (35.0)	105 (40.6)	115 (46.1)	
59 (15.0)		TC	42,550	40,490	38,140	35,490	32,550	
		CI	3.03	3.3	3.6	4.02	4.44	
	72(22.2)	SHC	29,690	28,560	27,310	25,940	24,460	
	76(24.4)	SHC	33,060	31,930	30,680	29,310	27,830	
	80(26.7)	SHC	36,580	35,460	34,210	32,830	31,350	
	84(28.9)	SHC	39,950	38,830	37,580	35,490	32,550	
	88(31.1)	SHC	42,550	40,490	38,140	35,490	32,550	
63 (17.2)		TC	44,140	42,170	40,070	37,670	35,070	
		CI	3.06	3.35	3.65	4.08	4.5	
	72(22.2)	SHC	25,370	24,390	23,360	22,210	20,990	
	76(24.4)	SHC	28,740	27,760	26,730	25,580	24,360	
	80(26.7)	SHC	32,270	31,280	30,250	29,100	27,890	
	84(28.9)	SHC	35,640	34,650	33,620	32,470	31,260	
	88(31.1)	SHC	39,010	38,020	36,990	35,840	34,630	
67 (19.4)		TC	45,820	44,020	# 42,000	39,770	37,340	
		CI	3.08	3.38	3.69	4.12	4.55	
	72(22.2)	SHC	21,040	20,210	19,310	18,330	17,280	
	76(24.4)	SHC	24,410	23,580	22,680	21,700	20,650	
	80(26.7)	SHC	27,930	27,110	26,200	25,220	24,170	
	84(28.9)	SHC	31,300	30,480	29,570	28,590	27,540	
	88(31.1)	SHC	34,670	33,850	32,940	31,960	30,910	
71 (21.7)		TC	48,260	46,580	44,770	42,800	40,610	
		CI	3.11	3.41	3.75	4.18	4.62	
	72(22.2)	SHC	16,770	16,070	15,330	14,530	13,670	
	76(24.4)	SHC	20,140	19,440	18,700	17,900	17,040	
	80(26.7)	SHC	23,660	22,960	22,220	21,430	20,560	
	84(28.9)	SHC	27,030	26,330	25,590	24,800	23,930	
	88(31.1)	SHC	30,400	29,700	28,960	28,170	27,300	
75 (23.9)		TC	49,220	47,630	45,950	44,020	41,960	
		CI	3.17	3.47	3.8	4.24	4.69	
	76(24.4)	SHC	15,420	14,820	14,200	13,500	12,770	
	80(26.7)	SHC	18,940	18,350	17,730	17,020	16,290	
	84(28.9)	SHC	22,310	21,720	21,100	20,400	19,660	
		88(31.1)	SHC	25,680	25,090	24,470	23,770	23,030

TC :Total Cooling Capacity (BTU/h)

SHC:Sensible Heat Capacity (BTU/h)

CI :Compressor Input (kW)

Rating conditions are

:Outdoor Ambient Temp.95° FDB

:Indoor Unit Entering Air Temp.80° FDB/67° FWB



# 1. Specifications

## Indoor Unit: XH4242 Outdoor Unit: CH4242

• 208V / 1 phase / 60Hz

RATING CAPACITY :		40,000 BTU/h		AIR FLOW RATE:		880 CFM	
EVAPORATOR		CONDENSER					
ENT.TEMP.°F(°C)		AMBIENT TEMP °F(°C)					
WB	DB		75 (23.9)	85 (29.4)	95 (35.0)	105 (40.6)	115 (46.1)
59 (15.0)		TC	40,520	38,560	36,320	33,800	31,000
		CI	2.91	3.18	3.46	3.92	4.38
	72(22.2)	SHC	28,050	26,960	25,750	24,420	22,990
	76(24.4)	SHC	31,120	30,040	28,820	27,490	26,060
	80(26.7)	SHC	34,340	33,250	32,040	30,710	29,280
	84(28.9)	SHC	37,410	36,330	35,110	33,780	31,000
	88(31.1)	SHC	40,490	38,560	36,320	33,800	31,000
63 (17.2)		TC	42,040	40,160	38,160	35,880	33,400
		CI	2.94	3.22	3.51	3.98	4.45
	72(22.2)	SHC	24,070	23,110	22,120	21,010	19,830
	76(24.4)	SHC	27,150	26,190	25,190	24,080	22,900
	80(26.7)	SHC	30,360	29,400	28,410	27,300	26,120
	84(28.9)	SHC	33,440	32,480	31,480	30,370	29,190
	88(31.1)	SHC	36,510	35,550	34,560	33,450	32,270
67 (19.4)		TC	43,640	41,920	# 40,000	37,880	35,560
		CI	2.96	3.25	3.55	4.02	4.49
	72(22.2)	SHC	20,070	19,270	18,390	17,440	16,430
	76(24.4)	SHC	23,150	22,340	21,470	20,520	19,500
	80(26.7)	SHC	26,360	25,560	24,680	23,730	22,720
	84(28.9)	SHC	29,440	28,630	27,760	26,810	25,790
	88(31.1)	SHC	32,510	31,710	30,830	29,880	28,870
71 (21.7)		TC	45,960	44,360	42,640	40,760	38,680
		CI	3	3.28	3.6	4.08	4.56
	72(22.2)	SHC	16,140	15,460	14,740	13,970	13,140
	76(24.4)	SHC	19,220	18,540	17,820	17,050	16,210
	80(26.7)	SHC	22,430	21,750	21,030	20,260	19,430
	84(28.9)	SHC	25,510	24,830	24,110	23,340	22,500
	88(31.1)	SHC	28,580	27,900	27,180	26,410	25,580
75 (23.9)		TC	46,880	45,360	43,760	41,920	39,960
		CI	3.05	3.34	3.66	4.14	4.62
	76(24.4)	SHC	14,840	14,260	13,660	12,980	12,270
	80(26.7)	SHC	18,060	17,480	16,880	16,200	15,490
	84(28.9)	SHC	21,130	20,550	19,950	19,270	18,560
	88(31.1)	SHC	24,210	23,630	23,030	22,350	21,640

TC :Total Cooling Capacity (BTU/h)

SHC:Sensible Heat Capacity (BTU/h)

CI :Compressor Input (kW)

Rating conditions are

:Outdoor Ambient Temp.95° FDB

:Indoor Unit Entering Air Temp.80° FDB/67° FWB

# 1. Specifications

## Indoor Unit: TH2442 Outdoor Unit: CH2442

• 230V / 1 phase / 60Hz

RATING CAPACITY :		22,400 BTU/h		AIR FLOW RATE:		460 CFM	
EVAPORATOR		CONDENSER					
ENT.TEMP.°F(°C)		AMBIENT TEMP °F(°C)					
WB	DB		75 (23.9)	85 (29.4)	95 (35.0)	105 (40.6)	115 (46.1)
59 (15.0)		TC	22,690	21,590	20,340	18,930	17,360
		CI	1.71	1.86	2.03	2.26	2.49
	72(22.2)	SHC	15,520	14,890	14,190	13,430	12,610
	76(24.4)	SHC	17,140	16,510	15,820	15,050	14,230
	80(26.7)	SHC	18,840	18,210	17,510	16,750	15,930
	84(28.9)	SHC	20,460	19,830	19,140	18,370	17,360
63 (17.2)		TC	23,540	22,490	21,370	20,090	18,700
		CI	1.72	1.89	2.06	2.29	2.52
	72(22.2)	SHC	13,380	12,830	12,250	11,610	10,940
	76(24.4)	SHC	15,000	14,450	13,880	13,240	12,560
	80(26.7)	SHC	16,700	16,150	15,570	14,930	14,260
	84(28.9)	SHC	18,320	17,770	17,200	16,560	15,880
67 (19.4)		TC	24,440	23,480	# 22,400	21,210	19,910
		CI	1.74	1.9	2.08	2.32	2.55
	72(22.2)	SHC	11,230	10,770	10,260	9,710	9,130
	76(24.4)	SHC	12,850	12,390	11,880	11,340	10,750
	80(26.7)	SHC	14,550	14,090	13,580	13,030	12,450
	84(28.9)	SHC	16,170	15,710	15,200	14,660	14,080
71 (21.7)		TC	25,740	24,840	23,880	22,830	21,660
		CI	1.76	1.92	2.11	2.35	2.59
	72(22.2)	SHC	9,130	8,730	8,320	7,880	7,390
	76(24.4)	SHC	10,750	10,360	9,940	9,500	9,020
	80(26.7)	SHC	12,450	12,050	11,640	11,200	10,710
	84(28.9)	SHC	14,070	13,680	13,260	12,820	12,340
75 (23.9)		TC	26,250	25,400	24,510	23,480	22,380
		CI	1.79	1.96	2.14	2.38	2.63
	76(24.4)	SHC	8,380	8,050	7,700	7,310	6,900
	80(26.7)	SHC	10,080	9,740	9,400	9,010	8,600
	84(28.9)	SHC	11,700	11,370	11,020	10,630	10,220
	88(31.1)	SHC	13,320	12,990	12,650	12,250	11,850

TC :Total Cooling Capacity (BTU/h)

SHC:Sensible Heat Capacity (BTU/h)

CI :Compressor Input (kW)

Rating conditions are

:Outdoor Ambient Temp.95° FDB

:Indoor Unit Entering Air Temp.80° FDB/67° FWB



# 1. Specifications

**Indoor Unit: TH2442 Outdoor Unit: CH2442**

• 208V / 1 phase / 60Hz

RATING CAPACITY :		21,600 BTU/h		AIR FLOW RATE:		410 CFM	
EVAPORATOR		CONDENSER					
ENT.TEMP.°F(°C)		AMBIENT TEMP °F(°C)					
WB	DB		75 (23.9)	85 (29.4)	95 (35.0)	105 (40.6)	115 (46.1)
59 (15.0)		TC	21,880	20,820	19,610	18,250	16,740
		CI	1.75	1.92	2.09	2.33	2.56
	72(22.2)	SHC	14,850	14,220	13,530	12,770	11,960
	76(24.4)	SHC	16,320	15,690	15,000	14,240	13,430
	80(26.7)	SHC	17,860	17,230	16,540	15,780	14,970
	84(28.9)	SHC	19,330	18,700	18,010	17,250	16,440
63 (17.2)		TC	22,700	21,690	20,610	19,380	18,040
		CI	1.77	1.94	2.12	2.36	2.6
	72(22.2)	SHC	12,870	12,320	11,750	11,120	10,450
	76(24.4)	SHC	14,340	13,800	13,220	12,590	11,920
	80(26.7)	SHC	15,880	15,330	14,760	14,130	13,460
	84(28.9)	SHC	17,350	16,800	16,230	15,600	14,930
67 (19.4)		TC	23,570	22,640	# 21,600	20,460	19,200
		CI	1.79	1.96	2.14	2.39	2.63
	72(22.2)	SHC	10,890	10,420	9,920	9,380	8,800
	76(24.4)	SHC	12,360	11,900	11,390	10,850	10,270
	80(26.7)	SHC	13,900	13,430	12,930	12,390	11,810
	84(28.9)	SHC	15,370	14,910	14,400	13,860	13,280
71 (21.7)		TC	24,820	23,950	23,030	22,010	20,890
		CI	1.81	1.98	2.17	2.42	2.67
	72(22.2)	SHC	8,950	8,560	8,150	7,710	7,230
	76(24.4)	SHC	10,420	10,030	9,620	9,180	8,700
	80(26.7)	SHC	11,960	11,570	11,160	10,720	10,240
	84(28.9)	SHC	13,430	13,040	12,630	12,190	11,710
75 (23.9)		TC	25,320	24,490	23,630	22,640	21,580
		CI	1.84	2.01	2.2	2.46	2.71
	76(24.4)	SHC	8,220	7,880	7,540	7,150	6,750
	80(26.7)	SHC	9,760	9,420	9,080	8,690	8,290
	84(28.9)	SHC	11,230	10,890	10,550	10,160	9,760
	88(31.1)	SHC	12,700	12,360	12,020	11,630	11,230

TC :Total Cooling Capacity (BTU/h)

SHC:Sensible Heat Capacity (BTU/h)

CI :Compressor Input (kW)

Rating conditions are

:Outdoor Ambient Temp.95° FDB

:Indoor Unit Entering Air Temp.80° FDB/67° FWB

# 1. Specifications

## Indoor Unit: TH3642 Outdoor Unit: CH3642

• 230V / 1 phase / 60Hz

RATING CAPACITY :		34,000 BTU/h		AIR FLOW RATE:		900 CFM	
EVAPORATOR		CONDENSER					
ENT.TEMP.°F(°C)		AMBIENT TEMP °F(°C)					
WB	DB		75 (23.9)	85 (29.4)	95 (35.0)	105 (40.6)	115 (46.1)
59 (15.0)		TC	34,440	32,780	30,870	28,730	26,350
		CI	2.32	2.53	2.76	3.06	3.36
	72(22.2)	SHC	24,970	24,120	23,160	22,110	20,970
	76(24.4)	SHC	28,140	27,290	26,330	25,280	24,140
	80(26.7)	SHC	31,460	30,610	29,650	28,600	26,350
	84(28.9)	SHC	34,440	32,780	30,870	28,730	26,350
63 (17.2)		TC	35,730	34,140	32,440	30,500	28,390
		CI	2.34	2.57	2.8	3.11	3.42
	72(22.2)	SHC	21,060	20,310	19,520	18,640	17,710
	76(24.4)	SHC	24,230	23,480	22,690	21,810	20,880
	80(26.7)	SHC	27,540	26,800	26,010	25,130	24,190
	84(28.9)	SHC	30,720	29,970	29,180	28,300	27,370
67 (19.4)		TC	37,090	35,630	# 34,000	32,200	30,230
		CI	2.36	2.59	2.83	3.14	3.45
	72(22.2)	SHC	17,120	16,500	15,810	15,060	14,250
	76(24.4)	SHC	20,300	19,670	18,980	18,230	17,420
	80(26.7)	SHC	23,610	22,980	22,290	21,550	20,740
	84(28.9)	SHC	26,780	26,160	25,470	24,720	23,910
71 (21.7)		TC	39,070	37,710	36,240	34,650	32,880
		CI	2.39	2.62	2.87	3.19	3.5
	72(22.2)	SHC	13,220	12,690	12,120	11,520	10,850
	76(24.4)	SHC	16,400	15,860	15,290	14,690	14,020
	80(26.7)	SHC	19,710	19,180	18,610	18,000	17,340
	84(28.9)	SHC	22,880	22,350	21,780	21,180	20,510
75 (23.9)		TC	39,850	38,560	37,200	35,630	33,970
		CI	2.43	2.66	2.91	3.23	3.55
	76(24.4)	SHC	12,170	11,720	11,240	10,700	10,140
	80(26.7)	SHC	15,490	15,030	14,560	14,020	13,460
	84(28.9)	SHC	18,660	18,200	17,730	17,190	16,630
	88(31.1)	SHC	21,830	21,380	20,900	20,360	19,800

TC :Total Cooling Capacity (BTU/h)

SHC:Sensible Heat Capacity (BTU/h)

CI :Compressor Input (kW)

Rating conditions are

:Outdoor Ambient Temp.95° FDB

:Indoor Unit Entering Air Temp.80° FDB/67° FWB

# 1. Specifications

## Indoor Unit: TH3642 Outdoor Unit: CH3642

• 208V / 1 phase / 60Hz

RATING CAPACITY :		33,000 BTU/h		AIR FLOW RATE:			800 CFM	
EVAPORATOR		CONDENSER						
ENT.TEMP.°F(°C)		AMBIENT TEMP °F(°C)						
WB	DB		75 (23.9)	85 (29.4)	95 (35.0)	105 (40.6)	115 (46.1)	
59 (15.0)		TC	33,430	31,810	29,960	27,890	25,580	
		CI	2.21	2.41	2.62	2.96	3.3	
	72(22.2)	SHC	23,800	22,940	21,990	20,950	19,820	
	76(24.4)	SHC	26,660	25,810	24,860	23,820	22,690	
	80(26.7)	SHC	29,660	28,810	27,860	26,810	25,580	
	84(28.9)	SHC	32,530	31,680	29,960	27,890	25,580	
	88(31.1)	SHC	33,430	31,810	29,960	27,890	25,580	
63 (17.2)		TC	34,680	33,130	31,480	29,600	27,560	
		CI	2.23	2.44	2.66	3	3.35	
	72(22.2)	SHC	20,200	19,450	18,670	17,800	16,870	
	76(24.4)	SHC	23,070	22,320	21,540	20,670	19,740	
	80(26.7)	SHC	26,070	25,320	24,540	23,660	22,740	
	84(28.9)	SHC	28,930	28,190	27,400	26,530	25,600	
	88(31.1)	SHC	31,800	31,050	30,270	29,400	27,560	
67 (19.4)		TC	36,000	34,580	# 33,000	31,250	29,340	
		CI	2.25	2.46	2.69	3.04	3.38	
	72(22.2)	SHC	16,590	15,960	15,280	14,530	13,730	
	76(24.4)	SHC	19,460	18,830	18,140	17,400	16,600	
	80(26.7)	SHC	22,460	21,830	21,140	20,400	19,600	
	84(28.9)	SHC	25,320	24,700	24,010	23,260	22,470	
	88(31.1)	SHC	28,190	27,560	26,880	26,130	25,330	
71 (21.7)		TC	37,920	36,600	35,180	33,630	31,910	
		CI	2.27	2.49	2.73	3.08	3.43	
	72(22.2)	SHC	13,020	12,490	11,930	11,320	10,660	
	76(24.4)	SHC	15,890	15,360	14,790	14,190	13,530	
	80(26.7)	SHC	18,890	18,350	17,790	17,190	16,530	
	84(28.9)	SHC	21,750	21,220	20,660	20,050	19,390	
	88(31.1)	SHC	24,620	24,090	23,530	22,920	22,260	
75 (23.9)		TC	38,680	37,420	36,100	34,580	32,970	
		CI	2.31	2.53	2.77	3.13	3.48	
	76(24.4)	SHC	11,990	11,530	11,060	10,520	9,970	
	80(26.7)	SHC	14,980	14,530	14,060	13,520	12,960	
	84(28.9)	SHC	17,850	17,390	16,920	16,390	15,830	
	88(31.1)	SHC	20,720	20,260	19,790	19,260	18,700	

TC :Total Cooling Capacity (BTU/h)

SHC:Sensible Heat Capacity (BTU/h)

CI :Compressor Input (kW)

Rating conditions are

:Outdoor Ambient Temp.95° FDB

:Indoor Unit Entering Air Temp.80° FDB/67° FWB



# 1. Specifications

## Indoor Unit: TH4242 Outdoor Unit: CH4242

• 230V / 1 phase / 60Hz

RATING CAPACITY :		42,000 BTU/h		AIR FLOW RATE:			900 CFM	
EVAPORATOR		CONDENSER						
ENT.TEMP.°F(°C)		AMBIENT TEMP °F(°C)						
WB	DB		75 (23.9)	85 (29.4)	95 (35.0)	105 (40.6)	115 (46.1)	
59 (15.0)		TC	42,550	40,490	38,140	35,490	32,550	
		CI	3.03	3.3	3.6	4.02	4.44	
	72(22.2)	SHC	29,360	28,200	26,920	25,510	24,000	
	76(24.4)	SHC	32,530	31,380	30,090	28,690	27,170	
	80(26.7)	SHC	35,850	34,690	33,410	32,000	30,490	
	84(28.9)	SHC	39,020	37,860	36,580	35,170	32,550	
	88(31.1)	SHC	42,190	40,490	38,140	35,490	32,550	
63 (17.2)		TC	44,140	42,170	40,070	37,670	35,070	
		CI	3.06	3.35	3.65	4.08	4.5	
	72(22.2)	SHC	25,230	24,220	23,160	21,990	20,740	
	76(24.4)	SHC	28,400	27,390	26,340	25,160	23,920	
	80(26.7)	SHC	31,720	30,710	29,650	28,470	27,230	
	84(28.9)	SHC	34,890	33,880	32,820	31,650	30,400	
	88(31.1)	SHC	38,060	37,050	36,000	34,820	33,580	
67 (19.4)		TC	45,820	44,020	# 42,000	39,770	37,340	
		CI	3.08	3.38	3.69	4.12	4.55	
	72(22.2)	SHC	21,080	20,240	19,310	18,300	17,230	
	76(24.4)	SHC	24,260	23,410	22,480	21,470	20,410	
	80(26.7)	SHC	27,570	26,730	25,790	24,790	23,720	
	84(28.9)	SHC	30,740	29,900	28,970	27,960	26,890	
	88(31.1)	SHC	33,920	33,070	32,140	31,130	30,070	
71 (21.7)		TC	48,260	46,580	44,770	42,800	40,610	
		CI	3.11	3.41	3.75	4.18	4.62	
	72(22.2)	SHC	17,020	16,300	15,540	14,720	13,840	
	76(24.4)	SHC	20,190	19,470	18,710	17,890	17,010	
	80(26.7)	SHC	23,510	22,790	22,020	21,210	20,320	
	84(28.9)	SHC	26,680	25,960	25,200	24,380	23,500	
	88(31.1)	SHC	29,850	29,130	28,370	27,550	26,670	
75 (23.9)		TC	49,220	47,630	45,950	44,020	41,960	
		CI	3.17	3.47	3.8	4.24	4.69	
	76(24.4)	SHC	15,640	15,030	14,400	13,680	12,930	
	80(26.7)	SHC	18,960	18,350	17,710	16,990	16,240	
	84(28.9)	SHC	22,130	21,520	20,880	20,170	19,410	
		88(31.1)	SHC	25,300	24,690	24,060	23,340	22,590

TC :Total Cooling Capacity (BTU/h)

SHC:Sensible Heat Capacity (BTU/h)

CI :Compressor Input (kW)

Rating conditions are

:Outdoor Ambient Temp.95° FDB

:Indoor Unit Entering Air Temp.80° FDB/67° FWB



# 1. Specifications

## Indoor Unit: TH4242 Outdoor Unit: CH4242

• 208V / 1 phase / 60Hz

RATING CAPACITY :		40,000 BTU/h		AIR FLOW RATE:			800 CFM	
EVAPORATOR		CONDENSER						
ENT.TEMP.°F(°C)		AMBIENT TEMP °F(°C)						
WB	DB		75 (23.9)	85 (29.4)	95 (35.0)	105 (40.6)	115 (46.1)	
59 (15.0)		TC	40,520	38,560	36,320	33,800	31,000	
		CI	2.91	3.18	3.46	4.16	4.86	
	72(22.2)	SHC	27,740	26,610	25,360	23,990	22,520	
	76(24.4)	SHC	30,610	29,480	28,230	26,860	25,390	
	80(26.7)	SHC	33,600	32,480	31,230	29,860	28,390	
	84(28.9)	SHC	36,470	35,350	34,090	32,730	31,000	
	88(31.1)	SHC	39,340	38,210	36,320	33,800	31,000	
63 (17.2)		TC	42,040	40,160	38,160	35,880	33,400	
		CI	2.94	3.22	3.51	4.22	4.93	
	72(22.2)	SHC	23,960	22,960	21,940	20,790	19,580	
	76(24.4)	SHC	26,820	25,830	24,800	23,660	22,450	
	80(26.7)	SHC	29,820	28,830	27,800	26,660	25,450	
	84(28.9)	SHC	32,690	31,700	30,670	29,520	28,320	
	88(31.1)	SHC	35,560	34,560	33,540	32,390	31,180	
67 (19.4)		TC	43,640	41,920	# 40,000	37,880	35,560	
		CI	2.96	3.25	3.55	4.27	4.98	
	72(22.2)	SHC	20,150	19,320	18,410	17,440	16,400	
	76(24.4)	SHC	23,020	22,190	21,280	20,300	19,260	
	80(26.7)	SHC	26,010	25,190	24,280	23,300	22,260	
	84(28.9)	SHC	28,880	28,050	27,150	26,170	25,130	
	88(31.1)	SHC	31,750	30,920	30,010	29,040	28,000	
71 (21.7)		TC	45,960	44,360	42,640	40,760	38,680	
		CI	3	3.28	3.6	4.33	5.05	
	72(22.2)	SHC	16,430	15,730	14,990	14,190	13,330	
	76(24.4)	SHC	19,300	18,600	17,850	17,060	16,200	
	80(26.7)	SHC	22,300	21,590	20,850	20,060	19,200	
	84(28.9)	SHC	25,160	24,460	23,720	22,920	22,060	
	88(31.1)	SHC	28,030	27,330	26,590	25,790	24,930	
75 (23.9)		TC	46,880	45,360	43,760	41,920	39,960	
		CI	3.05	3.34	3.66	4.39	5.13	
	76(24.4)	SHC	15,100	14,510	13,890	13,190	12,450	
	80(26.7)	SHC	18,100	17,500	16,880	16,180	15,450	
	84(28.9)	SHC	20,970	20,370	19,750	19,050	18,320	
		88(31.1)	SHC	23,840	23,240	22,620	21,920	21,190

TC :Total Cooling Capacity (BTU/h)

SHC:Sensible Heat Capacity (BTU/h)

CI :Compressor Input (kW)

Rating conditions are

:Outdoor Ambient Temp.95° FDB

:Indoor Unit Entering Air Temp.80° FDB/67° FWB

# 1. Specifications

## Indoor Unit: UH2442 Outdoor Unit: CH2442

• 230V / 1 phase / 60Hz

RATING CAPACITY :		24,000 BTU/h		AIR FLOW RATE:			670 CFM	
EVAPORATOR		CONDENSER						
ENT.TEMP.°F(°C)		AMBIENT TEMP °F(°C)						
WB	DB		75 (23.9)	85 (29.4)	95 (35.0)	105 (40.6)	115 (46.1)	
59 (15.0)		TC	24,310	23,140	21,790	20,280	18,600	
		CI	1.71	1.86	2.03	2.26	2.49	
	72(22.2)	SHC	16,820	16,180	15,450	14,660	13,810	
	76(24.4)	SHC	18,720	18,080	17,350	16,560	15,710	
	80(26.7)	SHC	20,710	20,070	19,340	18,550	17,700	
	84(28.9)	SHC	22,610	21,970	21,240	20,280	18,600	
	88(31.1)	SHC	24,310	23,140	21,790	20,280	18,600	
63 (17.2)		TC	25,220	24,100	22,900	21,530	20,040	
		CI	1.72	1.89	2.06	2.29	2.52	
	72(22.2)	SHC	14,370	13,810	13,210	12,550	11,850	
	76(24.4)	SHC	16,270	15,710	15,110	14,450	13,750	
	80(26.7)	SHC	18,260	17,690	17,100	16,440	15,740	
	84(28.9)	SHC	20,160	19,600	19,000	18,340	17,640	
	88(31.1)	SHC	22,060	21,500	20,900	20,240	19,540	
67 (19.4)		TC	26,180	25,150	# 24,000	22,730	21,340	
		CI	1.74	1.9	2.08	2.32	2.55	
	72(22.2)	SHC	11,910	11,430	10,910	10,350	9,750	
	76(24.4)	SHC	13,810	13,330	12,810	12,250	11,650	
	80(26.7)	SHC	15,800	15,320	14,800	14,240	13,630	
	84(28.9)	SHC	17,700	17,220	16,700	16,140	15,530	
	88(31.1)	SHC	19,600	19,120	18,600	18,040	17,430	
71 (21.7)		TC	27,580	26,620	25,580	24,460	23,210	
		CI	1.76	1.92	2.11	2.35	2.59	
	72(22.2)	SHC	9,490	9,090	8,660	8,200	7,700	
	76(24.4)	SHC	11,390	10,990	10,560	10,100	9,600	
	80(26.7)	SHC	13,380	12,970	12,540	12,090	11,590	
	84(28.9)	SHC	15,280	14,870	14,440	13,990	13,490	
	88(31.1)	SHC	17,180	16,780	16,340	15,890	15,390	
75 (23.9)		TC	28,130	27,220	26,260	25,150	23,980	
		CI	1.79	1.96	2.14	2.38	2.63	
	76(24.4)	SHC	8,710	8,360	8,000	7,600	7,180	
	80(26.7)	SHC	10,690	10,350	9,990	9,590	9,160	
	84(28.9)	SHC	12,590	12,250	11,890	11,490	11,070	
	88(31.1)	SHC	14,490	14,150	13,790	13,390	12,970	

TC :Total Cooling Capacity (BTU/h)

SHC:Sensible Heat Capacity (BTU/h)

CI :Compressor Input (kW)

Rating conditions are

:Outdoor Ambient Temp.95° FDB

:Indoor Unit Entering Air Temp.80° FDB/67° FWB

# 1. Specifications

## Indoor Unit: UH2442 Outdoor Unit: CH2442

• 208V / 1 phase / 60Hz

RATING CAPACITY :		23,400 BTU/h		AIR FLOW RATE:		600 CFM	
EVAPORATOR		CONDENSER					
ENT.TEMP.°F(°C)		AMBIENT TEMP °F(°C)					
WB	DB		75 (23.9)	85 (29.4)	95 (35.0)	105 (40.6)	115 (46.1)
59 (15.0)		TC	23,700	22,560	21,250	19,770	18,140
		CI	1.75	1.92	2.09	2.33	2.56
	72(22.2)	SHC	16,860	16,260	15,590	14,850	14,050
	76(24.4)	SHC	18,930	18,330	17,660	16,910	16,120
	80(26.7)	SHC	21,090	20,490	19,820	19,070	18,140
	84(28.9)	SHC	23,150	22,560	21,250	19,770	18,140
	88(31.1)	SHC	23,700	22,560	21,250	19,770	18,140
63 (17.2)		TC	24,590	23,490	22,320	20,990	19,540
		CI	1.77	1.94	2.12	2.36	2.6
	72(22.2)	SHC	14,280	13,750	13,190	12,580	11,920
	76(24.4)	SHC	16,340	15,810	15,260	14,640	13,990
	80(26.7)	SHC	18,500	17,970	17,420	16,800	16,150
	84(28.9)	SHC	20,570	20,040	19,490	18,870	18,210
	88(31.1)	SHC	22,630	22,100	21,550	20,940	19,540
67 (19.4)		TC	25,530	24,520	# 23,400	22,160	20,800
		CI	1.79	1.96	2.14	2.39	2.63
	72(22.2)	SHC	11,680	11,230	10,750	10,220	9,660
	76(24.4)	SHC	13,740	13,300	12,810	12,290	11,720
	80(26.7)	SHC	15,900	15,460	14,970	14,450	13,880
	84(28.9)	SHC	17,970	17,530	17,040	16,510	15,950
	88(31.1)	SHC	20,040	19,590	19,110	18,580	18,010
71 (21.7)		TC	26,890	25,950	24,940	23,840	22,630
		CI	1.81	1.98	2.17	2.42	2.67
	72(22.2)	SHC	9,110	8,730	8,330	7,900	7,440
	76(24.4)	SHC	11,170	10,800	10,400	9,970	9,500
	80(26.7)	SHC	13,330	12,960	12,560	12,130	11,660
	84(28.9)	SHC	15,400	15,020	14,620	14,190	13,730
	88(31.1)	SHC	17,460	17,090	16,690	16,260	15,800
75 (23.9)		TC	27,420	26,540	25,600	24,520	23,380
		CI	1.84	2.01	2.2	2.46	2.71
	76(24.4)	SHC	8,360	8,050	7,710	7,330	6,940
	80(26.7)	SHC	10,520	10,210	9,870	9,490	9,100
	84(28.9)	SHC	12,590	12,270	11,940	11,560	11,170
	88(31.1)	SHC	14,660	14,340	14,000	13,630	13,230

TC :Total Cooling Capacity (BTU/h)

SHC:Sensible Heat Capacity (BTU/h)

CI :Compressor Input (kW)

Rating conditions are

:Outdoor Ambient Temp.95° FDB

:Indoor Unit Entering Air Temp.80° FDB/67° FWB

# 1. Specifications

## Indoor Unit: UH3642 Outdoor Unit: CH3642

• 230V / 1 phase / 60Hz

RATING CAPACITY :		34,500 BTU/h		AIR FLOW RATE:		1,060 CFM	
EVAPORATOR		CONDENSER					
ENT.TEMP.°F(°C)		AMBIENT TEMP °F(°C)					
WB	DB		75 (23.9)	85 (29.4)	95 (35.0)	105 (40.6)	115 (46.1)
59 (15.0)		TC	34,950	33,260	31,330	29,150	26,740
		CI	2.32	2.53	2.76	3.06	3.36
	72(22.2)	SHC	26,210	25,370	24,440	23,400	22,280
	76(24.4)	SHC	29,810	28,970	28,040	27,000	25,880
	80(26.7)	SHC	33,570	32,740	31,330	29,150	26,740
	84(28.9)	SHC	34,950	33,260	31,330	29,150	26,740
	88(31.1)	SHC	34,950	33,260	31,330	29,150	26,740
63 (17.2)		TC	36,260	34,640	32,910	30,950	28,810
		CI	2.34	2.57	2.8	3.11	3.42
	72(22.2)	SHC	21,860	21,130	20,360	19,500	18,580
	76(24.4)	SHC	25,460	24,730	23,960	23,100	22,180
	80(26.7)	SHC	29,230	28,490	27,720	26,860	25,940
	84(28.9)	SHC	32,830	32,090	31,320	30,460	28,810
	88(31.1)	SHC	36,260	34,640	32,910	30,950	28,810
67 (19.4)		TC	37,640	36,160	# 34,500	32,670	30,670
		CI	2.36	2.59	2.83	3.14	3.45
	72(22.2)	SHC	17,500	16,890	16,210	15,470	14,680
	76(24.4)	SHC	21,100	20,490	19,810	19,070	18,280
	80(26.7)	SHC	24,860	24,250	23,570	22,840	22,050
	84(28.9)	SHC	28,460	27,850	27,170	26,440	25,650
	88(31.1)	SHC	32,060	31,450	30,770	30,040	29,250
71 (21.7)		TC	39,640	38,260	36,780	35,160	33,360
		CI	2.39	2.62	2.87	3.19	3.5
	72(22.2)	SHC	13,150	12,620	12,070	11,480	10,820
	76(24.4)	SHC	16,750	16,220	15,670	15,080	14,420
	80(26.7)	SHC	20,510	19,990	19,440	18,840	18,190
	84(28.9)	SHC	24,110	23,590	23,040	22,440	21,790
	88(31.1)	SHC	27,710	27,190	26,640	26,040	25,390
75 (23.9)		TC	40,430	39,120	37,740	36,160	34,470
		CI	2.43	2.66	2.91	3.23	3.55
	76(24.4)	SHC	12,100	11,650	11,190	10,660	10,110
	80(26.7)	SHC	15,860	15,420	14,950	14,430	13,870
	84(28.9)	SHC	19,460	19,020	18,550	18,030	17,470
	88(31.1)	SHC	23,060	22,620	22,150	21,630	21,070

TC :Total Cooling Capacity (BTU/h)

SHC:Sensible Heat Capacity (BTU/h)

CI :Compressor Input (kW)

Rating conditions are

:Outdoor Ambient Temp.95° FDB

:Indoor Unit Entering Air Temp.80° FDB/67° FWB

# 1. Specifications

## Indoor Unit: UH3642 Outdoor Unit: CH3642

• 208V / 1 phase / 60Hz

RATING CAPACITY :		33,000 BTU/h		AIR FLOW RATE:			950 CFM	
EVAPORATOR		CONDENSER						
ENT.TEMP.°F(°C)		AMBIENT TEMP °F(°C)						
WB	DB		75 (23.9)	85 (29.4)	95 (35.0)	105 (40.6)	115 (46.1)	
59 (15.0)		TC	33,430	31,810	29,960	27,890	25,580	
		CI	2.21	2.41	2.62	2.96	3.3	
	72(22.2)	SHC	24,700	23,890	22,980	21,980	20,890	
	76(24.4)	SHC	27,990	27,180	26,270	25,270	24,180	
	80(26.7)	SHC	31,420	30,610	29,700	27,890	25,580	
	84(28.9)	SHC	33,430	31,810	29,960	27,890	25,580	
63 (17.2)		TC	34,680	33,130	31,480	29,600	27,560	
		CI	2.23	2.44	2.66	3	3.35	
	72(22.2)	SHC	20,700	19,980	19,240	18,400	17,510	
	76(24.4)	SHC	23,980	23,270	22,530	21,690	20,800	
	80(26.7)	SHC	27,420	26,710	25,960	25,130	24,240	
	84(28.9)	SHC	30,710	30,000	29,250	28,410	27,520	
67 (19.4)		TC	36,000	34,580	# 33,000	31,250	29,340	
		CI	2.25	2.46	2.69	3.04	3.38	
	72(22.2)	SHC	16,680	16,080	15,420	14,710	13,950	
	76(24.4)	SHC	19,960	19,370	18,710	18,000	17,230	
	80(26.7)	SHC	23,400	22,800	22,150	21,440	20,670	
	84(28.9)	SHC	26,690	26,090	25,440	24,720	23,960	
71 (21.7)		TC	37,920	36,600	35,180	33,630	31,910	
		CI	2.27	2.49	2.73	3.08	3.43	
	72(22.2)	SHC	12,670	12,170	11,630	11,050	10,420	
	76(24.4)	SHC	15,960	15,460	14,920	14,340	13,710	
	80(26.7)	SHC	19,400	18,890	18,360	17,780	17,150	
	84(28.9)	SHC	22,690	22,180	21,640	21,060	20,430	
75 (23.9)		TC	38,680	37,420	36,100	34,580	32,970	
		CI	2.31	2.53	2.77	3.13	3.48	
	76(24.4)	SHC	11,670	11,230	10,780	10,270	9,740	
	80(26.7)	SHC	15,100	14,670	14,220	13,710	13,170	
	84(28.9)	SHC	18,390	17,960	17,510	16,990	16,460	
	88(31.1)	SHC	21,680	21,240	20,790	20,280	19,750	

TC :Total Cooling Capacity (BTU/h)

SHC:Sensible Heat Capacity (BTU/h)

CI :Compressor Input (kW)

Rating conditions are

:Outdoor Ambient Temp.95° FDB

:Indoor Unit Entering Air Temp.80° FDB/67° FWB

# 1. Specifications

## Indoor Unit: KH2442 Outdoor Unit: CH2442

• 230V / 1 phase / 60Hz

RATING CAPACITY :		22,000 BTU/h		AIR FLOW RATE:			540 CFM	
EVAPORATOR		CONDENSER						
ENT.TEMP.°F(°C)		AMBIENT TEMP °F(°C)						
WB	DB		75 (23.9)	85 (29.4)	95 (35.0)	105 (40.6)	115 (46.1)	
59 (15.0)		TC	22,290	21,210	19,980	18,590	17,050	
		CI	1.71	1.86	2.03	2.26	2.49	
	72(22.2)	SHC	15,990	15,430	14,800	14,110	13,360	
	76(24.4)	SHC	17,950	17,390	16,760	16,070	15,330	
	80(26.7)	SHC	20,000	19,440	18,810	18,120	17,050	
	84(28.9)	SHC	21,960	21,210	19,980	18,590	17,050	
	88(31.1)	SHC	22,290	21,210	19,980	18,590	17,050	
63 (17.2)		TC	23,120	22,090	20,990	19,730	18,370	
		CI	1.72	1.89	2.06	2.29	2.52	
	72(22.2)	SHC	13,550	13,060	12,540	11,960	11,350	
	76(24.4)	SHC	15,510	15,020	14,500	13,920	13,310	
	80(26.7)	SHC	17,560	17,070	16,550	15,970	15,360	
	84(28.9)	SHC	19,520	19,030	18,510	17,930	17,320	
	88(31.1)	SHC	21,480	20,990	20,470	19,730	18,370	
67 (19.4)		TC	24,000	23,060	# 22,000	20,830	19,560	
		CI	1.74	1.9	2.08	2.32	2.55	
	72(22.2)	SHC	11,100	10,690	10,230	9,740	9,210	
	76(24.4)	SHC	13,060	12,650	12,190	11,700	11,170	
	80(26.7)	SHC	15,110	14,700	14,240	13,750	13,220	
	84(28.9)	SHC	17,070	16,660	16,200	15,710	15,180	
	88(31.1)	SHC	19,030	18,620	18,160	17,670	17,140	
71 (21.7)		TC	25,280	24,400	23,450	22,420	21,270	
		CI	1.76	1.92	2.11	2.35	2.59	
	72(22.2)	SHC	8,670	8,320	7,950	7,550	7,110	
	76(24.4)	SHC	10,630	10,280	9,910	9,510	9,070	
	80(26.7)	SHC	12,680	12,330	11,960	11,560	11,120	
	84(28.9)	SHC	14,640	14,290	13,920	13,520	13,080	
	88(31.1)	SHC	16,600	16,250	15,880	15,480	15,040	
75 (23.9)		TC	25,780	24,950	24,070	23,060	21,980	
		CI	1.79	1.96	2.14	2.38	2.63	
	76(24.4)	SHC	7,980	7,690	7,380	7,020	6,650	
	80(26.7)	SHC	10,030	9,740	9,430	9,070	8,700	
	84(28.9)	SHC	11,990	11,700	11,390	11,030	10,660	
	88(31.1)	SHC	13,960	13,660	13,350	12,990	12,620	

TC :Total Cooling Capacity (BTU/h)

SHC:Sensible Heat Capacity (BTU/h)

CI :Compressor Input (kW)

Rating conditions are

:Outdoor Ambient Temp.95° FDB

:Indoor Unit Entering Air Temp.80° FDB/67° FWB

# 1. Specifications

## Indoor Unit: KH2442 Outdoor Unit: CH2442

• 208V / 1 phase / 60Hz

RATING CAPACITY :		21,000 BTU/h		AIR FLOW RATE:		510 CFM	
EVAPORATOR		CONDENSER					
ENT.TEMP.°F(°C)		AMBIENT TEMP °F(°C)					
WB	DB		75 (23.9)	85 (29.4)	95 (35.0)	105 (40.6)	115 (46.1)
59 (15.0)		TC	21,270	20,240	19,070	17,750	16,280
		CI	1.75	1.92	2.09	2.33	2.56
	72(22.2)	SHC	15,260	14,730	14,130	13,470	12,760
	76(24.4)	SHC	17,130	16,590	16,000	15,340	14,620
	80(26.7)	SHC	19,080	18,550	17,950	17,290	16,280
	84(28.9)	SHC	20,950	20,240	19,070	17,750	16,280
63 (17.2)		TC	22,070	21,080	20,030	18,840	17,540
		CI	1.77	1.94	2.12	2.36	2.6
	72(22.2)	SHC	12,940	12,470	11,970	11,430	10,840
	76(24.4)	SHC	14,810	14,330	13,840	13,290	12,710
	80(26.7)	SHC	16,760	16,290	15,790	15,250	14,660
	84(28.9)	SHC	18,630	18,150	17,660	17,110	16,530
67 (19.4)		TC	22,910	22,010	# 21,000	19,890	18,670
		CI	1.79	1.96	2.14	2.39	2.63
	72(22.2)	SHC	10,600	10,210	9,780	9,310	8,800
	76(24.4)	SHC	12,470	12,080	11,640	11,170	10,670
	80(26.7)	SHC	14,420	14,030	13,590	13,130	12,620
	84(28.9)	SHC	16,290	15,900	15,460	14,990	14,490
71 (21.7)		TC	24,130	23,290	22,390	21,400	20,310
		CI	1.81	1.98	2.17	2.42	2.67
	72(22.2)	SHC	8,290	7,960	7,600	7,220	6,800
	76(24.4)	SHC	10,160	9,820	9,470	9,090	8,670
	80(26.7)	SHC	12,110	11,780	11,420	11,040	10,620
	84(28.9)	SHC	13,980	13,640	13,290	12,910	12,490
75 (23.9)		TC	24,610	23,810	22,970	22,010	20,980
		CI	1.84	2.01	2.2	2.46	2.71
	76(24.4)	SHC	7,640	7,350	7,050	6,720	6,360
	80(26.7)	SHC	9,590	9,300	9,010	8,670	8,320
	84(28.9)	SHC	11,460	11,170	10,870	10,540	10,180
	88(31.1)	SHC	13,320	13,040	12,740	12,400	12,050

TC :Total Cooling Capacity (BTU/h)

SHC:Sensible Heat Capacity (BTU/h)

CI :Compressor Input (kW)

Rating conditions are

:Outdoor Ambient Temp.95° FDB

:Indoor Unit Entering Air Temp.80° FDB/67° FWB



# 1. Specifications

## Indoor Unit: KH3642 Outdoor Unit: CH3642

• 230V / 1 phase / 60Hz

RATING CAPACITY :		33,000 BTU/h		AIR FLOW RATE:			830 CFM	
EVAPORATOR		CONDENSER						
ENT.TEMP.°F(°C)		AMBIENT TEMP °F(°C)						
WB	DB		75 (23.9)	85 (29.4)	95 (35.0)	105 (40.6)	115 (46.1)	
59 (15.0)		TC	33,430	31,810	29,960	27,890	25,580	
		CI	2.32	2.53	2.76	3.06	3.36	
	72(22.2)	SHC	23,980	23,130	22,190	21,160	20,030	
	76(24.4)	SHC	26,900	26,060	25,110	24,080	22,960	
	80(26.7)	SHC	29,960	29,110	28,170	27,130	25,580	
	84(28.9)	SHC	32,880	31,810	29,960	27,890	25,580	
	88(31.1)	SHC	33,430	31,810	29,960	27,890	25,580	
63 (17.2)		TC	34,680	33,130	31,480	29,600	27,560	
		CI	2.34	2.57	2.8	3.11	3.42	
	72(22.2)	SHC	20,340	19,600	18,820	17,960	17,040	
	76(24.4)	SHC	23,260	22,520	21,740	20,880	19,960	
	80(26.7)	SHC	26,320	25,570	24,800	23,930	23,010	
	84(28.9)	SHC	29,240	28,500	27,720	26,850	25,940	
	88(31.1)	SHC	32,160	31,420	30,640	29,600	27,560	
67 (19.4)		TC	36,000	34,580	# 33,000	31,250	29,340	
		CI	2.36	2.59	2.83	3.14	3.45	
	72(22.2)	SHC	16,680	16,060	15,380	14,640	13,850	
	76(24.4)	SHC	19,600	18,980	18,300	17,560	16,770	
	80(26.7)	SHC	22,660	22,040	21,360	20,620	19,820	
	84(28.9)	SHC	25,580	24,960	24,280	23,540	22,750	
	88(31.1)	SHC	28,500	27,880	27,200	26,460	25,670	
71 (21.7)		TC	37,920	36,600	35,180	33,630	31,910	
		CI	2.39	2.62	2.87	3.19	3.5	
	72(22.2)	SHC	13,060	12,540	11,980	11,380	10,720	
	76(24.4)	SHC	15,980	15,460	14,900	14,300	13,640	
	80(26.7)	SHC	19,040	18,510	17,950	17,350	16,700	
	84(28.9)	SHC	21,960	21,430	20,880	20,280	19,620	
	88(31.1)	SHC	24,880	24,360	23,800	23,200	22,540	
75 (23.9)		TC	38,680	37,420	36,100	34,580	32,970	
		CI	2.43	2.66	2.91	3.23	3.55	
	76(24.4)	SHC	12,040	11,590	11,120	10,590	10,030	
	80(26.7)	SHC	15,090	14,640	14,170	13,640	13,090	
	84(28.9)	SHC	18,010	17,560	17,090	16,560	16,010	
	88(31.1)	SHC	20,940	20,480	20,020	19,490	18,930	

TC :Total Cooling Capacity (BTU/h)

SHC:Sensible Heat Capacity (BTU/h)

CI :Compressor Input (kW)

Rating conditions are

:Outdoor Ambient Temp.95° FDB

:Indoor Unit Entering Air Temp.80° FDB/67° FWB



# 1. Specifications

## Indoor Unit: KH3642 Outdoor Unit: CH3642

• 208V / 1 phase / 60Hz

RATING CAPACITY :		32,000 BTU/h		AIR FLOW RATE:		750 CFM	
EVAPORATOR		CONDENSER					
ENT.TEMP.°F(°C)		AMBIENT TEMP °F(°C)					
WB	DB		75 (23.9)	85 (29.4)	95 (35.0)	105 (40.6)	115 (46.1)
59 (15.0)		TC	32,420	30,850	29,060	27,040	24,800
		CI	2.21	2.41	2.62	2.96	3.3
	72(22.2)	SHC	22,940	22,100	21,170	20,140	19,030
	76(24.4)	SHC	25,620	24,780	23,850	22,820	21,710
	80(26.7)	SHC	28,420	27,580	26,650	25,620	24,520
	84(28.9)	SHC	31,100	30,270	29,060	27,040	24,800
	88(31.1)	SHC	32,420	30,850	29,060	27,040	24,800
63 (17.2)		TC	33,630	32,130	30,530	28,700	26,720
		CI	2.23	2.44	2.66	3	3.35
	72(22.2)	SHC	19,550	18,820	18,050	17,190	16,280
	76(24.4)	SHC	22,230	21,500	20,730	19,870	18,960
	80(26.7)	SHC	25,040	24,300	23,530	22,670	21,770
	84(28.9)	SHC	27,720	26,980	26,220	25,360	24,450
	88(31.1)	SHC	30,400	29,660	28,900	28,040	26,720
67 (19.4)		TC	34,910	33,540	# 32,000	30,300	28,450
		CI	2.25	2.46	2.69	3.04	3.38
	72(22.2)	SHC	16,150	15,530	14,860	14,120	13,340
	76(24.4)	SHC	18,830	18,220	17,540	16,810	16,020
	80(26.7)	SHC	21,630	21,020	20,340	19,610	18,830
	84(28.9)	SHC	24,320	23,700	23,020	22,290	21,510
	88(31.1)	SHC	27,000	26,380	25,710	24,970	24,190
71 (21.7)		TC	36,770	35,490	34,110	32,610	30,940
		CI	2.27	2.49	2.73	3.08	3.43
	72(22.2)	SHC	12,790	12,270	11,710	11,120	10,470
	76(24.4)	SHC	15,470	14,950	14,400	13,800	13,160
	80(26.7)	SHC	18,280	17,750	17,200	16,610	15,960
	84(28.9)	SHC	20,960	20,440	19,880	19,290	18,640
	88(31.1)	SHC	23,640	23,120	22,560	21,970	21,320
75 (23.9)		TC	37,500	36,290	35,010	33,540	31,970
		CI	2.31	2.53	2.77	3.13	3.48
	76(24.4)	SHC	11,780	11,340	10,870	10,350	9,800
	80(26.7)	SHC	14,580	14,140	13,680	13,150	12,600
	84(28.9)	SHC	17,270	16,820	16,360	15,840	15,290
	88(31.1)	SHC	19,950	19,500	19,040	18,520	17,970

TC :Total Cooling Capacity (BTU/h)

SHC:Sensible Heat Capacity (BTU/h)

CI :Compressor Input (kW)

Rating conditions are

:Outdoor Ambient Temp.95° FDB

:Indoor Unit Entering Air Temp.80° FDB/67° FWB

1-8 Heating Capacity

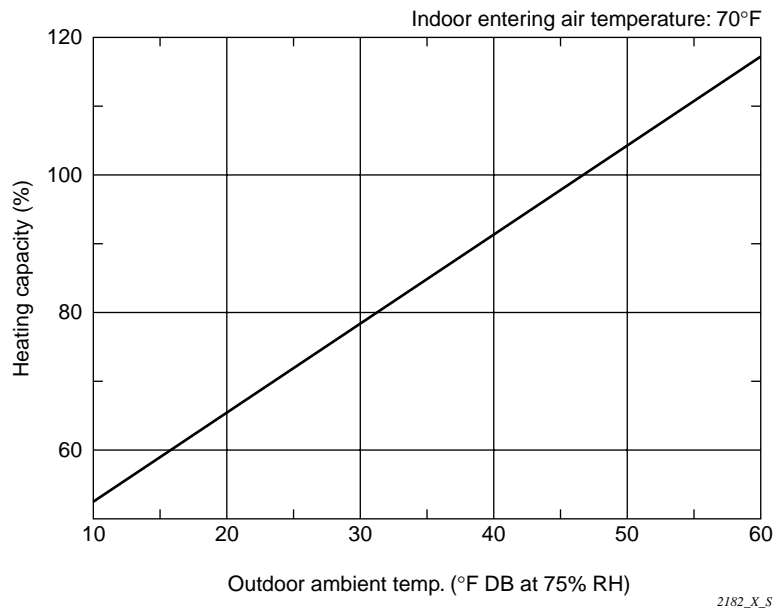

1-9 Performance Charts

● Cooling Characteristics

(1) Operating Current

① Indoor Unit: XH2442 Outdoor Unit: CH2442

Operating current characteristics versus outdoor ambient temperature and indoor temperature. (Indoor relative humidity: 50%, Indoor fan speed: High)

230V

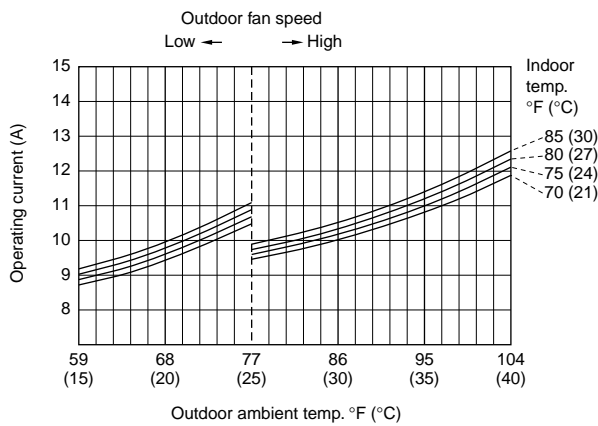

2183\_X\_S

208V

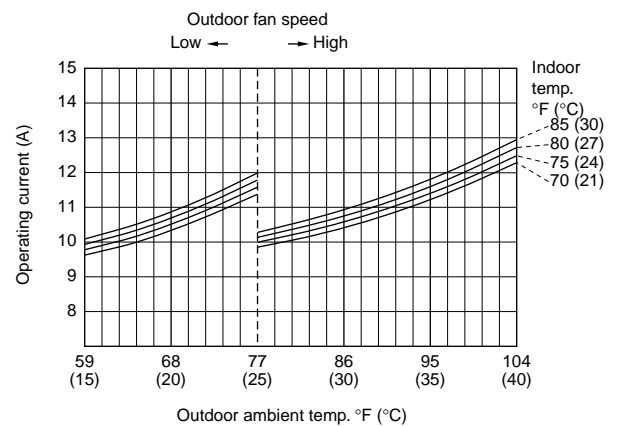

2184\_X\_S

Indoor Unit: XH3642

Outdoor Unit: CH3642

230V

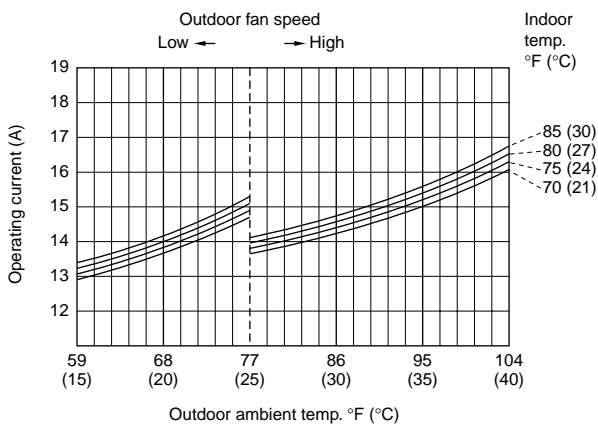

2185\_X\_S

208V

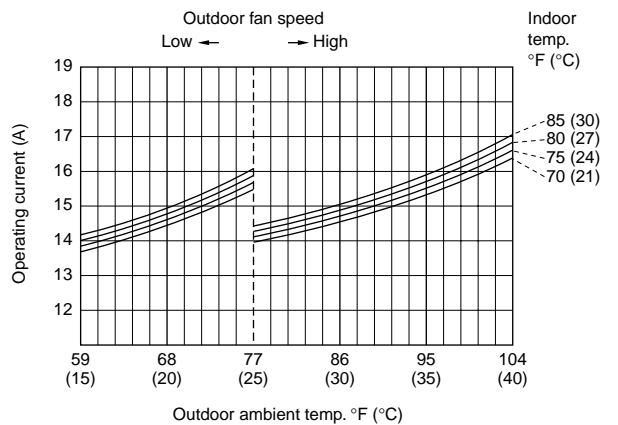

1467\_X\_S

1-9 Performance Charts

● Cooling Characteristics

(1) Operating Current

① Indoor Unit: XH4242 Outdoor Unit: CH4242

Operating current characteristics versus outdoor ambient temperature and indoor temperature. (Indoor relative humidity: 50%, Indoor fan speed: High)

230V

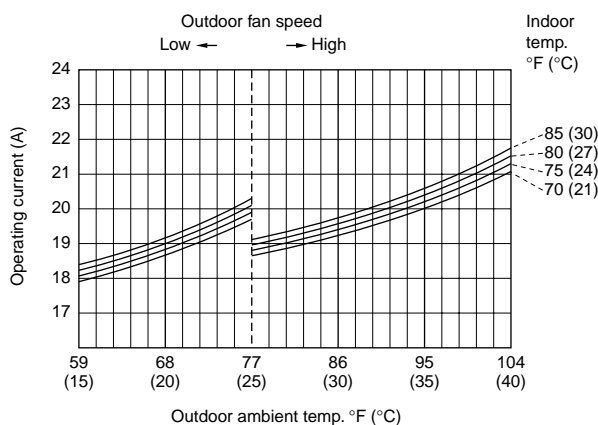

208V

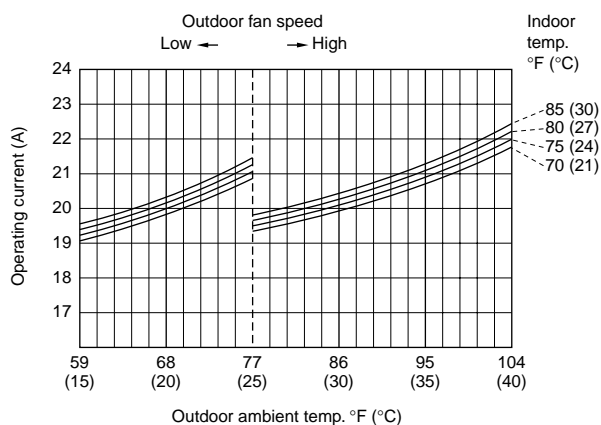

1-9 Performance Charts

● Cooling Characteristics

(1) Operating Current

① Indoor Unit: TH2442 Outdoor Unit: CH2442

Operating current characteristics versus outdoor ambient temperature and indoor temperature. (Indoor relative humidity: 50%, Indoor fan speed: High)

230V

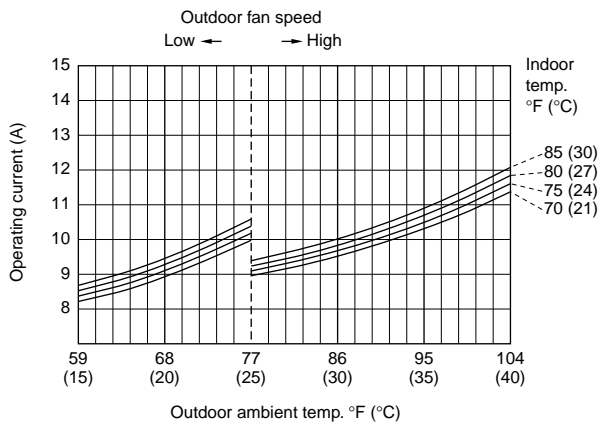

2186\_X\_S

208V

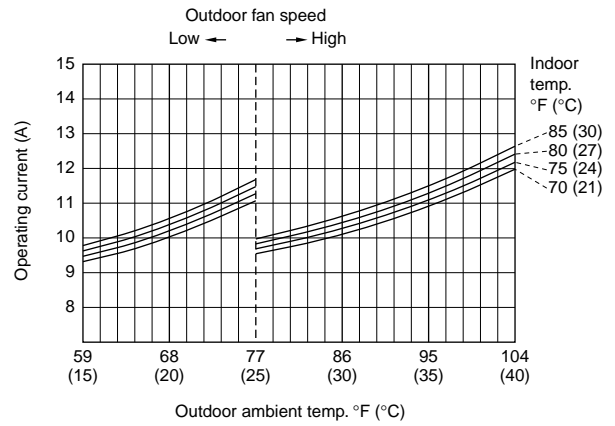

2187\_X\_S

Indoor Unit: TH3642

Outdoor Unit: CH3642

230V

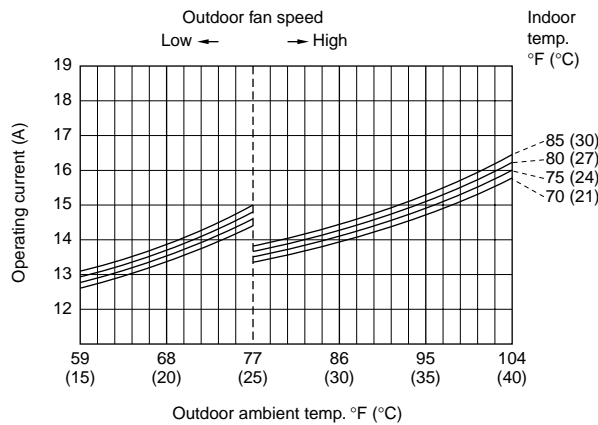

1466\_X\_S

208V

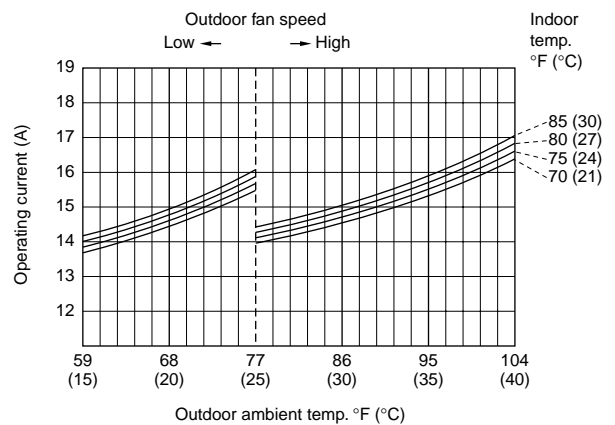

1467\_X\_S

1-9 Performance Charts

● Cooling Characteristics

(1) Operating Current

① Indoor Unit: TH4242 Outdoor Unit: CH4242

Operating current characteristics versus outdoor ambient temperature and indoor temperature. (Indoor relative humidity: 50%, Indoor fan speed: High)

230V

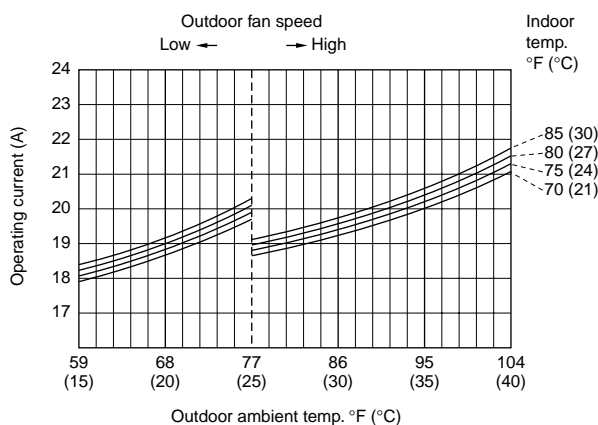

208V

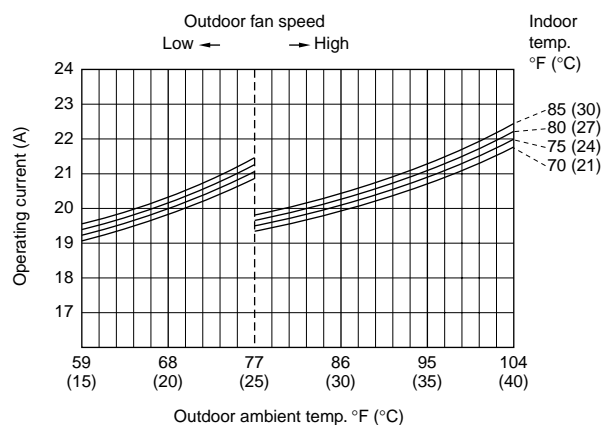

1-9 Performance Charts

● Cooling Characteristics

(1) Operating Current

① Indoor Unit: UH2442 Outdoor Unit: CH2442

Operating current characteristics versus outdoor ambient temperature and indoor temperature. (Indoor relative humidity: 50%, Indoor fan speed: High)

230V

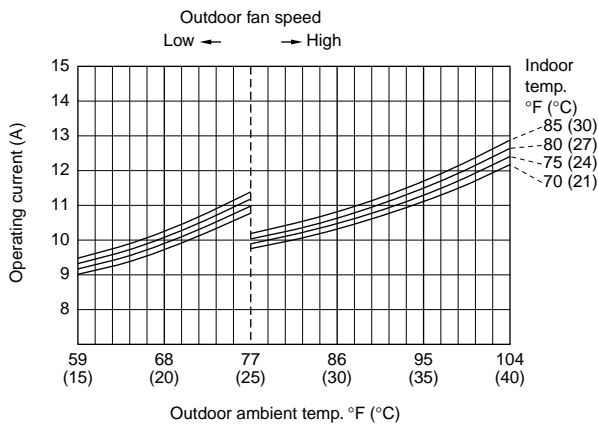

2188\_X\_S

208V

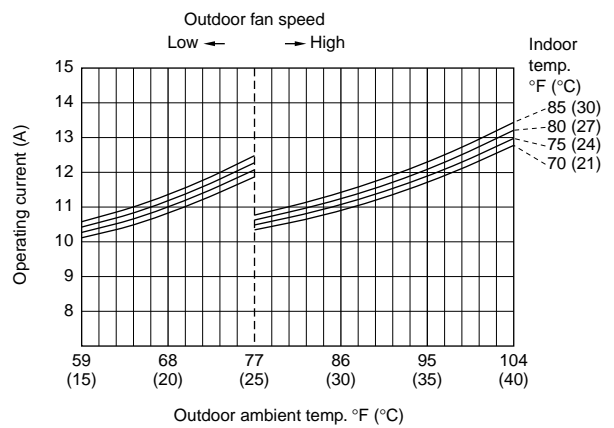

2189\_X\_S

Indoor Unit: UH3642

Outdoor Unit: CH3642

230V

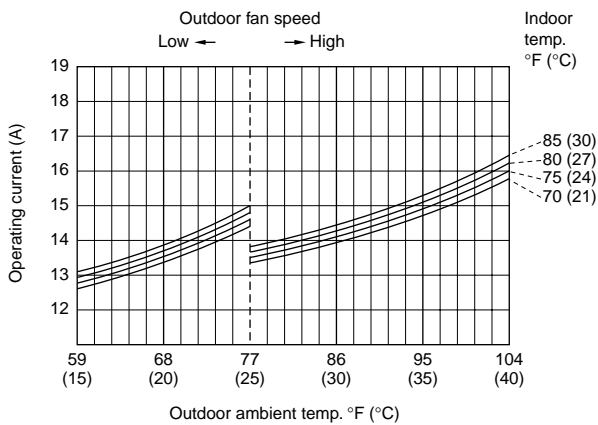

1466\_X\_S

208V

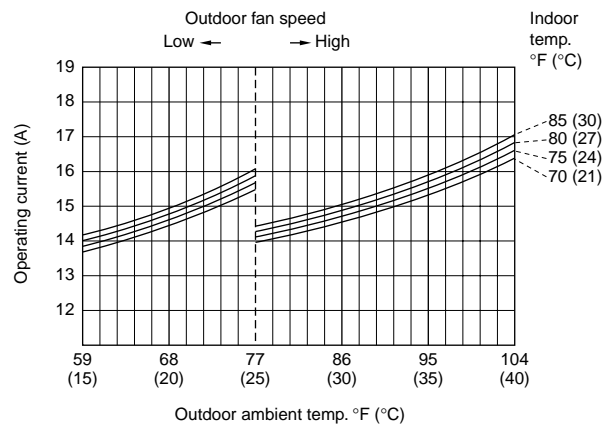

1467\_X\_S



1-9 Performance Charts

● Cooling Characteristics

(1) Operating Current

① Indoor Unit: KH2442 Outdoor Unit: CH2442

Operating current characteristics versus outdoor ambient temperature and indoor temperature. (Indoor relative humidity: 50%, Indoor fan speed: High)

230V

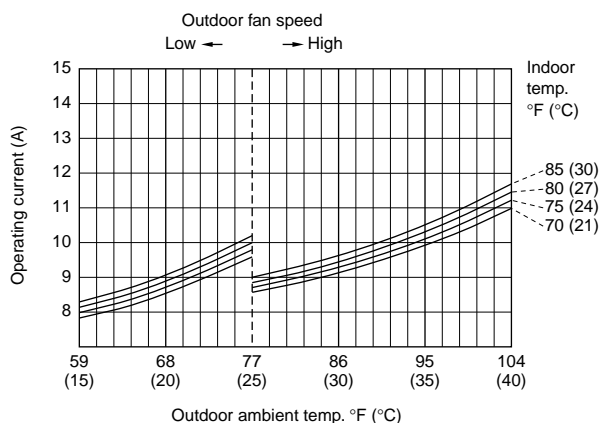

1159\_X\_S

208V

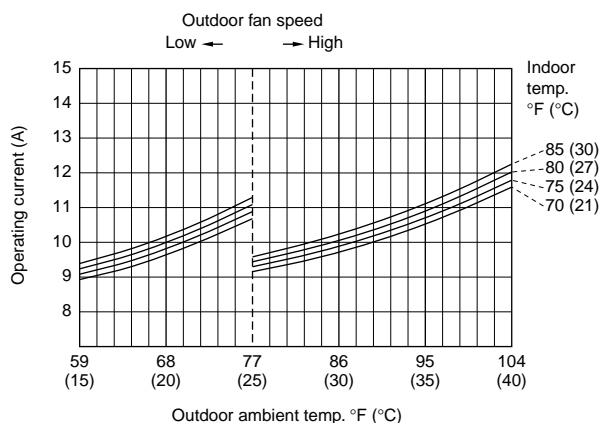

1160\_X\_S

Indoor Unit: KH3642

Outdoor Unit: CH3642

230V

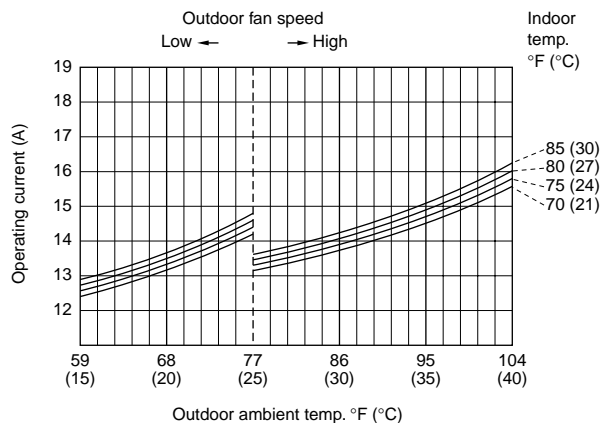

2190\_X\_S

208V

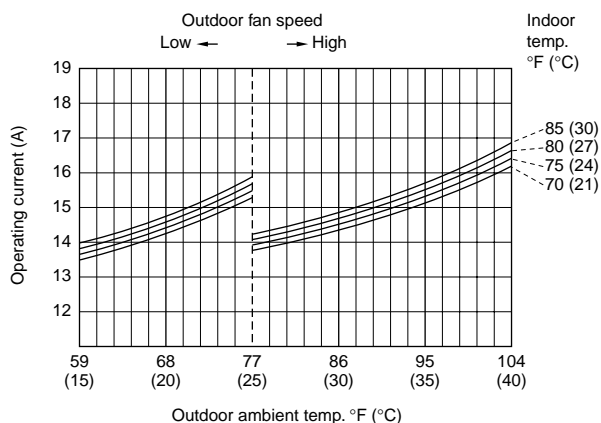

2191\_X\_S

1-9 Performance Charts

● Heating Characteristics

(1) Operating Current

① Indoor Unit: XH2442 Outdoor Unit: CH2442

Operating current characteristics versus outdoor ambient temperature and indoor temperature. (Indoor relative humidity: 50%, Indoor fan speed: High)

230V

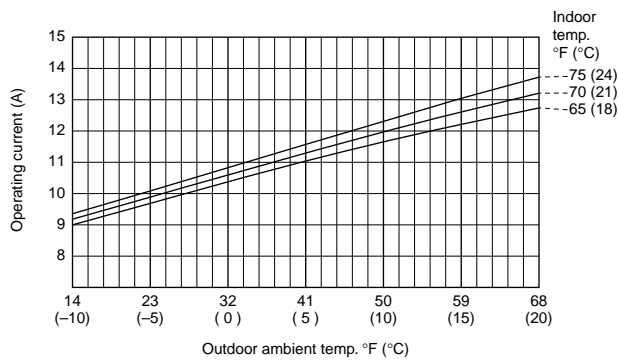

2192\_X\_S

208V

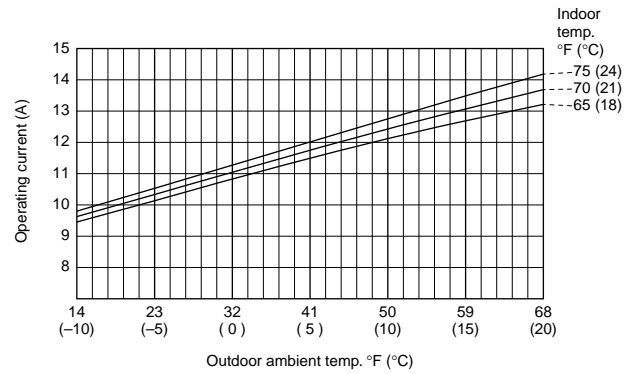

2232\_X\_S

Indoor Unit: XH3642

Outdoor Unit: CH3642

230V

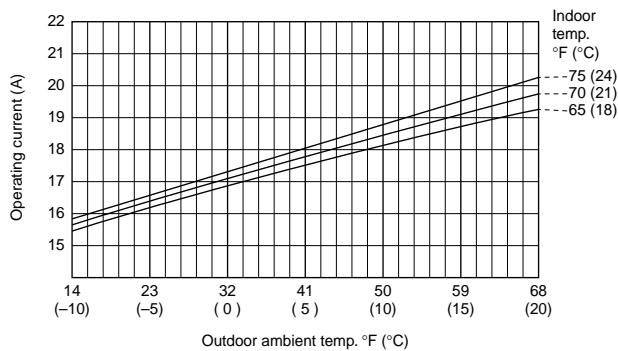

2233\_X\_S

208V

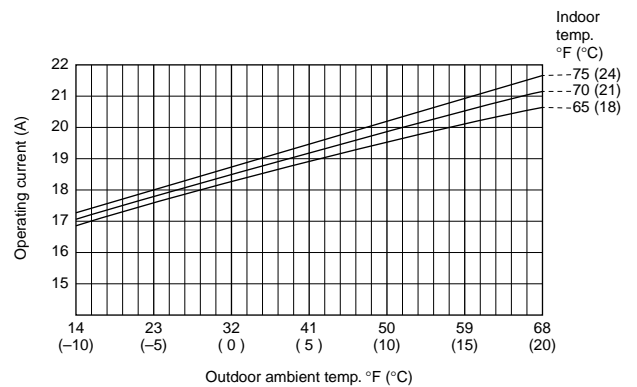

2234\_X\_S

1-9 Performance Charts

● Heating Characteristics

(1) Operating Current

① Indoor Unit: XH4242 Outdoor Unit: CH4242

Operating current characteristics versus outdoor ambient temperature and indoor temperature.  
(Indoor relative humidity: 50%, Indoor fan speed: High)

230V

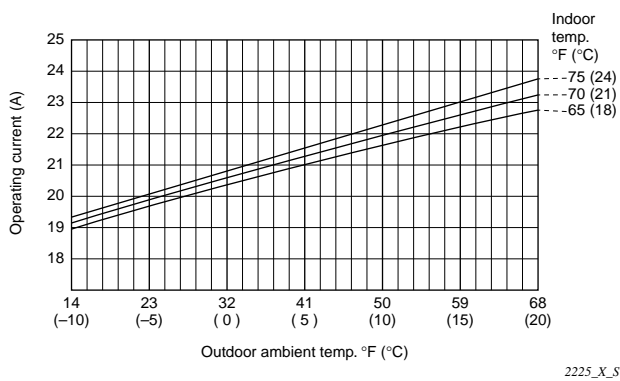

208V

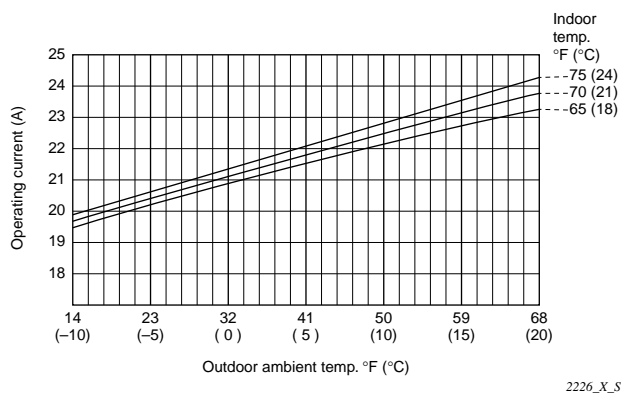

1-9 Performance Charts

● Heating Characteristics

(1) Operating Current

① Indoor Unit: TH2442 Outdoor Unit: CH2442

Operating current characteristics versus outdoor ambient temperature and indoor temperature. (Indoor relative humidity: 50%, Indoor fan speed: High)

230V

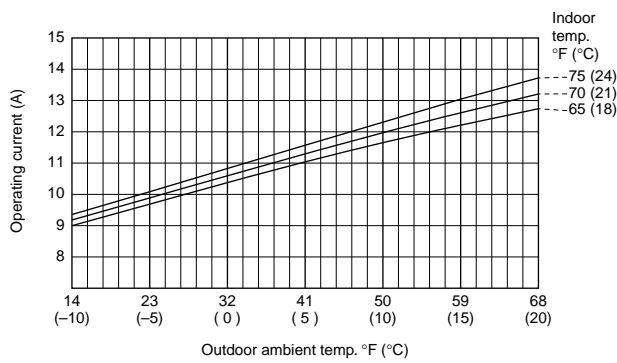

2192\_X\_S

208V

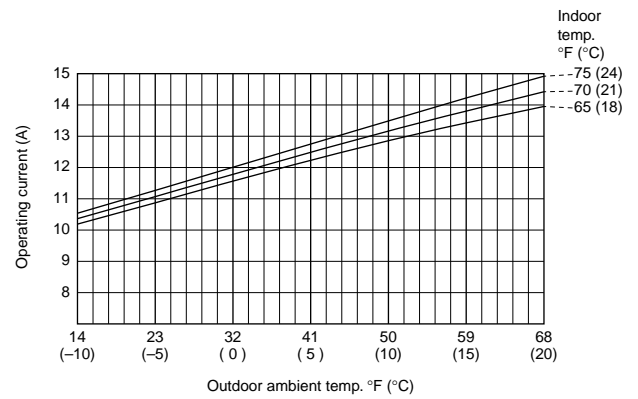

2193\_X\_S

Indoor Unit: TH3642

Outdoor Unit: CH3642

230V

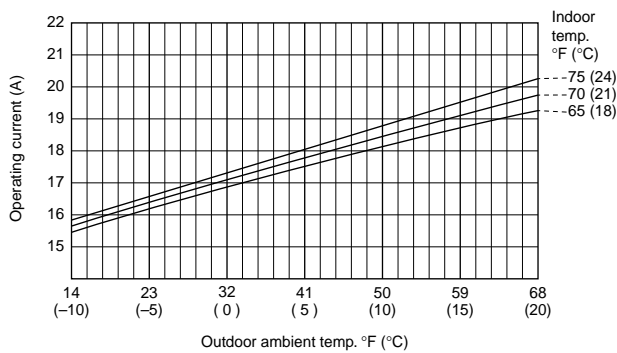

2232\_X\_S

208V

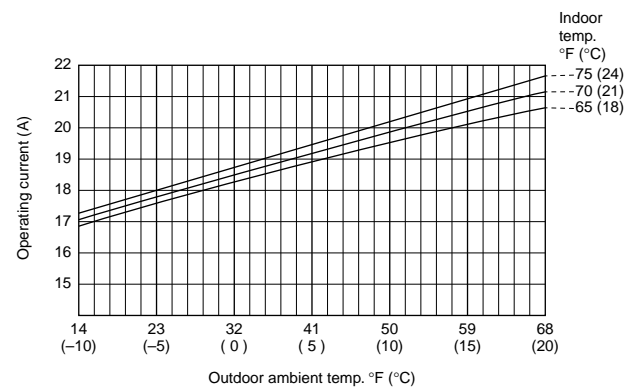

2234\_X\_S

1-9 Performance Charts

● Heating Characteristics

(1) Operating Current

① Indoor Unit: TH4242 Outdoor Unit: CH4242

Operating current characteristics versus outdoor ambient temperature and indoor temperature. (Indoor relative humidity: 50%, Indoor fan speed: High)

230V

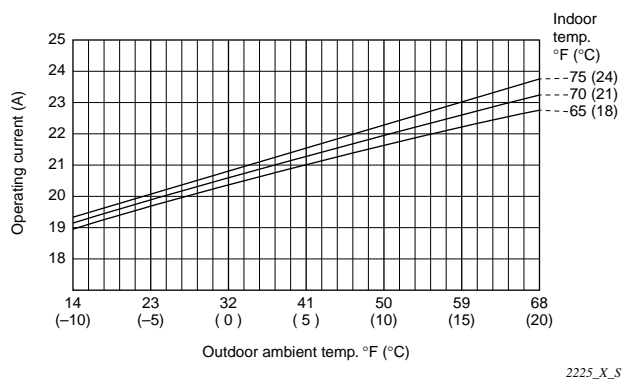

208V

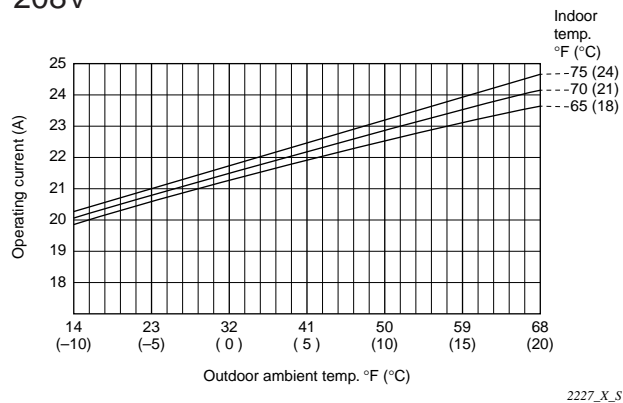

1-9 Performance Charts

● Heating Characteristics

(1) Operating Current

① Indoor Unit: UH2442 Outdoor Unit: CH2442

Operating current characteristics versus outdoor ambient temperature and indoor temperature. (Indoor relative humidity: 50%, Indoor fan speed: High)

230V

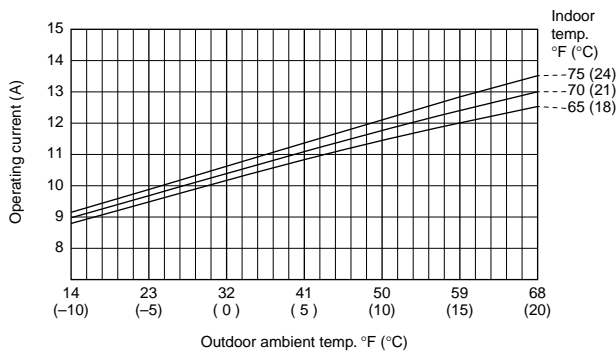

2194\_X\_S

208V

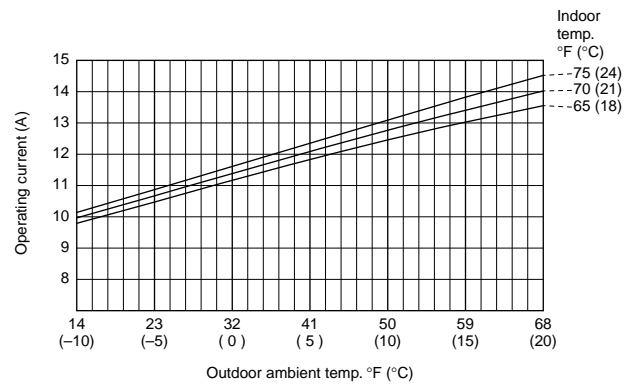

2195\_X\_S

Indoor Unit: UH3642

Outdoor Unit: CH3642

230V

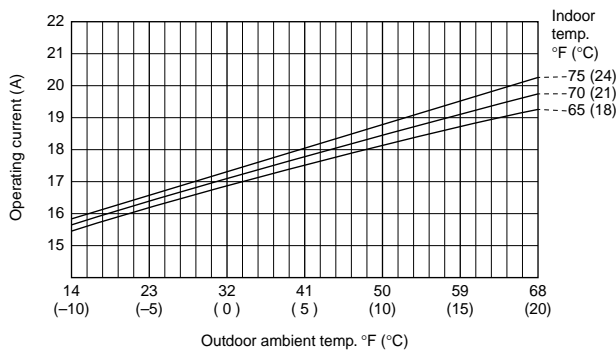

2233\_X\_S

208V

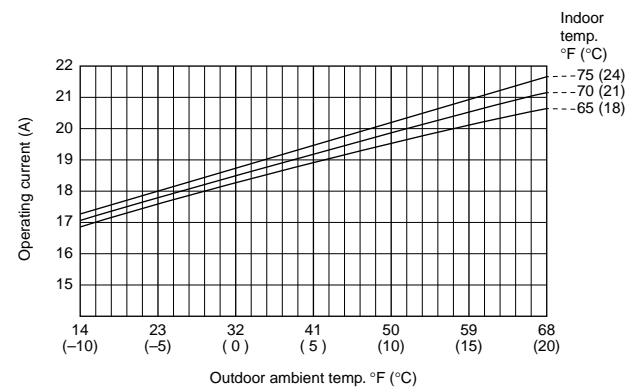

2234\_X\_S

1-9 Performance Charts

● Heating Characteristics

(1) Operating Current

① Indoor Unit: KH2442 Outdoor Unit: CH2442

Operating current characteristics versus outdoor ambient temperature and indoor temperature. (Indoor relative humidity: 50%, Indoor fan speed: High)

230V

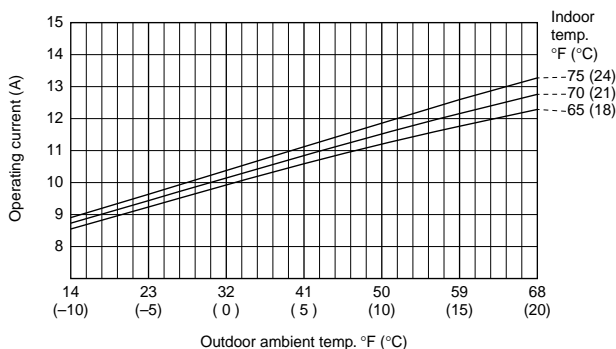

2235\_X\_S

208V

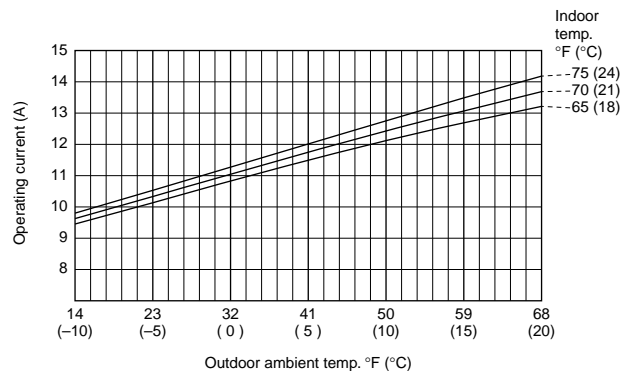

2232\_X\_S

Indoor Unit: KH3642

Outdoor Unit: CH3642

230V

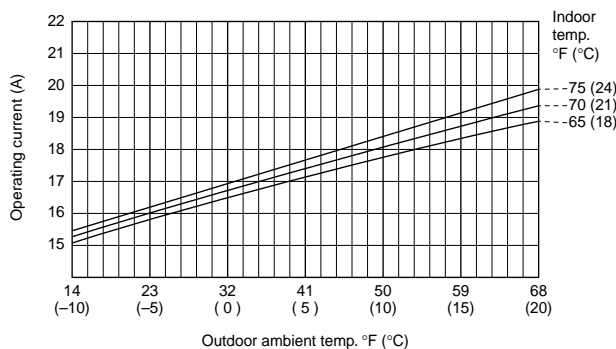

2196\_X\_S

208V

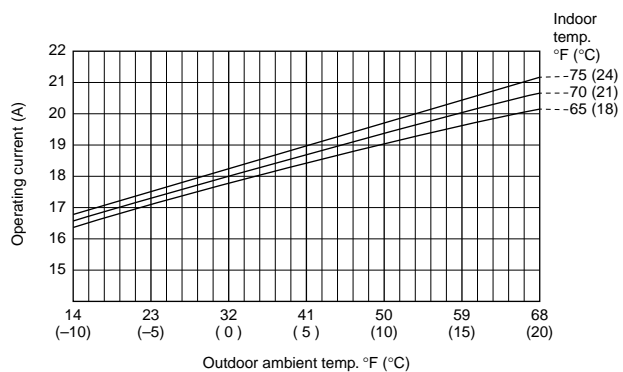

2197\_X\_S

1-9 Performance Charts

● Cooling Characteristics

(2) Operating Pressure

① Indoor Unit: 24 Type Outdoor Unit: CH2442

• High Pressure

High pressure characteristics versus outdoor ambient temperature and indoor temperature. (Indoor relative humidity: 50%, Indoor fan speed: High)

230V / 208V

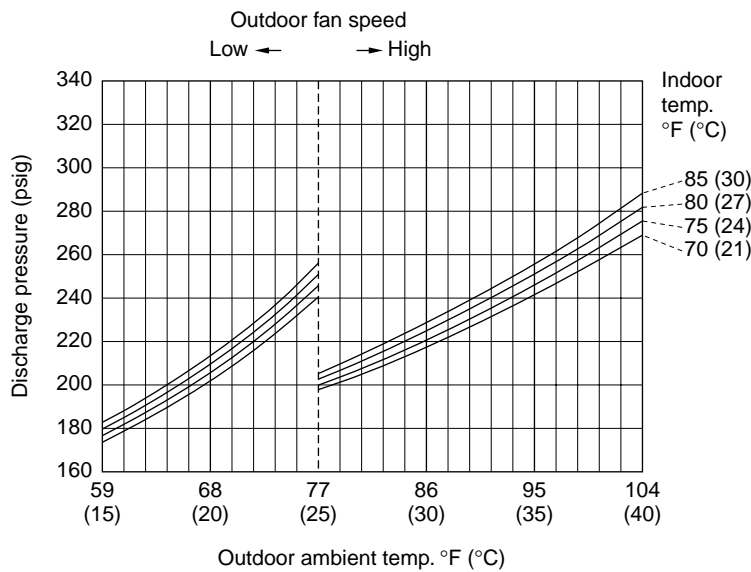

• Low Pressure

Low pressure characteristics versus outdoor ambient temperature and indoor temperature. (Indoor relative humidity: 50%, Indoor fan speed: High)

230V / 208V

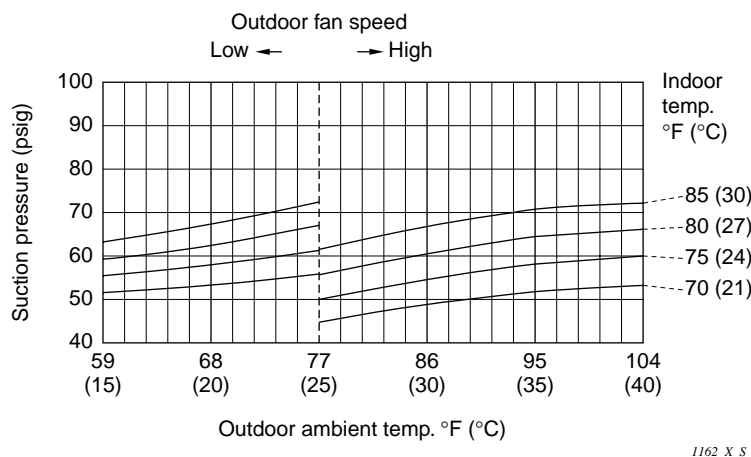



1-9 Performance Charts

● Cooling Characteristics

(2) Operating Pressure

① Indoor Unit: 36 Type Outdoor Unit: CH3642

• High Pressure

High pressure characteristics versus outdoor ambient temperature and indoor temperature. (Indoor relative humidity: 50%, Indoor fan speed: High)

230V / 208V

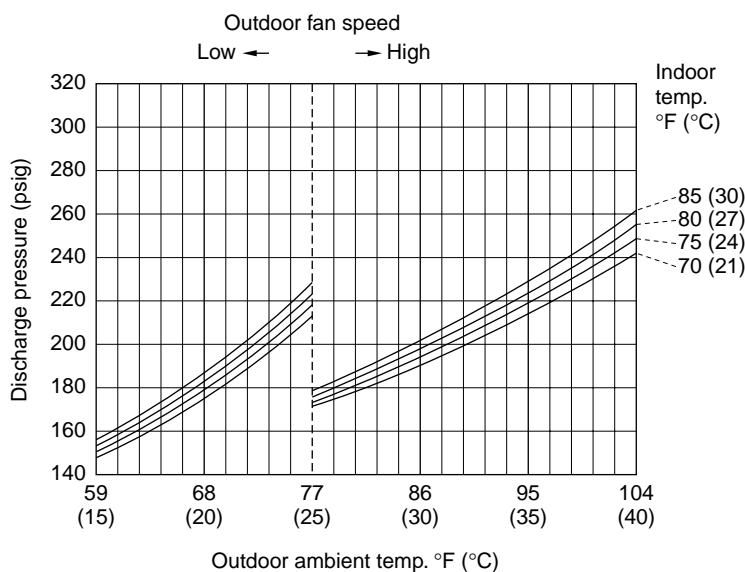

• Low Pressure

Low pressure characteristics versus outdoor ambient temperature and indoor temperature. (Indoor relative humidity: 50%, Indoor fan speed: High)

230V / 208V

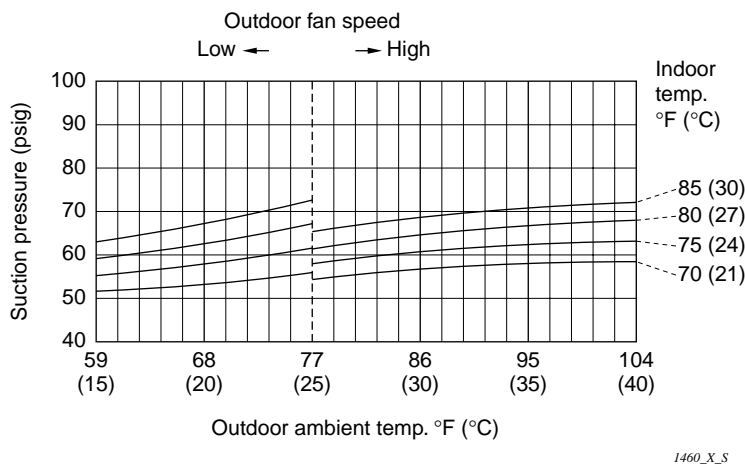

1-9 Performance Charts

● Cooling Characteristics

(2) Operating Pressure

① Indoor Unit: 42 Type Outdoor Unit: CH4242

• High Pressure

High pressure characteristics versus outdoor ambient temperature and indoor temperature. (Indoor relative humidity: 50%, Indoor fan speed: High)

230V / 208V

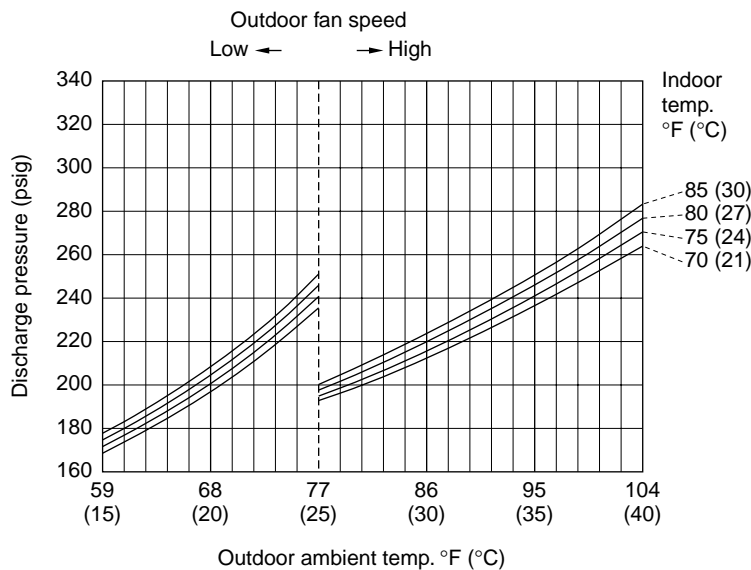

• Low Pressure

Low pressure characteristics versus outdoor ambient temperature and indoor temperature. (Indoor relative humidity: 50%, Indoor fan speed: High)

230V / 208V

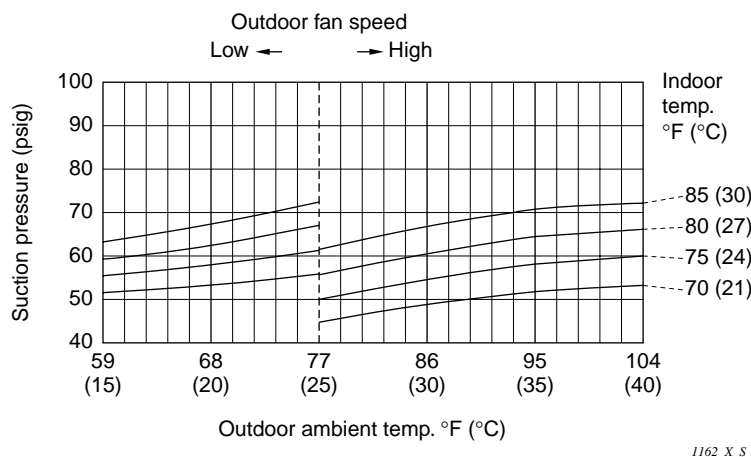

1-9 Performance Charts

● Heating Characteristics

(2) Operating Pressure

① Indoor Unit: 24 Type Outdoor Unit: CH2442

• High Pressure

High pressure characteristics versus outdoor ambient temperature and indoor temperature. (Indoor relative humidity: 50%, Indoor fan speed: High)

230V / 208V

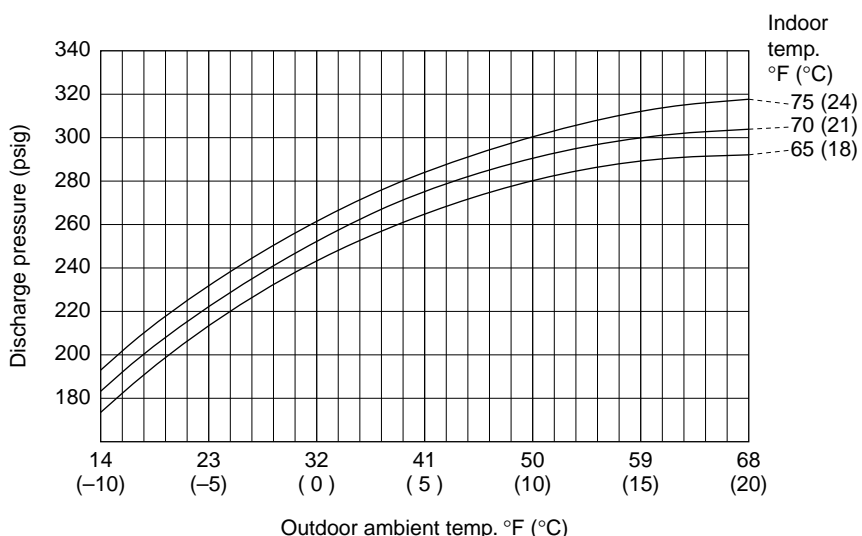

1165\_X\_S

• Low Pressure

Low pressure characteristics versus outdoor ambient temperature and indoor temperature. (Indoor relative humidity: 50%, Indoor fan speed: High)

230V / 208V

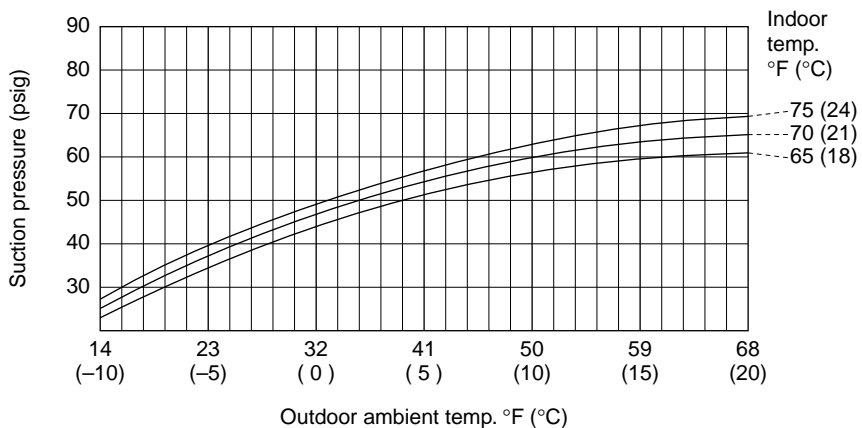

1166\_X\_S



**1-9 Performance Charts**

● Heating Characteristics

**(2) Operating Pressure**

① Indoor Unit: 36 Type      Outdoor Unit: CH3642

• High Pressure

High pressure characteristics versus outdoor ambient temperature and indoor temperature.  
(Indoor relative humidity: 50%, Indoor fan speed: High)

230V / 208V

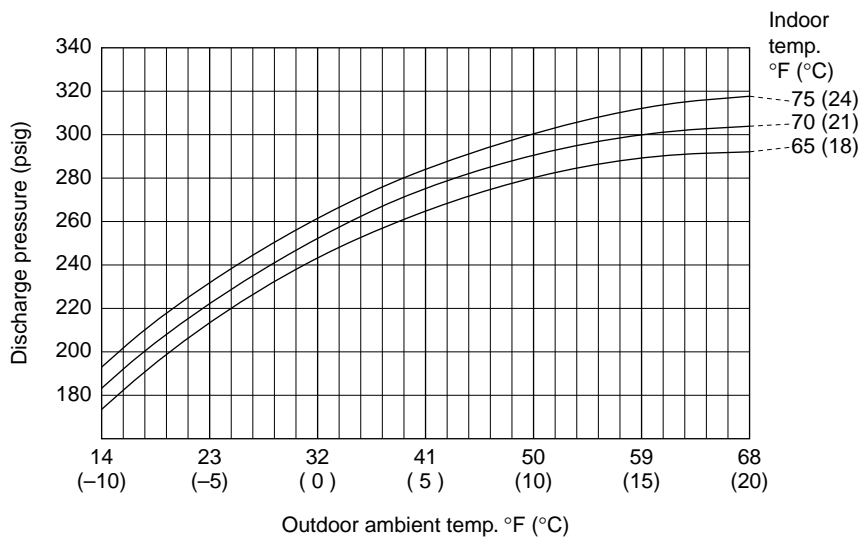

1165\_X\_S

1-9 Performance Charts

● Heating Characteristics

(2) Operating Pressure

① Indoor Unit: 42 Type Outdoor Unit: CH4242

• High Pressure

High pressure characteristics versus outdoor ambient temperature and indoor temperature. (Indoor relative humidity: 50%, Indoor fan speed: High)

230V / 208V

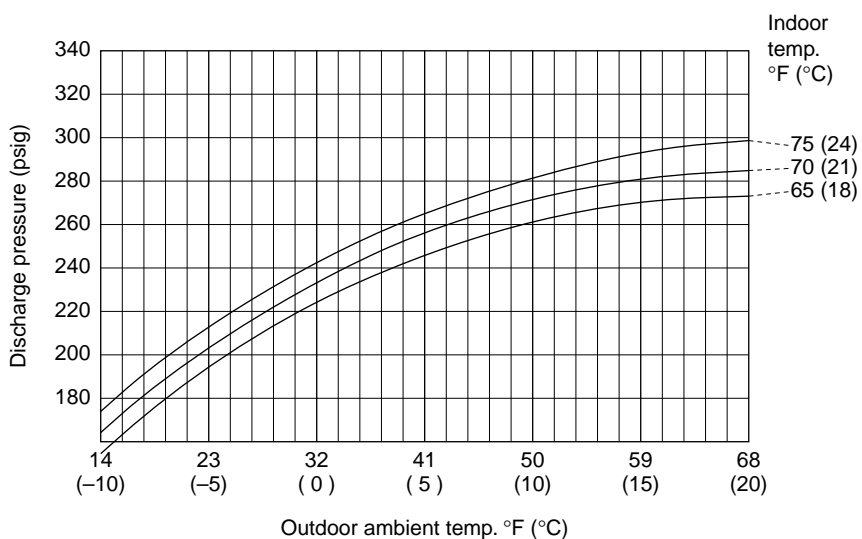

2229\_X\_S

• Low Pressure

Low pressure characteristics versus outdoor ambient temperature and indoor temperature. (Indoor relative humidity: 50%, Indoor fan speed: High)

230V / 208V

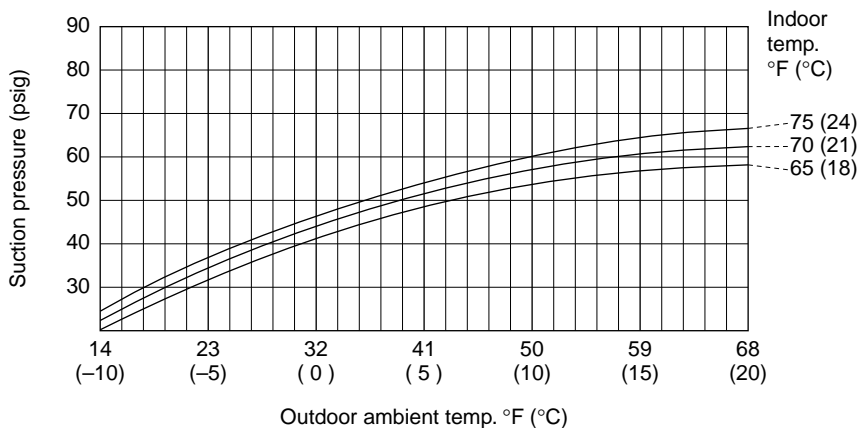

2230\_X\_S



1-10 Noise Criterion Curves

● 4-Way Air Discharge Semi-concealed Type

MODEL : XH2442  
 SOUND LEVEL : HIGH 38 dB(A), NC 31  
 LOW 31 dB(A), NC 23  
 CONDITION : Center, Under the unit 4.9 ft.  
 SOURCE : 208 - 230 V, 1 Phase, 60 Hz

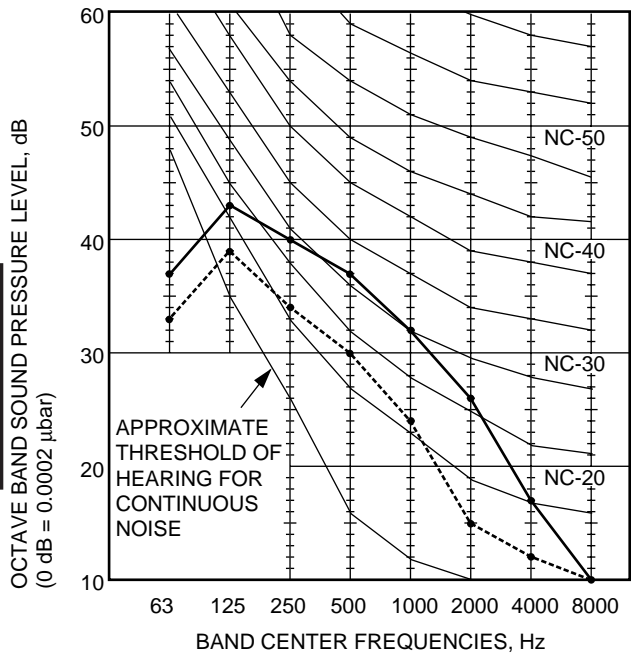

MODEL : XH3642  
 SOUND LEVEL : HIGH 44 dB(A), NC 37  
 LOW 33 dB(A), NC 25  
 CONDITION : Center, Under the unit 4.9 ft.  
 SOURCE : 208 - 230 V, 1 Phase, 60 Hz

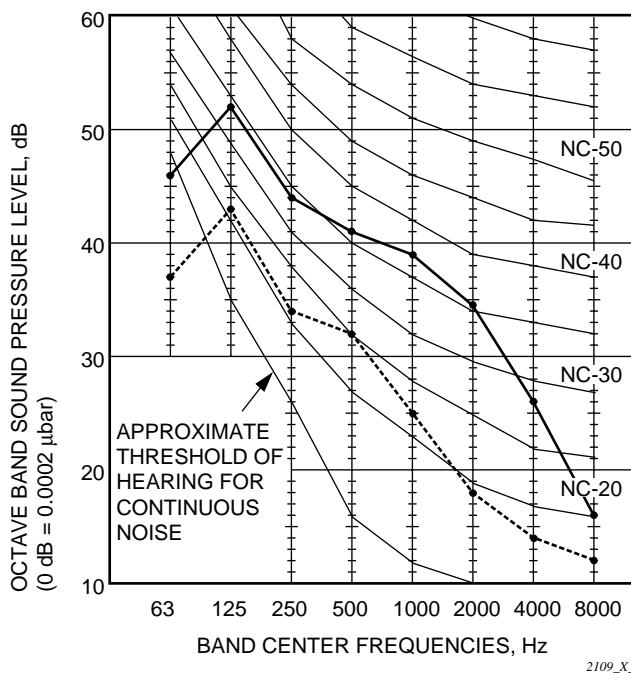

MODEL : XH4242  
 SOUND LEVEL : HIGH 45 dB(A), NC 38  
 LOW 34 dB(A), NC 27  
 CONDITION : Center, Under the unit 4.9 ft.  
 SOURCE : 208 - 230 V, 1 Phase, 60 Hz

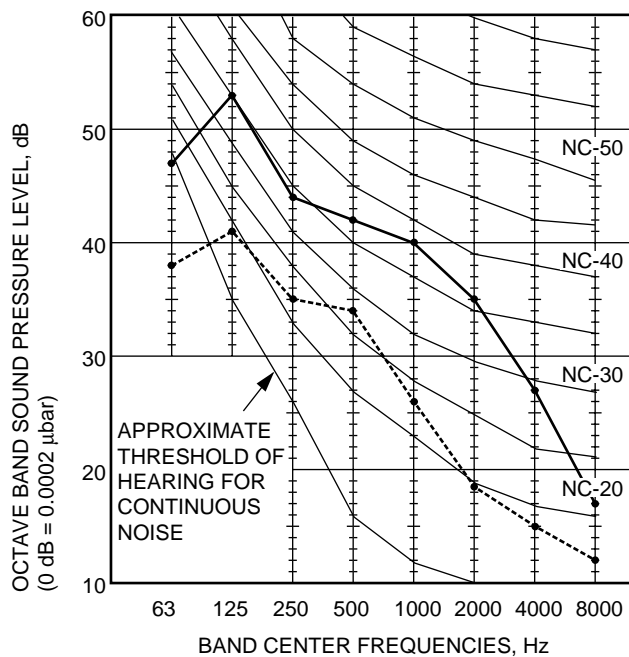

1-10 Noise Criterion Curves

● Ceiling Mounted Type

MODEL : TH2442  
 SOUND LEVEL : HIGH 40 dB(A), NC 34  
 LOW 36 dB(A), NC 26  
 CONDITION : Distance 3.3 ft., Under the unit 3.3 ft.  
 SOURCE : 208 - 230 V, 1 Phase, 60 Hz

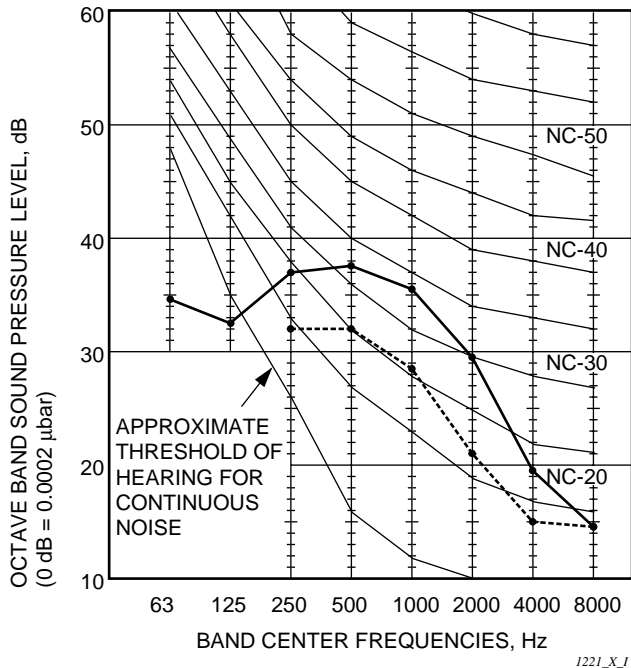

MODEL : TH4242  
 SOUND LEVEL : HIGH 47 dB(A), NC 40  
 LOW 38 dB(A), NC 32  
 CONDITION : Distance 3.3 ft., Under the unit 3.3 ft.  
 SOURCE : 208 - 230 V, 1 Phase, 60 Hz

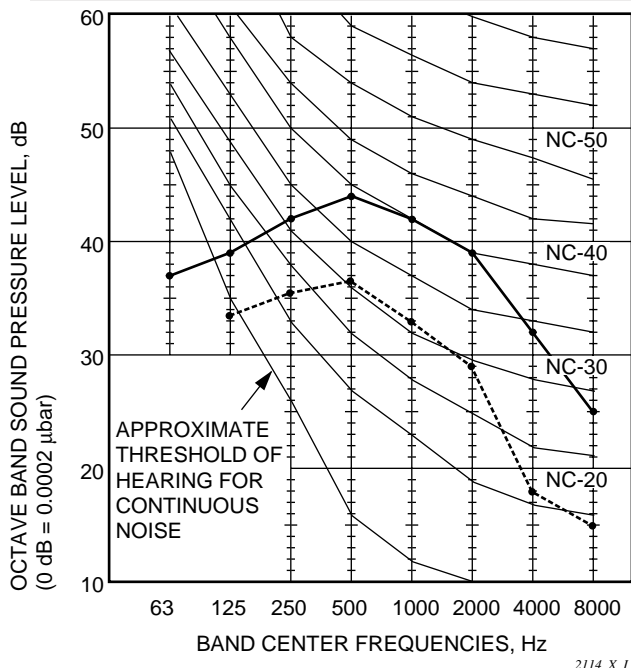

MODEL : TH3642  
 SOUND LEVEL : HIGH 46 dB(A), NC 39  
 LOW 37 dB(A), NC 31  
 CONDITION : Distance 3.3 ft., Under the unit 3.3 ft.  
 SOURCE : 208 - 230 V, 1 Phase, 60 Hz

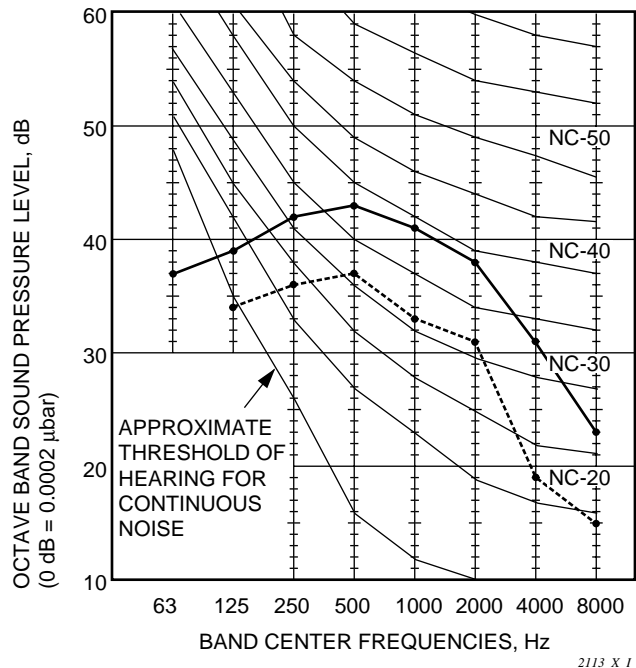

1-10 Noise Criterion Curves

● Concealed Duct Type

MODEL : UH2442  
 SOUND LEVEL : HIGH 34 dB(A), NC 22 / LOW 27 dB(A), NC 18  
 CONDITION : Under the unit 4.9 ft.  
 SOURCE : 208 - 230 V, 1 Phase, 60 Hz

MODEL : UH3642  
 SOUND LEVEL : HIGH 38 dB(A), NC 30 / LOW 31 dB(A), NC 21  
 CONDITION : Under the unit 4.9 ft.  
 SOURCE : 208 - 230 V, 1 Phase, 60 Hz

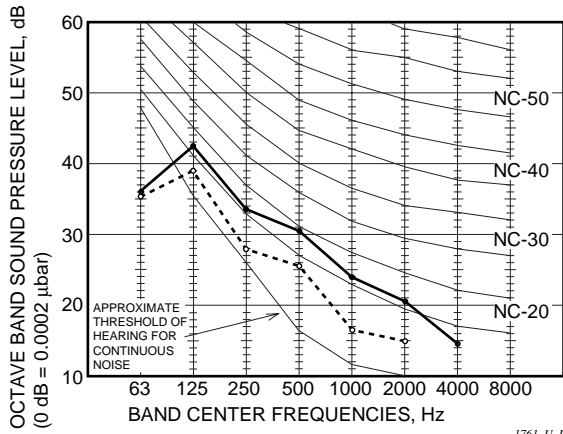

1761\_U\_I

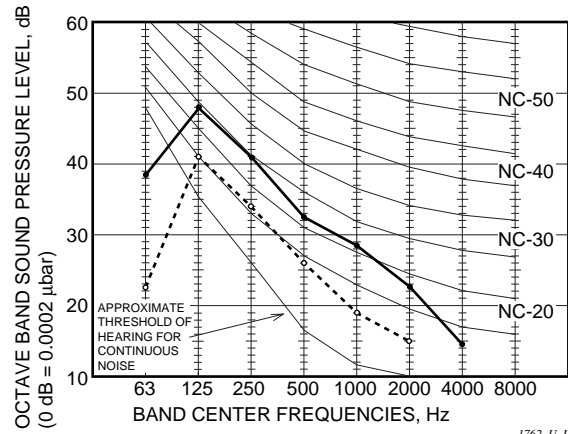

1762\_U\_I

1



1-10 Noise Criterion Curves

● Wall Mounted Type

MODEL : KH2442  
 SOUND LEVEL : HIGH 45 dB(A), NC 38  
 LOW 40 dB(A), NC 33  
 CONDITION : Distance 3.3 ft., Under the unit 3.3 ft.  
 SOURCE : 208 - 230 V, 1 Phase, 60 Hz

MODEL : KH3642  
 SOUND LEVEL : HIGH 48 dB(A), NC 41  
 LOW 40 dB(A), NC 33  
 CONDITION : Distance 3.3 ft., Under the unit 3.3 ft.  
 SOURCE : 208 - 230 V, 1 Phase, 60 Hz

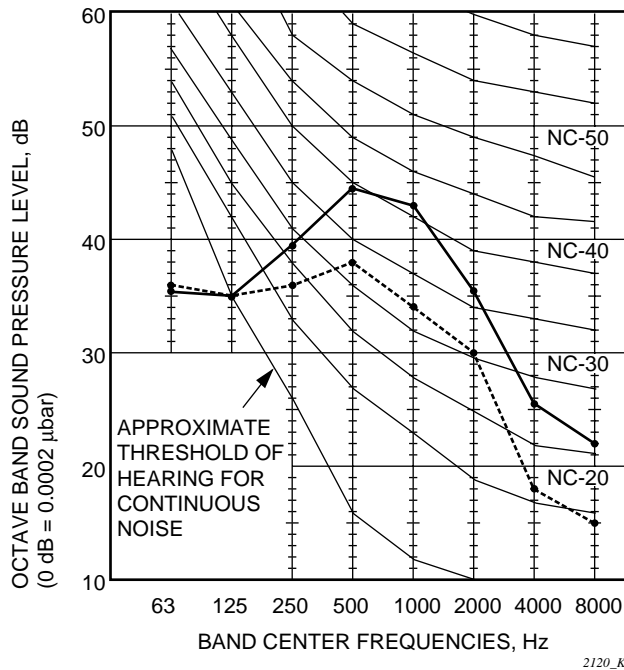
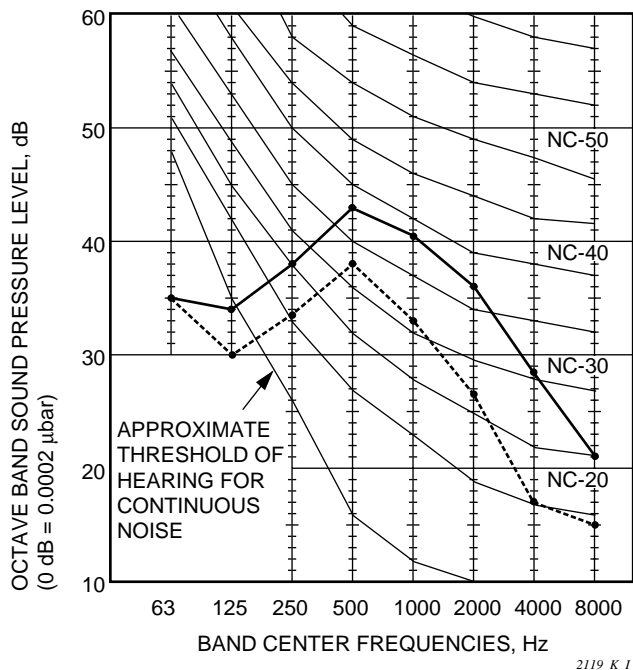

1-10 Noise Criterion Curves

● Outdoor Units

MODEL : CH2442  
 SOUND LEVEL : 53 dB(A), NC 44  
 CONDITION : Distance 1m, Height 1m  
 SOURCE : 230 - 208 V, 1 Phase, 60 Hz

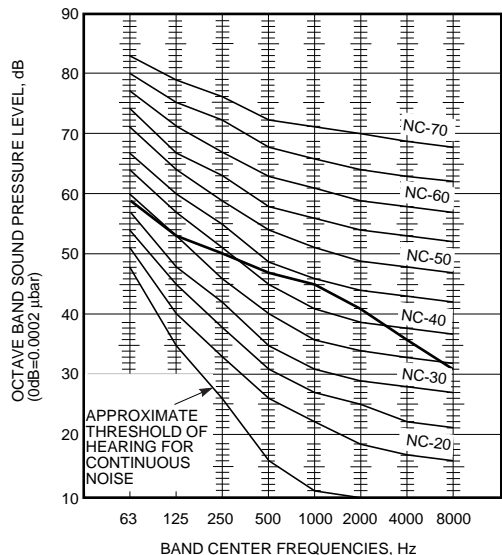

0597\_C\_S

MODEL : CH3642  
 SOUND LEVEL : 56 dB(A), NC 45  
 CONDITION : Distance 1m, Height 1m  
 SOURCE : 230 - 208 V, 1 Phase, 60 Hz

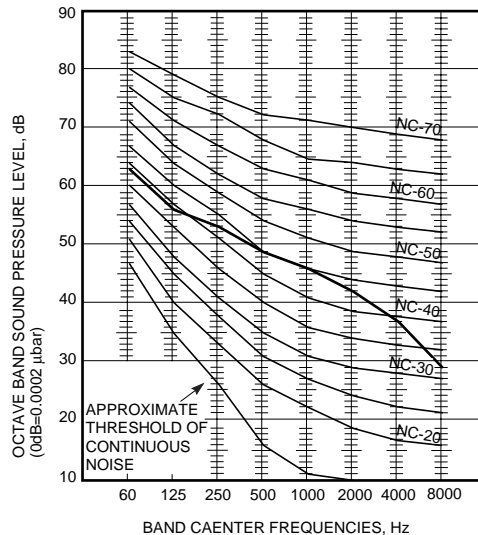

0598\_C\_S

MODEL : CH4242  
 SOUND LEVEL : 56 dB(A), NC 47  
 CONDITION : Distance 1m, Height 1m  
 SOURCE : 230 - 208 V, 1 Phase, 60 Hz

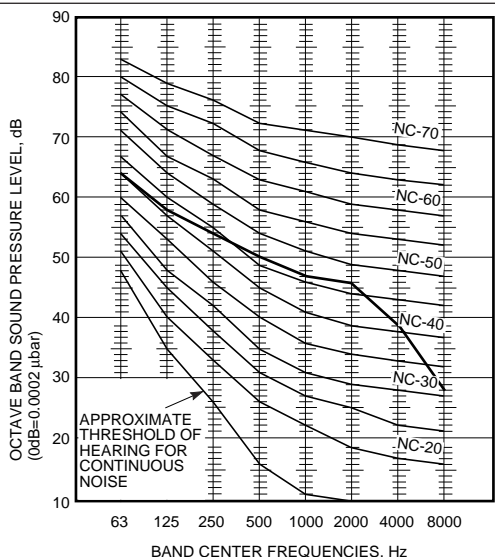

0599\_C\_S

- REMARKS:**
- Value obtained in the actual place where the unit is installed may be slightly higher than the values shown in this graph because of the conditions of operation, the structure of the building, the background noise and other factors.
  - The test results were obtained from an anechoic room.

**NOTE**

To evaluate "Noise level" the maximum number of the measured OCTAVE BAND SOUND PRESSURE LEVEL is used. Read the number on each BAND CENTER FREQUENCIES (horizontal axis) ranging from 63 Hz to 8000 Hz and select the maximum value (vertical axis) among them.

## 1-11 Increasing the Fan Speed

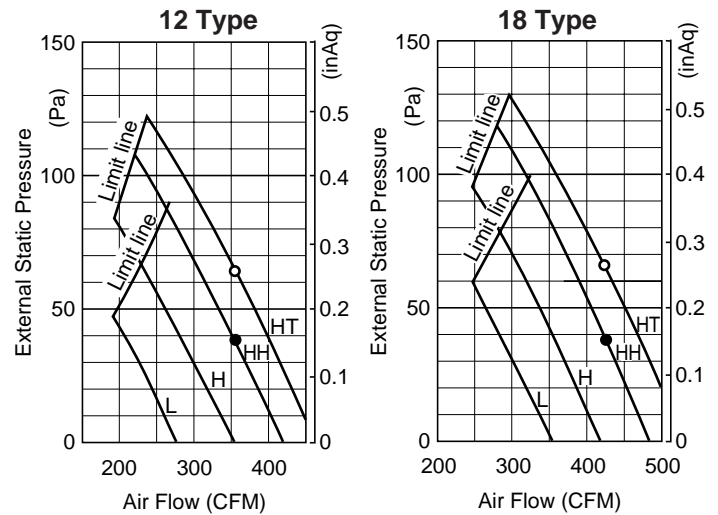
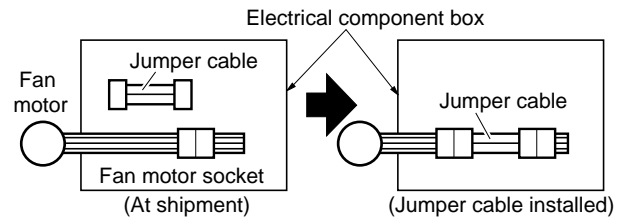

If external static pressure is too great (due to long extension of ducts, for example), the air flow volume may drop too low at each air outlet. This problem may be solved by increasing the fan speed using the following procedure:

- (1) Remove 4 screws on the electrical component box and remove the cover plate.
- (2) Disconnect the fan motor sockets in the box.
- (3) Take out the jumper cable (sockets at both ends) clamped in the box.
- (4) Securely connect the jumper cable sockets between the disconnected fan motor sockets in step 2.
- (5) Place the cable neatly in the box and reinstall the cover plate.

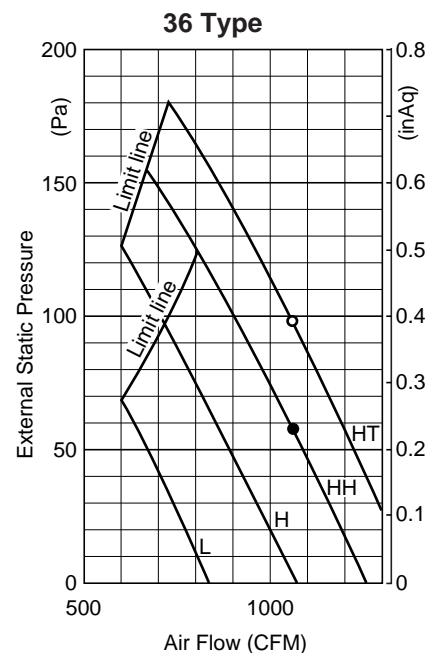
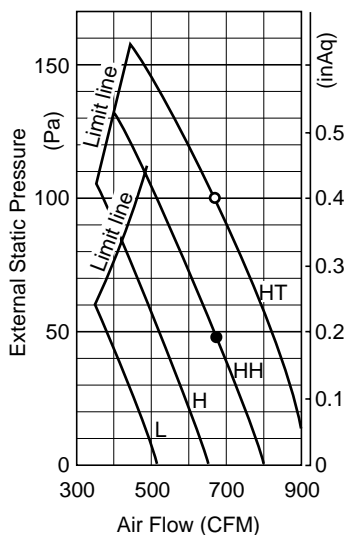

### Indoor Fan Performance 24 Type



**NOTE** HT : Using the booster cable   
 H : At shipment 

### How to read the diagram

The vertical axis is the external static pressure (Pa) while the horizontal axis represents the AIR FLOW (CFM). The characteristic curves for "HT", "H", "M" and "L" fan speed control are shown. The nameplate values are shown based on the "H" air flow. For the 24 type, the air flow is 636 CFM, while the external static pressure is 49 Pa at "H" position. If external static pressure is too great (due to long extension of duct, for example), the air flow volume may drop too low at each air outlet. This problem may be solved by increasing the fan speed as explained above.

1-12 Air throw distance chart

● 4-Way Air Discharge Semi-concealed Type

Model: 24 Type

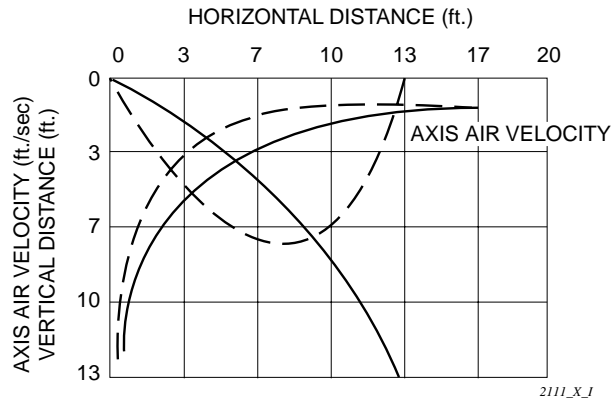

Model: 36, 42 Type

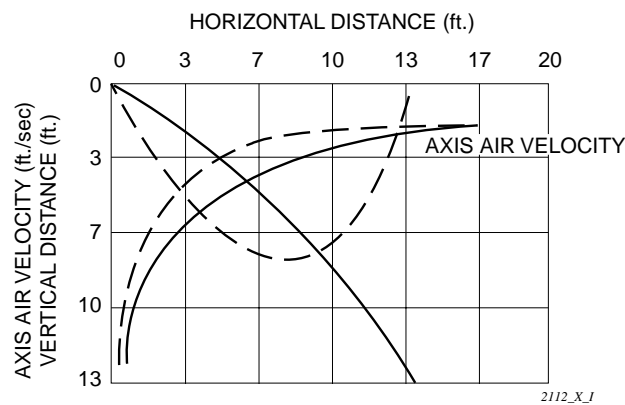

————— : LOUVER ANGLE 20° in Cooling mode  
 - - - - - : LOUVER ANGLE 60° in Heating mode

Condition Fan Speed : Hi

Room air temp. : 80 °C DB in cooling mode

68 °C DB in heating mode

1-12 Air throw distance chart

● Ceiling Mounted Type

Model: 24 Type

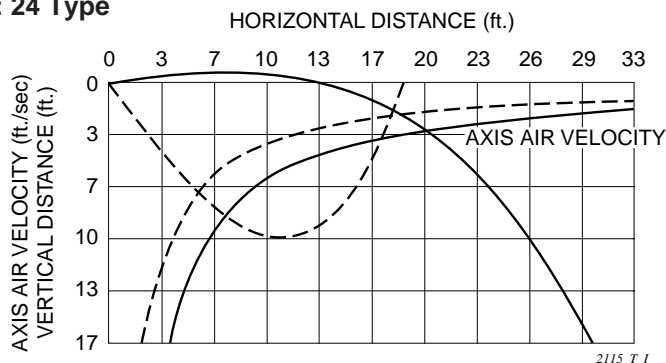

Model: 36 Type

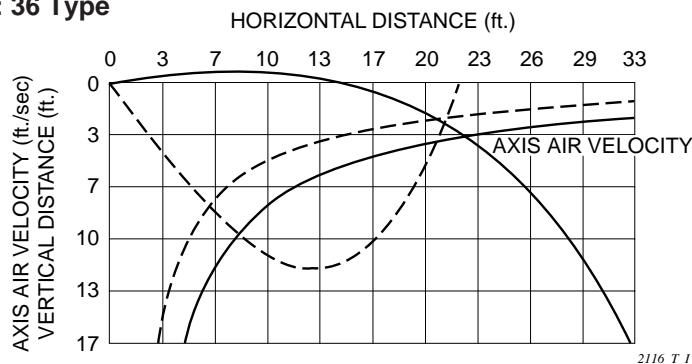

Model: 42 Type

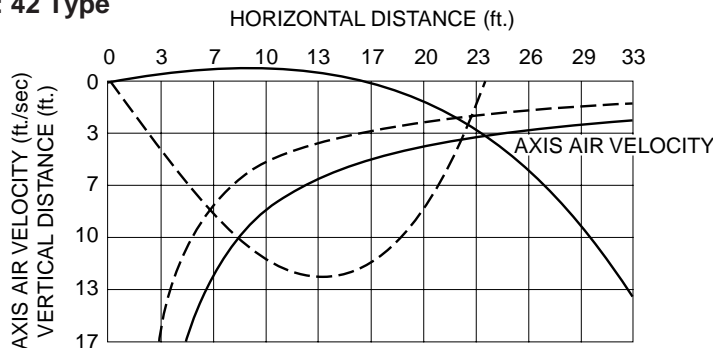

	COOLING	HEATING
FAN SPEED	HIGH	HIGH
ROOM AIR TEMP.	80° F	68° F
LOUVER ANGLE	- 7°	54°

————— : COOLING  
 - - - - - : HEATING

2117\_T\_J



1-12 Air throw distance chart

● Wall Mounted Type

MODEL: KHS2442

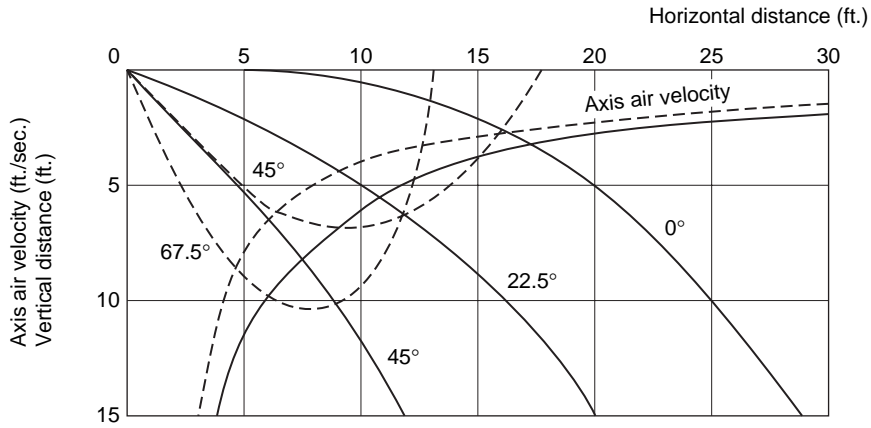

2121\_K\_S

	—— COOLING	----- HEATING
FAN SPEED	HIGH	HIGH
ROOM AIR TEMP.	80°F	70°F
FLAP ANGLE	0°, 22.5°, 45°	54°, 67.5°

MODEL: KHS3642

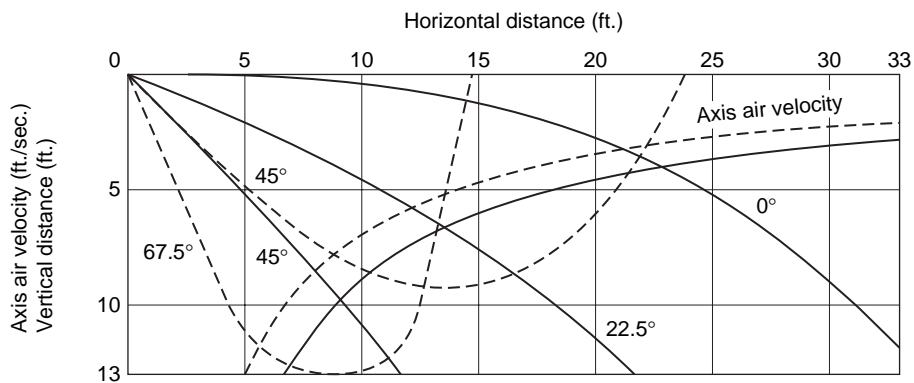

2122\_K\_S

	—— COOLING	----- HEATING
FAN SPEED	HIGH	HIGH
ROOM AIR TEMP.	80°F	70°F
FLAP ANGLE	0°, 22.5°, 45°	45°, 67.5°

1-13 Installation Instructions

● Tubing Length

- Refrigerant tubing between the indoor and outdoor units should be kept as short as possible.
- Select and decide the installation location so that the length of the refrigerant tubing will be within the limits given in Table 1-10.

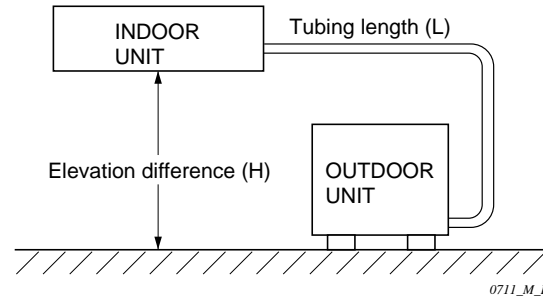

Fig. 1-1

Table 1-10

Tubing Data		Models	CH2442	CH3642, CH4242
Tubing size outer dia.	Narrow tube	in. (mm)	1/4 (6.35)	3/8 (9.52)
	Wide tube	in. (mm)	3/4 (19.05)	3/4 (19.05)
Limit of tubing length		(ft.)	165	165
Limit of elevation difference between the 2 units	Outdoor unit is higher than indoor unit (ft.)		165	165
	Outdoor unit is lower than indoor unit		100 (ft.)	100
Max. allowable tubing length at shipment		(ft.)	100	100
Required additional refrigerant		(oz./ft.)	0.48* <sup>1</sup>	0.53* <sup>2</sup>

No additional charge of compressor oil is necessary.

\*1 If total tubing length becomes 100 to 165 ft., charge additional refrigerant (R22) by 0.48 oz./ft..

\*2 If total tubing length becomes 100 to 165 ft., charge additional refrigerant (R22) by 0.53 oz./ft..



## ■ SELECTING THE INSTALLATION SITE

### Indoor Unit

#### AVOID:

- areas where leakage of flammable gas may be expected.
- places where large amounts of oil mist exist.
- direct sunlight.
- locations near inverter lamps which may affect performance of the unit.
- locations near heat sources which may affect performance of the unit.
- locations where external air may enter the room directly. This may cause "sweating" on the air discharge ports, causing them to spray or drip.
- locations where the remote control unit will be splashed with water or affected by dampness or humidity.
- installing the remote control unit behind curtains or furniture.
- locations where the receiver in the indoor unit is exposed to the inverter lamp light. Faulty operation of the unit occurs.

#### DO:

- select an appropriate position from which every corner of the room can be uniformly cooled.
- select a location where the ceiling is strong enough to support the weight of the unit.
- select a location where tubing and drain pipe have the shortest run to the outdoor unit.
- allow room for operation and maintenance as well as unrestricted air flow around the unit.
- install the unit within the maximum elevation difference above or below the outdoor unit and within a total tubing length from the outdoor unit as detailed in Table 1-10.
- allow room for mounting the remote control unit about 3 ft. off the floor, in an area that is not in direct sunlight nor in the flow of cool air from the indoor unit.

### NOTE

- Air delivery will be degraded if the distance from the floor to the ceiling is greater than 10 ft..

### Ceiling-Mounted Type

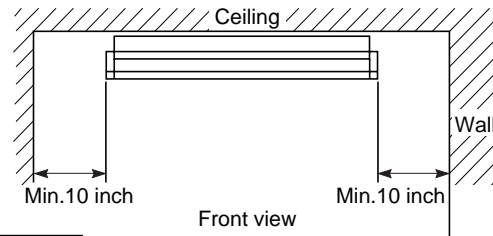

### NOTE

The rear of the indoor unit can be installed flush against the wall.

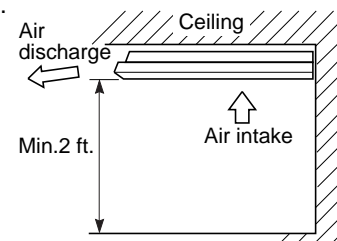

Side view

1091\_T\_1

### 4-Way Air Discharge Type Concealed-Duct Type

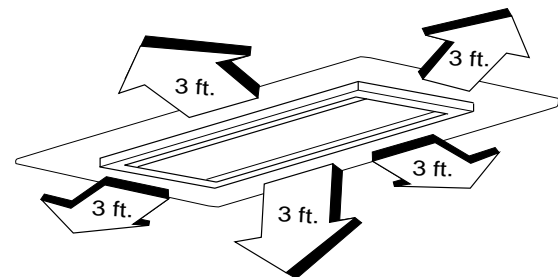

1960\_X\_1

### Wall-Mounted Type

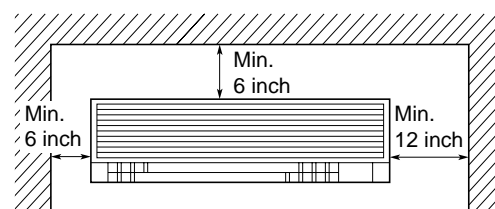

0930\_K\_1



## Outdoor Unit

### AVOID:

- heat sources, exhaust fans, etc. (Fig. 2-1)
- damp, humid or uneven locations.

### DO:

- choose a place as cool as possible.
- choose a place that is well ventilated and outside air temperature does not exceed maximum 115°F constantly.
- allow enough room around the unit for air intake/exhaust and possible maintenance. (Fig. 2-2)
- provide a solid base; about 6 inch above ground level to reduce humidity and possible water damage in the unit and decreased service life. (Fig. 2-3)
- use lug bolts or equivalent to bolt down unit, reducing vibration and noise.

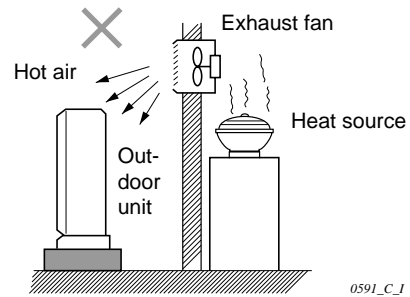

Fig. 2-1

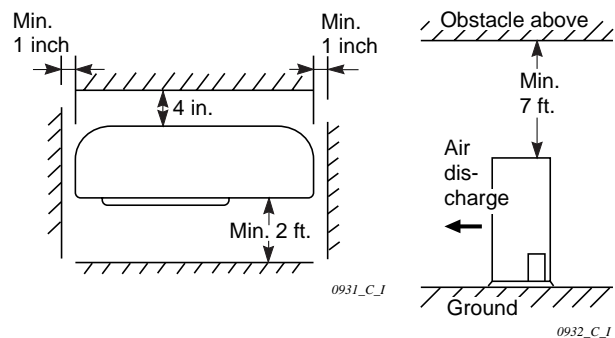
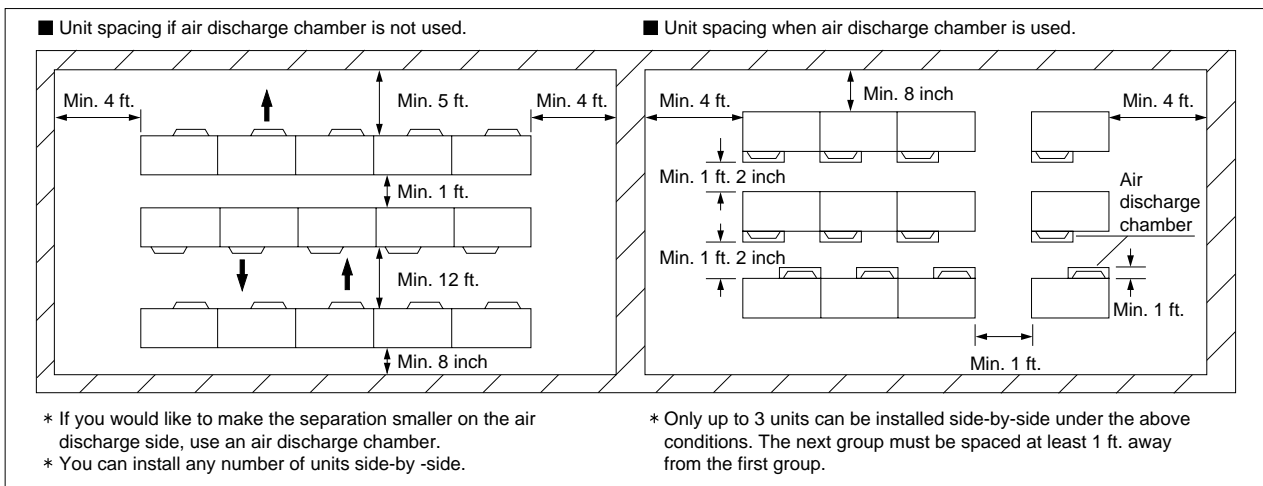

Fig. 2-2

### In case of multiple installations



0933\_C\_S

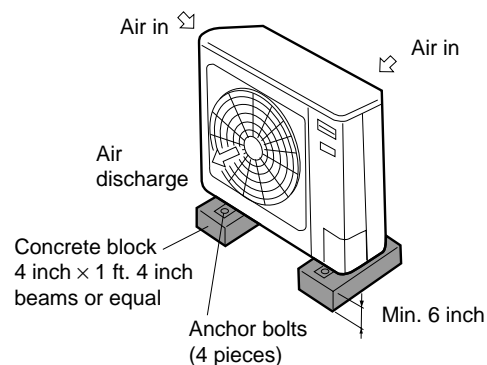

Fig. 2-3

0934\_C\_I

## ■ Air Discharge Chamber for Top Discharge

Install the air-discharge chamber in the field when:

- it is difficult to keep a space of minimum 2 ft. between the air-discharge outlet and the obstacle.
- the air-discharge outlet is facing the sidewalk and discharge hot air can annoy the passers-by.

Refer to Fig. 2-4.

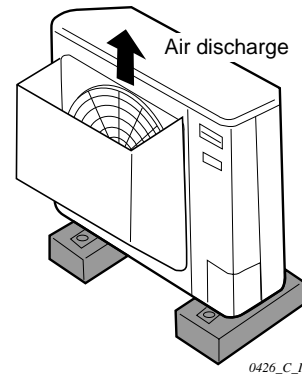

0426\_C\_1

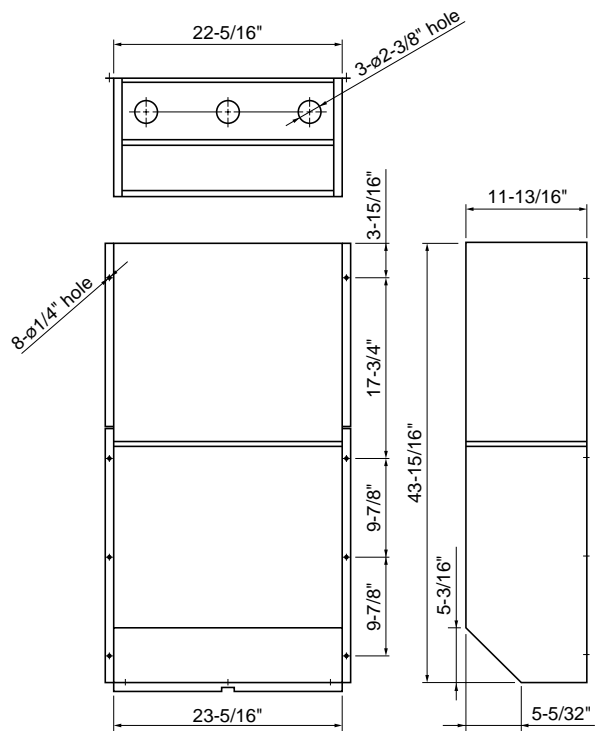

1352\_C\_1

CH3642

Recommended outer dimensions of wind shield  
(field supply)

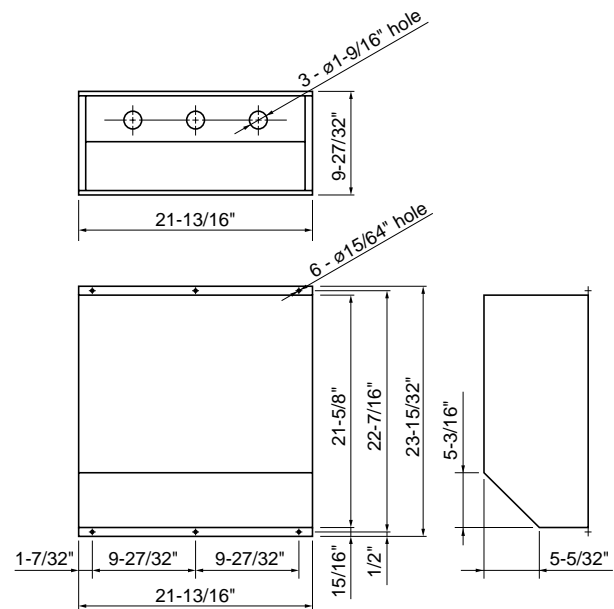

0936\_C\_1

CH2442

Fig. 2-4

## ■ Installing the Outdoor Unit in Heavy Snow Areas

In locations subject to strong winds, snow-proof ducting should be fitted and direct exposure to the wind should be avoided as much as possible.

The following problems may occur when the outdoor unit is not provided with a platform and snow-proof ducting.

- a) The outdoor fan may not run and there may be damage to the unit
- b) There may be no air flow.
- c) The tubing may freeze and burst.
- d) The condenser pressure may drop because of strong wind, and the indoor unit may freeze.

## ■ Precautions When Installing in Heavy Snow Areas

- (1) The platform should be higher than the maximum snow depth. (Fig. 2-5)
- (2) The two anchoring feet of the outdoor unit should be attached to the platform, and the platform should be installed beneath the air-intake side of the outdoor unit.
- (3) The platform foundation must be solid and the unit must be secured with anchor bolts.
- (4) When installing on a roof subject to strong wind, countermeasures must be taken to prevent the unit from being overturned.

## ■ Dimensions of Snow / Wind-proof Ducting and Refrigerant Tubing Space for Installation

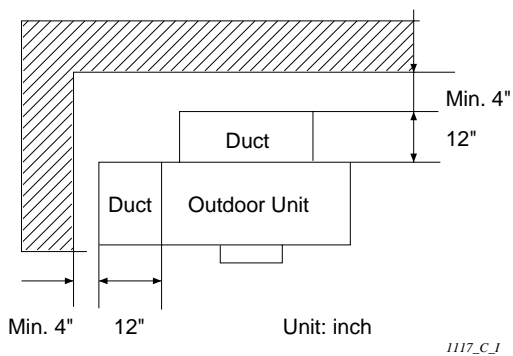

In regions with snow fall, the outdoor unit should be provided with a platform and snow-proof duct.

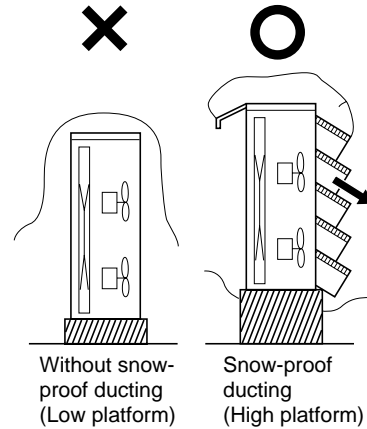

Fig. 2-5

Fig. 2-6

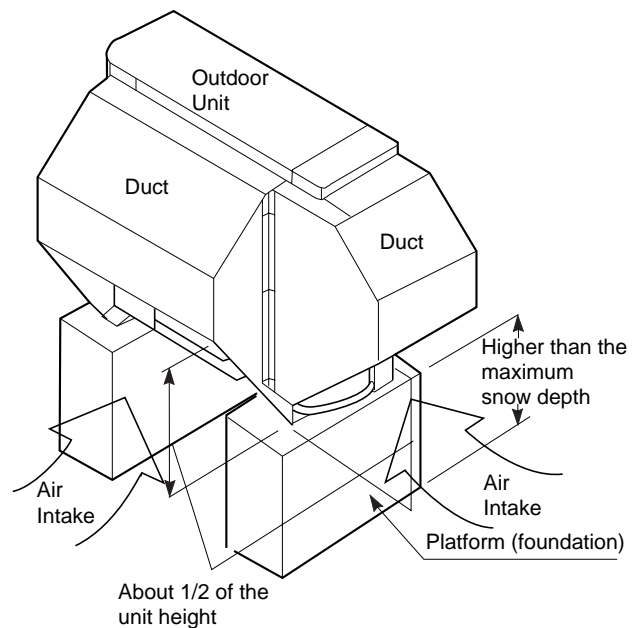

Fig. 2-7

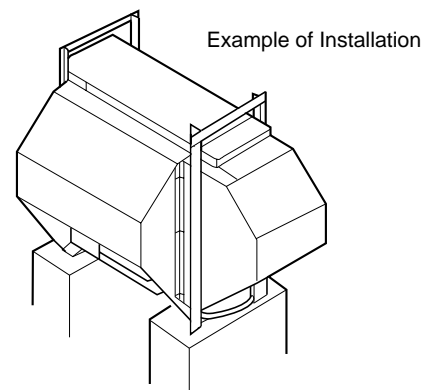

Fig. 2-8

■ ELECTRICAL WIRING

● General Precautions on Wiring

- (1) Before wiring, confirm the rated voltage of the unit as shown on its nameplate, then carry out the wiring closely following the wiring diagram.
- (2) Provide a power outlet to be used exclusively for each unit, and a power supply disconnect and circuit breaker for overcurrent protection should be provided in the exclusive line.
- (3) To prevent possible hazards from insulation failure, the unit must be grounded.
- (4) Each wiring connection must be done in accordance with the wiring system diagram. Wrong wiring may cause the unit to misoperate or become damaged.
- (5) Do not allow wiring to touch the refrigerant tubing, compressor, or any moving parts of the fan.
- (6) Unauthorized changes in the internal wiring can be very dangerous. The manufacturer will accept no responsibility for any damage or misoperation that occurs as a result of such unauthorized changes.
- (7) Regulations on wire diameters differ from locality to locality. For field wiring rules, must follow your LOCAL ELECTRICAL CODES before beginning. You must ensure that installation complies with all relevant rules and regulations.
- (8) To prevent malfunction of the air conditioner caused by electrical noise, care must be taken when wiring as follows:
  - The remote control wiring and the inter-unit control wiring should be wired apart from the inter-unit power wiring.
  - Use shielded wires for inter-unit control wiring between units and ground the shield on both sides.
- (9) If the power supply cord of this appliance is damaged, it must be replaced by a repair shop appointed by the manufacture, because special purpose tools are required.
- (10) All wiring must be used class 1.

● Recommended Wire Length and Wire Diameter for Power Supply System

Must follow LOCAL ELECTRICAL CODES for wiring.

Outdoor Unit

\* AWG = American Wire Gauge

Model Name	(A) Power Supply	Trade size of Conduit	MOP (Fuse or HACR type circuit braker)	Power Supply Terminal Base		Trade size of Conduit
				Capacity	Max. Wire Diameter	
CH2442	AWG #12 Max. length 69 ft.	3/4 in.	25 A	50 A	AWG #6	1-1/4 in.
CH3642	AWG #12 Max. length 69 ft.	3/4 in.	35 A/40 A (230/208 V)	50 A	AWG #6	1-1/4 in.
CH4242	AWG #10 Max. length 67 ft.	3/4 in.	45 A	50 A	AWG #6	1-1/4 in.

Indoor Unit

Type	(B) Power Supply	Trade size of Conduit	MOP (Fuse or HACR type circuit braker)	Power Supply Terminal Base		Trade size of Conduit
				Capacity	Max. Wire Diameter	
X, K, T, U	Max. length 330 ft.	3/4 in.	15 A	25 A	AWG #10	3/4 in.

Control Wiring

(C) Inter-Unit Control Wiring	(D) Remote Control Wiring	(E) Control Wiring For Group Control
AWG #18 (0.75 mm <sup>2</sup> ) <b>Use high voltage wire (300 V)<sup>*1</sup></b>	AWG #18* (0.75 mm <sup>2</sup> )	AWG #18 <sup>*2</sup> (0.75 mm <sup>2</sup> )
Max. 3,300 ft.	Max. 1,650 ft.	Max. 1,650 ft. (Total)

**NOTE** \*1 With ring type wire terminal.  
\*2 Wire joint connection.

## ● Wiring System Diagrams

### (1) Basic wiring diagram for standard control

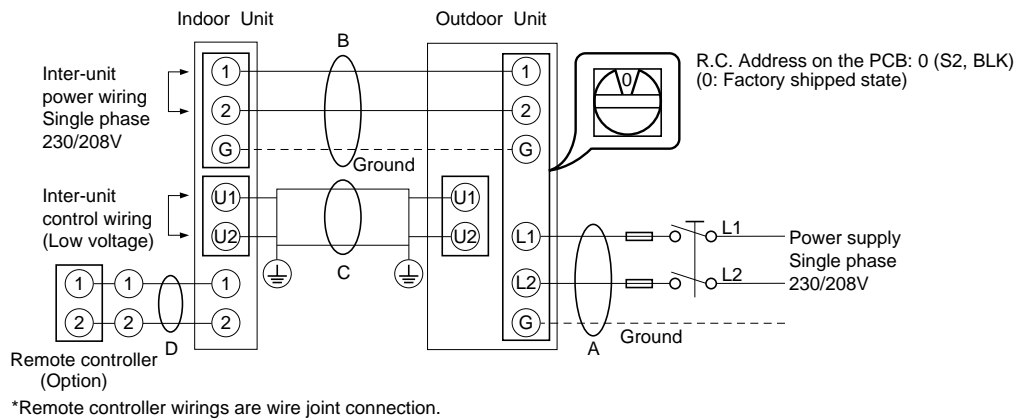

2085\_M\_I

### NOTE

- (1) Refer to “Recommended Wire Length and Wide Diameter for Power Supply System” for the explanation of “A”, “B”, “C”, “D”, and “E”, in the above diagrams.
- (2) Inter-Unit Control Wiring (C) and remote controller wiring (D), (E) has no polarity. But for other wiring, respect polarity. Be sure to connect as shown in the Wiring System Diagram.
- (3) R.C. Address should be set before turning the power on.
- (4) Regarding the R.C. Address setting, refer to Auto. address setting can be executed by a remote controller automatically.

### CH Type

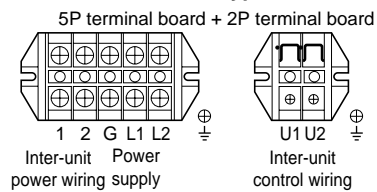

2086\_M\_I

### XH, TH, UH Type

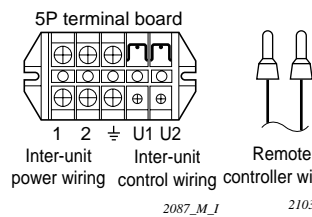

2087\_M\_I

2103\_M\_I

### KH Type

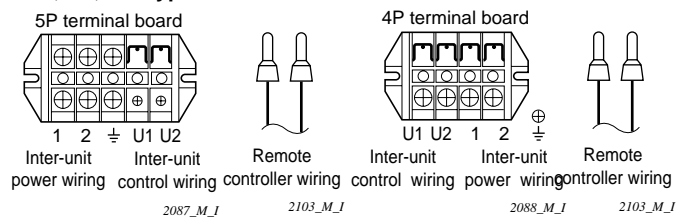

2088\_M\_I

2103\_M\_I

## (2) Basic wiring diagram for group control

This diagram shows when several units (max. 8) are controlled by a remote controller. In this case, a remote controller can be connected at any indoor unit.

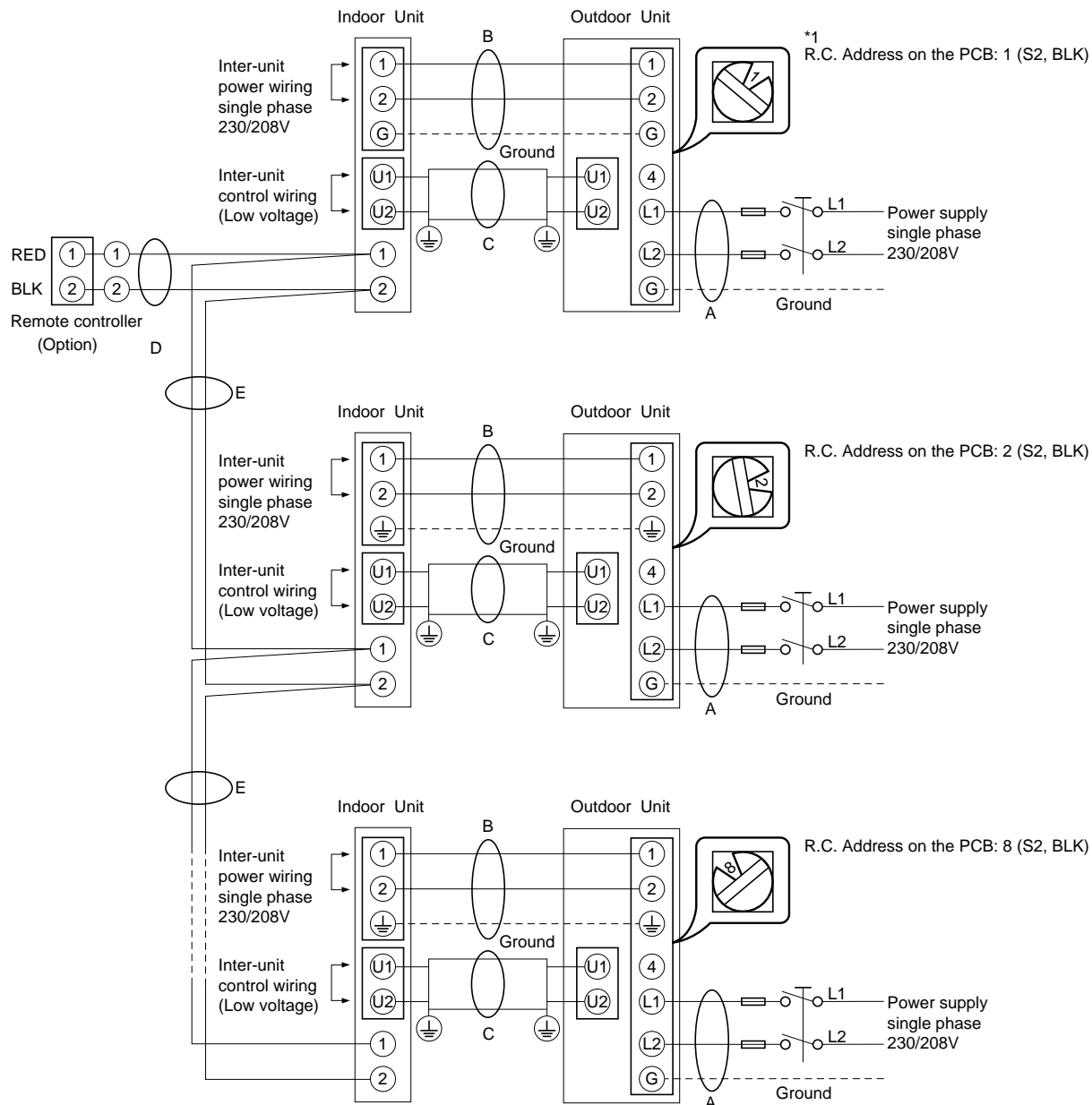

\*Remote controller wirings are wire joint connection.

2089\_M\_1

### NOTE

- R.C. Address should be set before turning the power on.
- Auto. address setting can be executed by a remote controller automatically. Please refer to "Automatic Address Setting Method".
- Each successive unit will respond at one-second intervals following the order of the R.C. address when the remote controller is operated.

## Electrical characteristics

### ■ Electrical Data

**Indoor model: XH2442 / Outdoor model: CH2442**

#### ● Cooling

		Indoor Unit	Outdoor Unit		Complete Unit
		Fan Motor	Fan Motor	Compressor	
Performance at		230 - 208 V / 1 phase / 60 Hz		230 - 208 V / 1 phase / 60 Hz	
Rating conditions	A	0.6 - 0.6	0.9 - 0.9	9.7 - 10.1	11.2 - 11.6
	kW	0.12 - 0.11	0.18 - 0.17	2.15 - 2.07	2.45 - 2.35
Full load conditions	A	0.6 - 0.6	0.9 - 0.9	11.1 - 12.0	12.6 - 13.5
	kW	0.12 - 0.11	0.18 - 0.17	2.50 - 2.47	2.80 - 2.75
Starting amperes	A	1 - 1	1 - 1	66 - 60	68 - 62

#### ● Heating

		Indoor Unit	Outdoor Unit		Complete Unit
		Fan Motor	Fan Motor	Compressor	
Performance at		230 - 208 V / 1 phase / 60 Hz		230 - 208 V / 1 phase / 60 Hz	
Rating conditions	A	0.4 - 0.4	0.9 - 0.9	10.4 - 11.0	11.7 - 12.3
	kW	0.09 - 0.08	0.18 - 0.17	2.23 - 2.20	2.50 - 2.45
Full load conditions	A	0.4 - 0.4	0.9 - 0.9	10.8 - 11.7	12.1 - 13.0
	kW	0.09 - 0.08	0.18 - 0.17	2.43 - 2.40	2.70 - 2.65
Starting amperes	A	1 - 1	1 - 1	66 - 60	68 - 62

#### Cooling:

Rating Conditions : Indoor Air Temperature 80 °F DB / 67 °F WB  
 Outdoor Air Temperature 95 °F DB  
 Full Load Conditions : Indoor Air Temperature 80 °F DB / 67 °F WB  
 Outdoor Air Temperature 115 °F DB

#### Heating:

Rating Conditions : Indoor Air Temperature 70 °F DB / 60 °F WB  
 Outdoor Air Temperature 47 °F DB / 43 °F WB  
 Full Load Conditions : Indoor Air Temperature 80 °F DB / — °F WB  
 Outdoor Air Temperature 45 °F DB / 35 °F WB

## Indoor model: XH3642 / Outdoor model: CH3642

### ● Cooling

		Indoor Unit	Outdoor Unit		Complete Unit
		Fan Motor	Fan Motor	Compressor	
Performance at		230 - 208 V / 1 phase / 60 Hz		230 - 208 V / 1 phase / 60 Hz	
Rating conditions	A	0.9 - 0.8	1.8 - 1.8	12.7 - 13.2	15.4 - 15.8
	kW	0.20 - 0.16	0.36 - 0.34	2.79 - 2.70	3.35 - 3.20
Full load conditions	A	0.9 - 0.8	1.8 - 1.8	15.4 - 16.7	18.1 - 19.3
	kW	0.20 - 0.16	0.36 - 0.34	3.43 - 3.41	3.99 - 3.91
Starting amperes	A	1 - 1	2 - 2	95 - 86	98 - 89

### ● Heating

		Indoor Unit	Outdoor Unit		Complete Unit
		Fan Motor	Fan Motor	Compressor	
Performance at		230 - 208 V / 1 phase / 60 Hz		230 - 208 V / 1 phase / 60 Hz	
Rating conditions	A	0.7 - 0.6	1.8 - 1.8	15.7 - 16.9	18.2 - 19.3
	kW	0.16 - 0.12	0.36 - 0.34	3.33 - 3.29	3.85 - 3.75
Full load conditions	A	0.7 - 0.6	1.8 - 1.8	14.2 - 15.6	16.7 - 18.0
	kW	0.16 - 0.12	0.36 - 0.34	3.16 - 3.21	3.68 - 3.67
Starting amperes	A	1 - 1	2 - 2	95 - 86	98 - 89

#### Cooling:

Rating Conditions : Indoor Air Temperature 80 °F DB / 67 °F WB  
 Outdoor Air Temperature 95 °F DB  
 Full Load Conditions : Indoor Air Temperature 80 °F DB / 67 °F WB  
 Outdoor Air Temperature 115 °F DB

#### Heating:

Rating Conditions : Indoor Air Temperature 70 °F DB / 60 °F WB  
 Outdoor Air Temperature 47 °F DB / 43 °F WB  
 Full Load Conditions : Indoor Air Temperature 80 °F DB / — °F WB  
 Outdoor Air Temperature 45 °F DB / 35 °F WB



## Electrical characteristics

### ■ Electrical Data

**Indoor model: XH4242 / Outdoor model: CH4242**

#### ● Cooling

		Indoor Unit		Outdoor Unit				Complete Unit	
		Fan Motor		Fan Motor		Compressor			
Performance at		230 V	208 V	230 V	208 V	230 V	208 V	230 V	208 V
Rating conditions	A	1.0	0.9	1.8	1.8	17.8	18.3	20.6	21.0
	kW	0.2	0.17	0.36	0.34	3.64	3.58	4.2	4.09
Full load conditions	A	1.0	0.9	1.8	1.8	21.0	21.9	23.8	24.6
	kW	0.2	0.17	0.36	0.34	4.41	4.33	4.97	4.84
Starting amperes	A	2	2	2	2	131	131	134	133.9

#### ● Heating

		Indoor Unit		Outdoor Unit				Complete Unit	
		Fan Motor		Fan Motor		Compressor			
Performance at		230 V	208 V	230 V	208 V	230 V	208 V	230 V	208 V
Rating conditions	A	0.9	0.8	1.8	1.8	18.9	19.6	21.6	22.2
	kW	0.19	0.16	0.36	0.34	3.9	3.85	4.45	4.35
Full load conditions	A	0.9	0.8	1.8	1.8	21.2	22.8	23.9	25.4
	kW	0.19	0.16	0.36	0.34	4.48	4.52	5.03	5.02
Starting amperes	A	2	2	2	2	131	131	133.9	133.8

#### Cooling:

Rating Conditions : Indoor Air Temperature 80 °F DB / 67 °F WB  
 Outdoor Air Temperature 95 °F DB  
 Full Load Conditions : Indoor Air Temperature 80 °F DB / 67 °F WB  
 Outdoor Air Temperature 115 °F DB

#### Heating:

Rating Conditions : Indoor Air Temperature 70 °F DB / 60 °F WB  
 Outdoor Air Temperature 47 °F DB / 43 °F WB  
 Full Load Conditions : Indoor Air Temperature 80 °F DB / — °F WB  
 Outdoor Air Temperature 45 °F DB / 35 °F WB

## Indoor model: TH2442 / Outdoor model: CH2442

### ● Cooling

		Indoor Unit	Outdoor Unit		Complete Unit
		Fan Motor	Fan Motor	Compressor	
Performance at		230 - 208 V / 1 phase / 60 Hz		230 - 208 V / 1 phase / 60 Hz	
Rating conditions	A	0.4 - 0.4	0.9 - 0.9	9.4 - 10.0	10.7 - 11.3
	kW	0.08 - 0.07	0.18 - 0.17	2.09 - 2.04	2.35 - 2.28
Full load conditions	A	0.4 - 0.4	0.9 - 0.9	11.0 - 11.7	12.3 - 13.0
	kW	0.08 - 0.07	0.18 - 0.17	2.45 - 2.42	2.71 - 2.66
Starting amperes	A	1 - 1	1 - 1	66 - 60	68 - 62

### ● Heating

		Indoor Unit	Outdoor Unit		Complete Unit
		Fan Motor	Fan Motor	Compressor	
Performance at		230 - 208 V / 1 phase / 60 Hz		230 - 208 V / 1 phase / 60 Hz	
Rating conditions	A	0.4 - 0.4	0.9 - 0.9	10.4 - 11.6	11.7 - 12.9
	kW	0.08 - 0.07	0.18 - 0.17	2.29 - 2.26	2.55 - 2.50
Full load conditions	A	0.4 - 0.4	0.9 - 0.9	11.4 - 11.8	12.7 - 13.1
	kW	0.08 - 0.07	0.18 - 0.17	2.55 - 2.44	2.81 - 2.68
Starting amperes	A	1 - 1	1 - 1	66 - 60	68 - 62

#### Cooling:

Rating Conditions : Indoor Air Temperature 80 °F DB / 67 °F WB  
 Outdoor Air Temperature 95 °F DB  
 Full Load Conditions : Indoor Air Temperature 80 °F DB / 67 °F WB  
 Outdoor Air Temperature 115 °F DB

#### Heating:

Rating Conditions : Indoor Air Temperature 70 °F DB / 60 °F WB  
 Outdoor Air Temperature 47 °F DB / 43 °F WB  
 Full Load Conditions : Indoor Air Temperature 80 °F DB / — °F WB  
 Outdoor Air Temperature 45 °F DB / 35 °F WB

## Indoor model: TH3642 / Outdoor model: CH3642

### ● Cooling

		Indoor Unit	Outdoor Unit		Complete Unit
		Fan Motor	Fan Motor	Compressor	
Performance at		230 - 208 V / 1 phase / 60 Hz		230 - 208 V / 1 phase / 60 Hz	
Rating conditions	A	0.7 - 0.7	1.8 - 1.8	12.6 - 13.2	15.1 - 15.7
	kW	0.16 - 0.14	0.36 - 0.34	2.83 - 2.69	3.35 - 3.17
Full load conditions	A	0.7 - 0.7	1.8 - 1.8	15.4 - 16.8	17.9 - 19.3
	kW	0.16 - 0.14	0.36 - 0.34	3.45 - 3.38	3.97 - 3.86
Starting amperes	A	1 - 1	2 - 2	95 - 86	97.7 - 88.7

### ● Heating

		Indoor Unit	Outdoor Unit		Complete Unit
		Fan Motor	Fan Motor	Compressor	
Performance at		230 - 208 V / 1 phase / 60 Hz		230 - 208 V / 1 phase / 60 Hz	
Rating conditions	A	0.7 - 0.7	1.8 - 1.8	15.7 - 17.1	18.2 - 19.6
	kW	0.16 - 0.14	0.36 - 0.34	3.43 - 3.41	3.95 - 3.89
Full load conditions	A	0.7 - 0.7	1.8 - 1.8	13.6 - 14.6	16.1 - 17.1
	kW	0.16 - 0.14	0.36 - 0.34	3.02 - 2.98	3.54 - 3.46
Starting amperes	A	1 - 1	2 - 2	95 - 86	97.7 - 88.7

### Cooling:

Rating Conditions : Indoor Air Temperature 80 °F DB / 67 °F WB  
 Outdoor Air Temperature 95 °F DB  
 Full Load Conditions : Indoor Air Temperature 80 °F DB / 67 °F WB  
 Outdoor Air Temperature 115 °F DB

### Heating:

Rating Conditions : Indoor Air Temperature 70 °F DB / 60 °F WB  
 Outdoor Air Temperature 47 °F DB / 43 °F WB  
 Full Load Conditions : Indoor Air Temperature 80 °F DB / — °F WB  
 Outdoor Air Temperature 45 °F DB / 35 °F WB

## Indoor model: TH4242 / Outdoor model: CH4242

### ● Cooling

		Indoor Unit		Outdoor Unit				Complete Unit	
		Fan Motor		Fan Motor		Compressor			
Performance at		230 V	208 V	230 V	208 V	230 V	208 V	230 V	208 V
Rating conditions	A	0.8	0.7	1.8	1.8	18.0	18.8	20.6	21.3
	kW	0.18	0.15	0.36	0.34	3.76	3.71	4.3	4.2
Full load conditions	A	0.8	0.7	1.8	1.8	21.0	22.6	23.6	25.1
	kW	0.18	0.15	0.36	0.34	4.49	4.49	5.03	4.98
Starting amperes	A	1	1	2	2	131	131	133.8	133.7

### ● Heating

		Indoor Unit		Outdoor Unit				Complete Unit	
		Fan Motor		Fan Motor		Compressor			
Performance at		230 V	208 V	230 V	208 V	230 V	208 V	230 V	208 V
Rating conditions	A	0.8	0.7	1.8	1.8	19.1	20.0	21.7	22.5
	kW	0.18	0.15	0.36	0.34	3.91	3.86	4.45	4.35
Full load conditions	A	0.8	0.7	1.8	1.8	21.2	23.6	23.8	26.1
	kW	0.18	0.15	0.36	0.34	4.52	4.67	5.06	5.16
Starting amperes	A	1	1	2	2	131	131	133.8	133.7

#### Cooling:

Rating Conditions : Indoor Air Temperature 80 °F DB / 67 °F WB  
 Outdoor Air Temperature 95 °F DB  
 Full Load Conditions : Indoor Air Temperature 80 °F DB / 67 °F WB  
 Outdoor Air Temperature 115 °F DB

#### Heating:

Rating Conditions : Indoor Air Temperature 70 °F DB / 60 °F WB  
 Outdoor Air Temperature 47 °F DB / 43 °F WB  
 Full Load Conditions : Indoor Air Temperature 80 °F DB / — °F WB  
 Outdoor Air Temperature 45 °F DB / 35 °F WB

## Indoor model: UH2442 / Outdoor model: CH2442

### ● Cooling

		Indoor Unit	Outdoor Unit		Complete Unit
		Fan Motor	Fan Motor	Compressor	
Performance at		230 - 208 V / 1 phase / 60 Hz		230 - 208 V / 1 phase / 60 Hz	
Rating conditions	A	0.9 - 0.8	0.9 - 0.9	9.7 - 10.4	11.5 - 12.1
	kW	0.18 - 0.16	0.18 - 0.17	2.19 - 2.15	2.55 - 2.48
Full load conditions	A	0.9 - 0.8	0.9 - 0.9	11.1 - 12	12.9 - 13.7
	kW	0.18 - 0.16	0.18 - 0.17	2.53 - 2.48	2.89 - 2.81
Starting amperes	A	2 - 2	1 - 1	66 - 60	67.9 - 61.8

### ● Heating

		Indoor Unit	Outdoor Unit		Complete Unit
		Fan Motor	Fan Motor	Compressor	
Performance at		230 - 208 V / 1 phase / 60 Hz		230 - 208 V / 1 phase / 60 Hz	
Rating conditions	A	0.7 - 0.7	0.9 - 0.9	10.4 - 10.9	12 - 12.5
	kW	0.16 - 0.14	0.18 - 0.17	2.31 - 2.24	2.65 - 2.55
Full load conditions	A	0.7 - 0.7	0.9 - 0.9	11.2 - 12.2	12.8 - 13.8
	kW	0.16 - 0.14	0.18 - 0.17	2.49 - 2.47	2.83 - 2.8
Starting amperes	A	2 - 2	1 - 1	66 - 60	67.7 - 61.7

### Cooling:

Rating Conditions : Indoor Air Temperature 80 °F DB / 67 °F WB  
 Outdoor Air Temperature 95 °F DB  
 Full Load Conditions : Indoor Air Temperature 80 °F DB / 67 °F WB  
 Outdoor Air Temperature 115 °F DB

### Heating:

Rating Conditions : Indoor Air Temperature 70 °F DB / 60 °F WB  
 Outdoor Air Temperature 47 °F DB / 43 °F WB  
 Full Load Conditions : Indoor Air Temperature 80 °F DB / — °F WB  
 Outdoor Air Temperature 45 °F DB / 35 °F WB

## Indoor model: UH3642 / Outdoor model: CH3642

### ● Cooling

		Indoor Unit	Outdoor Unit		Complete Unit
		Fan Motor	Fan Motor	Compressor	
Performance at		230 - 208 V / 1 phase / 60 Hz		230 - 208 V / 1 phase / 60 Hz	
Rating conditions	A	1 - 1	1.8 - 1.8	12.3 - 13.7	15.1 - 15.7
	kW	0.22 - 0.2	0.36 - 0.34	2.77 - 2.63	3.35 - 3.17
Full load conditions	A	1 - 1	1.8 - 1.8	15.4 - 16.8	18.2 - 19.6
	kW	0.22 - 0.2	0.36 - 0.34	3.45 - 3.38	4.03 - 3.92
Starting amperes	A	2 - 2	2 - 2	95 - 86	98 - 89

### ● Heating

		Indoor Unit	Outdoor Unit		Complete Unit
		Fan Motor	Fan Motor	Compressor	
Performance at		230 - 208 V / 1 phase / 60 Hz		230 - 208 V / 1 phase / 60 Hz	
Rating conditions	A	0.9 - 0.8	1.8 - 1.8	15.5 - 17	18.2 - 19.6
	kW	0.21 - 0.18	0.36 - 0.34	3.21 - 3.24	3.78 - 3.76
Full load conditions	A	0.9 - 0.8	1.8 - 1.8	14.7 - 16	17.4 - 18.6
	kW	0.21 - 0.18	0.36 - 0.34	3.32 - 3.29	3.89 - 3.81
Starting amperes	A	2 - 2	2 - 2	95 - 86	97.9 - 88.8

#### Cooling:

Rating Conditions : Indoor Air Temperature 80 °F DB / 67 °F WB  
 Outdoor Air Temperature 95 °F DB  
 Full Load Conditions : Indoor Air Temperature 80 °F DB / 67 °F WB  
 Outdoor Air Temperature 115 °F DB

#### Heating:

Rating Conditions : Indoor Air Temperature 70 °F DB / 60 °F WB  
 Outdoor Air Temperature 47 °F DB / 43 °F WB  
 Full Load Conditions : Indoor Air Temperature 80 °F DB / — °F WB  
 Outdoor Air Temperature 45 °F DB / 35 °F WB

## Indoor model: KH2442 / Outdoor model: CH2442

### ● Cooling

		Indoor Unit	Outdoor Unit		Complete Unit
		Fan Motor	Fan Motor	Compressor	
Performance at		230 - 208 V / 1 phase / 60 Hz		230 - 208 V / 1 phase / 60 Hz	
Rating conditions	A	0.4 - 0.4	0.9 - 0.9	9.0 - 9.6	10.3 - 10.9
	kW	0.08 - 0.07	0.18 - 0.17	2.04 - 1.98	2.30 - 2.22
Full load conditions	A	0.4 - 0.4	0.9 - 0.9	11.0 - 11.7	12.3 - 13.0
	kW	0.08 - 0.07	0.18 - 0.17	2.46 - 2.44	2.72 - 2.68
Starting amperes	A	1 - 1	1 - 1	66 - 60	68 - 62

### ● Heating

		Indoor Unit	Outdoor Unit		Complete Unit
		Fan Motor	Fan Motor	Compressor	
Performance at		230 - 208 V / 1 phase / 60 Hz		230 - 208 V / 1 phase / 60 Hz	
Rating conditions	A	0.4 - 0.4	0.9 - 0.9	10.0 - 10.9	11.3 - 12.2
	kW	0.08 - 0.07	0.18 - 0.17	2.24 - 2.19	2.50 - 2.43
Full load conditions	A	0.4 - 0.4	0.9 - 0.9	11.1 - 11.7	12.4 - 13.0
	kW	0.08 - 0.07	0.18 - 0.17	2.52 - 2.44	2.78 - 2.68
Starting amperes	A	1 - 1	1 - 1	66 - 60	68 - 62

### Cooling:

Rating Conditions : Indoor Air Temperature 80 °F DB / 67 °F WB  
 Outdoor Air Temperature 95 °F DB  
 Full Load Conditions : Indoor Air Temperature 80 °F DB / 67 °F WB  
 Outdoor Air Temperature 115 °F DB

### Heating:

Rating Conditions : Indoor Air Temperature 70 °F DB / 60 °F WB  
 Outdoor Air Temperature 47 °F DB / 43 °F WB  
 Full Load Conditions : Indoor Air Temperature 80 °F DB / — °F WB  
 Outdoor Air Temperature 45 °F DB / 35 °F WB

## Indoor model: KH3642 / Outdoor model: CH3642

### ● Cooling

		Indoor Unit	Outdoor Unit		Complete Unit
		Fan Motor	Fan Motor	Compressor	
Performance at		230 - 208 V / 1 phase / 60 Hz		230 - 208 V / 1 phase / 60 Hz	
Rating conditions	A	0.5 - 0.5	1.8 - 1.8	12.6 - 13.2	14.9 - 15.5
	kW	0.10 - 0.09	0.36 - 0.34	2.83 - 2.69	3.29 - 3.12
Full load conditions	A	0.5 - 0.5	1.8 - 1.8	15.4 - 16.8	17.7 - 19.1
	kW	0.10 - 0.09	0.36 - 0.34	3.45 - 3.38	3.91 - 3.81
Starting amperes	A	1 - 1	2 - 2	95 - 86	97.5 - 88.5

### ● Heating

		Indoor Unit	Outdoor Unit		Complete Unit
		Fan Motor	Fan Motor	Compressor	
Performance at		230 - 208 V / 1 phase / 60 Hz		230 - 208 V / 1 phase / 60 Hz	
Rating conditions	A	0.5 - 0.5	1.8 - 1.8	15.5 - 16.8	17.8 - 19.1
	kW	0.10 - 0.09	0.36 - 0.34	3.40 - 3.38	3.86 - 3.81
Full load conditions	A	0.5 - 0.5	1.8 - 1.8	14.7 - 16.0	17 - 18.3
	kW	0.10 - 0.09	0.36 - 0.34	3.32 - 3.29	3.78 - 3.72
Starting amperes	A	1 - 1	2 - 2	95 - 86	97.5 - 88.5

#### Cooling:

Rating Conditions : Indoor Air Temperature 80 °F DB / 67 °F WB  
 Outdoor Air Temperature 95 °F DB  
 Full Load Conditions : Indoor Air Temperature 80 °F DB / 67 °F WB  
 Outdoor Air Temperature 115 °F DB

#### Heating:

Rating Conditions : Indoor Air Temperature 70 °F DB / 60 °F WB  
 Outdoor Air Temperature 47 °F DB / 43 °F WB  
 Full Load Conditions : Indoor Air Temperature 80 °F DB / — °F WB  
 Outdoor Air Temperature 45 °F DB / 35 °F WB



## 2. PROCESSES AND FUNCTIONS

2-1	Room Temperature Control .....	II - 2
	(A) Cooling .....	II - 2
	(B) Heating .....	II - 3
2-2	Cold Draft Prevention (Heating Cycle).....	II - 4
2-3	Automatic Fan Speed (Indoor Unit) .....	II - 5
	(A) Cooling .....	II - 5
	(B) Heating .....	II - 5
2-4	Outdoor Fan Speed Control .....	II - 6
	(A) Cooling .....	II - 6
	(B) Heating .....	II - 6
2-5	Freeze Prevention (Cooling) .....	II - 7
2-6	Condensing Temperature Control (Cooling) .....	II - 8
2-7	Overload Protection (Heating) .....	II - 9
2-8	Discharge Temperature Control (Cooling and Heating) .....	II -10
2-9	Auto. Mode for Automatic Heating/Cooling Switching .....	II -11
2-10	Defrosting Control, Outdoor Heat Exchanger Coil (Heating) .....	II -13
2-11	4-Way Valve, Solenoid Control .....	II -14
	(A) Normal Control Mode .....	II -14
	(B) AUTO Control Mode .....	II -15
2-12	Automatic Restart after Power Interruption .....	II -15
2-13	Electronic Refrigerant Control Valve .....	II -16
2-14	Compressor Discharge Gas Temperature .....	II -16
	(A) Cooling .....	II -16
	(B) Heating (Except During Defrosting) .....	II -16
2-15	Compressor Current Detection Circuit .....	II -17
2-16	Electronic Refrigerant Control Valve Control .....	II -18
2-17	Voltage Detection Control .....	II -19

## 2-1 Room Temperature Control

The Unit adjusts room temperature by turning the outdoor unit's compressor ON and OFF. This process is controlled by the **thermostat** located in the remote control unit. The figures on this and the next pages show how each part of the system performs when the room temperature changes and the thermostat activates the compressor to start (**thermo ON**) or stop (**thermo OFF**). Fig. 1 shows about the cooling cycle, and Fig. 2 shows about the heating cycle.

### (A) Cooling

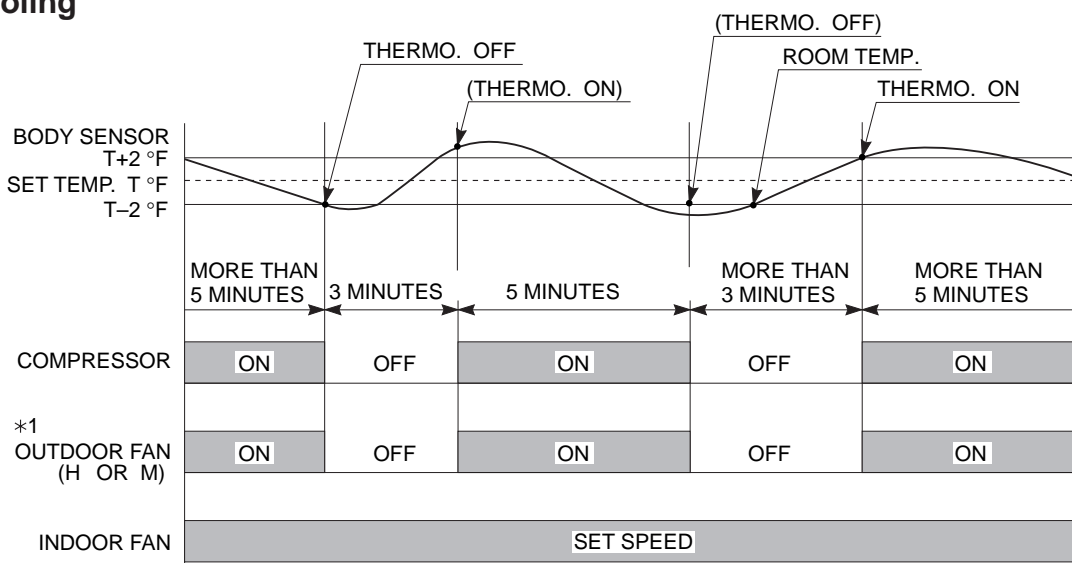

\*1. Refer to 2-4 Outdoor Fan Speed Control

1133\_THS\_1

Fig. 1

### Chart Summary and Explanations

- ❑ Once the compressor **starts**, it keeps running for 5 minutes.
- ❑ Once the compressor **stops**, it will not start running again for 3 minutes.
- ❑ If you **change** the operation mode (**HEAT, COOL, or FAN**) during the cooling cycle, the control circuit **stops** the compressor for 3 minutes.
- ❑ For 5 minutes after the compressor is first turned on, and for 3 minutes after it is turned off, the compressor is not controlled by the room sensor.
- ❑ **Thermo ON:** When room temperature rises  $2^\circ\text{F}$  ( $4^\circ\text{F}$  when set on body sensor) above the set temperature  $T$ , ( $T+2^\circ\text{F}$  or  $T+4^\circ\text{F}$  when set on body sensor):  
Compressor → **ON**
- ❑ **Thermo OFF:** When the room temperature is  $-2^\circ\text{F}$  below the set temperature  $T$ :  
Compressor → **OFF**

(B) Heating

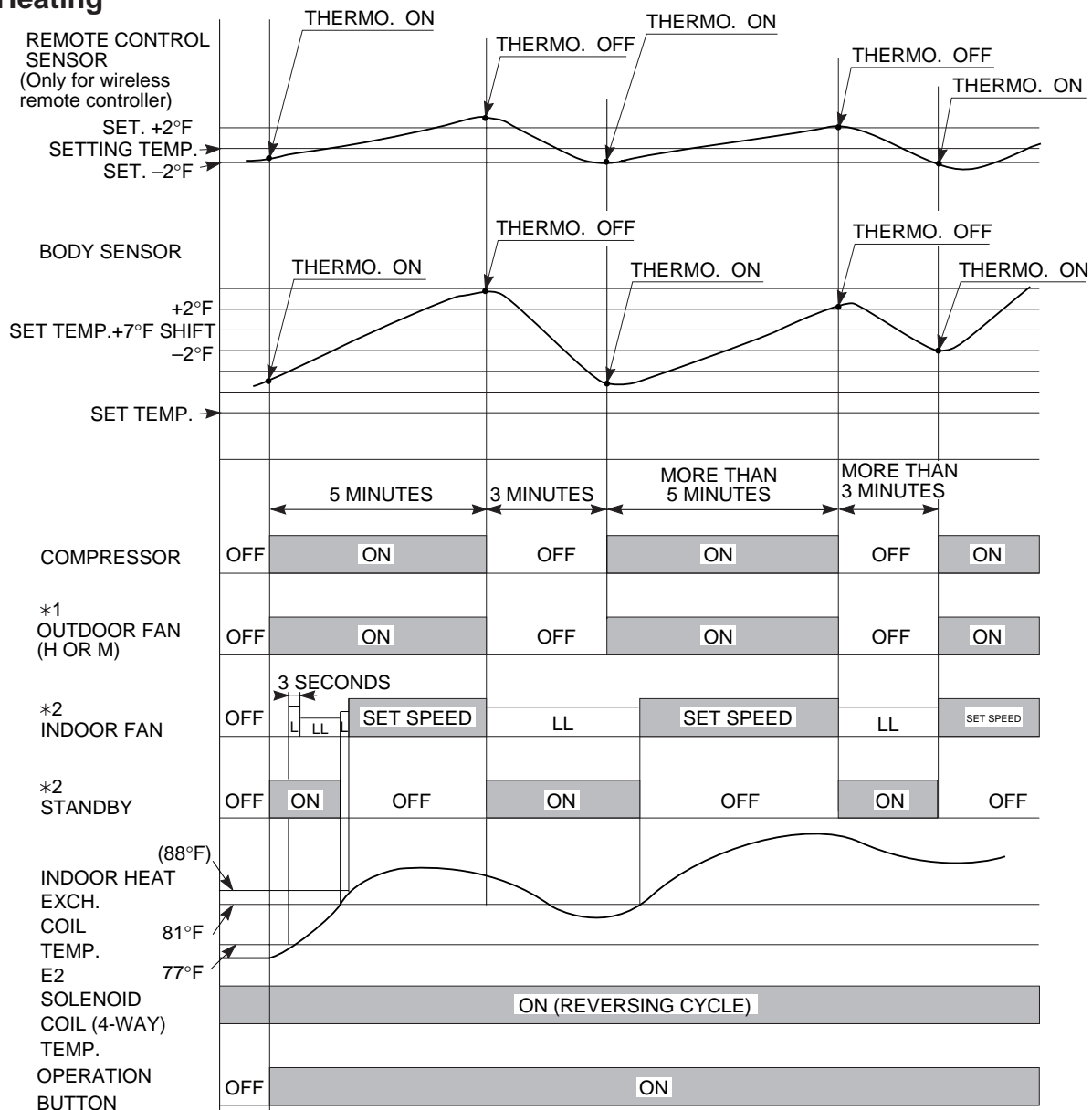

\*1. Refer to 2-4 Outdoor Fan Speed Control  
 \*2. Refer to 2-2 Cold Draft Prevention (Heating)

1134\_THS\_J

Fig. 2

Chart Summary and Explanations

- Once the compressor starts, it keeps running for 5 minutes.
  - Once the compressor stops, it will not start running again for 3 minutes.
  - If you change the operation mode (HEAT, COOL or FAN) during the heating cycle, the control circuit **stops** the compressor for **3 minutes**.
  - For 5 minutes after the compressor is first turned on, and for 3 minutes after it is turned off, the compressor is not controlled by the room sensor.
- When set on remote control sensor
- Thermo ON:** When room temperature is -2°F below the set temperature T°. Compressor → ON
  - Thermo OFF:** When the room temperature is 2°F above the set temperature T°, (T°+2°F) Compressor → OFF
- When set on body sensor
- NOTE:** In case of Body sensor, operating temperature is shifted to setting temperature +7°F.



## 2-2 Cold Draft Prevention (Heating Cycle)

The cold draft prevention function controls indoor fan speed so a strong draft of cold air will not blow out before the indoor heat exchange coils have warmed up.

- ❑ STANDBY shows on the remote controller when the indoor fan speed is LL (very low) or OFF. This condition occurs in the following 3 cases:
  - During Thermo OFF (refer to 2-1 B). Room Temperature Control, Heating)
  - During the defrosting operation (refer to 2-10 Defrosting Control, Heating)
  - Until either the coil temperature E2 reaches 81°F or when a maximum of 6 minutes has past.
- ❑ The indoor fan motor operates in L instead of LL for 3 seconds as it starts to give the fan an initial boost.

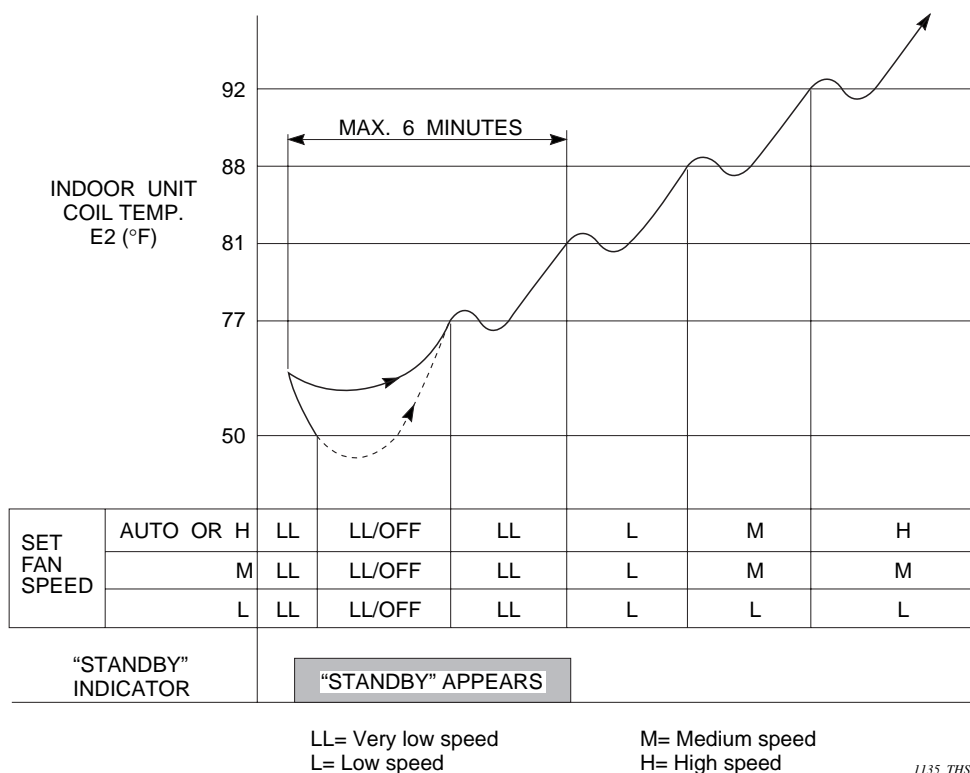

Fig. 3

### Chart Summary and Explanations

- ❑ The main idea of this chart is to show that the indoor fan speed increases and gets closer to the set fan speed as the coil temperature **E2** rises.
- ❑ The indoor unit’s coil temperature is taken from sensor **E2** located in the middle of the indoor heat exchange coil.
- ❑ The dotted line shows that the indoor fan motor is **OFF**. When the temperature at sensor **E2** falls below 50°F, the indoor fan motor stops running.

### 2-3 Automatic Fan Speed (Indoor Unit)

By pressing the FAN SPEED button on the remote controller, the fan speed can be set at one of four steps: AUTO., HI., MED., or LO. When set at AUTO. the indoor unit fan speed will be automatically adjusted to the room temperature as the two charts shown below.

#### (A) Cooling

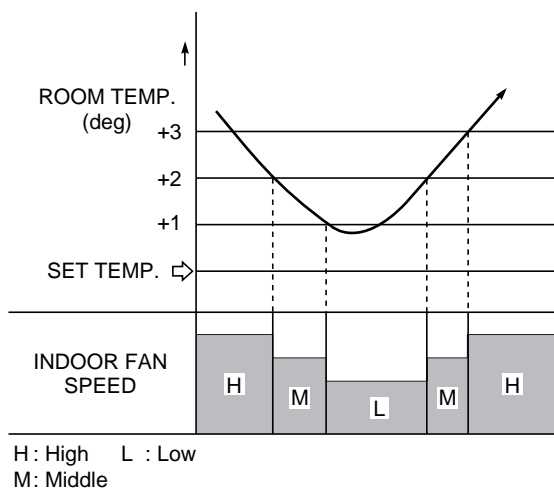

Fig. 4

#### Chart Explanations and notes

- When the fan speed changes, it keeps the speed step for at least 3 minutes, even if the temperature changes to another speed step during the time.

#### (B) Heating

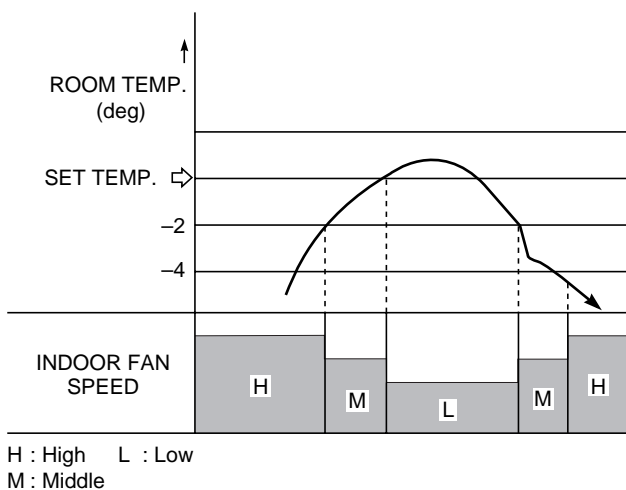

Fig. 5

#### Chart Explanations and notes

- When the fan speed changes, it keeps the speed step for at least 1 minute, even if the temperature changes to another speed step during the time.

## 2-4 Outdoor Fan Speed Control

To optimize the performance of air conditioner, the outdoor fan speed is selected automatically according to the outdoor temperature.

- ❑ Note that in both **Cooling** and **Heating** modes, the fan comes on at first at high speed (H mode) for 5 seconds. Since outdoor conditions sometimes make it difficult for the fan to start, this sudden surge of power may be necessary.
- ❑ The outdoor fan operates in H mode for 3 minutes after the compressor stops (excluding defrosting operation period).
- ❑ Charts below show how the outdoor fan speed changes with the change in outdoor temperature.

### (A) Cooling

Outdoor unit coil temperature [C2]	Outdoor fan motor (FMo)
or more 77°F	H
32°F or more, less than 77°F	M
less than 32°F	L

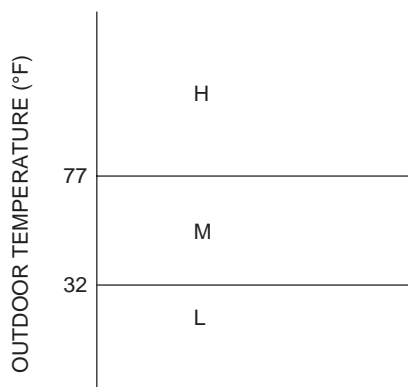

Fig. 6

### (B) Heating

Outdoor coil temperature [C2]	Outdoor fan motor (FMo)
or more 57°F	M
less than 57°F	H

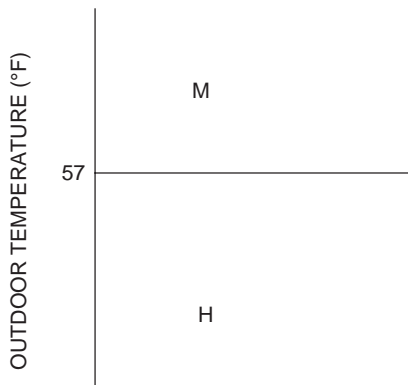

Fig. 7

## 2-5 Freeze Prevention (Cooling)

Freeze Prevention keeps the indoor heat exchange coil from freezing. Freezing reduces the efficiency of the unit, and frost build up on the coil blocks cool air circulation from the indoor unit's fan.

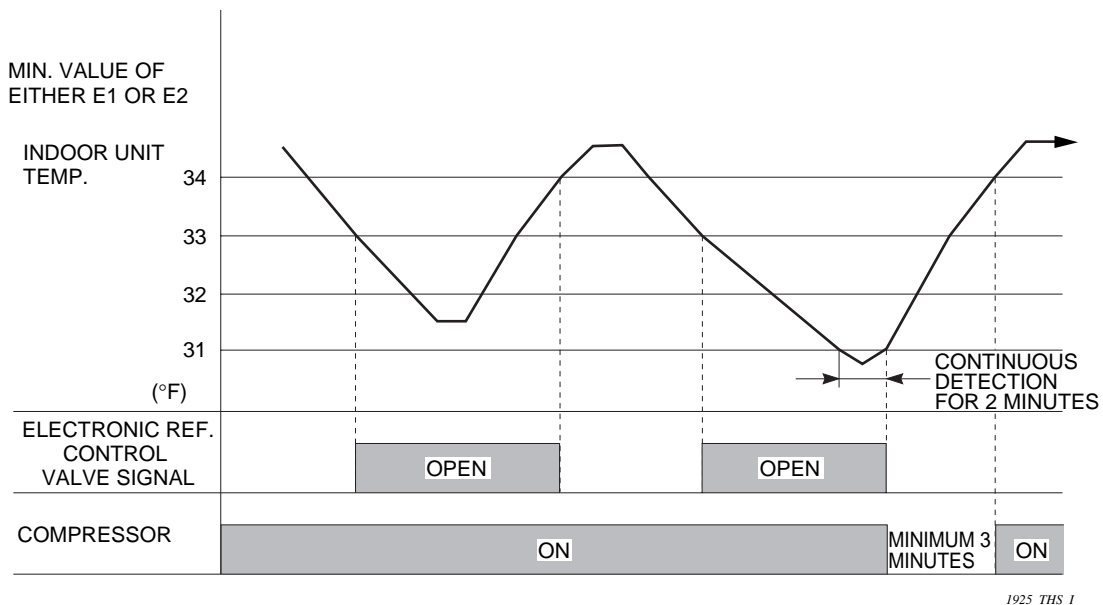

Fig. 8

**Note:** Freeze prevention is controlled by the temperature at the indoor heat exchanger coil as sensed by either sensor **E1** (located at the entrance of the coil) or sensor **E2** (located on the middle of the coil). Freeze prevention cycle is controlled by the lower temperature sensed at either of the two sensors.

### Chart Explanations and notes

- ❑ This chart shows when the **electronic refrigerant control valve** opens to regulate the temperature of the indoor unit coil to prevent freezing.
- ❑ If the refrigerant control is not effective and the temperature continues to drop and stays below 31°F for 2 minutes continuously, the control circuit stops the compressor. The compressor does not start again until the temperature rises above 34°F. The compressor stops for 3 minutes minimum.

## 2-6 Condensing Temperature Control (Cooling)

Condensing temperature is controlled by the outdoor heat exchanger coil temperature as sensed by sensor **C2**.

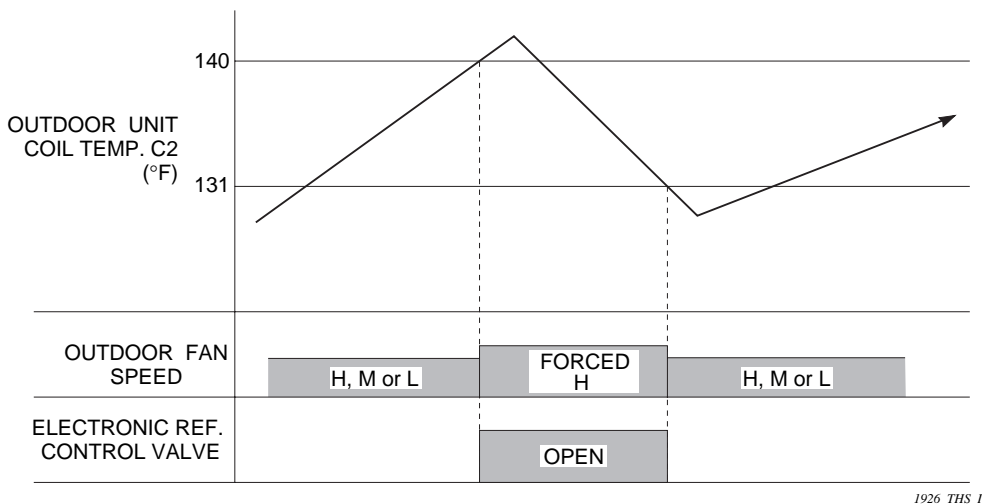

Fig. 9

### Chart Explanations and notes

- ❑ This chart shows how the outdoor fan speed and the electronic refrigerant control valve react to coil temperature to control condensing temperature.
- ❑ Sensor **C2** is located in the middle of the outdoor unit heat exchange coil.
- ❑ When **C2** rises above 140°F the electronic refrigerant control valve opens at 50 steps/30 seconds, and the outdoor fan speed is forced to change to high (H) until **C2** falls below 131°F.



## 2-7 Overload Protection (Heating)

This function prevents the air conditioner from overloading.

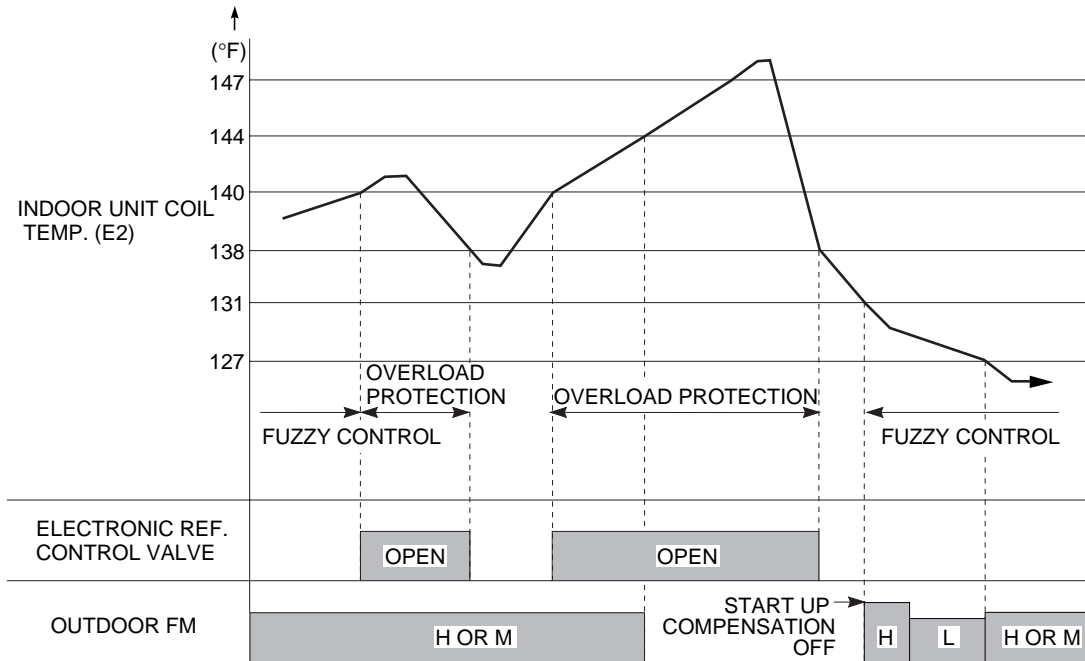

1927\_THS\_1

Fig. 10

### Chart Explanations and notes

- This chart shows how the outdoor fan speed and the electronic refrigerant control valve react to coil temperature to keep the indoor heat exchanger coil from overloading.
- When sensor **E2** rises above 140°F the electronic refrigerant control valve opens at 50 steps/30 seconds until **E2** falls below 138°F.
- Sensor **E2** is located in the middle of the indoor unit heat exchange unit.
- When sensor **E2** rises above 144°F, the control circuit stops the outdoor fan motor till the temp. drops to 131°F
- Fuzzy control controls the electronic refrigerant control valve.

## 2-8 Discharge Temperature Control (Cooling and Heating)

This function prevents the compressor motor from burnout by overheating.

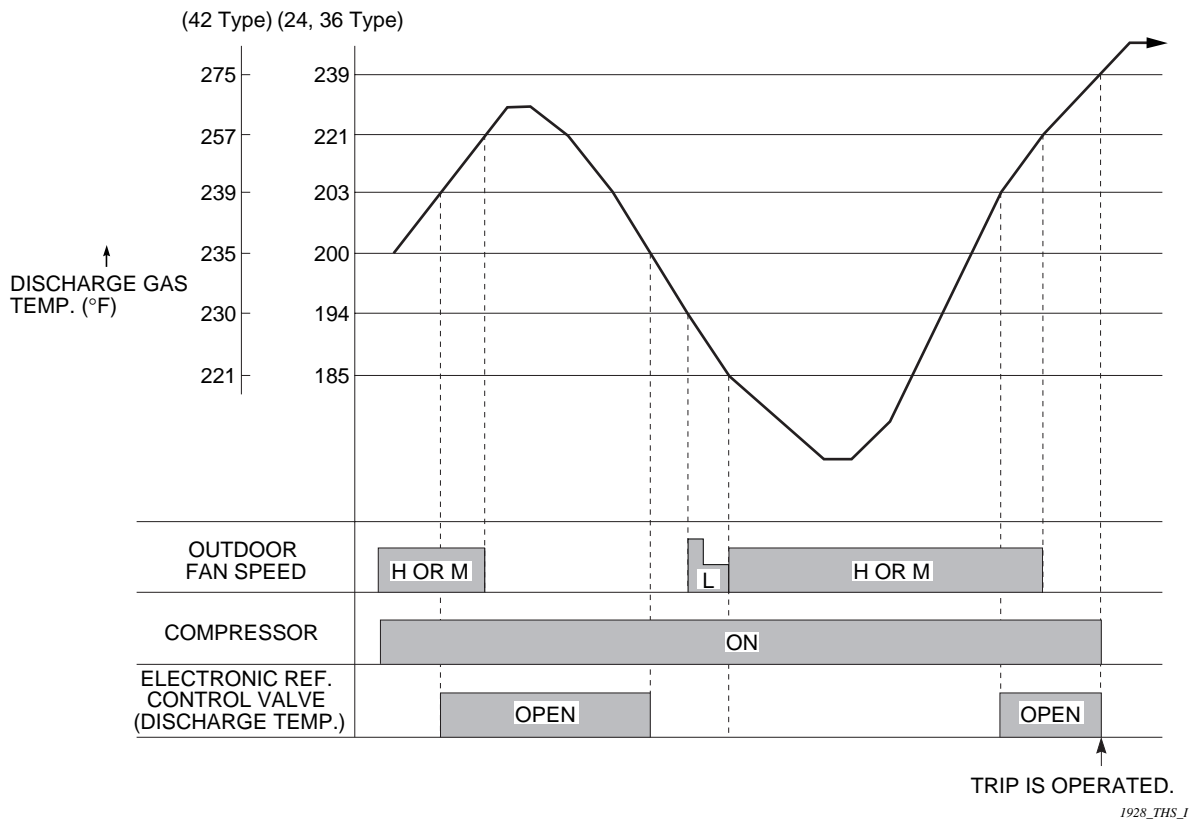

Fig. 11

### Chart Summary and Explanations

- Discharge temperature is sensed by **TH8** (discharge gas sensor).
- When the temperature rises **above 203°F** (24, 36 Type) the electronic refrigerant control valve opens at 50 steps/30 seconds until the temperature falls **below 200°F** (24, 36 Type) .
- During **HEATING** operation, when the temperature rises **above 221°F** (24, 36 Type), the control circuit stops the outdoor fan motor until the temperature falls below 194°F (24, 36 Type). Please note that this control does not function during **COOLING** operation.
- For both **COOLING** and **HEATING** modes, if the temperature reaches **239°F** (24, 36 Type) the operation shuts down and alarm **P3** appears on the remote controller.
- The outdoor fan speed is controlled on discharge temp. at heating mode.

### 2-9 Auto. Mode for Automatic Heating/Cooling Switching

- When the AUTO mode is selected, the microprocessor calculates the difference between the set temperature and the room temperature, and automatically switches to the COOLING or HEATING mode to maintain the desired temperature.

Room temp.  $\geq$  Set temp.  $\rightarrow$  COOLING

Room temp.  $<$  Set temp.  $\rightarrow$  HEATING

This means that if the room temperature is **higher or equal to** the set temperature, **COOLING** operation starts. If the room temperature is **lower** than the set temperature, **HEATING** operation starts.

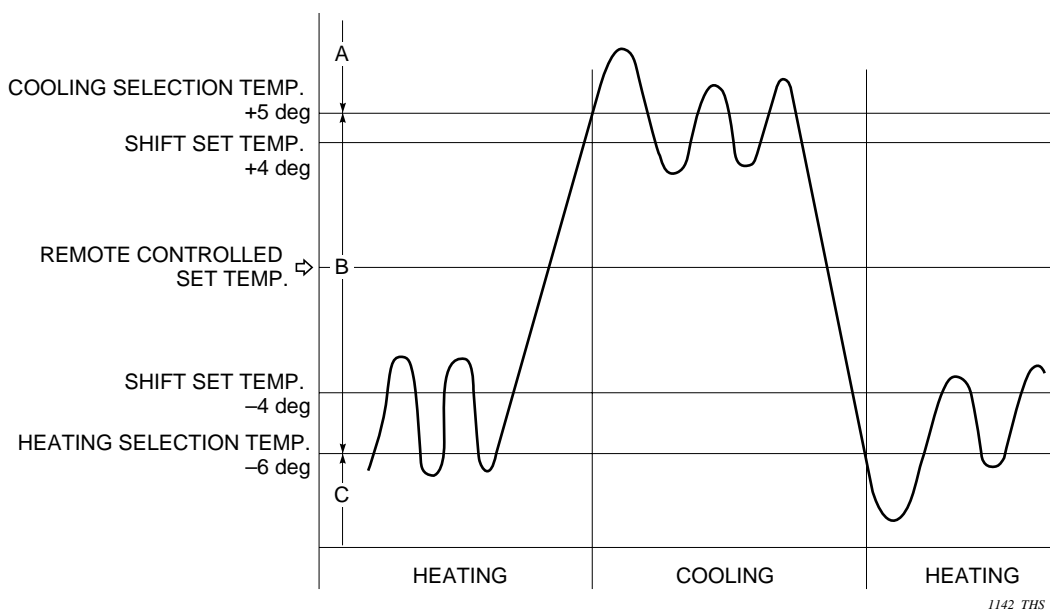

Fig. 12



### Chart summary and Explanations

- ❑ This chart shows how the Operation Mode (**COOLING** or **HEATING**) is determined by the microprocessor taking the room temperature into consideration. It also shows the temperature points at which the cooling or heating mode is switched, when the AUTO mode is selected.
- ❑ After operation starts, the set temperature shifts automatically by +4 deg. at cooling and by -4 deg. at heating. For example, if cooling is selected, the set temperature changes from 68°F to 72°F.  
(The display of the remote controller remains 68°F.)
- ❑ The change of the operation mode (heating to cooling, cooling to heating) by the change of the room temperature during the operation is as follows.  
  
Heating to Cooling; Room temp.  $\geq$  Shifted temp +1.0 deg.  
Cooling to Heating; Room temp.  $\leq$  Shifted temp -2.0deg.  
  
For example, if the room temperature rises above 73°F (=72+1) during the cooling operation at the room temperature 68°F set by the remote controller, the operation changes to cooling. When the room temperature lowers below 63°F (=65-2) thereafter, the operation changes to heating again.
- ❑ In heating operation, using the body sensor, room temperature control is designed so that room air temp. is sensed as 8 deg. lower than suctioned air at indoor unit taking into account of the temperature gap between upper part and lower part of the room.
- ❑ Within 10 minutes after the compressor turns OFF, the operation does not change to cooling (heating), even when the room temperature changes from C to A (A to C).
- ❑ When switching from cooling (heating) to heating (cooling), the actuation of the 4 way valve will delay about 30-50 seconds after the compressor turns ON.

### 2-10 Defrosting Control, Outdoor Heat Exchanger Coil (Heating)

When the outdoor temperature is low, frost may form on the outdoor heat exchanger coil. When this occurred, the defrosting system operates. The microprocessor in the outdoor unit monitors the relationship between the temperature of the outdoor heat exchanger coil and the outdoor temperature so it can defrost when necessary.

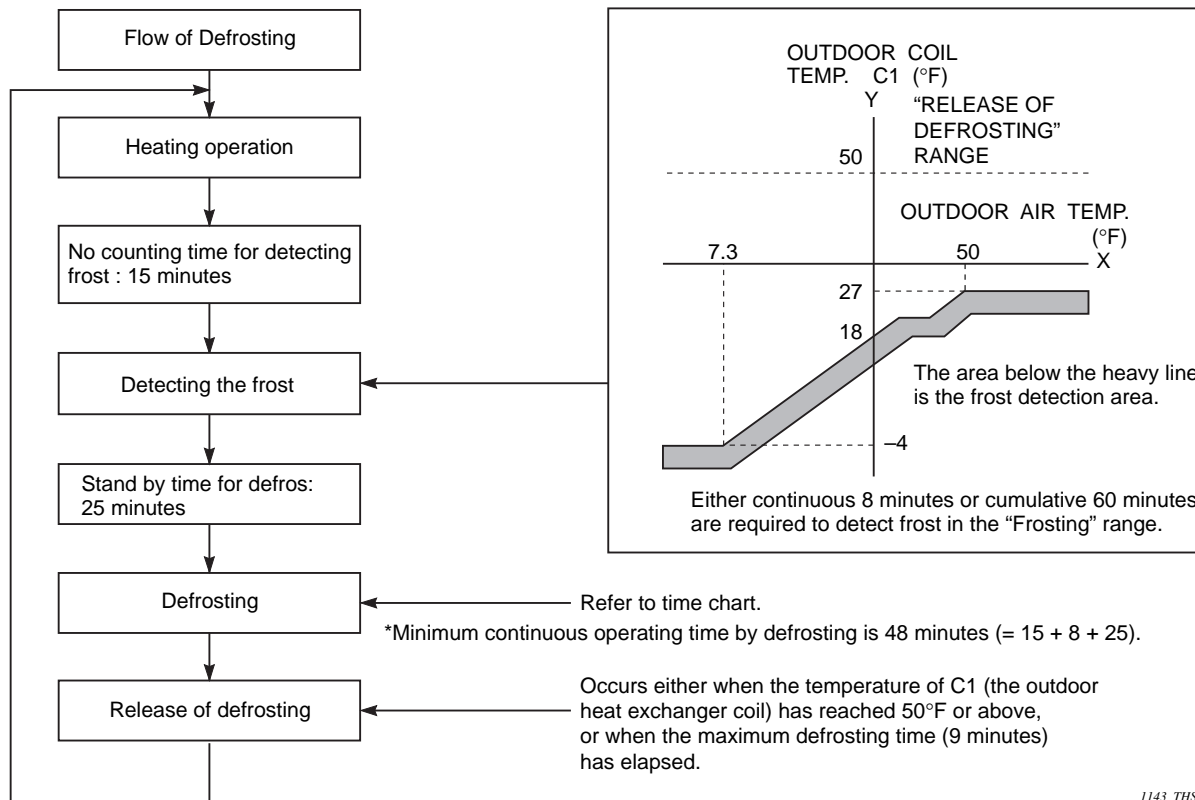

1143\_THS\_I

Fig. 13

#### Time Chart for Defrosting

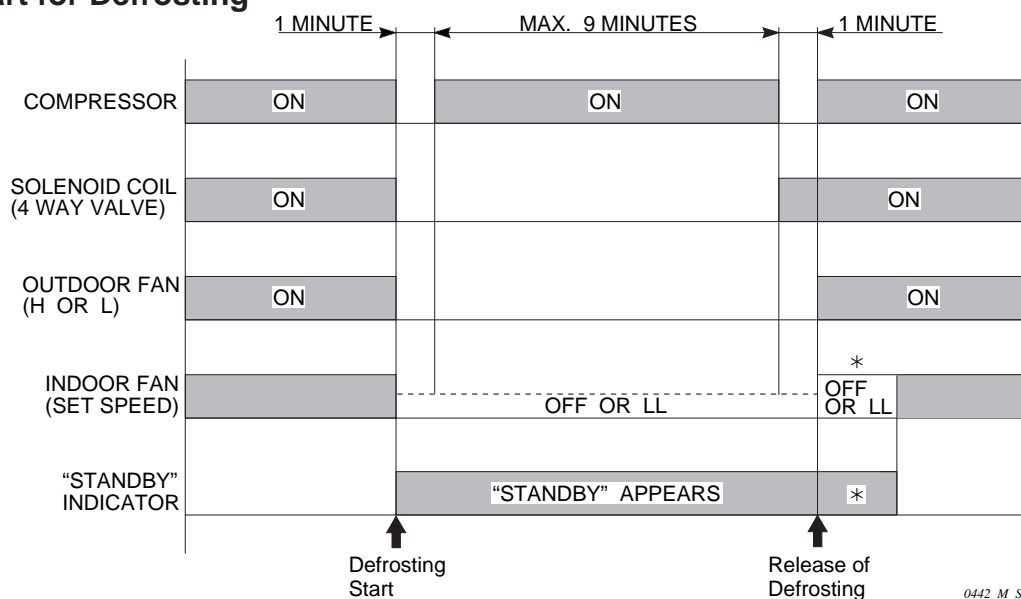

0442\_M\_S

Fig. 14

- During the defrost cycle, **STANDBY** appears on the remote controller.
- \*.....Cold Draft Prevention may operate occasionally



## 2-11 4-Way Valve, Solenoid Control

The basic function of the 4-way valve is to direct the refrigerant in the correct direction according to the Operation Mode (**COOLING** or **HEATING**) selected.

The following two charts show conditions of the controls and functions listed in the left hand column when the solenoid is **ON** or **OFF**. Chart (A) on this page shows the relationships when the temperature control is in **NORMAL** mode, and Chart (B) on the next page shows the relationships when the remote controller is set to **AUTO** mode.

### (A) Normal Control Mode

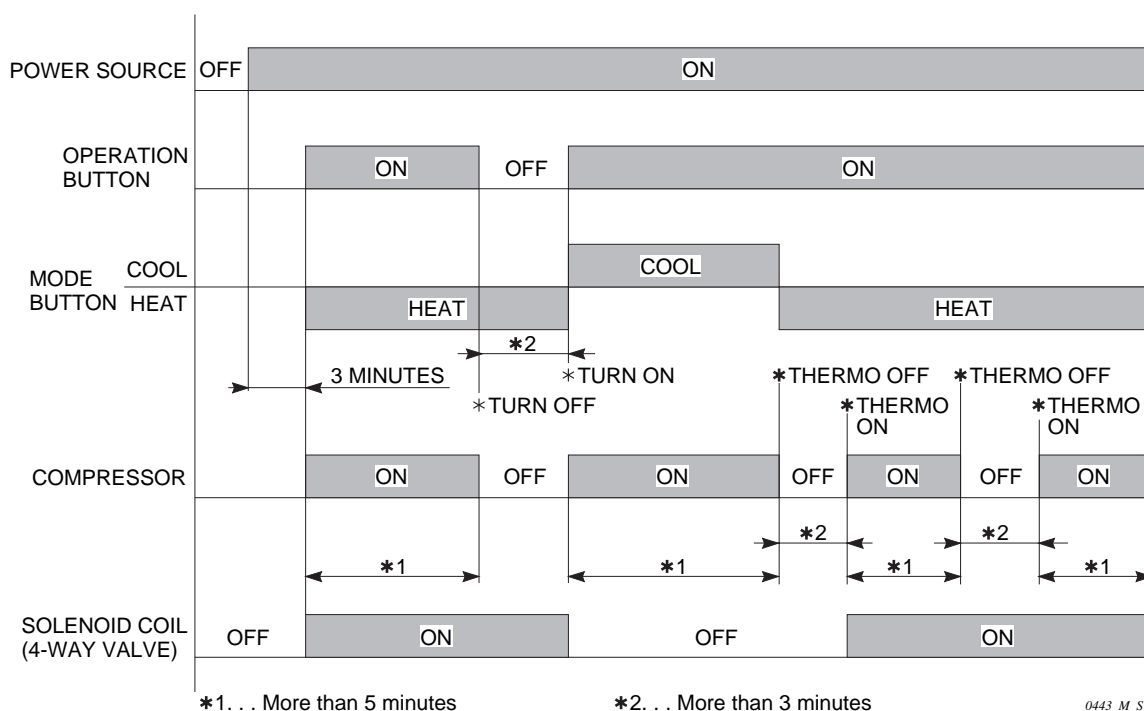

Fig. 15

### Chart Summary and Explanations

- For the first 3 minutes after power is applied, the 4-way valve remains OFF and the compressor will not operate, even if the ON button is pushed.
- If the 4-way valve is turned OFF with the compressor operating, the air conditioner operates in COOLING mode. See Table below.
- If the 4-way valve is turned ON with the compressor operating, the air conditioner operates in HEATING mode. See Table below.

Operation Mode	4-way valve solenoid	Compressor
COOLING	OFF	ON
HEATING	ON	

(B) AUTO Control Mode

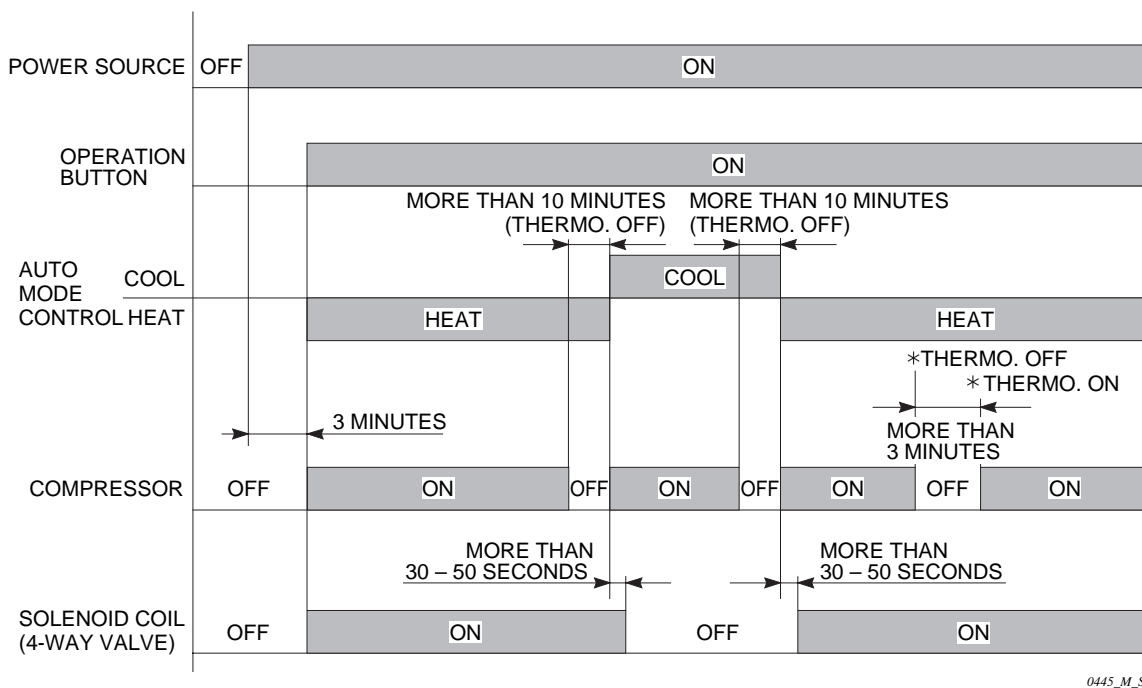
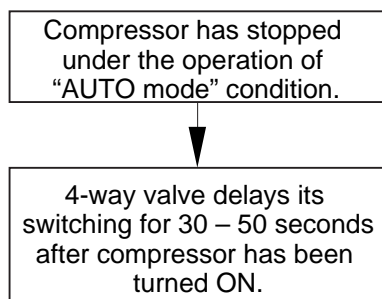

Fig. 16

When the Compressor has stopped while in **AUTO** mode, the 4-way valve switches on (heating) or off (cooling) within 1 minute according to the following conditions:



0446\_M\_S

Fig. 17

2-12 Automatic Restart after Power Interruption

This air conditioner has a power failure recovery function.



### 2-13 Electronic Refrigerant Control Valve

- This valve allows very precise and smooth control of the amount of refrigerant flow in the system. Since the valve is operated by a step motor, the control circuits can open or close it in very exact amounts, so the degree of heating or cooling can be changed by just a little, or changed very quickly or slowly.

(Completely close ..... 0 step)

(Full open..... 480 step)

Model	Min. open		Max. open
	HEAT	COOL	
24 type	100 step	100 step	480 step
36 type	90 step	90 step	
42 type	100 step	100 step	

#### □ Fuzzy Control

Fuzzy Control is a controlling system to control electronic refrigerant control valve using fuzzy logic. It regulates the functions of heating and cooling, as well as some of the processes inside the unit, by taking account of many different conditions of temperature, fan speed, etc. These control circuits work automatically to send just the right amount of refrigerant through the **Electronic Refrigerant Control Valve**.

### 2-14 Compressor Discharge Gas Temperature

#### (A) Cooling

Indoor temp. (°F)	68 – 77		79 – 82	84 – 90
Outdoor temp. (°F)	55 or below	57 – 61	81 – 95	97 – 109
Compressor discharge gas temp. (°F)	104 – 176	104 – 194	140 – 212	158 – 221

#### (B) Heating (Except During Defrosting)

Indoor temp. (°F)	64 – 70		72 – 77			79 – 86		
Outdoor temp. (°F)	32 or below	34 – 50	32 or below	34 – 50	52 – 70	32 or below	34 – 50	52 – 70
Compressor discharge gas temp. (°F)	104 – 176	122 – 194	122 – 194	122 – 212	140 – 221	122 – 194	140 – 212	158 – 221

- Operate the unit at least 30 minutes to stabilize the discharge temperature.
- The above discharge temperature was measured with a 15m tubing length. The temperature may vary with tubing length.



### 2-15 Compressor Current Detection Circuit

- ❑ The Compressor Current Detection Circuit detects the compressor current and, depending on the current range, can stop the compressor motor so it will not be damaged by overcurrent.
- ❑ Overcurrent can be caused by several factors, particularly mechanical seizing of the compressor or liquid backflow. Either of these conditions can hold the compressor to run, and thus drawing so much current that the motor can burn out.

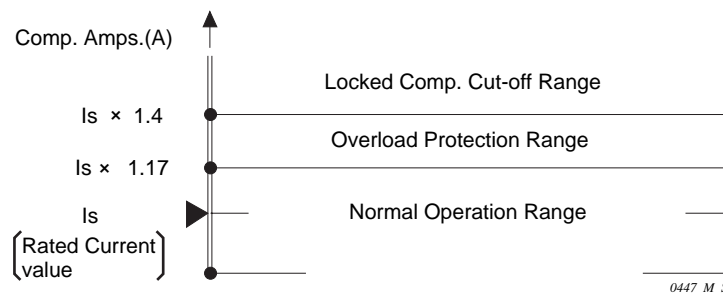

Fig. 18

Outdoor Model	Rated Current Value Is (A)	Overload Protection Is x 1.17 (A)	Locked Compressor Cut-off Is x 1.4 (A)
CH2442	17.1	20.0	23.9
CH3642	27.5	32.2	38.5
CH4242	34.7	40.6	48.6

#### Chart Summary and Explanations

- ❑ **Overload Protection**
  - When the detected current is 1.17 – 1.4 times greater than the rated current value (Is) and continues for 30 seconds, both compressor and outdoor fan stop (Thermostat **OFF**).
  - After 3-minute pause, if the air conditioner is ready for Thermostat **ON**, it starts again. However, if the condition mentioned above repeats **twice within 30 minutes**, the remote controller displays the alarm message **H01, compressor overload**.
- ❑ **Locked Compressor Cut-off**
  - When the detected current is **1.4 times greater** than the rated current value (Is) and **continues for 2 seconds**, both compressor and outdoor fan stop (Thermostat **OFF**).
  - After 3-minute pause, if the air conditioner is ready for Thermostat **ON**, it starts again. However, if the condition mentioned above repeats **twice**, the remote controller displays the alarm message **H02, compressor locked**.
- ❑ **Failure of Compressor Current Detection**
  - When the Compressor Current Detection Circuit fails to detect the compressor current **within 2 seconds after compressor starts**, both compressor and outdoor fan stop (Thermostat **OFF**).
  - After 3-minute pause, if the air conditioner is ready for Thermostat **ON**, it starts again. However, when the circuit fails to detect the current twice in a row, the remote controller displays alarm message **H03, Failure of compressor Current Detection**.



## 2-16 Electronic Refrigerant Control Valve Control

The circulation volume of the refrigerant is controlled by a pulse type electronic control valve. When the power is switched ON, the opening degree of the electronic control valve is controlled between 90 and 480 steps after setting the initial step at the time when the thermostat is ON.

### Contents and Order of control

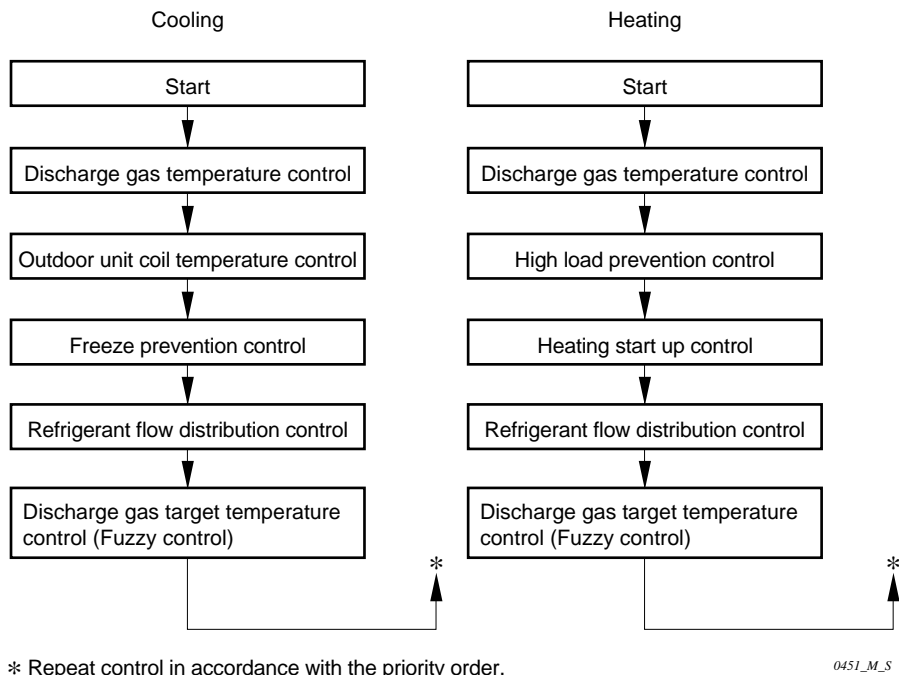

Even though the operation is performed every 30 seconds, the control of discharge gas temperature, high load prevention, outdoor unit coil temperature and freeze prevention activates when it occurs.

### (1) Refrigerant flow distribution control

At the control of flexible combination (a plural number of indoor units are set), the opening degree of the electronic control valve is controlled by the indoor unit coil temperature.

Cooling: indoor unit coil E2 temperature (located at the middle of coil)

Heating: indoor unit coil E1 temperature (located at the outlet of coil)

### (2) Fuzzy control (optimal refrigerant flow rate control)

By outputting the fuzzy estimation result corresponding to the fuzzy input variables (the indoor unit coil temp., the deviation between the actual discharge gas temp. and the target discharge gas temperature calculated from the outdoor unit coil temperature and the change thereof), the electronic refrigerant valve is controlled so that the unit can perform its maximum ability in accordance with the indoor and outdoor temperature conditions at the operation.

### **2-17 Voltage Detection Control**

When the power voltage falls below 160 V or rises above 260 V, operation lamp and stand-by lamp flash alternately to protect the compressor and electrical components.

## 3. ELECTRICAL DATA

3-1	Indoor Units (Electric Wiring Diagram, Schematic Diagram) .....	III - 2
	4-Way Air Discharge Semi-concealed Type .....	III - 2
	Ceiling Mounted Type .....	III - 4
	Concealed Duct Type .....	III - 6
	Concealed Duct High Static Pressure Type .....	III - 8
3-2	Outdoor Units (Electric Wiring Diagram, Schematic Diagram) .....	III - 12

3-1 Indoor Units

4-Way Air Discharge Semi-concealed Type : XH2442, XH3642, XH4242

• Electric Wiring Diagram

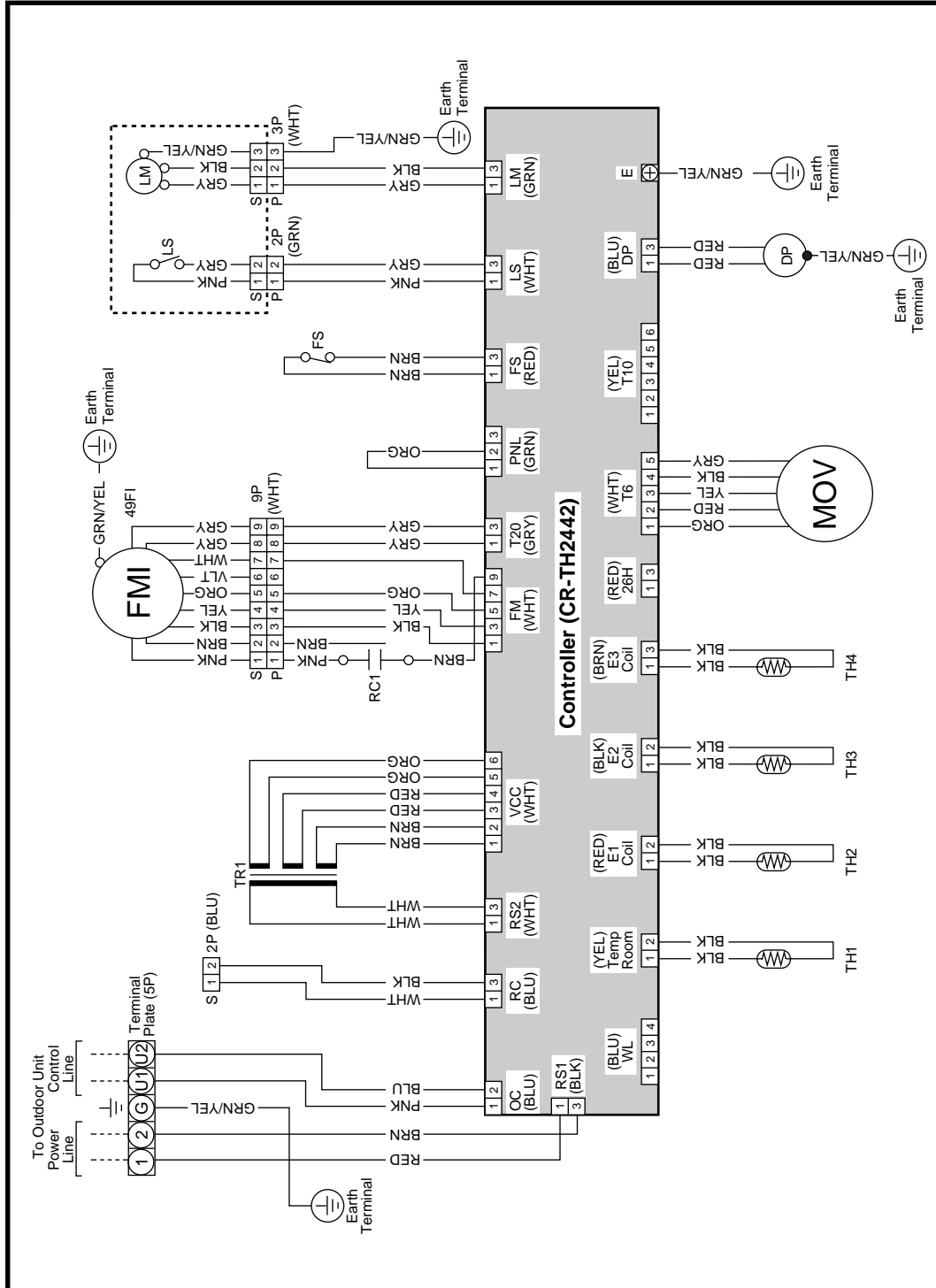

⑧ 854-2-5268-930-00-1 (X)

4-Way Air Discharge Semi-concealed Type : XH2442, XH3642, XH4242

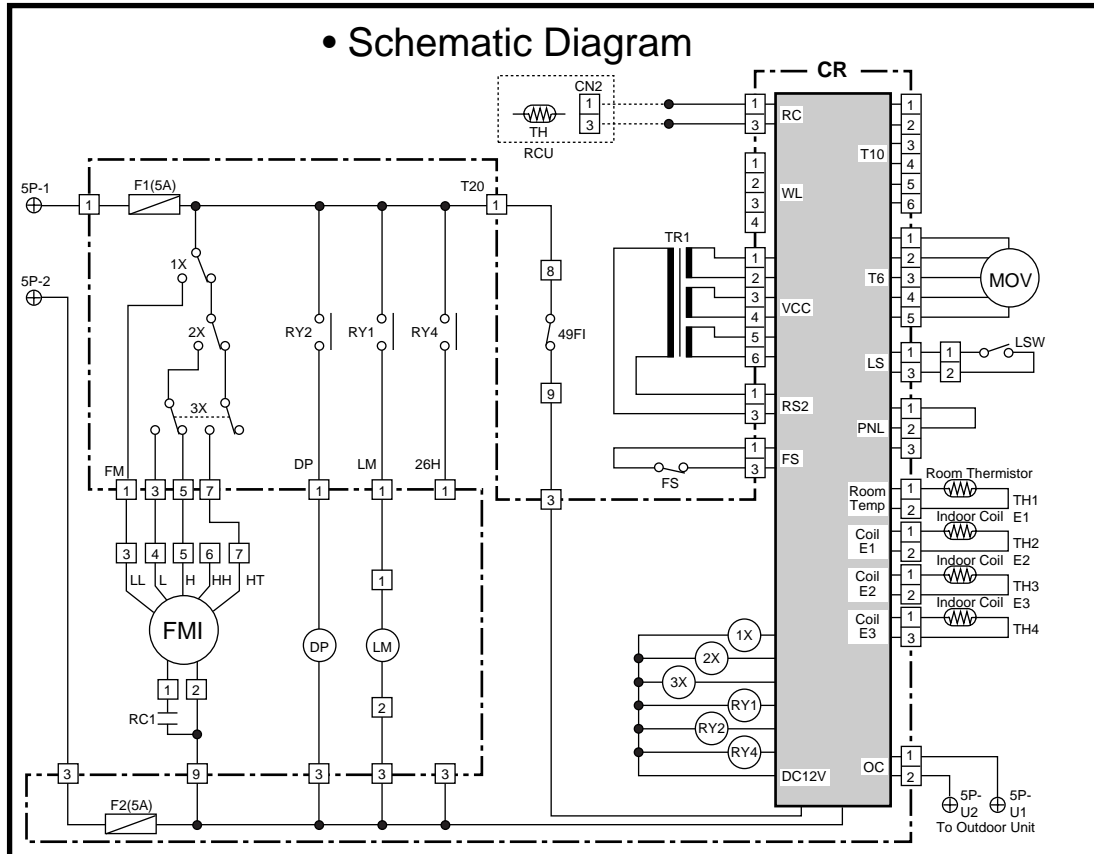

Symbols	Description	Symbols	Description
FMI	Indoor Fan Motor	1X-3X	Auxiliary Relay
MOV	Motor Operated Valve	RY1, 2, 3	
49FI	Indoor Motor Thermal Protector	CR	Indoor Controller
RC1	Running Capacitor	LSW	Limit Switch
TR1	Power Transformer	LM	Auto Louver Motor
DP	Drain Pump	(RCU)	Remote Control Unit (Optional Parts)
FS	Float Switch	(TH)	Room Thermistor
TH1	Room Thermistor	⊕	Terminal Plate
TH2	Thermistor (Indoor Coil E1)	□	Connector
TH3	Thermistor (Indoor Coil E2)	⊕	Terminal
TH4	Thermistor (Indoor Coil E3)		
F1, 2	Fuse		

© 854-2-5268-930-00-1 (X)



Ceiling Mounted Type : TH2442, TH3642, TH4242

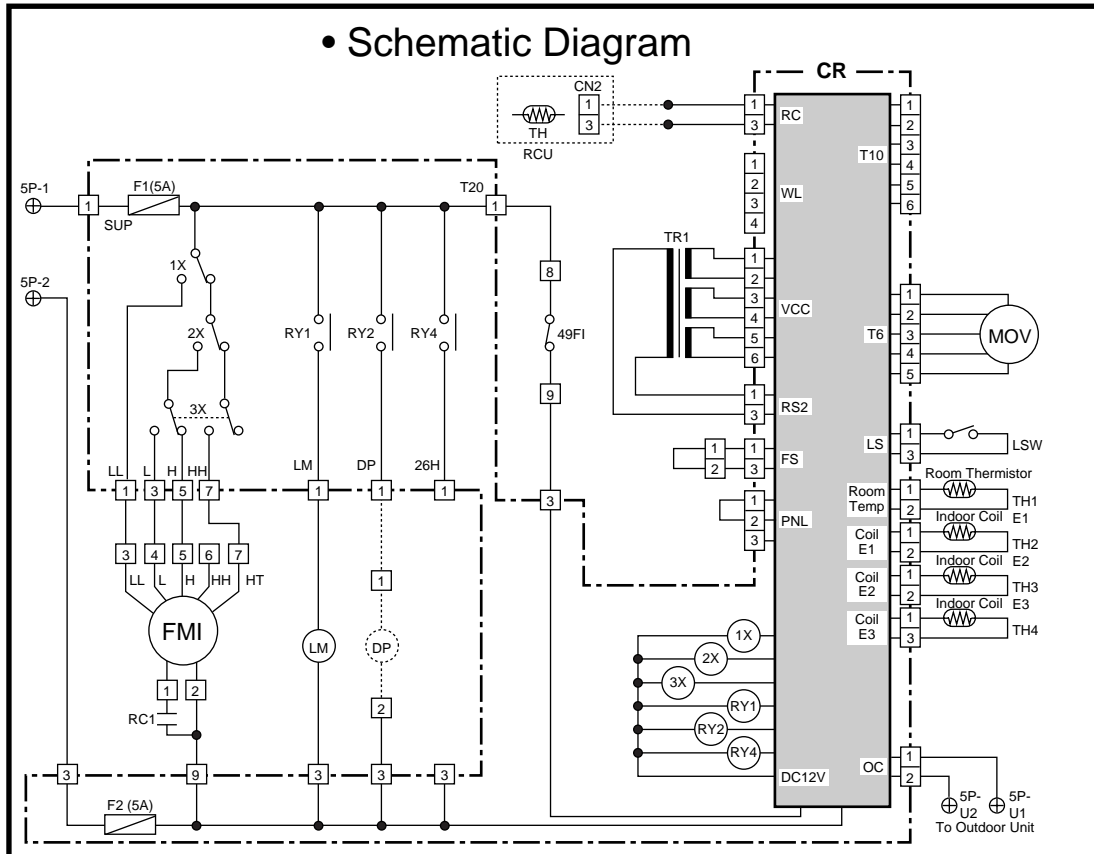

Symbols	Description	Symbols	Description
FMI	Indoor Fan Motor	TH2	Thermistor (Indoor Coil E1)
49FI	Indoor Motor Thermal Protector	TH3	Thermistor (Indoor Coil E2)
RC1	Running Capacitor	TH4	Thermistor (Indoor Coil E3)
F1, 2	Fuse	CR	Indoor Controller
LM	Auto Louver Motor	(RCU)	Remote Control Unit (Optional Parts)
TR1	Power Transformer	(TH)	Room Thermistor
1X~3X	Auxiliary Relay	⊕	Terminal Plate
RY1, 2, 4	Auxiliary Relay	□	Connector
MOV	Motor Operated Valve	⊕	Terminal
FS	Float Switch		
LSW	Limit Switch		
TH1	Room Thermistor		

© 854-2-5268-923-00-1 (T)



Concealed Duct Type : UH2442, UH3642

• Electric Wiring Diagram

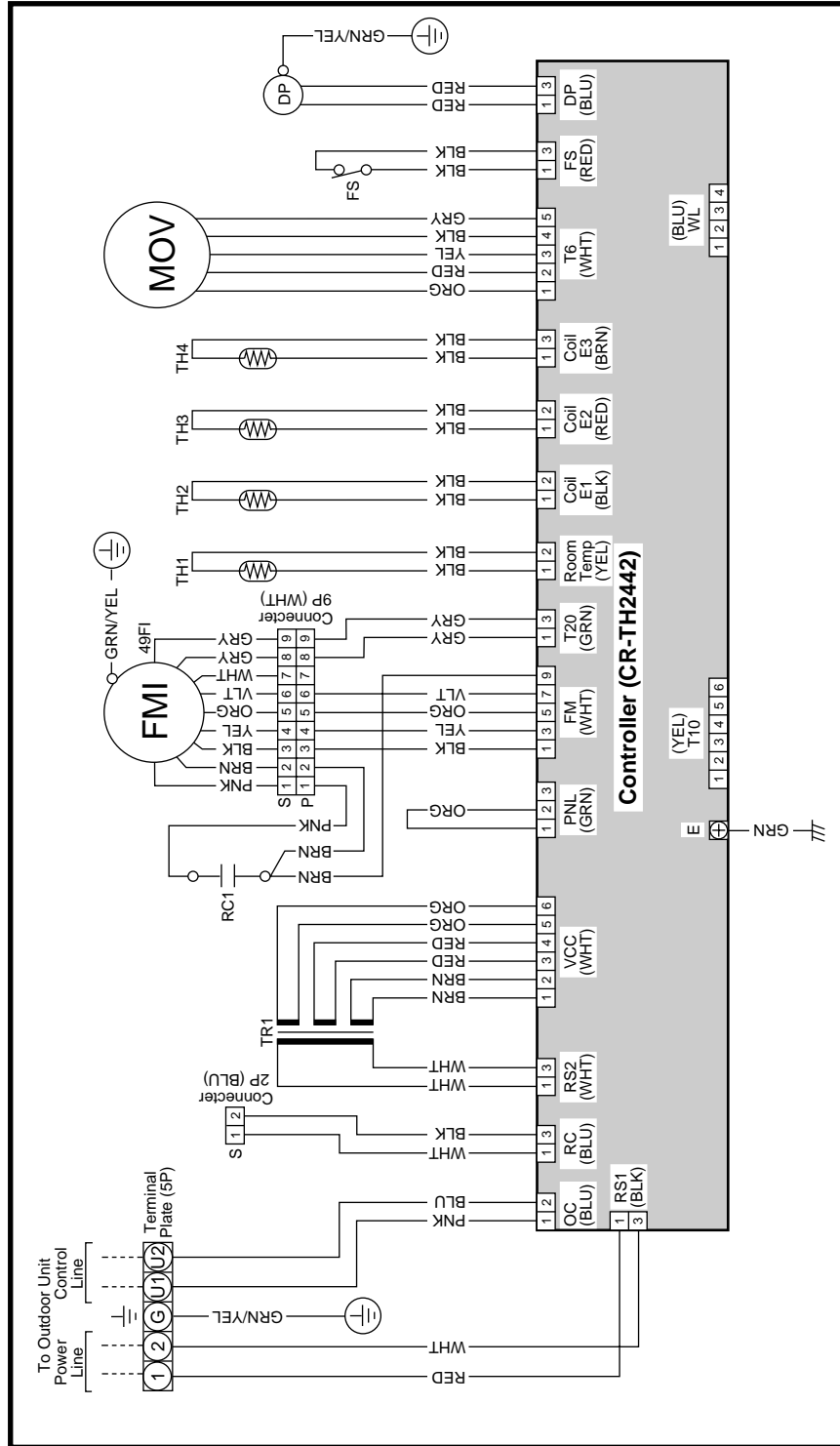

Ⓜ 854-2-5268-940-00-1 (UH1242)

Concealed Duct Type : UH2442, UH3642

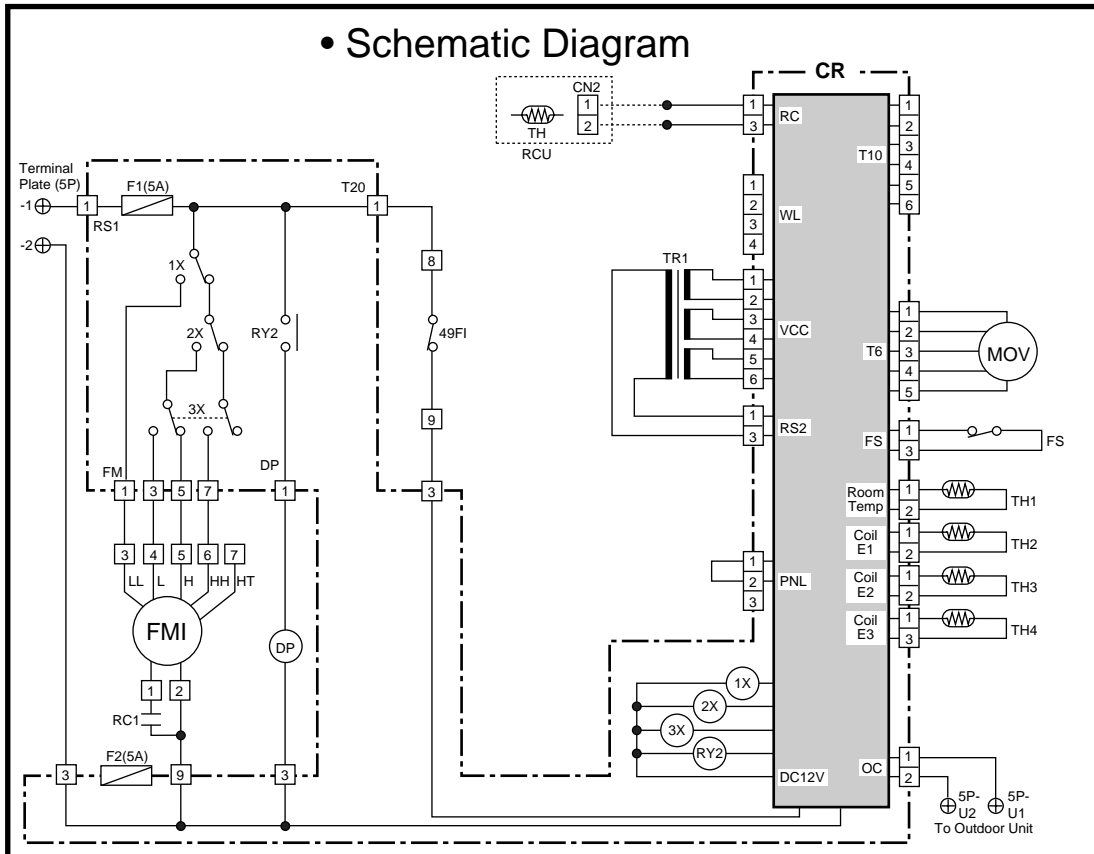

Symbols	Description	Symbols	Description
FMI	Indoor Fan Motor	CR	Indoor Controller
49FI	Indoor Motor Thermal Protector	(RCU)	Remote Control Unit (Optional Parts)
RC1	Running Capacitor	(TH)	Room Thermistor
F1, 2	Fuse	⊕	Terminal Plate
DP	Drain Pump	□	Connector
FS	Float Switch	⊕	Terminal
TR1	Power Transformer		
1X~3X	Auxiliary Relay		
RY2	Auxiliary Relay		
MOV	Motor Operated Valve		
TH1	Room Thermistor		
TH2	Thermistor (Indoor Coil E1)		
TH3	Thermistor (Indoor Coil E2)		
TH4	Thermistor (Indoor Coil E3)		

© 854-2-5268-940-00-0 (UH1242)



Wall Mounted Type : KH2442

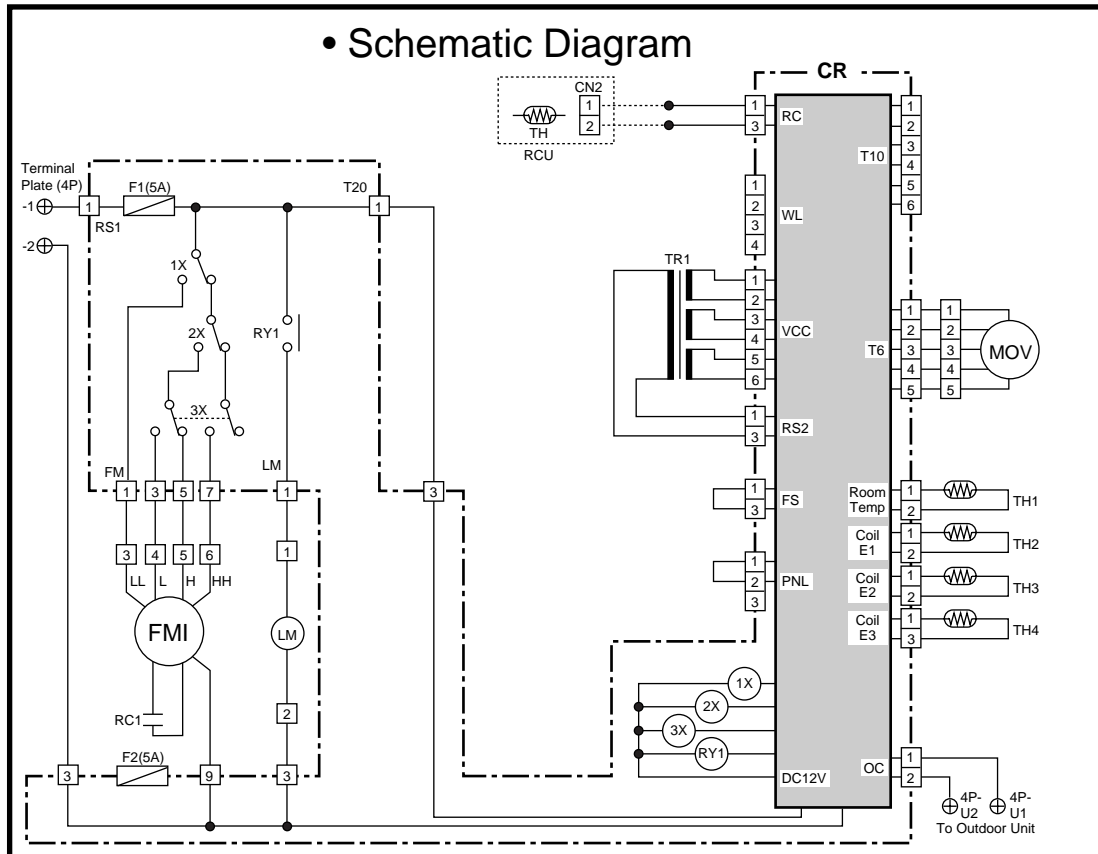

3

Symbols	Description	Symbols	Description
FMI	Indoor Fan Motor	CR	Indoor Controller
49FI	Indoor Motor Thermal Protector	(RCU)	Remote Control Unit (Optional Parts)
RC1	Running Capacitor	(TH)	Room Thermistor
F1, 2	Fuse	⊕	Terminal Plate
LM	Auto Louver Motor	□	Connector
TR1	Power Transformer	⊕	Terminal
1X-3X	Auxiliary Relay		
RY1	Auxiliary Relay		
MOV	Motor Operated Valve		
TH1	Room Thermistor		
TH2	Thermistor (Indoor Coil E1)		
TH3	Thermistor (Indoor Coil E2)		
TH4	Thermistor (Indoor Coil E3)		

© 854-2-5268-935-00-0 (KH2442)

Wall Mounted Type : KH3642

• Electric Wiring Diagram

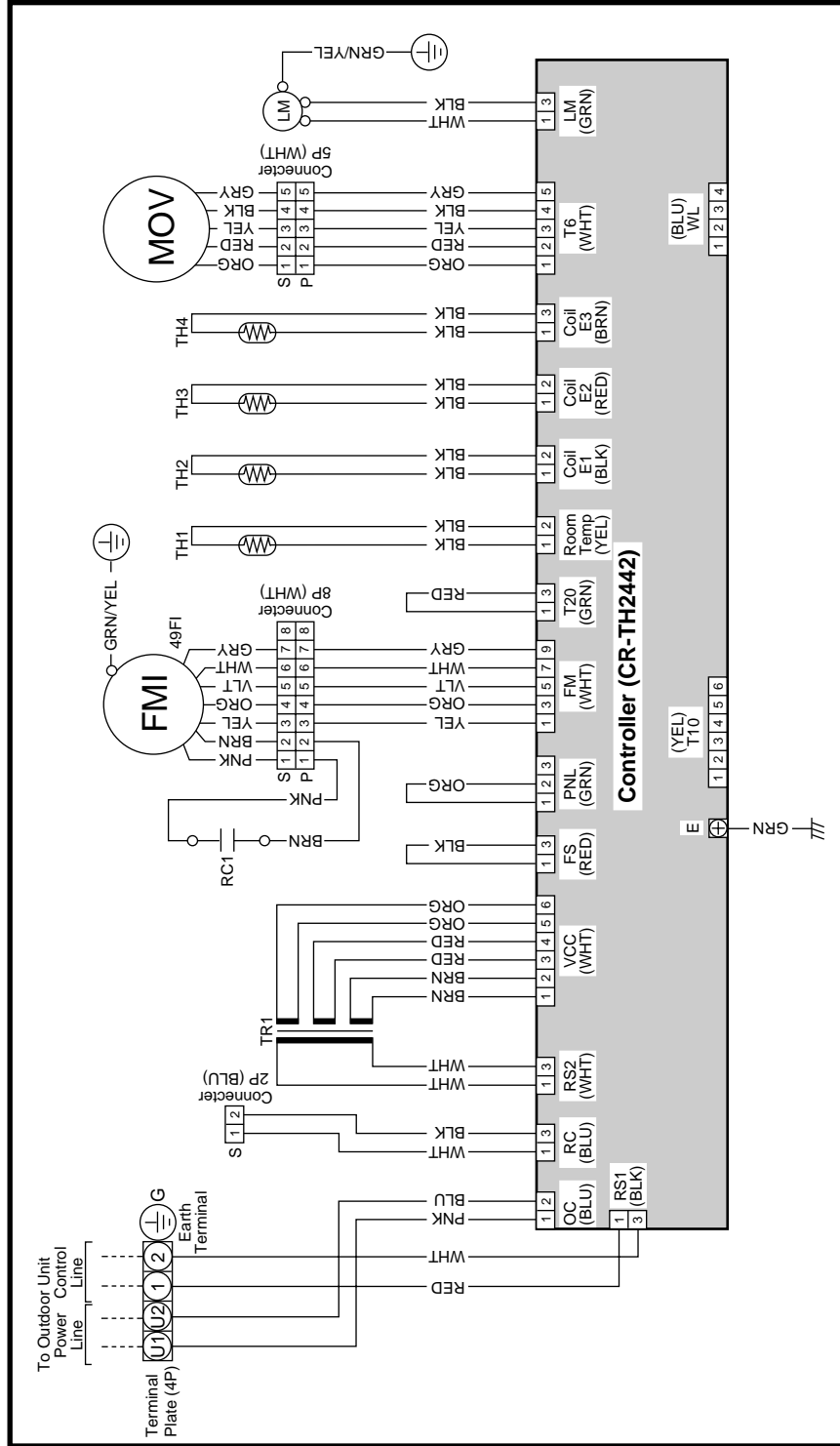

⑧ 854-2-5268-936-00-0 (KH3642)

Wall Mounted Type : KH3642

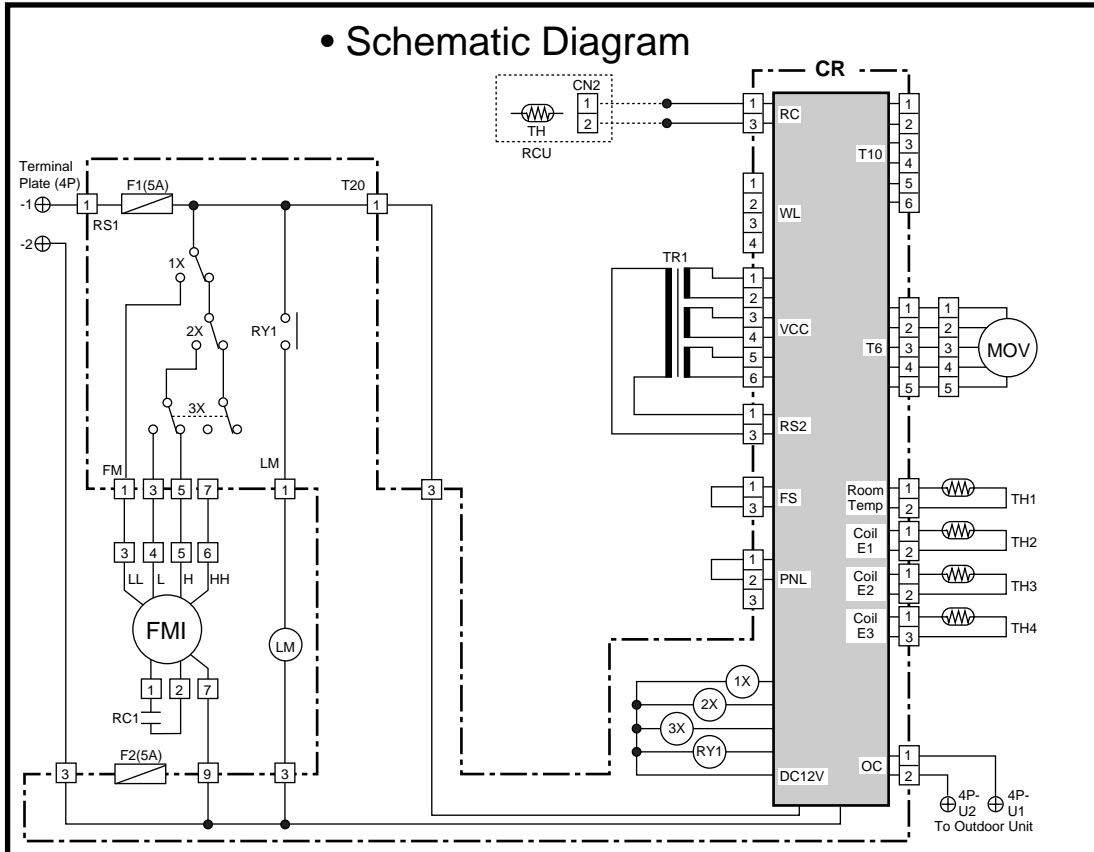

Symbols	Description	Symbols	Description
FMI	Indoor Fan Motor	CR	Indoor Controller
49FI	Indoor Motor Thermal Protector	(RCU)	Remote Control Unit (Optional Parts)
RC1	Running Capacitor	(TH)	Room Thermistor
F1, 2	Fuse	⊕	Terminal Plate
LM	Auto Louver Motor	□	Connector
TR1	Power Transformer	⊕	Terminal
1X~3X	Auxiliary Relay		
RY1	Auxiliary Relay		
MOV	Motor Operated Valve		
TH1	Room Thermistor		
TH2	Thermistor (Indoor Coil E1)		
TH3	Thermistor (Indoor Coil E2)		
TH4	Thermistor (Indoor Coil E3)		

© 854-2-5268-936-00-0 (KH3642)



3-2 Outdoor Units

① CH2442

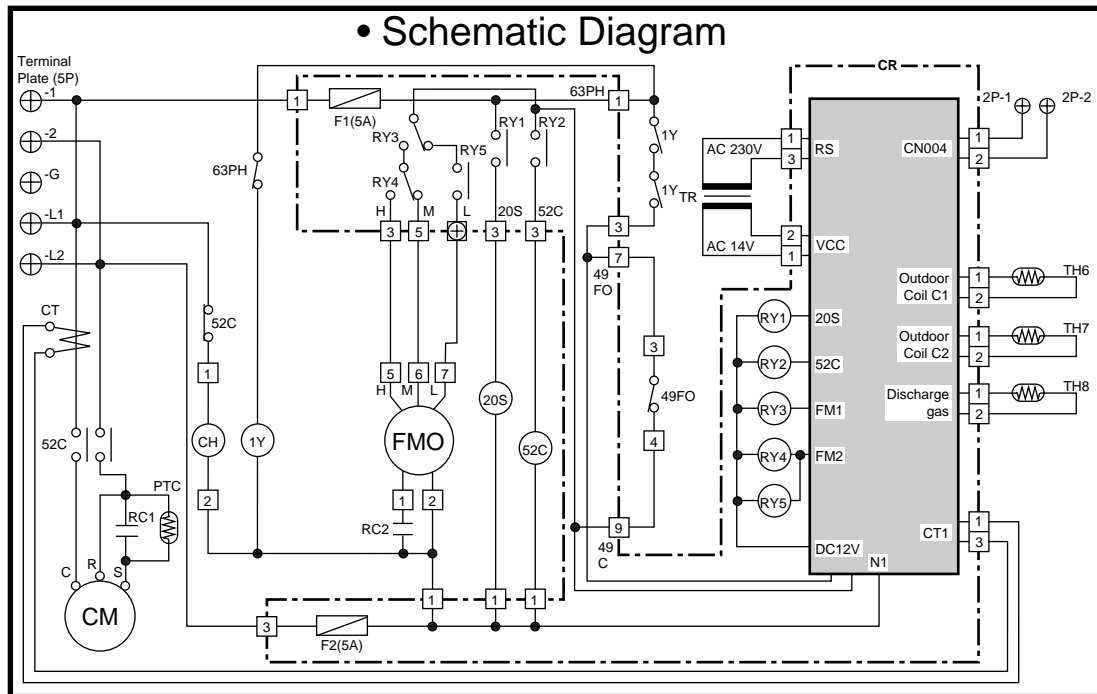

Symbols	Description	Symbols	Description
CM	Compressor Motor	CR	Outdoor Controller
FMO	Outdoor Fan Motor	RY1~RY5	Auxiliary Relay
52C	Compressor Motor Magnetic Contactor	1Y	Auxiliary Relay
49FO	Outdoor Fan Motor Thermal Protector	⊕	Terminal Plate
63PH	High Pressure Switch	⊕	Terminal
CT	Current Transmitter	□	Connector
RC1,2	Running Capacitor		
TR	Power Transformer		
CH	Crank Case Heater		
20S	Four Way Valve		
F1,2	Fuse		
TH6	Thermistor (Outdoor Coil C1)		
TH7	Thermistor (Outdoor Coil C2)		
TH8	Thermistor (Discharge Gas)		
PTC	PTC Thermistor		

© 854-2-5268-945-00-0 (CH2442-S)





3-2 Outdoor Units

② CH3642

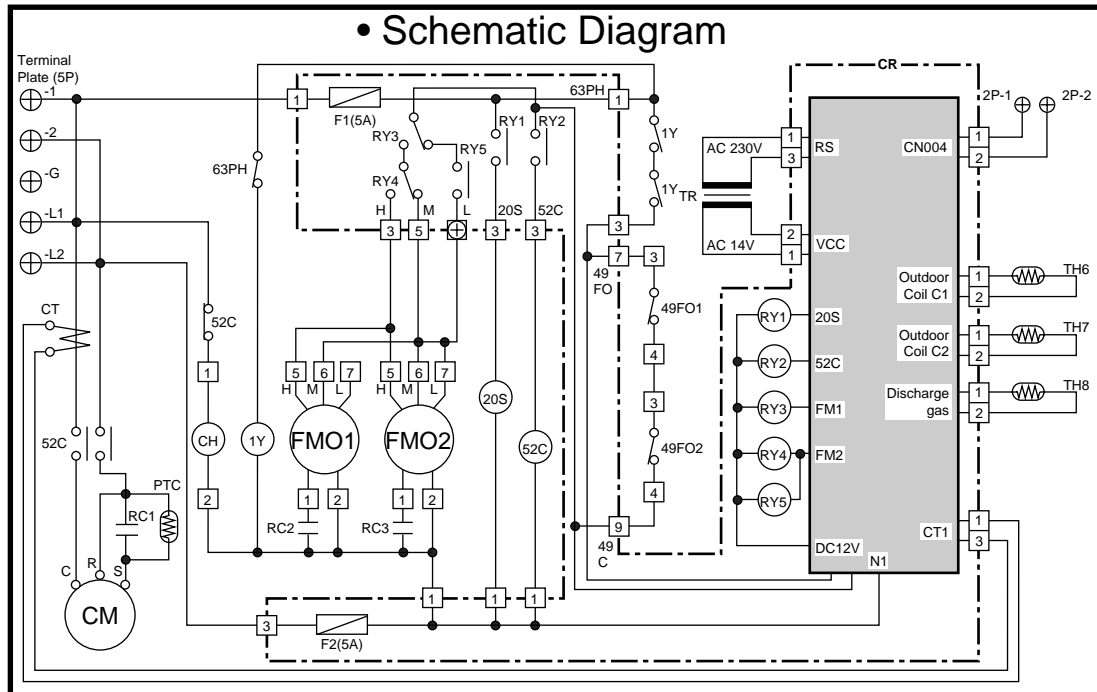

Symbols	Description	Symbols	Description
CM	Compressor Motor	CR	Outdoor Controller
FMO1,2	Outdoor Fan Motor	RY1~RY5	Auxiliary Relay
52C	Compressor Motor Magnetic Contactor	1Y	Auxiliary Relay
49FO1,2	Outdoor Fan Motor Thermal Protector	⊕	Terminal Plate
63PH	High Pressure Switch	⊕	Terminal
CT	Current Transmitter	□	Connector
RC1,2,3	Running Capacitor		
TR	Power Transformer		
CH	Crank Case Heater		
20S	Four Way Valve		
F1,2	Fuse		
TH6	Thermistor (Outdoor Coil C1)		
TH7	Thermistor (Outdoor Coil C2)		
TH8	Thermistor (Discharge Gas)		
PTC	PTC Thermistor		

© 854-2-5268-946-00-0 (CH3462-S)



3-2 Outdoor Units

③ CH4242

• Electric Wiring Diagram

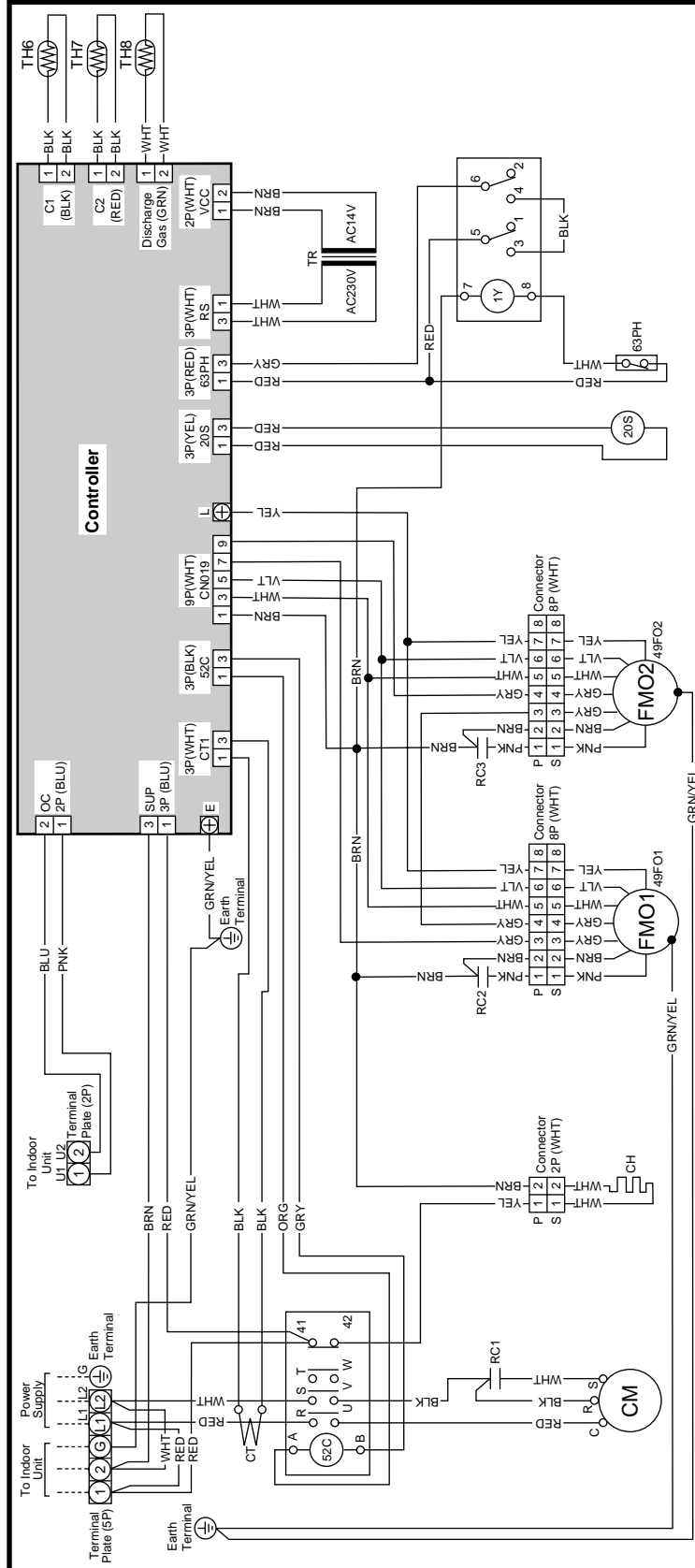

⑈ 854-2-5268-948-00-0 (CH4242-S)

3-2 Outdoor Units

③ CH4242

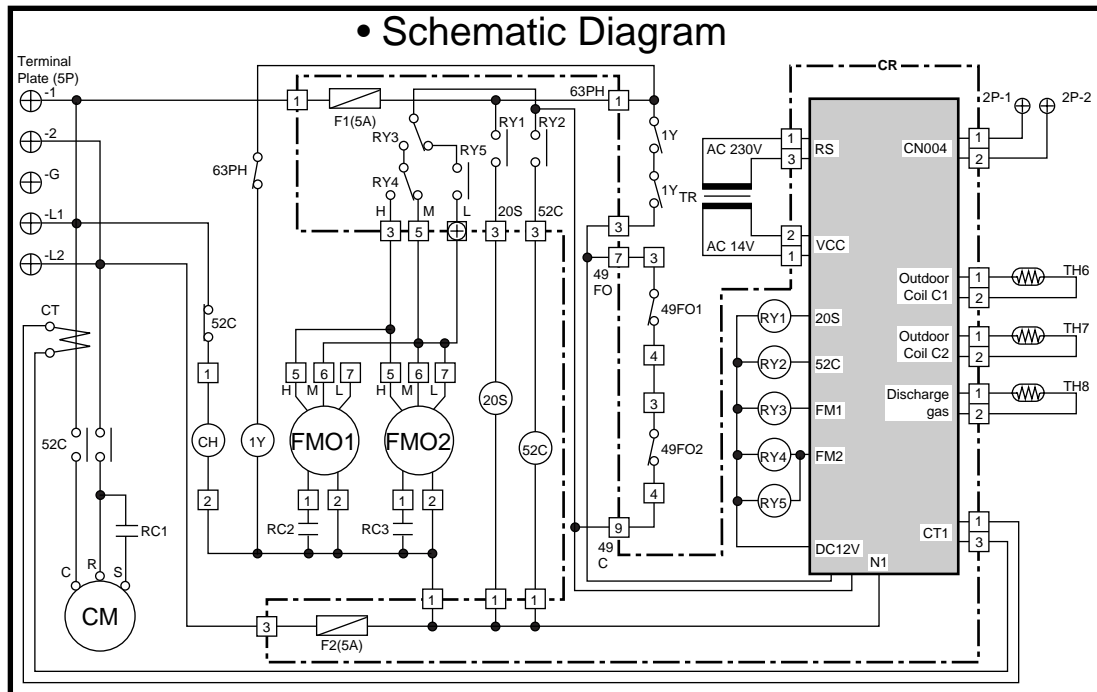

Symbols	Description	Symbols	Description
CM	Compressor Motor	CR	Outdoor Controller
FMO1,2	Outdoor Fan Motor	RY1~RY5	Auxiliary Relay
52C	Compressor Motor Magnetic Contactor	1Y	Auxiliary Relay
49FO1,2	Outdoor Fan Motor Thermal Protector	⊕	Terminal Plate
63PH	High Pressure Switch	⊕	Terminal
CT	Current Transmitter	□	Connector
RC1,2,3	Running Capacitor		
TR	Power Transformer		
CH	Crank Case Heater		
20S	Four Way Valve		
F1,2	Fuse		
TH6	Thermistor (Outdoor Coil C1)		
TH7	Thermistor (Outdoor Coil C2)		
TH8	Thermistor (Discharge Gas)		

© 854-2-5268-948-00-0 (CH4242-S)



## 4. SERVICE PROCEDURES

4-1	Troubleshooting .....	IV - 2
(1)	Check before and after Troubleshooting .....	IV - 3
(2)	General Troubleshooting Flow Chart: Diagnosis and Remedy .....	IV - 4
(3)	Meanings of alarm messages .....	IV - 6
(4)	LED Indication on the Outdoor Unit's P.C.B. Ass'y .....	IV - 8
(5)	Symptoms and parts to inspect .....	IV - 9
(6)	Procedures When a Specific Component Does Not Work .....	IV - 19
(7)	Service Functions of Remote Controller .....	IV - 21
4-2	Checking the Electrical Components .....	IV - 30
(1)	Measurement of Insulation Resistance .....	IV - 30
(2)	Checking the Protective Devices .....	IV - 31
(3)	Checking the Electrical Parts .....	IV - 32
(4)	Thermistor Characteristic Curve .....	IV - 35
(5)	PCB Setting .....	IV - 36
(6)	R.C Address Setting Method .....	IV - 37
(7)	Automatic Address Setting Method .....	IV - 38
(8)	Displaying Indoor / Outdoor Unit Combination Numbers .....	IV - 38
(9)	Items to Check Prior to Test Run .....	IV - 39
(10)	Test Run .....	IV - 40
(11)	PCBs and Their Location .....	IV - 42
(12)	Checking procedure for each PC Board .....	IV - 44
(13)	TMX60 Pins .....	IV - 45

### 4-1 Troubleshooting

This section explains:

- What the LED codes mean
- What the remote control unit display screen messages mean
- How to use the flow charts to find and solve problems
- How to use the self-diagnostic tests to find parts that aren't working right

This unit is made to be trouble free, and not need much service. However, with time, moving parts wear out, electronic components break down, and sometimes misuse damages the unit. The purpose of this section is to help you when the unit is not working properly. Sometimes your experience will tell you right away where to look for a problem, and when you find it you will know how to fix it at once.

Often, however, all you have is a *symptom* like "poor cooling" or "outside fan doesn't come on." Now you must find out the cause of the problem, and then how to fix it. This section provides several ways to help you go from the symptom to the cause and then the solution. The first chart, **General Troubleshooting Flow Chart** is divided into two sections: Poor heating and Poor Cooling. Under each heading you will find the main things that can go wrong and cause either of these problems. Sometimes you can start with this chart and find the problem right away, but often you will come here for more suggestions after you have looked at the error code on the remote control unit display. This chart gives you the "big picture" of problems and solutions.

The other main tool we explain here is the use of the **Alarm Messages**. When a certain part fails or a safety device has shut the unit down, any alpha-numeric codes appears on the display to guide you to the problem.

By understanding the code you can often go right to the problem area and then, with this manual and your knowledge of air conditioning, find the solution.

### (1) Check before and after Troubleshooting

Many problems may happen because of wiring or power supply problems, so you should check these areas first. Problems here can cause false results in some of the other tests, and so should be corrected first.

#### ①. Check power supply wiring

- Check the power supply wires are correctly connected between terminal No. 1 & 2 on the 5P terminal plates in the indoor unit and the outdoor unit.

#### ②. Check inter-unit wiring

- Check that inter-unit control wiring (DC low voltage) is correctly connected between the indoor unit and outdoor unit.

Power Supply: 60 Hz, single-phase, 230/208 V

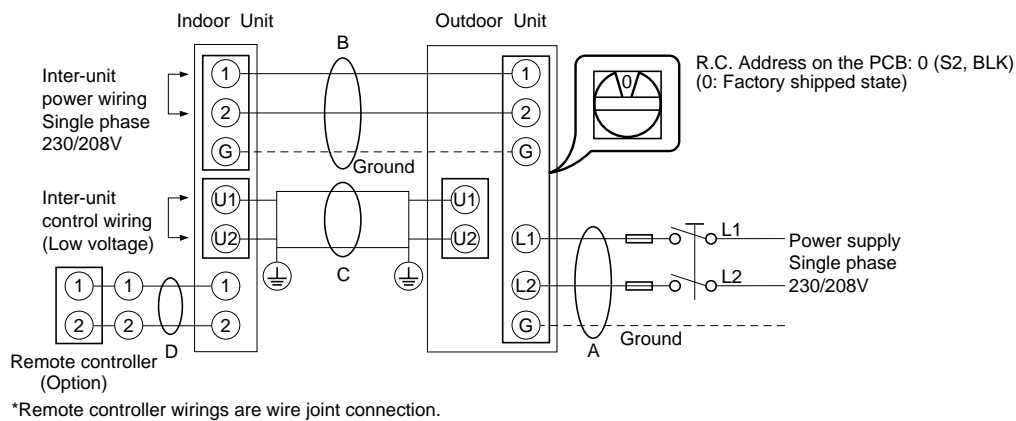

2085\_M\_1

Fig. IV-1

#### ③. Check power supply

- Check that voltage is within the specified range ( $\pm 10\%$  of the rating).
- Check that power is being supplied.



**WARNING**

If the following troubleshooting must be done with power being supplied, be careful not to touch any uninsulated live part that can cause **ELECTRIC SHOCK**.

#### ④. Check the lead wires and connectors in indoor and outdoor units.

- Check that the sheath of lead wires is not damaged.
- Check that the lead wires are firmly connected at the terminal plate.
- Check that the wiring is correct.

**(2) General Troubleshooting Flow Chart: Diagnosis and Remedy**

When you have found a major problem, such as refrigerant not flowing in the system or reduced air circulation, come to this section and find the box listing the problem. Connected to the box are the main causes of the problem and their remedies. To find out which malfunction is happening in your case, check the remote controller for an Alarm Message, and follow the steps in section 3).

**(A) Cooling**

a. Cooling

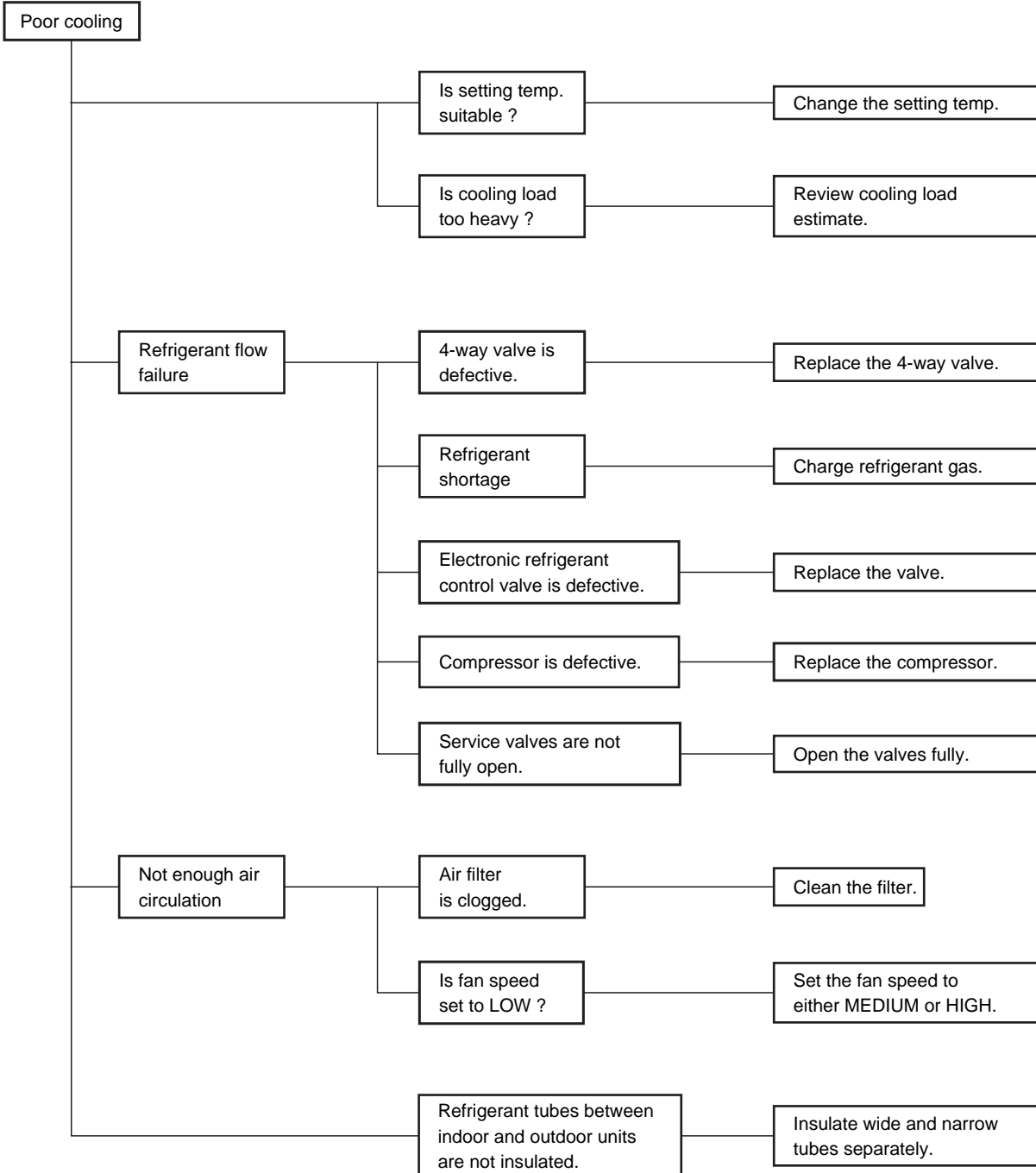

0458\_M\_I



(B) Heating

b. Heating

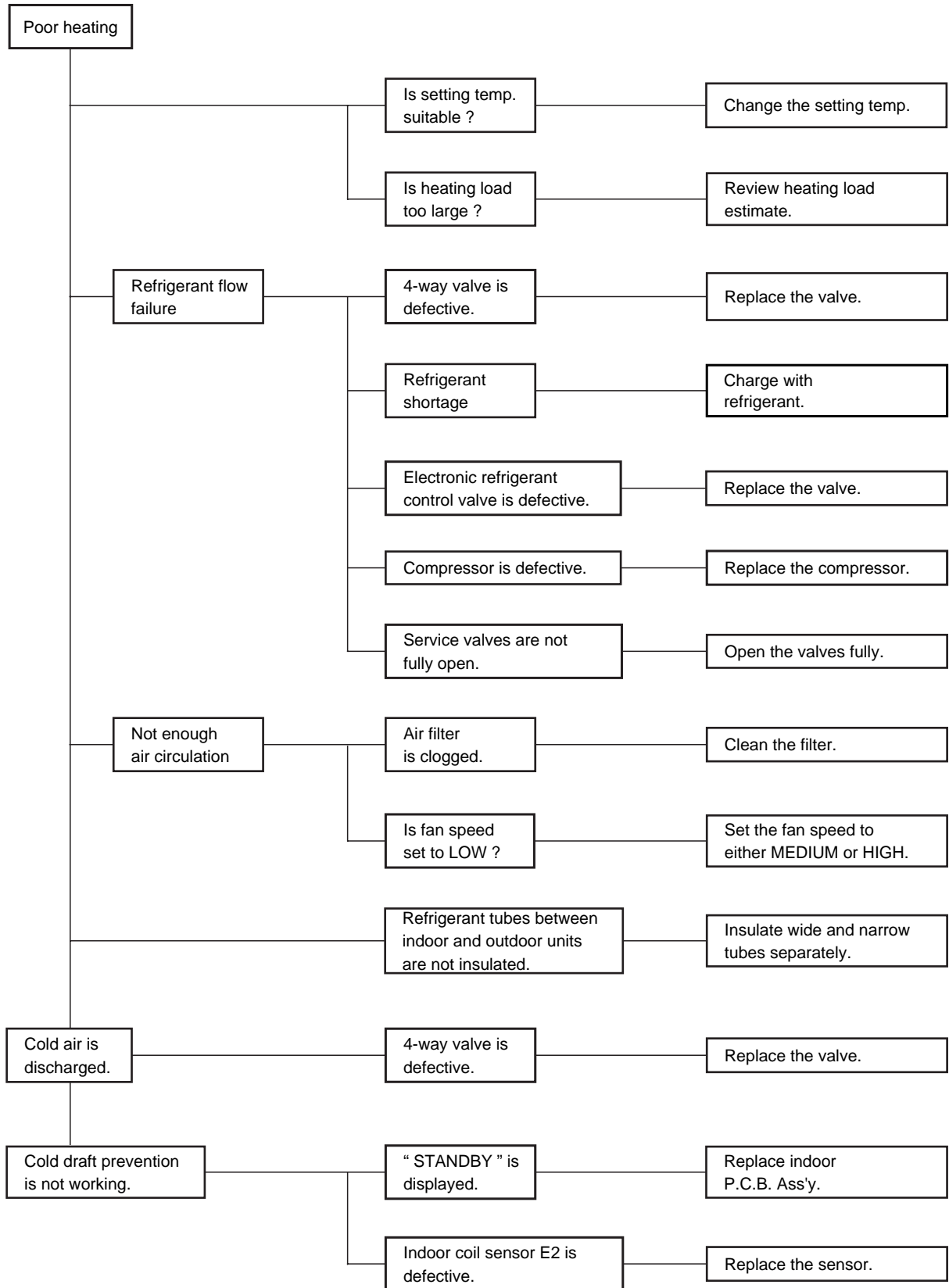

0459\_M\_1



(3) Meanings of alarm messages

Possible Cause of Malfunction		Alarm message
<ul style="list-style-type: none"> <li>• Serial communication errors</li> <li>• Mis-setting</li> </ul>	Remote controller is detecting error signal from indoor unit.	E1
		E2
	• Indoor unit is detecting error signal from the remote controller. (No serial communications signal)	E3
	Indoor unit is detecting error signal from outdoor unit.	E4
		E5
	Outdoor unit is detecting error signal from indoor unit.	E6
	Indoor unit is not working correctly.	
	Outdoor unit is transmitting error signal.	E7
	Improper setting of indoor unit or remote controller.	E8
		E9
		E12
	When using group control, main indoor unit address setting is duplicated. (For single heat pump type.)	E14
	Error in Auto. address setting. (No. or capacity of judged indoor unit is small.)	E15
	Error in Auto. address setting. (No. or capacity of judged indoor unit is large.)	E16
Indoor unit is detecting error signal from another indoor unit.	E18	
Activation of protective device	Protective device in indoor unit is activated.	• Thermal protector in indoor fan motor is activated. P1
	Protective device in outdoor unit is activated.	• Thermal protector in outdoor fan motor is activated. • Comp. thermal protector is activated. P2
		Incorrect discharge gas temp. of comp. P3
		High-pressure switch is activated. P4
		Incorrect power supply voltage . Negative phase, defective phase or voltage drop. P5
		Incorrect discharge gas temp. of comp. P17
	Protective device in indoor unit is activated.	Improper wiring connections of ceiling panel. P9
		Float switch is activated. P10

**NOTE**

- RCU : Remote Control Unit (remote controller)
- R.C. : Refrigerant Circuit
- comp. : Compressor
- temp. : Temperature
- PCB : Printed Circuit Board

## 4. Service procedures

Possible Cause of Malfunction			Alarm message
Thermistor failure	Indoor thermistor is either open or damaged.	Indoor coil temp. (E1 = TH1) cannot be detected.	F1
		Indoor coil temp. (E2 = TH2) cannot be detected.	F2
		Indoor coil temp. (E3 = TH3) cannot be detected.	F3
		Indoor room (air-intake) temp. can not be detected.	F10
	Outdoor thermistor is either open or damaged.	Discharge gas temp. (comp. = TH0A) cannot be detected.	F4
		Outdoor coil gas temp. (C2 = TH0C) cannot be detected.	F25
		Outdoor coil liquid temp. (C1 = TH0D) cannot be detected.	F7
EEPROM (ICB of PCB) failure			F29
Fault with comp. and its circuit	Protective device for comp. is activated.	Comp. motor is overloaded.	H1
		Comp. motor is locked.	H2
		Current of comp. cannot be detected when it is turned on.	H3
		Current of comp. is detected when it is not operated.	F27
		Comp. contactor (Mg SW) is chattering.	H18

Possible cause of Malfunction	Alarm message
Model setting of indoor unit is not matching the outdoor unit.	L2
When using group control, main indoor unit address setting is duplicated. (Judging by indoor unit.)	L3
Outdoor unit address (R.C. No.) is duplicated.	L4
Priority setting of indoor unit is duplicated.	L5
—	L6
Improper wiring between indoor units. (There is group connection wiring in case of individual control.)	L7
Capacity code of indoor unit is not set.	L9
Improper wiring of group control wiring.	L11

Possible Cause of Malfunction (The following messages are displayed only for the system controller.)			Alarm message
<ul style="list-style-type: none"> <li>• Serial communication errors</li> <li>• Mis-setting</li> </ul>	System controller is transmitting incorrect signal.	<ul style="list-style-type: none"> <li>• Indoor or outdoor unit is not working correctly.</li> <li>• Control lines between indoor unit, outdoor unit, and system controller are not wired correctly.</li> </ul>	C05
	System controller is detecting incorrect signal.	<ul style="list-style-type: none"> <li>• Same as for C05, above.</li> <li>• Connector CN1 is not connected correctly.</li> </ul>	C06
Activation of protective device	Protective device of the sub-indoor unit is activated in group control.	When using wireless remote controller or system controller, connect wired remote controller with the indoor unit temporarily to check the alarm message in detail.	P30

### NOTE

- R.C. : Refrigerant Circuit
- comp. : Compressor
- temp. : Temperature
- PCB : Printed Circuit Board

**(4) LED Indication on the Outdoor Unit's P.C.B. Ass'y**

If something goes wrong with the outdoor unit, **LED** lamps on the **outdoor P.C.B. Ass'y** light up to show the cause of the trouble, in addition to the Alarm message on the remote controller.

LED 2 on P.C. board	LED 1 on P.C. board	Remote controller	Possible cause of trouble
●	●	No message	Normal
●	○	E06, E07, L04	Outdoor unit serial communication signal is abnormal. Outdoor unit address is duplicated.
●	*	No message	Other outdoor units are performing auto address and detecting refrigerant shortage.
○	●	P02	FMo • CM thermal protection is in operation. Power supply voltage is abnormal.
○	○	P04, P05	High voltage SW activates Negative phase protector activates.
○	*	F04~F09	Sensor is abnormal. (Open or short)
*	●	H01, H02	Abnormal compressor current value is detected.
*	*	E15, E16	Auto address failure
Flash at the same time			
*	*	"SETTING" flashes.	Auto address is in operation.
Flash alternately			

**NOTE** ●: LED lamps OFF ○: LED lamps ON (lights up) \*: LED lamps ON (blink)

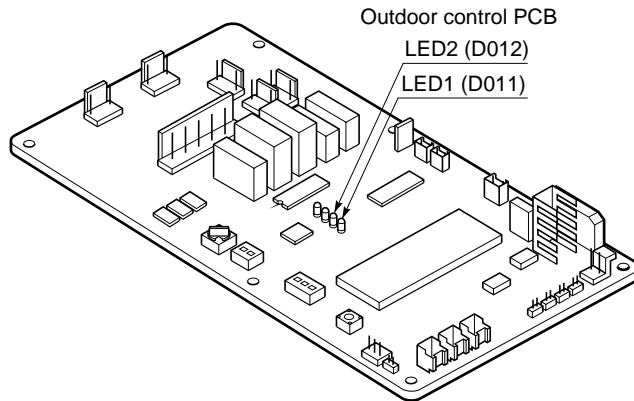

Fig. IV-2



**\* REFRIGERANT SHORTAGE**

Note particularly that a **shortage of refrigerant** is only shown by the **outdoor P.C.B. Ass'y LEDs** and the Alarm Message does not appear on the Indoor Remote Controller . The compressor keeps running even when the refrigerant is less, so when you find the LED indication on the **outdoor P.C.B. Ass'y**, stop the air conditioner immediately to avoid the compressor damage.

(5) Symptoms and parts to inspect

- 1) Symptom: LCD on the remote controller does not display and remote controller does not operate.

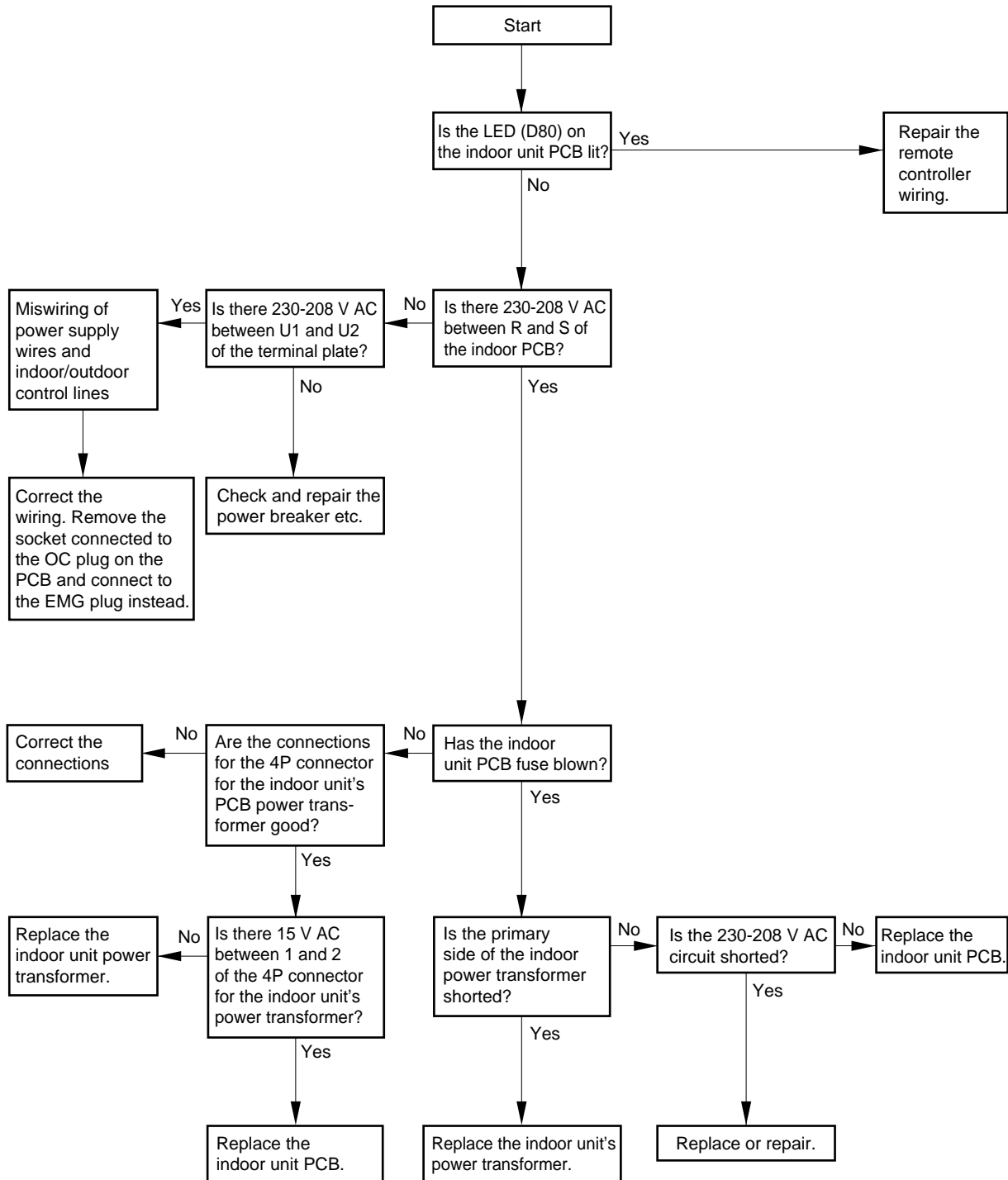

2095\_THS\_1



- 2) Symptom: LCD on the remote controller displays “CHECK E01”. (Unusual communication between remote controller and indoor unit.)

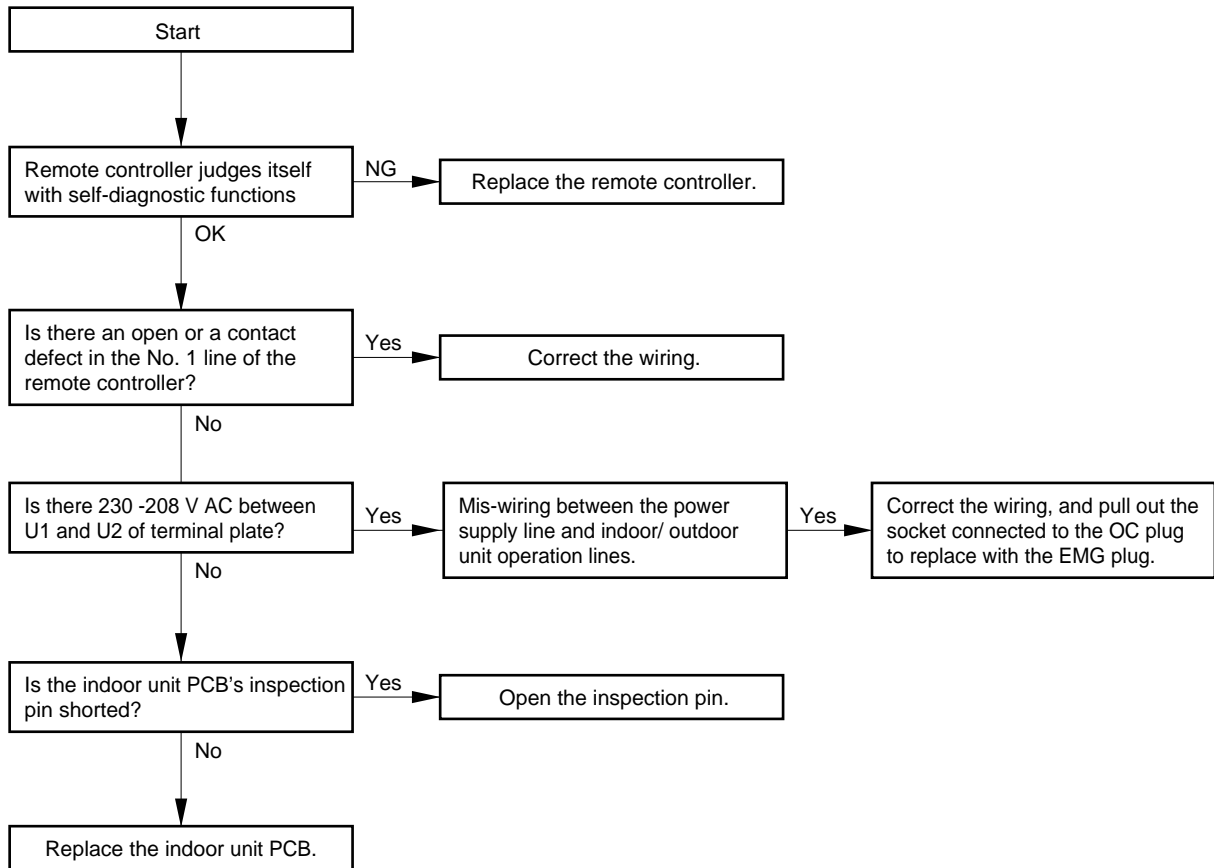

2096\_THS\_I

- 3) Symptom: LCD on the remote controller displays “CHECK E02”. (Unusual communication between remote controller and indoor unit)

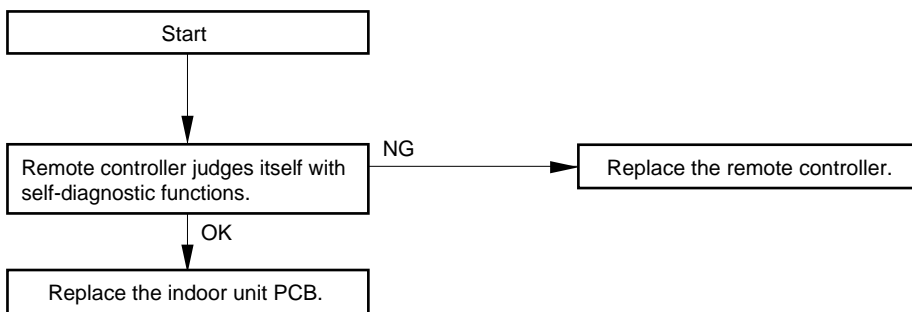

2097\_M\_I

- 4) Symptom: LCD on the remote controller is displaying “CHECK E04”. (Unusual communication between the indoor and outdoor units.)

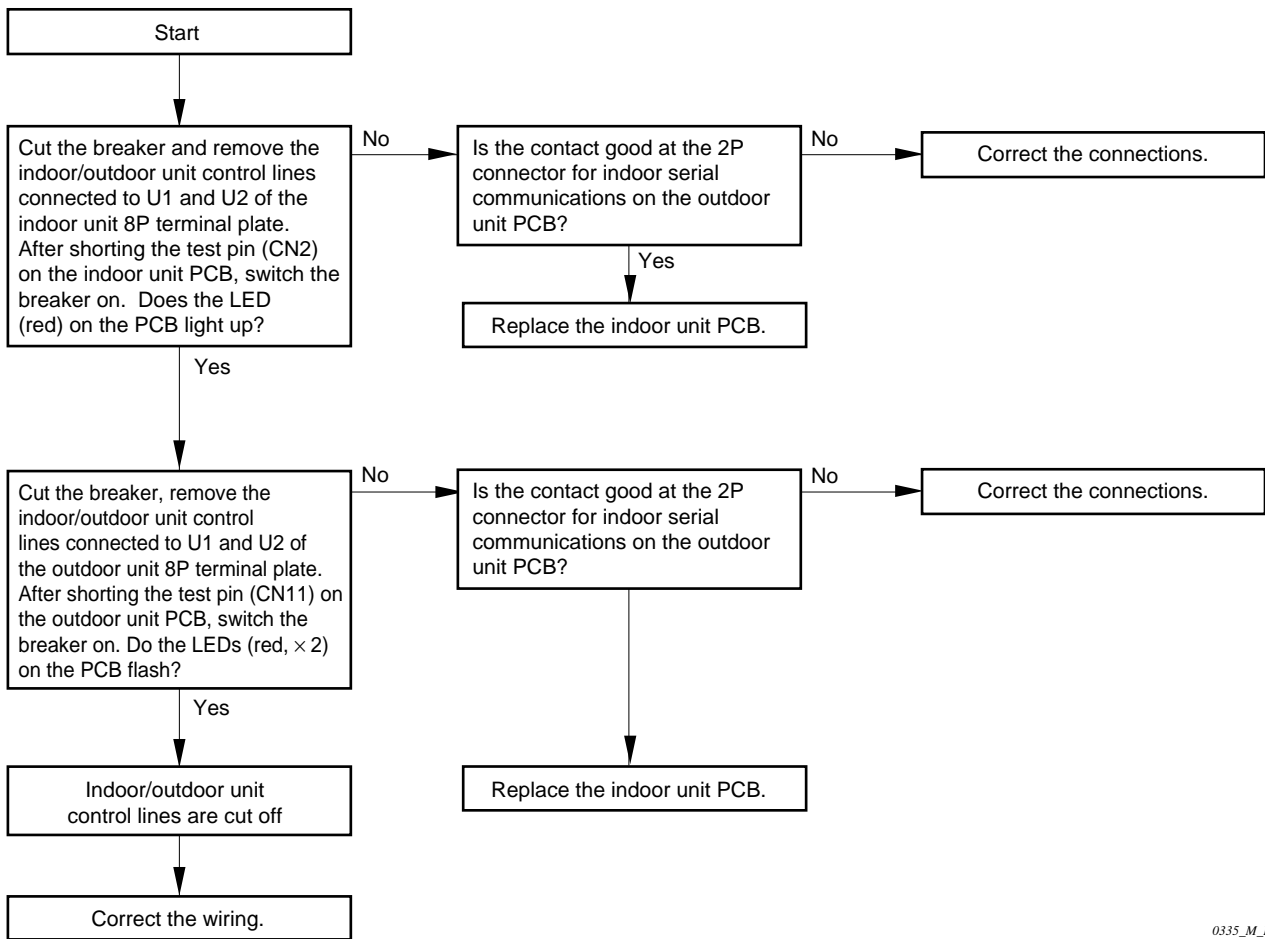

0335\_M\_I

- 5) Symptom: LCD on the remote controller is displaying “CHECK E05”. (Unusual communication between the indoor and outdoor units)

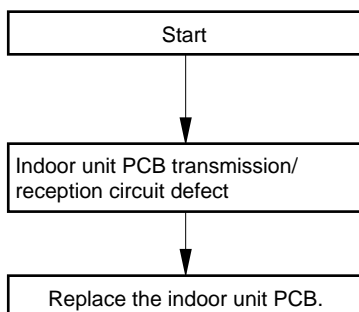

0336\_M\_I



- 6) Symptom: LCD on the remote controller is displaying "CHECK E06". (Unusual communication between the indoor and outdoor units)

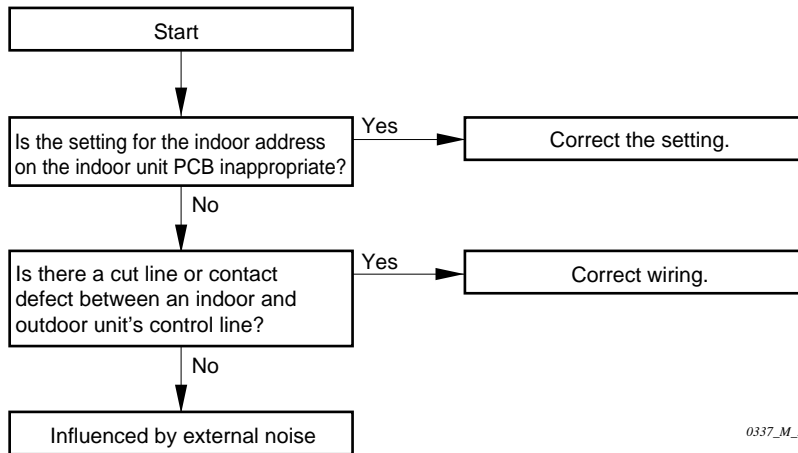

- 7) Symptom: LCD on the remote controller is displaying "CHECK E08". (Duplicate indoor unit address setting)

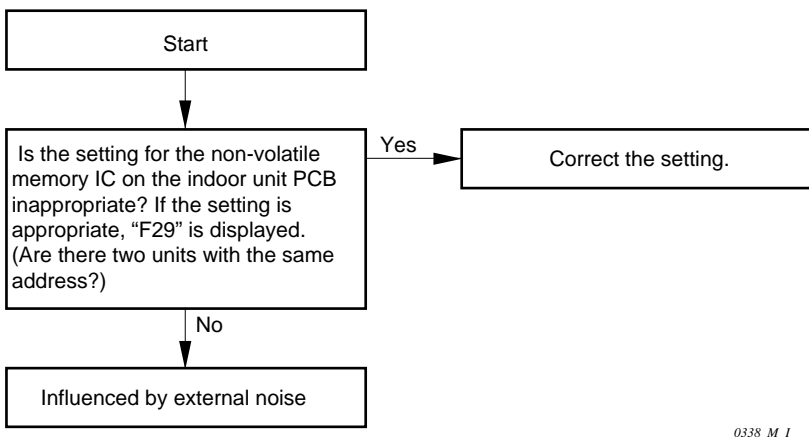

- 8) Symptom: LCD on the remote controller is displaying "CHECK E09". (Duplicate setting of RCU address switch of remote controllers)

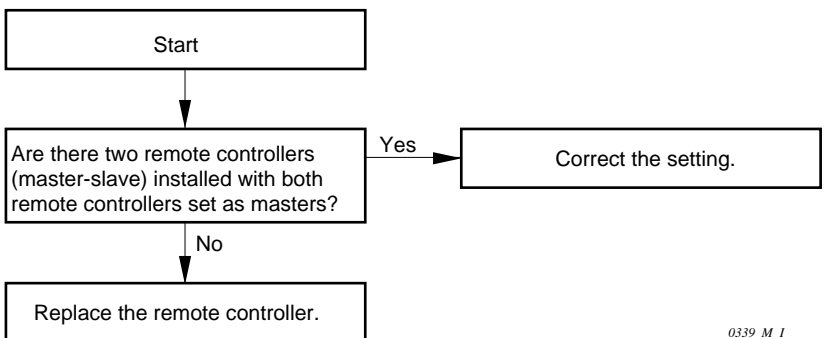



- 9) Symptom: LCD on the remote controller displays "CHECK P01". (Indoor fan protection thermostat operation warning)

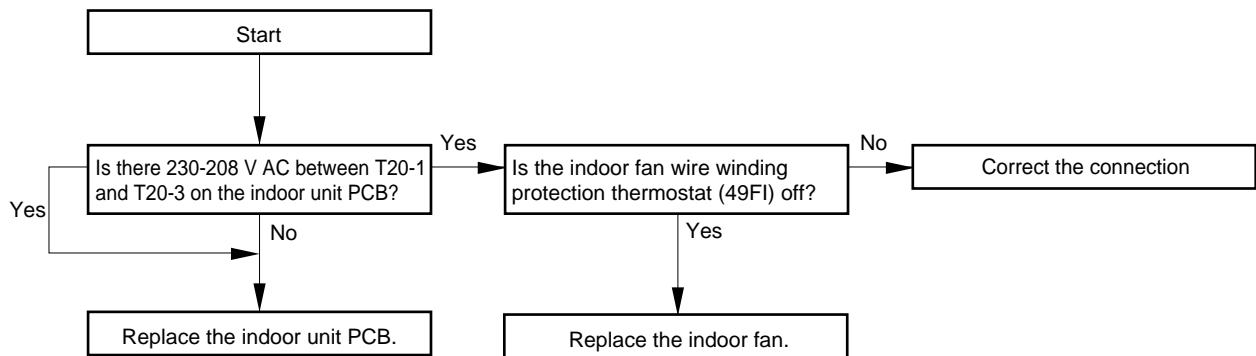

2098\_THS\_J

10) Symptom: LCD on the remote controller displays "CHECK P02". (Compressor / outdoor fan protection thermostat operation warning / power supply voltage abnormality)

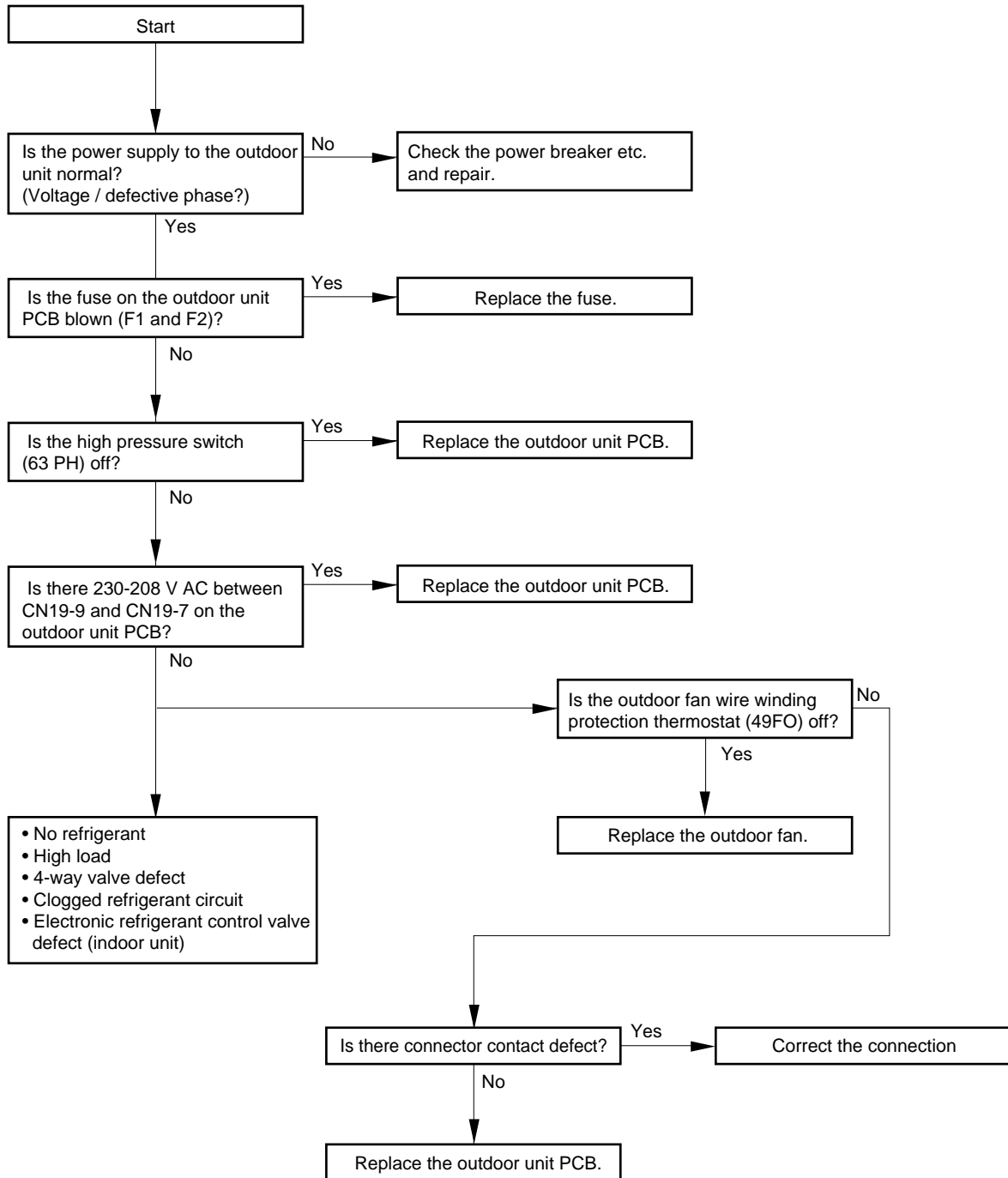

2099\_THS\_I

4

11) Symptoms: LCD on the remote controller displays “CHECK P03”.  
(Alarm for unusual discharge temp. of compressor)

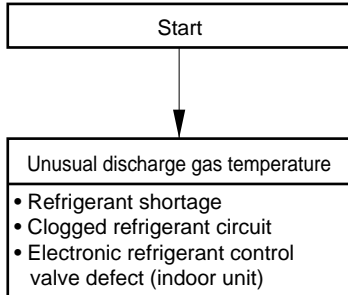

0343\_M\_I

12) Symptom: LCD on the remote controller displays “CHECK P04”. (High-pressure switch activation warning)

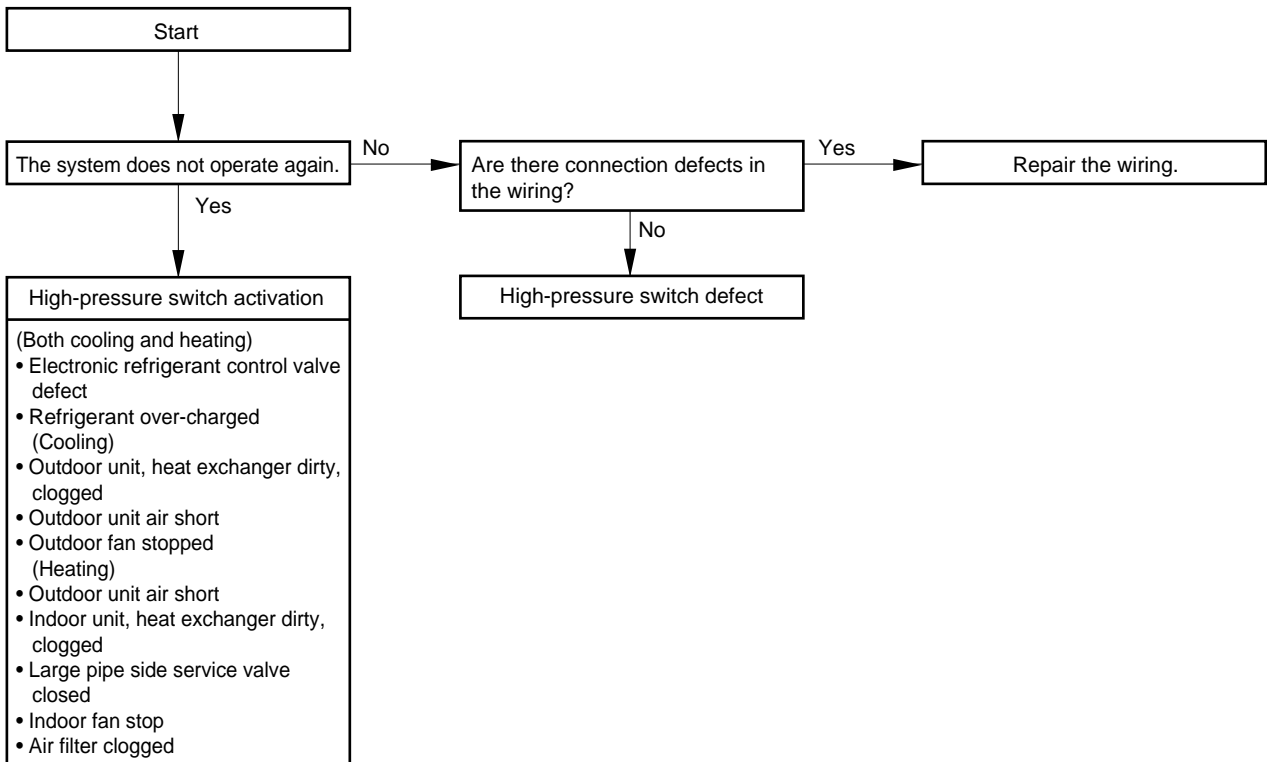

0344\_M\_I

13) Symptom: LCD on the remote controller displays "CHECK P05". (Negative phase detection operation warning)

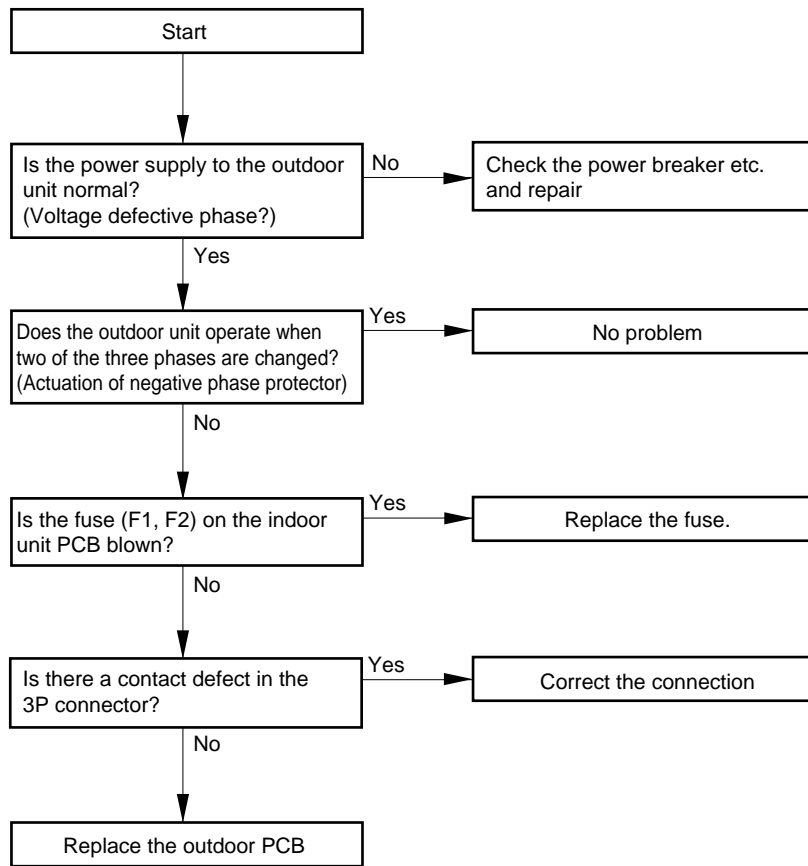

0345\_M\_I

14) Symptom: LCD on the remote controller displays "CHECK E15".

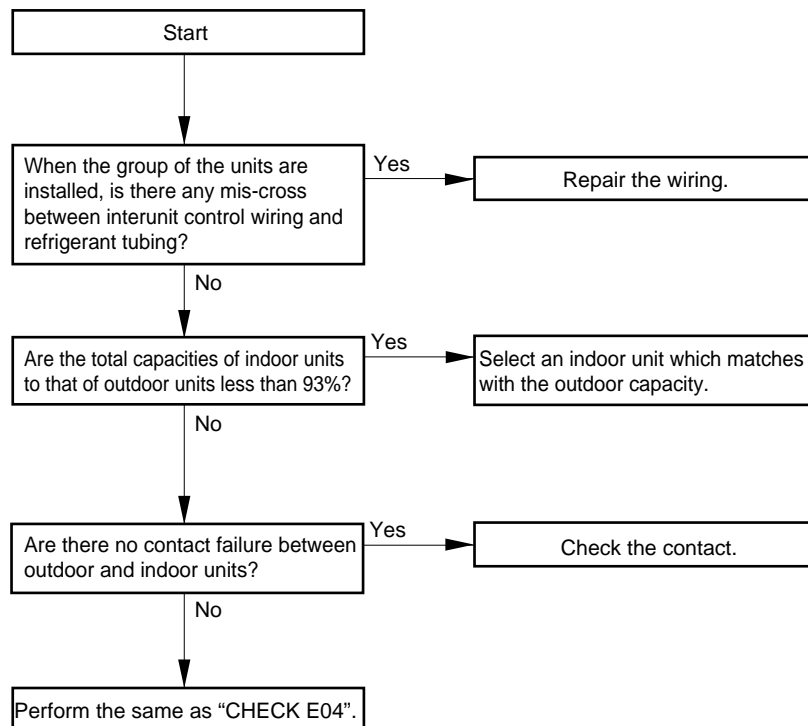

0646\_M\_S

15) Symptom: LCD on the remote controller displays “CHECK E16”.

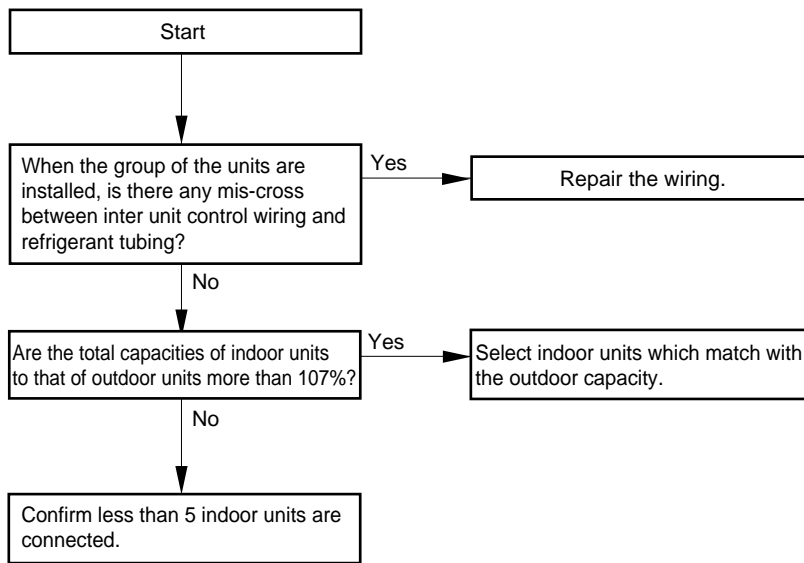

0647\_M\_S

16) Symptom: LCD on the remote controller displays “CHECK L13”.

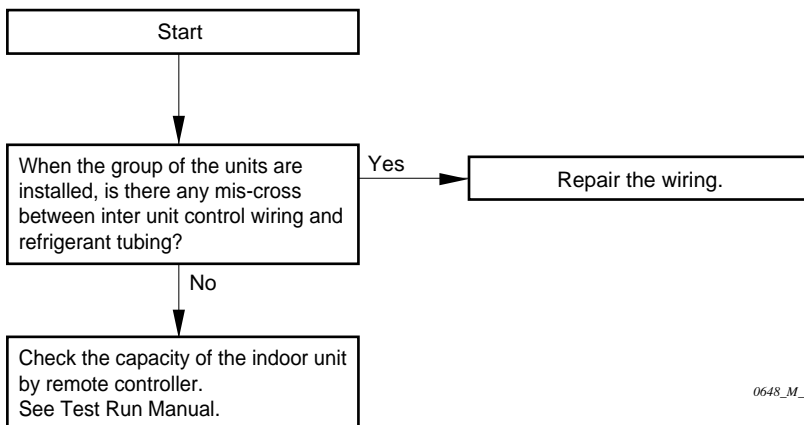

0648\_M\_S

17) “Check P9” is displayed on the remote control unit.

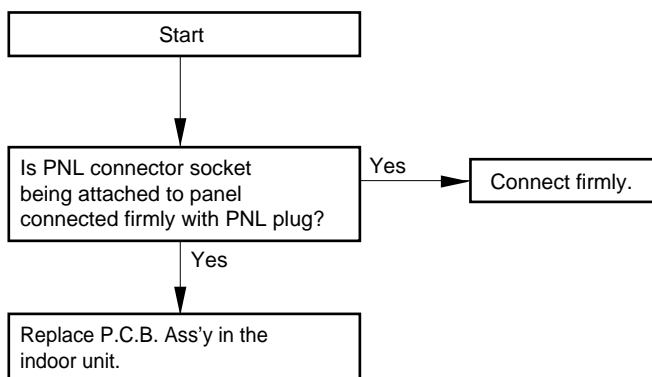

2100\_M\_S

18) Symptom: LCD on the remote controller displays “CHECK H01, H02, H03”.  
(compressor current detection)

\* Please check the related part described in the following chart after confirming the code setting (S4) of the outdoor unit’s capacity on the PCB in the outdoor unit.

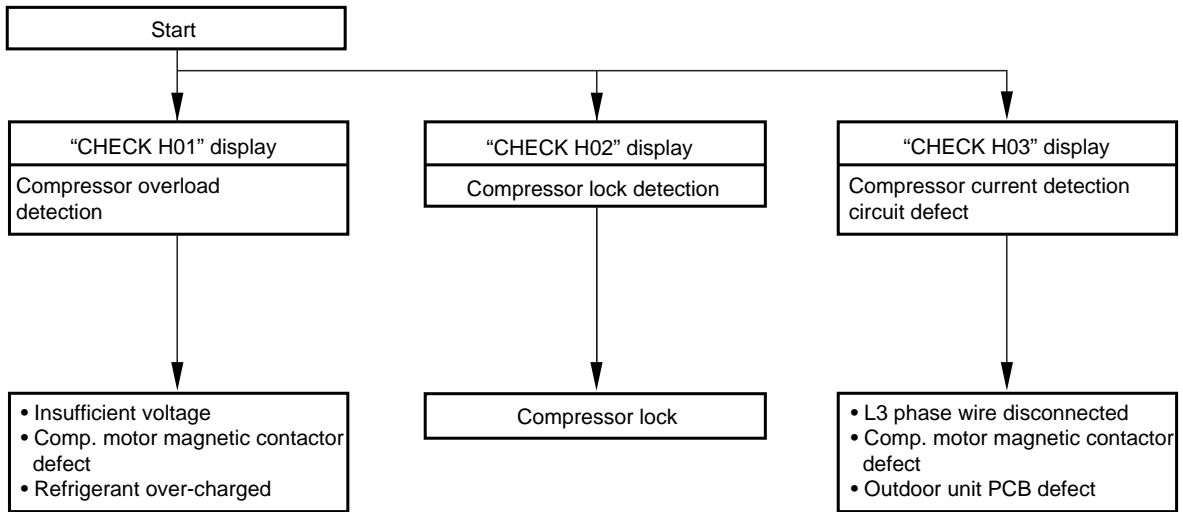

0346\_M\_I

19) Check the indoor unit (When the alarm of communication failure is not activated)

- If the electronic control valve failure occurred in Flexible Combination system (simultaneous operation system), one indoor unit would not be operated normally, then the other units won't be operated either. Due to this, try to detect the troubled unit and correct it.

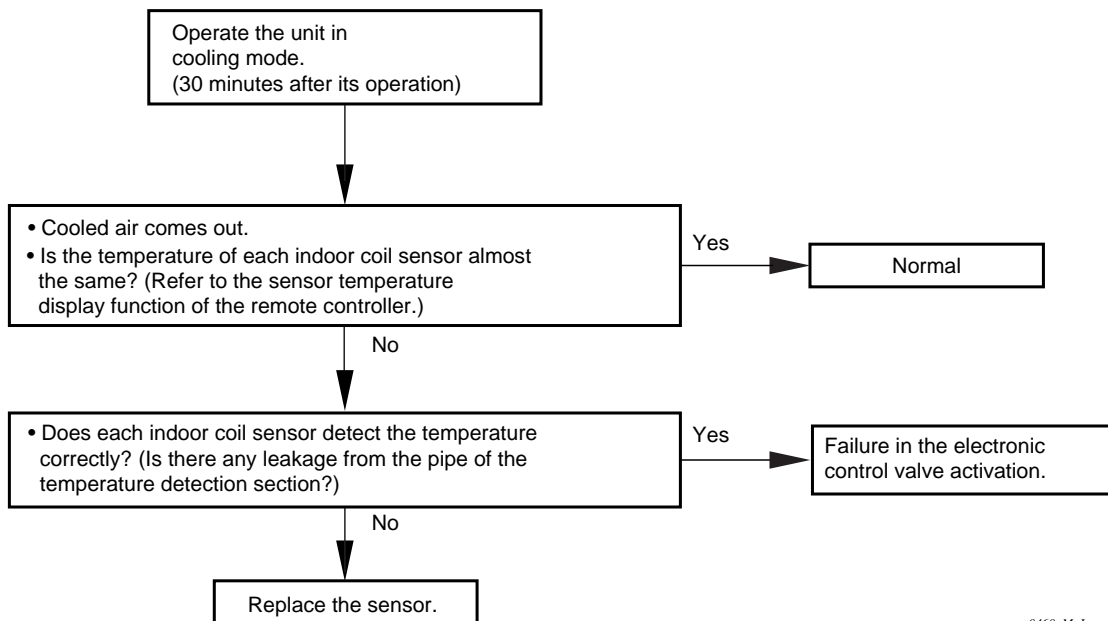

0460\_M\_I

(6) Procedures When a Specific Component Does Not Work

1) Indoor fan does not operate.

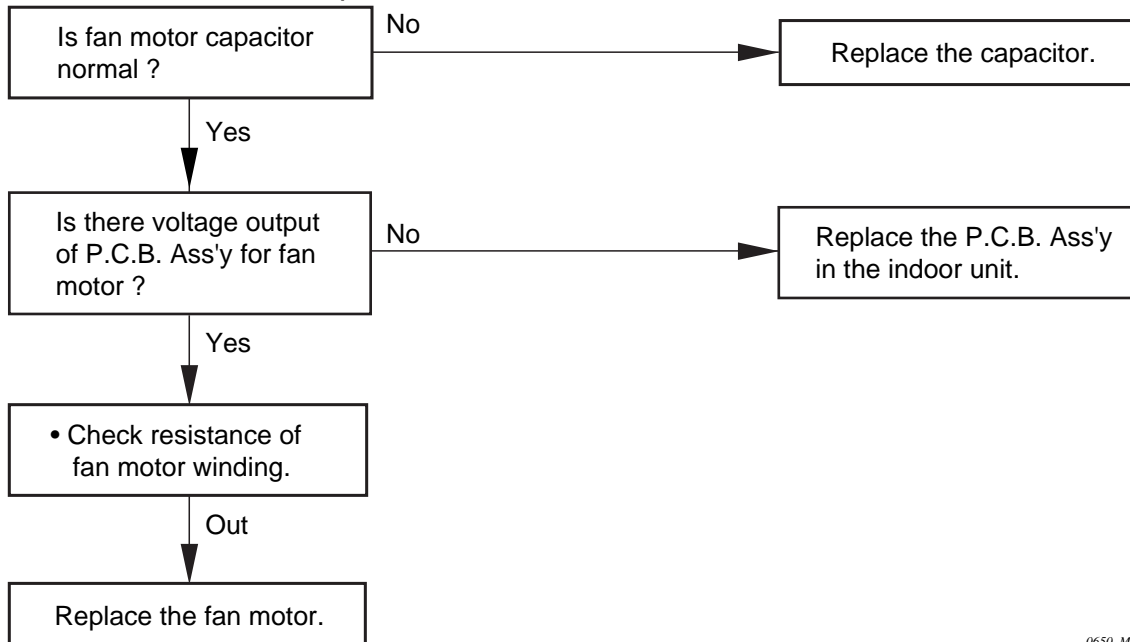

0650\_M\_S

2) Flaps in indoor unit's air outlet does not operate, when you press SWEEP button.

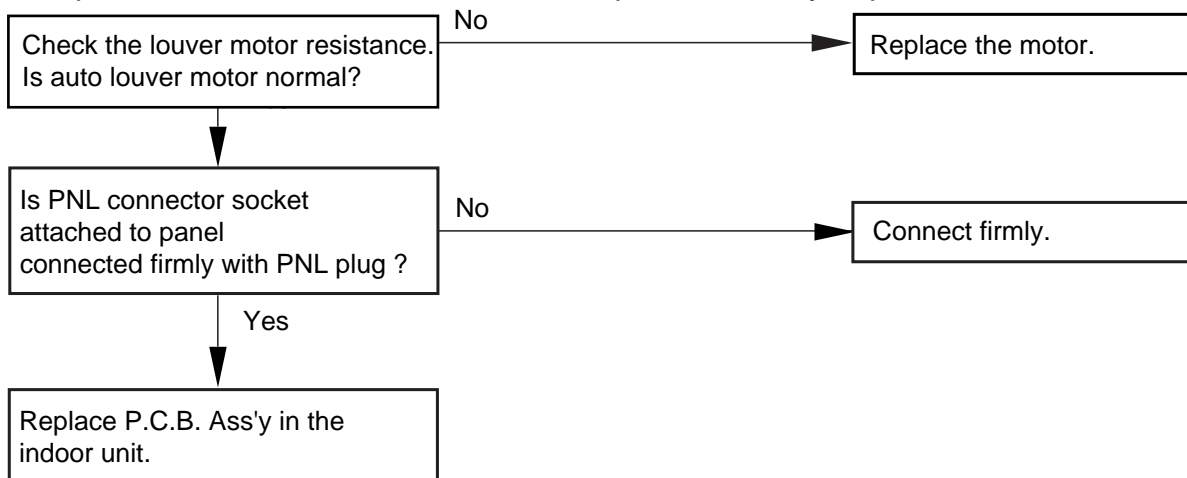

2101\_M\_S

3) Flap does not operate, when you press  button. (When you press SWEEP button, flap operates.)

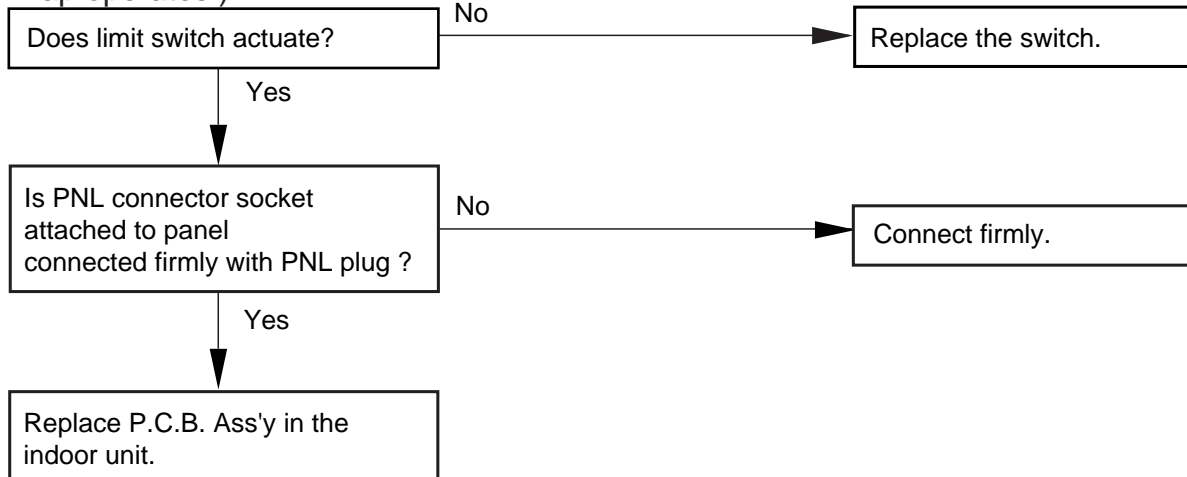

2102\_M\_S

SM830082

4) Compressor motor does not operate.

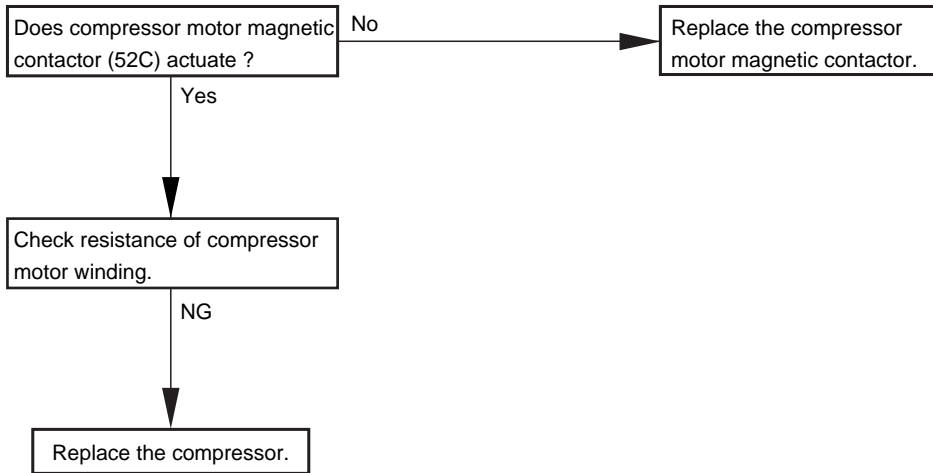

0461\_M\_1

5) Outdoor fan does not operate.

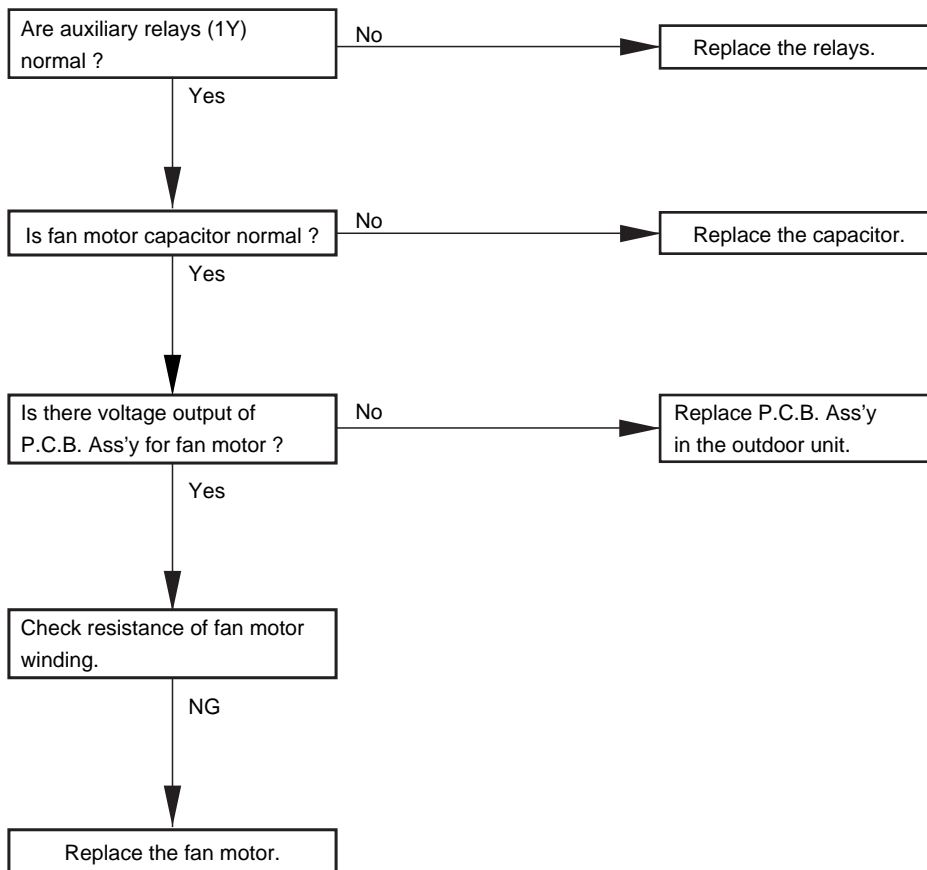

1148\_THS\_1

4



### (7) Service Functions of Optional Wired Remote Controller

From the remote controller you can control both the operation and settings of the unit as well as perform several useful service checks. This section explains how to use the remote controller on the following items from (A) to (I).

- (A) Use the test run procedure.
- (B) Check the sensor temperature readings.
- (C) Accessing the service problem history.
- (D) Check the remote controller itself for correct operation.
- (E) Excute the auto. address operation.
- (F) Confirm and change the indoor unit address.
- (G) Change the shift temperature in heating mode
- (H) Set the indoor unit address.
- ( I ) Change the period of the filter timer

#### (A) Use the test run procedure

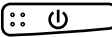
- Ⓐ After holding down the remote controller  button for 4 seconds or more, press the  button.
  - While the test is running, "TEST" shows on the LCD display.
  - In "TEST" mode, the temperature cannot be adjusted. Do not use this mode except during test run operation.
- Ⓑ Use "TEST" mode in either heating or cooling operation mode.

#### NOTE

The outdoor unit will not start running for approximately 3 minutes after the power is turned on or the unit is turned off.

- Ⓒ When the unit is not operating normally, a code will be displayed on the remote controller LCD. Refer to the Table of Self-Diagnostic Functions at "- - -", and take the corrective measures indicated.
- Ⓓ After completing the test run operation, press the  button again and check to see that "TEST" is no longer displayed on the remote controller LCD.  
(The remote controller is equipped with a timer that terminates test run operation after 60 minutes in order to prevent continuous test run operation.)

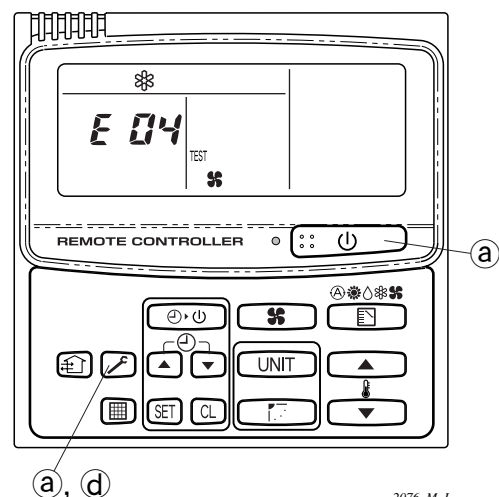

Fig. IV-3





2076\_M\_1

### (B) Check the sensor temperature readings

The air conditioner has thermo sensors which are used to control the unit.

- ❑ Each sensor has an address which is made up of the indoor unit address, and the sensor address. The indoor unit address is used only when several units are hooked up to one remote controller (group control). If there is only one unit, made up of one indoor and one outdoor unit, then only the sensor address should be put in, as shown in the procedure below.

Follow this procedure to display the temperature of each sensor:

- ① On the remote controller, press both  and  buttons at the same time for more than 4 seconds. (Ref. Fig. IV-4)
  - ② The UNIT No., the address and temperature of the sensors instead of its usual information will flash on the display.
- ❑ Following example shows the UNIT No. (Indoor unit address) is fixed at **01- 01**.
  - ❑ In case of group control, select the UNIT NO. (Indoor unit address) which you want to check with  button.
  - ❑ Each time you press the  button you can select a different sensor, and the display shows the sensor address and temperature as shown Fig. IV-4.

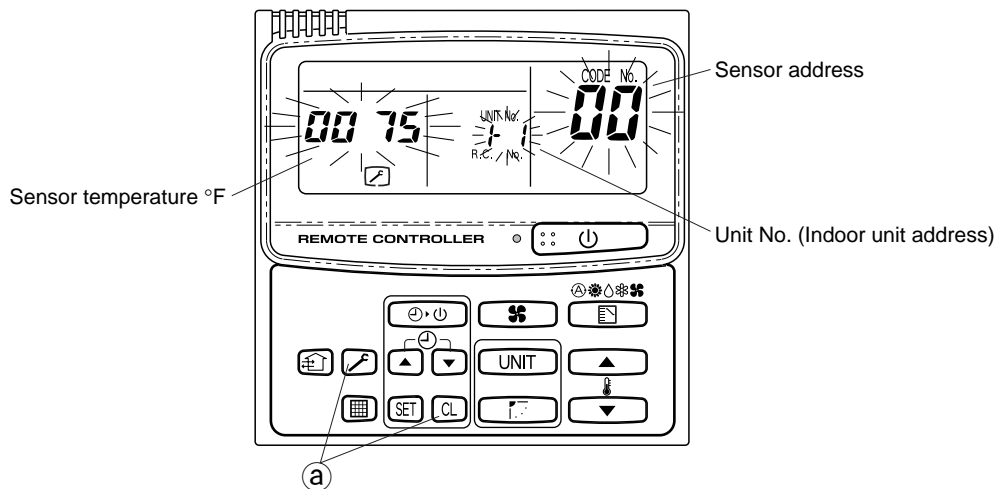

Fig. IV-4

1929\_M\_I

Refer to the table below for the relationship between the sensor address and the location of the sensor.

Relationship between the sensor address and the location of sensor

Sensor Address (CODE No.)		Location of Sensor (Themistor)
Indoor Unit	00	A/C controlled room Temp.
	01	Remote controller room Temp.
	02	Indoor air suction Temp.
	03	Indoor coil Temp. (E1)
	04	Indoor coil Temp. (E2)
	05	Indoor coil Temp. (E3)
	06	—
	07	—
	08	Indoor electronic expansion valve Temp.
	09	—
Outdoor Unit	0A	Discharge gas Temp.
	0B	—
	0C	—
	0D	Outdoor coil liquid Temp. (C2)
	0E	Outdoor coil liquid Temp. (C1)
	0F	—
	10	—
	11	—
	12	—
	13	—
14	—	

**NOTE**





In case there are no sensor equipped with the unit, “- -” is shown on the display.

© Resetting the remote controller display to previous mode.

- To reset the display, press  button, then the remote controller will return to previous mode.



**(C) Accessing the service problem history**

The gist of past service problems can be recalled.

- (a) Press the  and  buttons simultaneously for 4 seconds or more to enter the service check mode. The term “CHECK SERVICE” will be illuminated and code No. 01 will be displayed at first. Then the most recent alarm message will be displayed, showing the number of the indoor unit that generated the alarm and the nature of the alarm.
- (b) In order to monitor more of the service problem history, press the SET TEMP ,  () button. This will change the service problem history number (code number). Code number 01 (most recent)...code number 04 (oldest)

**NOTE**

The service problem history keeps four problems in memory.

- © Pressing the  button will clear the entire indoor unit alarm history. Pressing the  button will restore the normal operating display.

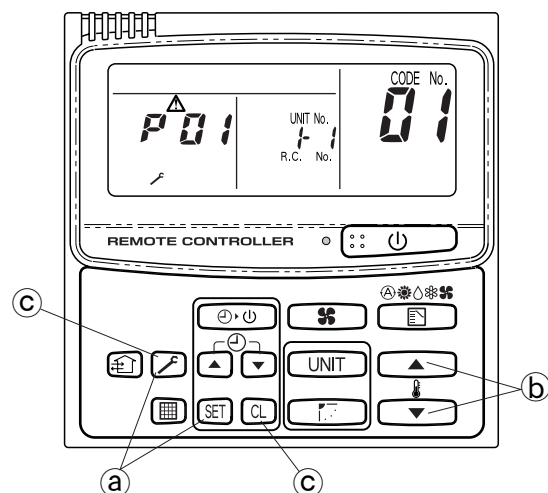

Fig. IV-5

2081\_M\_1

### Important

Never press **CL** (clear) button unless you want to erase the accessed data in memory. Follow the procedure below only when erasing is necessary.

- ❑ To erase accessed data, press the **CL** button.
- ❑ When erasing is finished,“----” mark appears on the controller’s display.



After checking the alarm messages, be sure to press the **OK** button.

### (D) Check the remote controller itself for correct operation

The remote controller has a self-diagnostic function to check for problems in the remote controller itself.

In order to check, the shorting plug (2P) inserted in the socket (4P) on the back of the remote controller circuit board should be moved from RCU.Main to RCU.CK. (Ref. Fig. IV-6)

### NOTE

- 1) Be sure that the shorting plug is inserted onto RCU.Main during normal operation.
- 2) The remote controller self-diagnostic function can be run on a remote controller independently if power of 9–16 VDC is supplied to plug 2P as shown in Figure IV-6. (A 12-Ω 1/4-W resistor must be placed in between.)

#### ● Checking serial communications

The remote controller’s own serial communications sending and receiving circuits can be checked by moving the shorting plug. The indicators will respond as follows for approximately 10 seconds, then turn off:

Correct : All indicators light up.

Incorrect : All indicators flash on and off.

#### ● Checking I/O circuits

After completing the serial communications check (for 10 seconds), operate each switch on the remote controller. If the LCD display responds, then the remote controller is normal.

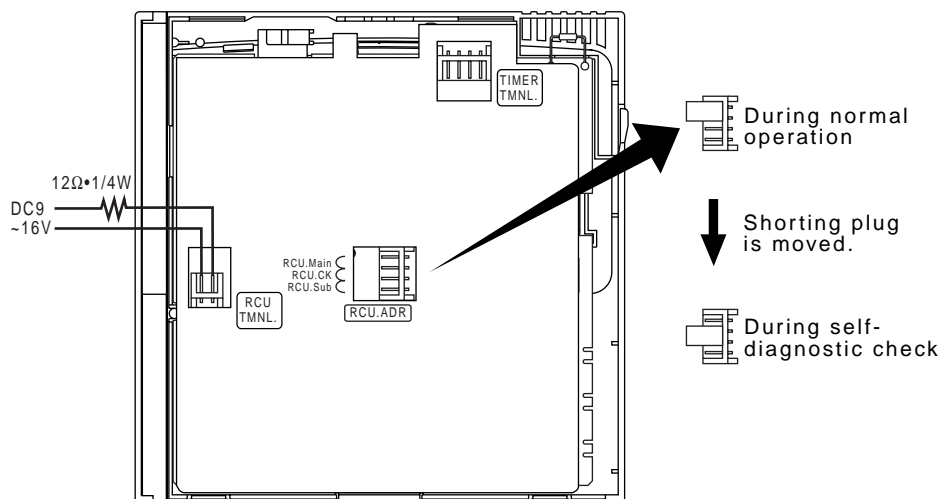

Fig. IV-6

2079\_M\_1

### Important

Never press **CL** (clear) button unless you want to erase the accessed data in memory. Follow the procedure below only when erasing is necessary.

- ❑ To erase accessed data, press the **CL** button.
- ❑ When erasing is finished, "----" mark appears on the controller's display.



After checking the alarm messages, be sure to press the **OK** button.

### (E) Execute the auto. address operation

- ❑ **Auto. address operation is executed by pressing the A. ADD (S1) button of outdoor unit's PCB usually.**  
For your convenience it can be executed by remote controller also.

- a Press the **OK** and **▲** ( **⊕** ) buttons at the same time for more than 4 seconds. (Fig. IV-7)
- b Set CODE No. A1 with **▲** , **▼** ( **⊕** / **⊖** ) button.

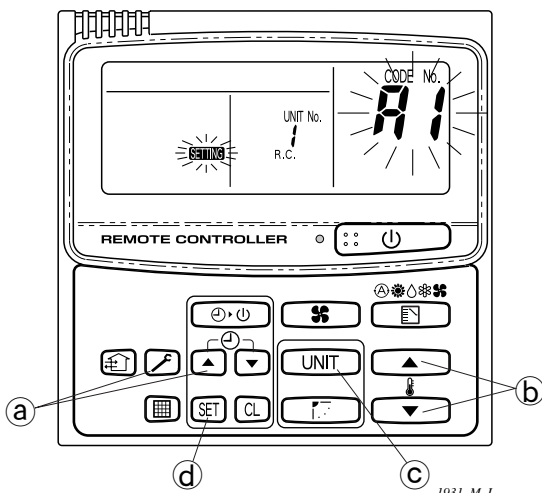















Fig. IV-7

In this mode, the auto. address operation is executed at each R.C. (Refrigerant Circuit) line one by one.

- c Select R.C. No. which you want to execute the auto. address operation with **UNIT** button.
- d Press the **SET** button. The auto. address operation will start. CODE No. changes from flashing to ON state.
- e If an error occurs during operation, the alarm message will be displayed. Check and remove the cause. If you want to stop the operation, press the **CL** button then the unit stands in waiting mode (Press the **SET** button again.)
- f If the automatic address operation finishes, the display will disappear.
- g Execute the operation of the other R.C. line in the same way by following the above steps c to d .

**(F) Confirm and change the indoor unit address (Ref. Fig. IV-8, IV-9)**

□ The purpose of the above function is to let you confirm the indoor unit address after the auto. address operation, and change the indoor unit address if it is needed.

- (a) Press the  and  (  ) buttons at the same time for more than 4 seconds.
- (b) Select the R.C. No. which you want to change with the  (up) or  (down) buttons.
- (c) Press the  button (to confirm the R.C. No.).  
The smallest registered indoor No. and the selected R.C. No. will be displayed.
- (d) Select the indoor No. which you want to change with  button. Once in this mode, **the fan motor of selected indoor unit will turn on and let you confirm the indoor unit address.**
- (e) Set the required new indoor unit's No. by pressing the  ,  (  ) button.
- (f) Press the  button.  
UNIT No, SET DATA (0001) and  changes from flashing to ON state.
- (g) If you made a mistake, press the  button.
- (h) Finally, press the  button.
- (i) If you want to change the indoor unit address of the other R.C. No., follow the step (a) to (h) in the same way.

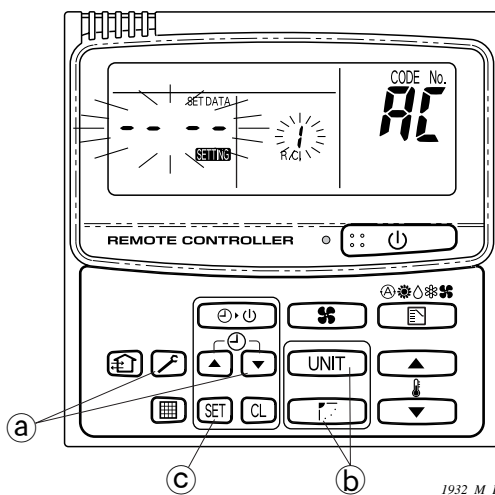

Fig. IV-8

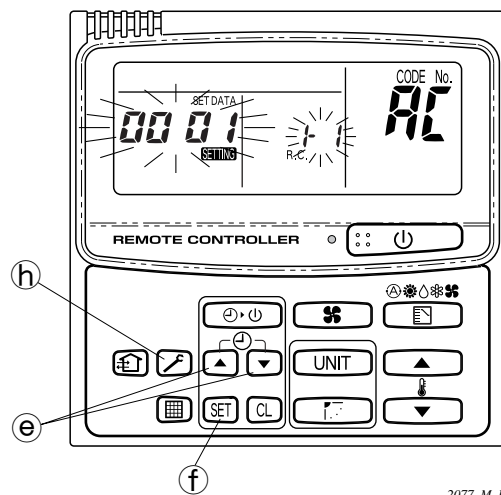

Fig. IV-9

**(G) Change the shift temperature in heating mode (Ref. Fig. IV-10)**

- ❑ If the indoor unit is installed at high location (ex. ceiling level), the thermostat tends to turn off at heating mode because of the hot air temperature around ceiling level. In order to solve the problem, the shift temp. (valid while heating only) is set when shipped from factory.
- ❑ If the shift temp. is not enough (ex. the indoor unit is installed at position higher than 3 m), the shift temp. can be set with remote controller from 0 to +10 deg (°F) <from 0 to 20 deg (°F)>. manually as follows:
  - (a) Press the + buttons at same time for more than 4 seconds.
  - (b) In case of group control, if you want to change all units in group control collectively, proceed next step remaining ALL displayed. If you want to change a unit individually, select the indoor unit address (UNIT No.) with button.
  - (c) Select the CODE No. 06 with , ( ) button.
  - (d) Choose the shift temp with , ( ) button.
  - (e) Press the button. CODE No. 06, SET DATA and change from flashing to ON state.
  - (f) If you made a mistake, press the button.
  - (g) Finally, press the button.

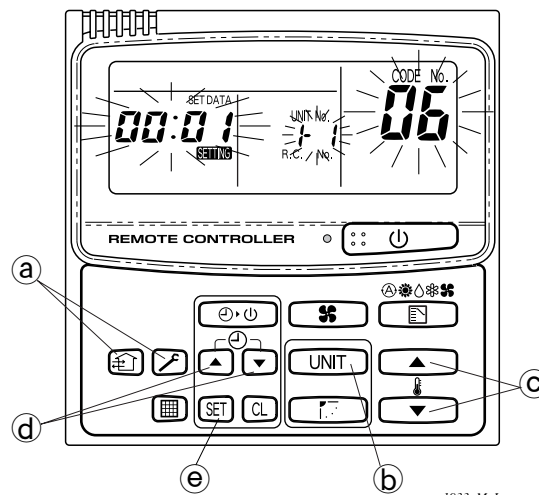

Fig. IV-10











**(H) Set the indoor unit address (Ref. Fig. IV-11, IV-12)**

- ❑ This function is usable if the auto. address operation is not available. Indoor unit address can be set one by one by remote controller in such case.









**NOTE**

- 1) In case of group control, branch wiring for group control should be removed temporarily.
- 2) In case of remote controllerless system, remote controller should be connected with the indoor unit temporarily.











(Set the No. of R.C. address)

- (b) Press the ,  and  buttons at the same time for more than 4 seconds.
- (c) Set the **CODE No. 12** to set the No. of R. C. with the ,  (  ) button.
- (d) Set the No. of R. C. which you want to set with ,  (  ) button.
- (e) Press the  button.  
UNIT No., CODE No. 12,  and SET DATA (0002) change from flashing to ON state.

(Set the indoor address)

- (f) Select the **CODE No. 13** to set the indoor unit No. with the ,  (  ) button.
- (g) Set the indoor unit No. which you want to set with the ,  (  ) button.
- (h) Press the  button.  
UNIT No., CODE No. 13,  and SET DATA (0004) change from flashing to ON state.

(Set the group address)

- (i) Select the **CODE No. 14** to set group setting with the ,  (  ) button.
- (j) Set the No. of group setting with the ,  (  ) button.
- (k) Press the  button.  
UNIT No., CODE No. 14,  and SET DATA change from flashing to ON state.
- (l) If you made a mistake, press the  button so that setting returns to the initial state.
- (m) Press the  button to finish this mode.  
The display is disappeared.
- (n) Confirm the indoor unit address (UNIT No.) with the  button after pressing the **ON / OFF** button.
- (o) In case of group control, be sure to restore the branch wiring to its original wiring. In case of remote controller-less system, remove the remote controller.



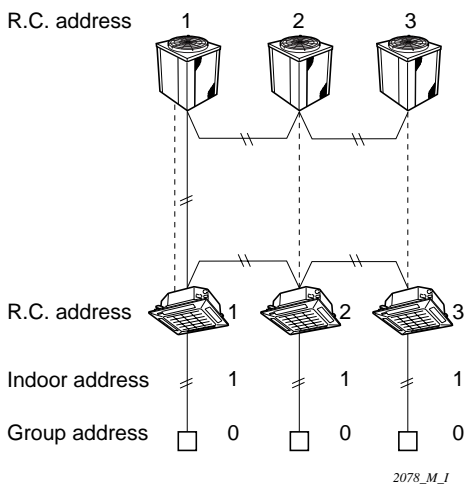

Fig. IV-11

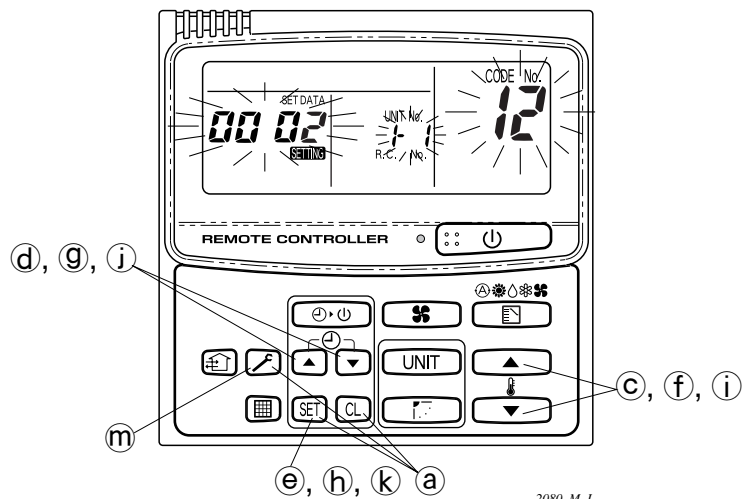

Fig. IV-12

### (I) Change the period of the filter timer (Ref. Fig. IV-13)

- ❑ If the period of filter timer is not suitable (for example in case of dirty environment), the period can be shortened to half as follows:

- a Press the + buttons at same time for more than 4 seconds.
- b In case of group control, if you want to change all units in group control collectively, proceed next step remaining "ALL" displayed. If you want to change a unit individually, select the indoor unit address (UNIT No.) with button.
- c Select the CODE No. 02 with , ( ) button.
- d Change the No. from 0000 to 0001 with , ( ) button.
- e Press the button. CODE No. 06, SET DATA and change from flashing to ON state.
- f If you made a mistake, press the button.
- g Finally, press the button.

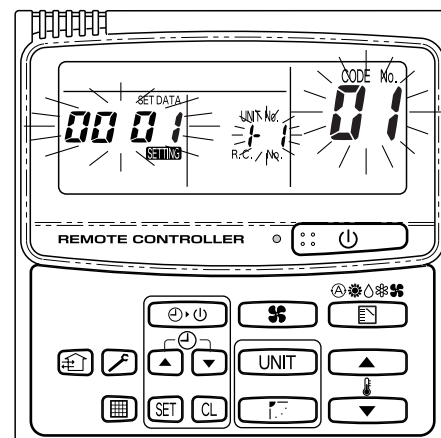

Fig. IV-13

## 4-2 Checking the Electrical Components

### (1) Measurement of Insulation Resistance

- The electrical insulation is acceptable when the resistance exceeds 1 MΩ.

#### ① Power Supply Wires

Clamp the earthed wire of the Power Supply wires with a lead clip of the insulation resistance tester and measure the resistance by placing a probe on either of the power wires. (Fig. IV-14)

Then measure the resistance between the earthed wire and the other power wires. (Fig. IV-14)

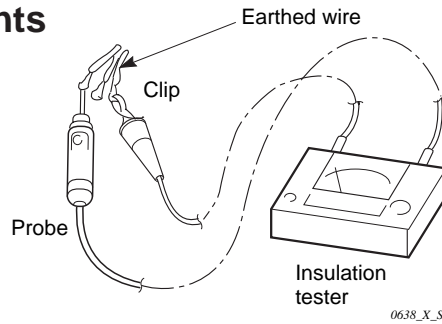

Fig. IV-14

#### ② Indoor Unit

Clamp an aluminum plate fin or copper tube with the lead clip of the insulation resistance tester and measure the resistance by placing a probe on the terminal plate (Fig. IV-15)

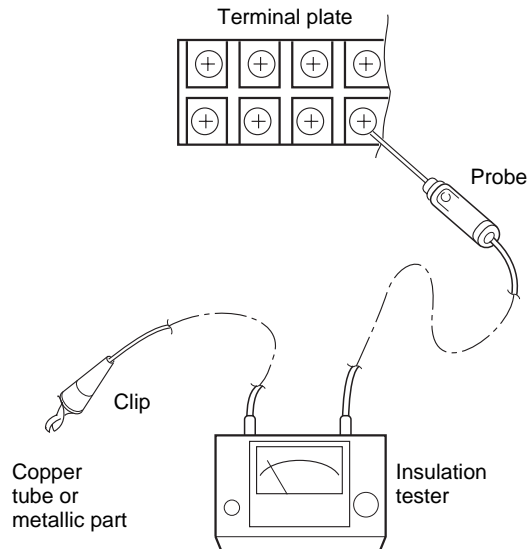

Fig. IV-15

#### ③ Outdoor Unit

Measure the resistance by placing a probe on the terminal plate in the same manner as explained above ②. (Fig. IV-15)

#### ④ Measurement of Insulation Resistance for Electrical parts

- Disconnect the connector of the desired electric part from terminal plate, P.C.B. Ass'y, etc. (Fig. IV-16)
- Similarly, disconnect the lead wires from compressor, capacitor, etc. (Fig. IV-17)
- Measure the resistance in the same manner as illustrated on the right.

Refer to Electrical Wiring Diagram.

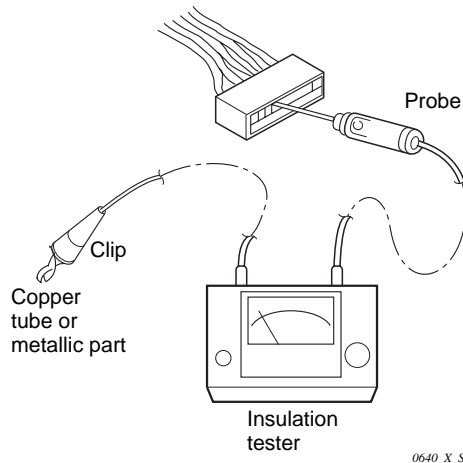

Fig. IV-16

#### NOTE

If the probe does not enter the hole because the hole is too narrow, use a probe with a thinner pin.

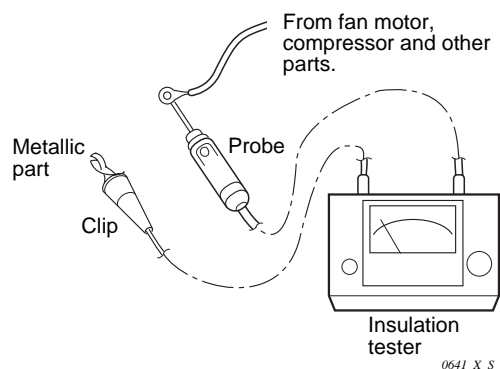

Fig. IV-17

### (2) Checking the Protective Devices

- Disconnect the connector, which consists of P (plug) and S (socket) when you want to check the protective device.
- Then check continuity among plug's (and/or socket's) terminal as in **Fig. IV-18**.
- Normality of the protective device can be judged by the following table.  
The Protective Device is proved normal if there is a continuity between terminals.

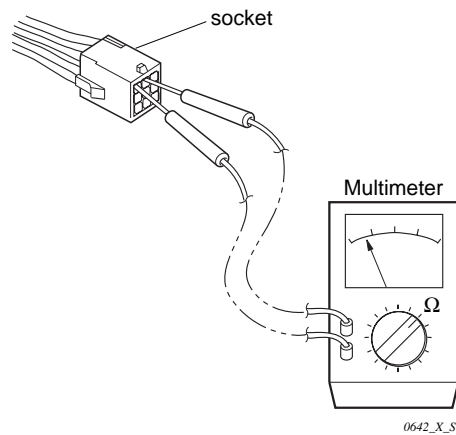

Fig. IV-18

- ① **Indoor fan motor thermal protector (49FI) . . . . . Indoor unit**
  - Disconnect the connector which leads to the indoor fan motor (FMI).
  - Check the socket's terminals.
- ② **Compressor motor thermal protector . . . . . Outdoor unit**
  - Disconnect the wires from terminals of compressor.
  - Check the terminals of compressor.
- ③ **Outdoor fan motor thermal protector (49FO) . . . . . Outdoor unit**
  - Disconnect both the connector which leads to the outdoor fan motor (FMO).
  - Check socket's terminal.

**(3) Checking the Electrical Parts**

① **Power transformer (TR1) ..... Indoor unit** \*Measure the coil resistance.

- Primary 230-208V ; Measure the resistance between No.1 and No.3 (WHT lead wires) terminals of 3P (WHT) socket connected to power transformer.
- Secondary 14.8V ; Measure the resistance between No.1 and No.2 (RED lead wires).  
14.8V ; Measure the resistance between No.3 and No.4 (BRN lead wires).

Refer to “1-3 Other component specifications”.

② **Power transformer (TR) ..... Outdoor unit** \*Measure the coil resistance.

- Primary 230-208V ; Measure the resistance between No.1 and No.3 (WHT lead wires) terminals of 3P(WHT) socket jointed to power transformer.
- Secondary 14 V ; Measure the resistance between No.1 and No.2 (BRN lead wires).

Refer to “1-3 Other component specifications”.

③ **Indoor fan motor (FMI) ..... Indoor unit** \*Measure the coil resistance.

- Measure the resistance between each terminal of 9P (WHT) socket connected to the indoor fan motor.

Refer to “1-2-(A) Major component specifications”.

④ **Outdoor fan motor (FMO) .....Outdoor unit** \*Measure the coil resistance.

- Measure the resistance in the same manner as explained above ③.

Refer to “1-2-(B)Major component specifications”.

⑤ **Motor capacitor ..... Both in indoor and outdoor unit**

- Remove the lead wires from the capacitor terminals, and then place a probe on the capacitor terminals as shown in **Fig. IV-19**. Observe the deflection of the pointer, setting the resistance measuring range of the multimeter to the maximum value.
- The capacitor is “good” if the pointer bounces to a great extent and then gradually returns to its original position.

**NOTE**

The range of deflection and the deflection time differ according to the capacity of the capacitor.

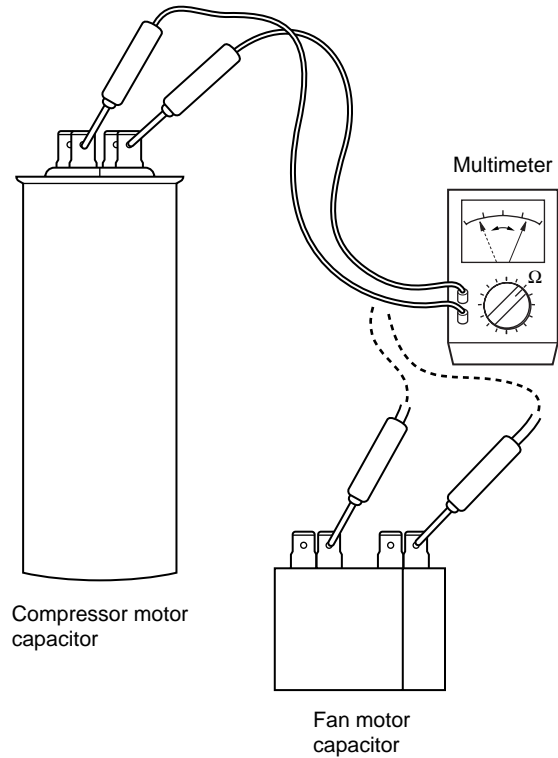

1041\_X\_S

**Fig. IV-19**

⑥ **Continuity of fuse on P.C.B. Ass’y**

- Check for continuity using a multimeter as shown in Fig. IV-20.

**NOTE**

**Method Used to Replace Fuse on PCB Ass’y**

1. Remove the PCB Ass’y from the electrical component box.
2. Remove the fuse from PCB Ass’y using pliers while heating the soldered leads on the back side of the PCB Ass’y with a soldering iron (30W or 60W). (Fig. IV-21)
3. For replacement, insert a fuse of the same rating to the intended position and solder it. (Allow time to radiate heat during soldering so that the fuse does not melt.)

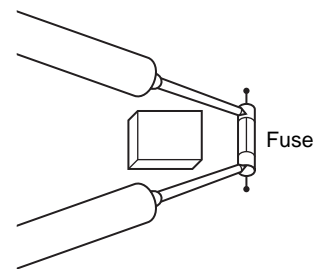

1042\_X\_S

**Fig. IV-20**

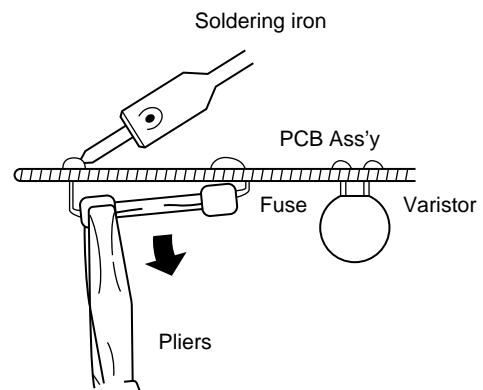

1043\_X\_S

**Fig. IV-21**



**CAUTION**

**When replacing the fuse, be sure not to break down the varistor.**

⑦ **Solenoid coil of the electronic refrigerant control valve (ERCV) ..... Indoor unit** \*Measure the coil resistance.

- Measure the resistance between No. 5 (GRY lead wire) and other terminals (another color of lead wires) of 5P (WHT) plug connected to the solenoid coil.

Refer to “1-2-(A) Major component specifications”.

⑧ **Compressor motor (CM) ..... Outdoor unit** \*Measure the coil resistance.

- **In case of single -phase compressor**

Remove the cover of compressor terminal and measure the resistance between terminals.

Refer to “1-2 Major component specifications”.

⑨ **Compressor motor magnetic contactor (52C) ..... Outdoor unit**

- Measure the resistance between A (ORG lead wire) and B (GRY lead wire) terminals on the compressor motor magnetic contactor.

Refer to “1-3 Other component specifications”.

- Check the continuity between contactors.

MODEL	FMCA-1UL			
Push button on the magnetic contactor	Pair of terminals			
	R – U	S – V	T – W	31 – 32
no press	—	—	—	YES
press	YES	YES	YES	—

⑩ **Solenoid coil of 4-way valve (20S) ... Outdoor unit** \*Measure the coil resistance.

- Measure the resistance between No.1 (BLK lead wire) and No.2 (BLK lead wire) terminals of 2P (BLK) socket connected to the solenoid coil.

Refer “1-3 Other component specifications”.

(4) Thermistor Characteristic Curv

(1) Room temp. sensor : TH1 (KTEC-35)

(2) Indoor heat exch. coil sensor : TH2(E1), TH3(E2)  
 Outdoor heat exch. coil sensor : TH6(C1), TH7(C2)

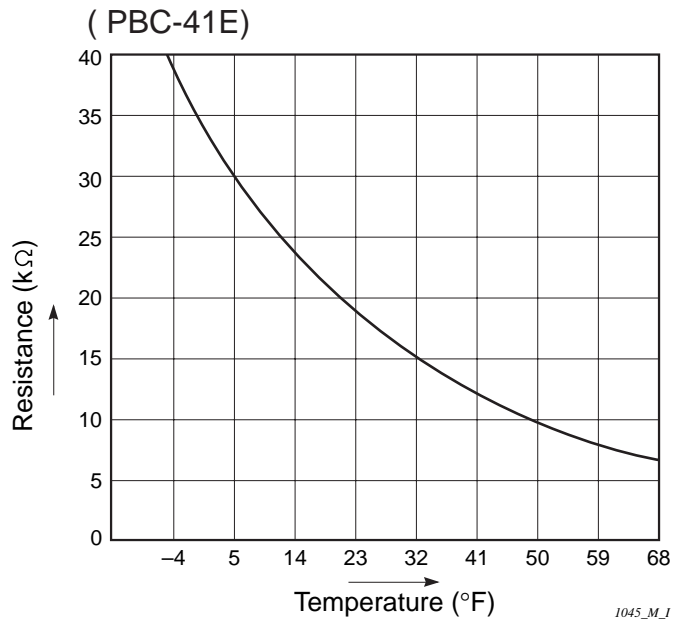
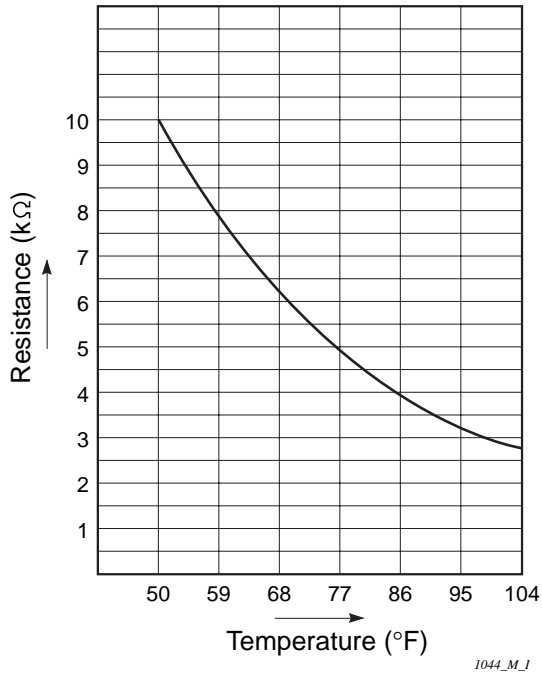

(3) Compressor discharge gas temp. sensor : TH8 (PTC-51H)

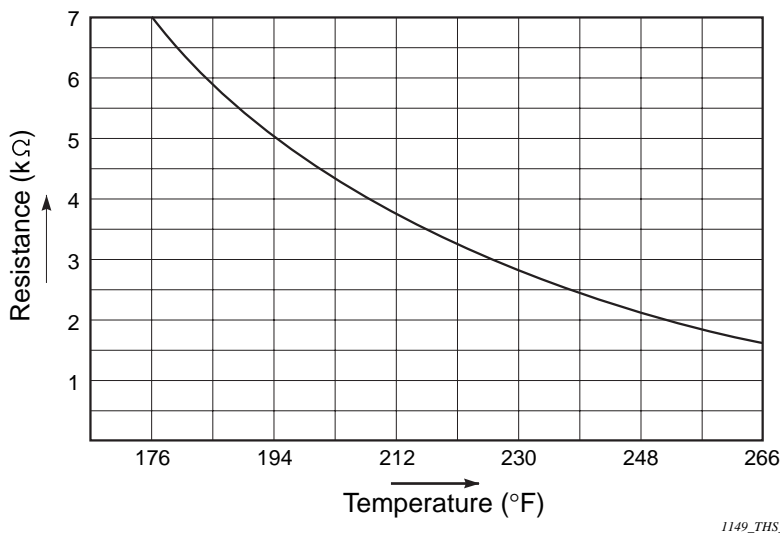

### (5) PCB Setting

#### ● Setting of outdoor control PCB

##### (A) Standard control (single outdoor unit)

In case of single outdoor unit installation, even if in case of twin, triple or quartet type (2, 3 or 4 indoor units), no setting necessary.

Keep factory shipment state (R.C. address is set in "0").

In this case, auto. address operation takes place automatically for the first time when the power is switched on. This takes about a few minutes.

##### (B) Group control (Multiple outdoor units)

In case of group control (up to 8 indoor units can be connected with one remote controller), before turning the power supply on set the R.C. address with S2, S3 on the outdoor control PCB.

R.C. address: Refrigerant circuit address 1 ~ 30.

##### (C) Central control (when using the system controller)

In case of central control (when using the system controller, that is, when linking outdoor units in a network),

- (a) Before turning the power supply on, set the R.C. address with S2, S3 on the outdoor control PCB.
- (b) Remove the short plug (CN006, 2P Black) from all outdoor units except any one of outdoor unit.

#### ● Setting of indoor control PCB

No setting necessary.

Each indoor unit address (UNIT No.: R.C. – No.) is decided after auto. address operation.

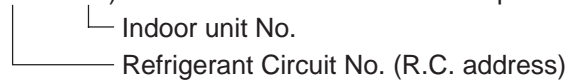

Manual setting for indoor unit address can be performed also by remote controller.





(6) R.C. Address Setting Method

Outdoor unit R.C. address setting method

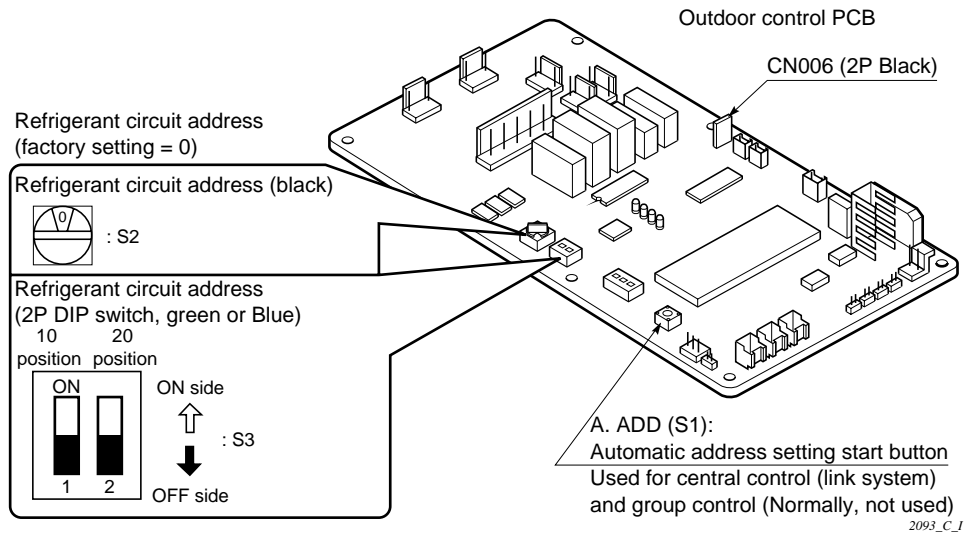
In case of group control or central control, set the R.C. address to 1, 2, 3, ... according to the No. of outdoor units.

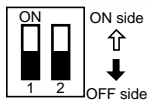















R.C. address	R.C. address (S3 2P dip switch, green or blue)	R.C. address (S2 Rotary switch, Black)
00 auto address ("0" when shipped from factory)	Both OFF 	 Set to 0

### (7) Automatic Address Setting Method

— For group control and central control with multiple outdoor units —

#### Carry out automatic address setting with the remote controller.

- (1) All auto. address operation
  - ① Press the  and  (  ) buttons at the same time for more than 4 seconds.
  - ② Press the  button after confirming the CODE No. AA (CODE No. AA: All Auto. address operation).  
  
After addresses are automatically set in order for the outdoor units from No. 1 to No. 30, the system returns to the normal stopped state.
- (2) Individual auto. address operation for each refrigerant circuit
  - ① To select each refrigerant circuit individually and set addresses automatically, press the  and  (  ) buttons at the same time for more than 4 seconds, then press the ,  (  ) button once to set CODE No. A1. (CODE No. A1: Auto. address operation)
  - ② Select R.C. No. which you want to execute the auto. address operation with  button.
  - ③ Press the  button. The auto. address operation will start. CODE No. changes from flashing to ON state.
  - ④ If the error is happened during the operation, the alarm message will display. Check and remove the cause. If you want to interrupt the operation, press the  button then the unit stands in waiting mode (Press the  button).
  - ⑤ If the auto. address operation finishes, the display will disappear.
  - ⑥ Execute the operation of the other R.C. line in the same way by following the above steps ② to ③.
  - ⑦ Complete the auto. address operation by pressing the  button.

#### NOTE

Required time for auto. address operation:

In case of group control : a few minutes for each R.C.

In case of central control : max. about 20 min. for each R.C.

### (8) Displaying Indoor / Outdoor Unit Combination Numbers





Display the indoor / outdoor unit address after automatic address setting.

- (1) When installing multiple units, match the indoor unit address numbers and the outdoor R.C. address numbers and display them at an easy-to-check location (near the nameplate) with an oil-based magic marker or other indelible marker so that the individual indoor and outdoor unit combinations can be checked.

Example:

Outdoor Unit 1 – Indoor Units 1-1, 1-2, 1-3, ....

Outdoor Unit 2 – Indoor Units 2-1, 2-2, 2-3, ....

- (2) This is necessary for maintenance. Always label these.  
\*Check indoor unit address with the remote controller. Press the  button for at least 4 seconds and check the indoor unit address with the  button. (Each time you press the  button, the address changes 1-1, 1-2, ... 2-1, 2-2, ...) The fan for only the selected indoor unit turns on at high speed, so check which indoor unit runs and label the indoor unit address. (If there is 1 outdoor unit, the addresses are 1-1, 1-2, ...)  
  
When you press the  button again, the system returns to normal remote control mode.

**(9) Items to Check Prior to Test Run**

- (1) Turn on the power supply switch more than 5 hours before in order to charge the crank case heater.
- (2) Fully open the outdoor service valve after making the leak inspection of field connected tubing, vacuuming, and gas charging if necessary.
- (3) Check the capacity code setting.
  - \* The factory setting is as shown in the table. Double check it.
  - \* The capacity code is set by S4 (green or blue, 4P DIP switch) on outdoor control PCB.

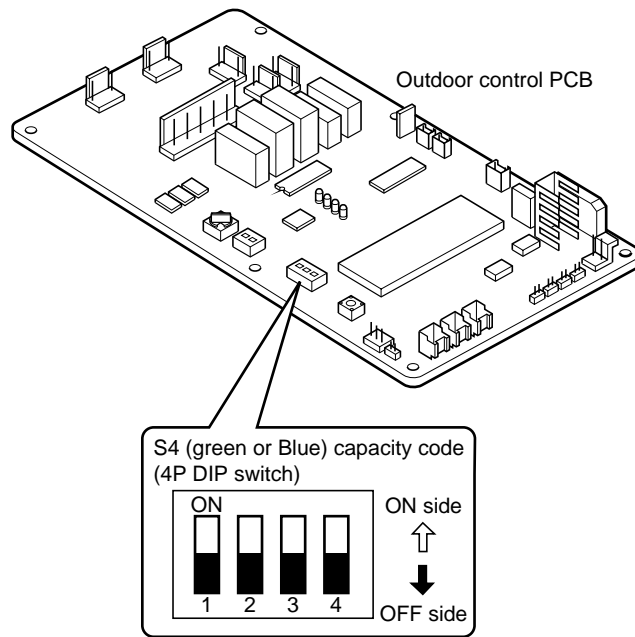

S4. Capacity code

Model No.	No.	Outdoor PCB			
		1	2	3	4
24 type		ON	ON	ON	OFF
36 type		OFF	ON	OFF	ON
48 type		ON	ON	OFF	ON

(10) Test Run

■ Preparing for Test Run

● Before attempting to start the air conditioner, check the following:

- (1) All loose matter is removed from the cabinet especially steel filings, bits of wire, and clips.
- (2) The control wiring is correctly connected and all electrical connections are tight.
- (3) The protective spacers for the compressor used for transportation have been removed. If not, remove them now.
- (4) The transportation pads for the indoor fan have been removed. If not, remove them now.
- (5) The power has been connected to the unit for at least 5 hours before starting the compressor. The bottom of the compressor should be warm to the touch and the crankcase heater around the feet of the compressor should be hot to the touch. (Fig. IV-22)
- (6) Both the wide and narrow tube service valves are open. If not, open them now. (Fig. IV-23)

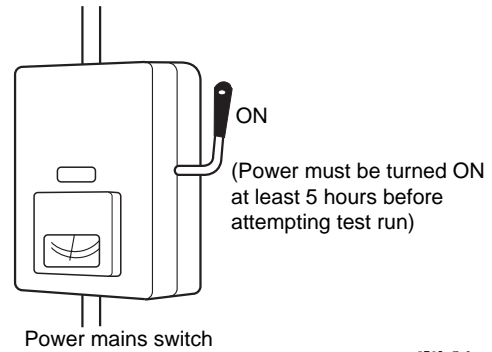

Fig. IV-22

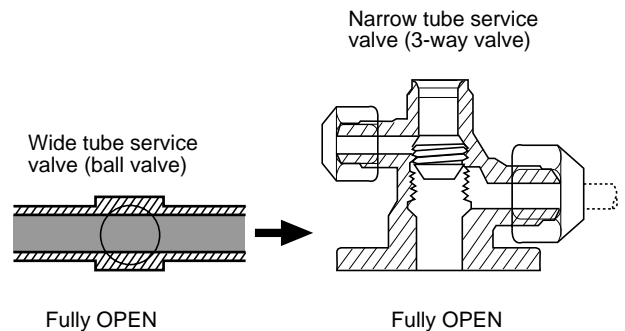

Fig. IV-23

● Test run procedure

- ❑ The purpose of the test run function is to let you control the operation of the unit directly without the thermostat turning the unit on or off. As indicated in the following procedure, switch out of TEST RUN when you are finished, or the air conditioner can be damaged because it will not cycle on and off normally.

- ❑ To protect the air conditioner from overloading, the outdoor unit will not start running for 3 minutes after power is applied or the unit is turned OFF.

- a Press the (TEST RUN) button on the remote controller. (Fig. IV-24)
- b Press the (ON / OFF operation) button to start the test run.
- c Press the (MODE) button to select either COOL or HEAT mode.
- d When the test run has started, "TEST" shows on display of the remote controller.
- e During the test run, the air conditioner runs continuously and the thermostat does not control the system.
- f After the test run, press the button once again to cancel this mode and check that "TEST" is not shown on the display.

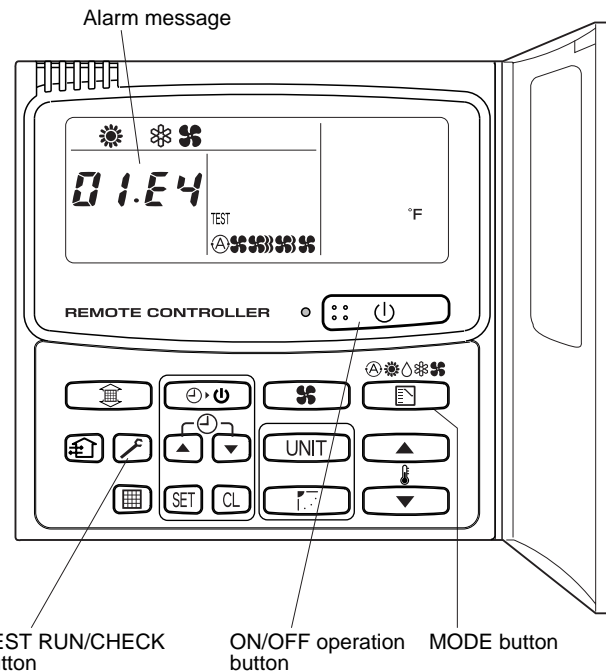
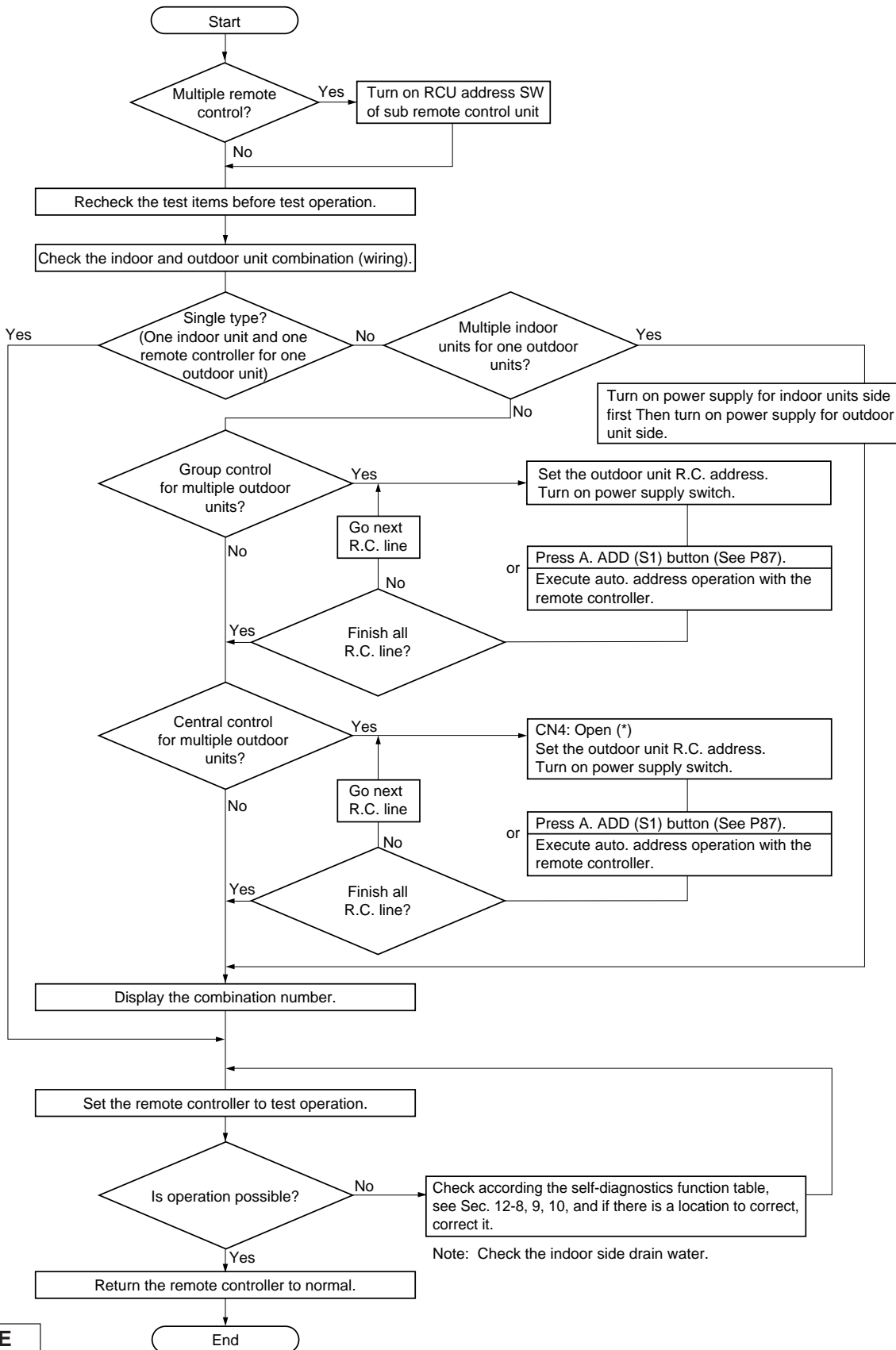

Fig. IV-24



**The TEST RUN button is used only for servicing the air conditioner. Do not press this button for normal operation, or the system may be damaged.**

● Test Run Procedure



**NOTE**

- 1) One of CN006 of all linked outdoor units should be short.
- 2) In case of using system controller, zone registration is required after finishing Test run. Regarding the zone registration, please refer to page 74 and 75.

2231\_M\_I

(11) PCBs and Their Location

● PCB (CR-TH2442) FOR INDOOR UNITS

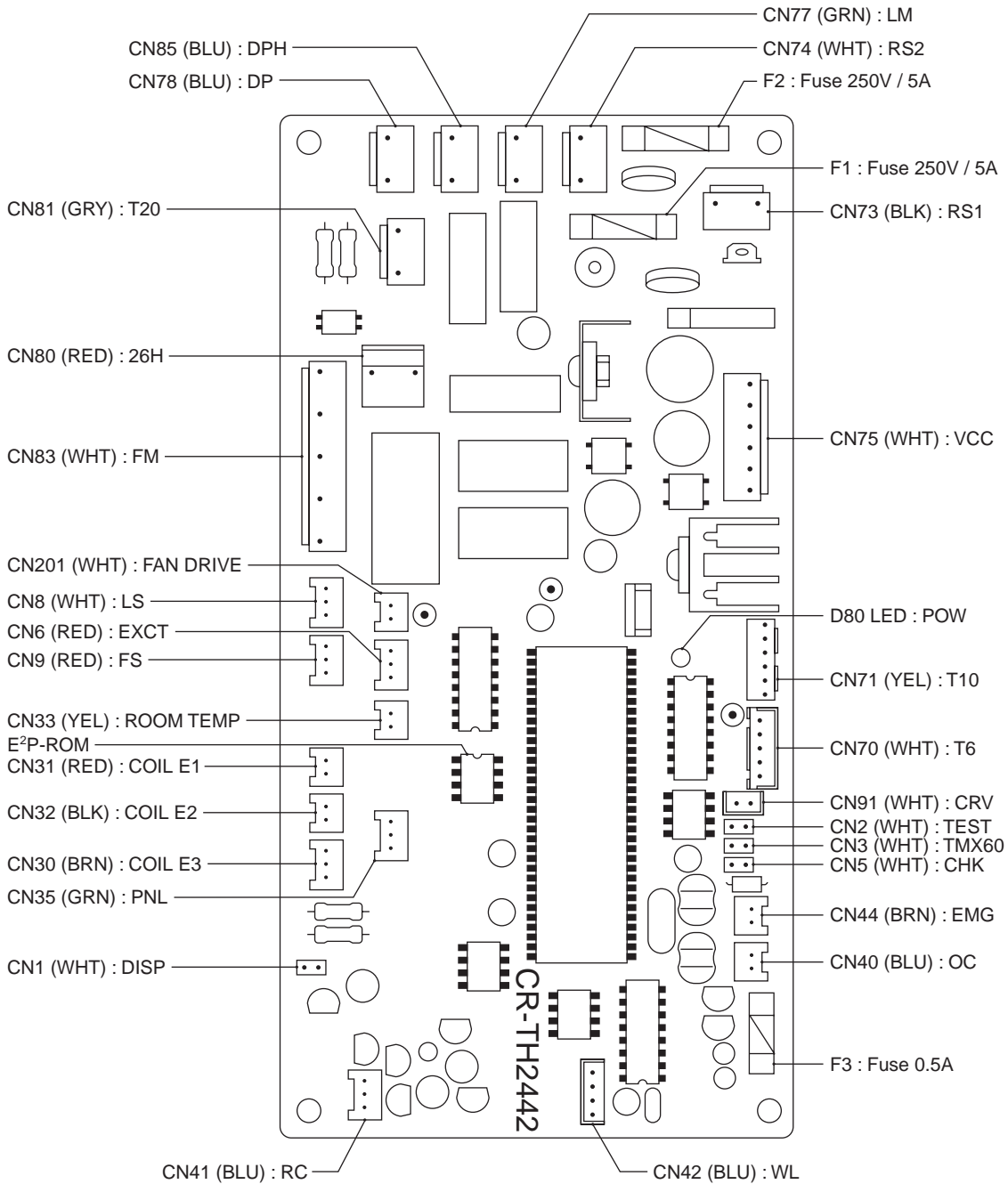

2124\_C.5

4

● PCB (CR-CH2442) FOR OUTDOOR UNITS

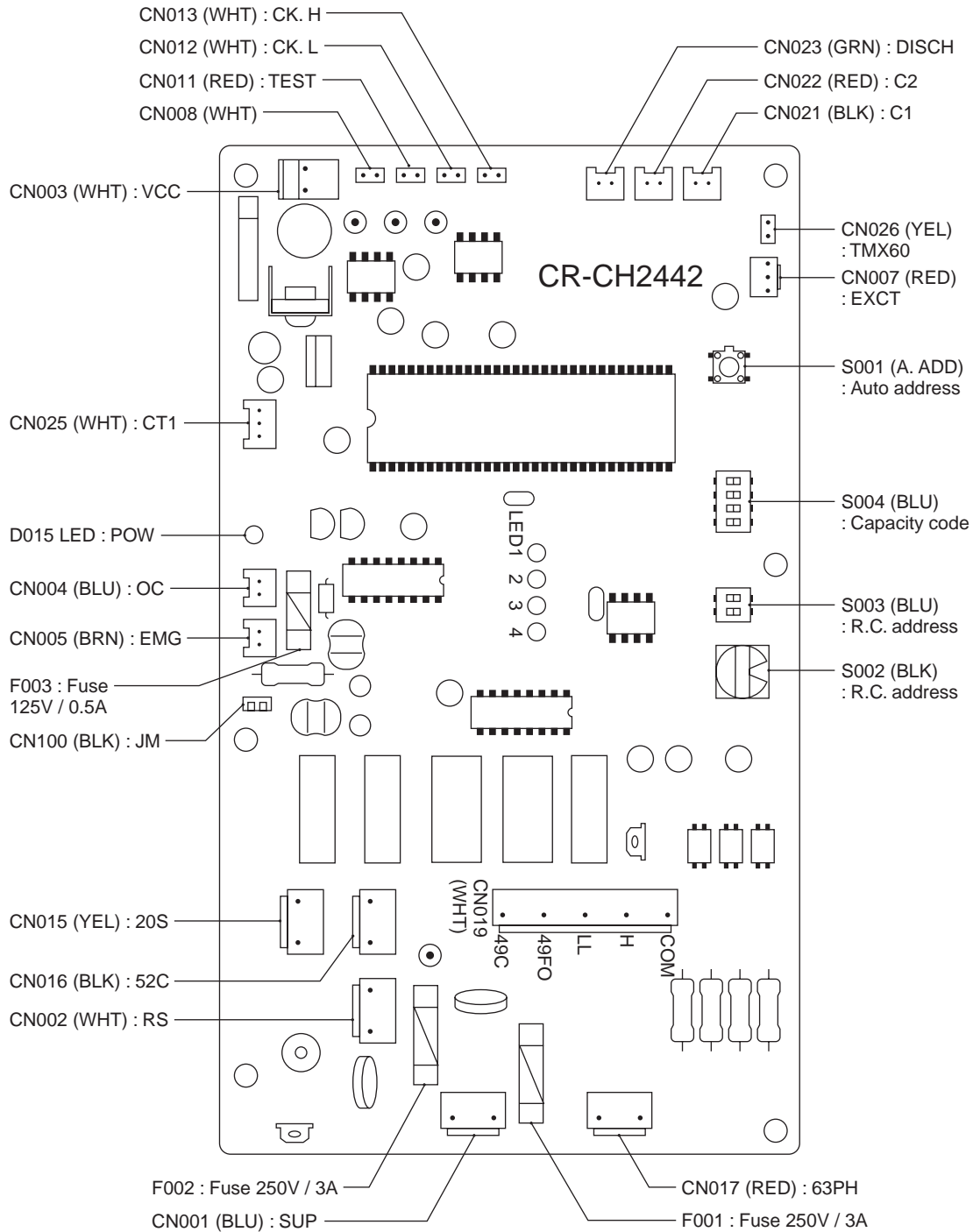

2178\_C\_1

**(12) Checking procedure for each PC Board**

The indoor and outdoor PCBs have functions to check the signal transmission and reception of the serial circuit and to check the microcomputer operation. (Self-diagnosis function)

● Precautions required when checking

1. After turning off the power to the indoor (outdoor) unit, remove the inter-unit control wiring (U1-U2) and create a short-circuit between U1 and U2.
2. Short the CHECK PIN on the PC board of the indoor (outdoor) unit and turn on the power.
3. When checking the Outdoor controller, remove the compressor wiring from the compressor electromagnetic contactor.

4-1. Checking the serial circuit

Indoor controller: A lighted LED indicates normal. A blinking LED indicates abnormal.

Outdoor controller: Blinking LEDs (D11 and D22) indicate normal. If one of the LEDs (D11 and D22) goes off, it indicates abnormal.

4-2. Checking microcomputer operation

When the microcomputer works normally, the relays are switched in sequence as below.

Indoor controller

	Output	ON time
Operation order	Indoor fan Very high fan speed (HH)	0.5 seconds
	Indoor fan High fan speed (H)	0.5 seconds
	Indoor fan Low fan speed (L)	0.5 seconds
	Indoor fan Very low fan speed (LL)	0.5 seconds
	Flap motor	0.5 seconds
	Drain pump	0.5 seconds
	Electric heater	0.5 seconds
	Operation signal	0.5 seconds
	In a lump	0.5 seconds
	Electronic control valve A	0.5 seconds
	Electronic control valve B	0.5 seconds
	Electronic control valve $\bar{A}$	0.5 seconds
Electronic control valve $\bar{B}$	0.5 seconds	

Outdoor controller

	Output	ON time
Operation order	Outdoor fan High fan speed (H)	0.5 seconds
	Outdoor fan Low fan speed (L)	0.5 seconds
	4-way valve	0.5 seconds
	Compressor	0.5 seconds



### (13) TMX60 pins

When shorting TMX60 pins on the indoor and outdoor PCBs, operations shown on the above table will be performed on each indoor and outdoor unit. Use TMX60 pins to perform a quick check.

#### NOTE

- When checking pin operation, stop the indoor and outdoor units with the remote control unit.

#### ■ Shorting CK.L or CK.H pin of the outdoor PCB

##### ● When shorting the cooling pin (CN8) with normal operation

- Relay RY3 is turned ON for 3 seconds → The outdoor fan motor operates at the “LL” fan speed.
- Relay RY4 is turned ON for 3 seconds → The outdoor fan motor operates at the “H” fan speed.
- Turn ON relay RY2 under the above condition → The magnet switch (52C) turns ON.

※ It will take about 18 seconds before cooling operation begins.

##### ● Shorting the heating pin (CN9) with normal operation

- Relays RY3 and RY4 are turned ON for 3 seconds → The outdoor fan motor operates at the “H” fan speed.
- Relay RY3 is turned ON for 3 seconds → The outdoor fan motor operates at the “LL” fan speed.
- Turn ON relay RY2 under the above conditions → The magnet switch (52C) turns ON. If relay RY1 is turned ON, the 4-way valve (20S) turns ON.

※ It will take about 18 seconds before heating operation begins.

#### NOTE

- The outdoor unit operates independently regardless of the indoor unit's operation. However, the outdoor unit does not defrost.
- The indoor and outdoor units stop when the outdoor protection apparatus activates during the checking operation, and automatically restarts, unlike in normal operation.

SANYO FISHER Service Company  
CENTRAL REGION

1739 Sands Place, Suite G  
Marietta, GA 30067  
Phone: (770) 951-8284  
Fax: (770) 951-2077

July. / '01

Printed in U.S.A.

## Free Manuals Download Website

<http://myh66.com>

<http://usermanuals.us>

<http://www.somanuals.com>

<http://www.4manuals.cc>

<http://www.manual-lib.com>

<http://www.404manual.com>

<http://www.luxmanual.com>

<http://aubethermostatmanual.com>

Golf course search by state

<http://golfingnear.com>

Email search by domain

<http://emailbydomain.com>

Auto manuals search

<http://auto.somanuals.com>

TV manuals search

<http://tv.somanuals.com>