

ECD-T1535

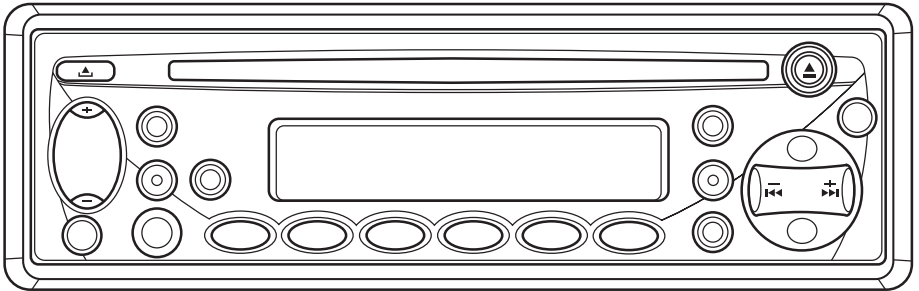

PLL Synthesized Stereo Radio with Digital Compact Disc Player

- 1 pair of RCA output
- CD-R/CD-RW Compatibility
- 4 preset Equalization
- Auxiliary Input

INSTALLATION

Notes:

- Choose the mounting location where the unit will not interfere with the normal driving function of the driver.
- Before finally installing the unit, connect the wiring temporarily and make sure it is all connected up properly and the unit and the system works properly.
- Use only the parts included with the unit to ensure proper installation. The use of unauthorized parts can cause malfunctions.
- Consult with your nearest dealer if installation requires the drilling of holes or other modifications of the vehicle.
- Install the unit where it does not get in the driver's way and cannot injure the passenger if there is a sudden stop, like an emergency stop.
- If installation angle exceeds 30° from horizontal, the unit might not give its optimum performance.

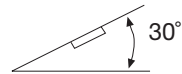

- Avoid installing the unit where it would be subject to high temperature, such as from direct sunlight, or from hot air, from the heater, or where it would be subject to dust, dirt or excessive vibration.

DIN FRONT/REAR-MOUNT

This unit can be properly installed either from “Front” (conventional DIN Front-mount) or “Rear” (DIN Rear-mount installation, utilizing threaded screw holes at the sides of the unit chassis). For details, refer to the following illustrated installation methods.

DIN FRONT-MOUNT (Method A)

Installation of the unit

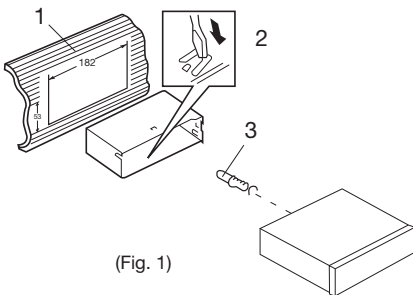

(Fig. 1)

1. Dashboard

2. Holder

After inserting the holder into the dashboard, select the appropriate tab according to the thickness of the dashboard material and bend them inwards to secure the holder in place.

3. Screw

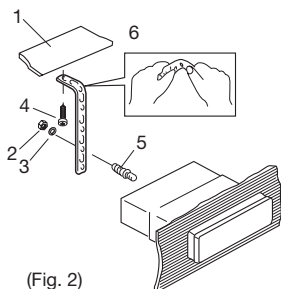

(Fig. 2)

1. Dashboard
2. Nut (5mm)
3. Spring washer
4. Screw (5 x 14mm)
5. Screw
6. Strap

Be sure to use the strap to secure the back of the unit in place. The strap can be bent by hand to the desired angle.

Removing the unit

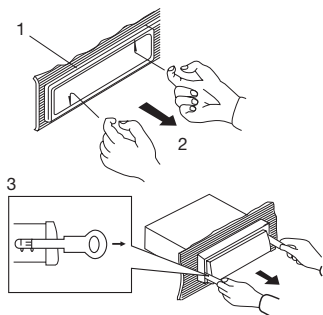

1. Frame
2. Insert fingers into the groove in the front of frame and pull out to remove the frame. (When reattaching the frame, point the side with a groove downwards and attach it.)
3. Lever
Insert the levers supplied with the unit into the grooves at both sides of the unit as shown in figure until they click. Pulling the levers makes it possible to remove the unit from the dashboard.

DIN REAR-MOUNT (Method B)

Installation using the screw holes on the sides of the unit.

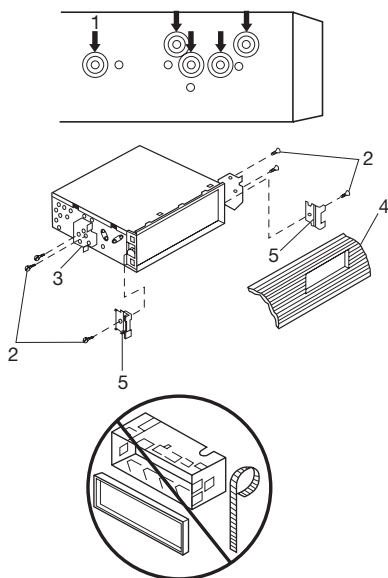

Fastening the unit to the factory radio mounting bracket.

1. Select a position where the screw holes of the bracket and the screw holes of the main unit become aligned (are fitted), and tighten the screws at 2 places on each side.
Use either truss screws (5 x 5mm) or flush surface screws (4 x 5mm), depending on the shape of the screw holes in the bracket.
2. Screw
3. Factory radio mounting bracket
4. Dashboard or Console
5. Hook (Remove this part)

Note: The mounting box, outer trim ring, and half-sleeve are not used for method B installation.

HOW TO REMOVE AND INSTALL THE FRONT PANEL (OPTIONAL)

1. Press the release button and pull-off the front panel.
Store front panel in the case.
2. To install the front panel, insert the panel into the housing and make sure the panel is properly installed, otherwise, abnormalities may occur on the display or some keys may not function properly.

REMOVING THE FRONT PANEL

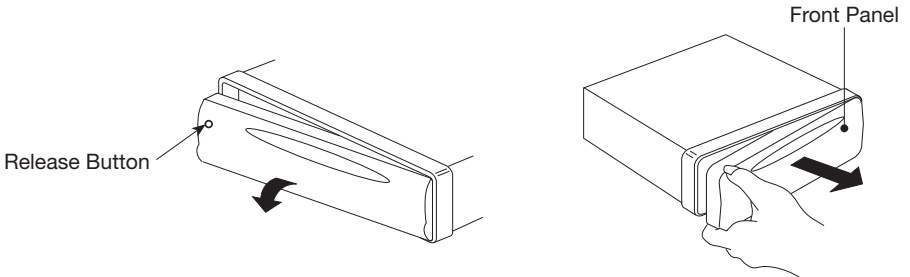

INSTALLING THE FRONT PANEL

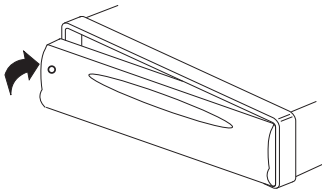

WIRING CONNECTION

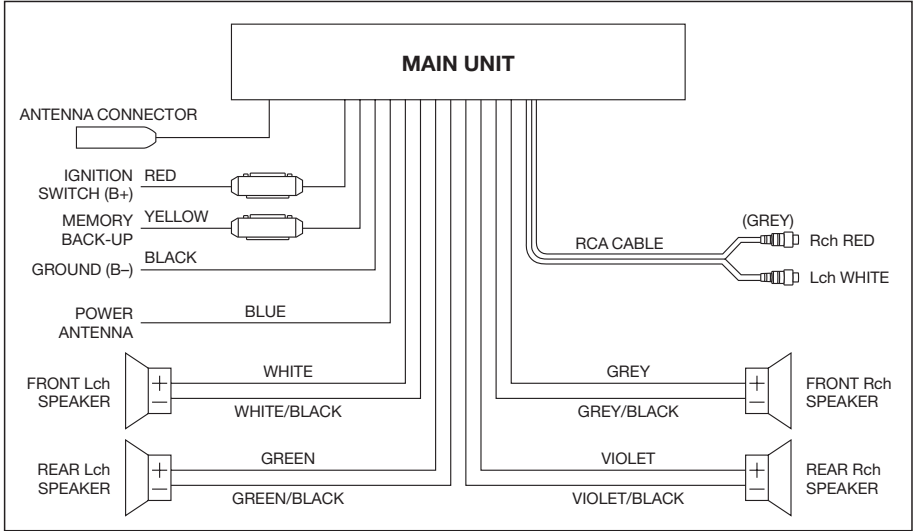

OPERATION

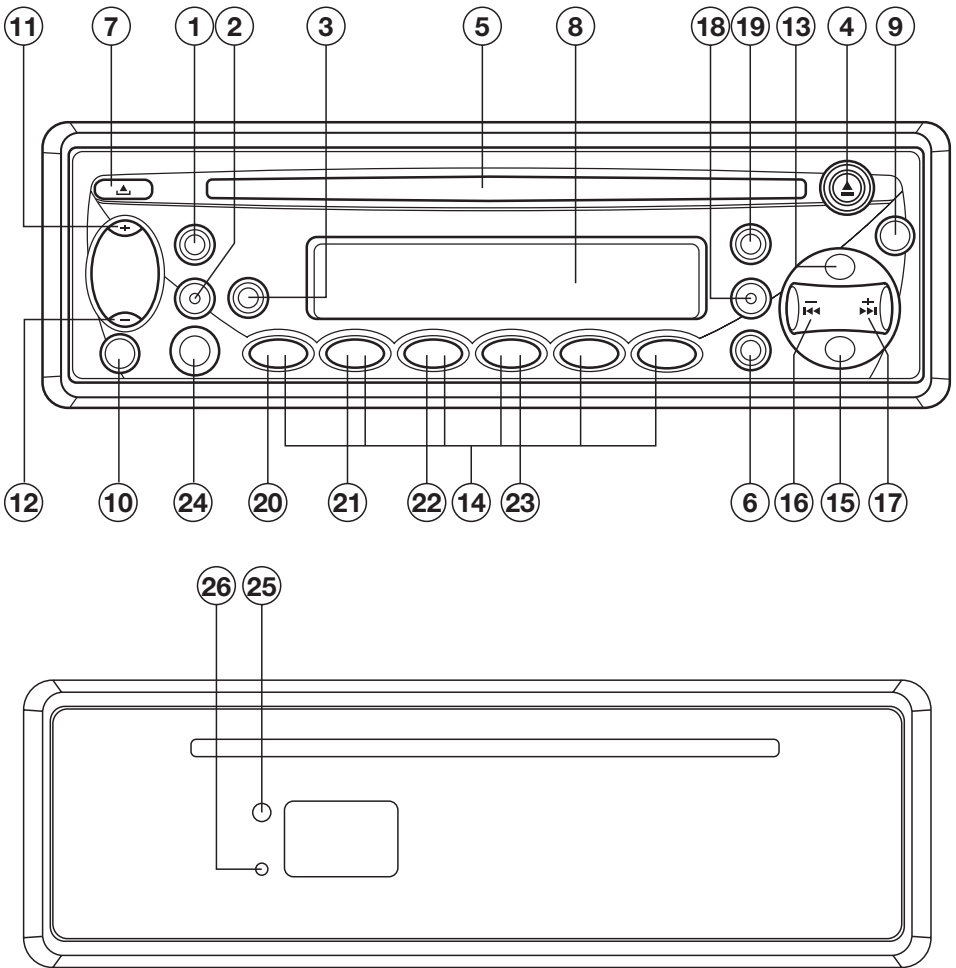

GENERAL OPERATION

• ON/OFF

Switch on the unit by pressing any button [except \blacktriangle button (7) and eject \blacktriangle button (4)]. When system is on, press **PWR** button (9) to turn off the unit.

• FACEPLATE RELEASE

Press \blacktriangle button (7) to detach the removable faceplate.

The adjustment mode will change in the following order:

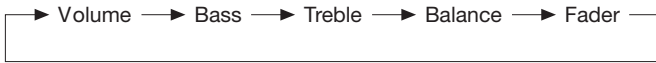



By pressing **VOL** button + (11) or **VOL** button – (12), it is possible to adjust the desired sound level.

- **LOUDNESS**

Press **BND/LOU** button (13) for several seconds to reinforce the bass output and display will show “**LOUD**”. Press it for several seconds again to release this function.

- **SET THE CLOCK**

Press the **DSP** button (15), the clock is shown on the LCD display. Then hold down the button until the clock flashes. Then press the **MANU/SKIP**  button (17) to change hours or **MANU/SKIP**  (16) to change minutes.

- **SELECT MODE**

Press **MOD** button (6) shortly to choose desired listening mode. [e.g. radio mode to CD mode to AUX mode]

- **MUTE**

Press **MUT** button (3) to mute the sound instantly. If any button is pressed in the mute state, the mute mode is released.

- **LIQUID CRYSTAL DISPLAY**

Exhibit current frequency and activated functions on the display (8).

- **EQUALIZATION**

Press **EQ** button (19) to turn on equalization function and to select desired audio mode. There are five kinds of mode as below:

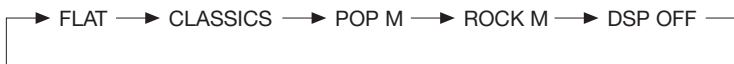

- **AUXILIARY INPUT**

The unit can be connected to a portable audio player through the AUX IN jack (24). To hear the input signal, press MOD (6) button several times until the display shows “AUX”.

- **FLASHING LED**

If the front panel is not installed in the main unit, the **LED** (25) will be flashing.

- **RESET**

RESET button (26) can be activated with either a ball point pen or thin metal object. **RESET** button (26) is to be activated for the following reasons:

- Initial installation of the unit when all wiring is completed.
- All the function buttons do not operate.
- Error symbol on the display.



RADIO OPERATION

- **BAND SELECTION**

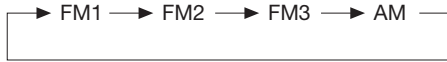
At tuner mode, press **BND/LOU** button (13) to select the desired band. The reception band will change in the following order:



- **STATION SELECTION**

Press **MANU/SKIP**  button (16) or **MANU/SKIP**  button (17) to activate automatic seek function. To select manual tuning mode, press for several seconds until “**MANUAL**” appears on the display. If both buttons are not pressed for several seconds, the tuner will return to seek tuning mode and “**AUTO**” will appear on the display.

- **LOCAL/DISTANCE**

Press **LOC** button (2) to select between local and distant stations. Local setting for reception of strong station, and a distant setting for reception of weaker stations. This function is in effect during AUTO SEEK operation.

- **AUTOMATIC MEMORY STORING & PROGRAM SCANNING**

- Automatic Memory Storing

Press **ATP** button (18) for several seconds, the radio will search from the current station and check the signal strength until one cycle search is finished. The 6 strongest stations detected will be stored into the corresponding preset button.

- Program Scanning

Press **ATP** button (18) shortly to scan preset station.

- **STATION STORING**

Press any one of the preset buttons (14) (M1 to M6) to select a station which had been stored in the memory. Press this button for several seconds to store the current station into that preset button.



- **SEEK FUNCTION**

Press **SEEK** button (1) to scan and hear all tunable stations for a few seconds. Press SEEK again to stop at current station.

CD OPERATION

- **SELECT TRACKS**

Press **MANU/SKIP**  button (16) or **MANU/SKIP**  button (17) to move to the previous track or the following track. Track number shows on display.

Hold **MANU/SKIP**  button (16) or **MANU/SKIP**  button (17) to fast reverse or fast forward. CD play starts from when you release the button.

- **PAUSE PLAYING**

Press **PAU** button (20) to pause CD player. Press it again to resume play.

- **REPEAT THE SAME TRACK**

Press **RPT** button (22) to continuously repeat the same track. Press again to stop repeat.

- **PREVIEW ALL TRACKS**

Press **SCN** button (21) to play first several seconds of each track on the current disc. Press again to stop intro and listen to track.

- **PLAY ALL TRACKS IN RANDOM**

Press **SHF** button (23) to play all tracks on CD in random order. Press again to cancel the function.

- **EJECT**

Press **▲** (eject) button (4) to stop CD playing and eject the disc from the disc slot (5).

Note:

A. Notes on discs:

1. Attempting to use non-standard shape discs (e.g. square, start, heart) may damage the unit. Be sure to use round shape CD discs only for this unit.
2. Do not stick paper or tape etc., onto the label side or the recording side of any discs, as it may cause a malfunction.
3. Dirt, dust, scratches and warping discs will cause misoperation.

B. Notes on CD-Rs (recordable CDs)/CD-RWs (rewritable CDs):

1. Be sure to use discs with following marks only for the unit to play:



2. The unit can only play a CD-R and CD-RW that is finalized. (Please refer to the manual of your CD-R/CD-RW recorder or CD-R/CD-RW software for more information on finalization process).
 3. Depending on the recording status, conditions of the disc and the equipment used for the recording, some CD-Rs/CD-RWs may not play on this unit. (See *1)
- *1: To have more reliable play back, please see following recommendations:
- Use CD-RWs with speed 1x to 4x and write with speed 1x to 2x.
 - Use CD-Rs with speed 1x to 8x and write with speed 1x to 2x.
 - Do not play a CD-RW which has been written for more than 5 times.

SPECIFICATION

GENERAL

- Power Supply Requirements : DC 12 Volts, Negative Ground
- Chassis Dimensions : 178 (W) x 165 (D) x 50 (H)
- Tone Controls
 - Bass (at 100 Hz) : + 10 dB / - 10 dB
 - Treble (at 10 KHz) : + 10 dB / - 10 dB
- Maximum Output Power : 40W x 4 (ch)
- Current Drain : 15 Ampere (max.)

CD PLAYER

- Signal to Noise Ratio : More than 55 dB
- Channel Separation : More than 50 dB
- Frequency Response : 40 Hz - 18 KHz

RADIO

FM

- Frequency Coverage : 87.5 to 107.9 MHz
- IF : 10.7 MHz
- Sensitivity (S/N = 30 dB) : 4 μ V
- Stereo Separation : > 25 dB

AM

- Frequency Coverage : 530 to 1710 KHz
- IF : 450 KHz
- Sensitivity (S/N = 20 dB) : 36 dBu

TROUBLE SHOOTING

Before going through the check list, check wiring connection. If any of the problems persist after check list has been made, consult your nearest service dealer.

Symptom	Cause	Solution
No power.	The car ignition switch is not on.	If the power supply is properly connected to the car accessory circuits, but the engine is not running, switch the ignition key to "ACC".
	The fuse is blown.	Replace the fuse.
Disc cannot be loaded or ejected.	Presence of CD disc inside the player.	Remove the disc in the player, then put a new one.
	Disc is upside-down.	Insert the compact disc with the label facing upward.
	Compact disc is extremely dirty or defective disc.	Clean the disc or try to play a new one.
	Temperature inside the car is too high.	Cool off or until the ambient temperature returns to normal.
	Condensation.	Leave the player off for an hour or so, then try again.
No sound.	Volume is in minimum.	Adjust volume to a desired level.
	Wiring is not properly connected.	Check wiring connection.
Sound skips.	The installation angle is more than 30 degrees.	Adjust the installation angle less than 30 degrees.
	The disc is extremely dirty or defective disc.	Clean the compact disc, or try to play a new one.
The operation keys do not work.	The built-in microcomputer is not operating properly due to noise.	Press the RESET button. Make Sure the Front panel is properly fixed into its place.
The radio does not work. The radio station automatic selection does not work.	The antenna cable is not connected.	Insert the antenna cable firmly.
	The signals are too weak.	Select a station manually.

SANYO MOBILE AUDIO MODEL ECD-T1535 LIMITED WARRANTY

OBLIGATIONS

In order to obtain warranty service, the product must be delivered to and picked up from an Authorized Sanyo Factory Service Center at the user's expense, unless specifically stated otherwise in this warranty. The names and addresses of Authorized Sanyo Service Centers may be obtained by calling the toll-free number listed below.

For product operation, authorized service center referral, service assistance or problem resolution, call
CUSTOMER INFORMATION 1-800-421-6382
Weekdays 8:00 AM - 5:00 PM Pacific Time

THIS WARRANTY IS VALID ONLY ON SANYO PRODUCTS PURCHASED AND USED IN THE UNITED STATES OF AMERICA.

THIS WARRANTY APPLIES ONLY TO THE ORIGINAL RETAIL USER, AND DOES NOT APPLY TO PRODUCTS USED FOR ANY INDUSTRIAL, PROFESSIONAL OR COMMERCIAL PURPOSE. THE ORIGINAL DATED BILL OF SALE OR SALES SLIP MUST BE SUBMITTED TO THE AUTHORIZED SANYO SERVICE CENTER AT THE TIME WARRANTY SERVICE IS REQUESTED. Subject to the OBLIGATIONS above and EXCLUSIONS below, SANYO FISHER COMPANY (SFC) warrants this SANYO product against defects in materials and workmanship for the periods specified below. SFC will repair or replace (at its option) the product and any of its parts which fail to conform to this warranty with new or reconditioned products or parts. The warranty period commences on the date the product was first purchased at retail.

LABOR	PARTS
1 YEAR	1 YEAR

EXCLUSIONS

This warranty does not cover (A) the adjustment of customer-operated controls as explained in the appropriate model's instruction manual, or (B) the repair of any product whose serial number has been altered, defaced or removed.

This warranty does not apply to the cabinet or cosmetic parts, knobs or routine maintenance. This warranty does not apply to the elimination of car static or motor noise, correction of antenna problems, or damage to compact discs, speakers, accessories or vehicle electrical systems. This warranty does not apply to repairs or replacements necessitated by any cause beyond the control of SFC including, but not limited to, any malfunction, defect or failure caused by or resulting from unauthorized service or parts, improper maintenance, operation contrary to furnished instructions, shipping or transit accidents, modification or repair by the user, abuse, misuse, neglect, accident, incorrect power line voltage, fire, flood or other Acts of God, or normal wear and tear. The foregoing is in lieu of all other express warranties and SFC does not assume or authorize any party to assume for it any other obligation or liability.

THE DURATION OF ANY WARRANTIES WHICH MAY BE IMPLIED BY LAW (INCLUDING THE WARRANTIES OF MERCHANTABILITY AND FITNESS) IS LIMITED TO THE TERM OF THIS WARRANTY IN NO EVENT SHALL SFC BE LIABLE FOR SPECIAL, INCIDENTAL OR CONSEQUENTIAL DAMAGES ARISING FROM OWNERSHIP OR USE OF THIS PRODUCT, OR FOR ANY DELAY IN THE PERFORMANCE OF ITS OBLIGATIONS UNDER THIS WARRANTY DUE TO CAUSES BEYOND ITS CONTROL.

SOME STATES DO NOT ALLOW LIMITATIONS ON HOW LONG AN IMPLIED WARRANTY LASTS AND/OR DO NOT ALLOW THE EXCLUSION OR LIMITATION OF CONSEQUENTIAL DAMAGES, SO THE ABOVE LIMITATIONS AND EXCLUSIONS MAY NOT APPLY TO YOU.

THIS WARRANTY GIVES YOU SPECIFIC LEGAL RIGHTS. YOU MAY HAVE OTHER RIGHTS, WHICH VARY FROM STATE TO STATE.

For your protection in the event of theft or loss of this product, please fill in the information below for your own personal records.

Model No. _____ Serial No. _____
Located on back or bottom side of unit

Date of Purchase _____ Purchase Price _____

Where Purchased _____



21605 Plummer Street
Chatsworth, CA91311

ECD-T1535. Issue Number 1.

Free Manuals Download Website

<http://myh66.com>

<http://usermanuals.us>

<http://www.somanuals.com>

<http://www.4manuals.cc>

<http://www.manual-lib.com>

<http://www.404manual.com>

<http://www.luxmanual.com>

<http://aubethermostatmanual.com>

Golf course search by state

<http://golfingnear.com>

Email search by domain

<http://emailbydomain.com>

Auto manuals search

<http://auto.somanuals.com>

TV manuals search

<http://tv.somanuals.com>