



SANYO

INSTRUCTION MANUAL

DRW-500

DVD Video Recorder

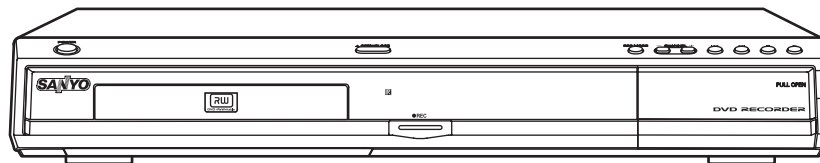

SANYO'S HELP-LINE

Call the toll-free number below if you have any difficulties operating this product.
1-800-813-3435 (Weekdays: 7:30 AM - 4:00 PM Central Time)

Please Read This Manual.

We recommend that you read this manual carefully before connecting your DVD Video Recorder and operating it for the first time.

Keep the manual in a safe place for future reference.

1AD6P1P2047--A DRW-500, Issue Number 2

English

CONTENTS

Important Safety Instructions	E2	Disc Information	E38
Safety Certification	E4	Recordable Discs	E38
Accessories	E4	Playable Discs	E38
Controls	E5	Recording	E40
Remote Control	E6	Preparations	E40
For Safe and Efficient Operation	E7	Recording TV Programs	E41
Basic Connection	E8	Timer Recording	E43
Before Connection	E8	Recording from an External Equipment (VCR, etc.)	E43
Step 1: Connecting the Antenna Cable	E8	Disc Playback	E44
Step 2: Connecting the Video Cable	E11	Preparations	E44
Step 3: Connecting the Audio Cables	E12	Basic Playback	E45
Step 4: Connecting the Power Cord	E14	Stopping Playback	E45
Connecting a VCR or Similar Recording Equipment		Selecting a Top Menu	E46
to This Unit	E15	Selecting a DVD Menu	E46
Connecting to a Satellite Receiver or a Cable Box	E17	Chapter (Track) Skip	E46
Setting the Clock	E18	Title or Chapter Search	E46
Preparations	E18	Time Search	E46
To Set the Clock	E18	Time Search [CD]	E47
Tuner Setting	E19	Track Search [CD]	E47
Setting "Channel Setup"	E19	Fast Playback	E47
Before Initial Setting	E22	Slow Motion Playback	E47
Common Procedure	E22	Still Picture (Pause)	E47
Initial Settings	E23	Frame by Frame Advance Playback	
Recording Setup	E23	[DVD-Video] [DVD+RW] [DVD+R]	E47
Preparations	E23	Picture Zoom	E48
Setting "Record Mode"	E23	Viewing from a Desired Camera Angle	
Setting "Auto Chapter"	E24	(Multi-Angle) [DVD-Video]	E48
DVD Control	E25	Repeat Playback	E48
Preparations	E25	Designated Range Repeat Playback (A-B Repeat)	E48
Setting "Disc Menu"	E25	Selecting Subtitle Language	E49
Setting "Angle Mark"	E26	Selecting Audio Soundtrack Language	
Setting "Audio"	E26	(Multi-Language)	E49
Setting "Subtitle"	E26	Shuffle Playback [CD]	E50
Setting "Parental Control"	E27	Programmed Playback [CD]	E50
General	E29	To Check the Disc Playing Time	E50
Preparations	E29	MP3 CD Operation	E51
Setting "Menu Language"	E29	Before Starting	E51
Video	E30	MP3 CD Playback	E51
Preparations	E30	Stopping Playback	E51
Setting "TV Display"	E30	Pause	E52
Audio	E31	File Skip	E52
Preparations	E31	Repeat Playback	E52
Setting "Digital Out"	E31	To Check the Elapsed Playing Time	E52
Setting "DRC (Dynamic Range Control)"	E31	Picture Disc Operation	E53
AV Select	E32	Kodak Picture CD Playback	E53
Preparations	E32	JPEG CD Playback	E54
Setting "AV1 Select" and "AV2 Select"	E32	Picture Zoom	E54
Record Status	E33	Editing	E55
Preparations	E33	Preparations	E55
Setting "Record Time"	E33	Play/Edit Titles	E55
Setting "Record Day"	E34	Edit Disc	E57
Setting "Input Source"	E35	Troubleshooting Guide	E59
Setting "TV"	E35	Maintenance	E61
Setting "Record Mode"	E36	Specifications	E61
Setting "Title"	E36	Warranty	E62
Record List	E37		

Note:

This handling description is printed prior to product development.



When a part of the product specification must be changed to improve operability or other functions, priority is given to the product specification itself. In such instances, the instruction manual may not entirely match all the functions of the actual product.

Therefore, the actual product and packaging, as well as the name and illustration, may differ from the manual.

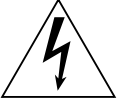

	CAUTION RISK OF ELECTRIC SHOCK DO NOT OPEN	
CAUTION: TO PREVENT THE RISK OF ELECTRIC SHOCK, DO NOT REMOVE COVER (OR BACK). NO USER-SERVICEABLE PARTS INSIDE. REFER SERVICING TO QUALIFIED SERVICE PERSONNEL.		

WARNING: TO PREVENT FIRE OR SHOCK HAZARD, DO NOT EXPOSE THIS APPLIANCE TO RAIN OR MOISTURE.

	This symbol indicates that dangerous voltage constituting a risk of electric shock is present within this unit.
	This symbol indicates that there are important operating and maintenance instructions in the literature accompanying this unit.

WARNING: UNAUTHORIZED RECORDING OF COPYRIGHTED MATERIAL MAY VIOLATE APPLICABLE COPYRIGHT LAWS. THE MANUFACTURER ASSUMES NO RESPONSIBILITY FOR UNAUTHORIZED DUPLICATION, USE OR OTHER ACTS WHICH INFRINGE UPON THE RIGHTS OF COPYRIGHT OWNERS.

IMPORTANT SAFETY INSTRUCTIONS

1. Read Instructions – All the safety and operating instructions should be read before the product is operated.
2. Retain Instructions – The safety and operating instructions should be retained for future reference.
3. Heed Warnings – All warnings on the product and in the operating instructions should be adhered to.
4. Follow Instructions – All operating and use instructions should be followed.
5. Cleaning – Unplug this product from the wall outlet before cleaning. Do not use liquid cleaners or aerosol cleaners. Use a damp cloth for cleaning.
6. Attachments – Do not use attachments not recommended by the product manufacturer as they may cause hazards.
7. Water and Moisture – Do not use this product near water – for example, near a bath tub, wash bowl, kitchen sink, or laundry tub; in a wet basement; or near a swimming pool; and the like.
8. Accessories – Do not place this product on an unstable cart, stand, tripod, bracket, or table. The product may fall, causing serious injury to a child or adult, and serious damage to the product. Use only with a cart, stand, tripod bracket, or table recommended by the manufacturer, or sold with the product. Any mounting of the product should follow the manufacturer's instructions, and should use a mounting accessory recommended by the manufacturer.
9. A product and cart combination should be moved with care. Quick stops, excessive force, and uneven surfaces may cause the product and cart combination to overturn.

PORTABLE CART WARNING
(Symbol provided by RETAC)



S3125A

(Figure 1)

10. Ventilation – Slots and openings in the cabinet are provided for ventilation and to ensure reliable operation of the product and to protect it from overheating, and these openings must not be blocked or covered. The openings should never be blocked by placing the product on a bed, sofa, rug, or other similar surface. This product should not be placed in a built-in installation such as a bookcase or rack unless proper ventilation is provided or the manufacturer's instructions have been adhered to.
11. Power Sources – This product should be operated only from the type of power source indicated on the marking label. If you are not sure of the type of power supply to your home, consult your product dealer or local power company. For products intended to operate from battery power, or other sources, refer to the operating instructions.
12. Grounding or Polarization – This product may be equipped with a polarized alternating-current line plug (a plug having one blade wider than the other). This plug will fit into the power outlet only one way. This is a safety feature. If you are unable to insert the plug fully into the outlet, try reversing the plug. If the plug should still fail to fit, contact your electrician to replace your obsolete outlet. Do not defeat the safety purpose of the polarized plug.
13. Power-Cord Protection – Power-supply cords should be routed so that they are not likely to be walked on or pinched by items placed upon or against them, paying particular attention to cords at plugs, convenience receptacles, and the point where they exit from the product.
14. Lightning – For added protection for this product during a lightning storm, or when it is left unattended and unused for long periods of time, unplug it from the wall outlet and disconnect the antenna or cable system. This will prevent damage to the product due to lightning and power-line surges.

15. Outdoor Antenna Grounding – If an outside antenna or cable system is connected to the product, be sure the antenna or cable system is grounded so as to provide some protection against voltage surges and built-up static charges. Article 810 of the National Electrical Code, ANSI/NFPA 70, provides information with regard to proper grounding of the mast and supporting structure, grounding of the lead-in wire to an antenna discharge unit, size of grounding conductors, location of antenna-discharge unit, connection to grounding electrodes, and requirements for the grounding electrode. See Figure 2.

EXAMPLE OF ANTENNA GROUNDING AS PER NATIONAL ELECTRICAL CODE, ANSI/NFPA 70

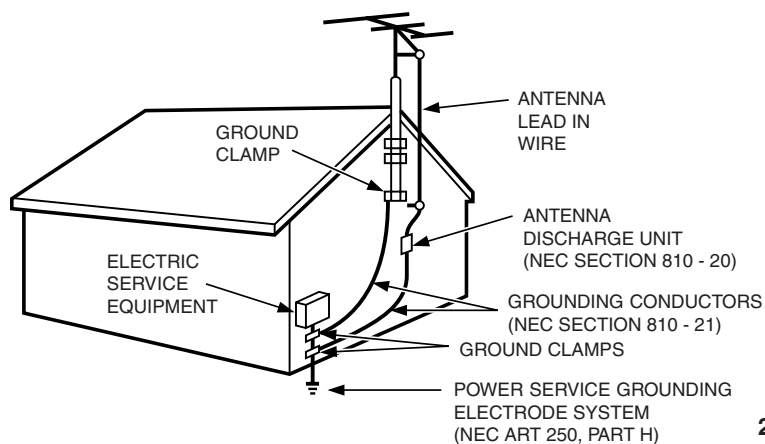

NEC – NATIONAL ELECTRICAL CODE

S2898A

(Figure 2)

16. Power Lines – An outside antenna system should not be located in the vicinity of overhead power lines or other electric light or power circuits, or where it can fall into such power lines or circuits. When installing an outside antenna system, extreme care should be taken to keep from touching such power lines or circuits as contact with them might be fatal.

17. Overloading – Do not overload wall outlets, extension cords, or integral convenience receptacles as this can result in a risk of fire or electric shock.

18. Object and Liquid Entry – Never push objects of any kind into this product through openings as they may touch dangerous voltage points or short-out parts that could result in a fire or electric shock. Never spill liquid of any kind on the product.

19. Servicing – Do not attempt to service this product yourself as opening or removing covers may expose you to dangerous voltage or other hazards. Refer all servicing to qualified service personnel.

20. Damage Requiring Service – Unplug this product from the wall outlet and refer servicing to qualified service personnel under the following conditions:

- a. When the power-supply cord or plug is damaged.
- b. If liquid has been spilled, or objects have fallen into the product.
- c. If the product has been exposed to rain or water.
- d. If the product does not operate normally by following the operating instructions. Adjust only those controls that are covered by the operating instructions as an improper adjustment of other controls may result in damage and will often require extensive work by a qualified technician to restore the product to its normal operation.
- e. If the product has been dropped or damaged in any way.
- f. When the product exhibits a distinct change in performance – this indicates a need for service.

21. Replacement Parts – When replacement parts are required, be sure the service technician has used replacement parts specified by the manufacturer or have the same characteristics as the original part. Unauthorized substitutions may result in fire, electric shock, or other hazards.

22. Safety Check – Upon completion of any service or repairs to this product, ask the service technician to perform safety checks to determine that the product is in proper operating condition.

23. Heat – The product should be situated away from heat sources such as radiators, heat registers, stoves, or other products (including amplifiers) that produce heat.



SAFETY CERTIFICATION

This unit is made and tested to meet exacting safety standards. It meets UL and FCC requirements and complies with safety performance standards of the U.S. Department of Health and Human Services.

CAUTION - USE OF CONTROLS OR ADJUSTMENTS OR PERFORMANCE OF PROCEDURES OTHER THAN THOSE SPECIFIED HEREIN MAY RESULT IN HAZARDOUS RADIATION EXPOSURE.

THIS UNIT SHOULD NOT BE ADJUSTED OR REPAIRED BY ANYONE EXCEPT PROPERLY QUALIFIED SERVICE PERSONNEL.

FCC INFORMATION

This device complies with Part 15 of the FCC Rules. Operation is subject to the following two conditions: (1) This device may not cause harmful interference, and (2) this device must accept any interference received, including interference that may cause undesired operation.

CAUTION:
Changes or modifications not expressly approved by Sanyo may void the user's authority to operate this equipment.

Note:

This equipment has been tested and found to comply with the limits for a Class B digital device, pursuant to Part 15 of the FCC Rules. These limits are designed to provide reasonable protection against harmful interference in a residential installation. This equipment generates, uses and can radiate radio frequency energy and, if not installed and used in accordance with the instructions, may cause harmful interference to radio communications. However, there is no guarantee that interference will not occur in a particular installation. If this equipment does cause harmful interference to radio or television reception, which can be determined by turning the equipment off and on, the user is encouraged to try to correct the interference by one or more of the following measures:

- Reorient or relocate the receiving antenna.
- Increase the separation between the equipment and receiver.
- Connect the equipment into an outlet on a circuit different from that to which the receiver is connected.
- Consult the dealer or an experienced radio/TV technician for help.

THIS CLASS B DIGITAL APPARATUS COMPLIES WITH CANADIAN ICES-003.

CET APPAREIL NUMÉRIQUE DE CLASSE B EST CONFORME AUX EXIGENCES DU RÉGLEMENT CANADIEN ICES-003.

ACCESSORIES

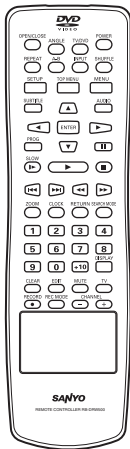

RB-DRW500 wireless remote control

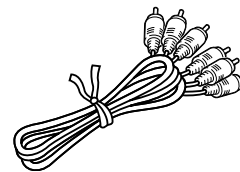

Audio/Video cable

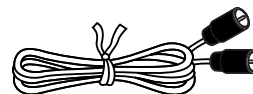

75-ohm coaxial antenna cable

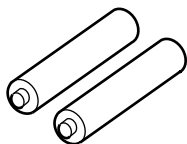

AA size battery (manganese)
Quantity: 1 pair



CONTROLS

Front Panel

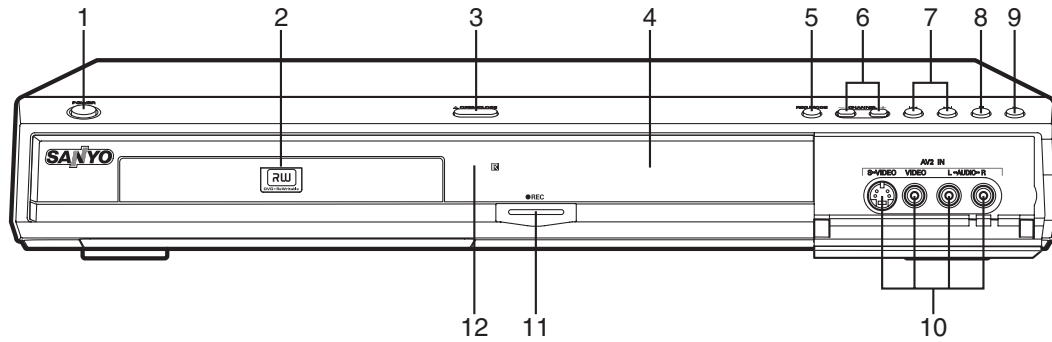

- | | |
|---|--|
| 1. Power button (POWER) | 9. Play button (▶) |
| 2. Disc tray | 10. 2nd AV input jacks (AV2 IN)
S-video input jack (S-VIDEO)
Video input jack (VIDEO)
Audio input jacks (L-AUDIO-R) |
| 3. Open/Close button (▲ OPEN/CLOSE) | 11. Record button and indicator (● REC) |
| 4. FL display | 12. Remote sensor (IR) |
| 5. Record mode button (REC MODE) | |
| 6. TV channel scanning button (- CHANNEL +) | |
| 7. Skip/Next/Previous buttons (◀◀, ▶▶) | |
| 8. Stop button (■) | |

FL Display

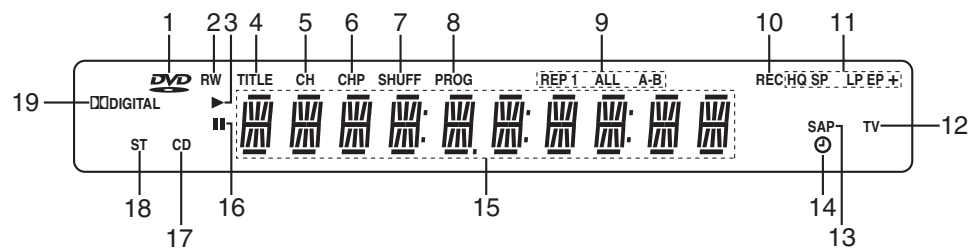

- | | |
|---------------------------------------|--|
| 1. DVD indicator (DVD) | 11. Record mode indicators (HQ, SP, LP, EP, +) |
| 2. DVD rewritable indicator (RW) | 12. TV indicator (TV) |
| 3. Play indicator (▶) | 13. Second Audio Program indicator (SAP) |
| 4. Title indicator (TITLE) | 14. Timer indicator (⌚) |
| 5. Channel indicator (CH) | 15. Message or number indicators
(Title, chapter, track, playing time or other information) |
| 6. Chapter indicator (CHP) | 16. Pause indicator (⏸) |
| 7. Shuffle indicator (SHUFF) | 17. CD indicator (CD) |
| 8. Program indicator (PROG) | 18. Stereo indicator (ST) |
| 9. Repeat indicators (REP1, ALL, A-B) | 19. Dolby Digital indicator (Ⓜ DIGITAL) |
| 10. Record indicator (REC) | |

Back Panel

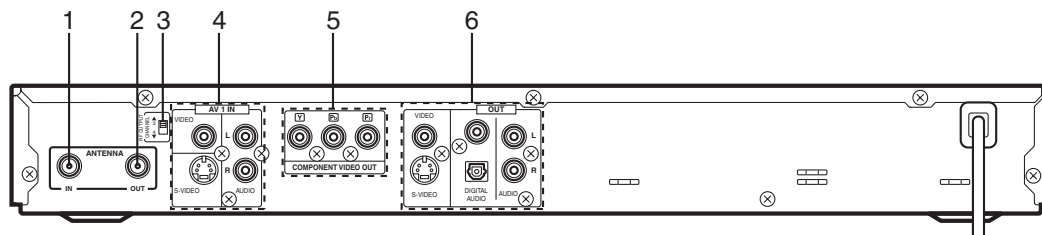

- | | |
|---|---|
| 1. VHF/UHF antenna input jack (ANTENNA IN) | 5. Component video output jacks (COMPONENT VIDEO OUT) |
| 2. VHF/UHF antenna output jack (ANTENNA OUT) | 6. AV output jacks (OUT)
Video output jack (VIDEO)
S-video output jack (S-VIDEO)
Coaxial digital audio output and Optical digital audio output jacks (DIGITAL AUDIO)
Audio output jacks (L/R AUDIO) |
| 3. RF output channel switch (RF OUTPUT CHANNEL) | |
| 4. 1st AV input jacks (AV1 IN)
Video input jack (VIDEO)
S-video input jack (S-VIDEO)
Audio input jacks (L/R AUDIO) | |

REMOTE CONTROL

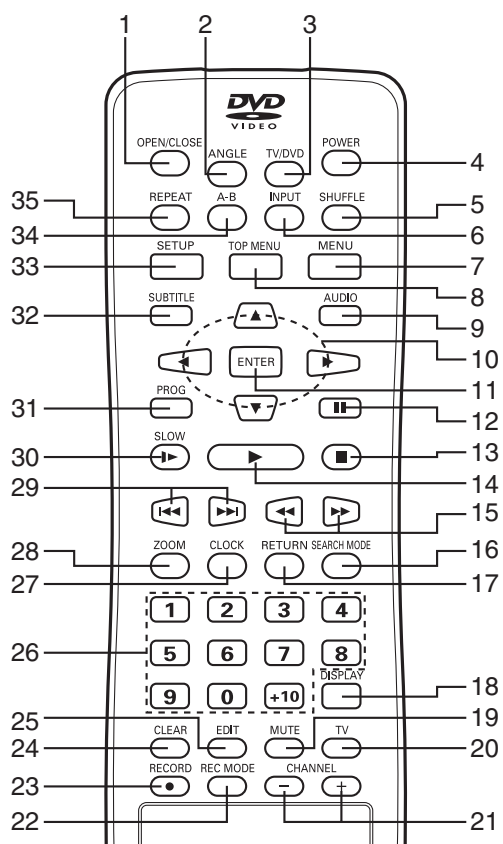

1. Open/Close button (OPEN/CLOSE)
2. Angle button (ANGLE)
3. TV/DVD select button (TV/DVD)
4. Power button (POWER)
5. Shuffle button (SHUFFLE)
6. Input select button (INPUT)
7. Menu button (MENU)
8. Top menu button (TOP MENU)
9. Audio button (AUDIO)
10. Directional arrow buttons (▲, ►, ▼, ◀)
11. Enter button (ENTER)
12. Pause button (⏸)
13. Stop button (■)
14. Play button (▶)
15. Fast forward/Fast reverse buttons (⏩, ⏪)
16. Search mode button (SEARCH MODE)
17. Return button (RETURN)
18. Display button (DISPLAY)
19. Muting button (MUTE)
20. TV button (TV)
21. TV channel scanning buttons (- CHANNEL +)
22. Record mode button (REC MODE)
23. Record button (● RECORD)
24. Clear button (CLEAR)
25. Edit button (EDIT)
26. Number buttons (1 – 9, 0, +10)
27. Clock button (CLOCK)
28. Zoom button (ZOOM)
29. Skip/Next/Previous buttons (⏮, ⏭, ⏪)
30. Slow motion playback button (⏪)
31. Program button (PROG)
32. Subtitle button (SUBTITLE)
33. Setup button (SETUP)
34. A-B repeat button (A-B)
35. Repeat button (REPEAT)

Inserting batteries

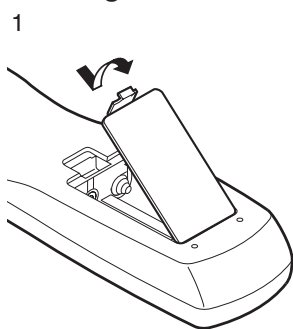

Two "AA" batteries (supplied)

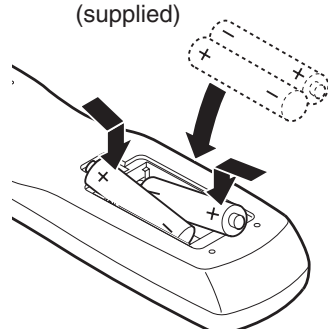

Note:

Remove the batteries if the remote control is not to be used for a month or more. Batteries left in the unit may leak and cause damage.

IMPORTANT NOTE:

SPENT OR DISCHARGED BATTERIES MUST BE RECYCLED OR DISPOSED OF PROPERLY IN COMPLIANCE WITH ALL APPLICABLE LAWS. FOR DETAILED INFORMATION, CONTACT YOUR LOCAL COUNTY SOLID WASTE AUTHORITY.

Remote control range

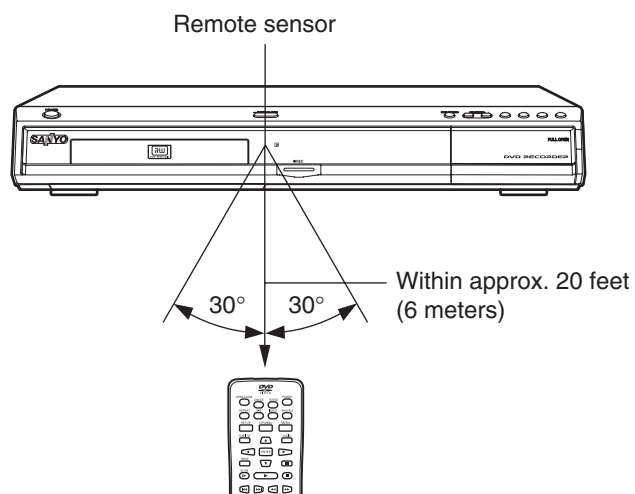

Note:

This is not Multi-brand Remote Control. It cannot operate your TV and VCR.



FOR SAFE AND EFFICIENT OPERATION

- Do not damage the power cord.
- When not in use, disconnect the power cord from the outlet. Grasp the plug, not the cord, when disconnecting the unit.
- If water should enter the unit, electrical shock or a malfunction may result. Use in an area where there is low humidity and little dust.
- Do not disassemble or alter the unit in any way.
- Do not use the unit in areas where extremes in temperature occur (below 40°F (5°C) or exceeding 95°F (35°C)), or where it may be exposed to direct sunlight.
- Because of the DVD recorder extremely low noise and wide dynamic range, there is a tendency to set the volume on the amplifier higher than necessary. Doing so may produce an excessively high output from the amplifier which can cause damage to your speakers. Please be careful in this regard.
- Sudden changes in the surrounding temperature can cause dew to form on the optical pickup lens inside the unit. Under this condition the unit may be unable to operate properly. If this should occur, remove the disc and allow the unit to adjust to the surrounding temperature.
- **When carrying the unit, be sure to remove a disc which may be inside and turn the power off. Then unplug the power cord from the AC outlet after 10 seconds. Carrying the unit with a disc inside may damage the disc and/or the unit.**
- Do not install this equipment in a confined space, such as a book case or built in cabinet.

CAUTION:

The unit must be operated in a horizontal position only.
The unit must be placed in a well ventilated area.
Do not place any object on the top of the unit.
Do not block ventilation holes.
The cabinet of the unit warms up when it is used for a long time, however it is not a malfunction.

Press [▲ OPEN/CLOSE] (or [OPEN/CLOSE] on the remote control) when closing the disc tray. Do not push the disc tray.

To reduce the volume temporarily (muting)

Press [MUTE] on the remote control. "MUTE" appears on the TV screen.
To restore the previous volume setting, press [MUTE] again. "MUTE OFF" appears briefly on the TV screen.

WHAT TO DO IF...

If the operation of the unit or display is not normal, even though the appropriate buttons have been pressed.

1. Disconnect the power cord.
2. Connect the power cord again.
3. Operate the unit again.

Note:

If the unit still does not operate correctly, please contact your nearest Sanyo Authorized Service Facility.



**Need help? Call
1-800-813-3435**



BASIC CONNECTION

Notes:

- Unpack the unit and insert the two AA size batteries in the remote control (See page E6).
- **Do not connect the power cord to a 120VAC 60Hz outlet until all connections have been made.**



Need help? Call
1-800-813-3435

Before Connection

This guide will help you to connect the unit.

Step 1: Connecting the Antenna Cable (See page E8.)



Step 2: Connecting the Video Cables (See page E11.)



Step 3: Connecting the Audio Cables (See page E12.)



Step 4: Connecting the Power Cord (See page E14.)

Step 1: Connecting the Antenna Cable

First, select one of the following antenna connections that best suit you.

If you use	See
Antenna only (no cable TV), or cable without cable box	Example: Basic Antenna/Cable connections (Page E9)
Cable box with a few or many scrambled channels	Example: Connecting a Cable Box (Page E10)

Note to CATV system installer:

This reminder is provided to call the CATV system installer's attention to Section 820-40 of the NEC which provides guidelines for proper grounding and, in particular, specifies that the cable ground shall be connected to the grounding system of the building, as close to the point of cable entry as practical.

Notes:

- If the antenna is a flat cable (300-ohm twin lead cable), use a 300-75 ohm matching transformer (not supplied) to connect the antenna to the unit.
- If you use separate VHF and UHF antenna cables, use a VHF/UHF band combiner (not supplied) to connect the antenna to the unit.
- If you are not sure about the connection, please consult your audio/video dealer.

CAUTION:

Do not connect the antenna and VCR as shown below. Your VCR doesn't work.

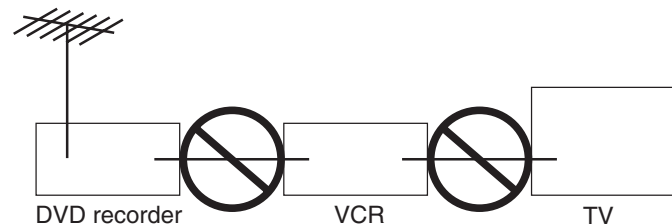
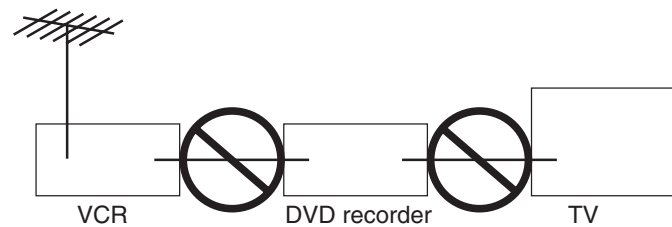

Example: Basic Antenna/Cable Connections

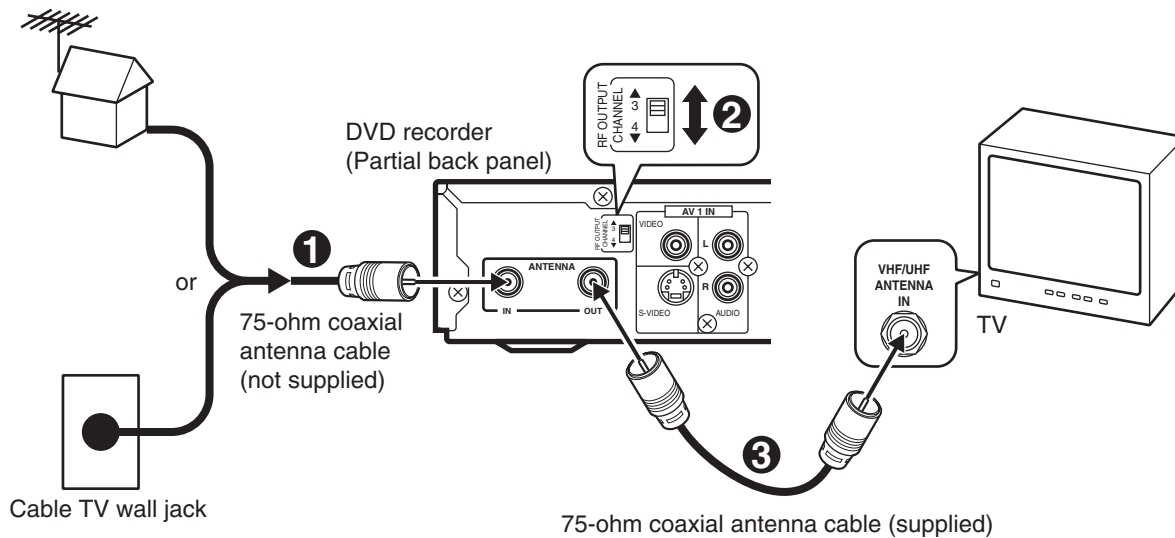

1. Connect an antenna (or a cable TV system) to the unit.
2. Set the RF OUTPUT CHANNEL switch to "3" or "4".
3. Connect the unit to the TV with the 75-ohm coaxial antenna cable (supplied).

Channel Switch Setting

Set your TV to either channel 3 or channel 4. (Choose a channel that is not used for broadcasting in your area.) Then set the RF OUTPUT CHANNEL switch to channel 3 or 4 to match the channel selected on the TV. This is your unit channel. The TV must be set to this channel whenever the unit is used for playing a disc or watching a TV program. If in doubt, check with your local cable company.



Need help? Call
1-800-813-3435

Example: Connecting a Cable Box

This unit can receive all unscrambled cable channels without the use of a cable box. If you wish to view and record scrambled cable channels, you must connect a cable box as described below.

Your local cable TV company will advise you of the channels available in your area.

We recommend that you consult your cable TV company to make sure that the cable is properly connected.

Example:

Connecting a cable box with many scrambled channels

Use this connection if your cable system scrambles all or most channels.

Connect the cable box to the unit first.

Notes:

- The unit and TV receive the same channel. Be sure that the cable box is turned on.
- Recording one channel while watching another channel is not possible.

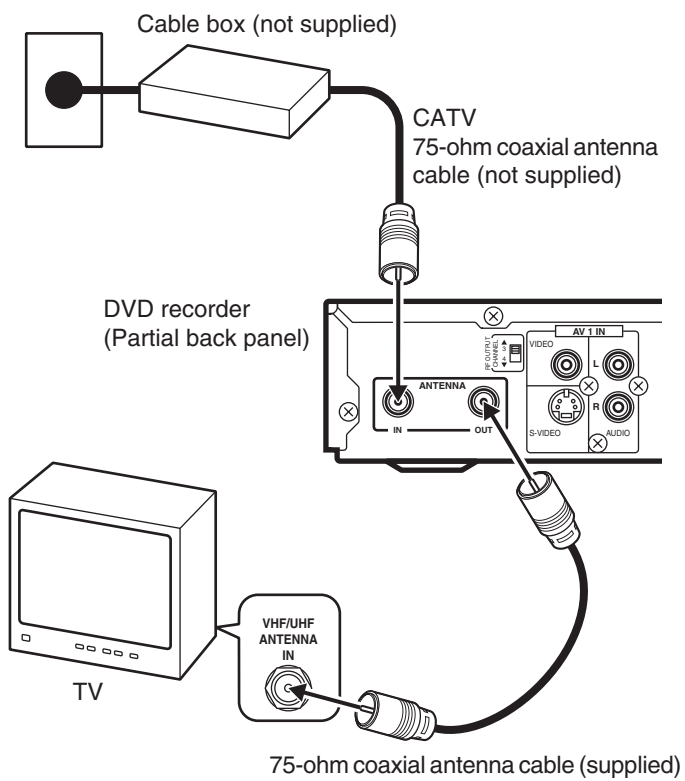

Example:

Connecting a cable box with only a few scrambled channels

Use this connection if your cable system scrambles only a few channels.

Connect the cable box between the unit and the TV.

Notes:

- You can record any non-scrambled channel by selecting the channel on the unit.
- You cannot record scrambled channels that require a cable box.

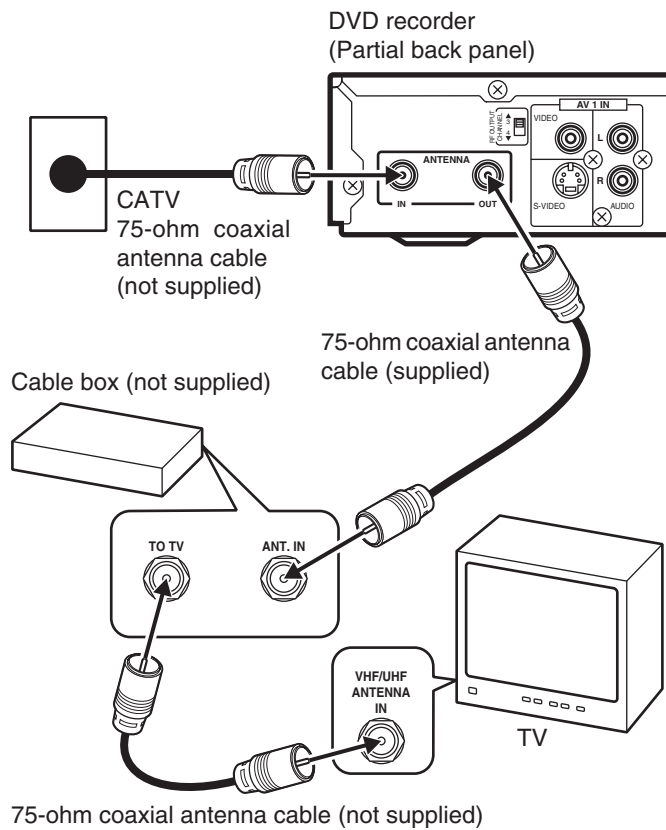

**Need help? Call
1-800-813-3435**

Step 2: Connecting the Video Cable

Connect the unit to your TV.
Select one of the following examples.
(If the TV has an antenna input jack only, skip this step.)

Note:
For AUDIO connection, see page E12.



Need help? Call
1-800-813-3435

Example:

Connecting to the VIDEO OUT jack

Connect the yellow plug of the Audio/Video cable to the video (yellow) jack.
You can enjoy standard picture images.

Note:

Connect the right (red) and left (white) plugs of the Audio/Video cable to the audio input jacks (see page E12).

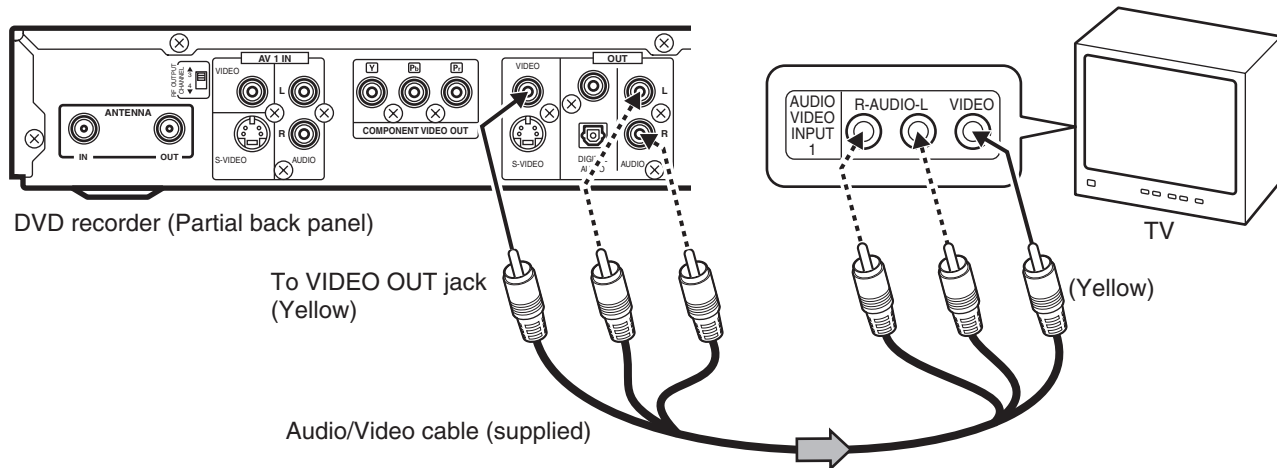

Example:

Connecting to the S-VIDEO OUT jack

Connect the S-video cable (not supplied) as shown below.
(The VIDEO OUT jack connection is not necessary.)
You can enjoy clearer picture images.

For AUDIO connection, see page E12.

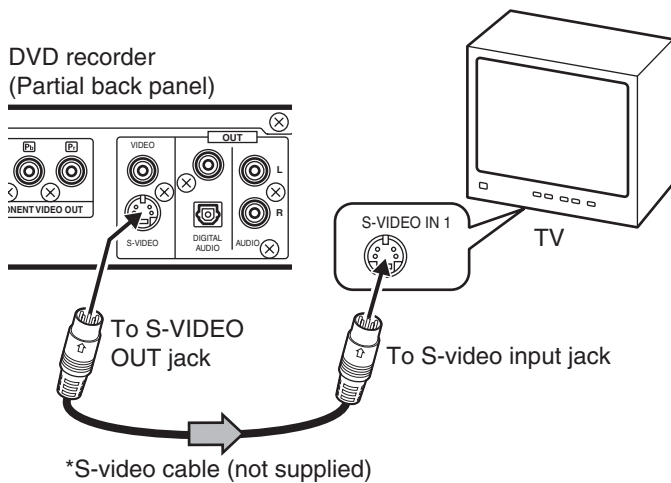

* Please consult your local audio/video dealer.

Example:

Connecting to the COMPONENT VIDEO OUT jacks

Connect a component video cable (not supplied) as shown below.
(The VIDEO OUT or S-VIDEO OUT jack connection is not necessary.)
You can enjoy high quality picture images.

For AUDIO connection, see page E12.

If you use a TV with Progressive-scan Capability, set the unit to the PROGRESSIVE mode. See page E44.

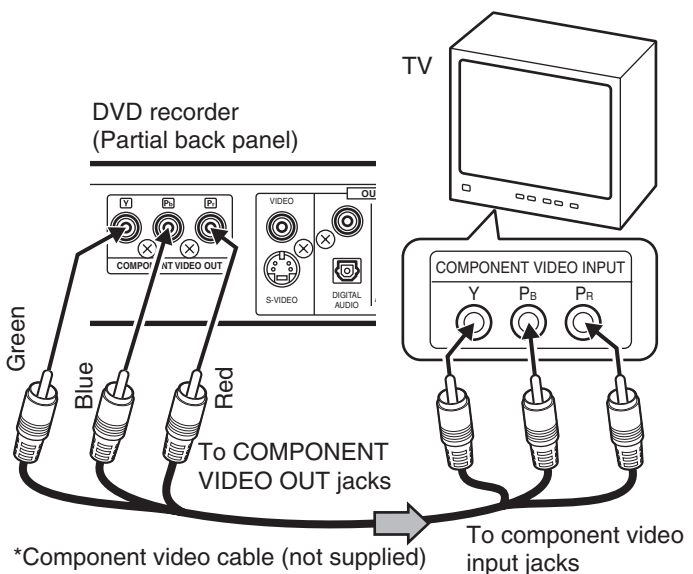

*Component video cable (not supplied) To component video input jacks

Step 3: Connecting the Audio Cables

Select the audio connection that best suits your system.
(If the TV has an antenna input jack only, skip this step.)

Note:

For VIDEO connection, see page E11.

Example:

Connecting to your TV (or Audio System)

The built-in speakers in your TV will sound.

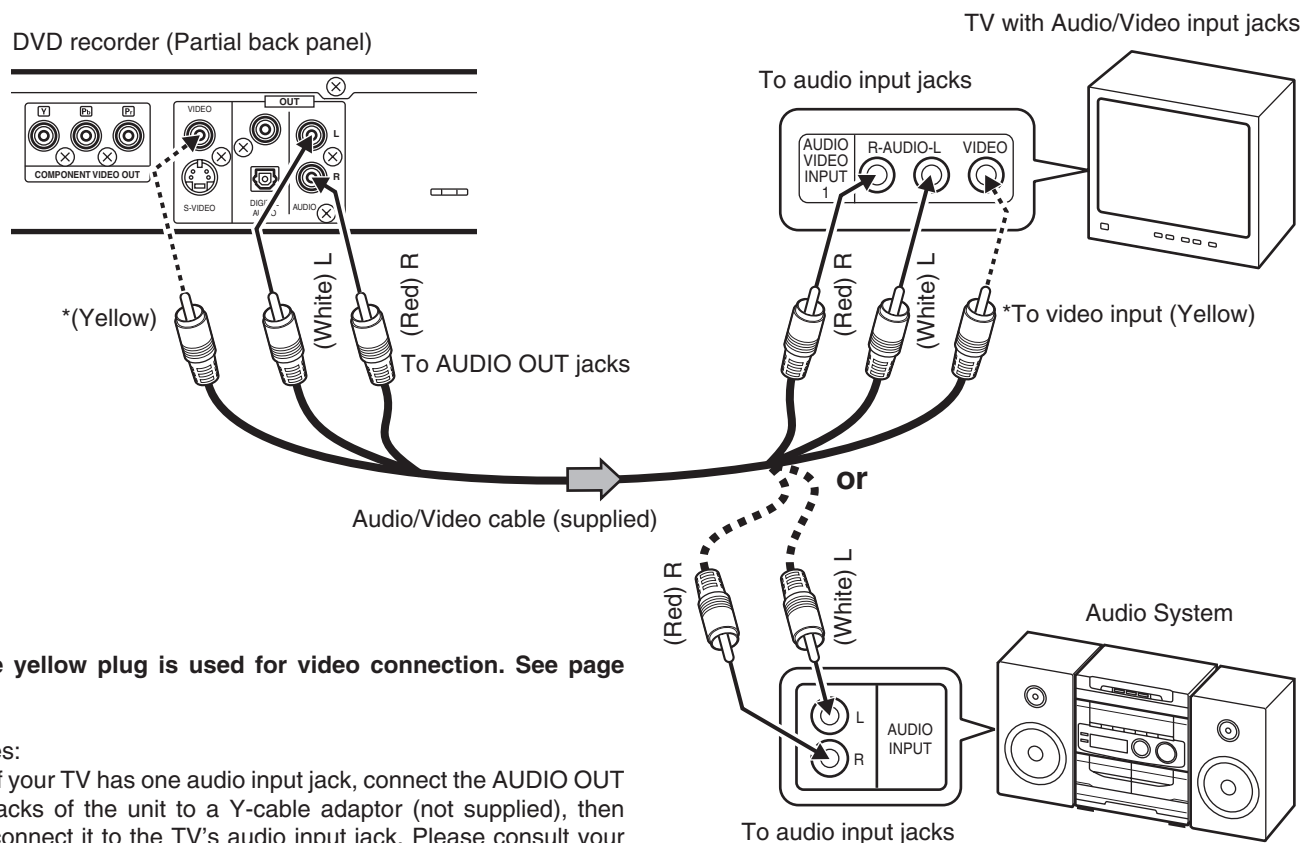

*The yellow plug is used for video connection. See page E11.

Notes:

- If your TV has one audio input jack, connect the AUDIO OUT jacks of the unit to a Y-cable adaptor (not supplied), then connect it to the TV's audio input jack. Please consult your local audio/video dealer.
- Do not connect the AV1 IN or AV2 IN (AUDIO L/R) jacks of the unit to your TV's audio output jacks at the same time.



**Need help? Call
1-800-813-3435**

**Example:
Connecting to an Amplifier with Dolby Digital Decoder or DTS Decoder**

Connect the audio cable and/or coaxial digital cable or optical digital cable.

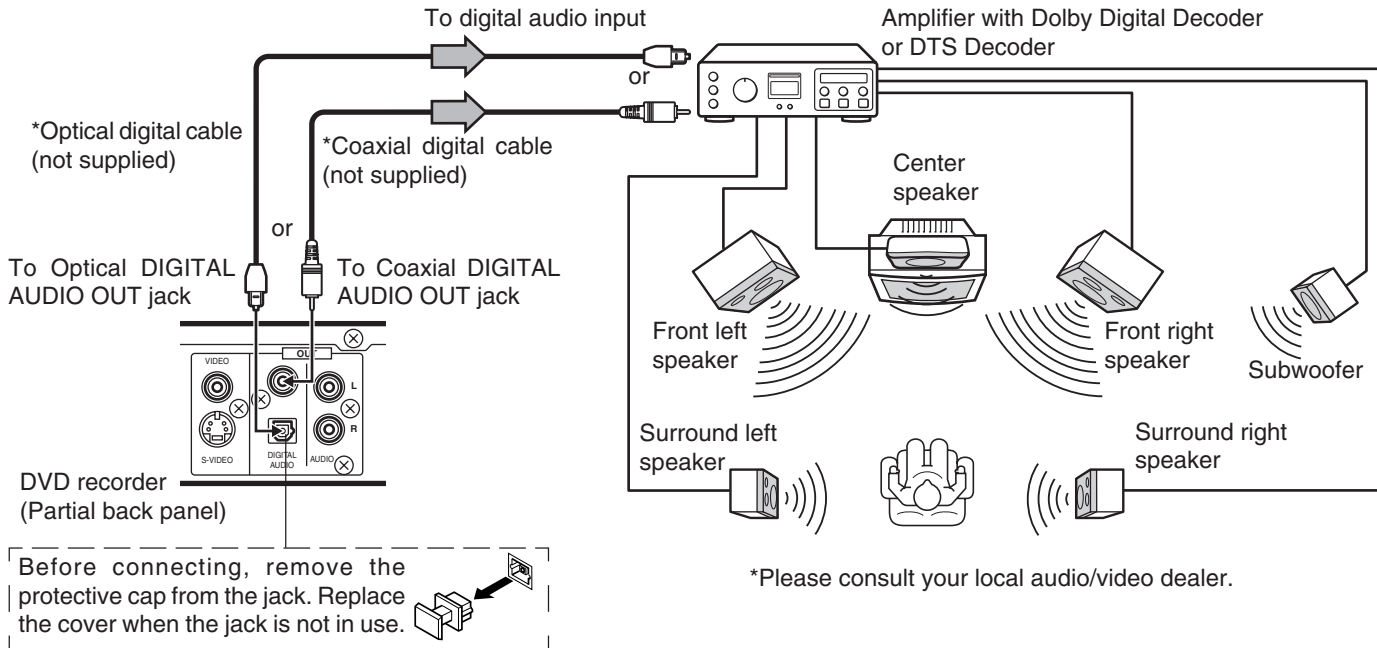

Manufactured under license from Dolby Laboratories. "Dolby", "Pro Logic" and the double-D symbol are trademarks of Dolby Laboratories.

To enjoy Dolby Digital or DTS sound
Set "Digital Out" to "ON" in "Audio Setup" screen. See page E31.

"DTS" and "DTS Digital Out" are trademarks of Digital Theater Systems, Inc.

**Example:
Connecting to an Amplifier with Dolby Pro Logic Decoder**

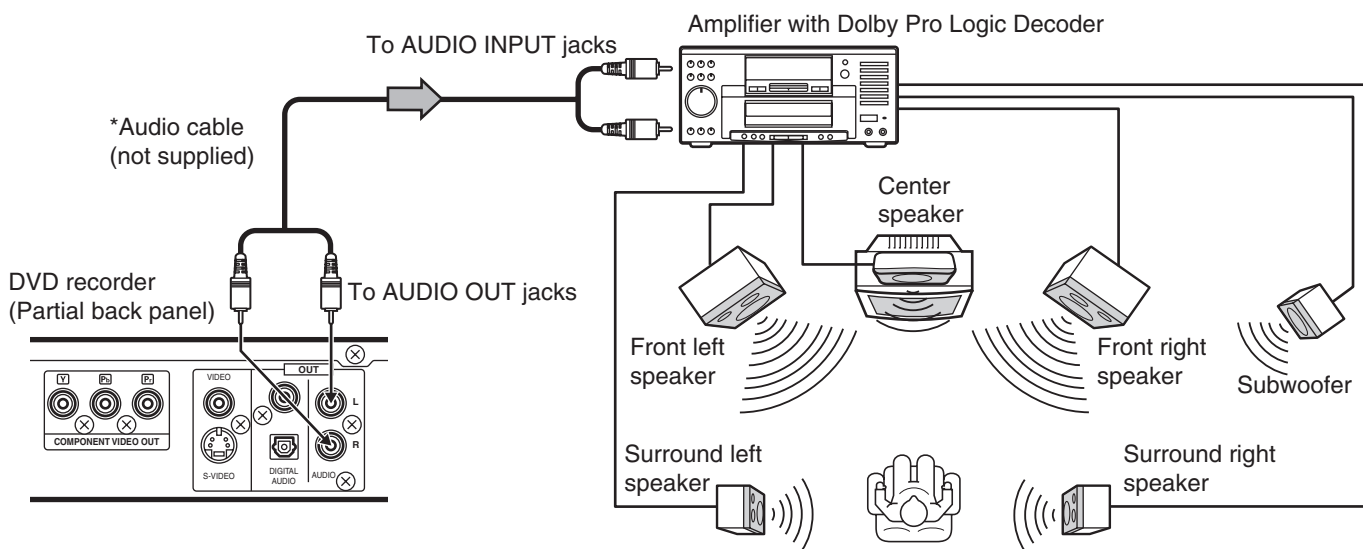

Note:
Please refer to your amplifier instruction manual.

*Please consult your local audio/video dealer.

Step 4: Connecting the Power Cord

Connect the power cord to a 120VAC 60Hz outlet. This unit is equipped with a polarized plug. If you have difficulty inserting the plug, turn it over and reinsert it. If the unit will not be used for a long time, disconnect the AC plug from the AC outlet.

Notes:

- Before plugging the power cord into an AC outlet, make sure that all the connections have been made.
- The unit is not disconnected from the AC power unless the power cord is unplugged from the AC outlet.

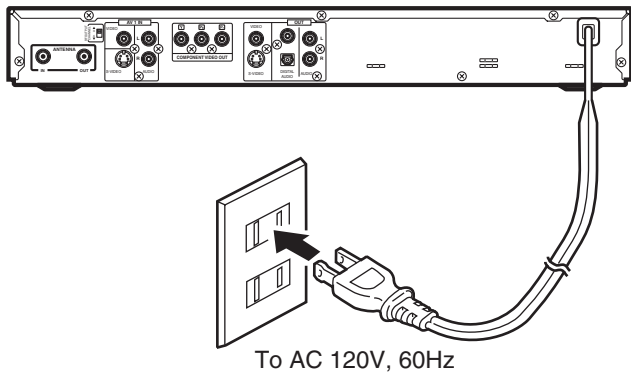

CAUTION:
TO PREVENT ELECTRIC SHOCK, MATCH WIDE BLADE OF PLUG TO WIDE SLOT, FULLY INSERT.

ATTENTION :
POUR ÉVITER LES CHOC ÉLECTRIQUES, INTRODUIRE LA LAME LA PLUS LARGE DE LA FICHE DANS LA BORNE CORRESPONDANTE DE LA PRISE ET POUSSER JUSQU' AU FOND.



**Need help? Call
1-800-813-3435**

Connecting a VCR or Similar Recording Equipment to This Unit

You can use this unit as the source player or as the recording deck.
 First, disconnect the AC power cord from an AC outlet.
 Connect a VCR or similar recording equipment to this unit as shown below.
 See also the owner's manual supplied with the connected equipment.

CAUTION:

Pictures containing copyright protection signals cannot be recorded.

Example:

Connection for recording from other equipment

Connect a VCR or similar recording equipment to the AV1 IN or AV2 IN jacks.
 See "AV Select" on page E32.

Note:

Do not connect the video (yellow) jack when using an S-video cable (not supplied).

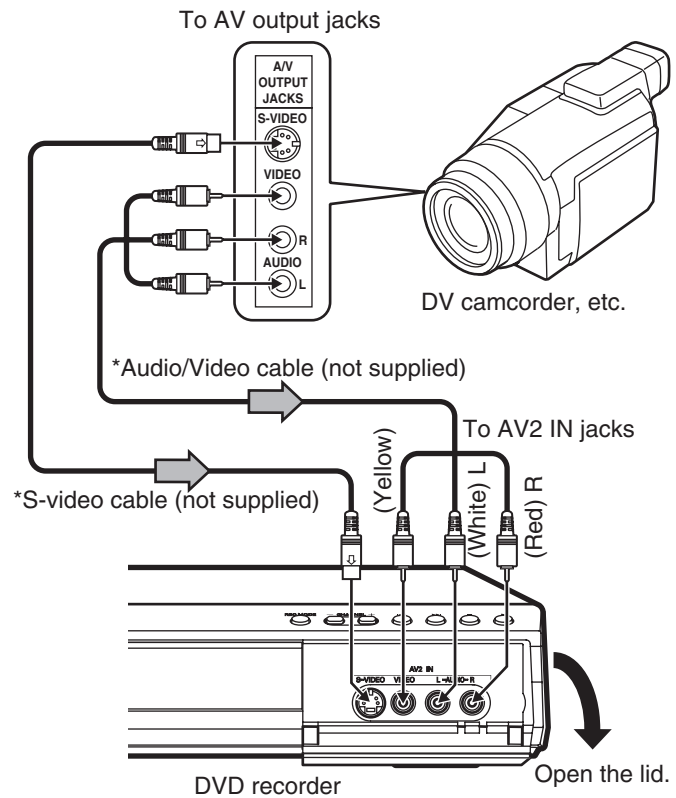
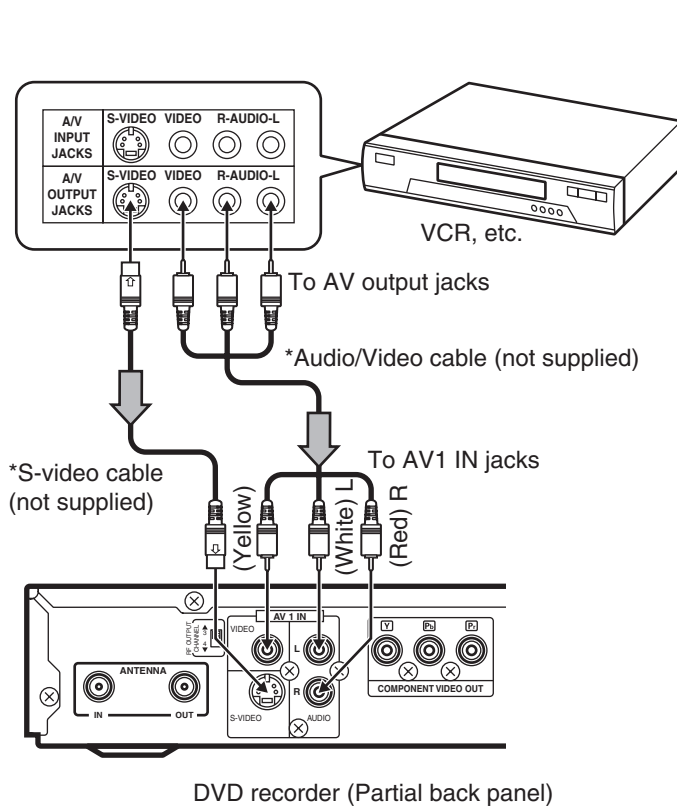

CAUTION:

Almost all videos and DVD softwares on sale have a copy-protection. You cannot record them using this unit.
 Video Games cannot be recorded.

*Please consult your local audio/video dealer.



**Need help? Call
 1-800-813-3435**

Example:

Connection for recording to other equipment

Connect a VCR or similar recording equipment to the OUT jacks.

Notes:

- Do not connect the video (yellow) jack when using an S-video cable (not supplied).
- If you pass the DVD recorder signals via the VCR, you may not receive a clear image on the TV screen.

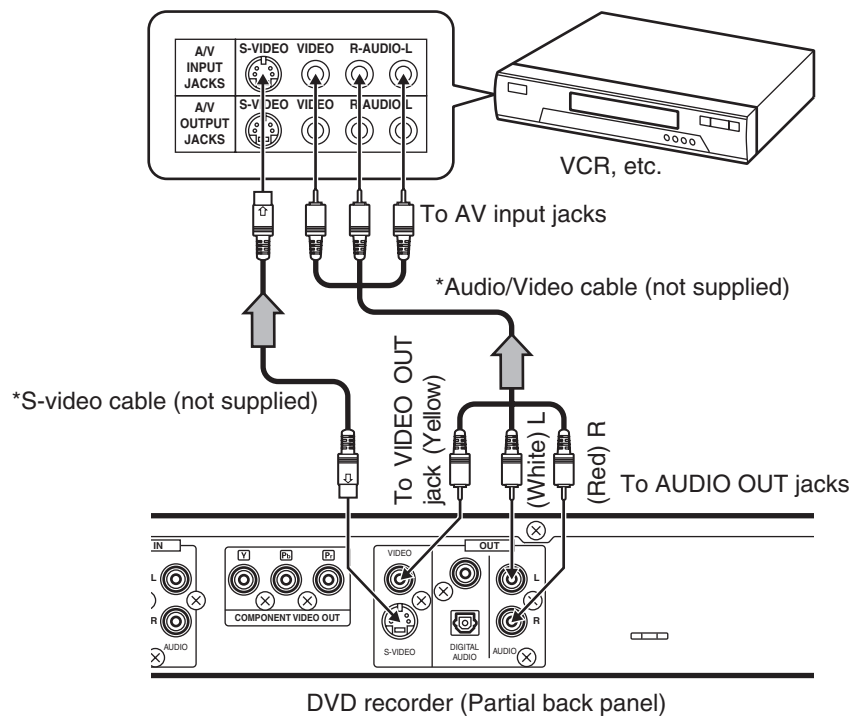

CAUTION:

Almost all videos and DVD softwares on sale have a copy-protection. You cannot record them using this unit.

*Please consult your local audio/video dealer.



**Need help? Call
1-800-813-3435**

Connecting to a Satellite Receiver or a Cable Box

Connect a satellite receiver, digital cable box, or cable box to this unit using the AV1 IN jacks. First, disconnect the AC power cord from an AC outlet. See also the owner's manual supplied with the connected equipment.

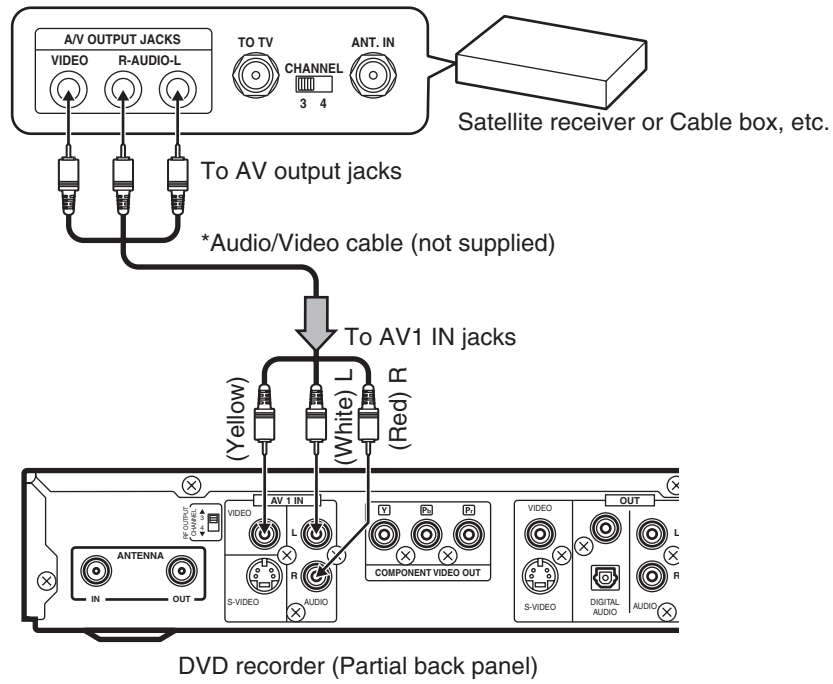

CAUTION:

Pictures containing copyright protection signals cannot be recorded.

*Please consult your local audio/video dealer.



**Need help? Call
1-800-813-3435**

SETTING THE CLOCK

When the unit is first connected to the AC outlet (“-- : --” may brink on the FL display), or after the power has failed, please follow the steps below.

Important Note:

This unit uses the International Time System (24-hour display). Therefore the unit does not have Daylight Saving Time (DST) function. You must set the clock when summer switches to winter and vice versa.

Preparations

Turn on the TV and select the appropriate video input to suit the connections to this unit. (Refer to your TV's owner manual.)

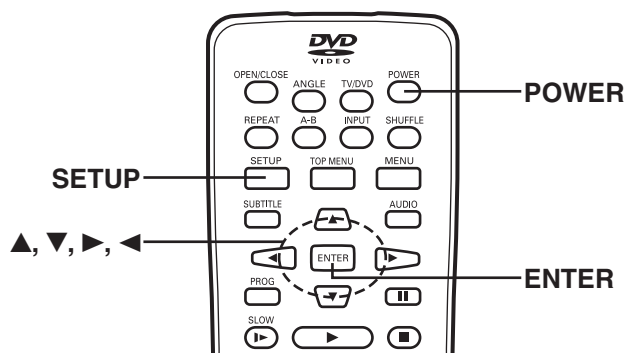

To Set the Clock

1. Press [POWER] to turn on the power.
 - “POWER ON” appears briefly on the FL display.
 - “SANYO” logo appears on the TV screen.
2. Press [SETUP] in “NO DISC” mode. “Menu” screen appears on the TV screen.

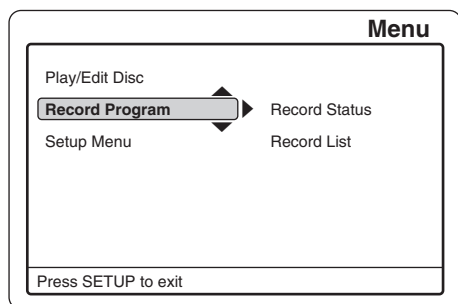

3. Press [▼] to select “Setup Menu”.

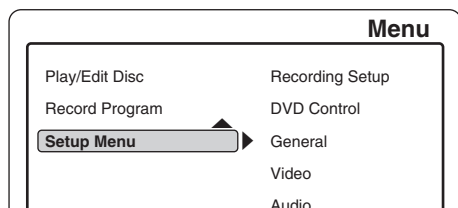

4. Press [ENTER] (or [▶]). “Recording Setup” is highlighted.
5. Press [ENTER] (or [▶]) again. “Recording Setup” screen appears.

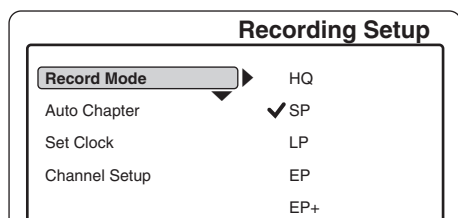

6. Press [▼] to select “Set Clock”.

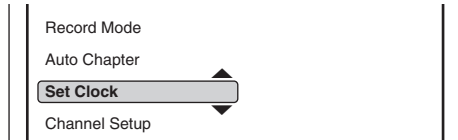

7. Press [ENTER] (or [▶]). “Set Clock Setup” screen appears. Example:

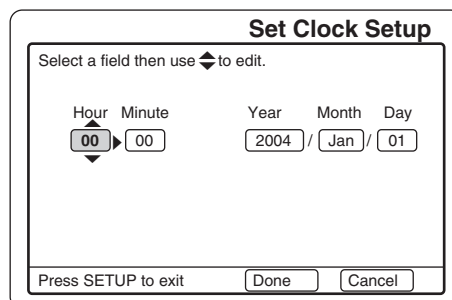

8. Press [▲], [▼], [▶] or [◀] repeatedly (or number buttons) to set the date and time. Example:

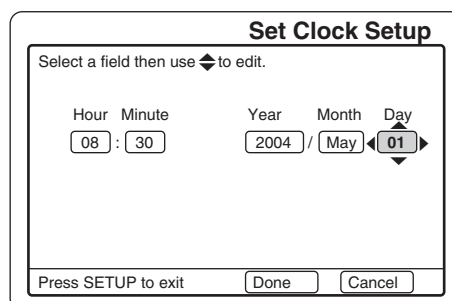

9. Press [▶] to select “Done”.

Note:
If you want to cancel it, press [▶] to select “Cancel”, and then press [ENTER]. “Recording Setup” screen returns.
10. Press [ENTER].
 - “Recording Setup” screen returns.
 - “Set Clock” is highlighted.
11. Press [SETUP]. “Recording Setup” screen disappears.
12. Press [POWER] to turn off the power. The clock appears on the FL display. Example: 08:30



TUNER SETTING

This unit is equipped with a channel memory feature which allows channels to skip up or down to the next channel set into memory, skipping over unwanted channels.

Before selecting channels, they must be programmed into the memory. In addition to normal VHF and UHF channels, this unit can receive up to 125 Cable TV channels. To use this unit with an antenna, set the "Channel Setup" menu.

Important Note:

- The antenna must be connected to this unit. See pages E8 ~ E10.
- You may need extra instructions during this setting. If a message appears, please follow the instructions displayed on the TV screen.
- For improvement, on-screen display subject to change without notice.

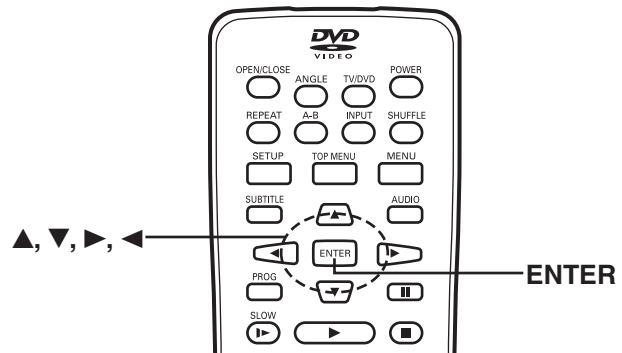

Setting "Channel Setup"

1. Open "Recording Setup" screen.
(Repeat steps 1 ~ 5 of "To Set the Clock" on page E18.)

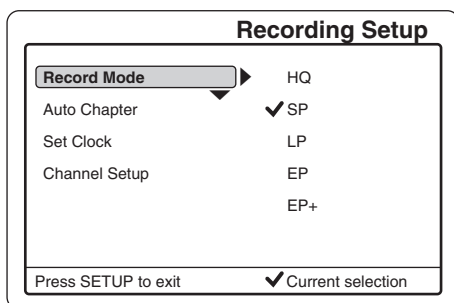

2. Press [▼] to select "Channel Setup".
3. Press [ENTER] (or [▶]) to select the sub menu.

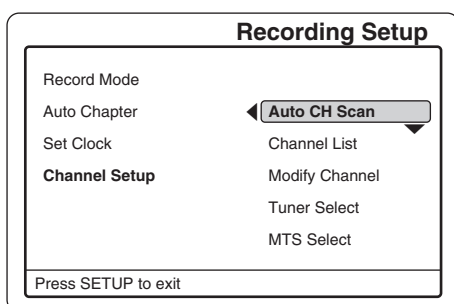

4. Press [▼] or [▲] to select the item.
 - Auto CH Scan** ==> See page E20.
 - Channel List** ==> See page E20.
 - Modify Channel** ==> See page E21.
 - Tuner Select** ==> See the right column.
 - MTS Select** ==> See page E21.

If you use this unit for first time, select "Tuner Select".

Tuner Select

Select the antenna system "CATV" or "TV".

- 1) Select "Tuner Select".

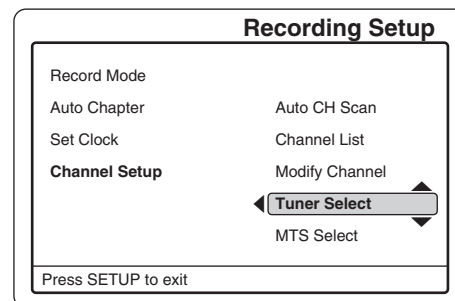

- 2) Press [ENTER] (or [▶]).
"Tuner Select Setup" screen appears.

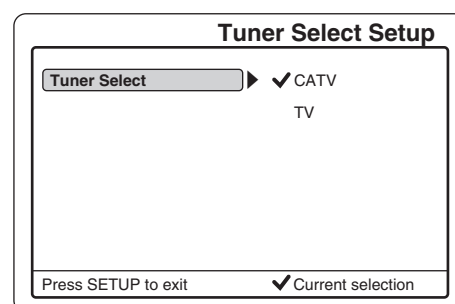

- 3) Press [▶] to select the sub menu.
- 4) Press [▼] or [▲] to select "CATV" or "TV".
- 5) Press [ENTER]. "√" appears.
- 6) Press [◀] repeatedly to return to "Recording Setup" screen.



Need help? Call
1-800-813-3435

Auto CH Scan

- 1) Select "Auto CH Scan".

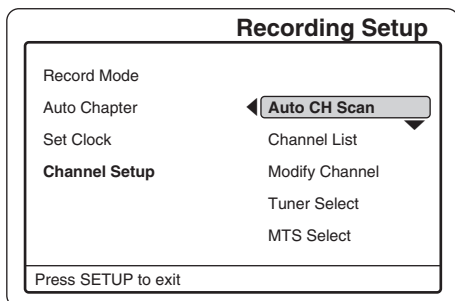

- 2) Press [ENTER] (or [▶]).
A message screen appears.

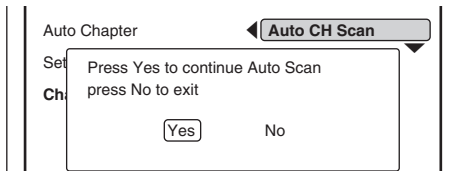

"Yes" is highlighted.

Note:

If you want to cancel it, press [▶] to select "No", and then press [ENTER].

- 3) Press [ENTER].
Auto memory channel scanning screen appears and starts to memorize all the channels available in your area.

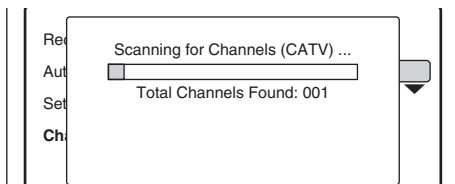

Please wait until the confirmation screen appears.



The confirmation screen appears.

Example:



"Yes" is highlighted.

Note:

If you don't want it, press [▶] to select "No", and then press [ENTER].

- 4) Press [ENTER].
"Channel List" screen appears. (Refer to the right column.)

Note:

If you want to receive or not receive the channel, press [▼] or [▲] to select the channel, and then press [ENTER]. "Enabled" or "Disabled" appears.

- 5) Press [◀] to return to "Recording Setup" screen.

Channel List

- 1) Select "Channel List".

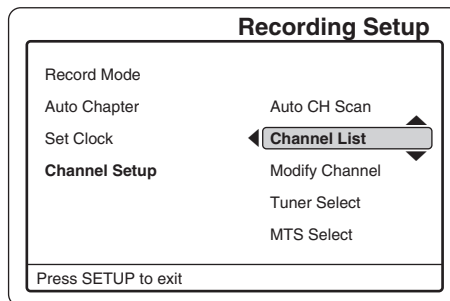

- 2) Press [ENTER] (or [▶]).
"Channel List" screen appears.
Example:

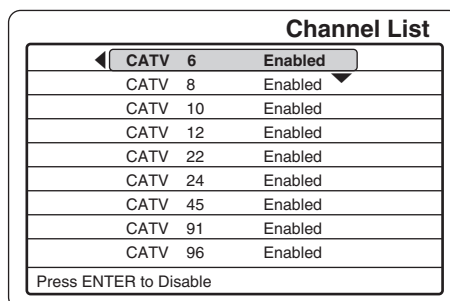

Note:

If you want to receive or not receive the channel, press [▼] or [▲] to select the channel, and then press [ENTER]. "Enabled" or "Disabled" appears.

- 3) Press [◀] to return to "Recording Setup" screen.

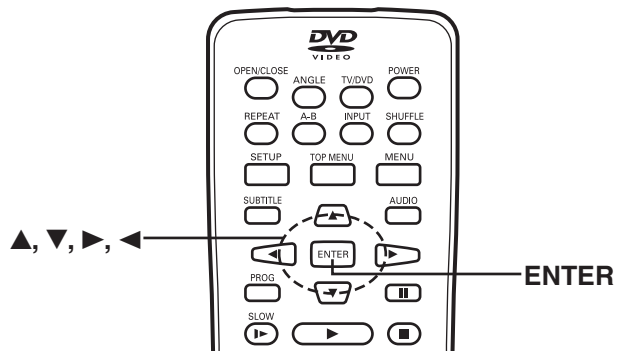

Need help? Call
1-800-813-3435

Modify Channel

- 1) Select "Modify Channel".

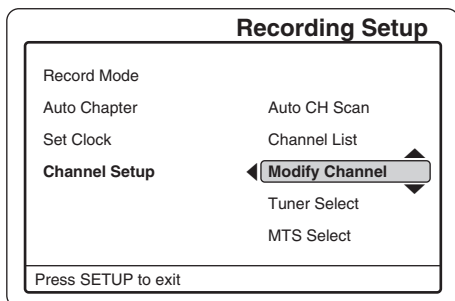

- 2) Press [ENTER] (or [▶]).
"CATV Modify Channel" or "TV Modify Channel" screen appears.
Example:

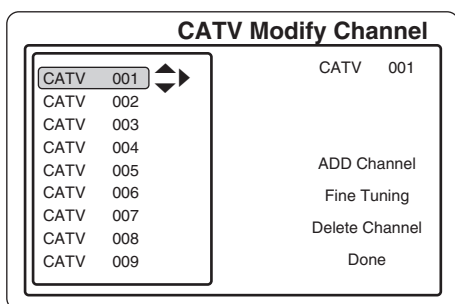

- 3) Press [▼] or [▲] to select the desired channel to be modified.
- 4) Press [▶] to select the sub menu.
"ADD Channel" is highlighted.
- 5) Press [▼] or [▲] to select "ADD Channel", "Fine Tuning" or "Delete Channel", and then press [ENTER].

ADD Channel

The channel is added.

Fine Tuning

"Fine Tuning" screen appears.

Press [▶] or [◀] to adjust it.

Press [▼] to select "Done" and then press [ENTER].

(To cancel it, select "Cancel" and then press [ENTER].)

Delete Channel

The channel is deleted.

- 6) Repeat these steps as necessary.

After the setting is completed, select "Done", and then press [ENTER]. "Recording Setup" screen returns.

If you want to confirm the channel, open the "Channel List" screen. (See the previous page.)

MTS (Multi-channel TV Sound) Select

This unit is equipped with a feature known as Multi-channel TV Sound or MTS. MTS broadcasts greatly enhance TV viewing by bringing you programs with high fidelity stereo sound.

MTS also provides an extra channel called the Second Audio Program or SAP which broadcasters can use to transmit a second language for bilingual transmission or for other purposes.

- 1) Select "MTS Select".

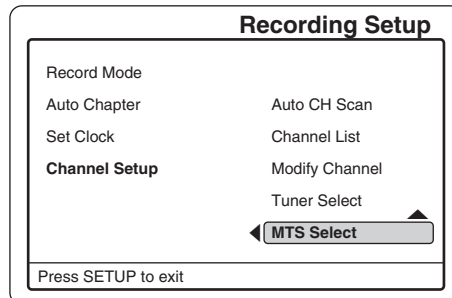

- 2) Press [ENTER] (or [▶]).
"MTS Select Setup" screen appears.

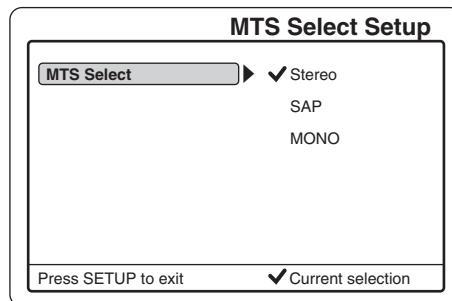

- 3) Press [▶] to select the sub menu.
- 4) Press [▼] or [▲] to select "Stereo", "SAP" or "MONO".
Usually select "Stereo".
- 5) Press [ENTER].
"/" appears.
- 6) Press [◀] repeatedly to return to "Recording Setup" screen.

Note:

Press [SETUP] to close the screen.

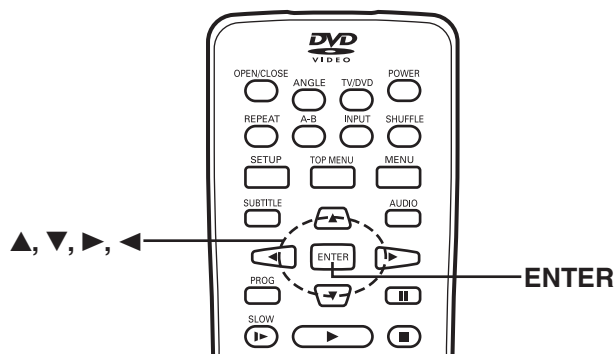

BEFORE INITIAL SETTING

Common Procedure

- See "SETTING THE CLOCK" on pages E18 and "TUNER SETTING" on pages E19 first.
 - Turn on the TV and select the appropriate video input to suit the connections to this unit. (Refer to your TV's owner manual.)
 - Press [■] before setting if the unit is receiving the TV program.
1. Press [POWER] to turn on the power.
 - "POWER ON" appears briefly on the FL display.
 - "SANYO" logo appears on the TV screen.
 2. Press [SETUP] in "NO DISC" mode or full stop mode. "Menu" screen appears on the TV screen.
 3. Press [▼] (or [▲]) to select the desired menu and go to the reference page.

Important Note:

- In this instruction manual, the language in on-screen display is English.
- If you change the language, please follow the selected language in on-screen display.
- You may need extra instructions during the setting. If a message appears, please follow the instructions displayed on the TV screen.
- For improvement, on-screen display subject to change without notice.

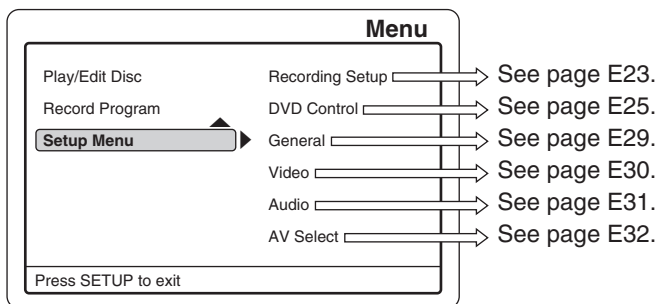
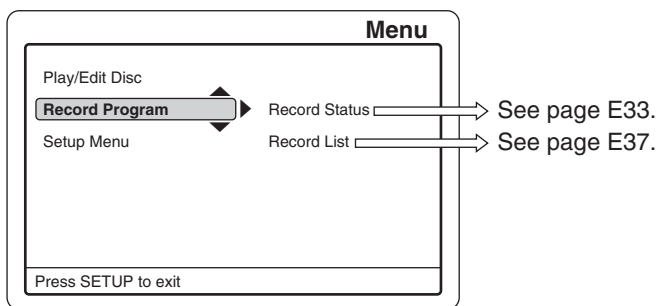

Note:
When a disc is loaded, "Play/Edit Disc" can be selected.

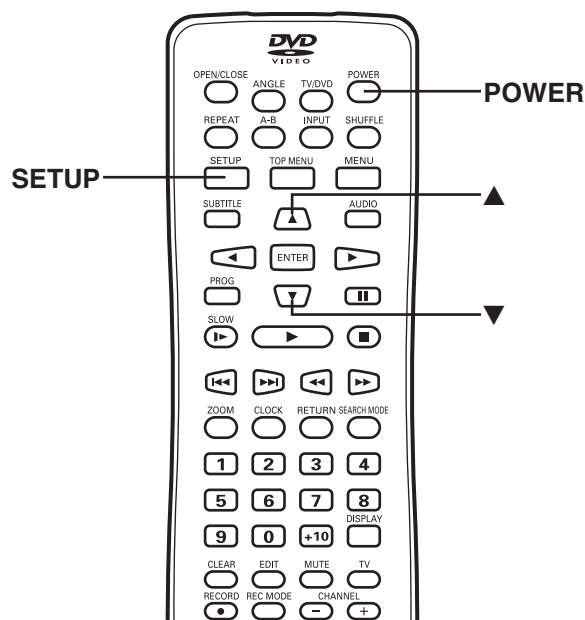
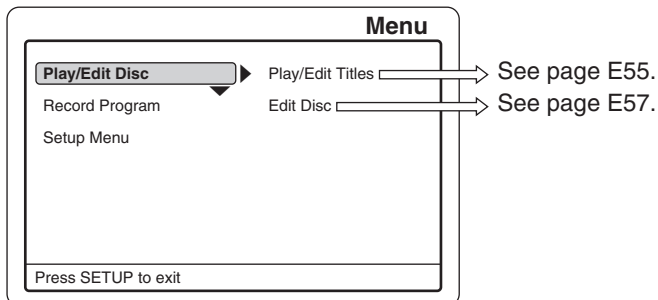

Need help? Call
1-800-813-3435

INITIAL SETTINGS

Recording Setup

This is a setup for recording on a DVD+RW or DVD+R disc.

Preparations

(Recording Setup ---> Record Mode & Auto Chapter)

1. Select "Setup Menu" in "Menu" screen. See page E22.

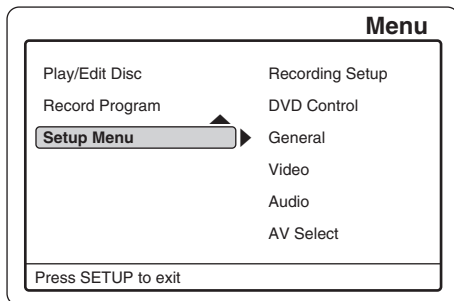

2. Press [ENTER] (or [▶]).
"Recording Setup" is highlighted.
3. Press [ENTER] (or [▶]) again.
"Recording Setup" screen appears.

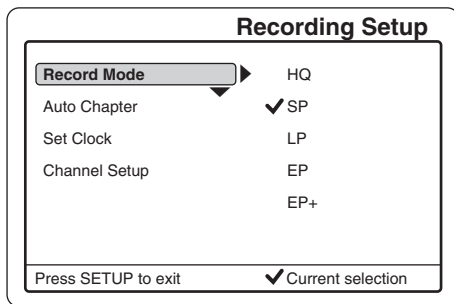

4. Press [▲] or [▼] to select the item.

Record Mode	====>	See the right column.
Auto Chapter	====>	See page E24.
Set Clock	====>	See page E18.
Channel Setup	====>	See page E19.

Setting "Record Mode"

1. Select "Record Mode".

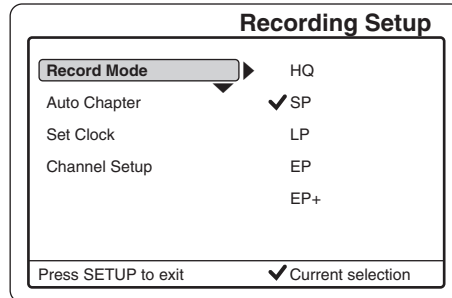

2. Press [ENTER] (or [▶]) to select the sub menu.

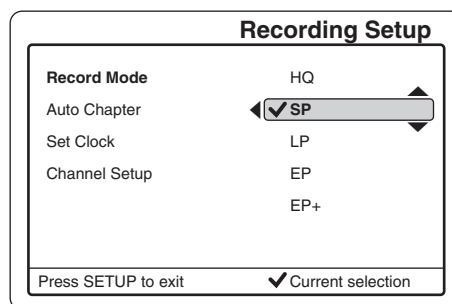

3. Press [▼] or [▲] to select the desired record mode.

Record mode	Record time (minutes)
HQ:	60
SP (Standard mode):	120
LP:	180
EP:	240
EP+:	360

Please note the following:

- The record times are an estimate and actual times may differ.
- The record time may differ depending on the recording conditions.
 - Recording a program with poor reception, or a program or video source of low picture quality
 - Recording on a disc that has already been edited
 - Recording only a still picture or just sound

4. Press [ENTER].
"√" appears.
The record mode is set.
5. Press [◀] to return to "Record Mode".

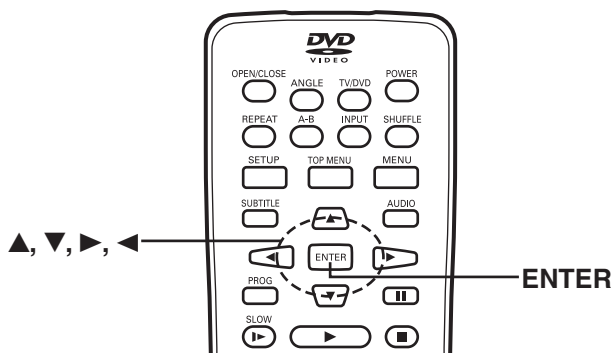

**Need help? Call
1-800-813-3435**

Setting "Auto Chapter"

When recording starts, the chapters in the title are made automatically on the disc by this setting.

1. Select "Auto Chapter".

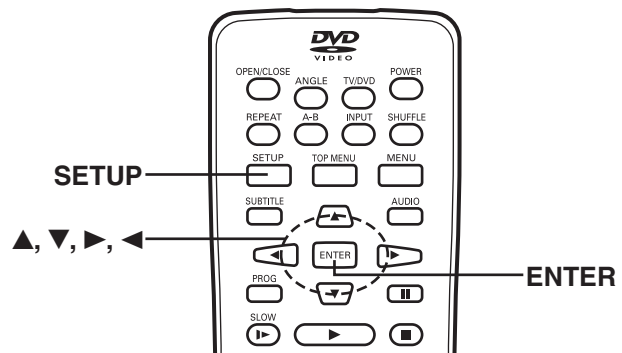
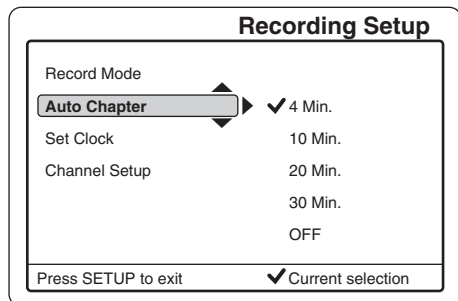

2. Press [ENTER] (or [▶]) to select the sub menu.
3. Press [▼] or [▲] to select the desired time.
4. Press [ENTER].
"✓" appears.
5. Press [◀] to return to "Auto Chapter".

Notes:

- To set "Set Clock", see "SETTING THE CLOCK" on page E18.
- To set "Channel Setup", see "TUNER SETTING" on page E19.
- Press [◀] again to return to "Menu" screen.
- Press [SETUP] to close the screen.



Need help? Call
1-800-813-3435



DVD Control

This is a setup for playing back DVD-Video discs.

Preparations

(DVD Control ---> Disc Menu, Angle Mark, Audio, Subtitle & Parental Control)

1. Select "Setup Menu" in "Menu" screen. See page E22.

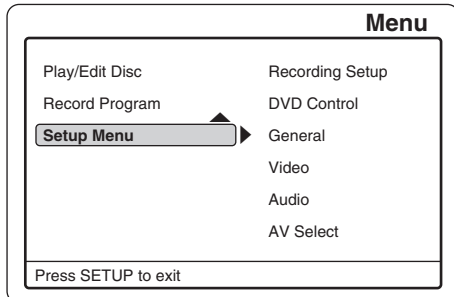

2. Press [ENTER] (or [▶]).
"Recording Setup" is highlighted.
3. Press [▼] to select "DVD Control".
4. Press [ENTER] (or [▶]).
"DVD Control Setup" screen appears.



5. Press [▲] or [▼] to select the item.
Disc Menu ==> See the right column.
Angle Mark ==> See page E26.
Audio ==> See page E26.
Subtitle ==> See page E26.
Parental Control ==> See page E27.

Setting "Disc Menu"

1. Select "Disc Menu".

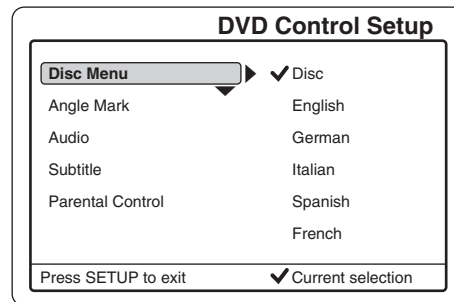

2. Press [ENTER] (or [▶]) to select the sub menu.

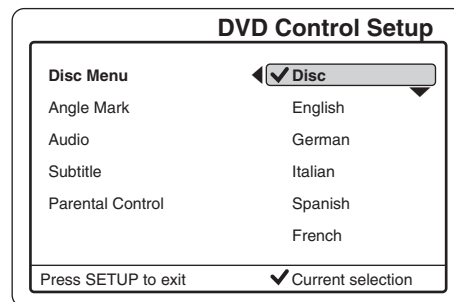

3. Press [▼] or [▲] to select the desired language.
Note:
Disc: The first priority language of the disc
4. Press [ENTER].
"√" appears.
The disc menu language is set.
5. Press [◀] to return to "Disc Menu".

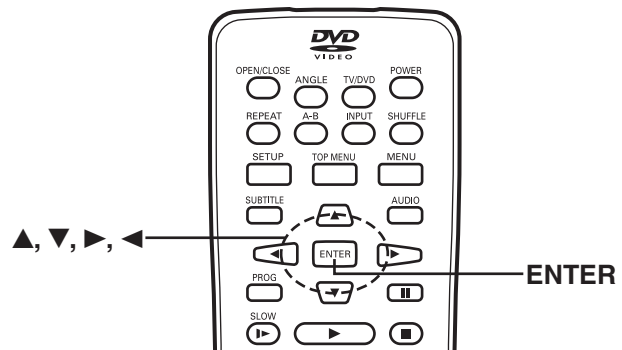

**Need help? Call
1-800-813-3435**

Setting "Angle Mark"

To show the angle mark when playing back DVD-Video discs (recorded with multi-angle), select this setting.

1. Select "Angle Mark".

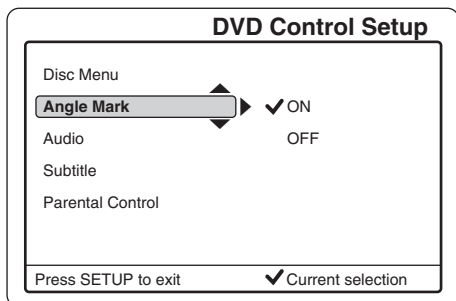

2. Press [ENTER] (or [▶]) to select the sub menu.

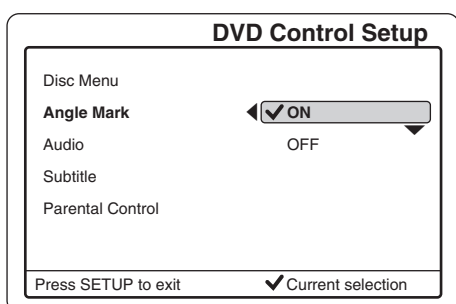

3. Press [▼] or [▲] to select "ON" or "OFF".

4. Press [ENTER]. "✓" appears.

5. Press [◀] to return to "Angle Mark".

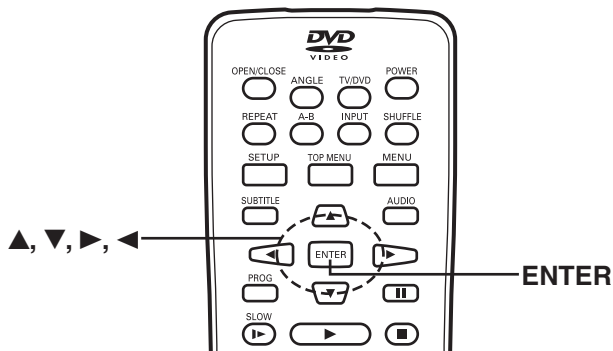

Setting "Audio"

1. Select "Audio".

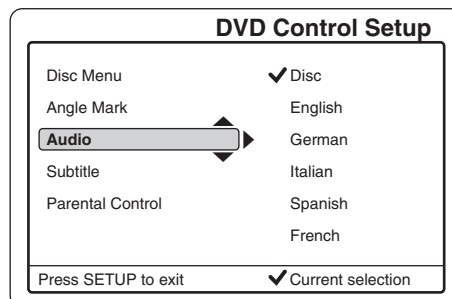

2. Press [ENTER] (or [▶]) to select the sub menu.



3. Press [▼] or [▲] to select the desired language.

Note:

Disc: The first priority language of the disc

4. Press [ENTER]. "✓" appears.

5. Press [◀] to return to "Audio".

Setting "Subtitle"

1. Select "Subtitle".

2. Repeat the same steps as described in "Setting Audio".



Need help? Call
1-800-813-3435

Setting "Parental Control"

Notes:

- "Password" is set to "0000" before shipping from the factory.
- You may need extra instructions during the setting. If a message appears, please follow the instructions displayed on the TV screen.

1. Select "Parental Control".

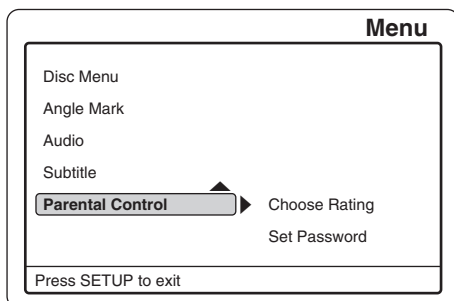

2. Press [ENTER] (or [▶]) to select the sub menu.

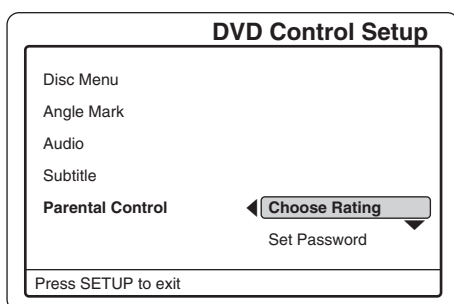

3. Press [▼] or [▲] to select "Choose Rating" or "Set Password".

Choosing Rating

- 1) Select "Choose Rating".
- 2) Press [ENTER] (or [▶]).
"Parental Control Set" screen appears.

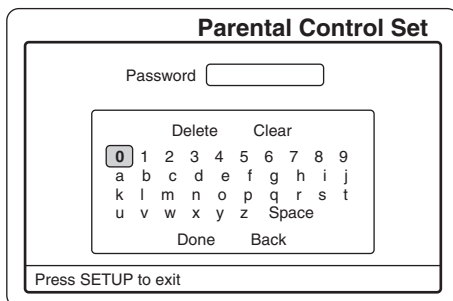

Note:

If you want to cancel the setting, select "Back", and press [ENTER]. "DVD Control Setup" screen returns.

- 3) Press the directional arrow button (▶, ◀, ▲, ▼), and press [ENTER] to enter the password.

Note:

If you use this unit for first time, enter [0], [0], [0] and [0]. Because the initial password is set "0000" before shipping from the factory.

- 4) Press [▼] to select "Done".
- 5) Press [ENTER].
The parental lock level screen appears.
Example:

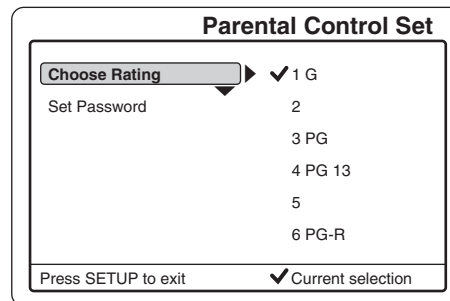

- 6) Press [ENTER] (or [▶]) to select the sub menu.
- 7) Press [▼] or [▲] to select the parental lock level.

Parental Control

MPAA (Motion Picture Association of America) Guideline is a rating system that provides advanced cautionary information to parent about the content of movie programs.

The parental lock level is equivalent to the following MPAA Rating System.

- 1 G (General audiences)
- 3 PG (Parental guidance suggested)
- 4 PG-13 (Parents strongly cautioned)
- 6 PG-R (Restricted)
- 7 NC-17 (No one 17 and under admitted)
- 8 Adult
- No Parental

Some DVD-Video discs contain a restriction level which enables parents to prevent playback of discs by children. This unit is equipped with a password designed to prevent children changing the level.

You cannot play DVD-Video discs rated higher than the level you selected unless you cancel the parental lock function.

For example, when you select level "5", the unit will not play discs with ratings of "6", "7" or "8".

The information will appear on the TV screen.

If you forget the password...

1. Enter [+10],[+10],[+10], and [+10]. (The numbers do not appear in the box.)
It returns to the original factory setting "0000".
2. Enter a new password and set the parental lock level again.

Note:

DVD video discs may or may not respond to the parental lock settings. Make sure this function works with your DVD video discs.

- 8) Press [ENTER]. "✓" appears.
- 9) Press [◀] twice to return to "DVD Control Setup" screen.

Set Password

- 1) Select "Set Password".
 - 2) Press [ENTER] (or [▶]).
- "Parental Control Set" screen appears.

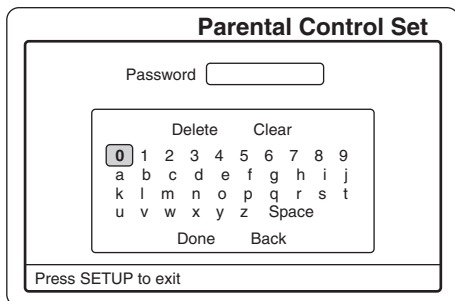

Note:

If you want to cancel it, select "Back", and then press [ENTER]. "DVD Control Setup" screen returns.

- 3) Enter the password.
(Please refer to "Choosing Rating" on the previous page. If you use this unit for first time, enter [0], [0], [0] and [0].)
 - 4) Press [▼] repeatedly to select "Done".
 - 5) Press [ENTER].
- The parental lock level screen appears.

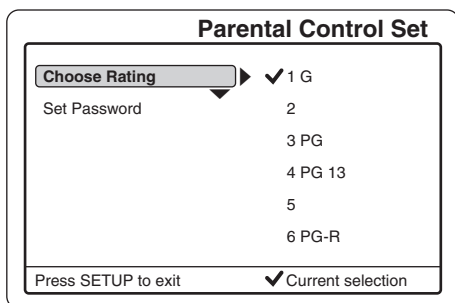

- 6) Press [▼] to select "Set Password".

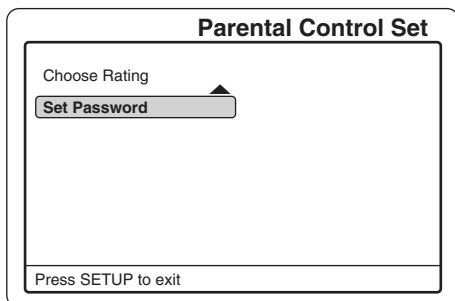

- 7) Press [ENTER].
- "New Password" screen appears.

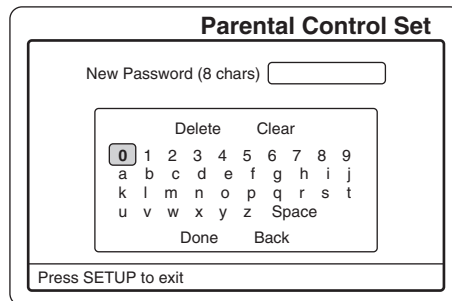

- 8) Press the directional arrow button (▶, ◀, ▲, ▼), and press [ENTER] to enter the new password (maximum 8 characters or numbers).
 - 9) Press [▼] to select "Done".
 - 10) Press [ENTER].
- "Confirm Password" screen appears.
- 11) Press [▲] to return to the character list.
 - 12) Enter the same password as above.
 - 13) Press [▼] to select "Done".
 - 14) Press [ENTER].
- The new password is set.

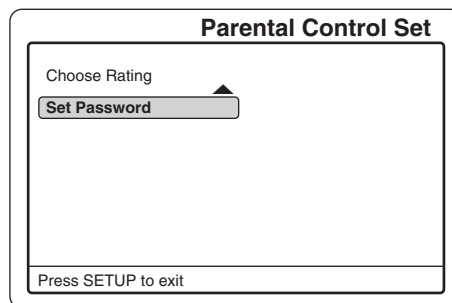

- 15) Press [◀] to return to "DVD Control Setup" screen.

Notes:

- If you want to cancel the setting, select "Back", and then press [ENTER]. "DVD Control Setup" screen returns.
- Press [SETUP] to close the screen.

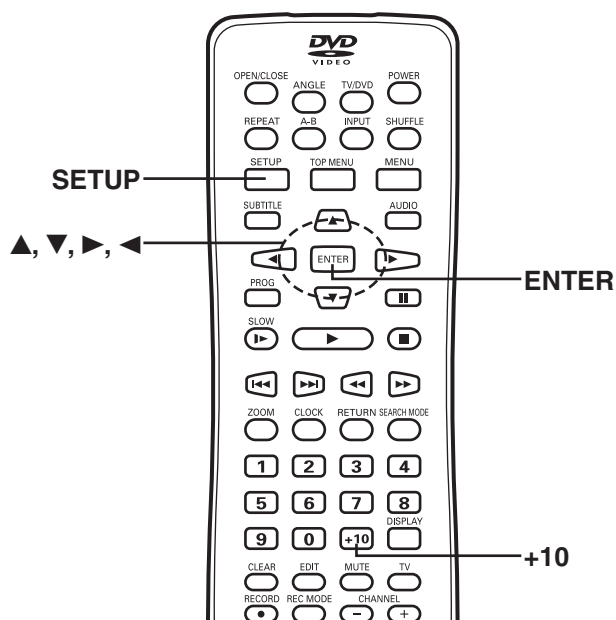
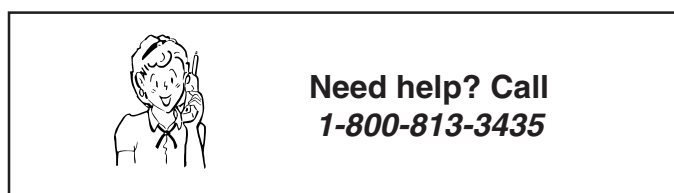



General

This is on-screen language setting.

In this instruction manual, the language in on-screen display is English.

If you change the language, please follow the selected language in on-screen display.

Preparations

(General ---> Menu Language)

1. Select "Setup Menu" in "Menu" screen. See page E22.

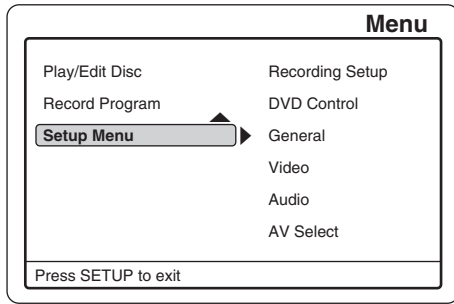

2. Press [ENTER] (or [▶]).
"Recording Setup" is highlighted.

3. Press [▼] to select "General".

4. Press [ENTER] (or [▶]).
"General Setup" screen appears.

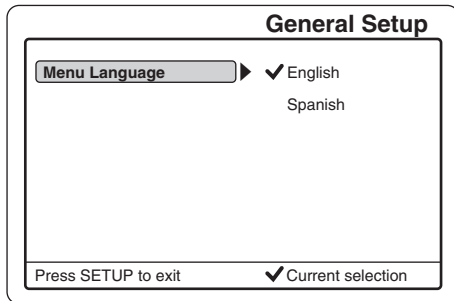

Setting "Menu Language"

1. Press [ENTER] (or [▶]) to select the sub menu.

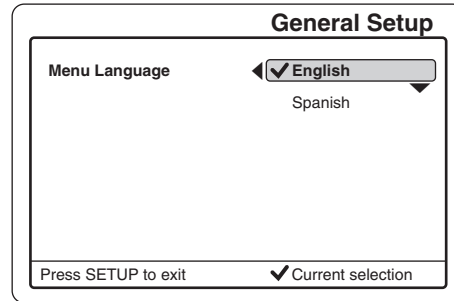

2. Press [▼] or [▲] to select the desired language.

3. Press [ENTER].
"√" appears.
The menu language is set.

4. Press [◀] to return to "Menu Language".

Notes:

- Press [◀] again to return to "Menu" screen.
- Press [SETUP] to close the screen.

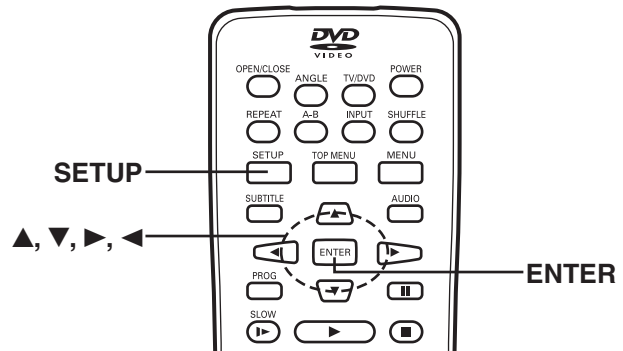

Need help? Call
1-800-813-3435



Video

In this section, select the playback picture size according to the aspect ratio of the TV,

Preparations

(Video ---> TV Display)

1. Select "Setup Menu" in "Menu" screen. See page E22.

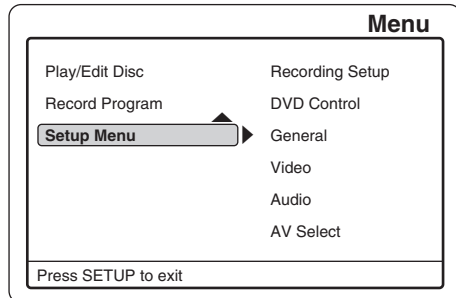

2. Press [ENTER] (or [▶]).
"Recording Setup" is highlighted.
3. Press [▼] to select "Video".
4. Press [ENTER] (or [▶]).
"Video Setup" screen appears.

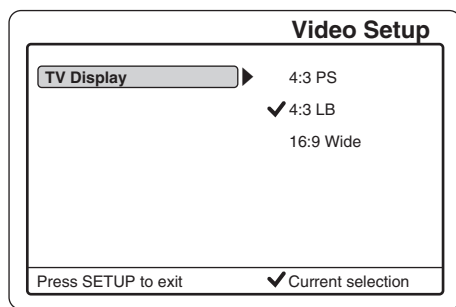

Setting "TV Display"

1. Press [ENTER] (or [▶]) to select the sub menu.

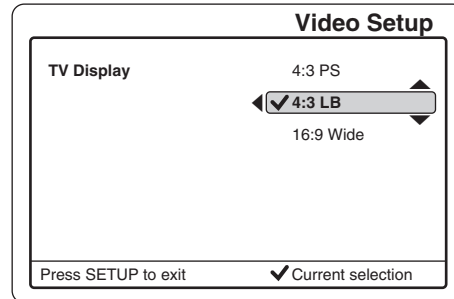

2. Press [▼] or [▲] to select the appropriate setting for your TV screen size.

4:3 PS (Panscan):

Select when a conventional TV set is connected.

When the wide screen disc is played back, it displays pictures cropped to fill to your TV screen. The left and right edges are cut off.

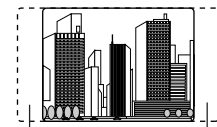

Cut off Cut off

4:3 LB (Letterbox):

Select when a conventional TV set is connected.

When the wide screen disc is played back, the black bands appear at the top and bottom of screen.



16:9 Wide:

Select when a wide screen TV set is connected.

Played in "FULL" size. (Setting the wide screen TV to "FULL" mode is also necessary.)

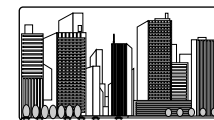

Notes:

- The screen size may differ depending on the DVD video discs.
- If you select 16:9 Wide to get rid of the black bands on screen when wide screen disc is played back, picture may be slightly distorted.
- In some discs, even if 4:3 PS is selected, the black bands may remain on the screen.

3. Press [ENTER]. "✓" appears.

4. Press [◀] to return to "TV Display".

Notes:

- Press [◀] again to return to "Menu" screen.
- Press [SETUP] to close the screen.

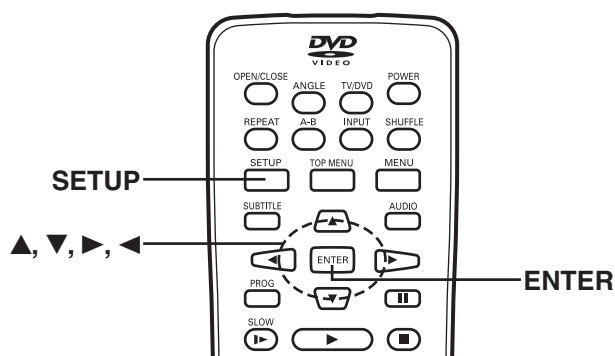

Need help? Call
1-800-813-3435



Audio

Preparations

(Audio ---> Digital Out & DRC)

1. Select "Setup Menu" in "Menu" screen. See page E22.

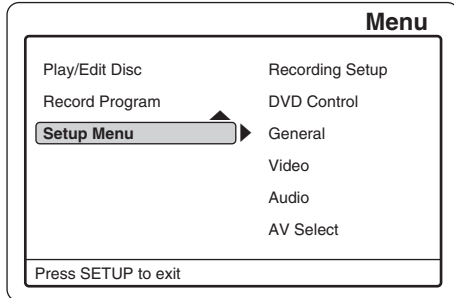

2. Press [ENTER] (or [▶]).
"Recording Setup" is highlighted.
3. Press [▼] to select "Audio".
4. Press [ENTER] (or [▶]).
"Audio Setup" screen appears.

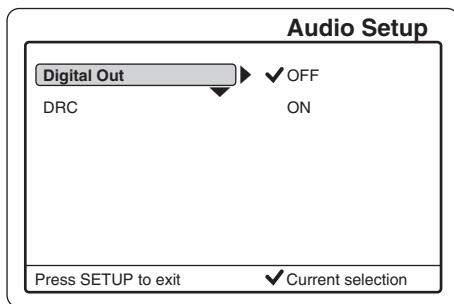

5. Press [▼] or [▲] to select "Digital Out" or "DRC".

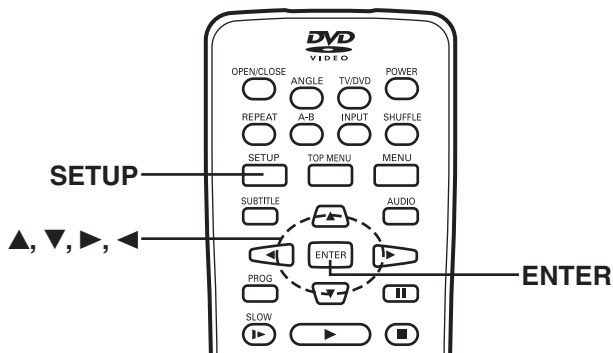

Need help? Call
1-800-813-3435

Setting "Digital Out"

If the coaxial or optical DIGITAL AUDIO OUT jack is connected to the digital amplifier, you must set as follows:

1. Select "Digital Out".
2. Press [ENTER] (or [▶]) to select the sub menu.

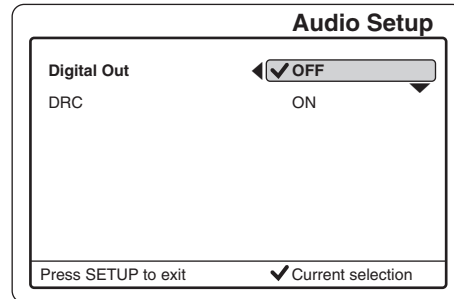

3. Press [▼] or [▲] to select "ON" or "OFF".
4. Press [ENTER]. "✓" appears.
5. Press [◀] to return to "Digital Out".

Setting "DRC (Dynamic Range Control)"

1. Select "DRC".

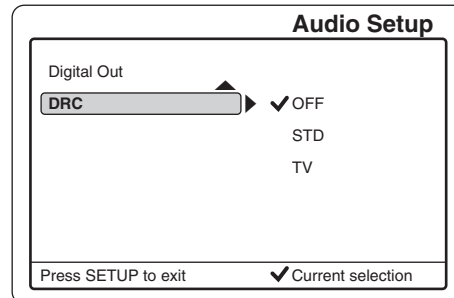

2. Press [ENTER] (or [▶]) to select the sub menu.

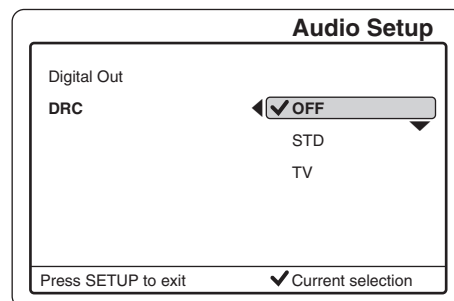

3. Press [▼] or [▲] to select "OFF", "STD" or "TV".
OFF: Off position
STD: When connecting the amplifier to the AUDIO OUT jacks (not DIGITAL AUDIO OUT jacks)
TV: When using 3 or 4 channel on TV
4. Press [ENTER].
"✓" appears.
5. Press [◀] to return to "DRC".

Notes:

- Press [◀] again to return to "Menu" screen.
- Press [SETUP] to close the screen.



AV Select

When the 1st AV input (AV1 IN) or 2nd AV input (AV2 IN) jacks are connected, you must set as follows:

Preparations

(AV Select ---> AV1 Select & AV2 Select)

1. Select "Setup Menu" in "Menu" screen. See page E22.

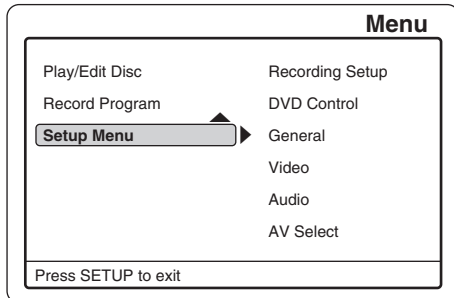

2. Press [ENTER] (or [▶]).
"Recording Setup" is highlighted.
3. Press [▼] to select "AV Select".
4. Press [ENTER] (or [▶]).
"AV Select" screen appears.

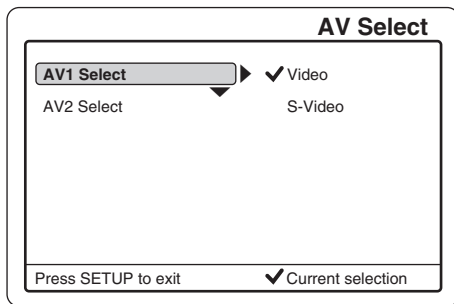

Setting "AV1 Select" and "AV2 Select"

1. Press [▼] or [▲] to select "AV1 Select" or "AV2 Select".
AV1 Select: When AV1 IN jacks are used
AV2 Select: When AV2 IN jacks are used
2. Press [ENTER] (or [▶]) to select the sub menu.

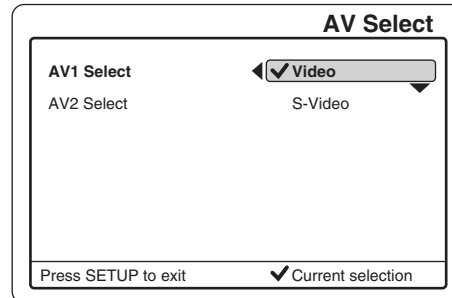

3. Press [▼] or [▲] to select the video input jack.
Video: Using VIDEO input jack
S-Video: Using S-VIDEO input jack
4. Press [ENTER]. "√" appears.
5. Press [◀] to return to "AV1 Select" or "AV2 Select".
6. Repeat steps 1 ~ 5 as necessary.

Notes:

- Press [◀] again to return to "Menu" screen.
- Press [SETUP] to close the screen.

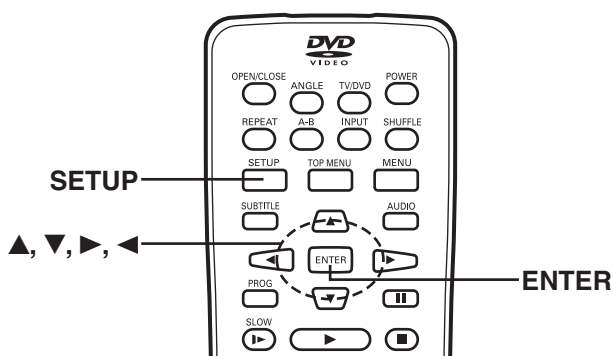

Need help? Call
1-800-813-3435



Record Status

The program timer switches the unit on and off to record a TV program at a preset time.

You can program a total of 15 times slots to be recorded, during the next one-year period.

These settings are retained in the program memory and will repeat as long as a recordable disc is loaded in the unit.

Note:

The clock must be set before this setting. See "SETTING THE CLOCK" on page E18.

Preparations

(Record Status ---> Record Time, Record Day, Input Source, TV, Record Mode & Title)

1. Select "Record Program" in "Menu" screen. See page E22.

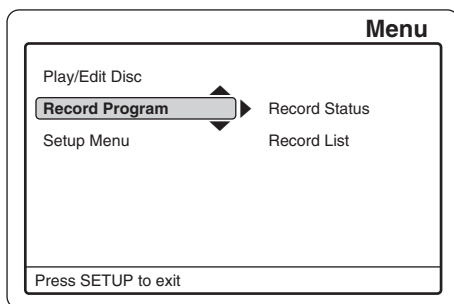

2. Press [ENTER] (or [▶]). "Recording Status" is highlighted.

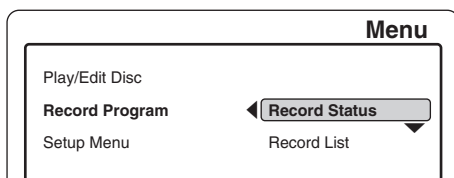

3. Press [ENTER] (or [▶]) again. "Record Show" screen appears. Example:

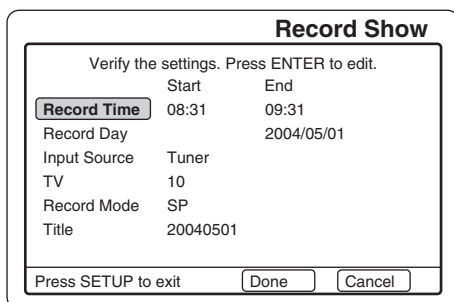

4. Press [▲] or [▼] to select the item.
Record Time ==> See the right column.
Record Day ==> See page E34.
Input Source ==> See page E35.
TV ==> See page E35.
Record Mode ==> See page E36.
Title ==> See page E36.

Note:

After all settings are completed, press [▼] to select "Done", and then press [ENTER].

Setting "Record Time"

Note:

If you have set "Record Status" already, open "Record List" to check the list. Remove the unnecessary program from the list first. See page E37.

1. Select "Record Time". Example:

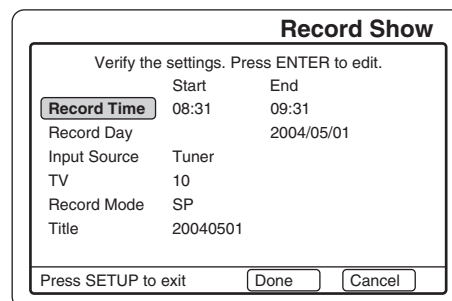

2. Press [ENTER]. The start and end time screen appears. Example:

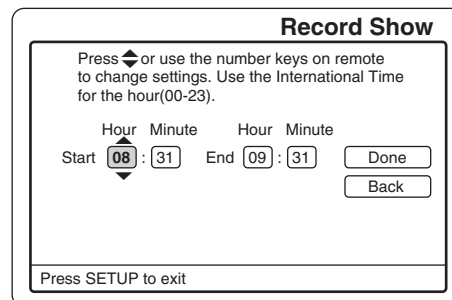

3. Press [▲] or [▼] (or the number buttons on the remote control) to set the start and end times.

Note:

Press [▶] or [◀] to move the cursor.

4. Press [▶] to select "Done".

5. Press [ENTER]. The record time is set. The screen returns. Example:

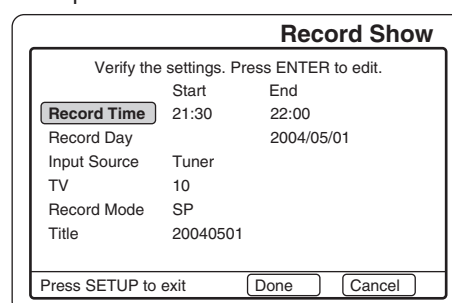

Note:

To cancel the setting, select "Back" or "Cancel" in the screen, and then press [ENTER].

Setting "Record Day"

1. Select "Record Day".

Example:

Record Show

Verify the settings. Press ENTER to edit.

	Start	End
Record Time	21:30	22:00
Record Day	2004/05/01	
Input Source	Tuner	
TV	10	
Record Mode	SP	
Title	20040501	

Press SETUP to exit

2. Press [ENTER].

The calendar screen appears.

Record Show

Press \blacktriangle or use the number keys on remote to change settings.

Year Month Day

2004 05 01

S	M	T	W	Th	F	Sa
						1
2	3	4	5	6	7	8
9	10	11	12	13	14	15
16	17	18	19	20	21	22
23	24	25	26	27	28	29
30	31					

Press SETUP to exit

3. Press [\blacktriangle] or [\blacktriangledown] (or the number buttons on the remote control) to set the record date ("Year", "Month" and "Day").

Note:

Press [\blacktriangleright] or [\blacktriangleleft] to move the cursor.

4. Press [\blacktriangleright] to select "Done".

5. Press [ENTER].

The record date is set.

The screen returns.

Example:

Record Show

Verify the settings. Press ENTER to edit.

	Start	End
Record Time	21:30	22:00
Record Day	2004/05/03	
Input Source	Tuner	
TV	10	
Record Mode	SP	
Title	20040503	

Press SETUP to exit

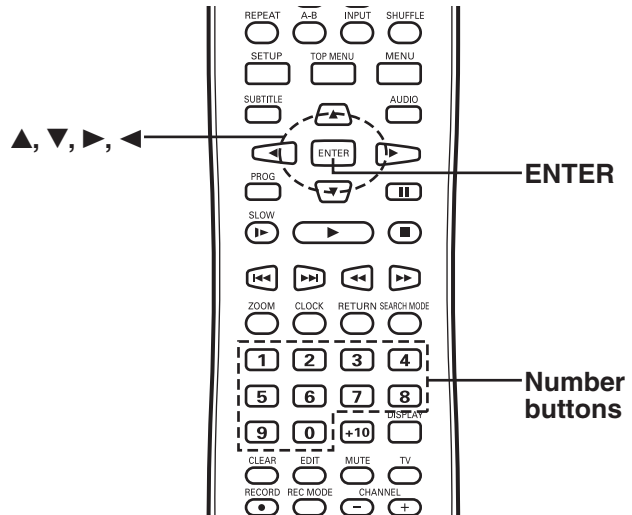

Important Note:

You may need extra operations during the setting. If a message appears, please follow the instructions displayed on the TV screen.



Need help? Call
1-800-813-3435

Important Information

To set the timer recording, leave two minutes in between programs. For example if the program is scheduled to end at 8:00 am, the next recording should be scheduled for 8:02 am.

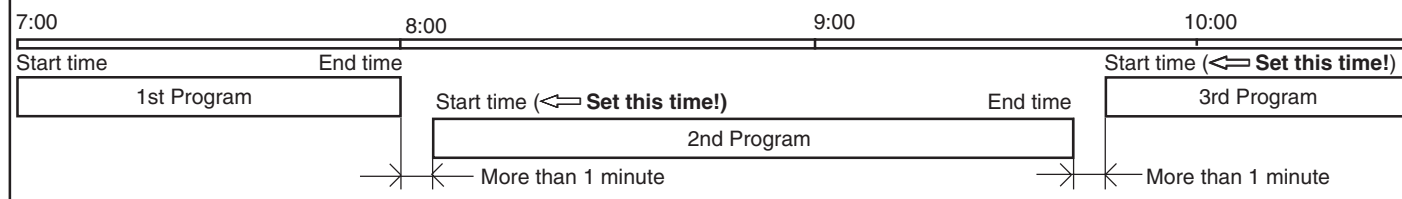

Setting "Input Source"

1. Select "Input Source".
Example:

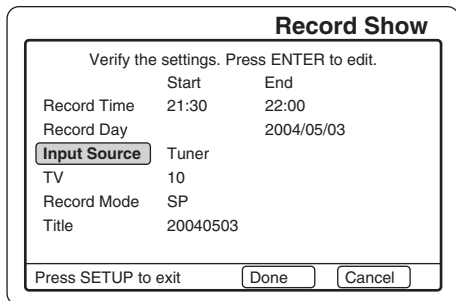

2. Press [ENTER].
"Input Source" screen appears.

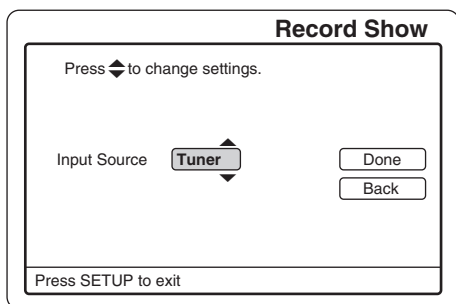

3. Press [\blacktriangle] or [\blacktriangledown] to select "Tuner", "AV1" or "AV2".
4. Press [ENTER] (or [\blacktriangleright]) to select "Done".
5. Press [ENTER].
The recording input source is selected.
The screen returns.
Examples:

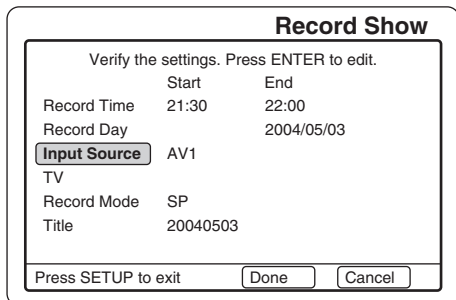
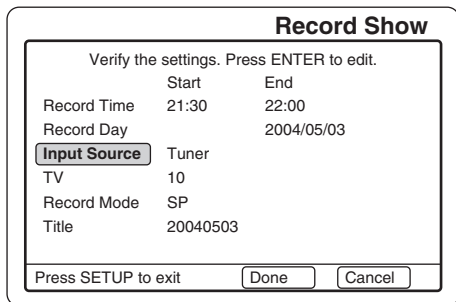

Setting "TV"

- Select the TV channel number.
- Note:
- If "AV1" or "AV2" is selected for the Input Source, the channel number does not appear. Skip this section.

1. Select "TV".
Example:

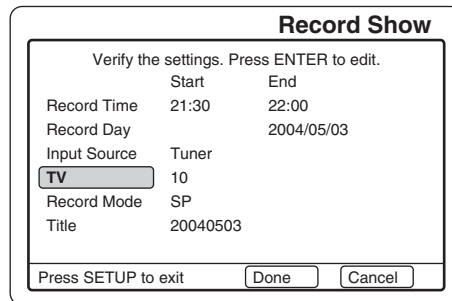

2. Press [ENTER].
"TV" screen appears.
Example:

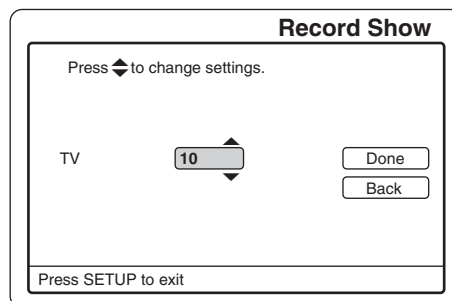

3. Press [\blacktriangle] or [\blacktriangledown] to select the TV channel number.
4. Press [ENTER] (or [\blacktriangleright]) to select "Done".
5. Press [ENTER].
The TV channel number is set.
The screen returns.
Example:

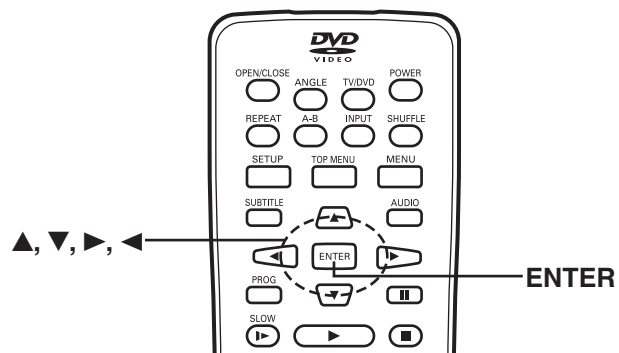
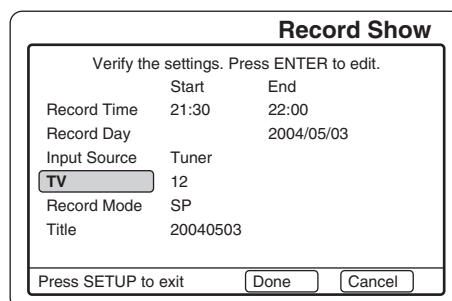



- Press [ENTER].
"Title" screen returns.
The new title name appears.
Example:

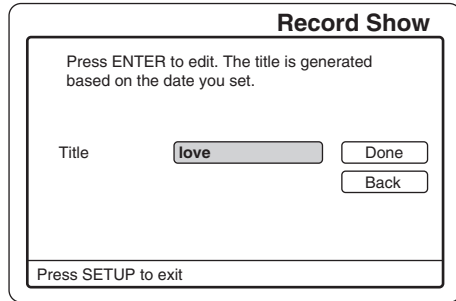

- Press [▶] to select "Done".

- Press [ENTER].
The screen returns.
Example:

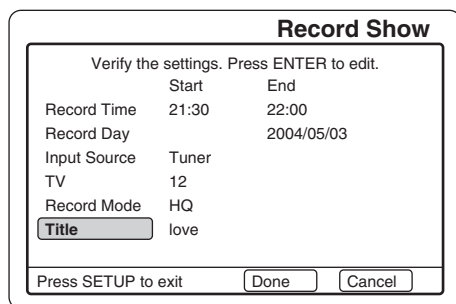

- After all settings are completed, press [▼] to select "Done".
Note:
If you want to cancel it, select "Cancel", and then press [ENTER].

- Press [ENTER].
If a disc is not loaded, a message "Please insert disc." screen appears. Press [ENTER] again.
"Menu" screen returns.

If a message appears...

- Examples:
- "Record time in the past"
 - "Program Overlapped ...", etc.

In these cases, please follow the instructions displayed on the TV screen.

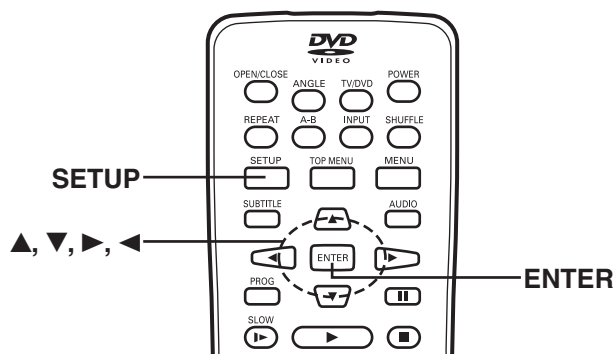

Record List

- Select "Record List" in "Menu" screen.
(See pages E22 and E33.)

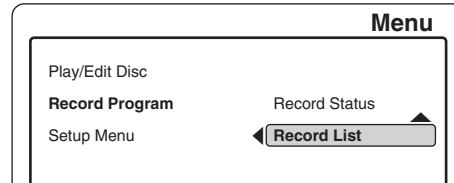

- Press [ENTER] (or [▶]).
"My Record List" screen appears.
Example:

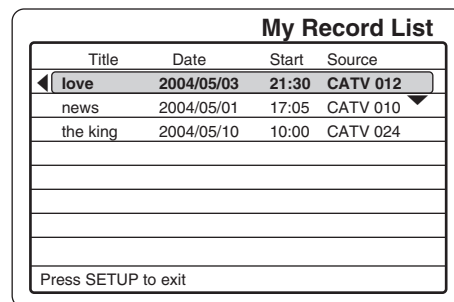

If the list is correct...

- Press [◀] to return to the previous screen.
- Press [SETUP] to close the screen.

If you want to delete or edit it...

- Press [▲] or [▼] to select the program in the list.
- Press [ENTER].

A message appears on the screen.

Example:

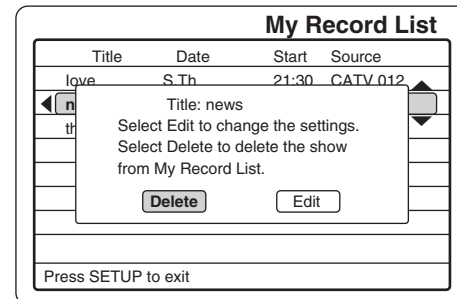

Do one of the followings:

Delete:

- Select "Delete".
- Press [ENTER]. The confirmation screen appears.
- Select "Confirm".
- Press [ENTER]. "My Record List" screen returns.

Edit:

- Select "Edit".
- Press [ENTER]. "Edit My Record List" screen appears.
- Edit the items again. (Please refer to "Setting Record Time" ~ "Setting Title" on pages E33 ~ E36.) "My Record List" screen returns.



- Press [◀] to return to the previous screen.
 - Press [SETUP] to close the screen.



DISC INFORMATION

Recordable Discs

The following types of discs can be recorded on this unit.

Disc type and logo mark	
DVD+RW	 DVD+ReWritable
DVD+R	 DVD+R

We recommend the discs as shown below.

DVD+RW:

Rewritable disc

You can re-record/erase the disc approximately 1,000 times.

CMC (2.4x)

Infodisc (2.4x)

Mitsubishi (2.4x/4x)

Moser Bare India (2.4x)

Optdisc (2.4x)

Philips (2.4x/4x)

Prodisc (2.4x)

Richo (2.4x/4x)

Ritek (2.4x)

Melody (2.4x)

DVD+R:

Non-rewritable disc, record-once medium

CMC (2.4x/4x)

DAXON (4x)

Mitsubishi (2.4x/4x)

Prodisc (2.4x)

Richo (2.4x/4x)

Taiyo Yuden (4x)

CAUTION:





- Only the above types of discs can be recorded on this unit. DVD-RAM, DVD-RW, DVD-R, DVD-ROM, CD-ROM, SVCD, CVD, VCD, CD-R, CD-RW, Audio CD, etc. cannot be recorded.
- Fingerprints and small scratches on a disc can affect recording and/or playback performance. Please take proper care of your discs.
- In some cases, you may not be able to add new recordings to DVD+RWs that contain recordings made on other DVD Recorders or PCs.
- To play a recorded disc on other DVD equipment, you need to finalize the disc. See page E57.
- If the disc contains PC data unrecognized by this unit, the data will be erased.
- When repeat opening/closing the disc tray and add new recording on the DVD+R disc, the disc can be added new recording up to 30 times.
- When a data is erased from a DVD+R, that space does not become available. Once an area on a DVD+R is recorded on, that area is no longer available for recording, whether the recording is erased or not.

Unrecordable pictures

Pictures with copy protection cannot be recorded on this unit. When the unit receives a copy guard signal while recording, the unit cannot record correctly.

Playable Discs

The following types of discs can be played on this unit.

Disc type and logo mark	
DVD-Video	
DVD+RW	 DVD+ReWritable
DVD+R	 DVD+R
Audio CD	

CAUTION:

- Only the above types of discs can be played on this unit. DVD-RAM, DVD-ROM, CD-ROM, SVCD, CVD, VCD, etc. cannot be played.
- Some DVD+R/DVD+RWs cannot be played back depending on the recording conditions.
- This unit can play back the DVD-R that has recorded movie data as well. However, some DVD-Rs cannot be played back depending on the recording conditions.
- The DVD-R that has no movie data cannot be played back.
- The DVD-RW (Video mode) can be played back. However, some DVD-RWs cannot be played back depending on the recording conditions. The DVD-RW (VR mode) cannot be played back.
- Incompatible DVD discs cannot be played back.
- Unfinalized DVD+R discs cannot be played back. However, some (finalized) DVD+Rs cannot be played back depending on the recording conditions.
- This unit is to be used exclusively with the NTSC color system. PAL and SECAM system discs cannot be used with this unit.
- **For MP3 CD, please see page E51.**
- **For Picture/JPEG CD, please see pages E53 and E54.**

This product incorporates copyright protection technology that is protected by method claims of certain U.S. patents and other intellectual property rights owned by Macrovision Corporation and other rights owners. Use of this copyright protection technology must be authorized by Macrovision Corporation, and is intended for home and other limited viewing uses only unless otherwise authorized by Macrovision Corporation. Reverse engineering or disassembly is prohibited.

Important Note:

SANYO takes no responsibility for recording failure due to power cuts, defective discs, or damage to the unit, etc.

Region Number (DVD-Video disc only)

Region number (Regional restriction code) is built-in to the unit and DVD-Video discs.

Region number "1" or "ALL" of DVD-Video discs can be used on this unit.



DVD-Video Disc

DVD-Video discs are divided into titles, and the titles are subdivided into chapters.

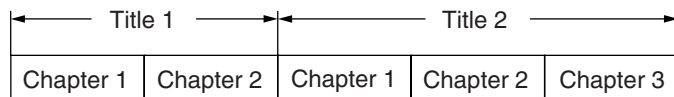

There are the marks on some DVD-Video disc package.
Example:



Multiple languages



Multi-language subtitles



Multi-angle

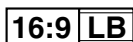

Multi-aspect



Region number



Closed caption

Audio CD Disc

Audio CD discs are divided into tracks.



Handling, Storing and Cleaning Discs

- Fingerprints and dust should be carefully wiped from the signal surface of the disc (glossy side) with a soft cloth. Wipe in a straight motion from the center to the outside of the disc.
- Never use chemicals such as record cleaning sprays, antistatic sprays or fluids, benzene or thinner to clean the discs. These chemicals will permanently damage the plastic surface of the disc.
- To remove a disc from its storage case, press down on the center of the case and lift the disc out, holding it carefully by the edges.
- Discs should be returned to their cases after use to protect them from dust and scratches.
- To prevent warping the disc, do not expose it to direct sunlight, high humidity or high temperatures for extended periods of time.
- Do not apply paper or write anything on either side of the disc. Sharp writing instruments, or the inks used in some felt-tip pens, may damage the surfaces of the disc.



**Need help? Call
1-800-813-3435**

RECORDING

Preparations

- This instruction manual explains the basic instruction of this unit using the remote control unit.
- Turn on the TV and select the video input source. Refer to your TV's owner manual.
- Check that the disc has enough available space for recording.
- Set "Record Mode" and "Auto Chapter" (See pages E23 and E24).
- Select "Stereo" in "MTS (Multi-channel TV Sound) Select" on page E21.
- Do not touch the disc tray while it is moving.
- Never place anything except a disc on the disc tray. Foreign objects can damage the unit.
- Do not apply excessive force to the disc tray.
- Only one disc must be placed on the disc tray at a time.

When operation buttons are pressed, that operation is displayed on the TV screen. The display turns off after several seconds.

1. Press [POWER] to turn the power on.
 - "SANYO" logo appears on the TV screen.
 - "POWER ON" ---> "LOADING" ---> "NO DISC" appears on the FL display.

2. Press [OPEN/CLOSE] to open the disc tray.
 - "OPEN" appears.

Note:

To open or close the disc tray, be sure to press [OPEN/CLOSE]. Do not press the disc tray with your hand.

3. Place a **DVD+RW** or **DVD+R** disc (label facing up) to be recorded on the disc tray.

See "Recordable Discs" on page E38.

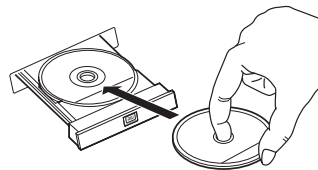

4. Press [OPEN/CLOSE] again to close the disc tray .
Please wait until "CLOSE" ---> "DISC LOADING" ---> "STOP" disappears on the TV screen.

- If a blank disc is used for first time, "SANYO" logo screen remains.
- If the disc is recorded once before, a title menu screen may appear.
- "DVD RW" (or "DVD") and "SP" (or "HQ", "LP", "EP" or "EP+") appear on the FL display.
- Blank DVD+RWs may take a while longer before "STOP" disappears on the TV screen.

5. Press [REC MODE] to select the Record Mode ("HQ", "SP", "LP", "EP" or "EP+").

For more details, please refer to "Setting Record Mode" on page E23.

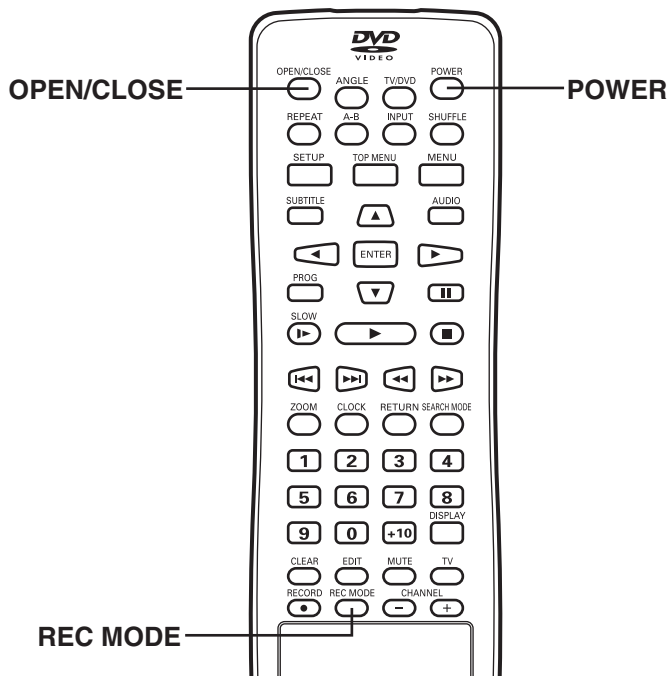

**Need help? Call
1-800-813-3435**

Recording TV Programs

- Before pressing [TV], select the Record Mode (“HQ”, “SP” “LP”, “EP” or “EP+”) first. See the previous page.
1. Press [TV] to receive the TV program.
“MONITOR” appears briefly on the TV screen.
 2. To select the channel, do one of the following:
 - Press [CHANNEL] + or -.
 - Press the number button(s).
 Examples:
 To select Channel 6: Press [6].
 To select Channel 12: Press [1] and [2].
 To select Channel 110: Press [1], [1] and [0].
 The channel number appears on the FL display.
 3. Press [RECORD ●] (or [●REC] on the unit) to start recording.
 - “RECORDING” appears briefly on the TV screen.
 - While picture is frozen there is no recording until picture is moving again. Please wait until recording starts.
 - Elapsed recording time appears on the TV screen.
 - The REC indicator lights.

Example (FL display):

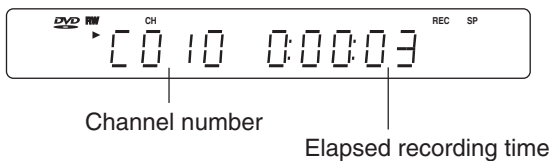

Recording continues until you stop the recording or the disc is full.

Note:

Press [DISPLAY] repeatedly until the elapsed recording time disappears on the TV screen, if necessary.

To pause recording

Press [II] during recording.

- “RECORDING PAUSE” appears on the TV screen.
- Press it again to restart recording.

To stop recording

Press [■] during recording.

Please wait until “CLOSING...” ---> “PLEASE WAIT...” ---> “STOP” disappears on the TV screen.

Note:

It takes a while to complete closing the disc. You may not watch TV program while closing.



A title menu screen appears on the TV screen.

- The TV program is recorded on the disc.
- The additional recording information is also stored on the disc.

Example:

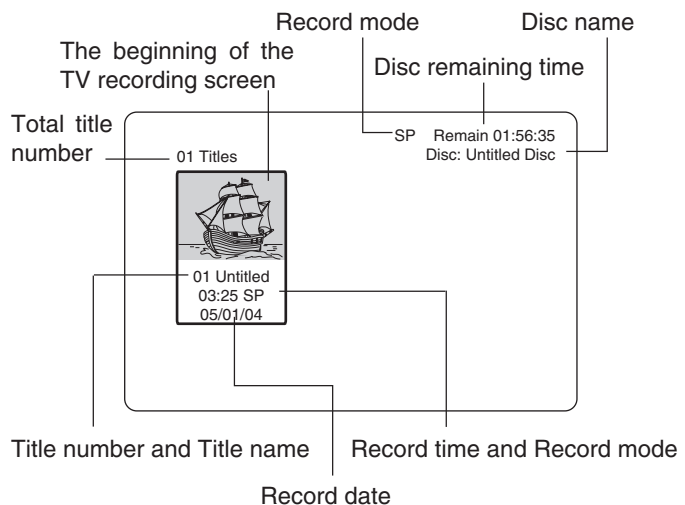

Notes:

- You cannot change the channel or record mode during recording.
- The record time is estimate and actual time may differ.
- Recording makes on open space on the disc. Data will not be overwritten.
- You can record up to 48 programs on one disc (Maximum 360 minutes for continuous recording of one program).
- You cannot record a program with copy-protection.

To record TV program again, repeat steps 1 ~ 3 on the left column.

To play back the disc, see page “DISC PLAYBACK” on page E44.

Note:

To turn off the power, press [POWER]. The clock appears on the FL display. If the timer recording is set, “⌚” appears.

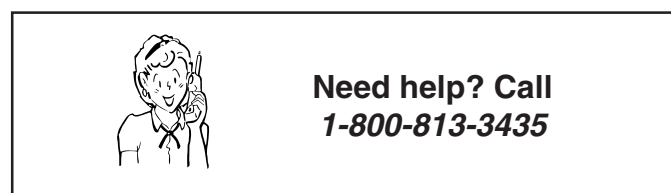
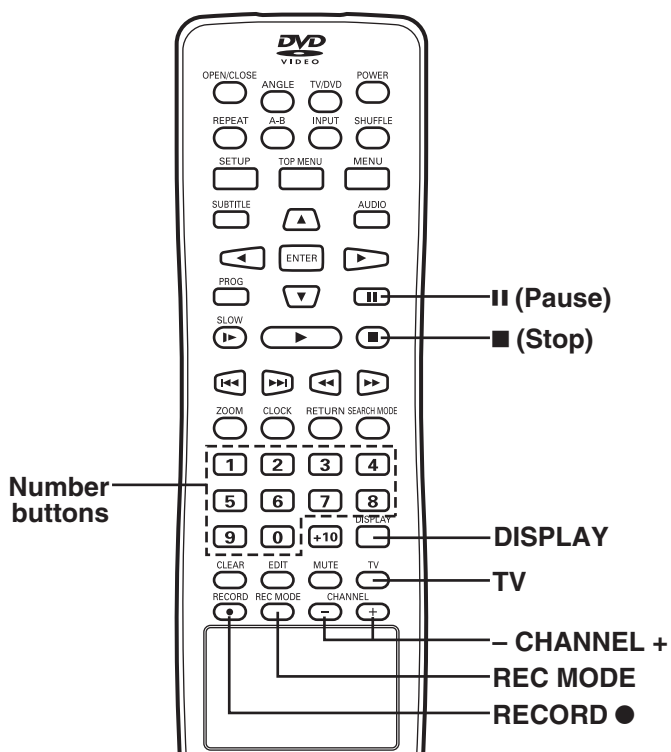

To watch another TV while recording

Press [TV/DVD] repeatedly to select "ANTENNA SOURCE TV" on the TV screen.

- "TV" appears on the FL display.

Use your original TV remote control to select the channel on your TV.

Note:

If you do not want to watch TV while recording, you can turn off the TV. If using a cable box, make sure to leave it on.

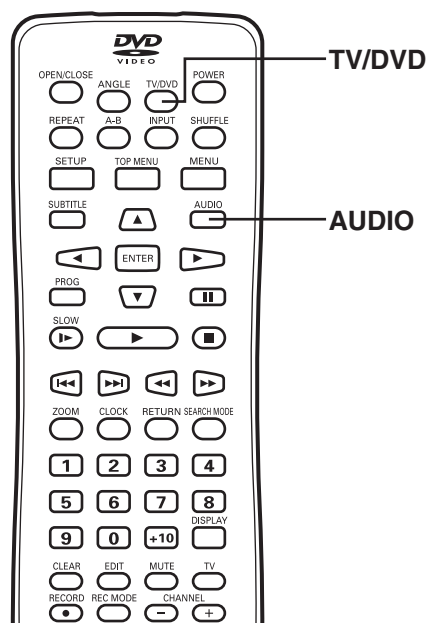

Recording stereo program and SAP (Second Audio Program)

1. Select the recording sound.
 - 1) Select "Stereo", "SAP" or "MONO" in "MTS Select".
See "MTS (Multi-channel TV Sound) Select" on page E21.
 - 2) Press [AUDIO] to select "LEFT", "RIGHT" or "STEREO" on the TV screen.

MTS select	AUDIO select	TV program	Recording sound
Stereo	LEFT	Mono	Mono
		Mono+SAP	
		Stereo	Stereo
		Stereo+SAP	
	RIGHT	Mono	Mono
		Mono+SAP	
		Stereo	Stereo
		Stereo+SAP	
	STEREO	Mono	Mono
		Mono+SAP	
		Stereo	Stereo
		Stereo+SAP	
Mono	LEFT RIGHT STEREO	Mono	Mono
		Mono+SAP	
		Stereo	
		Stereo+SAP	
SAP	LEFT	Mono	Mono
		Mono+SAP	
		Stereo	Stereo
		Stereo+SAP	Mono
SAP	RIGHT	Mono	Mono
		Mono+SAP	SAP
		Stereo	Stereo
		Stereo+SAP	SAP
SAP	STEREO	Mono	Mono
		Mono+SAP	
		Stereo	Stereo
		Stereo+SAP	Mono

2. Start recording.

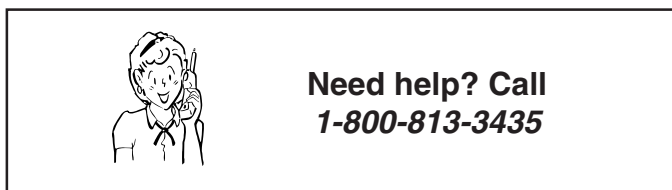

Timer Recording

Note:

This unit uses the International Time System (24-hour display). Therefore the unit does not have Daylight Saving Time (DST) function. You must set the clock when summer switches to winter and vice versa. See page E18.

1. Set the program(s) first.
(See "Record Status" on page E33.)
2. Open "My Record List" screen and confirm the program to be recorded. Make corrections if necessary.
(See "Record List" on page E37.)
Example:

My Record List			
Title	Date	Start	Source
love	2004/05/03	21:30	CATV 012
news	2004/05/01	17:05	CATV 010
the king	2004/05/10	10:00	CATV 024
Press SETUP to exit			

3. Press [SETUP] to close "My Record List" screen.
 4. Press [POWER] to turn the power off.
Recording standby mode is set.
 - The present time and "⌚" appear on the FL display.
- When the timer ON time arrives, the power turns on automatically and recording starts.
 - When the timer OFF time arrives, the power turns off automatically and it is set to the standby mode.

Notes:

- If there is not enough space on the disc, as much of the program as possible will be recorded on the disc.
- Be sure to check and/or change the disc after every timer recording has been completed.

Recording from an External Equipment (VCR, etc.)

- Connect a VCR or other equipment to the AV1 IN or AV2 IN jacks first. See page E15.
- Select "Video" or "S-Video" in "AV Select" screen. See page E32.

1. Load the disc.
2. Press [INPUT] repeatedly to select "VIDEO1 IN" or "VIDEO2 IN" for the equipment you have connected.
 - "VIDEO1" or "VIDEO2" appears on the FL display.
3. Start playback on the other equipment.
4. Press [RECORD ●] at the point you want to start recording.
Recording starts.

To pause recording

Press [II]. Press it again to restart recording.

To stop recording

Press [■].

For more details, see page E41.

CAUTION:

Almost all videos and DVD softwares on sale have a copy-protection. You cannot record them using this unit. Video Games cannot be recorded.

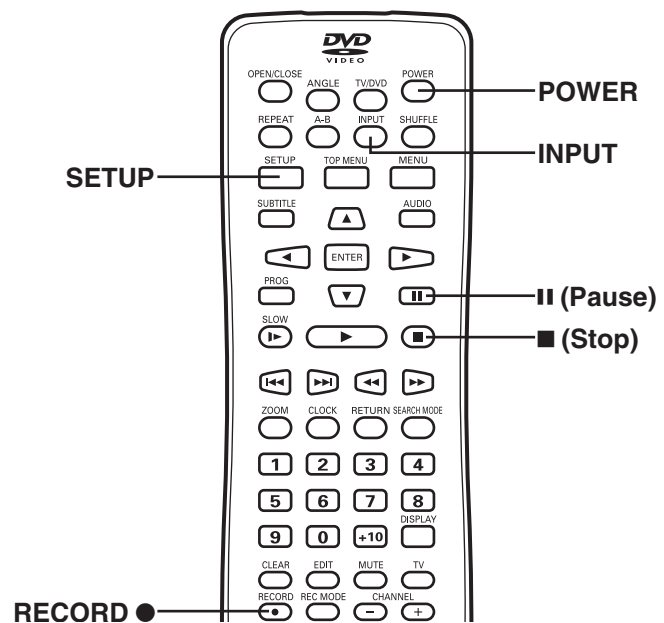

**Need help? Call
1-800-813-3435**



DISC PLAYBACK

Important Note:

- This instruction manual explains the basic instruction of this unit using the remote control unit.
- Some DVD-Video discs have different functions that may not be explained in this instruction manual. You may need extra instructions. In this case, please follow the instructions displayed on the TV screen or jacket or case of the disc.
- If “⊘” appears on the TV screen during operation, the operation is prohibited by the unit or the disc.
- For improvement, on-screen display subject to change without notice.

Preparations

- Please refer to “Preparations” on page E40.
- Turn on the TV and select the video input source. Refer to your TV's owner manual.
- Select the playback picture size according to the aspect ratio of the TV. (See “Setting TV Display” on page E30.)

4:3 PS
(Panscan)

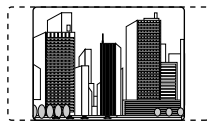

4:3 LB
(Letterbox)

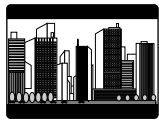

16:9 Wide

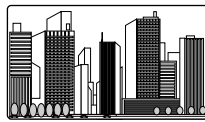

Press [■] if you want to play back a DVD disc while the unit is receiving the TV program.

- When you use a TV with Progressive-scan capability and connect it to the COMPONENT VIDEO OUT jacks of the unit (see page E11), you must select the PROGRESSIVE mode. (For more details, please refer to your TV's owner manual.)

Note:

If you use a Conventional TV or non-progressive-scan TV, skip this section.

1. Press [POWER] to turn on the power.
2. In “NO DISC” mode, press and hold down [▶] on the unit until “PROGRESSIVE TV” appears briefly on the TV screen.

If you want to switch the setting back again, press and hold down [▶] until “INTERLACE TV” appears briefly on the TV screen.

Note:

In “PROGRESSIVE TV” mode, the closed caption may not appear on the TV screen.

Progressive Scanning

While interlaced scanning produces one frame of video in two fields, progressive scanning creates one frame in one field. Conventional interlaced scanning constitutes one second with 30 frames (60 fields), but progressive scanning constitutes it with 60 frames from scratch. Progressive scanning can reproduce sharper picture with high resolution for still image or other picture containing long texts or horizontal lines.

This model has compliance with 525p (progressive) system.

Interlaced scanning



Progressive scanning

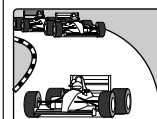

Note:

This handling description is printed prior to product development. When a part of the product specification must be changed to improve operability or other functions, priority is given to the product specification itself. In such instances, the instruction manual may not entirely match all the functions of the actual product. Therefore, the actual product and packaging, as well as the name and illustration, may differ from the manual.



Need help? Call
1-800-813-3435

Basic Playback

Notes:

- Do not touch the disc tray while it is moving.
- Never place anything except a disc on the disc tray. Foreign objects can damage the unit.
- Do not apply excessive force to the disc tray.
- Only one disc must be placed on the disc tray at a time.

When operation buttons are pressed, that operation is displayed on the TV screen. The display turns off after several seconds.

1. Press [OPEN/CLOSE] to open the disc tray.

Note:

To open or close the disc tray, be sure to press [OPEN/CLOSE]. Do not press the disc tray with your hand.

2. Place the disc with the label facing up on the disc tray.
See "Playable Discs" on page E38.

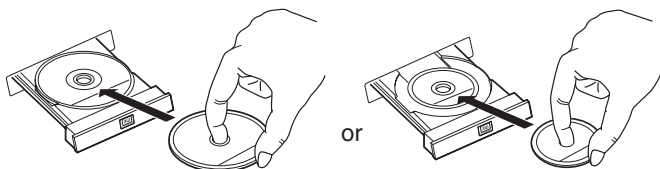

For 5-inch (12cm) disc

For 3-inch (8cm) disc

3. Press [OPEN/CLOSE] again to close the disc tray.
Please wait until "CLOSE" ---> "DISC LOADING" ---> "STOP" disappears on the TV screen.
 - Some discs may start playback automatically.

4. Start playback.

[DVD+RW] [DVD+R]

If a recorded DVD+RW or DVD+R disc is loaded, a title menu screen may appear.

Example:

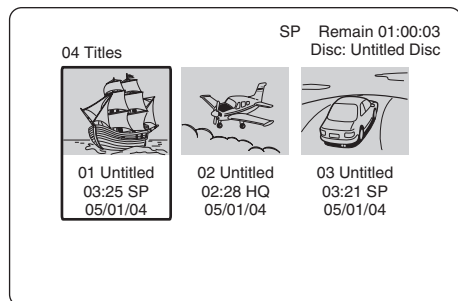

- 1) Press [▶] or [◀] to select the title.
- 2) Press [ENTER] (or [▶] (Play)) to start playback.
 - Elapsed playing time appears on the TV screen.

Example (FL display):



[DVD-Video]

Press [▶] (Play) to start playback.

- Elapsed playing time appears on the TV screen.
- If a menu screen appears on the TV screen...
 - 1) Press [▲], [▶], [▼] or [◀] (or the number buttons) to select the desired menu.
 - 2) Press [ENTER].
Playback of the selected menu starts.

Note:

For more details, please refer to the jacket or case of the disc.

Notes:

- Press [DISPLAY] repeatedly until the elapsed playing time disappears, if necessary. (See page E50.)
- In some discs, even if 4:3 PS is selected, the black bands may remain on the TV screen.
- If the disc is loaded with the label side downward (and it is a single sided disc), or if a badly scratched disc is loaded, "NO DISC" or "NO PLAY" appears on the TV screen. If this occurs, load the disc correctly or replace the disc.

Stopping Playback

[DVD-Video][DVD+RW][DVD+R]

- Press [■] once during playback.
"PRESS PLAY TO CONTINUE" appears briefly on the TV screen.

When you press [▶] (Play) again, playback starts automatically from the point where you stopped. "PLAY" appears briefly on the TV screen.

Note:

Some discs may not resume playback.

- Press [■] twice during playback.
"STOP" appears briefly on the TV screen and playback stops completely.
When you press [▶] (Play), playback starts from the beginning of the disc.

[CD]

- Press [■] once during playback. The unit stops completely.

To turn off the power, press [POWER]. The clock appears on the FL display.

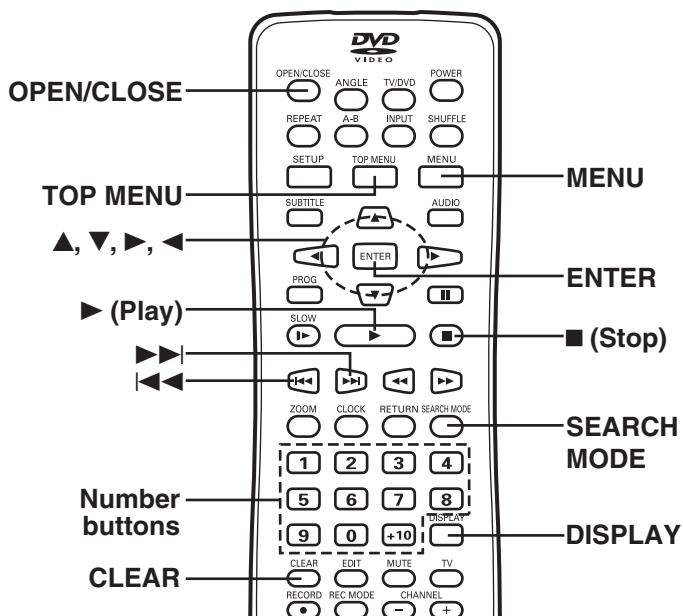

Selecting a Top Menu

Notes:

- The operation may differ depending on the disc used.
- Selecting a menu may not be possible on some discs.

1. Press [TOP MENU].
The menu screen will appear (if the disc contains it).
2. Press [▲], [▼], [◀] or [▶] (or the number buttons) to select the desired menu.
3. Press [ENTER].
The selected menu playback starts.

Selecting a DVD Menu

Notes:

- The operation may differ depending on the disc used.
- Selecting a menu may not be possible on some discs.

1. Press [MENU].
The menu screen will appear.
2. Press [▲], [▼], [◀] or [▶] (or the number buttons) to select the desired menu.
3. Press [ENTER].
The selected menu playback starts.

Chapter (Track) Skip



Press [▶▶] or [◀◀] during playback.

▶▶:

Skip to the next chapter (or track).

◀◀:

Skip back to the beginning of the previous chapter (or track).

The information appears briefly on the TV screen.

Example:

TITLE 01 / 28 CHAPTER 016 / 035

Notes:

- You can skip only through the chapters, not over the title on the DVD-Video disc.
- "NEXT" or "PREVIOUS" may appear during CD playback.

Important Note:

If "⊘" appears on the TV screen during operation, the operation is prohibited by the unit or the disc.

Title or Chapter Search

1. Press [SEARCH MODE] **once** during playback or in the stop mode.

The title/chapter search screen appears on the TV screen.

Example:

TITLE 01 / 28 CHAPTER 015 / 035

2. Press [▶] or [◀] to select "TITLE" or "CHAPTER".
3. Press the number button(s) to enter the title or chapter number.

Examples:

To select "3", press [3].

To select "10", press [+10], then [0].

To select "24", press [+10], [+10], then [4].

The title or chapter number will be changed.

Example:

TITLE 24 / 28 CHAPTER 015 / 035

Note:

If you make a mistake, enter the title or chapter number again.

4. Press [▶] (Play).
Playback starts from the selected title (or chapter).

Time Search

1. Press [SEARCH MODE] **twice** during playback.

The time search screen appears on the TV screen.

Example:

TITLE 01 / 02 TIME -- : -- : --

2. Press the number button(s) to enter the time.

Examples:

3 minutes 40 seconds:

Press [0], [0], [0], [3], [4], then [0].

20 minutes 5 seconds:

Press [0], [0], [2], [0], [0], then [5].

42 minutes 39 seconds:

Press [0], [0], [4], [2], [3], then [9].

1 hour 4 minutes 35 seconds:

Press [0], [1], [0], [4], [3], then [5].

Note:

If you make a mistake, enter the time again.

3. Press [▶] (Play).
Playback starts from the searched time.

Note:

The Search mode may not work on some discs.



**Need help? Call
1-800-813-3435**

Time Search [CD]

1. Press [SEARCH MODE] **once** during playback.
"GOTO --:--" appears on the TV screen.
2. Press the number button(s) to enter the time.
Example:
2 minutes 5 seconds:
Press [0], [2], [0], then [5].
42 minutes 39 seconds:
Press [4], [2], [3], then [9].



Playback starts from the searched time in the track.

Track Search [CD]

Press the number buttons during playback or in the stop mode.

Example:

- To select Track No. 3, press [3].
- To select Track No. 10, press [+10], then [0].
- To select Track No. 24, press [+10], [+10], then [4].



Playback starts from the selected track.

Fast Playback

During playback, press [▶▶] or [◀◀]. Each time the button is pressed, the playback speed changes as follows:

- [DVD-Video] [DVD+RW] [DVD+R]
- ▶▶: Fast forward
FF 2X → FF 4X → FF 6X → FF 8X (4 steps)
 - ◀◀: Fast reverse
FR 2X → FR 4X → FR 6X → FR 8X (4 steps)

[CD]

- ▶▶: Fast forward
FF 2X → FF 4X → FF 8X → FF 16X (4 steps)
- ◀◀: Fast reverse
FR 2X → FR 4X → FR 8X → FR 16X (4 steps)

Press [▶] (Play) to return to normal playback.

Note:

The sound is muted during fast playback in DVD.

Slow Motion Playback

[DVD-Video] [DVD+RW] [DVD+R]

Press [SLOW ▶] repeatedly to select the forward (or reverse) slow speed playback.

- SF 2X → SF 4X → SF 8X → SR 2X → SR 4X → SR 8X
(Forward, 3 steps) (Reverse, 3 steps)

Press [▶] (Play) to return to normal playback.

Note:

The sound is muted during slow motion playback.

Still Picture (Pause)

Press [⏸] during playback.

- "PAUSE" appears on the TV screen.
- "⏸" appears on the FL display.

[DVD-Video] [DVD+RW] [DVD+R]
Still picture mode

[CD]
Pause mode

Press [▶] (Play) to return to normal playback.

Note:

The sound is muted during still picture.

Frame by Frame Advance Playback

[DVD-Video] [DVD+RW] [DVD+R]

Press [⏪] during still picture.

- "STEP" appears briefly on the TV screen.
 - Each time the button is pressed, the picture advances one frame.
- Press [▶] (Play) to return to normal playback.

Notes:

- The sound is muted.
- Frame playback is operated forward only.

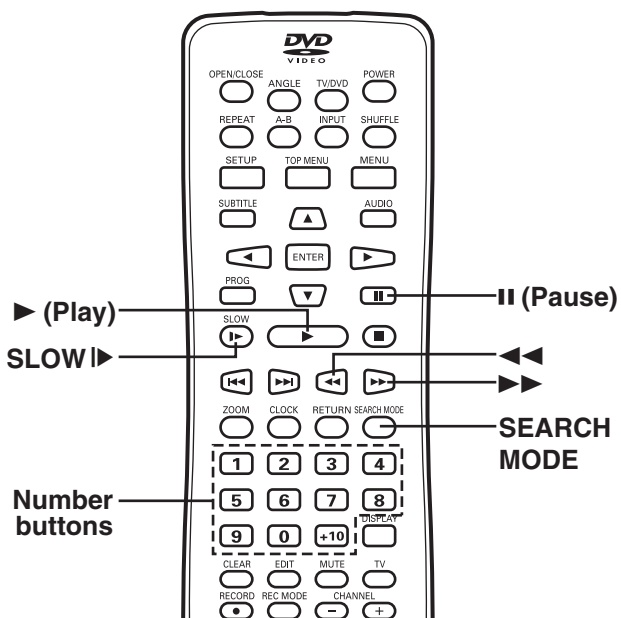

Important Note:

If "⊘" appears on the TV screen during operation, the operation is prohibited by the unit or the disc.



Need help? Call
1-800-813-3435

Picture Zoom

Press [ZOOM] during normal/slow playback or still picture. The central part of the picture is magnified, and "ZOOM X 1.5" appears on the TV screen.

- Each time you press [ZOOM], the zoom mode will be changed as follows:

ZOOM X 1.5 → ZOOM X 2 → ZOOM X 3 → ZOOM OFF

- Press [▲], [▶], [▼] or [◀] to change the zoom point.

To return to the original screen, select "ZOOM OFF".

Note:

Picture Zoom may not work on some discs.

Viewing from a Desired Camera Angle (Multi-Angle) [DVD-Video]

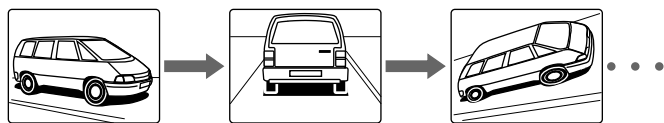

Some DVD-Video discs may contain scenes which have been shot simultaneously from a number of different camera angles. The jacket or case of discs that are recorded with angles will be marked.

Example:



Note:

The recorded angles differ depending on the disc used.

- Play the disc that is recorded with angles.
- Press [ANGLE] repeatedly until the desired angle appears.
 - If "Angle Mark" is set to "ON" (see page E26), the angle mark appears on the TV screen.

Example:

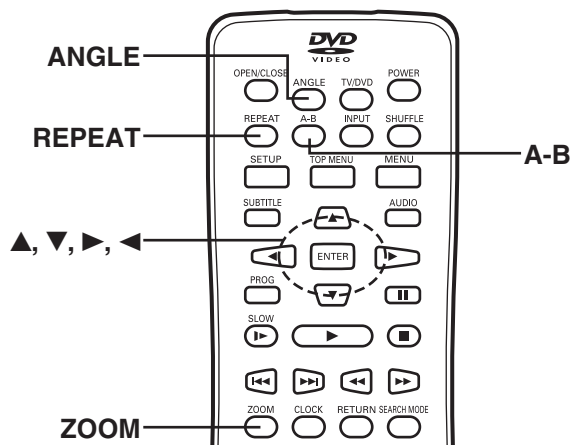

Important Note:

If "⊘" appears on the TV screen during operation, the operation is prohibited by the unit or the disc.

Repeat Playback

Press [REPEAT] during playback (or programmed playback) of the title (or track) you want to repeat.

Each time the button is pressed, the repeat mode will be changed as follows.

[DVD-Video] [DVD+RW] [DVD+R]
 CHAPTER REPEAT ON/REP 1:
 Repeat of the chapter being played
 TITLE REPEAT ON/REP ALL:
 Repeat of the title being played
 REPEAT OFF:
 Normal playback mode

[CD]
 REP-ONE/REP 1:
 Repeat of the track being played
 REP-ALL/REP ALL:
 Repeat all tracks
 REPEAT OFF:
 Normal playback mode

Designated Range Repeat Playback (A-B Repeat)

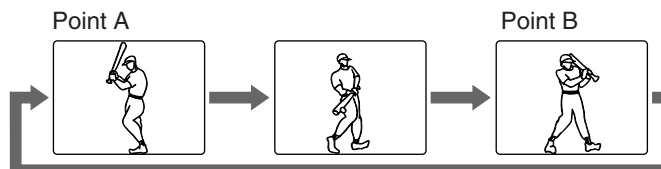

- Press [A-B] during playback at the beginning of the section you want to repeat (Point A).
 - "A TO B SET A" appears briefly on the TV screen.
 - "REP A" appears on the FL display.
- Press [A-B] again at the end of the section you want to repeat (Point B).
 - [DVD-Video] [DVD+RW] [DVD+R]
"A TO B REPEAT ON" appears briefly on the TV screen.
 - [CD]
"A TO B SET B" appears briefly on the TV screen.
 - "REP A-B" appears on the FL display.
 - The section between points A and B is played repeatedly.
- To return to normal playback, press [A-B] again.
 - "A TO B CANCELLED" appears briefly on the TV screen.

Note:

Repeat playback or A-B repeat playback mode may not work correctly with some discs.



**Need help? Call
1-800-813-3435**

Selecting Subtitle Language

This operation works only with discs on which multiple subtitle languages are recorded.

Press [SUBTITLE] repeatedly during playback until the desired subtitle language appears on the TV screen.

Example:

SUBTITLE 01/03 : ENGLISH

After a few seconds, it disappears.

Notes:

- In some cases, the subtitle language is not changed to the selected one.
- When a disc supporting closed caption is played, the subtitle and the closed caption may overlap each other on the TV screen. In this case, turn the subtitle off.
- When the desired language is not selected even if the button is pressed, the language is not available on the disc.
- When the power is turned on or the disc is replaced, select the subtitle language again.
- If the subtitle language is not necessary, press [SUBTITLE] to select "SUBTITLE OFF".
- Please refer to "Setting Subtitle" on page E26.

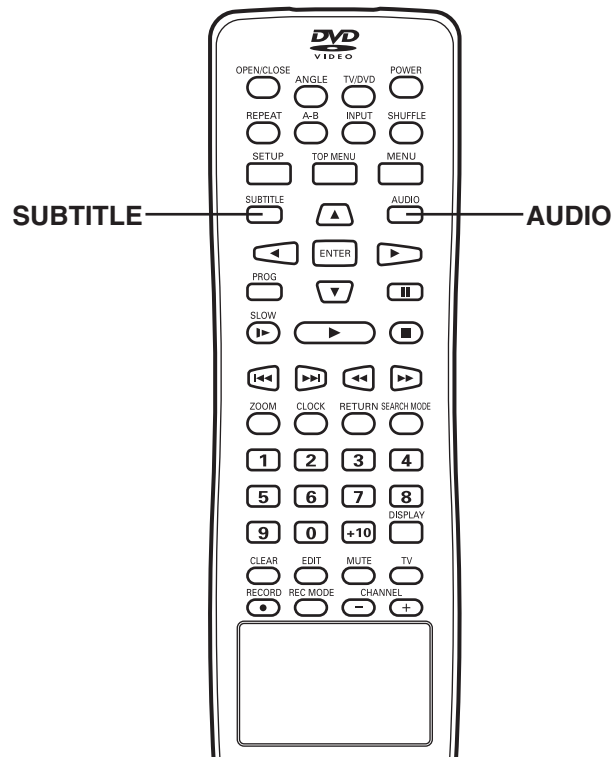

Selecting Audio Soundtrack Language (Multi-Language)

This operation works only with discs on which multiple audio soundtrack languages are recorded.

Press [AUDIO] repeatedly during playback until the desired language appears on the TV screen.

Examples:

AUDIO 1/4:DOLBY D 2CH ENGLISH

AUDIO 2/4:DTS 5.1 ENGLISH

(If using an amplifier with DTS Decoder, the DTS sound will be heard. See page E13 for the amplifier connection.)

Notes:

- When the desired language is not selected even if the button is pressed, the language is not available on the disc.
- When the power is turned on or the disc is replaced, select the language again.
- If the language is not recorded on the disc, only the available language on the disc will be heard.

Notes on Audio CD playback

Changing the audio channel output

During Audio CD playback, press [AUDIO] to select an audio channel ("LEFT", "RIGHT", or "STEREO").

Important Note:

If "⊗" appears on the TV screen during operation, the operation is prohibited by the unit or the disc.



Need help? Call
1-800-813-3435

Shuffle Playback [CD]

- Press [SHUFFLE] in the stop mode.
 - "SHUFFLE ON" appears briefly on the TV screen.
 - "SHUFF" appears on the FL display.
- Press [▶] (Play) to start shuffle playback.

The unit will automatically select tracks at random.

Note:

To stop shuffle playback, press [■], and then press [SHUFFLE]. "SHUFFLE OFF" appears briefly on the TV screen.

Programmed Playback [CD]

Up to 99 selections can be programmed.

Programming procedure

- Press [PROG] in the stop mode.
 - "PROGRAM P00:00" appears on the TV screen.
 - "PROG" appears on the FL display.
- Press the number buttons to select the track number.

Examples:

 - To select Track No.3, press [3].
 - To select Track No.10, press [+10], then [0].
 - To select Track No.24, press [+10], [+10], then [4].

Example:

PROGRAM P01:03
(The Track No.3 is set to the first programmed number.)

Note:

If you make a mistake, press [CLEAR].

- Repeat step 2 as above to select other tracks.

Examples:

PROGRAM P02:10
PROGRAM P03:24

- Press [▶] (Play) to start programmed playback.

When all programmed selections have been played, the unit stops automatically.

 - The programmed contents are retained in memory.

If [▶] (Play) is pressed again, programmed playback starts.

Note:

To cancel the program, press [PROG] ("PROGRAM P00:00" appears) in the stop mode, and then press [■].

Important Note:

If "⊘" appears on the TV screen during operation, the operation is prohibited by the unit or the disc.

To Check the Disc Playing Time

Press [DISPLAY] during playback.

Each time the button is pressed, the various playing times will appear on the TV screen.

Examples (DVD-Video, DVD+RW, DVD+R):

TITLE 01/02 CHAPTER 015/035
00 : 50 : 09

TITLE REMAIN (Title remaining playing time)
01 : 10 : 20

CHAPTER ELAPSED (Chapter elapsed playing time)
00 : 01 : 25

CHAPTER REMAIN (Chapter remaining playing time)
00 : 01 : 34

Released

Examples (CD):

SINGLE ELAPSED (Track elapsed playing time)
00 : 00 : 54

SINGLE REMAIN (Track remaining playing time)
00 : 02 : 59

TOTAL ELAPSED (Disc elapsed playing time)
00 : 01 : 05

TOTAL REMAIN (Disc remaining playing time)
00 : 45 : 34

OFF (Released)

Press [DISPLAY] repeatedly until all playing times disappear.

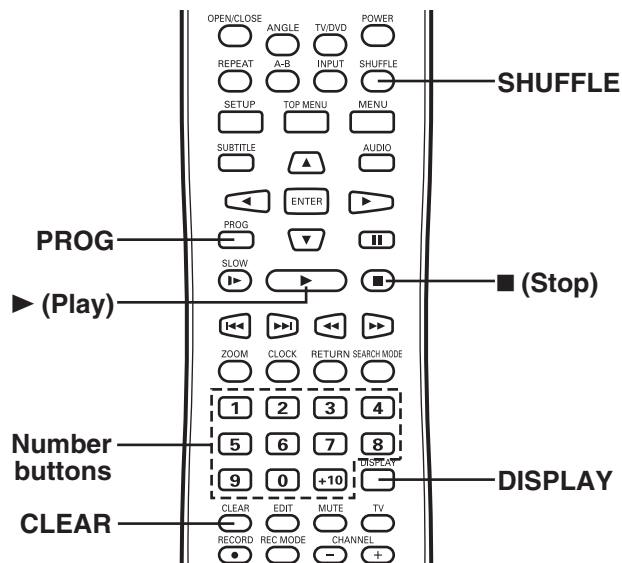

Need help? Call
1-800-813-3435



MP3 CD OPERATION

Before Starting

This unit can play back the CD that has recorded music data, MP3 files.

- The file system is ISO9660 Level 1 and Level 2.
- It would take 30 seconds or more for this unit to read MP3 files depending on its structure.
- This unit can recognize up to 999 files or folders per disc. The CD with 1000 files or folders and over is not available to this unit.
- MP3 CDs may not be played in the recorded order.
 1. Please use the MP3 software with the function that can record data alphabetically or numerically.
 2. Please refrain from making many sub-folders by preference.

However, some CD-R/RWs cannot be played back depending on the recording conditions.

Before playing back MP3 files, please read the following.

MP3 CD

- MP3 files must have the extension letters, ".MP3" or ".mp3".
- Standard, sampling frequency, and the bit rate:
 - MPEG-1 Layer 3
 - 44.1kHz, 48kHz
 - 56kbps ~ 320kbps (constant bit rate)
- The recommended recording setting for a high-quality sound is 44.1kHz of sampling frequency and 128kbps of constant bit rate.

LIMITATIONS ON DISPLAY

Available letters for display are the following: numbers of 0 through 9, and capital alphabets of A through Z.

CAUTION:

- Some MP3 CDs cannot be played back depending on the recording conditions.
- The CD has no music data or non-MP3 files cannot be played back.
- The WMA files cannot be played back.
- Customers should also note that permission is required in order to download MP3 files and music from the Internet. SANYO has no right to grant such permission. Permission should always be sought from the copyright owner.

Important Note:

If "⊘" appears on the TV screen during operation, the operation is prohibited by the unit or the disc.

MP3 CD Playback

1. Load the disc with the label facing up on the disc tray. (Please refer to "Basic Playback" on page E45.)
 - "SmartNAVI" screen appears.

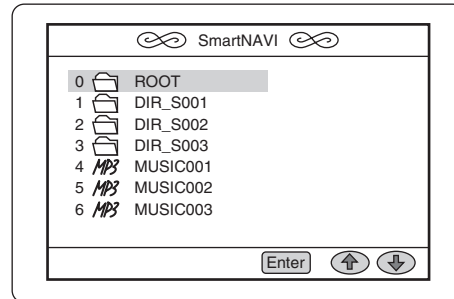

2. Press [▼] or [▲] to select the folder or file, and press [ENTER].
 - If the folder is selected, the file menu of the selected folder appears.
 - If the file is selected, the selected file playback starts ("Play" appears briefly on the TV screen).
 - Number buttons can be used for selecting the file.

Examples:

To select No.3, Press [3].

To select No.10, press [+10], then [0].

To select No.24, press [+10], [+10], then [4].
3. Repeat step 2 to select the file in the folder, if necessary.

Note:

If the disc is loaded with the label side downward, or if a badly scratched disc is loaded, "NO DISC" or "NO PLAY" appears on the TV screen. If this occurs, load the disc correctly or replace the disc.

Stopping Playback

Press [■] during playback.

"Stop" appears briefly on the TV screen.



**Need help? Call
1-800-813-3435**

Pause

Press [II] during playback.

- "Pause" appears on the TV screen.
- "II" appears on the FL display.

Note:

The sound is muted.

Press [▶] (Play) (or [II]) to return to normal playback.

File Skip

Skipping forward

Press [▶▶] during playback to skip to the next file.
"Next" appears briefly on the TV screen.

Skipping backward

Press [◀◀] during playback to skip back to the previous file.
"Previous" appears briefly on the TV screen.

Repeat Playback

Press [REPEAT] in the stop mode.

Each time the button is pressed, the repeat mode will be changed as follows.

- Rep-one
- Disc Repeat
- Folder Repeat
- Repeat off

To Check the Elapsed Playing Time

Press [DISPLAY] during playback.

Each time the button is pressed, various playing time appears.

- "File Elapsed" and elapsed playing time
- "File Remain" and remaining playing time
- "OFF"

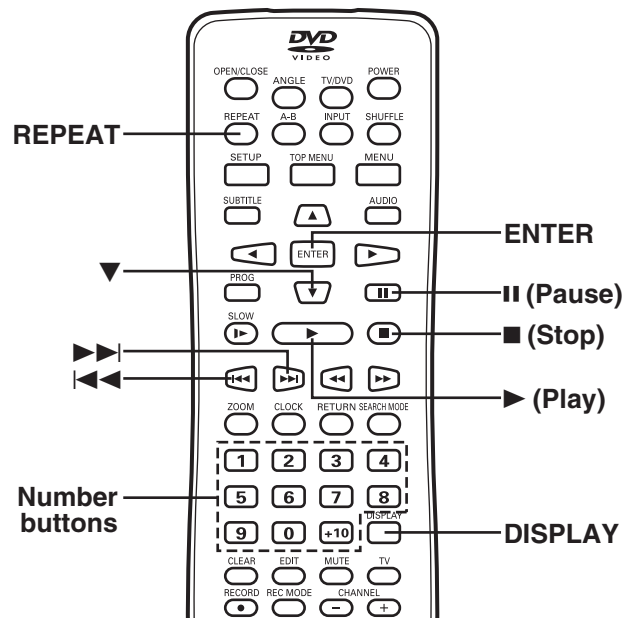

Important Note:

If "⊘" appears on the TV screen during operation, the operation is prohibited by the unit or the disc.



Need help? Call
1-800-813-3435



PICTURE DISC OPERATION

KODAK Picture CD Playback

With KODAK Picture CD, it's easy to turn film into pictures you can email from your PC and view on this unit! Just bring your film in for processing, and check the box for KODAK Picture CD. You'll get back your prints and negatives as usual - plus you'll get a special CD that contains your pictures along with software that lets you view, enhance, share, and print your pictures from your computer and view them on this unit.

1. Press [OPEN/CLOSE] to open the disc tray.

Note:

To open or close the disc tray, be sure to press [OPEN/CLOSE]. Do not press the disc tray with your hand.

2. Place the disc with the label facing up on the disc tray.

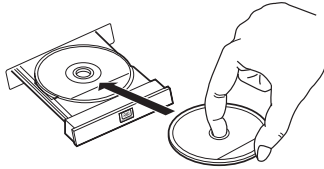

3. Press [OPEN/CLOSE] again to close the disc tray. **Please wait** until "CLOSE" ---> "DISC LOADING" ---> "STOP" disappears on the TV screen. The first thumbnail pictures (maximum 9-picture) appear on the TV screen. Example:

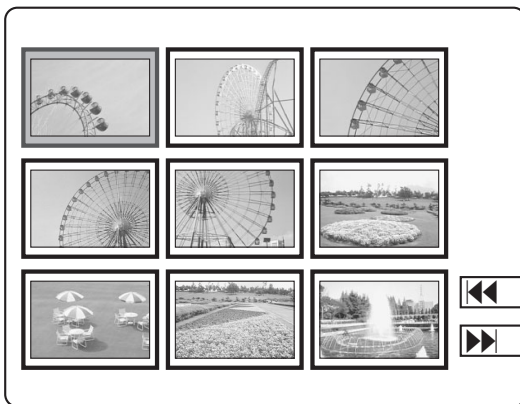

4. Press [▲], [▶], [▼] or [◀] to move the cursor to the desired picture.
 - To go to the next or previous thumbnail pictures, press [▶▶] or [◀◀].
5. Press [ENTER] (or [▶] (Play)) to start the slide show from the selected picture.
 - If you press [■] during the slide show, the slide show stops temporarily. "PAUSE" appears. Press [▶] (Play) (or [■]) again to resume the slide show.
 - **If the picture appears upside down, sideways, etc...** Press [▲], [▶], [▼] or [◀] as follows:
 - ▶ : Rotate it 90 degrees clockwise.
 - ◀ : Rotate it 90 degrees counterclockwise.
 - ▲ : Change it to the vertically reversed image picture.
 - ▼ : Change it to the mirror reversed image picture.
 - If you press [▶▶] or [◀◀] during the slide show, it skips to the next picture or previous picture. "NEXT" or "PREVIOUS" appears briefly.
 - To stop the slide show, press [■]. The thumbnail pictures appear.

Notes:

- If the disc is loaded with the label side downward, or if a badly scratched disc is loaded, "NO DISC" or "NO PLAY" appears on the TV screen. If this occurs, load the disc correctly or replace the disc.
- The file system is ISO9660 Level 1 and Level 2.
- This unit can recognize up to 999 files or folders per disc. The CD with 1000 files or folders and over is not available to this unit.
- FUJICOLOR CD cannot be used.
- Some discs cannot be played back depending on the recording conditions.
- It would take 30 seconds or more for this unit to read KODAK Picture CDs depending on its structure.

KODAK and Picture CD are registered trademarks of Eastman Kodak Company.

Important Note:

If "⊘" appears on the TV screen during operation, the operation is prohibited by the unit or the disc.



**Need help? Call
1-800-813-3435**

JPEG CD Playback

You can also view digital images from JPEG files on disc created by your computer.

- It would take 30 seconds or more for this unit to read the JPEG files depending on its structure.
- Some JPEG files cannot be played back depending on the recording conditions.

1. Load the disc with the label facing up on the disc tray. (See the previous page.)
 - "SmartNAVI" screen appears.

2. To select the file, do one of the following:
 - Press the number button(s).
Example:
To select No.3, press [3].
To select No.10, press [+10], then [0].
To select No.24, press [+10], [+10], then [4].
 - Press [▼] (or [▲]) to select the file, and press [ENTER].



The slide show starts.

- If you press [II] during the slide show, the slide show stops temporarily. "PAUSE" appears. Press [▶] (Play) (or [II]) again to resume the slide show.
- **If the picture appears upside down, sideways, etc...** Press [▲], [▶], [▼] or [◀] as follows:
 - ▶ : Rotate it 90 degrees clockwise.
 - ◀ : Rotate it 90 degrees counterclockwise.
 - ▲ : Change it to the vertically reversed image picture.
 - ▼ : Change it to the mirror reversed image picture.
- If you press [▶▶] or [◀◀] during the slide show, it skips to the next picture or previous picture. "NEXT" or "PREVIOUS" appears briefly.
- To stop the slide show, press [■].

Notes:

- If the disc is loaded with the label side downward, or if a badly scratched disc is loaded, "NO DISC" or "NO PLAY" appears on the TV screen. If this occurs, load the disc correctly or replace the disc.
- The file system is ISO9660 Level 1 and Level 2.
- This unit can recognize up to 999 files or folders per disc. The CD with 1000 files or folders and over is not available to this unit.
- JPEG resolution up to 5120 x 3840.
- Some discs cannot be played back depending on the recording conditions.

Picture Zoom

1. Press [II] at the desired picture (KODAK Picture CD or JPEG CD).
2. Press [ZOOM].
"ZOOM ON" appears briefly on the TV screen.
3. Press [▶▶] or [◀◀] to select the desired picture size.
 - To return to the original size, press [ZOOM] again.
"ZOOM OFF" appears briefly on the TV screen.

If the disc is mixed with MP3 and JPEG files...
The files will be played back in alphabetical order.

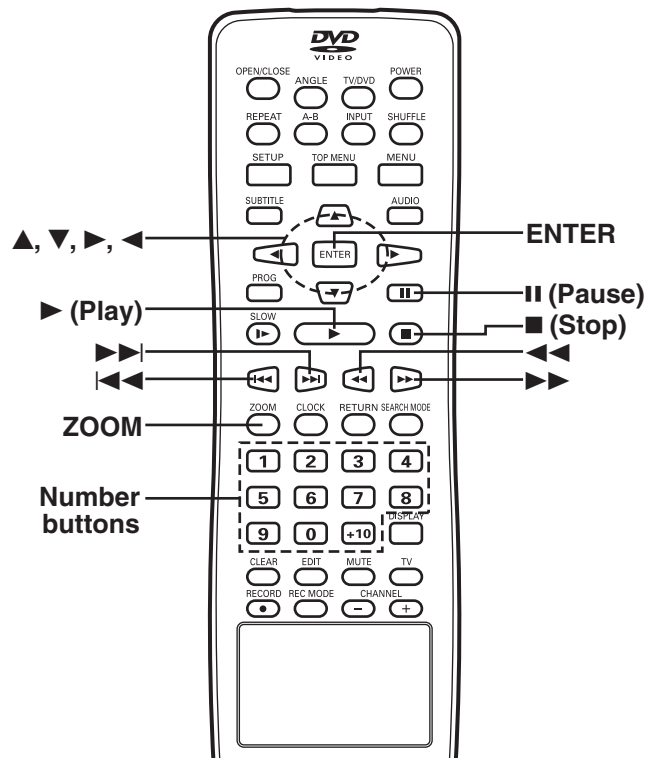

Important Note:

If "⊘" appears on the TV screen during operation, the operation is prohibited by the unit or the disc.



Need help? Call
1-800-813-3435



EDITING

Important Note:

- You may need extra operations during this editing. If a message appears, please follow the instructions displayed on the TV screen.
- This unit may not be able to edit a disc if it was recorded on other DVD recorders or PCs.
- For improvement, on-screen display subject to change without notice.

Preparations

- Load a **DVD+RW** or **DVD+R** disc (label facing up) to be edited, and then press [■] **twice**. (Please refer to "Basic Playback" on page E45.) "SANYO" logo screen remains.

- Press [SETUP]. "Menu" screen appears on the TV screen. "Play/Edit Disc" is highlighted.

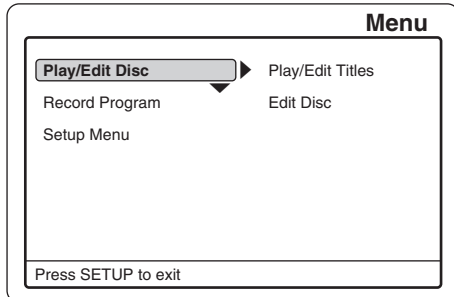

- Press [ENTER] (or [▶]) to select the sub menu.

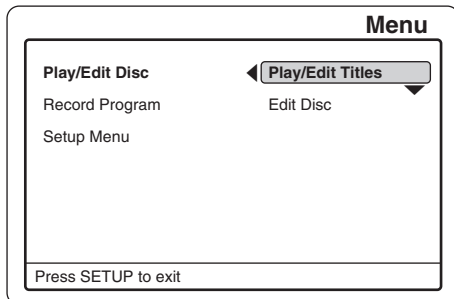

- Press [▼] or [▲] to select the item and go to the reference page.

Play/Edit Titles ==> See the right column.
Edit Disc ==> See page E57.

Notes:

- Once the DVD+R disc is finalized, you cannot edit or record on the disc.
- You may lose the edited contents if you remove the disc or a timer recording starts while editing.



Need help? Call
1-800-813-3435

Check carefully before proceeding.

Play/Edit Titles

- Select "Play/Edit Titles".

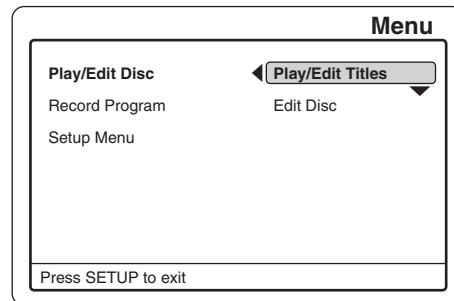

- Press [ENTER]. "TITLE MENU" appears briefly on the TV screen. The title menu screen appears. Example:

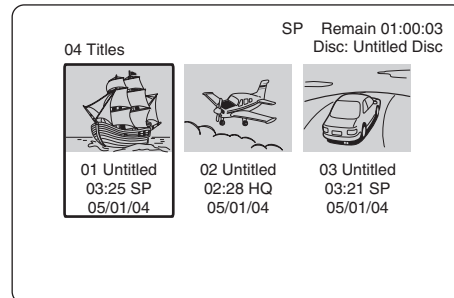

- Press [▶] or [◀] to select the title first.

- Press [EDIT]. The edit screen appears.

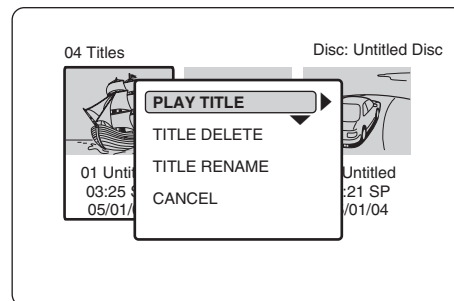

Notes:

- If it is not necessary, select "CANCEL", and then press "ENTER".
- Press [■] to close the screen.

- Press [▼] or [▲] to select the item.

PLAY TITLE [DVD+RW] [DVD+R]

- Select "PLAY TITLE".
- Press [ENTER].

The selected title starts playback.

Please refer to "DISC PLAYBACK" on page E44.

TITLE DELETE [DVD+RW]

Note:

Select the title first. See the previous page.

- 1) Select "TITLE DELETE".

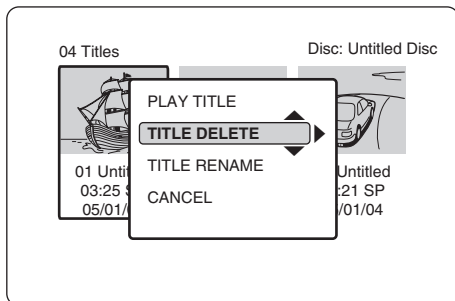

- 2) Press [ENTER].
A message appears.

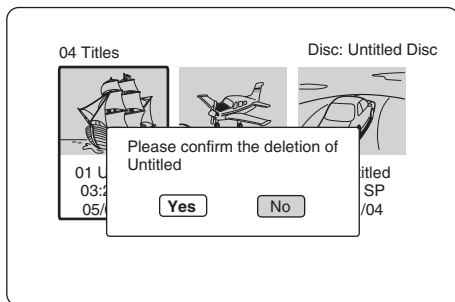

- 3) Press [◀] to select "Yes".
Note:
If it is not necessary, select "No", and then press [ENTER].
- 4) Press [ENTER].
Please wait until "PLEASE WAIT..." disappears on the TV screen.
 - The title menu (with "DELETED") screen returns.

TITLE RENAME [DVD+RW] [DVD+R]

Note:

Select the title first. See the previous page.

- 1) Select "TITLE RENAME".

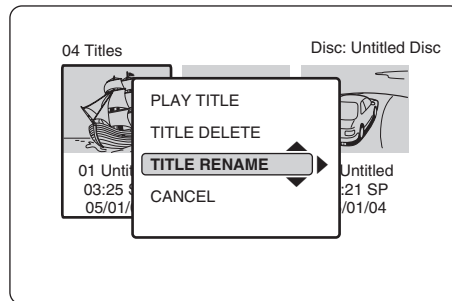

- 2) Press [ENTER].
"Rename" screen appears.

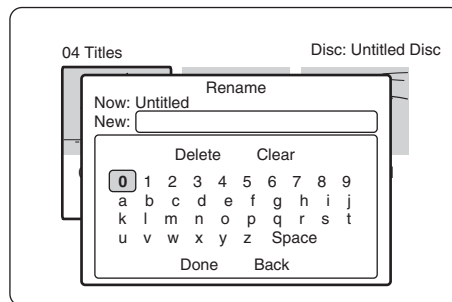

- 3) Press the directional arrow button (▶, ◀, ▲, ▼) to select the letter or number.
- 4) Press [ENTER].
The character appears in the box.
- 5) Repeat steps 3) and 4) to make the new title name (up to 10 characters).

Note:

If you make a mistake, select "Delete" or "Clear", and press [ENTER].

Delete:

Every time [ENTER] is pressed, the last character of the title name is deleted.

Clear:

[ENTER] is pressed, the title name is cleared at once.

- 6) Press [▼] to select "Done".
- 7) Press [ENTER].
Please wait until "PLEASE WAIT..." disappears on the TV screen.
 - The title menu (with the new title name) screen returns.

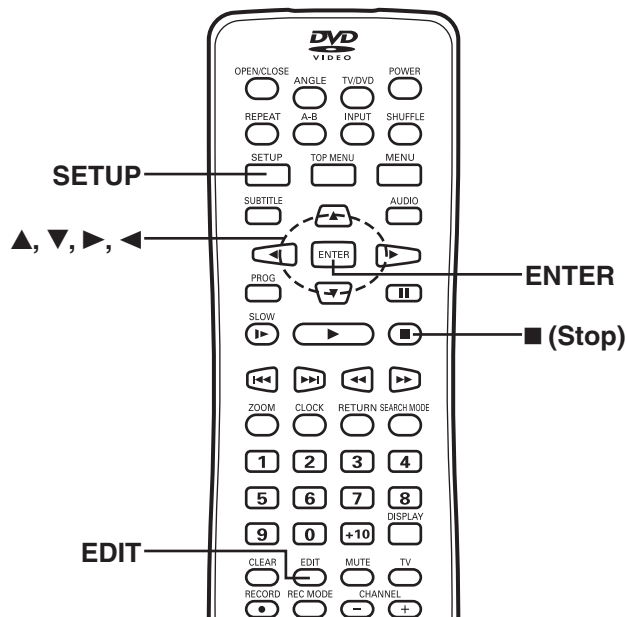

**Need help? Call
1-800-813-3435**

Check carefully before proceeding.

Note:

If it is a title menu screen, press [■] twice.

Edit Disc

1. Select "Edit Disc" in "Menu" screen.
(See page E55.)

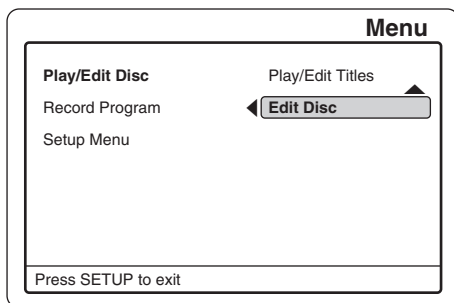

2. Press [ENTER].
"Disc Operations" screen appears.

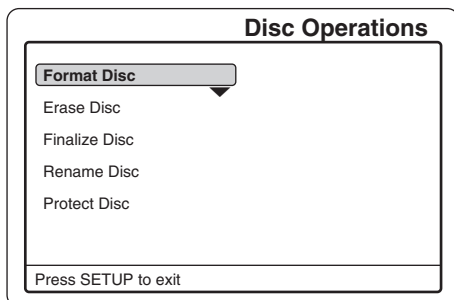

3. Press [▼] or [▲] to select the item.

Format Disc [DVD+RW]

You can delete all titles and create a blank disc. Make sure nothing important is left on the disc.

- 1) Select "Format Disc".
- 2) Press [ENTER].
A message appears.

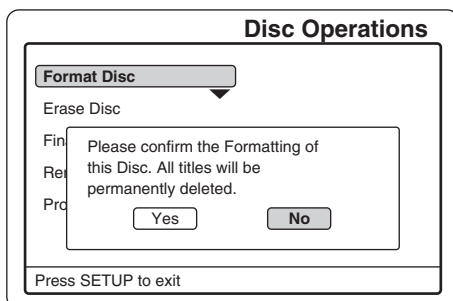

- 3) Press [◀] to select "Yes".
Note:
If it is not necessary, select "No", and then press [ENTER].
- 4) Press [ENTER] to start to format.
Please wait until formatting is finished.
 - "Disc Operations" screen returns.

Erase Disc [DVD+RW]

You can erase all titles on the disc.

- 1) Select "Erase Disc".
- 2) Press [ENTER].
A message appears.

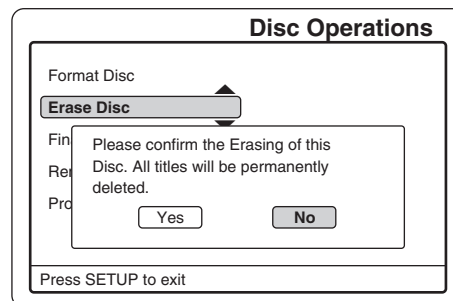

- 3) Press [◀] to select "Yes".
Note:
If it is not necessary, select "No", and then press [ENTER].
- 4) Press [ENTER] to start to erase.
Please wait until erasing is finished.
 - "Disc Operations" screen returns.

Finalize Disc [DVD+R]

After you finalize the disc, you can play the disc on other DVD players. It can be used as DVD-Video disc. However, this is not guaranteed.

CAUTION:

After you finalize a DVD+R disc, you cannot edit or record on the disc. Finish all the editing before you start to finalize the disc.

- 1) Select "Finalize Disc".
- 2) Press [ENTER].
A message appears.

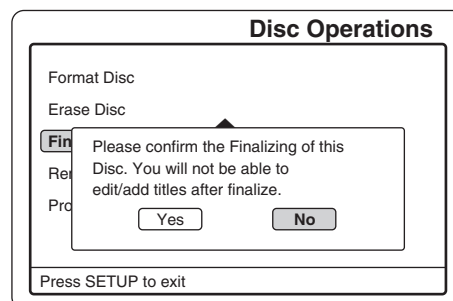

- 3) Press [◀] to select "Yes".
Note:
If it is not necessary, select "No", and then press [ENTER].
- 4) Press [ENTER] to start to finalize.
Please wait until finalizing is finished.
 - "Disc Operations" screen returns.

Notes:

- This unit may not be able to finalize the disc if it was recorded on other DVD recorders or PCs.
- You do not need to finalize the disc again once the disc has been finalized with this unit.
- Depending on the condition of the disc, recording, or the unit, discs may not be played even if the discs are finalized.

Rename Disc [DVD+RW] [DVD+R]

You can enter up to 10 characters for a disc name.

- 1) Select "Rename Disc".
- 2) Press [ENTER].
"New Disc Name" screen appears.

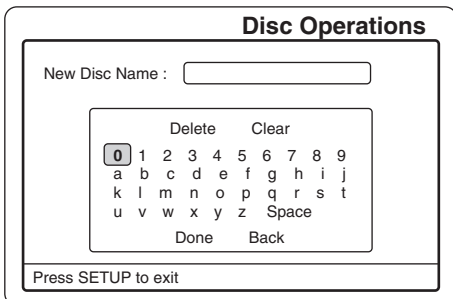

- 3) Press the directional arrow button (▶, ◀, ▲, ▼) to select the letter or number.
Note:
If it is not necessary, select "Back", and then press [ENTER].
- 4) Press [ENTER].
The character appears in the box.
- 5) Repeat steps 3) and 4) to make the new disc name (up to 10 characters).

Note:

If you make a mistake, select "Delete" or "Clear", and press [ENTER].

Delete:

Every time [ENTER] is pressed, the last character of the disc name is deleted.

Clear:

[ENTER] is pressed, the disc name is cleared at once.

- 6) Press [▼] to select "Done".
- 7) Press [ENTER].
Please wait until "Rename disc. Please wait..." disappears.
 - "Disc Operations" screen returns.

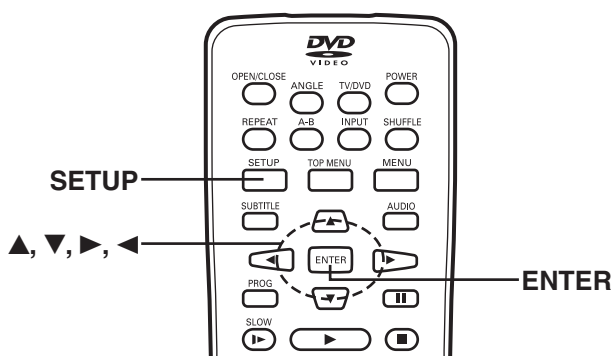

Need help? Call
1-800-813-3435

Protect Disc [DVD+RW]

You can protect a disc from accidental erasure or editing.

- 1) Select "Protect Disc".
- 2) Press [ENTER].
A message appears.

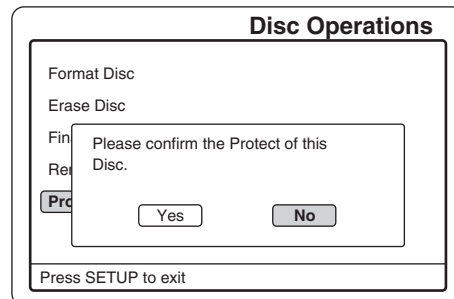

- 3) Press [◀] to select "Yes".
Note:
If it is not necessary, select "No", and then press [ENTER].
- 4) Press [ENTER].
A message appears.

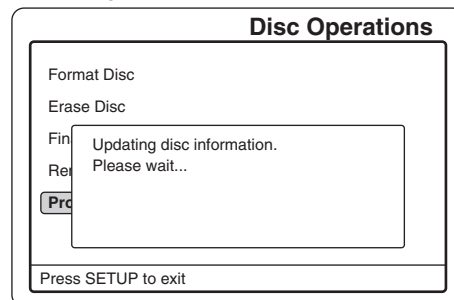

- "Disc Operations" screen returns.
- "Protect Disc" is changed to "Unprotect Disc".

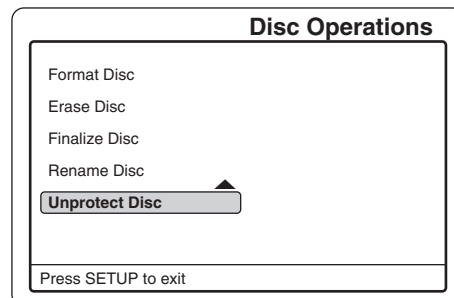

- 5) Press [◀].
"Menu" screen returns.

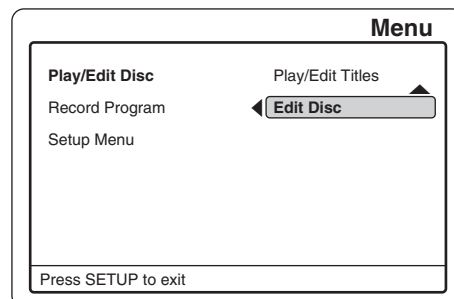

- 6) Press [SETUP] to close the screen.

Note:

When you unprotected the disc protected in the unit, select "Unprotect Disc" for procedure 1) above.
You can record or edit on the disc.

TROUBLESHOOTING GUIDE

If you have followed the instructions and are having difficulty operating the unit, locate the SYMPTOM in the left column below. Check the corresponding POSSIBLE CAUSE and CORRECTIVE ACTION columns to locate and remedy the problem.

Power

SYMPTOM	POSSIBLE CAUSE	CORRECTIVE ACTION
No power.	The power cord is not connected.	Insert the power plug into the AC wall outlet.
	The power is not on.	Press the POWER button to turn the power on.

Operation

SYMPTOM	POSSIBLE CAUSE	CORRECTIVE ACTION
The operation or display is not normal.	The unit must be reset.	<ol style="list-style-type: none"> 1. Disconnect the power cord. 2. Connect the power cord again. 3. Operate the unit.

Picture

SYMPTOM	POSSIBLE CAUSE	CORRECTIVE ACTION
There is no picture.	The video cable is not connected.	Connect the video cable into the jack.
	The TV is not set to receive signals from the unit.	Select the correct input function on the TV.
	No disc is loaded.	Load a disc. See page E45.
	"PROGRESSIVE" mode is set.	Select "INTERLACE" mode. See page E44.
The playback picture is poor.	The disc is dirty.	Clean the disc or replace it.
	An unplayable disc is loaded.	Load a playable or recordable disc. See page E38.
Screen size is wrong.	Incorrect aspect ratio setup on TV.	Refer to your TV's owner manual.
	Incorrect "TV Display" setting.	Select the appropriate setting for your TV screen size. See page E30.
	The aspect ratio of the disc is fixed on your DVD	—
"⊘" appears on the TV screen.	The selected function does not operate on the disc now.	<p>The feature or action cannot be completed at this time because:</p> <ul style="list-style-type: none"> • The operation is prohibited by the unit or the disc. • The feature is not available at the moment. • The DVD software restricts it. • The DVD software doesn't support the feature (e.g., angles).
TV picture does not appear on the TV screen.	The antenna cable is not connected.	See the antenna connections. See page E8.
	TV channel is not selected.	<ul style="list-style-type: none"> • In "NO DISC" mode, (1) press the ■ button, (2) press the TV button, (3) and press the CHANNEL button (+ or -) or press the number buttons on the remote control. • Press the INPUT button to select the TV mode. • Press the TV/DVD button on the remote control to select the TV mode.
TV reception worsens after connecting the unit.	RF signals are weak.	RF signals are being divided between the unit and the TV. Use a signal booster. Please consult your A/V dealer.
The playback picture or TV program from the equipment connected through the unit is distorted.	The program contains copy protection signals that restricts copying.	Disconnect the playback equipment from the unit and connect it directly to your TV.



Sound

SYMPTOM	POSSIBLE CAUSE	CORRECTIVE ACTION
No sound.	The TV is turned off.	Turn on the TV.
	The audio cables are not connected.	Connect the audio cables into the jacks.
	The audio equipment is turned off.	Turn on the audio equipment connected with the audio cables.
Low volume.	The sound volume is low on some DVDs.	Adjust the volume control of your equipment.

Playback

SYMPTOM	POSSIBLE CAUSE	CORRECTIVE ACTION
The disc does not play.	No disc is loaded.	Load a playable disc. See page E45.
	A blank disc is loaded.	Load a playable disc. See page E38.
	The disc is upside down.	Load the disc with the labeled side facing up.
	An unplayable disc is loaded.	<ul style="list-style-type: none"> Load a playable disc. (Check the disc logo, type, color system, and region number.) See page E38. When the disc was recorded on another DVD recorder, the unit cannot play if it was not finalized. However, the disc cannot be played back depending on the recording condition.
	"Parental" is set.	Cancel the parental lock function or change the rating level. Reset it after play. See page E27.

Recording/Timer Recording

SYMPTOM	POSSIBLE CAUSE	CORRECTIVE ACTION
Cannot record.	An unrecordable disc is loaded.	Load a DVD+RW or DVD+R disc. See page E38.
	The disc is upside down.	Load the disc with the labeled side facing up.
	The disc is set to "Protect Disc".	Release the function on the disc. See page E58.
	The disc space is not enough.	Load a new DVD+RW or DVD+R disc.
Timer recording does not start.	The clock setting is not correct.	See "SETTING THE CLOCK" on page E18.
	The timer setting is not correct or overlapped with another setting.	Set the Record Time correctly. See "Record Status" on page E33.
	The disc space is not enough.	Load a new DVD+RW or DVD+R disc.

SERVICING:

Should this product require service, refer to the SANYO AUDIO/VIDEO limited warranty.

If you do not have a convenient SANYO service station nearby, contact the SANYO dealer where you purchased the unit. Be sure to give the model number and explain the problem. The dealer will advise you how to obtain service.



Need help? Call
1-800-813-3435



MAINTENANCE

WARNING:

FOR YOUR PERSONAL SAFETY, BE SURE TO DISCONNECT THE AC POWER CORD BEFORE PROCEEDING WITH ANY MAINTENANCE OR CLEANING.

Cleaning the cabinet

Use a clean soft cloth moistened with plain lukewarm water and wrung dry. Never use benzol, benzene or other strong chemical cleaners since these could damage the finish of your unit. It is important that no liquid reaches the inside of the unit.

SPECIFICATIONS

Playable discs

DVD+RW
DVD+R
DVD-VIDEO
DVD-R (Video mode)
DVD-RW (Video mode)
Audio CD (CD-DA)
MP3 CD
JPEG CD
Kodak Picture CD

Recordable discs

DVD+RW
DVD+R

Video recording format

DVD+RW Video Format

Audio recording format

MPEG Audio

Recording time (DVD+RW, Version 1.2)

HQ: Approx. 60 minutes
SP (Standard mode): Approx. 120 minutes
LP: Approx. 180 minutes
EP: Approx. 240 minutes
EP+: Approx. 360 minutes

TV system

NTSC standard system

Tuner channel range

VHF: 2-13
UHF: 14-69
CATV: 1-125

RF converter

Built-in VHF converter

Converter output

Channel 3 or 4 selectable

Time indication

24-hour system

Timer

1 year/15-event programmable

Outputs

COMPONENT VIDEO OUT:

Y: 1.0 Vp-p (75 Ω)
Pb: 0.7 Vp-p (75 Ω)
Pr: 0.7 Vp-p (75 Ω)
VIDEO: 1.0 Vp-p (75 Ω)

S-VIDEO:

Y: 1.0 Vp-p (75 Ω)
C: 0.286 Vp-p (75 Ω)

DIGITAL AUDIO:

Optical & Coaxial

AUDIO (L/R):

2 V rms

Inputs

AV1 IN:

VIDEO: 1.0 Vp-p (75 Ω)

S-VIDEO:

Y: 1.0 Vp-p (75 Ω)
C: 0.286 Vp-p (75 Ω)

AUDIO (L/R): 2 V rms

AV2 IN:

VIDEO: 1.0 Vp-p (75 Ω)

S-VIDEO:

Y: 1.0 Vp-p (75 Ω)
C: 0.286 Vp-p (75 Ω)

AUDIO (L/R): 2 V rms

Power requirements

120 V AC, 60 Hz

Power consumption

28 Watts

Dimensions (W x H x D)

Approx. 16.9" x 2.3" x 14" (430 x 59 x 355 mm)

Weight

Approx. 8.1 lbs (3.7 kg)

IMPORTANT INFORMATION

Because its products are subject to continuous improvement, Sanyo reserves the right to modify product designs and specifications without notice and without incurring any obligation.

For assistance in obtaining repairs and operational information, please contact the following Toll Free Number:

DIAL TOLL FREE: 1-800-813-3435

Weekdays: 7:30 AM - 4:00 PM Central Time

Also, you may write to SANYO Manufacturing Corporation, 3333 Sanyo Road, Forrest City, Arkansas 72335.

Limited Warranty

LABOR 1 YEAR

PARTS 1 YEAR

CARRY-IN ONLY

THIS WARRANTY IS VALID ONLY ON SANYO PRODUCTS PURCHASED FROM A WAL-MART STORE AND USED IN THE UNITED STATES OF AMERICA, EXCLUDING HAWAII AND ALL U.S. TERRITORIES AND PROTECTORATES. THIS WARRANTY APPLIES ONLY TO THE ORIGINAL RETAIL PURCHASER AND DOES NOT APPLY TO PRODUCTS USED FOR ANY INDUSTRIAL, PROFESSIONAL OR COMMERCIAL PURPOSE.

Subject to the OBLIGATIONS and EXCLUSIONS below, SANYO Manufacturing Corporation ("SANYO") warrants this SANYO product against defects in materials and workmanship for the periods of LABOR and PARTS specified above. SANYO will repair or replace (at its option) the product and any of its parts which fail to conform to this warranty with new or refurbished products or parts. The warranty period commences on the date the product was first purchased at retail from a Wal-Mart Store.

OBLIGATIONS

In order to obtain warranty service, the product must be delivered to and picked up from a Wal-Mart Store at the original retail purchaser's expense. The original dated bill of sale, or sales slip from a Wal-Mart Store must be submitted to a Wal-Mart Store at the time warranty service is requested.

EXCLUSIONS

1. This warranty does not cover (A) the adjustment of customer-operated controls as explained in the appropriate model's instruction manual, or (B) the repair of any product whose serial number has been altered, defaced or removed.
2. This warranty shall not apply to the cabinet or cosmetic parts, broken or damaged video heads, batteries or routine maintenance.
3. This warranty does not apply to uncrating, setup, installation, removal of the product for repair or reinstallation of the product after repair.
4. This warranty does not apply to repairs or replacements necessitated by any cause beyond the control of SANYO including, but not limited to, any malfunction, defect or failure caused by or resulting from unauthorized service or parts, improper maintenance, operation contrary to furnished instructions, shipping or transit accidents, modification or repair by user or any third party, abuse, misuse, neglect, accident, incorrect line voltage, fire, flood or other Acts of God, or normal wear and tear.

The foregoing is in lieu of all other express warranties and SANYO does not assume or authorize any party to assume for it any other obligation or liability.

THE DURATION OF ANY WARRANTIES WHICH MAY BE IMPLIED BY LAW (INCLUDING THE WARRANTIES OF MERCHANTABILITY AND FITNESS) IS LIMITED TO THE TERM OF THIS WARRANTY. IN NO EVENT SHALL SANYO OR THE MANUFACTURER OF THE PRODUCT BE LIABLE FOR SPECIAL, INCIDENTAL OR CONSEQUENTIAL DAMAGES ARISING FROM OWNERSHIP OR USE OF THIS PRODUCT, OR FOR ANY DELAY IN THE PERFORMANCE OF ITS OBLIGATIONS UNDER THIS WARRANTY DUE TO CAUSES BEYOND ITS CONTROL.

SOME STATES DO NOT ALLOW LIMITATIONS ON HOW LONG AN IMPLIED WARRANTY LASTS AND/OR DO NOT ALLOW THE EXCLUSION OR LIMITATION OF CONSEQUENTIAL DAMAGES, SO THE ABOVE LIMITATIONS AND EXCLUSIONS MAY NOT APPLY TO YOU.

THIS WARRANTY GIVES YOU SPECIAL LEGAL RIGHTS. YOU MAY HAVE OTHER RIGHTS, WHICH VARY FROM STATE TO STATE. R03/12/18 (M)

For your protection in the event of theft or loss of this product, please keep the following information with a sales receipt in a safe place.

Model No. _____ Serial No. _____ Date of Purchase _____

Purchase Price _____ Where Purchased _____

SANYO

SANYO Manufacturing Corporation



SANYO

SANYO Electric Co., Ltd.
Printed in China



Free Manuals Download Website

<http://myh66.com>

<http://usermanuals.us>

<http://www.somanuals.com>

<http://www.4manuals.cc>

<http://www.manual-lib.com>

<http://www.404manual.com>

<http://www.luxmanual.com>

<http://aubethermostatmanual.com>

Golf course search by state

<http://golfingnear.com>

Email search by domain

<http://emailbydomain.com>

Auto manuals search

<http://auto.somanuals.com>

TV manuals search

<http://tv.somanuals.com>