



Digital Video Recorder

DSR-M810P

■ Instruction manual

English

GB

About this manual

Before installing and using this unit, please read this manual carefully. Be sure to keep it handy for later reference.

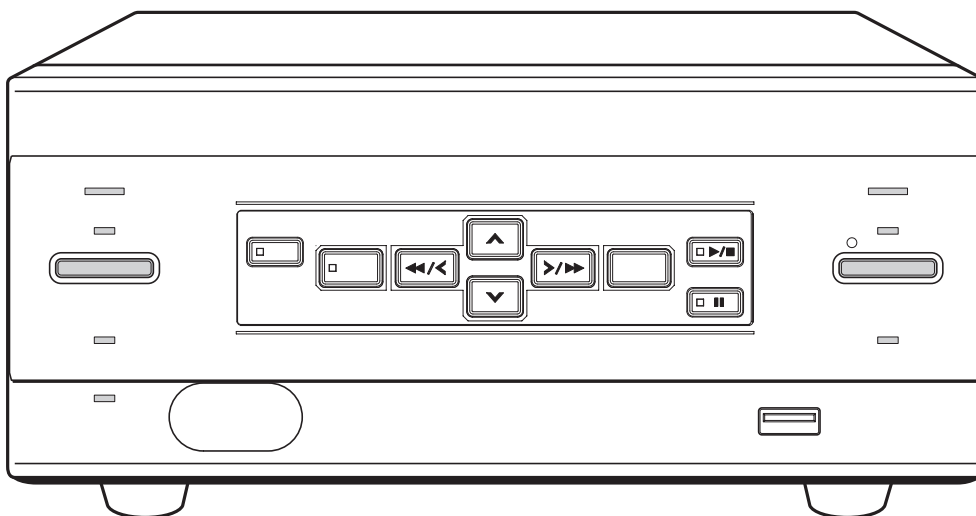

PRECAUTION

WARNING: TO REDUCE THE RISK OF FIRE OR ELECTRIC SHOCK, DO NOT EXPOSE THIS APPLIANCE TO RAIN OR OTHER MOISTURE.
To avoid electrical shock, do not open the cabinet.
Refer servicing to qualified personnel only.
If the power supply cord (AC power cord) of this appliance is damaged, it must be replaced. Return to a SANYO Authorised Service Centre for replacement of the cord.

Location

For safe operation and satisfactory performance of your unit, keep the following in mind when selecting a place for its installation:

Shield it from direct sunlight and keep it away from sources of intense heat.

Avoid dusty or humid places.

Avoid places with insufficient ventilation for proper heat dissipation. Do not block the ventilation holes at the top and bottom of the unit. Do not place the unit on a carpet because this will block the ventilation holes.

Install the unit in a horizontal position only.

Avoid locations subject to strong vibrations.

Avoid moving the unit between cold and hot locations.

Do not place the unit directly on top of a monitor TV, as this may cause playback or recording problems.

Avoiding Electrical Shock and Fire

Do not handle the power cord with wet hands.

Do not pull on the power cord when disconnecting it from an AC wall outlet. Grasp it by the plug.

If any liquid is spilled on the unit, unplug the power cord immediately and have the unit inspected at a factory-authorized service centre.

Do not place anything directly on top of this unit.

SERVICE

This unit is a precision instruments and if treated with care, will provide years of satisfactory performance. However, in the event of a problem, the owner is advised not to attempt to make repairs or open the cabinet. Servicing should always be referred to your dealer or Sanyo Authorized Service Centre.

CAUTION

Danger of explosion if battery is incorrectly replaced.
Replace only with the same or equivalent type recommended by the manufacturer.
Discard used batteries according to the manufacture's instructions.

INTRODUCTION

Main features

This digital video recorder can be used to store images recorded by a monitoring camera onto its built-in hard disk.

■ Complete range of recording/playback functions

- You can play back and record images at the same time.
- You can record and play back audio.
- The timer record function lets you make recordings at different times each day. (→P.31)

■ The search function lets you instantly display the desired image. (→P.18)

- Searching in order of alarm occurrence (new to old)
- Searching by date/time

■ The security lock function lets you restrict users for data and equipment management. (→P.36)

■ Expandable, can be connected to a PC

- The LAN terminal lets you connect the digital video recorder to a network, for remote operation/remote monitoring.*
- Network connection lets you control up to 4,000 DVRs (digital video recorders) using 8 PCs.*
- Can be connected to a system controller (sold separately) using the RS-485 terminal.
- A CompactFlash card reader or CD-R/RW drive can be connected using the USB terminal, letting you upload/download menu data to a CompactFlash card and copy recorded images onto a CompactFlash card or CD-R/RW.

Items marked by asterisks (*) require the VA-SW81LITE remote operation software (accessory) or VA-SW814 remote operation software (sold separately). For more information, contact a Sanyo Authorized Service Center.

Accessories

Check that you have all the parts below.

Power cord

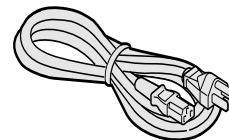

Ferrite core (2) (for LAN connection cable/ DVR power cord)

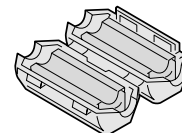

Power cord tie

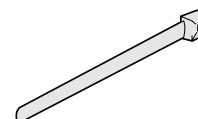

Application software (VA-SW81LITE)

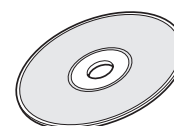

Symbols used in this manual

NOTE Information describing operation methods or how to get the most out of functions

CAUTION Information describing the correct use of the digital video recorder

(→P. xx) Indicates manual page to refer to.

Copyright

- This manual and software are copyrighted by Sanyo Electric Co., Ltd.
- Brand and product names used in this manual are the trademarks or registered trademarks of their respective companies.
- Except for personal use, copyright law prohibits the use of recorded copyrighted images without the permission of the copyright holder.
- Sanyo's DSR-M810P Digital Video Recorder uses software components distributed as freeware based on end user license agreements or copyright notifications (collectively referred to as "EULA") set forth by third parties.

CONTENTS

INTRODUCTION

1 BEFORE USE 5	2 NAMES AND FUNCTIONS OF PARTS 7
Notes on handling internal hard disk drive components 5	Front panel 7
Do not use the digital video recorder in the following locations: 5	Rear panel 8
The hard disk and cooling fan are consumables. 5	3 INSTALLATION AND CONNECTIONS 9
Installation conditions 5	Basic connections 9
For important recordings 6	System controller connections 9
Hard disk protection 6	Connecting a remote control circuit 9
Care 6	Connecting cables to the control and alarm terminals 10
During extended disuse 6	Connecting to a network 10
Backup battery 6	Connecting the power cord 10
MENU button 6	

OPERATION

1 SCREEN DISPLAY AND POSITION 11	5 NORMAL RECORDING/TIMER RECORDING PLAYBACK 16
Operation display area 11	Playback 16
Changing the position of the operating display 11	Playback while fast-forwarding/rewinding 16
2 SETTING THE LANGUAGE/CLOCK 12	Viewing still images 17
To change the language 12	Frame advance (reverse) 17
Setting the time 13	6 SEARCHING FOR RECORDED IMAGES 18
3 NORMAL RECORDING/TIMER RECORDING 14	Alarm search 18
Normal recording 14	Date/time search 19
Timer recording 14	7 COPYING TO CF CARDS OR CD-R/RW DISCS AND FORMATTING 21
4 ALARM RECORDING 15	Copying image 21
Alarm recording 15	Formatting a CompactFlash card or CD-RW 22
	8 PREVENTING ACCIDENTAL OPERATION (KEY LOCK FUNCTION) 23
	Setting the key lock function 23
	Releasing the key lock function 23

SETTINGS

MENU CONFIGURATION AND OPERATIONS 24

- Displaying the menu screen and sub-menu screens 24
- To restore menu setting items to their initial values 24
- Overview of sub-menus 25

1 LANGUAGE/CLOCK SET 26

- <SUMMER TIME SET> settings 26
- <EXT.CLOCK SET> settings 27

2 REC MODE SET 29

- <REC MODE SET> setting items 29
- Settings 30
- Starting recording again when the FULL indicator lights 30

3 TIMER REC SET 31

- Timer setting items 31
- Timer reservations every day at the same time with the same image quality 31
- To cancel all timer reservations 32
- Timer reservations spanning more than 24 hours 32
- Setting holidays 33

4 DISPLAY/BUZZER SET 34

- <DISPLAY/BUZZER SET> setting items 34
- Settings 35

5 SECURITY LOCK SET 36

- Password setting example 36
- Password setting 36
- Setting passwords 36
- Setting the user password 37
- Setting the authorization for recording and playback operations 38
- Setting the security lock 38

6 RS-485/NETWORK SET 39

- Network connections and settings 39
- RS-485 connections and settings 40
- Setting REMOTE SET 41

7 POWER LOSS/USED TIME 42

8 MENU UPLOAD/DOWNLOAD 43

- Operations 43

9 HDD SET 46

- Initializing the hard disk 46
- Adding a hard disk 47

OTHER

1 INTERFACE SPECIFICATIONS 48

- RS-485 specifications 48
- RS-485 termination switch settings..... 48
- DVR/VCR command table 49

2 SPECIFICATIONS 50

- Dimensions 51

INDEX 52

Notes on handling internal hard disk drive components

This unit has a built-in hard disk drive (HDD). Be sure to observe the following points carefully when operating, setting-up and servicing the unit.

■ Do not subject the unit to shocks or vibration.

If the unit is subjected to shocks or vibration, it may damage the HDD or cause corruption of the data stored in the HDD.

- Do not move the unit while the power is turned on. Turn off the power and wait approximately 30 seconds before removing the unit from or placing it in a rack.
- When transporting the unit, pack it securely using the specified packing materials. In addition, use a method of transportation that minimizes vibration.
- When placing the unit down on a surface such as a floor, attach the specified feet to the base of the unit and place it down gently.

■ Do not move the unit for 30 seconds after turning off the power.

After the power is turned off, the disk inside the HDD will continue to spin for a brief period due to inertia, and the heads will be in an unstable state.

During this time, the unit is even more susceptible to shocks and vibration than when power is being supplied. Make sure that the unit is not subjected to even gentle vibration for at least 30 seconds after turning off the power.

■ Do not operate the unit when condensation has formed.

If the unit is operated when condensation has formed, it may cause operating problems.

If sudden changes in the ambient temperature occur, wait for the temperature to stabilize before operating the unit.

■ Notes when replacing the HDD

Be sure to follow the correct replacement procedure when replacing the HDD.

- HDDs that have been removed from their packing may not operate correctly if they are subjected to any shocks and vibration. It is recommended that you place HDD onto a soft, level surface with the printed circuit board facing upward after unpacking it.
- Be careful not to subject the HDD to shocks or vibration when removing and tightening screws as part of the HDD replacement procedure.
- Make sure that all screws are tightened securely so that they will not become loose.

The HDD is sensitive to static electricity, so you should take proper precautions to prevent static electricity buildup.

■ Handling the HDD unit by itself

If transporting or storing the HDD unit by itself, always be sure to pack it in the specified packing first.

In addition, use a method of transportation that minimizes the vibration.

If the HDD becomes damaged, handle the unit and the damaged HDD that has been removed in order for it to be replaced carefully to prevent the problem from being aggravated until as the nature of the problem can be checked and analyzed.

Do not use the digital video recorder in the following locations:

- The hard disk is sensitive to dust, vibrations and shocks, and should also not be used near magnetic objects. To prevent loss of recorded data, observe the following precautions:
 - Do not subject the digital video recorder to shocks.
 - Do not use the digital video recorder on a vibrating or unstable surface.
 - Do not disconnect the power plug from the wall outlet during recording or playback.
 - Do not use the digital video recorder in areas of extreme temperature changes (10°C or more per hour).
 - Condensation may occur if the digital video recorder is moved to an area of extremely different temperature or high humidity. If the digital video recorder is used with condensation inside it, operating problems may occur.
 - Do not install the digital video recorder in areas of constant vibration such as motor vehicles or trains.

The hard disk and cooling fan are consumables.

Under use in an ambient temperature of 25°C, the hard disk should generally be replaced after 2 years, and the cooling fan after 3 years. These figures are intended as guidelines only, and are not guarantees of part performance.

The POWER indicator flashes if a problem occurs in the hard disk or fan. (→P.10)

Installation conditions

The digital video recorder has ventilation holes on its left, rear and bottom panels. Make sure these holes are not blocked after installation.

Do not use the unit in an area of poor ventilation such as a bookshelf or box.

When installing the unit in a rack, ensure a gap of at least 5 cm at the top and bottom.

For important recordings

- Always make a test recording beforehand to check that the digital video recorder's playback is normal.
- Note that no compensation will be provided for losses due to recording or playback problems arising from problems with the digital video recorder or its connected devices during operation.
- To be prepared for malfunctions or accidents, back up important recordings periodically, or record using mirroring.

Hard disk protection

The hard disk is checked automatically at power ON. If a hard disk problem is found, the POWER indicator flashes. If you need to initialize the disk or save images stored on the disk, contact a Sanyo Authorized Service Center.

Care

- To clean the digital video recorder, unplug the power plug from the wall outlet and wipe the unit lightly with a soft cloth.
- To remove heavy grime, wipe the digital video recorder with a well-wrung cloth soaked in a solution of water and neutral detergent, and then wipe it with a dry cloth.
- Do not clean the unit with benzine or paint thinner. Doing so may break down the finish or strip the paint.
- When using a chemical cloth, be sure to follow the precautions provided with it.
- Do not spray insecticide or other volatile chemicals on the cabinet. Do not allow rubber or vinyl products to come into contact with the digital video recorder for extended periods. Doing so may break down the finish or strip the paint.

During extended disuse

Extended disuse may cause problems in functions, so turn the power ON and operate the unit occasionally during such periods.

Backup battery

The digital video recorder comes with a built-in lithium battery. When the digital video recorder has been connected to a wall outlet for at least 48 hours and the date and time have been set, the clock function will continue to operate for up to 30 days after the power plug is disconnected.

When disposing of the digital video recorder, contact a Sanyo Authorized Service Center for information on how to dispose of the lithium battery.

MENU button

You cannot use the [MENU] button while using the remote operation software VA-SW81LITE/VA-SW814. Conversely, you cannot use the remote operation software when the [MENU] button is enabled.

Front panel

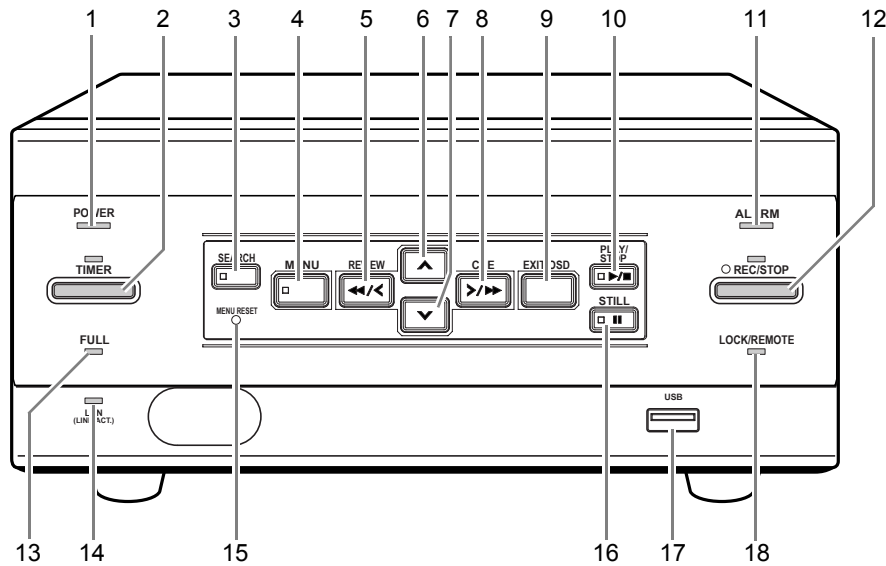
**1. POWER indicator**

Lights when the power is ON.
Flashes when there is a problem with the hard disk or fan.
(→P.10)

2. [TIMER] button and indicator (→P.14)

If this button is pressed while recording is stopped, the digital video recorder enters timer recorder standby and the indicator lights up. When the set time arrives, the digital video recorder starts timer recording.

3. [SEARCH] button and indicator (→P.18)

When the button is pressed while recording or stopped, the indicator lights, and the search setting screen appears.

4. [MENU] button and indicator

Used to display the menu screens (setting screens). The indicator lights when a menu screen is displayed.

5. [REVIEW] button

When pressed during playback, lets you rewind the image. Also used for menu screen operations.

6. [▲] button

Used to move the cursor in menu screens up. Also used to change setting values.

7. [▼] button

Used to move the cursor in menu screens down. Also used to change setting values.

8. [CUE] button

When pressed during playback, lets you fast-forward the image. Also used for menu screen operations.

9. [EXIT/OSD] button

Returns to the normal screen when the main menu or a sub-menu is displayed.

10. [PLAY/STOP] button and indicator

Plays back the normal image (indicator lights). When pressed during playback, stops playback.

11. ALARM indicator

Flashes when recording an alarm image.

12. [REC/STOP] button and indicator

Starts normal recording. Indicator lights during recording. During recording, pressing the button for at least 3 seconds stops recording and turns off the indicator.

13. FULL indicator (→P.14)

Lights when the remaining memory in the hard disk's recording area has reached zero and recording has stopped.

14. LAN indicator

Lights when the digital video recorder is connected to a network. Flashes when data is being sent and received.

15. [MENU RESET] button (→P.24)

Used to initialize the currently displayed menu settings, and to set the time.

16. [STILL] button and indicator

When pressed during playback, freezes the screen image (the indicator lights). Pressing the button again resumes playback.

17. USB terminal (→P.21, P.43)

Used to connect a CompactFlash card reader or CD-R/RW drive.

18. LOCK/REMOTE indicator (→P.23, P.38)

Lights when operations have been locked by the key lock or security lock setting.

If an operation button other than [MENU] button is pressed when the security lock is set, a buzzer sounds. The key lock cannot be set during playback.

The indicator flashes at 4Hz when there is a network connection, and flashes at 1Hz when there is a network connection while locked.

Rear panel

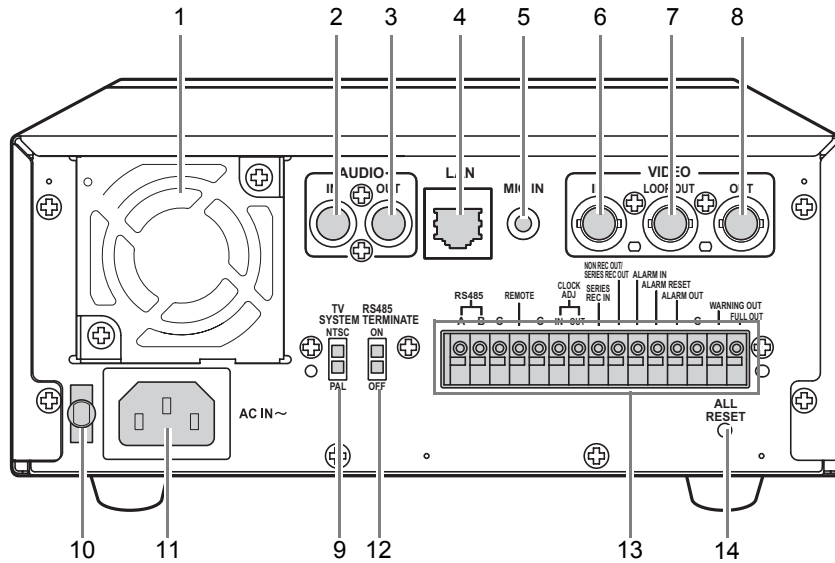

- 1. **FAN**
- 2. **AUDIO IN terminal**
- 3. **AUDIO OUT terminal**
- 4. **LAN terminal (→P.39)**
- 5. **MIC IN terminal**
- 6. **VIDEO IN terminal**
- 7. **VIDEO LOOP OUT terminal**
- 8. **VIDEO OUT terminal**
- 9. **TV SYSTEM selector switch**
Used to select the video signal between NTSC and PAL systems for the camera input and TV monitor output connected to the digital video recorder.

NOTE

- Turn the power OFF then ON again after switching the TV SYSTEM selector switch to NTSC or PAL.

- 10. **Power cord holder**
Secure the power cord to the holder using the cord tie (accessory) as shown in the illustration.

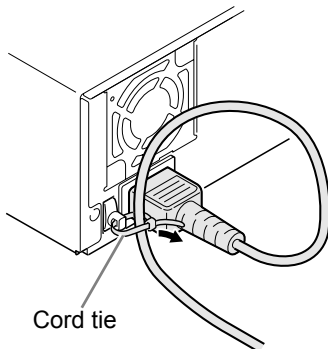

- 11. **AC INLET**
AC power input terminal (3-core)

- 12. **RS-485 TERMINATE switch (→P.48)**
RS-485 termination ON/OFF switch
- 13. **Control and alarm terminals**

Pin	Signal
RS-485A	To RS-485 terminal signal A *1
RS-485B	To RS-485 terminal signal B *1
C	Common *1
REMOTE	For wired remote control (VA-RMN01)
C	Common
CLOCK ADJ IN	Input for clock setting
CLOCK ADJ OUT	Output for clock setting
SERIES REC IN	SERIES-REC input
NON REC OUT/ SERIES REC OUT	NON-REC output/ SERIES-REC output *2
ALARM IN	Alarm input
ALARM RESET	Alarm reset input
ALARM OUT	Alarm output
C	Common
WARNING OUT	Warning output *3
FULL OUT	Recording area full warning

*1 Use a twisted-pair cable for connection.
 *2 NON REC is output when SERIES REC OUT is OFF.
 *3 The following warnings are output:
 ● Hard disk drive error ● Fan error ● Recording error
 ● No input signal when VIDEO LOSS is ON.

- 14. **ALL RESET switch**
Resets the clock and backup mode setting.

This section describes how to connect the digital video recorder to the CCTV camera and other devices. Be sure to read the instruction manuals for each connected device. Make connections carefully. Improper connections can cause smoke or malfunctions.

Basic connections

The connections for the camera, TV monitor, microphone and PC are shown below.

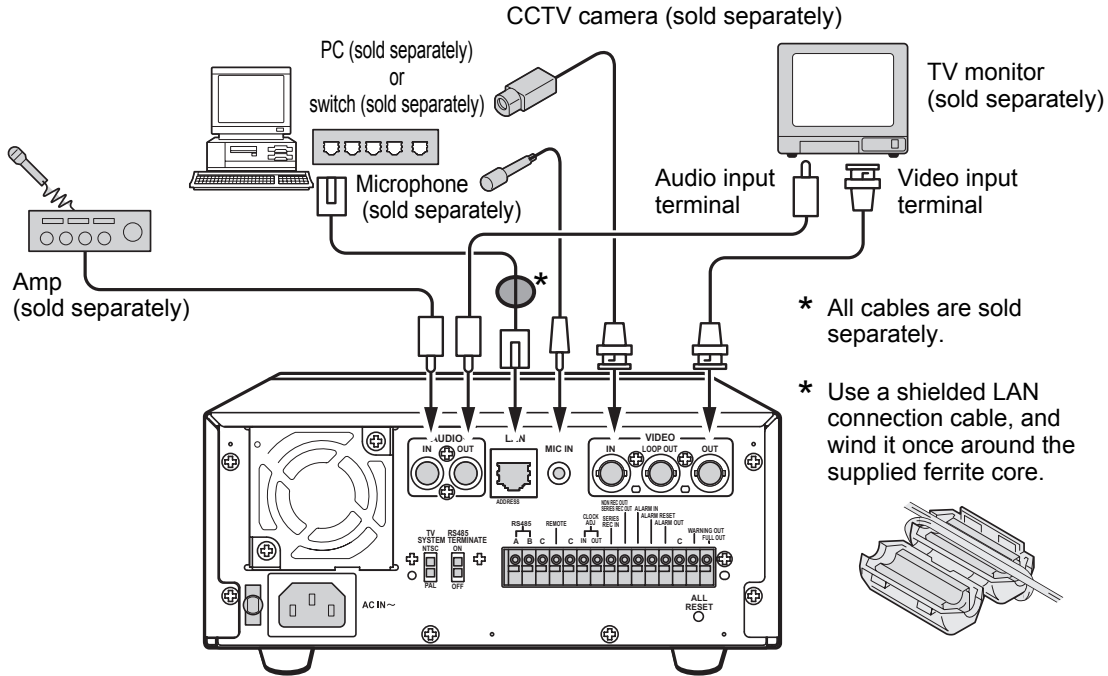

System controller connections

The connections for a system controller are shown below. Use a twisted-pair cable (sold separately) to connect rear panel control terminals A, B and C (ground). Connect signal A to signal A, and signal B to signal B.

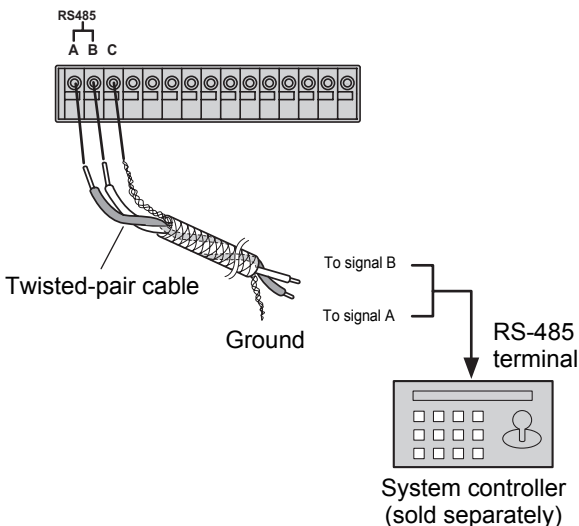

- Twisted-pair cable
Can reduce interference on the signal caused by noise generated by other cables.

Connecting a remote control circuit

The connections for a remote control circuit are shown below. Making the connections shown below lets you operate the digital video recorder by remote control.

- Create the remote control circuit shown in the illustration, and connect it to the remote control input terminals (among the control terminals).

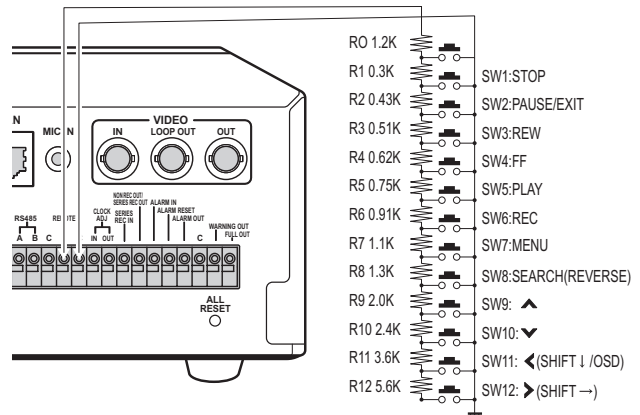

() : When VA-RMN01 is used
Use a resistance of 1/10 ohms or more and with a D ranking (precision 0.5% or finer).

NOTE

- In order to stop recording using the remote-control REC button, "REMOTE SET" must be set. (→P.41)

- Connect the cable of the wired remote control (VA-RMN01) (sold separately) to the remote control input terminals (among the control terminals).
Cut the plug off the cord, and connect the red wire to "REMOTE" and the bare wire to "C".

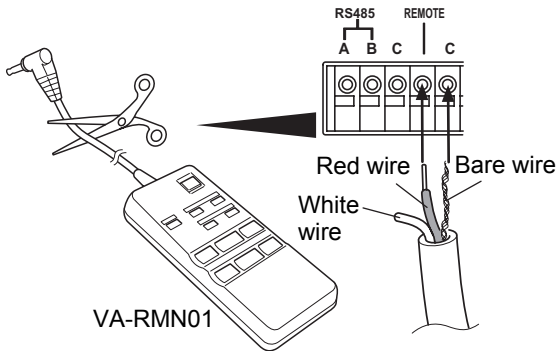

Connecting cables to the control and alarm terminals

- (1) Push in the lock pin with a flat-blade screwdriver.
- (2) Insert the cable.
- (3) Pull out the lock pin with a flat-blade screwdriver. The cable is now fixed in place.

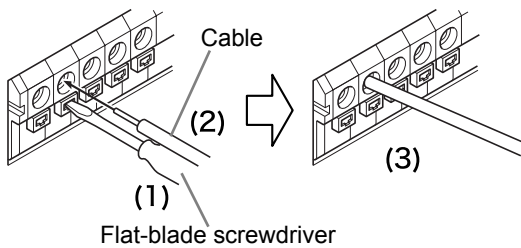

Connecting to a network

The VA-SW81LITE/VA-SW814 application software lets you control the digital video recorder, and monitor live images, recorded images and audio through a network.

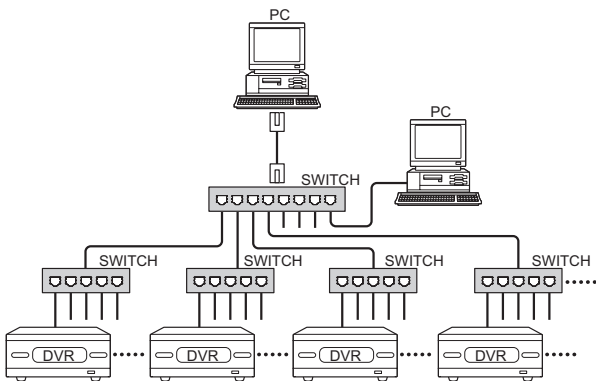

Connecting the power cord

- 1 When you have finished making all the other connections, insert the power plug into the wall outlet.

There is no power switch. The POWER indicator lights, then all the indicators on the front panel flash for approximately 30 seconds. The monitor screen displays the camera image.

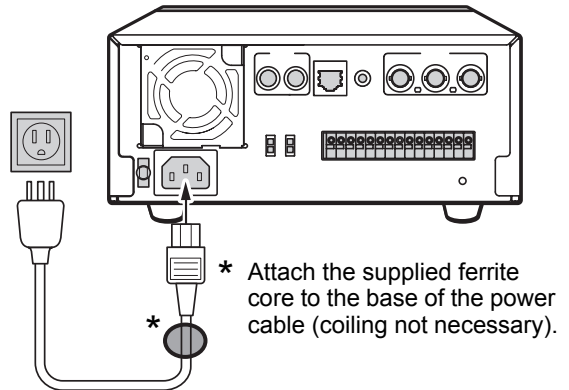

- **When turning the power ON for the first time**
"PLEASE SET THE CLOCK" is displayed on the monitor screen. Follow the steps on P.12 to set the clock.
- **If the clock is already set**
The operation display area is displayed.

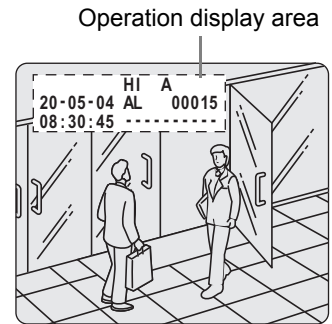

CAUTION

- **If the POWER indicator flashes**
The digital video recorder has a self-check function that detects problems. If there is a problem at power ON or during operation, the type of problem is indicated by how rapidly the POWER indicator flashes. Contact a Sanyo Authorized Service Center if the POWER indicator flashes.
4 flashes per second:
The hard disk is checked automatically at power ON. If a hard disk problem is found, the POWER indicator flashes, and the hard disk must be replaced or initialized. If you need to save images stored on the disk, contact a Sanyo Authorized Service Center.
1 flash per second:
Fan problem
- **If you disconnect the power cable**
Don't move the digital video recorder for 30 seconds after power OFF.
The disk in the hard disk drive briefly keeps spinning after power OFF due to inertia, during which time the head is unstable. At this time, the disk is sensitive to shocks or vibrations, so avoid even light shocks.

At power ON, the operation display area appears at the top left of the monitor screen. The operation display area shows the date/time, image quality, remaining time, and other information needed for operations.

Operation display area

Example: Normal screen

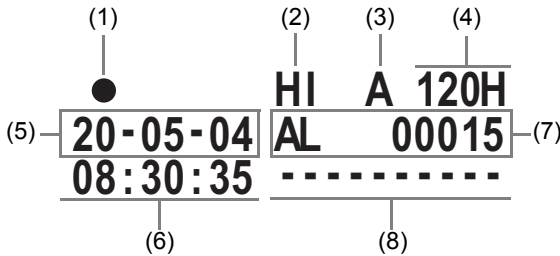

Playback screen

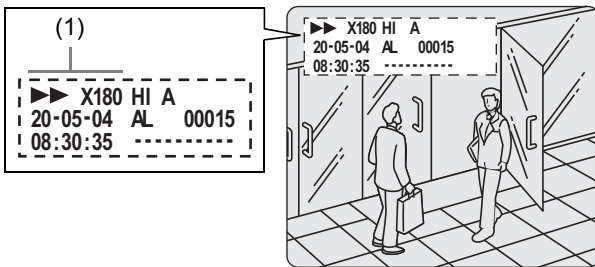

(1) Operating symbol display

Displays the operation (such as recording or playback) and playback speed.

- : Recording
- ▶▶ : Fast-forward playback
- ▶ : Playback
- ◀◀ : Rewind playback
- || : Still
- ||| : Slow playback
- ◀||| : Reverse slow playback

The playback speed is displayed during fast-forward or fast-rewind playback at 7.5 times the normal playback speed or faster, and during slow or reverse slow playback.

NOTE

- During simultaneous recording and playback, the display indicates playback (▶).

(2) Image quality display (→P.29)

Displays the quality of the image that can be recorded. Set to "HIGH" in the initial settings.

(3) Audio recording

Displays "A" when audio recording has been set.

(4) Remaining time display

Unless "OVER WRITE" is set for recording, displays the remaining amount of recording time, as shown below.

Remaining time	Displayed increment	Example
1 hour or more	1 hour increments	1H
Less than 1 hour	10 minute increments	10M
Less than 10 minutes	1 minute increments	1M

(5) Date display (→P.13)

Shows the day/month/year.

20-05-04 (day-month-year)

(6) Time display (→P.13)

"00:00:00" is displayed when you turn the power ON for the first time. The digital video recorder uses the date and time to manage recording and playback points.

(7) Alarm display and alarm count display (→P.15)

When you set an alarm using the <REC MODE SET> menu item, the alarm display area appears as shown below.

● Alarm display

When alarm recording is set, "AL" appears.

During alarm recording, the "AL" display flashes.

● Alarm count display

Displays the total number of alarms that have been generated.

(8) Name set for the digital video recorder

Displays the name set for the digital video recorder when it is controlled by a network.

Changing the position of the operating display

Press the [EXIT/OSD] button repeatedly.

Pressing the [EXIT/OSD] button repeatedly lets you move or erase the operation display area.

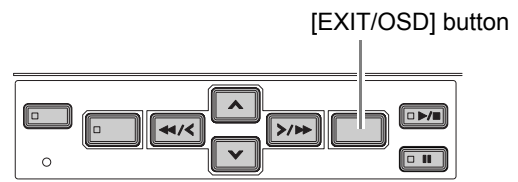

Normal screen

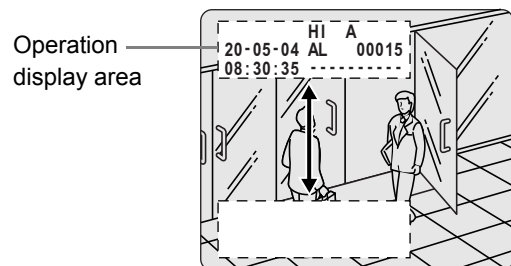

Playback screen

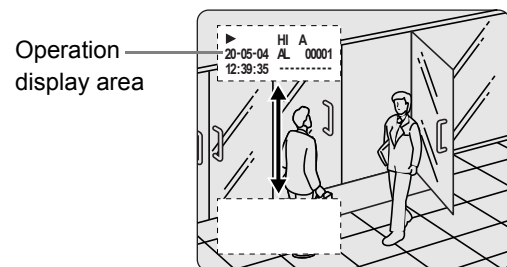

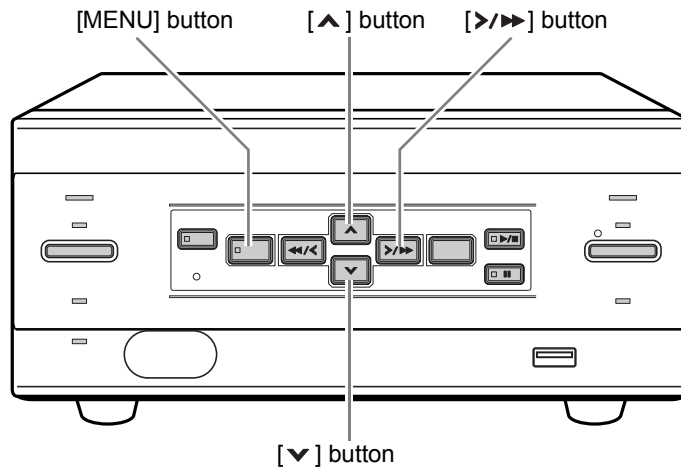

This section describes how to set the language displayed on the monitor and how to set the digital video recorder's internal clock.

[Settings] (◆ indicates initial setting.)

Item	Setting	Description
(1) LANGUAGE	◆ENGLISH	Sets the language to English.
	FRANCAIS	Sets the language to French.
	DEUTSCH	Sets the language to German.
	ESPAÑOL	Sets the language to Spanish.
(2) CLOCK SET		Sets the date and time.

1 Press the [MENU] button.

The MENU indicator lights, and the <MAIN MENU> screen appears.

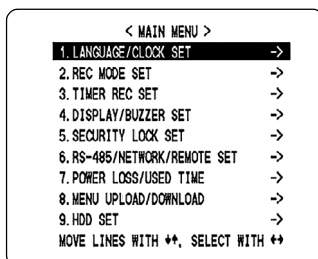

2 Select, "1. LANGUAGE/CLOCK SET", and press the [>/>>] button.

The <LANGUAGE/LANGUE/SPRACHE/IDIOMA> screen appears. The cursor is positioned on "ENGLISH".



To change the language

3 Press the [>/>>] button, then the [v] or [^] button to select the desired language.

The set item flashes.

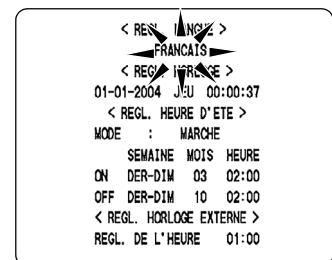

4 When you have made a selection, press the [>/>>] button.

The cursor moves to the date and time.

The language has now been set.

To return to the normal screen, press the [EXIT/OSD] button.

Setting the time

(Initial setting: 01-01-2004 THU 00:00:00)

Be sure to set the correct date and time. The digital video recorder stores the date and time of recordings for use in operations such as playback and search.

CAUTION

- Recording cannot commence if the clock hasn't been set.

Example: Setting 20 May, 2004, 8:30 AM

3 Press the [▼] or [▲] button to move the cursor to the date and time under <CLOCK SET>.

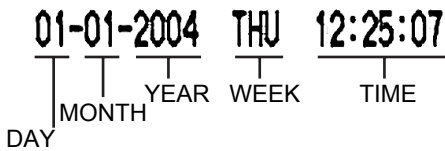
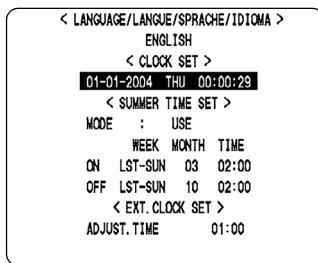

4 Press the [>/▶▶] button.

"01" (indicating the day) flashes.

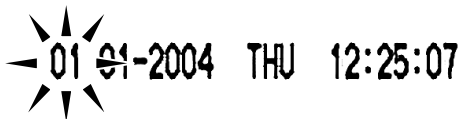

5 Press the [▼] or [▲] button to select "20".

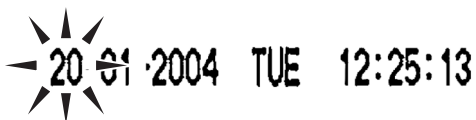

6 Press the [>/▶▶] button.

"01" (indicating the month) flashes.

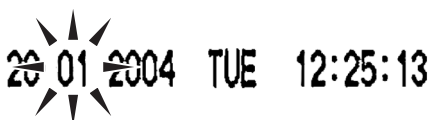

7 Use the same procedure to set the month (05), year (2004), hour (08) and minute (30).



When you have set the minute, the cursor moves to "MODE" under <SUMMER TIME SET>, and the clock starts from 00 seconds.

- The day of the week is set automatically.
- The time is stopped during clock setting.

8 Press the [EXIT/OSD] button.

The display returns to the normal screen.

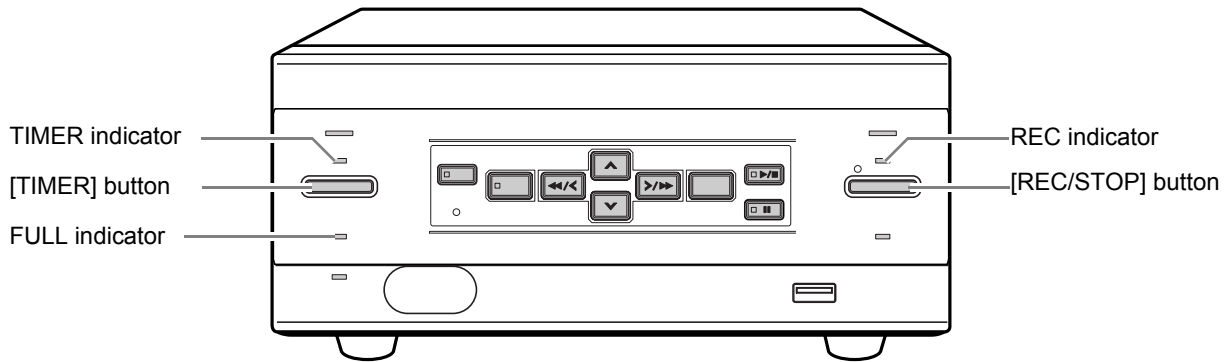

Normal recording

Follow the steps below to record the monitored image.

1 Set the TV SYSTEM selector switch on the rear panel to PAL.

Switch TV SYSTEM based on the camera and monitor to be connected.

2 Press the [REC/STOP] button.

The REC indicator lights, "●" (the recording symbol) appears on the screen, and recording starts.

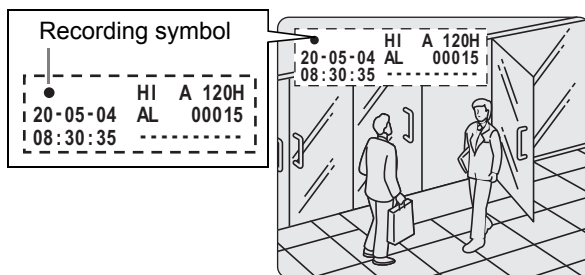

NOTE

- When you record for the first time, the initial settings are used. To change the image quality, see P.29.
- When the remaining space for recording reaches zero, recording ends and the FULL indicator lights. You can start recording from the beginning again by changing the "OVER WRITE" recording setting. (→P.29)
- You can record and play back images at the same time. See P.16 for the procedure.

Ending normal recording

3 Press the [REC/STOP] button for about 3 seconds.

The REC indicator goes out and recording stops.

Timer recording

Follow the steps to record the monitored image onto the hard disk at the set time.

1 Press the [TIMER] button.

The TIMER indicator lights, and the digital video recorder enters timer recording standby mode.

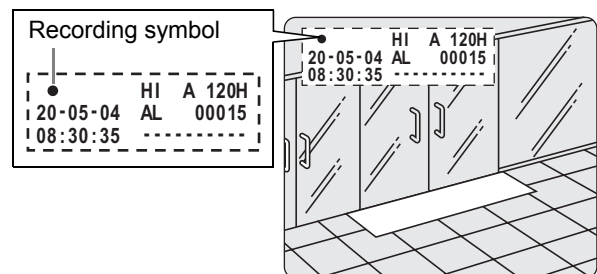

CAUTION

- A warning tone sounds if timer recording hasn't been set.
 - (1) See P.31 for how to set timer.
 - (2) When the time specified in the timer settings arrives, the REC indicator lights, "●" (the recording symbol) appears in the screen, and recording starts.
 - (3) When the set end time arrives, the REC indicator goes out, and recording stops.
 - (4) The following restrictions apply to normal recording and timer recording.
 - After making "PICTURE QUALITY" or "AUDIO RECORDING" menu settings and returning to the camera screen, recording does not start for a maximum of 6 seconds (although normal recording and timer recording operations can be made).
 - After recording finishes (the REC/STOP indicator turns off), recording does not start for a maximum of 10 seconds (although normal recording and timer recording operations can be made).

NOTE

- When the remaining memory space for recording reaches zero, recording ends, and the FULL indicator lights. You can start recording from the beginning again by changing the "OVER WRITE" setting. (→P.29)
- You can record and play back images at the same time. See P.16 for the procedure.

Stopping during timer recording

1 Press the [TIMER] button.

The TIMER indicator goes out and recording ends.

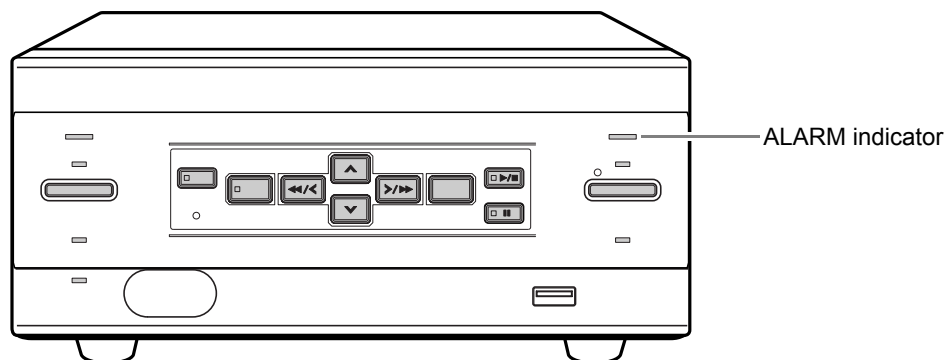

Alarm recording

Use the following procedure to have alarm video recorded when an alarm signal is received during recording or recording stop.

! CAUTION

- Check that the device required for alarm recording is connected to the ALARM terminal. (→P.8)

1 Set alarm recording.

The default settings are shown below. See P.29 for how to change these settings.

- **ALARM MODE: "OFF"**
Alarm recording is not performed.
- **ALARM DURATION: "20SEC"**
Recording is performed for approximately 20 seconds for each alarm signal received.

2 When alarm input is detected.

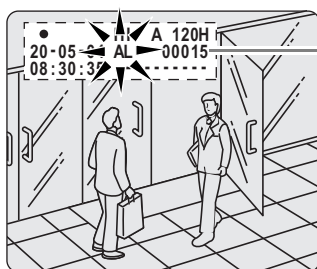

- When an alarm is received, "AL" flashes in the operation display area, the ALARM indicator flashes, and the alarm recording starts.
- The latest 49,999 incidents are stored in the alarm history. Older incidents are erased.

3 Ending alarm recording.

When the alarm duration time (default setting: 20 seconds) ends, "AL" disappears from the operation display, the ALARM indicator stops flashing, and recording ends.

NOTE

- When the hard disk's remaining space for recording reaches zero, the FULL indicator lights and recording ends. You can start recording from the beginning again by changing the recording setting. (→P.29)

! CAUTION

The following restrictions apply to alarm recording.

- (1) Just after recording starts (STOP→REC/STOP indicator lights).
- (2) After making "PICTURE QUALITY" or "AUDIO RECORDING" menu settings and returning to the camera screen.
For (1) and (2):
 - Alarm input is not recognized for a maximum of 4 seconds. Alarm input after the 4 seconds are recognized as usual.
 - Recording does not start for a maximum of 6 seconds regardless of alarm input.
- (3) Just after recording finishes (the REC/STOP indicator turns off).
 - Alarm input is not recognized for a maximum of 5 seconds. Alarm input after the 5 seconds are recognized as usual.
 - Recording does not start for a maximum of 10 seconds regardless of alarm input.

Follow the steps below to play back recorded images.

Playback

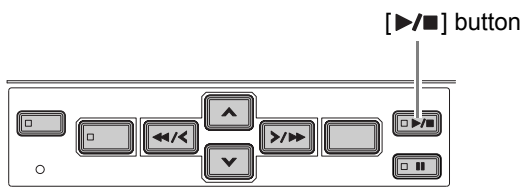

1 Press the [▶/■] button.

The PLAY/STOP indicator lights, and “▶” appears in the operation display area. The stored images are played back.

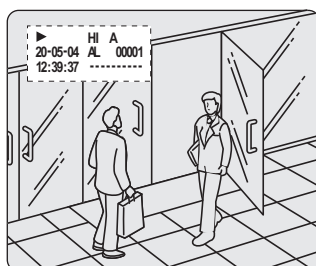

NOTE

- Image playback starts from the point at which recording started.
- If “OVER WRITE” has been set in “REC MODE SET”, playback starts with the oldest recorded image when the recording is played back for the first time.
- When playback of the recorded image ends, the digital video recorder pauses automatically.
- The still display (■) appears in the operation display area, and the STILL indicator lights.
- After playback is stopped, it will resume from the stopped point the next time it is started.

Ending playback

2 Press the [▶/■] button.

Playback ends.

■ Playing back an image near the point of recording

The digital video recorder prioritizes recording operations, so the playback image may freeze temporarily.

Playback while fast-forwarding/rewinding

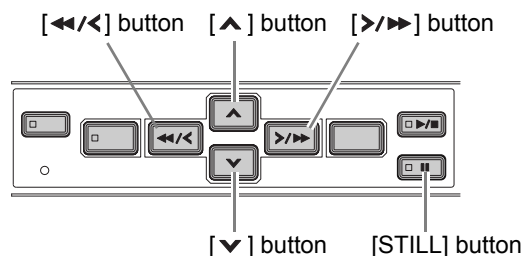

Press the [▶/▶] or [◀/◀] button during playback or while a still image is displayed.

When you press the [▶/▶] button, ▶ appears in the operation display, and the playback fast-forwards at 7.5 times the normal playback speed.

When you press the [◀/◀] button, ◀ appears in the operation display, and the playback fast-rewinds at 7.5 times the normal playback speed.

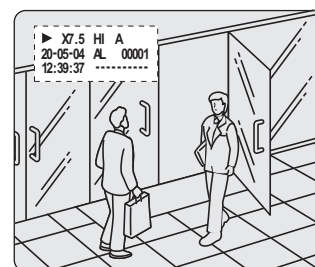

To change the fast-forward speed

Press the [▲] button while fast-forwarding.

Press the button once to increase the speed to 15 times the playback speed, twice to increase the speed to 30 times the playback speed, and 3 times to increase the speed to 180 times the playback speed.

To change the rewind speed

Press the [▼] button while rewinding.

Press the button once to increase the speed to 15 times the playback speed, twice to increase the speed to 30 times the playback speed, and 3 times to increase the speed to 180 times the playback speed.

Ending fast-forward/rewind

Press the [▶/■] button.

Normal playback starts.

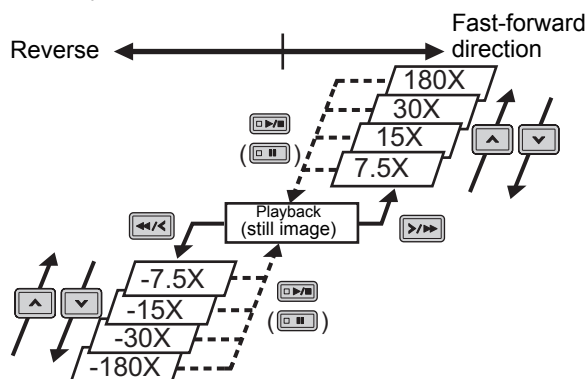

Viewing still images

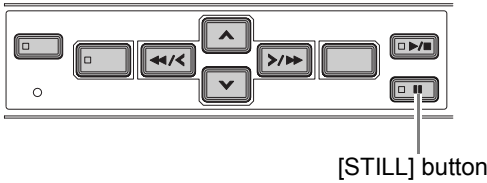

1 During playback, press the [STILL] button.

The image becomes a still image (freezes).
 II appears in the operation display area.

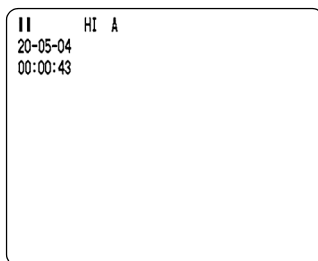

To resume playback

2 Press the [STILL] button.

Frame advance (reverse)

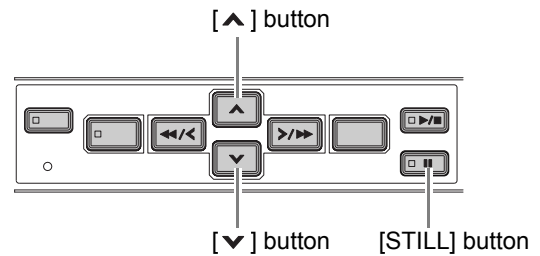

Press the [^] button while a still image is displayed.

The still image advances by one frame.

Press the [v] button while a still image is displayed.

The still image moves back three frames.

Slow playback

Press the [^] button for at least 2 seconds.

The playback speed slows to 1/8 the normal speed.

Pressing the [^] button again switches the playback speed to 1/4 the normal speed.

Pressing the button twice switches the playback speed to 1/2 the normal speed.

Slow reverse playback

Press the [v] button for at least 2 seconds.

The playback speed slows to 1/8 the normal speed.

Pressing the [v] button again switches the playback speed to 1/4 the normal speed.

Pressing the button twice switches the playback speed to 1/2 the normal speed.

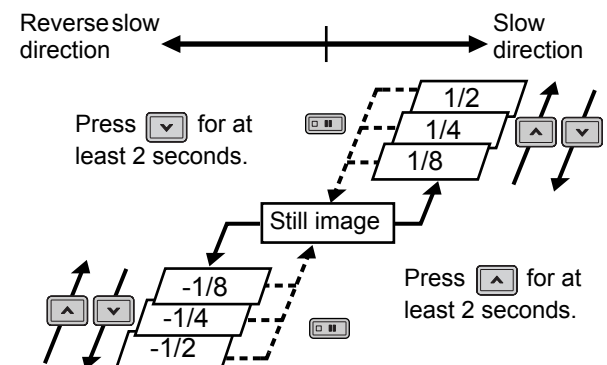

Recorded images can be searched. There are two search methods available.

Image to search

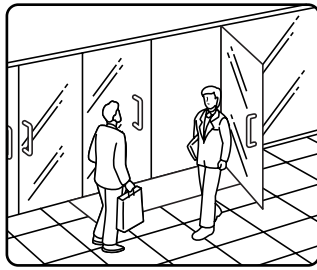

Search in <SEARCH> screen

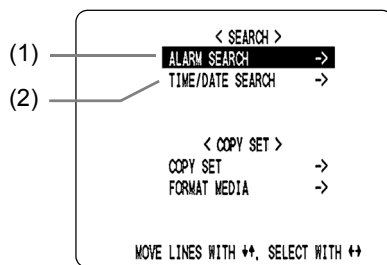

NOTE

- You can use the button operations to freeze, fast-forward or perform other operations on retrieved images being played back.

(1) ALARM SEARCH

Lets you search and play back recorded alarm images from the recording list.

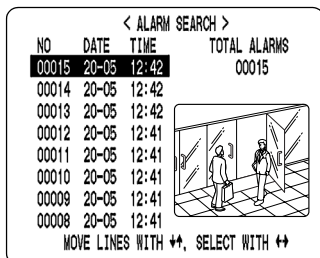

(2) TIME/DATE SEARCH (→P.19)

Lets you search and play back recorded images by date/time.

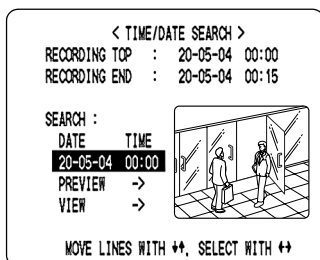

Alarm search

Lets you search and play back recorded alarm images.

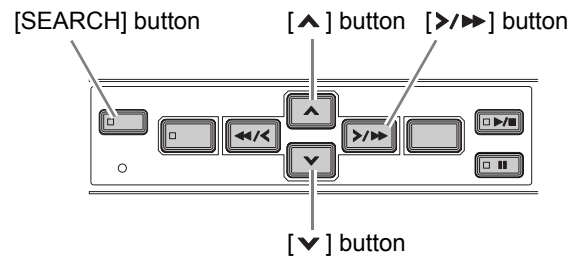

- Press the [SEARCH] button while the digital video recorder is recording or stopped.

The <SEARCH/COPY> screen appears.

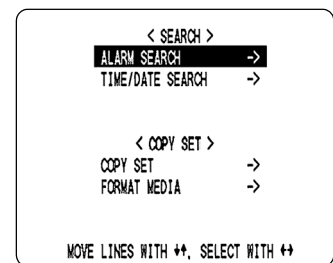

- Check that "ALARM SEARCH" is selected, and press the [>/>>] button.

The <ALARM SEARCH> screen appears.

The 8 latest alarm images are listed on the screen.

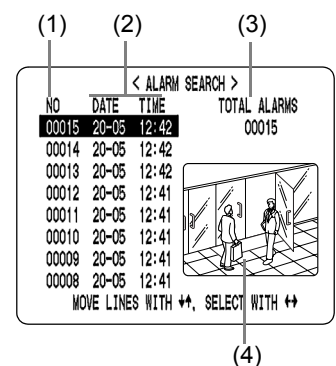

- NO:**
Displays the alarm number.
- DATE/TIME:**
Displays the date/time at which the alarm was received and the image recorded.
- TOTAL ALARMS:**
Displays the total number of recorded alarm images.
- Preview screen:**
Displays the selected alarm image.

3 Press the [▼] or [▲] button to select the image to play back.

The selected alarm image is displayed in the preview screen.

- **To display the next (previous) image**
Press the [▼] or [▲] button.
- **To display the items on the next page**
Press the [MENU] button. The next 8 items are displayed chronologically.
- **To end search mode**
Press the [EXIT/OSD] button.

4 Press the [▶/▶▶] button.

The selected image is played back on the entire screen.

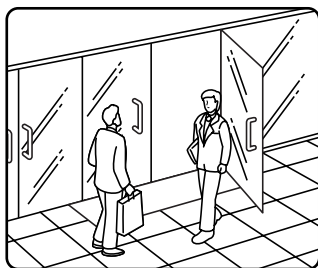

You can also search by specifying the desired alarm number.

1 Press the [SEARCH] button while the <ALARM SEARCH> screen is being displayed.

The alarm number input screen appears.
The cursor is positioned in the input field.

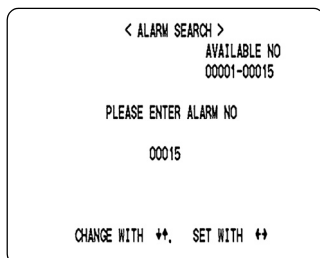

2 Enter the desired alarm number.

"AVAILABLE NO" indicates the numbers that can be searched. Enter the desired number from among the displayed numbers.

Press the [▲] and [▼] buttons to change the number.
Press the [▶/▶▶] button to move the cursor.

PLEASE ENTER ALARM NO



3 Press the [▶/▶▶] button.

Entered ALARM NO. appears and corresponding image appears in the preview screen.

Date/time search

Follow the steps below to search an image recorded by specifying its recorded date and time.

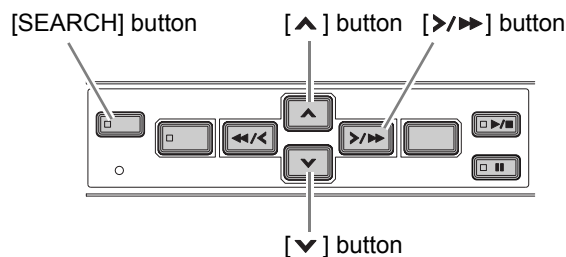

1 Press the [SEARCH] button while the digital video recorder is recording or stopped.

The <SEARCH/COPY> screen appears.

2 Press the [▼] or [▲] button to select "TIME/DATE SEARCH".

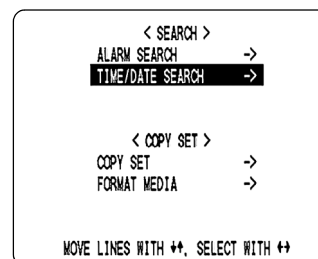

3 Press the [▶/▶▶] button.

The <TIME/DATE SEARCH> screen appears.

The cursor is positioned on the date and time item.

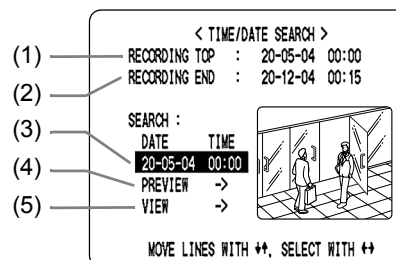

- (1) **RECORDING TOP:**
Displays the date/time of the image recorded first.
- (2) **RECORDING END:**
Displays the date/time of the image recorded last (latest image).
- (3) **SEARCH:**
Enter the date/time of the image to play back.
- (4) **PREVIEW:**
Select this item to display the preview screen.
- (5) **VIEW:**
Select this item to play back the image on the entire screen.

4 Press the [>/▶▶] button, and set the date/time to search.

Example: To search for the image from 26 October, 2004, 8:00 PM

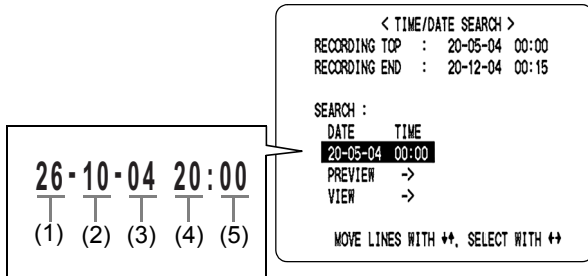

- (1) Press the [▼] or [▲] button to select “26” (the day).
- (2) Press the [>/▶▶] button, and then the [▼] or [▲] button to select “10” (the month).
- (3) Press the [>/▶▶] button, then the [▼] or [▲] button to select “04” (the year).
- (4) Press the [>/▶▶] button, and then the [▼] or [▲] button to select “20” (the hour).
- (5) Press the [>/▶▶] button to select “00” (the minute), then press the [>/▶▶] button.

The cursor moves to the preview.

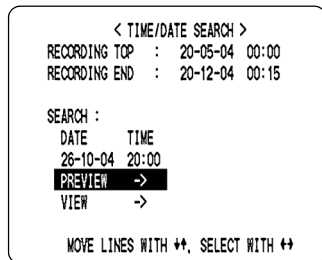

5 Press the [>/▶▶] button.

- **If no image exists for the specified time**
 The newest recording closest to the specified time is displayed.
- **To end search mode**
 Press the [EXIT/OSD] button.

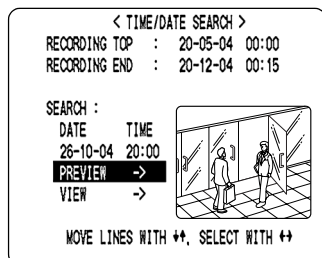

6 Press the [▼] button to select “VIEW”, then press the [>/▶▶] button.

The image in the preview screen is played back on the entire screen.



NOTE

- You can enter the desired date and time and select “VIEW” to display the retrieved image on the entire screen without showing it in the preview screen first.
- You can use the button operations to freeze, fast-forward or perform other operations on retrieved images being played back.

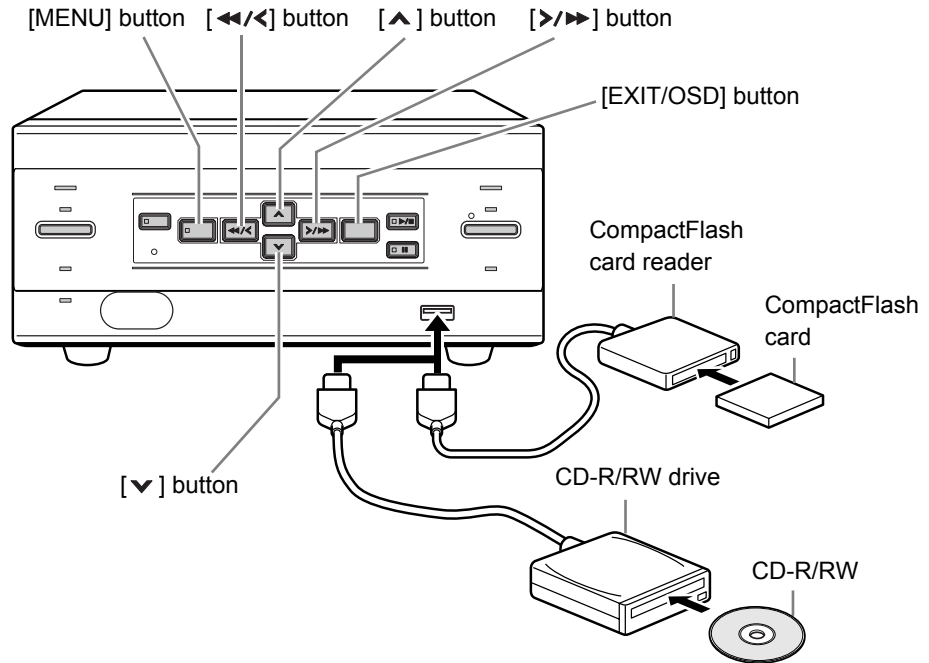

Use the following procedure to copy image recordings to a CompactFlash card, a CD-R/RW. CompactFlash cards and CD-RWs can also be formatted as described below.

! CAUTION

- Do not turn off the power while image is being copied.
- Data is written to CD-R/RWs using single-session recording. Once data has been written, therefore, it will not be possible to add additional data to a disc, even if free space is available.
- When a large amount of data is to be copied, it can be divided between a number of different cards or discs of the same type.
- Cards and discs cannot be formatted while copying. Prepare cards or discs with sufficient memory in advance.

NOTE

- The digital video recorder can automatically detect whether the copy destination is a CompactFlash card or a CD-R/RW disc.

Copying image

Connect either a CompactFlash card reader or a CD-R/RW drive to the USB port on the front of the digital video recorder. For information on CompactFlash card readers and CD-R/RW drives that can be connected, contact the dealer or Sanyo service centre.

1 Press the [SEARCH] button while the digital video recorder is recording, stopped, or a still image is displayed.

The <SEARCH/COPY> screen appears.

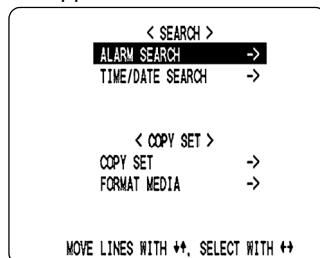

2 Press the [▲] and [▼] buttons to select "COPY SET" and press the [▶/▶] button.

The <COPY SET> screen appears.

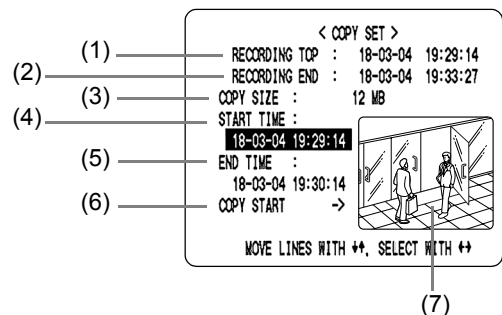

- (1) RECORDING TOP:**
Displays the date/time of the image recorded first.
- (2) RECORDING END:**
Displays the date/time of the image recorded last (i.e., the newest image).
- (3) COPY SIZE:**
Displays the amount of data between "START TIME" and "END TIME" in MB.
If this data is less than 1 MB in size, "-----" is displayed and "COPY START" will not be possible.
- (4) START TIME:**
Specifies the date/time for the start of copying.
- (5) END TIME:**
Specifies the date/time for the end of copying.
A date and time earlier than "START TIME" cannot be specified.
- (6) COPY START:**
Starts copying when selected.
- (7) Preview:**
Displays the image corresponding to the date/time set by "START TIME" or "END TIME".

NOTE

- The <COPY SET> screen also appears when the [SEARCH] button is pressed while playing still images (→P.17).

- Press the [▲] and [▼] buttons to specify “START TIME” and “END TIME”, and then press the [▶/▶▶] button.
- Press the [▲] and [▼] buttons to select “COPY START”, and then press the [▶/▶▶] button.

Copying of image starts.

Live image appears while copying.

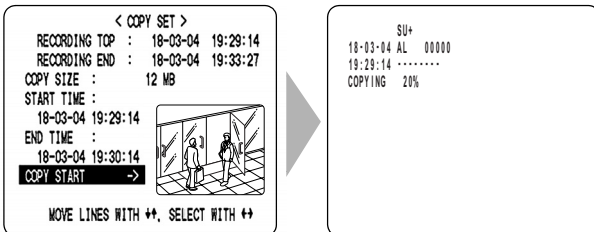

When copying has been completed, “COPY FINISHED” appears. It disappears when any button is pressed.

NOTE

- An image is copied to the CompactFlash card, CD-R/RW as follows.

Example: Copying from 10:15 on 25 April with a DVR NAME of “FRONT”

CompactFlash card, CD-R/RW

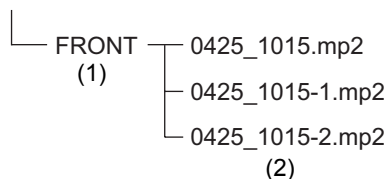

- A folder is created for the DVR NAME on the CompactFlash card, or CD-R/RW.
- A file is created inside that folder with its name reflecting the date and time.
 - A file named “***.idx” (index information file) is also created.
 - If “DVR NAME” has not been set, the name “DSR-M810” will be used when creating folders.
 - The character “+” will be used to replace any backslash (/), asterisk (*), period (.), or colon (:) characters appearing in “DVR NAME”.
 - When adding data to the same CompactFlash card, folders such as “Folder name-1” will be created.
 - The time stamp for files saved on a CD-R/RW is UTC (Universal time, coordinated).
 - For information on CompactFlash card readers and CD-R/RW drives that can be connected, contact the dealer or Sanyo service centre.

Formatting a CompactFlash card or CD-RW

- Press the [SEARCH] button while the digital video recorder is recording or stopped.

The <SEARCH/COPY> screen appears.

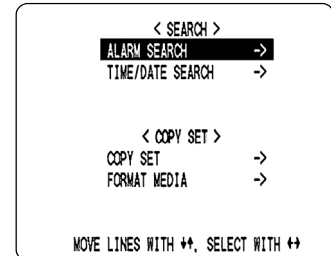

- Press the [▲] and [▼] buttons to select “FORMAT MEDIA” and press the [▶/▶▶] button.

The <WARNING> screen appears.

“NO” flashes.

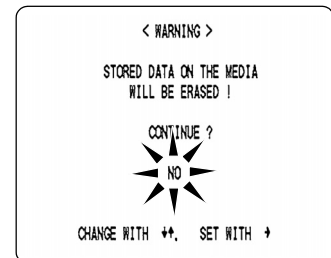

- Press the [▲] and [▼] buttons to select “YES” and press the [▶/▶▶] button.

Formatting of the media starts.

When formatting has been completed, “FORMAT FINISHED!” appears, and the screen will return to the display of live image when the [EXIT/OSD] button is pressed.

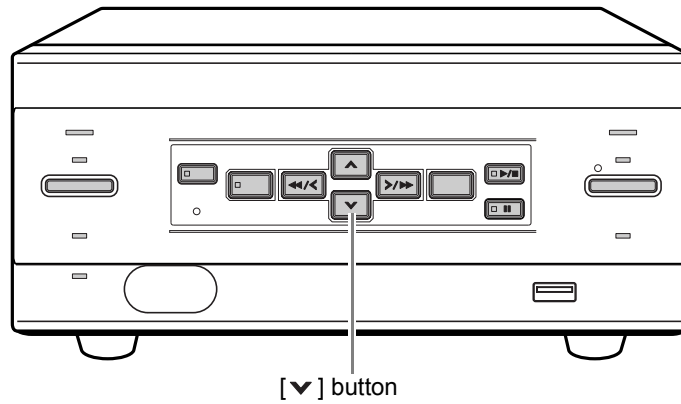

[v] button

Use the following procedure to set the key lock function so that operation as a result of accidental pressing of buttons can be prevented.

Setting the key lock function

- 1 Press the [v] button for about 3 seconds while the digital video recorder is recording or stopped.

When the key lock is set, a confirmation tone sounds, and the LOCK/REMOTE indicator lights.

NOTE

- The key lock is not released at power OFF.
- You cannot set the key lock during playback.

Releasing the key lock function

- 1 Press the [v] button for about 3 seconds while the key lock function is set.

When the key lock is released, a confirmation tone sounds, and the LOCK/REMOTE indicator goes out.

CAUTION

- When the key lock function has been set, the buttons can't be used for settings or operations.
- When the security lock is set, you cannot set the key lock alone.
- If you have already set the security lock, the password entry screen appears. (→P.38)

MENU CONFIGURATION AND OPERATIONS

This section describes the menu configuration, and which menu item to select for each operation.

Displaying the menu screen and sub-menu screens

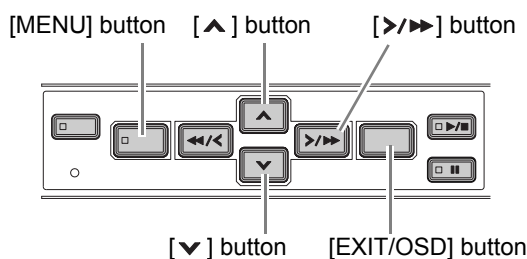

1 Press the [MENU] button.

The <MAIN MENU> screen appears.

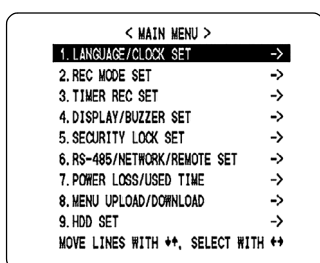

2 Press the [v] or [^] button to select the desired menu.

When you move the cursor, the selected item is displayed in reverse.

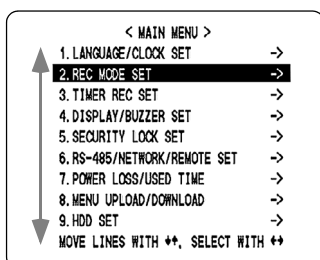

3 Press the [>/>>] button.

The selected sub-menu appears.
The cursor is positioned on the first setting item.

To exit a menu screen

4 Press the [EXIT/OSD] button.

The display returns to the normal screen.

! CAUTION

- While recording, you can display menu screens but cannot change menu settings.

Entering settings in sub-menu screens

In the sub-menu screen, use the [^][v][</<<][>/>>] buttons to enter the desired setting.

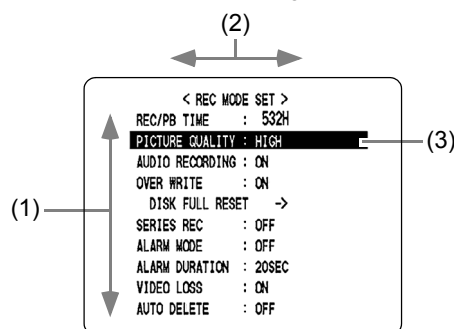

- To move the cursor up/down**
Press the [^] or [v] button.
- To move the cursor right or to a setting item**
Press the [</<<] or [>/>>] button.
- To change a setting value**
Press the [^] or [v] button.

To restore menu setting items to their initial values

Follow the steps below to restore just the currently displayed menu items to their initial values.

1 Display the desired sub-menu screen.

2 Press the [MENU RESET] button.

The displayed settings are restored to their initial values.

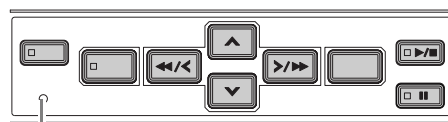

[MENU RESET] button

Overview of sub-menus

The screens below are the sub-menu screens displayed by selecting items from the MAIN MENU.

Pressing the [MENU] button while a sub-menu screen is displayed switches the display directly to the next sub-menu screen.

1. LANGUAGE/CLOCK SET (→P.26)

Enables the following settings:

- Screen display language
- Date and time settings
- Summer time settings
- Time synchronization with external devices

```

< LANGUAGE/LANGUE/SPRACHE/IDIOMA >
  ENGLISH
  < CLOCK SET >
    01-01-2004 THU 00:00:00
  < SUMMER TIME SET >
    MODE : USE
      WEEK MONTH TIME
    ON LST-SUN 03 02:00
    OFF LST-SUN 10 02:00
  < EXT. CLOCK SET >
    ADJUST. TIME 01:00
    
```

2. REC MODE SET (→P.29)

Lets you make settings for recording and alarms.

```

< REC MODE SET >
  REC/PB TIME : 532H
  PICTURE QUALITY : HIGH
  AUDIO RECORDING : ON
  OVER WRITE : ON
  DISK FULL RESET ->
  SERIES REC : OFF
  ALARM MODE : OFF
  ALARM DURATION : 20SEC
  VIDEO LOSS : ON
  AUTO DELETE : OFF
    
```

3. TIMER REC SET (→P.31)

Used for timer recording settings.

Furthermore, if month and day is set using "HOLIDAY SET", timer settings for Sunday will be adopted for both days.

```

< TIMER REC SET >
  WEEK START STOP SET
  SUN --:-- --:-- OFF
  MON --:-- --:-- OFF
  TUE --:-- --:-- OFF
  WED --:-- --:-- OFF
  THU --:-- --:-- OFF
  FRI --:-- --:-- OFF
  SAT --:-- --:-- OFF
  DLY --:-- --:-- OFF
  * HOLIDAY SET ->
    
```

4. DISPLAY/BUZZER SET (→P.34)

Lets you select the display item in the operation display area. Also lets you sound the buzzer on the following occasions:

- During alarms
- When there is no more available recording space
- When the operation button is pressed
- When there is a hard disk problem
- When there is a fan problem
- When there is a recording problem.
- When there is "VIDEO LOSS"

```

< DISPLAY SET >
  DATE/TIME : ON
  QUALITY/AUDIO : ON
  DVR NAME : OFF
  ALARM COUNT : ON
  < BUZZER SET >
  ALARM ON : ON
  DISK FULL : ON
  KEY IN : OFF
  WARNING : ON
  NON REC : OFF
    
```

5. SECURITY LOCK SET (→P.36)

Lets you set passwords to restrict the users.

```

< SECURITY LOCK SET >
  LEVEL PASSWORD(4-8) USE
  ADMIN ----- OFF
  USER ----- OFF
  REC CONTROL : ADMIN
    
```

6. RS-485/NETWORK/REMOTE SET (→P.39)

Used to make the settings needed when connecting the digital video recorder to an external device by RS-485 interface, or to a PC via a network.

```

< NETWORK SET >
  IP ADDRESS : 192.168. 0.250
  < ADVANCED SETTINGS ->
  < RS-485 SET >
  REMOTE AS : DVR
  DATA SPEED : 19200
  STATUS INFO : OFF
  ALARM INFO : OFF
  ADDRESS : 001
  < REMOTE SET >
  REC STOP : DISABLE
    
```

7. POWER LOSS/USED TIME (→P.42)

Lets you check the date/time of power losses and the amount of hard disk operation time.

```

< POWER LOSS/USED TIME >
  LOSS RECOVER
  #002 20-05 00:45 20-05 00:45
  03-01 02:09 03-01 02:43
  -----:--:-- -----:--:--
  -----:--:-- -----:--:--
  DISK1 USE : 00003 H
  DISK2 USE : ----- H
  POWER : 00003 H
  FIRMWARE : MAIN 1.05-00 / SUB 1.04-00
    
```

8. MENU UPLOAD/DOWNLOAD (→P.43)

Lets you save menu settings onto a CompactFlash card. Also lets you read menu settings saved on CompactFlash cards.

```

< MENU UPLOAD/DOWNLOAD >
  DVR TYPE VER. SAMG-01
  < SAVE MENUS TO CF ->
  LOAD MENUS FROM CF ->
  * COPY MIRRORING SETTINGS: NO
  FORMAT CF ->
  * IF YOU COPY MIRRORING SETTINGS,
  HARD DISK MAY BE INITIALIZED!
    
```

9. HDD SET (→P.46)

Used to initialize (reformat) the hard disk. Also lets you set mirroring when a second hard disk has been added.

```

< HDD SET >
  DISK1 : 300GB
  DISK2 : ---GB
  < DISK INITIALIZE ->
  CAUTION : ALL RECORDS WILL BE ERASED!
  MIRRORING : OFF
  MOVE LINES WITH ++, SELECT WITH +-
    
```

<MAIN MENU>

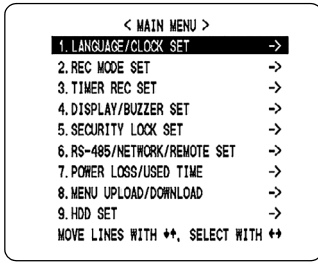

You can perform the following functions:
 Change the language used to display on-screen information.*
 Set the date and time.*
 Set the clock to adjust automatically for summer time.
 Set all the devices to the same time automatically when multiple devices are connected.
 * See P.12.

<SUMMER TIME SET> settings

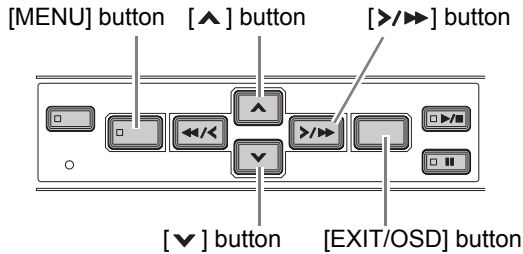

1 Press the [MENU] button.

The MENU indicator lights, and the <MAIN MENU> screen appears.

2 Select "1. LANGUAGE/CLOCK SET", and press the [>/>>] button.

The <LANGUAGE/LANGUE/SPRACHE/IDIOMA> screen appears with the cursor positioned on "ENGLISH".

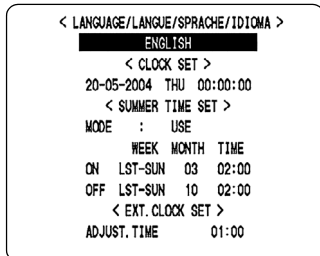

3 Press the [v] or [^] button to select "MODE" under <SUMMER TIME SET>.

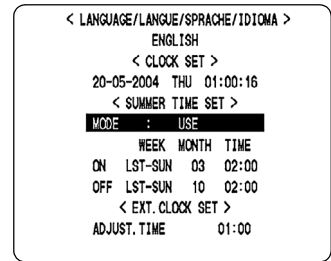

4 Press the [>/>>] button.

"USE" flashes.

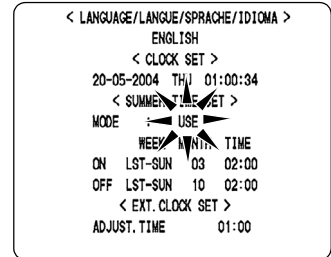

5 Press the [v] or [^] button to change the setting.

[Settings] (◆ indicates initial setting.)

Setting	Description
◆USE	Time is automatically adjusted to summer time.
NO USE	Time is not adjusted to summer time.

6 Press the [>/>>] button.

The cursor moves to the date/time at which to switch from standard time to summer time.

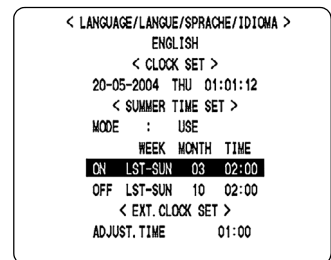

When "USE" is selected for "MODE" under <SUMMER TIME SET>.

You can set the date/time at which the time is switched from standard time to daylight savings time, and the date/time at which the time is switched back again.

The example below is the default value.

Example:

After the clock display reaches 28 March, 2004, 01:59, the next clock display is 03:00, putting the clock an hour ahead (daylight savings time).

After the clock display reaches 31 October, 2004, 01:59, the next clock display is 01:00, putting the clock an hour behind (back to standard time).

	(1)		(2)		(3)
	WEEK	MONTH	TIME		
ON	LST-SUN	03	02:00		
OFF	LST-SUN	10	02:00		
	(4)		(5)		(6)

- (1) Sets the week and the day of the week for switching to summer time.
- (2) Sets the month.
- (3) Sets the time.
- (4) Sets the week and the day of the week for ending summer time.
- (5) Sets the month.
- (6) Sets the time.

7 Press the [>/▶▶] button.

The cursor moves to "LST".

8 Press the [▼] and [▲] buttons to select the desired week, then press the [>/▶▶] button.

The cursor moves to "WEEK".

Set the desired week in the same manner.

9 Press the [>/▶▶] button.

The cursor moves to "MONTH".

10 Press the [▼] and [▲] buttons to select the desired month, then press the [>/▶▶] button.

The cursor moves to "TIME".

11 Press the [▼] and [▲] buttons to select the desired time, then press the [>/▶▶] button.

The cursor moves to the minutes portion of the time. Set the desired minutes in the same manner.

12 Press the [EXIT/OSD] button.

The display returns to the normal screen.

<EXT.CLOCK SET> settings

This section describes how to have the time synchronized automatically when two or more digital video recorders are connected. If you set the "ADJUST. TIME", all the connected devices are synchronized to the same time (to the nearest second) every day.

(Default setting: 01:00)

1 Use a cable to connect the CLOCK ADJ terminal on the rear panel of one digital video recorder to the CLOCK ADJ terminal on the second digital video recorder.

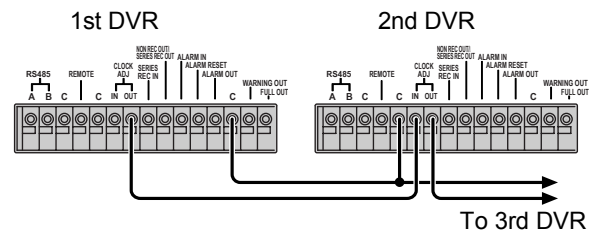

2 Press the [▼] or [▲] button to move the cursor to "ADJUST. TIME".

```

< LANGUAGE/LANGUE/SPRACHE/IDIOMA >
ENGLISH
< CLOCK SET >
20-05-2004 THU 01:01:27
< SUMMER TIME SET >
MODE : USE
WEEK MONTH TIME
ON LST-SUN 03 02:00
OFF LST-SUN 10 02:00
< EXT. CLOCK SET >
ADJUST. TIME 01:00

```

3 Press the [>/▶▶] button.

"01" flashes.

- 4** Press the [▼] or [▲] button to select the desired time, then press the [➤/▶▶] button.



NOTE

- Only an hour value can be set using “ADJUST. TIME”, and minutes and seconds cannot be set.

- 5** Press the [EXIT/OSD] button.

The display returns to the normal screen.

- 6** Use the same procedure to set the time on the second digital video recorder.

When you have finished making the settings, the display returns to the normal screen.

- When the digital video recorder is connected to a PC or other external device through a network, you can also set the time from that device. When connected to a PC, see the instructions for the VA-SW81LITE/VA-SW814 application software.

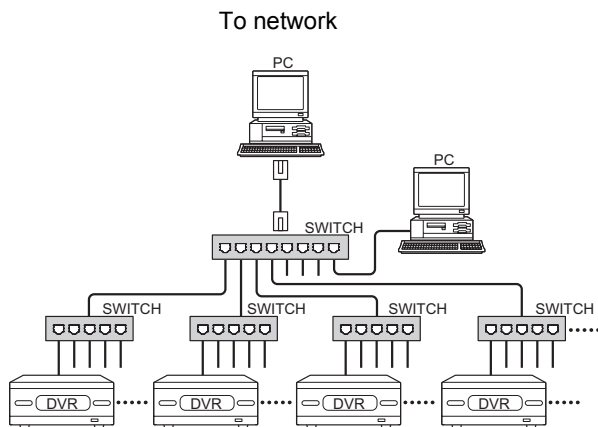

! CAUTION

- Subsequent digital video recorders must be synchronized with the first unit for “ADJUST. TIME”.
- Do not use a loop connection.

<REC MODE SET> setting items

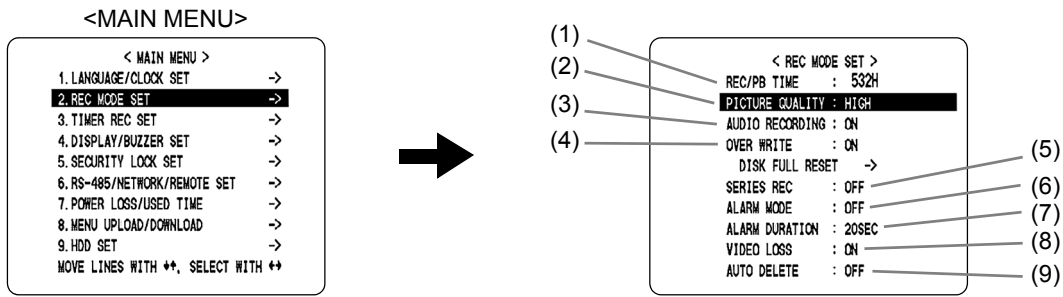

[Settings] (◆ indicates initial setting.)

	Item	Setting	Description
(1)	REC/PB TIME	-	Displays the possible recording time.
(2)	PICTURE QUALITY	SUPER+	Super highest image quality. Recording time: approx. 140 hours (300GB), approx. 56 hours (120GB).
		SUPER	Highest image quality. Recording time: approx. 210 hours (300GB), approx. 84 hours (120GB).
		◆ HIGH	High image quality. Recording time: approx. 420 hours (300GB), approx. 168 hours (120GB).
		STANDARD	Standard image quality. Recording time: approx. 840 hours (300GB), approx. 336 hours (120GB).
(3)	AUDIO RECORDING	◆ ON	Audio recording is performed.
		OFF	Audio recording is not performed.
(4)	OVER WRITE	◆ ON	When the hard disk runs out of space, recording automatically starts again from the beginning, recording over previously recorded images.
		OFF	When the hard disk runs out of space, FULL indicator flashes and recording stops. To begin recording again, set "DISK FULL RESET" to "YES". (→P.30)
(5)	SERIES REC	◆ OFF	Series recording is not performed.
		-1M	When multiple digital video recorders are connected, about 1 minute before the first recorder's hard disk becomes full, the second recorder's hard disk starts recording.
		-2M	When multiple digital video recorders are connected, about 2 minutes before the first recorder's hard disk becomes full, the second recorder's hard disk starts recording.
		-3M	When multiple digital video recorders are connected, about 3 minutes before the first recorder's hard disk becomes full, the second recorder's hard disk starts recording.
(6)	ALARM MODE	◆ OFF	Alarm recording is not performed.
		ENABLED	Alarm recording is always performed, during timer recording or other recording.
		AL-REC ON TIMER	Alarm recording is only performed during timer recording.
		AL-REC OFF TIMER	Alarm recording is performed only during recording types other than timer recording.
	OLY AL-RC ON TMR	Alarm recording is performed only during timer recording. Normal recording is not performed.	
(7)	ALARM DURATION	Time selections: CC/5SEC/10SEC/20SEC(◆)/40SEC/1MIN/2MIN/3MIN/4MIN/5MIN/10MIN/15MIN Sets the amount of time for recording when a single alarm is received.	
(8)	VIDEO LOSS	◆ ON	"VIDEO LOSS" is displayed on the screen when the camera image is interrupted. The WARNING signal is also output to a rear panel terminal.
		OFF	"VIDEO LOSS" is not displayed on the screen when the camera image is interrupted.
(9)	AUTO DELETE	Duration selections: OFF (◆), 1 DAYS to 99 DAYS Sets a storage period for recorded data. When the set period has expired, the corresponding data will be automatically deleted.	

- When item (4) "OVER WRITE" is set to "OFF" and the hard disk becomes full, the digital video recorder performs the operation set by item "DISK FULL RESET". For how to start recording again, see "Starting recording again when the FULL indicator lights" on P. 30.
- (5) "SERIES REC" can be set when "OVER WRITE" is "OFF".

Settings

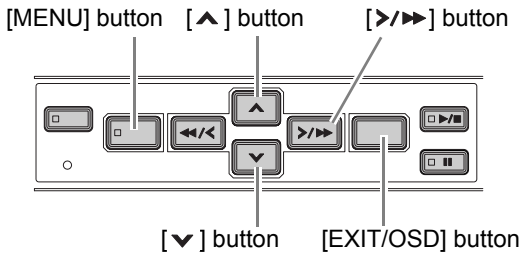

1 Press the [MENU] button.

The MENU indicator lights, and the <MAIN MENU> screen appears.

2 Select "2. REC MODE SET", and press the [>/>>] button.

The <REC MODE SET> screen appears.

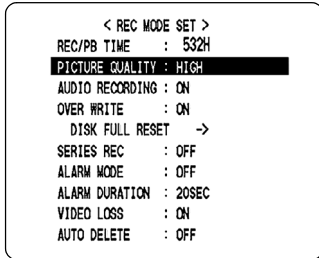

3 Press the [v] and [^] buttons to select the desired item, then press the [>/>>] button.

4 Press the [v] and [^] buttons to change the setting, then press the [>/>>] button.

5 Use the same procedure to set the other items as needed.

6 Press the [EXIT/OSD] button.

The display returns to the normal screen.

Connecting several digital video recorders to make series recordings

Use a cable to connect the control terminals as shown in the following.

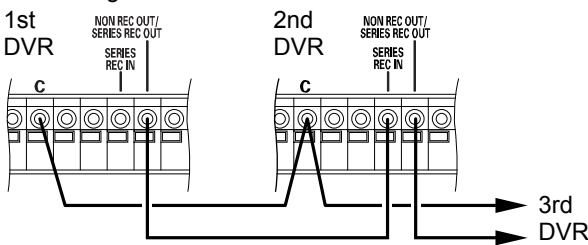

Starting recording again when the FULL indicator lights

When "OVER WRITE" is set to "OFF" and the hard disk becomes full, the FULL indicator lights and recording stops. To start recording again, first follow the steps below to erase the images recorded so far.

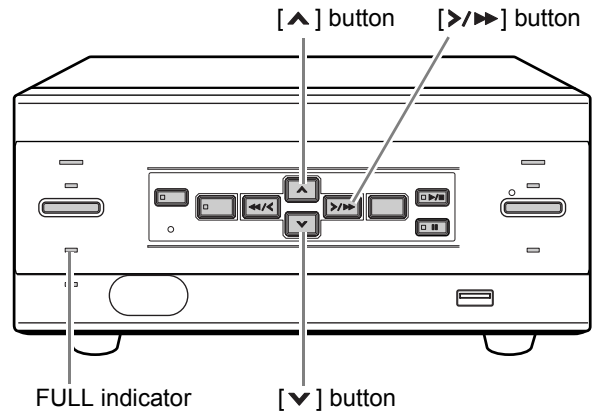

1 Display the <REC MODE SET> screen.

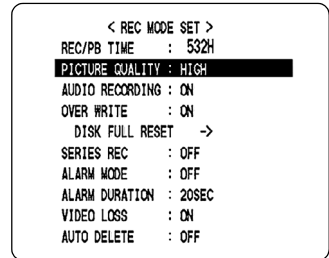

2 Press the [v] or [^] button to select "DISK FULL RESET", then press the [>/>>] button.

The <DISK FULL RESET> screen appears with "NO" flashing.

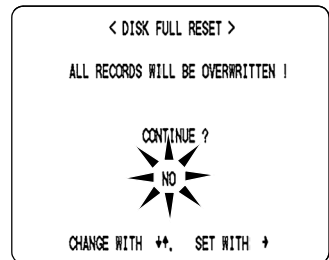

3 Press the [v] or [^] button to select "YES", then press the [>/>>] button.

The images recorded so far are erased, and the display returns to the normal screen. The FULL indicator goes out, and you can record until the disk becomes full.

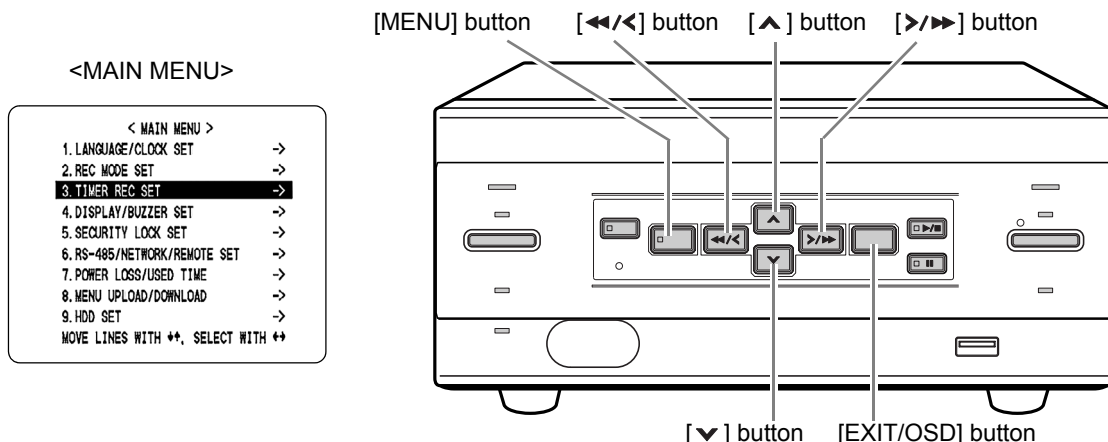

You can set recording start/stop times using the "TIMER REC SET".

Timer setting items

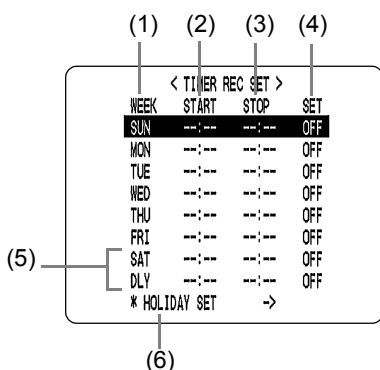

You can set times at which to start and stop cursor on each specified day of the week.

(1) WEEK

Used to select the days of the week for timer recording. When each day in the "WEEK" column is flashing, it can be set to other days. The 7th line (initially "SAT") and 8th line (initially "DLY") are used for timer recording settings of over 24 hours.

(2) START

Enter the time at which to start timer recording.

(3) STOP

Enter the time at which to stop timer recording.

(4) SET

Setting "ON" enables the entered timer recording setting.
Setting "OFF" disables the entered timer recording setting.

(5) Used for timer recording settings of over 24 hours

Use these lines for timer recording of over 24 hours.

(6) HOLIDAY SET (→P.33)

Timer reservations every day at the same time with the same image quality

Example:

Timer recording every day from 8:30 AM to 6:30 PM with the same recording rate.

1 Press the [MENU] button.

The MENU indicator lights, and the <MAIN MENU> screen appears.

2 Select "3. TIMER REC SET", and press the [▶/▶] button.

The <TIMER REC SET> screen appears.

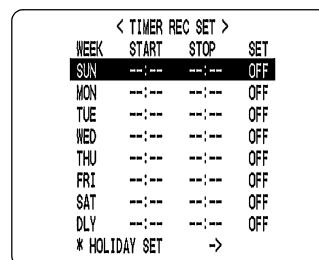

3 Press the [▶/▶] button once.

"SUN" under "WEEK" flashes.

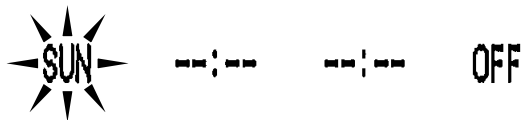

4 Press the [▼] or [▲] button to change "SUN" to "DLY".

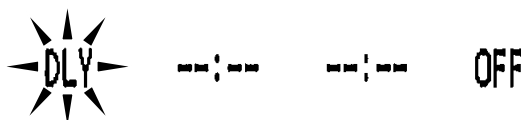

5 Press the [>/>>] button to move the cursor to the next item.

Each time you press the [>/>>] button, the cursor moves to the following items:

“WEEK” → “START” (hours, minutes) → “STOP” (hours, minutes) → “SET”.

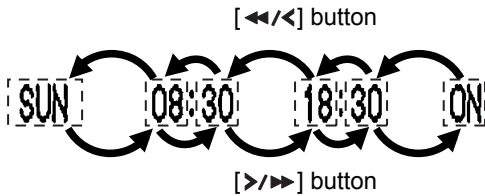

■ To change a displayed setting item

Press the [</<] or [>/>>] button to move the cursor to the item you want to change, then press the [v] or [^] button to change the setting.

■ Timer recording image quality

The image quality used for recording is set by “PICTURE QUALITY” in the <REC MODE SET>. (→P.29)

6 Press the [EXIT/OSD] button.

The display returns to the normal screen.

■ To set different recording times on each day of the week

Set the desired recording times for each day.

■ If timer reservation days overlap

The timer reservation that starts first will have priority.

To cancel all timer reservations

1 Press the [MENU RESET] button while the <TIMER REC SET> screen is displayed.

All the timer settings are erased.

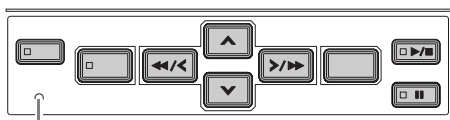

[MENU RESET] button

Timer reservations spanning more than 24 hours

This section describes how to use timer reservations to record for more than 24 hours. These settings are made using lines 7 (initially “SAT”) and 8 (initially “DLY”) of the <TIMER REC SET> screen.

Example:

Timer recording from 10:30 AM Monday to 8:30 PM Wednesday

1 Press the [v] or [^] button to move the cursor to the 7th line, then press the [>/>>] button.

“SAT” in the “WEEK” column flashes.

You can change the setting of the flashing item.

< TIMER REC SET >			
WEEK	START	STOP	SET
SUN	--:--	--:--	OFF
MON	--:--	--:--	OFF
TUE	--:--	--:--	OFF
WED	--:--	--:--	OFF
THU	--:--	--:--	OFF
FRI	--:--	--:--	OFF
SAT	--:--	--:--	OFF
DLY	--:--	--:--	OFF
* HOLIDAY SET			->

7th line

2 Set the items in the “WEEK” and “START” columns.

(1) Press the [v] or [^] button to change “SAT” to “MON”, then press the [>/>>] button.

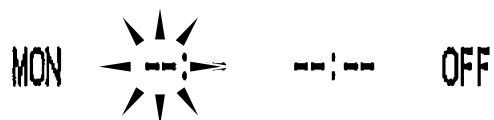

(2) Press the [v] or [^] button to change “--” to “10”, then press the [>/>>] button.

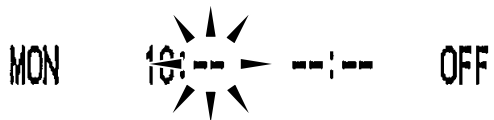

(3) Press the [v] or [^] button to change “--” to “30”, then press the [>/>>] button.

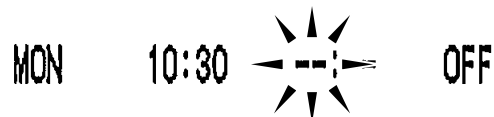

3 Press the [▼] or [▲] button to change the “STOP” time from “--:--” to “**:**”, then press the [▶/▶▶] button.

The “DLY” item on the 8th line automatically changes to “TUE” (the day after the day set on the 7th line), and flashes. Items that are not able to be set are displayed as asterisks (*).

MON	10:30	**:**	***
TUE	**:**	--:--	OFF

4 Set the time at which to stop recording, by setting the day in the “WEEK” column, entering the “STOP” time and changing “SET”.

MON	10:30	**:**	***
TUE	**:**	20:30	ON
(1)		(2) (3)	(4)

- (1) Press the [▼] or [▲] button to change “TUE” to “WED”, then press the [▶/▶▶] button.
- (2) Press the [▼] or [▲] button to change “--” to “20”, then press the [▶/▶▶] button.
- (3) Press the [▼] or [▲] button to change “--” to “30”, then press the [▶/▶▶] button.
- (4) Press the [▼] or [▲] button to change “OFF” to “ON”.

5 Press the [EXIT/OSD] button.

The display returns to the normal screen.

Setting holidays

You can set specific dates as holidays, to have the timer recording operation for Sunday used on those days. Dates such as national holidays and company off days should be set as holidays when you want those dates to have the same security as Sundays.

[Setting conditions]

Be sure to set holidays after first making timer settings for Sunday. (→P.31)

Example: To set 17 November as a holiday

NOTE

- You can set up to 20 days as holidays.

1 Press the [▼] or [▲] button to select “HOLIDAY SET”, then press the [▶/▶▶] button.

The <HOLIDAY SET> screen appears, with the cursor positioned on “1”.

< TIMER REC SET >			
WEEK	START	STOP	SET
SUN	--:--	--:--	OFF
MON	--:--	--:--	OFF
TUE	--:--	--:--	OFF
WED	--:--	--:--	OFF
THU	--:--	--:--	OFF
FRI	--:--	--:--	OFF
SAT	--:--	--:--	OFF
DLY	--:--	--:--	OFF
* HOLIDAY SET			->

< HOLIDAY SET >	
1. 01-01	11. -----
2. -----	12. -----
3. -----	13. -----
4. -----	14. -----
5. -----	15. -----
6. -----	16. -----
7. -----	17. -----
8. -----	18. -----
9. -----	19. -----
10. -----	20. -----

2 Set the month and day in item No. 1.

- (1) Press the [▶/▶▶] button to make “--” (the day) flash.
- (2) Press the [▼] or [▲] button to set “--” to “17”.
- (3) Press the [▶/▶▶] button to make “--” (the month) flash.
- (4) Press the [▼] or [▲] button to set “--” to “11”.

1. 17-11	
	(the month)
	(the day)
	(No.)

3 After entering the setting, press the [▶/▶▶] button.

The cursor moves to “2”.

4 Use the same procedure to set other holidays as needed.

5 Press the [EXIT/OSD] button.

The display returns to the normal screen.

<MAIN MENU>

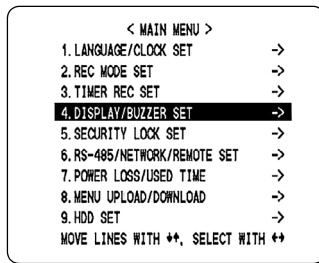

You can set the display item on the operation display area. This sub-menu also lets you set a warning buzzer to sound for alarms or when the hard disk space reaches zero. You can set items as needed.

<DISPLAY/BUZZER SET> setting items

<SUB MENU>

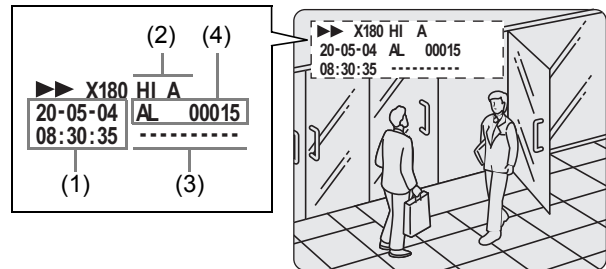
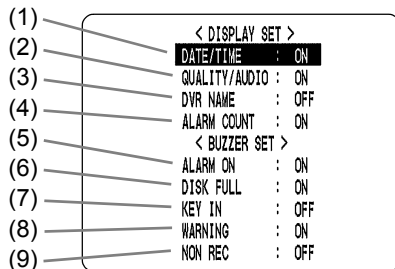

[Settings] (◆ indicates initial setting.)

	Item	Setting	Description
(1)	DATE/TIME	◆ ON	Display date/time in operation display area.
		OFF	Don't display date/time in operation display area.
(2)	QUALITY/AUDIO	◆ ON	Display picture quality and "A" (audio recording) in operation display area.
		OFF	Don't display picture quality or "A" (audio recording) in operation display area.
(3)	DVR NAME	ON	Display name set for digital video recorder.
		◆ OFF	Don't display name set for digital video recorder.
(4)	ALARM COUNT	◆ ON	Display current alarm count in operation display area.
		OFF	Don't display current alarm count in operation display area.
(5)	ALARM ON	◆ ON	Sound buzzer when alarm is received.
		OFF	Don't sound buzzer when alarm is received.
(6)	DISK FULL	◆ ON	When "OVER WRITE" is not set, sound buzzer when remaining hard disk space reaches zero.
		OFF	When "OVER WRITE" is not set, don't sound buzzer when remaining hard disk space reaches zero.
(7)	KEY IN	ON	Sound buzzer when operation button is pressed.
		◆ OFF	Don't sound buzzer when operation button is pressed.
(8)	WARNING	◆ ON	The buzzer sounds in the following cases: ●Hard disk drive error ●Fan error ●Recording error ●No input signal when VIDEO LOSS is ON
		OFF	Don't sound buzzer in the following cases: ●Hard disk drive error ●Fan error ●Recording error ●No input signal when VIDEO LOSS is ON
(9)	NON REC	ON	Sound buzzer when recording stops, or when recording is intentionally stopped.
		◆ OFF	Don't sound buzzer when recording stops.

Settings

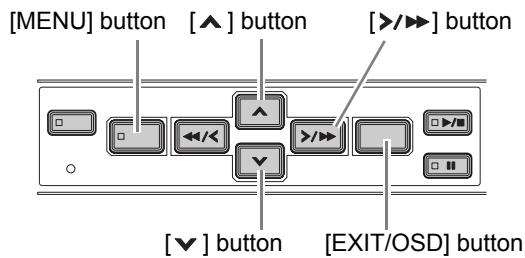

1 Press the [MENU] button.

The MENU indicator lights, and the <MAIN MENU> screen appears.

2 Select “4. DISPLAY/BUZZER SET”, and press the [>/>>] button.

The <DISPLAY/BUZZER SET> screen appears.

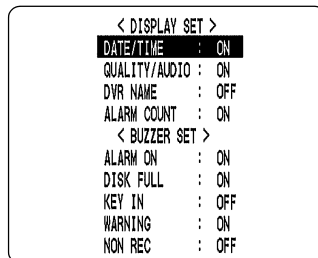

3 Press the [v] and [^] buttons to select the desired item, then press the [>/>>] button.

4 Press the [v] and [^] buttons to change the setting, then press the [>/>>] button.

5 Use the same procedure to set the other items as needed.

6 Press the [EXIT/OSD] button.

The display returns to the normal screen.

<MAIN MENU>

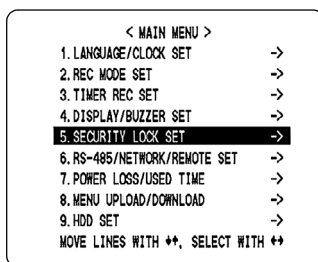

You can set passwords that restrict the users. When the security lock is set, a buzzer sounds when a user presses any of the digital video recorder's operation buttons. Be sure to make a note of the set passwords.

Password setting example

Two password types can be set, one for administrators and one for users. The table below gives example password setting combinations, and lists how the digital video recorder operates for each.

Setting example	Password	Operation
LEVEL PASSWORD (4-8) USE ADMIN 123456AB ON USER AB123456 ON REC CONTROL : ADMIN	No password is entered.	All operations are locked.
	User enters password.	Only playback operations can be performed.
	Administrator enters password.	All operations can be performed.
ADMIN 123456AB ON USER AB123456 ON REC CONTROL : USER	No password is entered.	All operations are locked.
	User enters password.	Only playback and recording operations can be performed.
	Administrator enters password.	All operations can be performed.
ADMIN 123456AB ON USER ----- OFF REC CONTROL : ADMIN	No password is entered.	Only playback operations can be performed.
	Administrator enters password.	All operations can be performed.
ADMIN 123456AB ON USER ----- OFF REC CONTROL : USER	No password is entered.	Only playback and recording operations can be performed.
	Administrator enters password.	All operations can be performed.
ADMIN ----- OFF USER ----- OFF REC CONTROL : ADMIN	No setting (Default value)	All operations can be performed.
ADMIN ----- OFF USER ----- OFF REC CONTROL : USER	No setting (Default value)	All operations can be performed.

Password setting

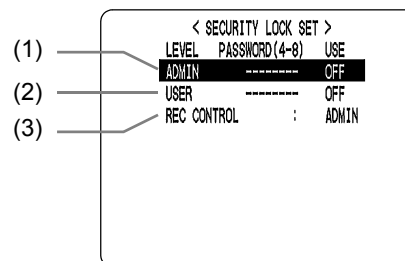

[Settings] (◆ indicates default setting.)

Item	Setting	Description
(1) ADMIN	ON	Used to set password for administrators. Also enables password setting.
	◆ OFF	Disables password setting.
(2) USER	ON	Used to set password for users. Also enables password setting.
	◆ OFF	Disables password setting.
(3) REC CONTROL	◆ ADMIN	Sets authorization for recording operation to "ADMIN" (administrators).
	USER	Sets authorization for recording operation to "USER" (users).

Setting passwords

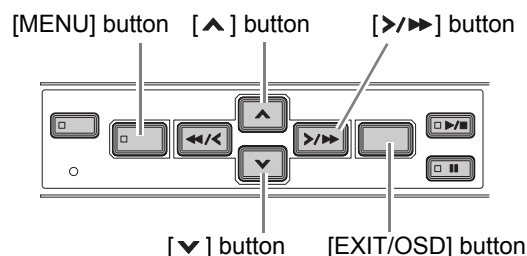

Passwords can be between 4 and 8 alphanumeric characters.

Characters that can be entered in passwords: 0 to 9, A to Z

Example: Setting "123456AB" as a password

1 Press the [MENU] button.

The MENU indicator lights, and the <MAIN MENU> screen appears.

2 Select "5. SECURITY LOCK SET", and press the [>/>>] button.

The <SECURITY LOCK SET> screen appears. The cursor is positioned on "ADMIN".

! CAUTION

- "LEVEL PASSWORD (4-8) USE" at the top of the screen is the screen title. You can't move the cursor to this item.

3 Press the [>/>>] button.

The first password entry bar “-” flashes.

**4 Press the [▼] and [▲] buttons to select the character to enter.**

Example:
Selecting “1”

5 Press the [>/>>] button.

The second password entry bar flashes.

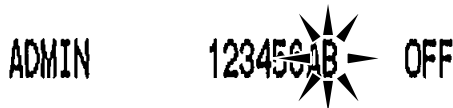
**6 Use the same procedure to enter the remaining digits (“23456AB” in this example).****NOTE**

- **To set a 4-digit password**
When you have entered four digits, and the fifth password entry bar is flashing, press the [>/>>] button.

7 When you have entered the password, press the [>/>>] button.

The cursor moves to “OFF” (flashing).

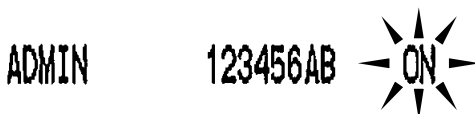
8 Press the [▼] and [▲] buttons to select “ON”.**CAUTION**

- If you select “OFF” for the “ADMIN” setting, you can’t set the “USER” password.

9 When you have finished making the setting, press the [>/>>] button.

The cursor moves to “USER”.

If you don’t want to set a user password, the password setting is now finished.

Press the [>/>>] button to move the cursor to “REC CONTROL”, to set the authorization for recording and playback operation. (→P.38)

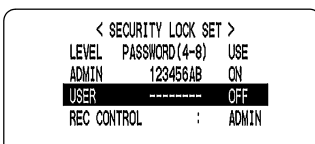
**Setting the user password**

Example: Setting “AB123456”

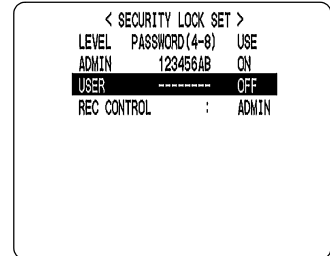
1 Press the [▼] and [▲] buttons to move the cursor to “USER”.**2 Press the [>/>>] button.**

The first password entry bar “-” flashes.

(Example: A)

Press the [▲] and [▼] buttons to select “A”.

**3 Press the [>/>>] button.**

The second password entry bar flashes.

Press the [▼] and [▲] buttons to select “B”.

Use the same procedure used to set the password to enter the remaining digits.

4 When you have finished making the setting, press the [>/>>] button.

The cursor moves to “OFF” (flashing).

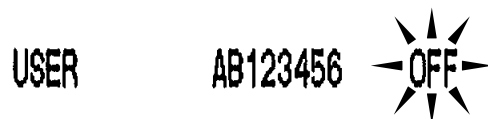
**5 Press the [▼] and [▲] buttons to select “ON”, then press the [>/>>] button.**

The cursor moves to “REC CONTROL”.

Setting the authorization for recording and playback operations

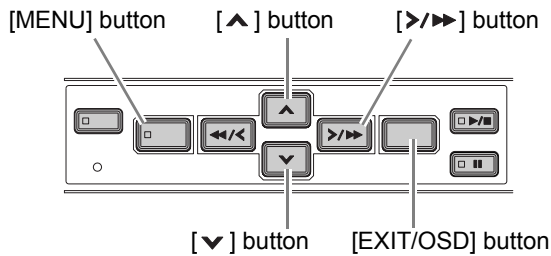

- 1 Press the [v] and [^] buttons to move the cursor to "REC CONTROL".

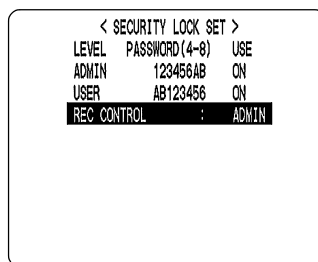

- 2 Press the [>/>>] button.
- 3 Press the [v] and [^] buttons to select "ADMIN" or "USER".

The setting is now finished.

- 4 Press the [EXIT/OSD] button.

The display returns to the normal screen.

Setting the security lock

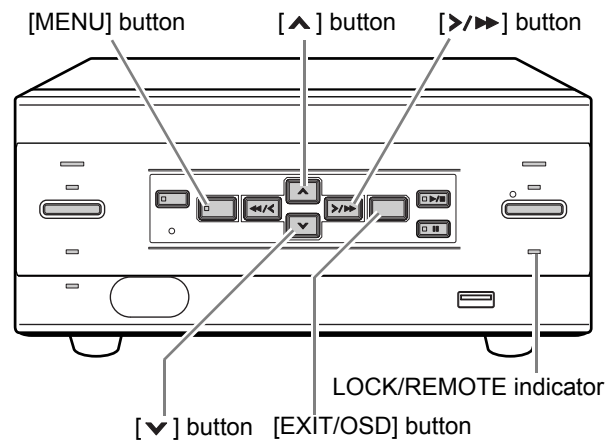

- 1 Press the [v] button for about 3 seconds after setting the password while the normal monitoring screen is displayed.

A confirmation tone sounds, the LOCK/REMOTE indicator lights, and the security lock is set.

- 2 To check the security lock, press the [MENU] button.

The password entry screen appears for about 5 seconds. When idle for approximately 5 seconds, the display returns to the normal screen.



- 3 Enter the password while the password entry screen is displayed.

Enter the password using the [v], [^] and [>/>>] buttons.

! CAUTION

- Enter the password set for administrators or users (such as "123456AB").

123456AB

- 4 Press the [>/>>] button.

The LOCK/REMOTE indicator goes out, and the display returns to the normal screen.

This section describes how to make the RS-485 terminal connections/settings needed to connect to an external device, and how to make the network connections needed to connect to a PC.

Network connections and settings

You can make digital video recorder menu settings and monitor images from a PC via a network. To do so, connect an LAN cable to the LAN terminal on the digital video recorder's rear panel.

- **To connect a PC directly**
(Do not use a switch.)

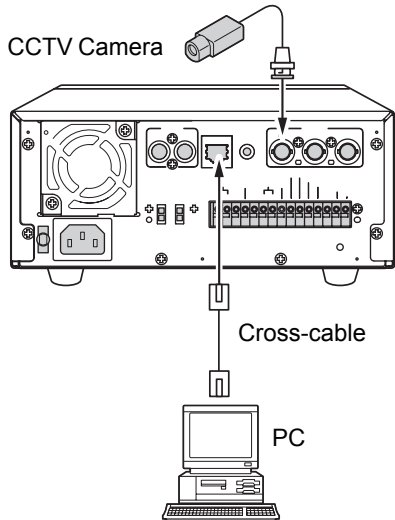

- **To connect to an intranet**
(Use a switch.)

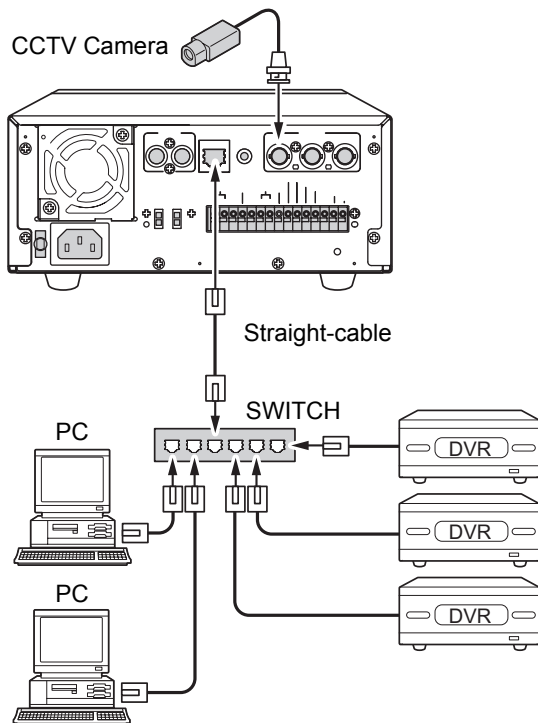

! CAUTION

- Network connection via the Internet is not available.
- You cannot use a router.

Settings for PC or network connection

When either the VA-SW81LITE or VA-SW814 remote operation software is used, the IP address will be set automatically by the PC. The following section describes the method to be used when it is necessary to set an IP address using the digital video recorder.

1 Press the [MENU] button.

The MENU indicator lights up and the <MAIN MENU> screen appears.

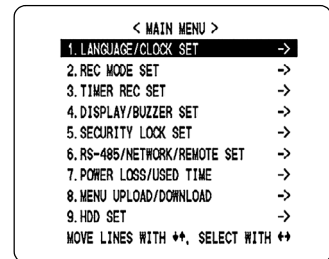

2 Select "6.RS-485/NETWORK/REMOTE SET" and press the [>/▶] button.

The <RS-485/NETWORK/REMOTE SET> screen appears.

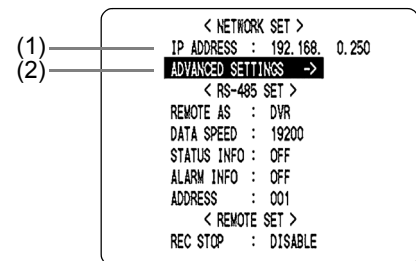

	Item	Setting	Description
(1)	IP ADDRESS		Displays the IP address that has been set.
(2)	ADVANCED SETTING		Set whether to set IP address on digital video recorder or on PC.

3 Press the [▲] and [▼] buttons to select “ADVANCED SETTING” and press the [▶/▶▶] button.

The <NETWORK SET-ADVANCED> screen appears.

The cursor moves to “ADDRESS SET”.

“DVR NAME” displays the name set for the digital video recorder when using remote control software.

When “ADDRESS SET” has been set to “MANUAL”, it will be possible to set “DVR NAME” using this menu.

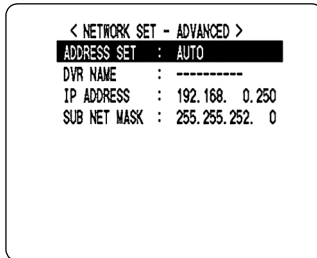

4 Press the [▶/▶▶] button, and then use the [▲], [▼], and [▶/▶▶] buttons to set “ADDRESS SET”.

[Settings] (◆ indicates initial setting.)

Setting	Description
◆AUTO	When either the VA-SW81LITE or VA-SW814 remote operation software is used, the digital video recorder's [STILL] button can be pressed to have the IP address set automatically.
MANUAL	The “DVR NAME”, “IP ADDRESS” and “SUB NET MASK” are set on the digital video recorder.

5 When “MANUAL” has been set, set “DVR NAME”, “IP ADDRESS”, and “SUB NET MASK” using the [▶/▶▶], [▲], and [▼] buttons.

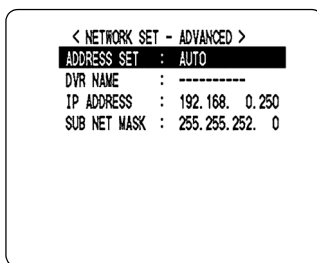

NOTE

- Refer to “Setting passwords” on P. 36 for more information regarding setting methods for “DVR NAME”.

6 Press the [EXIT/OSD] button.

The display returns to the normal screen.

NOTE

- When a new IP address is set using the digital video recorder, it will become valid upon leaving the <RS-485/NETWORK/REMOTE SET> screen.

CAUTION

- When connecting the digital video recorder to a network, check the IP address with the network administrator.

The set IP address is displayed in the <RS-485/NETWORK/REMOTE SET> screen.

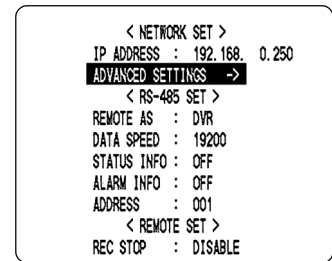

RS-485 connections and settings

Connect the digital video recorder's RS-485 (A, B) control terminals in series to the system controller, digital video recorder or similar device.

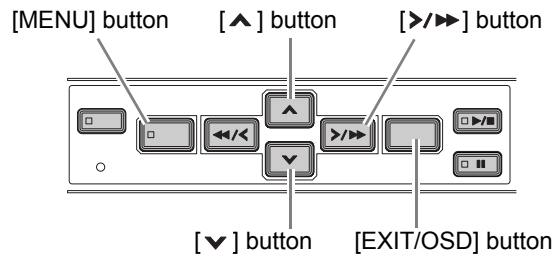

1 Press the [MENU] button.

The MENU indicator lights, and the <MAIN MENU> screen appears.

2 Select “6. RS-485/NETWORK/REMOTE SET”, and press the [▶/▶▶] button.

The <RS-485/NETWORK/REMOTE SET> screen appears.

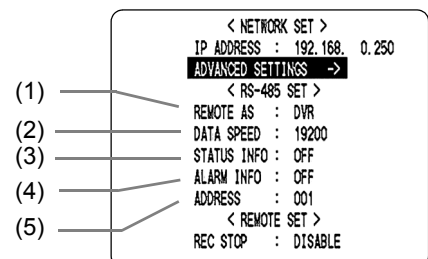

[Settings] (◆ indicates default setting.)

	Item	Setting	Description
(1)	REMOTE AS	VCR	When the digital video recorder is operated from a controller, sets it to operate as a VCR. Use VCR when using VSP-7000.
		◆ DVR	When the digital video recorder is operated from a controller, sets it to operate as a digital video recorder.
(2)	DATA SPEED		Used to select the communication speed. Selections: 19200/2400/4800/9600
(3)	STATUS INFO	ON	Status information is sent.
		◆ OFF	Status information is not sent.
(4)	ALARM INFO	ON	Alarm information is sent.
		◆ OFF	Alarm information is not sent.
(5)	ADDRESS*		Set the digital video recorder's address when using RS-485. Setting range: 000 to 127

3 Press the [▼] and [▲] buttons to select the desired item, then press the [▶/▶▶] button.

4 Press the [▼] and [▲] buttons to change the setting, then press the [▶/▶▶] button.

5 Use the same procedure to set the other items as needed.

6 Press the [EXIT/OSD] button.

The display returns to the normal screen.

Setting REMOTE SET

Use the following procedure to specify whether or not recording is to be stopped when the [REC] button on the separately-sold VA-RMN01 wired remote controller is pressed. When a setting of "ENABLE" has been made, the remote controller's [REC] button can be pressed for 2 seconds or longer to stop recording.

NOTE

- Regardless of this setting, if the [REC] button is pressed and released quickly (i.e., within 2 seconds), recording will be started.

1 Press the [MENU] button.

The MENU indicator lights up and the <MAIN MENU> screen appears.

Select "6.RS-485/NETWORK/REMOTE SET" and press the [▶/▶▶] button.

The <RS-485/NETWORK/REMOTE SET> screen appears.

```

< NETWORK SET >
IP ADDRESS : 192.168. 0.250
ADVANCED SETTINGS ->
< RS-485 SET >
REMOTE AS : DVR
DATA SPEED : 19200
STATUS INFO : OFF
ALARM INFO : OFF
ADDRESS : 001
< REMOTE SET >
REC STOP : DISABLE

```

2 Press the [▲] and [▼] buttons to select "REC STOP" and press the [▶/▶▶] button.

"DISABLE" flashes.

```

< NETWORK SET >
IP ADDRESS : 192.168. 0.250
ADVANCED SETTINGS ->
< RS-485 SET >
REMOTE AS : DVR
DATA SPEED : 19200
STATUS INFO : OFF
ALARM INFO : OFF
ADDRESS : 001
< REMOTE SET >
REC STOP -> DISABLE

```

3 Press the [▲] and [▼] buttons to change the setting, then press the [▶/▶▶] button.

[Settings] (◆ indicates initial setting.)

Setting	Description
◆DISABLE	Recording will not be stopped when the remote controller's [REC] button is pressed.
ENABLE	Recording will be stopped when the remote controller's [REC] button is pressed for at least 2 seconds.

4 Press the [EXIT/OSD] button.

The display returns to the normal screen.

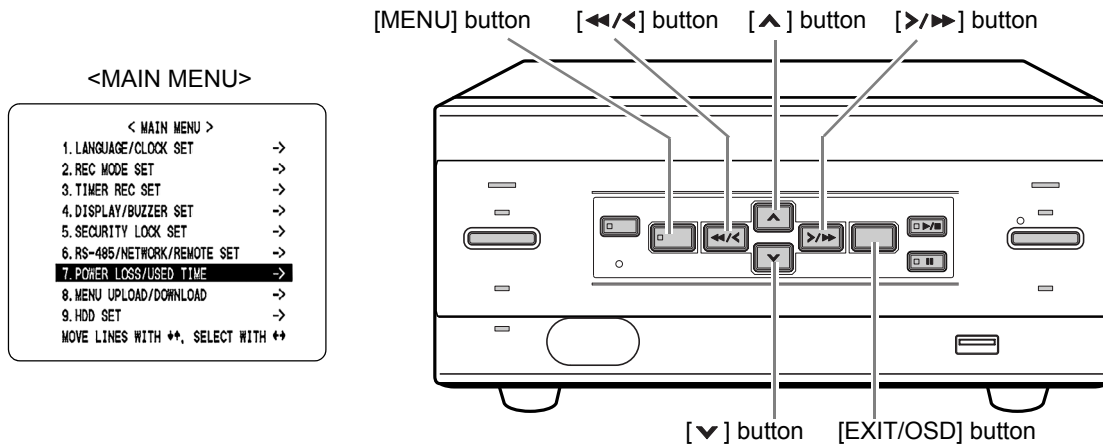

You can check the date/time of power losses and the amount of hard disk operation time.

1 Press the [MENU] button.

The MENU indicator lights, and the <MAIN MENU> screen appears.

2 Select "7. POWER LOSS/USED TIME", and press the [RIGHT] button.

The <POWER LOSS/USED TIME> screen appears. Use this screen to check the date/time of power losses and the amount of hard disk operation time.

< POWER LOSS/USED TIME >					
	LOSS		RECOVER		
(1)	#002	20-05 00:45	20-05 00:45		
		03-01 02:09	03-01 02:43		
		----	----		
		----	----		
(2)		DISK1 USE		:	00003 H
(3)		DISK2 USE		:	----- H
(4)		POWER		:	00003 H
FIRMWARE : MAIN 1.05-00 / SUB 1.04-00					

(1) LOSS/RECOVER

Displays the date and time of occurrence and restoration for the four most-recent power losses. The number on the left is the number of power losses (example: #002). Resets to "000" after exceeding "999".

(2) DISK1 USE

Displays the total amount of disk 1 operation time.

(3) DISK2 USE

Displays the total amount of disk 2 operation time (when second disk has been added).

(4) POWER

Displays the amount of power ON time for the digital video recorder.

3 Press the [EXIT/OSD] button.

The display returns to the normal screen.

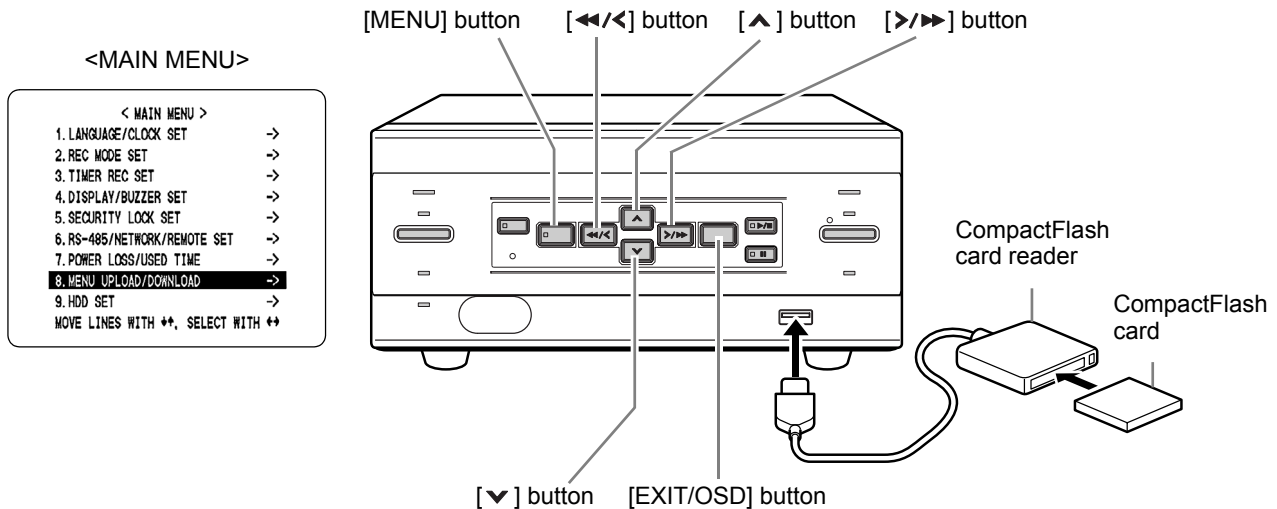

You can save menu settings onto a CompactFlash card. This sub-menu also lets you read menu settings saved on CompactFlash cards. This function proves useful when identical settings are to be used on a number of different digital video recorders. It also lets you initialize CompactFlash cards.

! CAUTION

- Do not turn the power OFF when saving/loading menu items to/from a CompactFlash card.
- Confirm that the light on the CompactFlash card reader is lit before using the card reader with the USB terminal. If used before the light is lit, SAVE and LOAD may not be recognized.
- When the menu cannot be saved to the CompactFlash card consecutively, remove the CompactFlash card, reinsert and try again.

NOTE

- At least 2 KB of available memory space is needed on the CompactFlash card.
- The file name is "M810MENU.TXT".

Operations

You will need a CompactFlash card reader and CompactFlash card (commercially available).

1 Press the [MENU] button.

The MENU indicator lights, and the <MAIN MENU> screen appears.

2 Select "8. MENU UPLOAD/DOWNLOAD", and press the [▶/▶▶] button.

The <MENU UPLOAD/DOWNLOAD> screen appears. The cursor is positioned on "SAVE MENUS TO CF".



The following two procedures describe the "SAVE MENUS TO CF" and "LOAD MENUS FROM CF" items.

To save menu items to CompactFlash card

1 Press the [➤/▶▶] button.

The <WARNING> screen appears.
“NO” flashes.

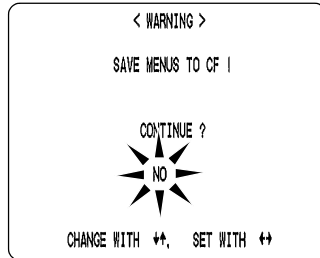

2 Press the [▼] and [▲] buttons to select “YES”, then press the [➤/▶▶] button.

Downloading starts.

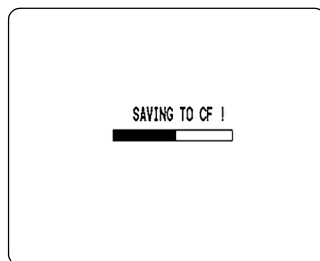

When you have finished saving, the display returns to the <MENU UPLOAD/DOWNLOAD> screen.

To load menu items from CompactFlash card

■ If “MIRRORING” setting is not loaded:

1 Press the [▼] and [▲] buttons to select “LOAD MENUS FROM CF”, then press the [➤/▶▶] button.

The <WARNING> screen appears.
“NO” flashes.

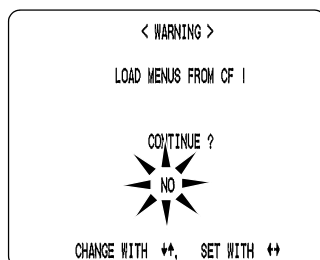

2 Press the [▼] and [▲] buttons to select “YES”, then press the [➤/▶▶] button.

Uploading starts.

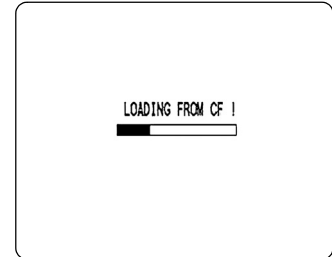

When you have finished loading, the display returns to the <MENU UPLOAD/DOWNLOAD> screen.

■ If “MIRRORING” setting is loaded:

! CAUTION

- If “COPY MIRRORING SETTINGS” is set to “YES”, the hard disk may be initialized. If you don't want to initialize the hard disk, select “NO”.

1 Press the [▲] and [▼] buttons to select “COPY MIRRORING SETTINGS” and press the [➤/▶▶] button.

“NO” flashes.

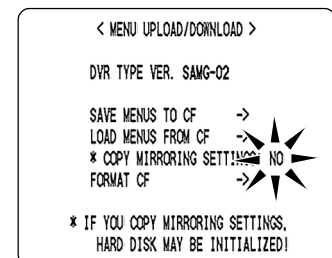

2 Press the [▲] and [▼] buttons to select “YES” and press the [➤/▶▶] button.

The cursor moves to “FORMAT CF”.

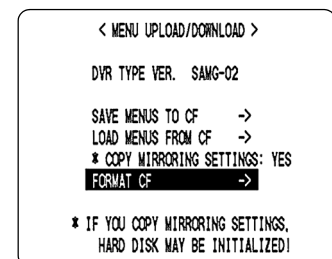

- 3** Press the [▲] and [▼] buttons to select “LOAD MENUS FROM CF” and press the [▶/▶▶] button.

The <WARNING> screen appears.
“NO” flashes.

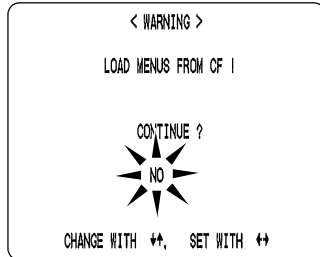

- 4** Press the [▲] and [▼] buttons to select “YES” and press the [▶/▶▶] button.

Uploading starts.

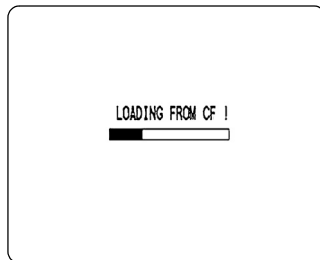

When you have finished loading, the display returns to the <MENU UPLOAD/DOWNLOAD> screen.

Formatting CompactFlash cards

- 1** Press the [▼] and [▲] buttons to select “FORMAT CF”, then press the [▶/▶▶] button.

The <WARNING> screen appears.
“NO” flashes.

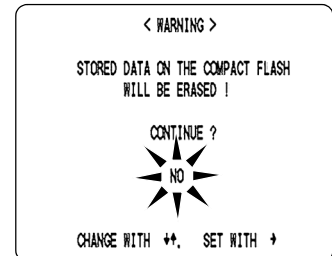

- 2** Press the [▼] and [▲] buttons to select “YES”, then press the [▶/▶▶] button.

CompactFlash card formatting starts.



When you have finished formatting, the display returns to the <MENU UPLOAD/DOWNLOAD> screen.

! CAUTION

- Formatting a CompactFlash card erases all the data stored on it. To cancel formatting, select “NO”.

To exit

- 3** Press the [EXIT/OSD] button.

The display returns to the normal screen.

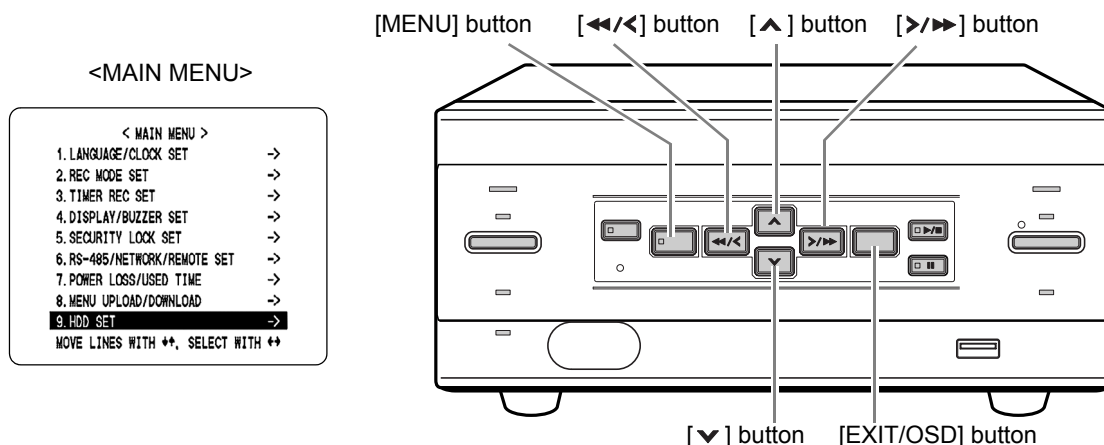

This section describes how to initialize the hard disk or add a hard disk.

Initializing the hard disk

1 Press the [MENU] button.

The MENU indicator lights, and the <MAIN MENU> screen appears.

2 Select "9. HDD SET", and press the [▶/▶] button.

The <HDD SET> screen appears.

The cursor is positioned on "DISK INITIALIZE".

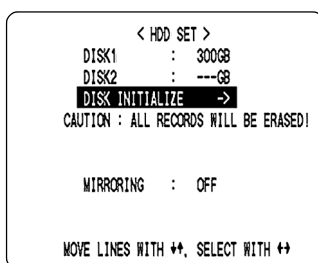

3 Press the [▶/▶] button.

The <WARNING> screen appears.

"NO" flashes.

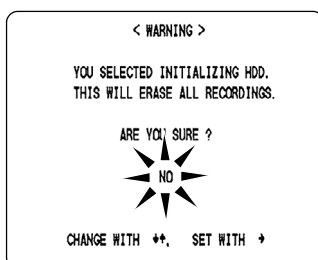

4 Press the [▼] or [▲] buttons to select "YES", then press the [▶/▶] button.

The "HDD INITIALIZING!" screen appears, and the hard disk is initialized (reformatted).

When the process has finished, the display returns to the MENU screen.

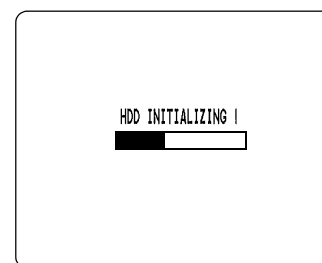

5 Press the [EXIT/OSD] button.

The display returns to the normal screen.

Adding a hard disk

To add a hard disk, contact a Sanyo Authorized Service Center. When adding a hard disk, use an add-on type hard disk unit (sold separately).

[Setting conditions]

- After adding a hard disk, be sure to initialize it. Note that both hard disks will be initialized, and any data on the original hard disk will be erased.

NOTE

Hard disk setting screen

- Mirroring: After adding a hard disk, you can record the same image on both hard disks. If an image write error occurs on one disk, you can still read the image from the other.
- Playback disk: When mirroring is set, the digital video recorder automatically sets which of the two hard disks to read the recorded image from.

RS-485 specifications

Data format

Mode	Asynchronous
Character length	8 bits
Data transmission speed	2400, 4800, 9600, 19200 bps
Parity check	None
Stop bit	1 bit

Communication protocol

A proprietary Sanyo protocol (SSP: Security Serial Protocol) is used. Use of a special controller for operation is recommended. To obtain this controller, contact a Sanyo Authorized Service Center.

RS-485 termination switch settings

Termination settings

When connecting multiple devices, you must make termination settings on both end devices.

- Set the RS-485 termination switch of both end devices to ON.
- Be sure to set the RS-485 termination switches of all devices in between (devices other than the first and last devices) to OFF.

! CAUTION

- If you don't make the correct termination settings, the incorrect data will be transmitted to each device.

Example

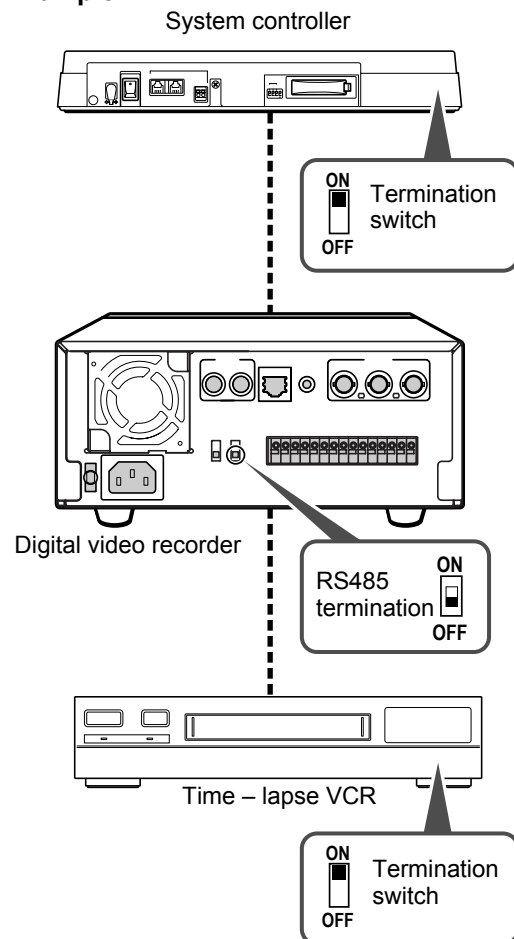

DVR/VCR command table

The table below shows the commands supported by the digital video recorder.

Left digit \ Right digit	0	1	2	3	4	5	6	7
0							TIMER ON/OFF	
1								
2								
3						SHIFT←	SHIFT→	
4						SHIFT↑	SHIFT↓	MENU
5							SHIFT+ /RP UP	
6							SHIFT- /RP DOWN	
7								
8								
9							SECURITY LOCK ON	
A	ACK			PLAY	REV PLAY /SEARCH (DVR)		SECURITY LOCK OFF	
B	NAK							
C							GROUP SET	
D							GROUP CHECK	
E							GROUP CLEAR	
F				STOP	STILL			

Left digit \ Right digit	8	9	A	B	C	D	E	F
0							CLOCK ADJUST	
1							MENU RESET	
2								
3								
4								
5								
6						T/L STATUS SENSE		
7						STATUS SENSE		
8								
9							CLOCK DOWNLOAD	
A					REC			REC/DUB REQUEST
B			FF					
C			REW					
D								RS-485 SEND START
E	OSD/EXIT			STATUS LOG2				RS-485 RCV CMF.
F				STATUS LOG1	REC STOP			

Television system	NTSC/PAL color signal standard (Switchable)	
Picture resolution	NTSC: 720 x 480 (Super+/Super/High), 352 x 480 (Standard) PAL: 720 x 576 (Super+/Super/High), 352 x 576 (Standard)	
Compression	MPEG2 (Video), MPEG1 Layer2 (Audio)	
Picture quality	4 levels (Super+/Super/High/Standard)	
Recording type	Frame	
Recording speed	1 (NTSC: 30 fps or PAL: 25 fps)	
Recording area	1	
Playback	Playback/Still/Search/Cue/Review/Frame advance/Slow	
Search mode	Time/date search	Search by time and date
	Alarm search	Search by alarm event list
Menu language	English/French/German/Spanish	
Clock settings	Day/Month/Year/Hours/Minutes/Seconds	
Video input terminal	1.0 V (p-p) / 75 Ω unbalanced (BNC)	
Video output terminal	1.0 V (p-p) / 75 Ω unbalanced (BNC)	
Audio input terminal	-8 dbs, 27 k Ω unbalanced (RCA pin jack)	
Audio output terminal	-8 dbs, 600 Ω unbalanced (RCA pin jack)	
Microphone input terminal	-60 dbs, 10 k Ω unbalanced (ϕ 3.5 mm mini jack)	
LAN terminal	100BASE-TX/10BASE-T (RJ-45)	
USB terminal	For CompactFlash card reader and CD-R/RW drive (Front)	
Control connector (Push lock)	RS-485 terminal	3 terminals (A, B, GND)
	Remote control input terminal	External switch connection or VA-RMN01 remote control
	Clock adjust input terminal	Normal open, Low level active
	Clock adjust output terminal	Normal 5 V, Low level active
	Series REC input terminal	Normal open, Low level active
	Non REC output terminal/ Series REC output terminal	Normal 5 V, Low level active
	Alarm input terminal	Normal open, Low level active
	Alarm reset input terminal	Normal open, Low level active
	Alarm output terminal	Normal 5 V, Low level active
	Warning output terminal	Open collector (500 mA), Low level active
Full out warning terminal	Open collector (50 mA), Low level active	
Power	120 V to 240 V AC, 50/60 Hz	
Current consumption	440 mA	
Operating environment	Temperature: 5°C to 40°C, Humidity: 10 % to 80 %	
Dimensions	210 (W) x 96 (H) x 380 (D) mm	
Weight	3.6 kg (3 kg without a HDD)	

Note that product appearance and specifications are subject to change without prior notice.

Dimensions

Unit: mm

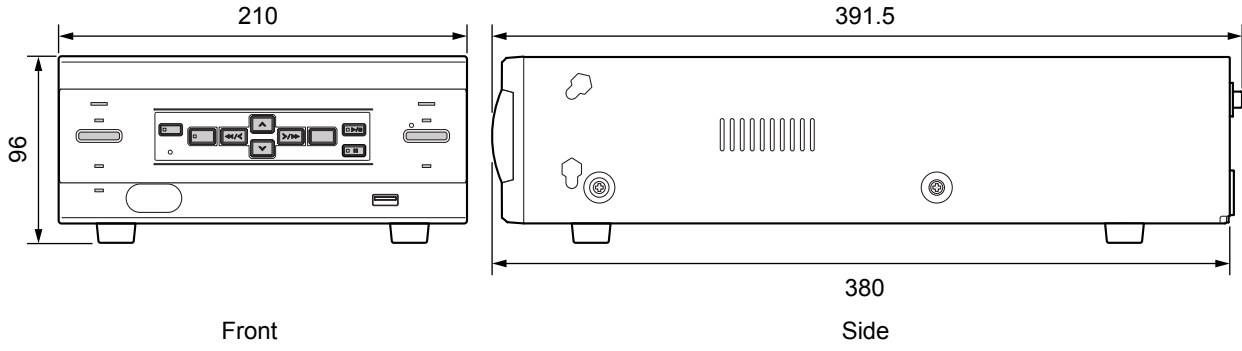

A

add a hard disk	47
ADDRESS	41
ADJUST. TIME	27
ADMIN	36
ADVANCED SETTING	40
ALARM COUNT	34
ALARM DURATION	29
ALARM indicator	15
ALARM INFO	41
ALARM MODE	29
alarm number	19
ALARM ON	34
Alarm recording	15
ALARM SEARCH	18
AUDIO RECORDING	29
AUTO DELETE	29

B

BUZZER SET	34
------------------	----

C

CLOCK SET	12
CompactFlash card	43
COPY SET	21
Copying image	21
[>/▶] (CUE) button	16

D

DATA SPEED	41
DATE/TIME	34
DISK FULL	34
DISPLAY SET	34
[▼] (DOWN) button	16
DVR NAME	34

E

[EXIT/OSD] button	24
EXT.CLOCK SET	27

F

FORMAT MEDIA	22
Formatting a CompactFlash card or CD-RW	22
Frame advance (reverse)	17
FULL indicator	30

H

HDD SET	46
HOLIDAY SET	33

I

initialize CompactFlash cards	43
initialize the hard disk	46

K

KEY IN	34
key lock	23

L

LANGUAGE	12
LANGUAGE/CLOCK SET	12
LOCK/REMOTE indicator	38

M

MAIN MENU	25
[MENU] button	24
[MENU RESET] button	24
MENU UPLOAD/DOWNLOAD	43
Mirroring	47

N

NETWORK SET	39
NON REC	34
Normal recording	14

O

OVER WRITE	29
------------------	----

P

Password	36
PICTURE QUALITY	29
[▶/■] (PLAY/STOP) button	16
Playback	16
Playback disk	47
Playback while fast-forwarding/rewinding	16
POWER indicator	10
POWER LOSS	42
POWER LOSS/USED TIME	42

Q

QUALITY/AUDIO	34
---------------------	----

R

REC CONTROL	36, 38
REC indicator	14
REC MODE SET	30
REC/PB TIME	29
[REC/STOP] button	14
Releasing the key lock	23
REMOTE AS	41
REMOTE SET	41
[◀/◀] (REVIEW) button	16
RS-485	39
RS-485 specifications	48
RS-485 termination switch	48

S

[SEARCH] button	18
SECURITY LOCK SET	36
SERIES REC	29
STATUS INFO	41

[STILL] button	17
still images	17
sub-menus	25
SUMMER TIME SET	26

T

TIME DATE SEARCH	19
[TIMER] button	14
TIMER indicator	14
TIMER REC SET	31
Timer recording	14
Timer reservations spanning more than 24 hours	32
TV SYSTEM selector switch	8

U

[^] (UP) button	16
USED TIME	42
USER	36

V

VIDEO LOSS	29
------------------	----

W

WARNING	34
---------------	----

Printed on recycled paper
Gedruckt auf recyceltem Papier
Imprimé sur du papier recyclé
Impreso en papel reciclado
Stampato su carta riciclata
印刷在再生纸上

1AC6P1P2825--
L8HAE/XE (0704TR-SY)

The SANYO logo is rendered in a bold, black, sans-serif font. The letter 'A' is stylized with several vertical lines passing through it, creating a distinctive graphic element.

SANYO Electric Co., Ltd.

Printed in Japan

Free Manuals Download Website

<http://myh66.com>

<http://usermanuals.us>

<http://www.somanuals.com>

<http://www.4manuals.cc>

<http://www.manual-lib.com>

<http://www.404manual.com>

<http://www.luxmanual.com>

<http://aubethermostatmanual.com>

Golf course search by state

<http://golfingnear.com>

Email search by domain

<http://emailbydomain.com>

Auto manuals search

<http://auto.somanuals.com>

TV manuals search

<http://tv.somanuals.com>