

SANYO

Digital Video Recorder

DSR-M800

Instruction manual	English	GB
Manuel D'instructions	Français	F
Manuel de Instrucciones	Español	E

About this manual

Before installing and using this unit, please read this manual carefully. Be sure to keep it handy for later reference.

À propos de ce manuel



Avant d'installer et d'utiliser cet appareil, veuillez lire ce manuel attentivement. Assurez-vous de le garder à portée de la main pour référence ultérieure.

Acerca de este manual

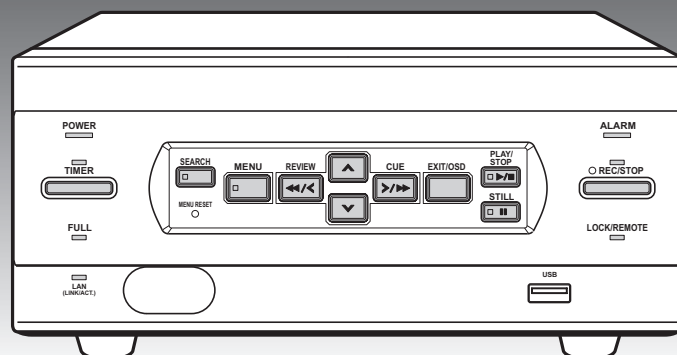
Antes de instalar y usar este aparato, lea detenidamente este manual. Asegúrese de guardarlo a mano para futuras referencias.





PRECAUTION

	CAUTION RISK OF ELECTRIC SHOCK DO NOT OPEN	
<p>CAUTION: TO REDUCE THE RISK OF ELECTRIC SHOCK, DO NOT REMOVE COVER (OR BACK). NO USER-SERVICEABLE PARTS INSIDE. REFER SERVICING TO QUALIFIED SERVICE PERSONNEL.</p>		

WARNING: To reduce the risk of fire or electric shock, do not expose this appliance to rain or moisture.

CAUTION: Changes or modifications not expressly approved by the manufacturer may void the user's authority to operate this equipment.

	The lightning flash with arrowhead symbol, within an equilateral triangle, is intended to alert the user to the presence of uninsulated "dangerous voltage" within the product's enclosure that may be of sufficient magnitude to constitute a risk of electric shock to persons.
	The exclamation point within an equilateral triangle is intended to alert the user to the presence of important operating and maintenance (servicing) instructions in the literature accompanying the product.

This equipment has been tested and found to comply with the limits for a Class B digital device, pursuant to part 15 of the FCC Rules.

These limits are designed to provide reasonable protection against harmful interference in a residential installation. This equipment generated, uses and can radiate radio frequency energy and, if not installed and used in accordance with the instructions, may cause harmful interference to radio communications. However, there is no guarantee that interference will not occur in a particular installation.

If this equipment does cause harmful interference radio or television reception, which can be determined by turning the equipment off and on, the user is encouraged to try to correct the interference by one or more of the following measures:

- Reorient or relocate the receiving antenna.
- Increase the separation between the equipment and receiver.
- Connect the equipment into an outlet on a circuit different from that to which the receiver is connected.
- Consult the dealer or an experienced radio/TV technician for help.

For the customers in Canada

This class B digital apparatus complies with Canadian ICES-003.

CAUTION

Danger of explosion if battery is incorrectly replaced. Replace only with the same or equivalent type recommended by the manufacturer. Discard used batteries according to the manufacture's instructions.

Declaration of Conformity

Model Number : DSR-M800
 Trade Name : SANYO
 Responsible party : SANYO FISHER COMPANY
 Address : 21605 Plummer Street,
 Chatsworth, California 91311
 Telephone No. : (818) 998-7322

- This device complies with Part 15 of the FCC Rules. Operation is subject to the following two conditions:
 - (1) this device may not cause harmful interference, and
 - (2) this device must accept any interference received, including interference that may cause undesired operation.

Location

For safe operation and satisfactory performance of your unit, keep the following in mind when selecting a place for its installation:

- Shield it from direct sunlight and keep it away from sources of intense heat.
- Avoid dusty or humid places.
- Avoid places with insufficient ventilation for proper heat dissipation. Do not block the ventilation holes at the top and bottom of the unit. Do not place the unit on a carpet because this will block the ventilation holes.
- Install the unit in a horizontal position only.
- Avoid locations subject to strong vibrations.
- Avoid moving the unit between cold and hot locations.
- Do not place the unit directly on top of a monitor TV, as this may cause playback or recording problems.

Avoiding Electrical Shock and Fire

- Do not handle the power cord with wet hands.
- Do not pull on the power cord when disconnecting it from an AC wall outlet. Grasp it by the plug.
- If any liquid is spilled on the unit, unplug the power cord immediately and have the unit inspected at a factory-authorized service centre.
- Do not place anything directly on top of this unit.

SERVICE

This unit is a precision instruments and if treated with care, will provide years of satisfactory performance. However, in the event of a problem, the owner is advised not to attempt to make repairs or open the cabinet. Servicing should always be referred to your dealer or Sanyo Authorized Service Centre.

INTRODUCTION

Main features

This digital video recorder can be used to store images recorded by a monitoring camera onto its built-in hard disk.

■ Comes with a large-capacity (120 GB or 240 GB) hard disk.

For the 120 GB model, a hard disk upgrade is available (sold separately) that gives you a total of 240 GB of memory.

■ Complete range of recording/playback functions

- You can play back and record images at the same time.
- You can record and play back audio.
- The timer record function lets you make recordings at different times each day. (→P.29)

■ The search function lets you instantly display the desired image. (→P.18)

- Searching in order of alarm occurrence
- Searching by date/time

■ The security lock function lets you restrict users, for data and equipment management. (→P.34)

■ Expandable, can be connected to a PC

- The Ethernet terminal lets you connect the digital video recorder to a network, for remote operation/remote monitoring.*
- Network connection lets you control up to 1,000 DVRs (digital video recorders) using 4 PCs.*
- Can be connected to a system controller (sold separately) using the RS-485 terminal.
- A CompactFlash reader can be connected using the USB terminal, letting you upload/download menu data.

Items marked by asterisks (*) require the VA-SW800 remote operation software (sold separately). For more information, contact a Sanyo service center.

Accessories

Check that you have all the parts below.

Power cord

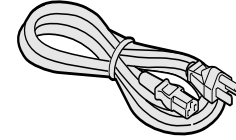

Ferrite core (for LAN connection cable)

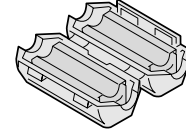

Power cord tie

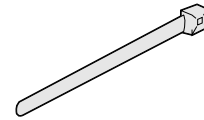

Symbols used in this manual



Information describing operation methods or how to get the most out of functions



Information describing the correct use of the digital video recorder

(→P. xx) Indicates manual page to refer to.

Copyright

- This manual and software are copyrighted by Sanyo Electric Co., Ltd.
- Brand and product names used in this manual are the trademarks or registered trademarks of their respective companies.
- Except for personal use, copyright law prohibits the use of recorded copyrighted images without the permission of the copyright holder
- Sanyo's DSR-M800 Digital Video Recorder uses software components distributed as freeware based on end user license agreements or copyright notifications (collectively referred to as "EULAs") set forth by third parties.

CONTENTS

INTRODUCTION

1 BEFORE USE.....5	2 NAMES AND FUNCTIONS OF PARTS 7
Notes on handling internal hard disk drive components5	Front panel..... 7
Do not use the digital video recorder in the following locations:.....5	Rear panel..... 8
The hard disk and cooling fan are consumables.....5	
Installation conditions.....5	3 INSTALLATION AND CONNECTIONS 9
For important recordings.....5	Basic connections 9
Hard disk protection.....6	System controller connections 9
Care6	Connecting a remote control circuit..... 9
During extended disuse6	Connecting cables to the control and alarm terminals..... 10
Backup battery6	Connecting to a network 10
	Connecting the power cord 10

OPERATION

1 SCREEN DISPLAY AND POSITION11	5 NORMAL RECORDING/TIMER RECORDING PLAYBACK 16
Operation display area11	Playback..... 16
Changing the position of the operating display11	Playback while fast-forwarding/rewinding 16
	Viewing still images..... 17
2 SETTING THE LANGUAGE/CLOCK12	Frame advance (reverse)..... 17
To change the language12	
Setting the time13	6 SEARCHING FOR RECORDED IMAGES ... 18
3 NORMAL RECORDING/TIMER RECORDING14	Alarm search 18
Normal recording14	Date/time search 19
Timer recording.....14	
4 ALARM RECORDING15	7 PREVENTING ACCIDENTAL OPERATION (KEY LOCK FUNCTION)..... 21
Alarm recording.....15	Setting the key lock function 21
	Releasing the key lock function..... 21

CONTENTS

SETTINGS

MENU CONFIGURATION AND OPERATIONS22	
Displaying the menu screen and sub-menu screens22	
To restore menu setting items to their initial values22	
Overview of sub-menus23	
1 LANGUAGE/CLOCK SET24	
<DAYLIGHT SAVING> settings24	
<EXT.CLOCK SET> settings25	
2 REC MODE SET27	
<REC MODE SET> setting items27	
Settings28	
Starting recording again when the FULL indicator lights28	
3 TIMER REC SET29	
Timer setting items29	
Timer reservations every day at the same time with the same image quality29	
To cancel all timer reservations30	
Timer reservations spanning more than 24 hours30	
Setting holidays31	
4 DISPLAY/BUZZER SET 32	
<DISPLAY/BUZZER SET> setting items 32	
Settings 33	
5 SECURITY LOCK SET 34	
Password setting example 34	
Password setting 34	
Setting passwords 34	
Setting the user password 35	
Setting the authorization for recording and playback operations 36	
Setting the security lock 36	
6 RS-485/NETWORK SET 37	
Network connections and settings 37	
RS-485 connections and settings 38	
7 POWER FAILURE/USED TIME 39	
8 MENU UPLOAD/DOWNLOAD 40	
Settings 40	
9 INITIALIZE/ADD HDD 42	
Initializing the hard disk 42	
Adding a hard disk (120 GB model only) 43	

OTHER

1 INTERFACE SPECIFICATIONS44	2 SPECIFICATIONS 46
RS-485 specifications44	Dimensions 47
RS-485 termination switch settings44	
DVR/VCR command table45	

INTRODUCTION

OPERATION

SETTINGS

OTHER

1 BEFORE USE

Notes on handling internal hard disk drive components

This unit has a built-in hard disk drive (HDD).

Be sure to observe the following points carefully when operating, setting-up and servicing the unit.

■ Do not subject the unit to shocks or vibration.

If the unit is subjected to shocks or vibration, it may damage the HDD or cause corruption of the data stored in the HDD.

- Do not move the unit while the power is turned on. Always be sure to turn off the power before removing the unit from or placing it onto the rack.
- When transporting the unit, pack it securely using the specified packing materials. In addition, use a method of transportation that minimizes vibration.
- When placing the unit down on a surface such as a floor, attach the specified feet to the base of the unit and place it down gently. If the feet are not attached, place the unit down very carefully so that it does not make any noise.

■ Do not move the unit for 30 seconds after turning off the power.

After the power is turned off, the disk inside the HDD will continue to spin for a brief period due to inertia, and the heads will be in an unstable state.

During this time, the unit is even more susceptible to shocks and vibration than when power is being supplied. Make sure that the unit is not subjected to even gentle vibration for at least 30 seconds after turning off the power.

■ Do not operate the unit when condensation has formed.

If the unit is operated when condensation has formed, it may cause operating problems.

If sudden changes in the ambient temperature occur, wait for the temperature to stabilize before operating the unit.

■ Notes when replacing the HDD

Be sure to follow the correct replacement procedure when replacing the HDD.

- HDDs that have been removed from their packing may not operate correctly if they are subjected to any shocks and vibration. It is recommended that you place HDD onto a soft, level surface with the printed circuit board facing upward after unpacking it.
- Be careful not to subject the HDD to shocks or vibration when removing and tightening screws as part of the HDD replacement procedure. Make sure that all screws are tightened securely so that they will not become loose.

The HDD is sensitive to static electricity, so you should take proper precautions to prevent static electricity buildup.

■ Handling the HDD unit by itself

If transporting or storing the HDD unit by itself, always be sure to pack it in the specified packing first.

In addition, use a method of transportation that minimizes the vibration.

If the HDD becomes damaged, handle the unit and the damaged HDD that has been removed in order for it to be replaced carefully to prevent the problem from being aggravated until as the nature of the problem can be checked and analyzed.

Do not use the digital video recorder in the following locations:

- The hard disk is sensitive to dust, vibrations and shocks, and should also not be used near magnetic objects. To prevent loss of recorded data, observe the following precautions:
 - Do not subject the digital video recorder to shocks.
 - Do not use the digital video recorder on a vibrating or unstable surface.
 - Do not disconnect the power plug from the wall outlet during recording or playback.
 - Do not use the digital video recorder in areas of extreme temperature changes (10°C or more per hour).
 - Condensation may occur if the digital video recorder is moved to an area of extremely different temperature or high humidity. If the digital video recorder is used with condensation inside it, operating problems may occur.
 - Do not install the digital video recorder in areas of constant vibration such as motor vehicles or trains.

The hard disk and cooling fan are consumables.

Under use in an ambient temperature of 25°C, the hard disk should generally be replaced after 2 years, and the cooling fan after 3 years. These figures are intended as guidelines only, and are not guarantees of part performance.

The POWER indicator flashes if a problem occurs in the hard disk or fan. (→P.10)

Installation conditions

The digital video recorder has ventilation holes on its left, rear and bottom panels. Make sure these holes are not blocked after installation.

Do not use the unit in an area of poor ventilation such as a bookshelf or box.

When installing the unit in a rack, ensure a gap of at least 5 cm at the top and bottom.

For important recordings

- Always make a test recording beforehand to check that the digital video recorder's playback is normal.
- Note that no compensation will be provided for losses due to recording or playback problems arising from problems with the digital video recorder or its connected devices during operation.

1 BEFORE USE

- To be prepared for malfunctions or accidents, back up important recordings periodically, or record using mirroring.

Hard disk protection

The hard disk is checked automatically at power ON. If a hard disk problem is found, the POWER indicator flashes. If you need to initialize the disk or save images stored on the disk, contact a Sanyo service center.

Care

- To clean the digital video recorder, unplug the power plug from the wall outlet and wipe the unit lightly with a soft cloth.
- To remove heavy grime, wipe the digital video recorder with a well-wrung cloth soaked in a solution of water and neutral detergent, and then wipe it with a dry cloth.
- Do not clean the unit with benzene or paint thinner. Doing so may break down the finish or strip the paint.
- When using a chemical cloth, be sure to follow the precautions provided with it.
- Do not spray insecticide or other volatile chemicals on the cabinet. Do not allow rubber or vinyl products to come into contact with the digital video recorder for extended periods. Doing so may break down the finish or strip the paint.

During extended disuse

Extended disuse may cause problems in functions, so turn the power on and operate the unit occasionally during such periods.

Backup battery

The digital video recorder comes with a built-in lithium battery. When the digital video recorder has been connected to a wall outlet for at least 48 hours and the date and time have been set, the clock function will continue to operate for up to 30 days after the power plug is disconnected.

When disposing of the digital video recorder, contact a Sanyo service center for information on how to dispose of the lithium battery.

2 NAMES AND FUNCTIONS OF PARTS

Front panel

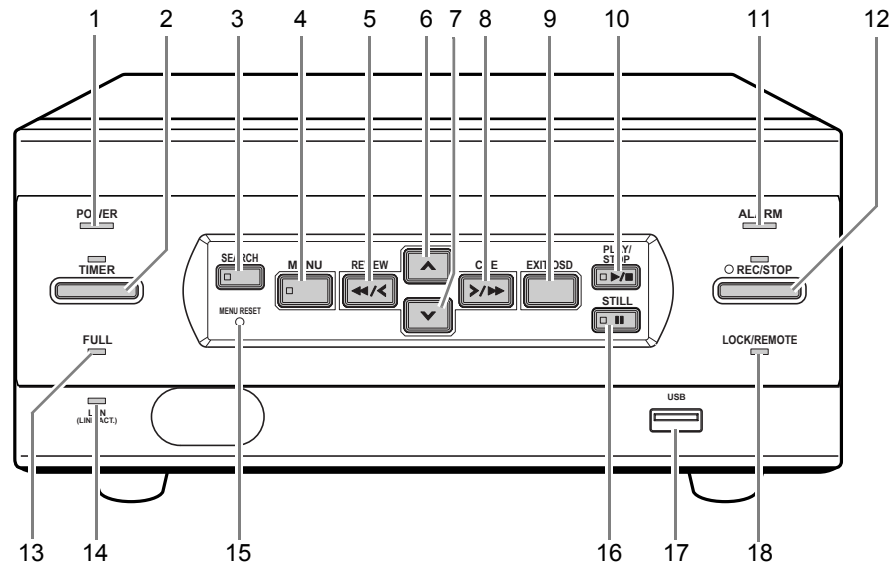

1. **POWER indicator**
Lights when the power is ON.
Flashes when there is a problem with the hard disk or fan. (→P.10)
2. **[TIMER] button and indicator (→P.14)**
When the button is pressed while recording or stopped, the digital video recorder enters timer record standby, and the indicator lights. When the set time arrives, the digital video recorder starts timer recording.
3. **[SEARCH] button and indicator (→P.18)**
When the button is pressed while recording or stopped, the indicator lights, and the search setting screen appears.
4. **[MENU] button**
Used to display the menu screens (setting screens). The indicator lights when a menu screen is displayed.
5. **[REVIEW] button**
When pressed during playback, lets you rewind the image while watching it on screen. Also used for menu screen operations.
6. **[▲] button**
Used to move the cursor in menu screens up. Also used to change setting values.
7. **[▼] button**
Used to move the cursor in menu screens down. Also used to change setting values.
8. **[CUE] button**
When pressed during playback, lets you fast-forward the image while watching it on screen. Also used for menu screen operations.
9. **[EXIT/OSD] button**
Returns to the normal screen when the main menu or a sub-menu is displayed.
10. **[PLAY/STOP] button**
Plays back the normal image (indicator lights). When pressed during playback, stops playback.
11. **ALARM indicator**
Flashes when recording an alarm image.
12. **[REC/STOP] button and indicator**
Starts normal recording. Indicator lights during recording.
During recording, pressing the button for at least 3 seconds stops recording and turns off the indicator.
13. **FULL indicator (→P.14)**
Lights when the remaining memory in the hard disk's recording area has reached zero and recording has stopped.
14. **LAN indicator**
Lights when the digital video recorder is connected to a network. Flashes when data is being sent and received.
15. **[MENU RESET] button (→P.22)**
Used to initialize the currently displayed menu settings, and to set the time.
16. **[STILL] button**
When pressed during playback, freezes the screen image (the indicator lights). Pressing the button again resumes playback.
17. **USB terminal (→P.40)**
Used to connect a CompactFlash memory card reader.
18. **LOCK/REMOTE indicator (→P.21, P.34)**
Lights when operations have been locked by the key lock or security lock setting.
If an operation button is pressed when the security lock is set, a buzzer sounds. The key lock cannot be set during playback.
The indicator flashes at 1Hz when there is a network connection, and flashes at 4Hz when there is a network connection while locked.

2 NAMES AND FUNCTIONS OF PARTS

Rear panel

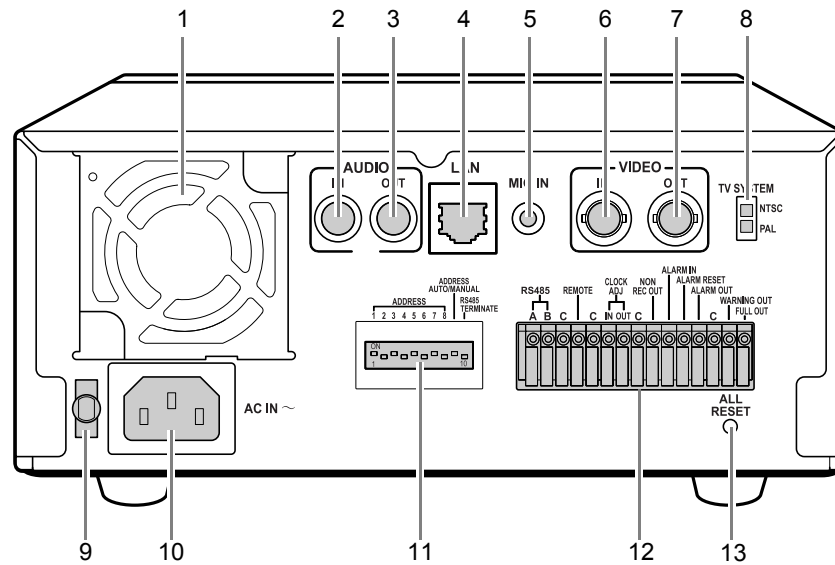

1. **FAN**
2. **AUDIO IN terminal**
3. **AUDIO OUT terminal**
4. **LAN terminal (→P.37)**
5. **MIC IN terminal**
6. **VIDEO IN terminal**
7. **VIDEO OUT terminal**
8. **TV SYSTEM selector switch**
Used to select the video signal between NTSC and PAL systems for the camera input and TV monitor output connected to the digital video recorder.
9. **Power cord holder**
Secure the power cord to the holder using the cord tie (accessory) as shown in the illustration.

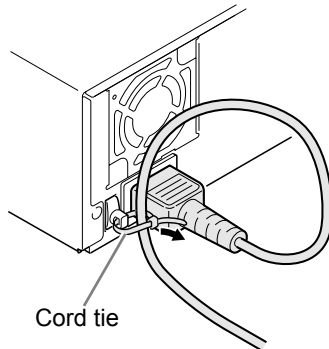

10. **AC INLET**
AC power input terminal (3-core)

11. Dip switches (→P.37)

ADDRESS	Used to set the device address of the TCP/IP or RS-485 (SSP) interface.
ADDRESS AUTO MANUAL	Used to select whether to acquire the IP address by automatic allocation, or to specify the lowest-order byte of the address using the dip switches.
RS485 TERMINATE	RS-485 termination ON/OFF switch

12. Control and alarm terminals

Pin	Signal
RS485A	To RS-485 terminal signal A *1
RS485B	To RS-485 terminal signal B *1
C	Common *1
REMOTE	For wired remote control (VA-RMN01)
C	Common
CLOCK ADJ IN	Input for clock setting
CLOCK ADJ OUT	Output for clock setting
C	Common
NON REC OUT	NON-REC output
ALARM IN	Alarm input
ALARM RESET	Alarm reset input
ALARM OUT	Alarm output
C	Common
WARNING OUT	Warning output *2
FULL OUT	Recording area full warning

*1 Used for twisted-pair cable connection.

*2 The following warnings are output:

- Hard disk drive error ● Fan error ● Recording error
- No input signal when VIDEO LOSS is ON.

13. ALL RESET switch

Resets the clock and backup mode setting.

3 INSTALLATION AND CONNECTIONS

This section describes how to connect the digital video recorder to the CCTV camera and other devices. Be sure to read the instruction manuals for each connected device. Make connections carefully. Improper connections can cause smoke or malfunctions.

Basic connections

The connections for the camera, TV monitor, microphone and PC are shown below.

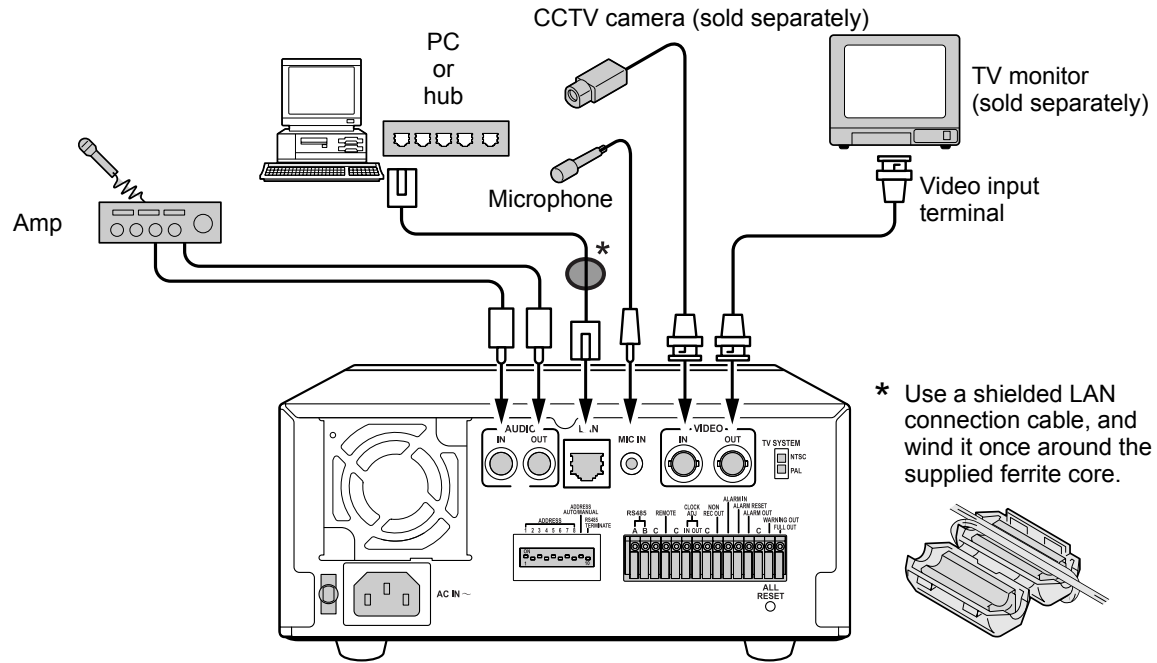

System controller connections

The connections for a system controller are shown below. Use a twisted-pair cable (sold separately) to connect rear panel control terminals A, B and C (ground). Connect signal A to signal A, and signal B to signal B.

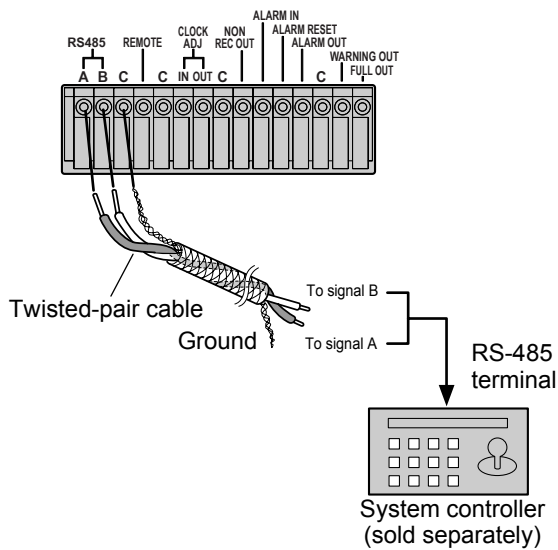

- Twisted-pair cable
Can reduce interference on the signal caused by noise generated by other cables.

Connecting a remote control circuit

The connections for a remote control circuit are shown below. Making the connections shown below lets you operate the digital video recorder by remote control.

- Create the remote control circuit shown in the illustration, and connect it to the remote control input terminals (among the control terminals).

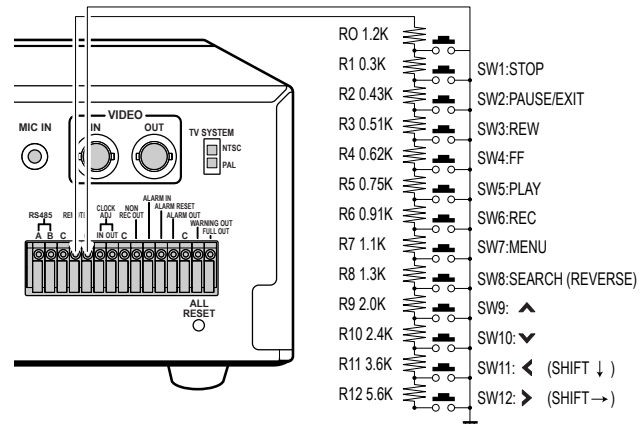

() : When VA-RMN01 is used

Use a resistance of 1/10 ohms or more and with a D ranking (precision 0.5% or finer).

3 INSTALLATION AND CONNECTIONS

- Connect the cable of the wired remote control (VA-RMN01) (sold separately) to the remote control input terminals (among the control terminals).
Cut the plug off the cord, and connect the red wire to "REMOTE" and the bare wire to "C".

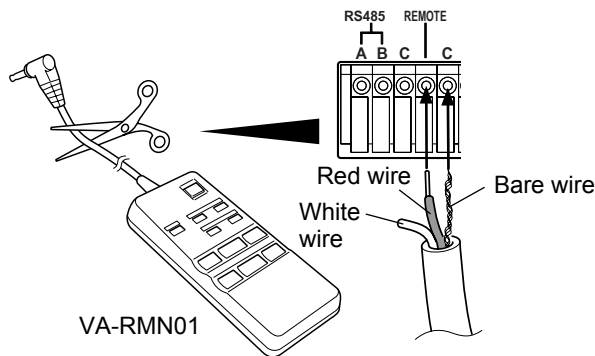

Connecting cables to the control and alarm terminals

- (1) Push in the lock pin with a flat-blade screwdriver.
- (2) Insert the cable.
- (3) Pull out the lock pin with a flat-blade screwdriver. The cable is now fixed in place.

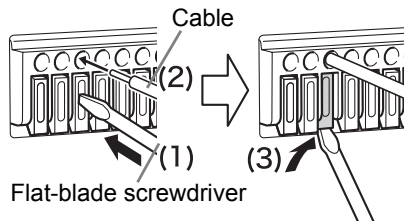

Connecting to a network

The VA-SW800 application software (sold separately) lets you control the digital video recorder, and monitor live images, recorded images and audio through a network.

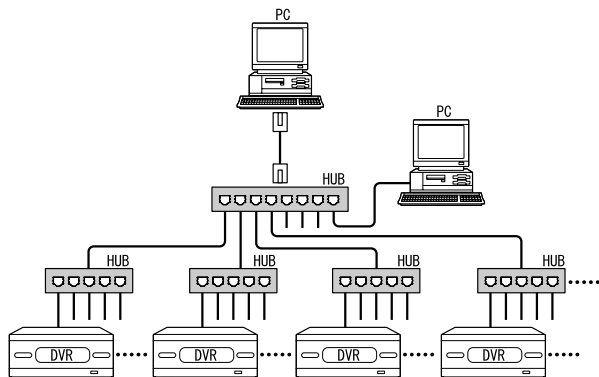

Connecting the power cord

- 1 When you have finished making all the other connections, insert the power plug into the wall outlet.

There is no power switch. All the display indicators flash for approximately 30 seconds, then the POWER indicator lights. The monitor screen displays the camera image.

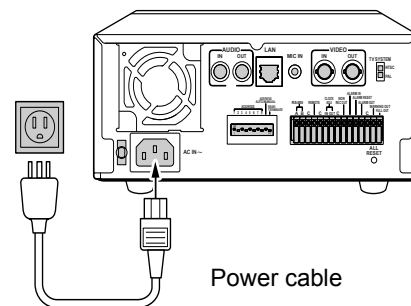

- When turning the power ON for the first time "PLEASE SET THE CLOCK" is displayed on the monitor screen. Follow the steps on page 12 to set the clock.
- If the clock is already set

Operating display

The operation display area is displayed.

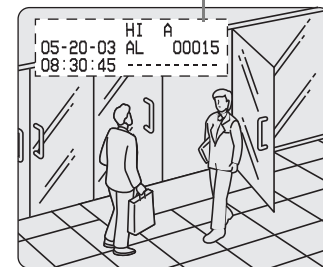

! CAUTION

- If the POWER indicator flashes
The digital video recorder has a self-check function that indicates problems. If there is a problem at power ON or during operation, the type of problem is indicated by how rapidly the POWER indicator flashes. Contact a Sanyo Authorized Service Center if the POWER indicator flashes.
4 flashes per second:
The disk is checked automatically at power ON. If a hard disk problem is found, the POWER indicator flashes, and the hard disk must be replaced or reformatted. If you need to save images stored on the disk, contact a Sanyo Authorized Service Center.
1 flash per second:
Fan problem
- If you disconnect the power cable
Don't move the digital video recorder for 30 seconds after power OFF.
The disk in the hard disk drive briefly keeps spinning after power OFF due to inertia, during which time the head is unstable. At this time, the disk is sensitive to shocks or vibrations, so avoid even light shocks.

1 SCREEN DISPLAY AND POSITION

At power ON, the operation display area appears at the top left of the monitor screen. The operation display area shows the date/time, image quality, remaining time, and other information needed for operations.

Operation display area

Example: Normal screen

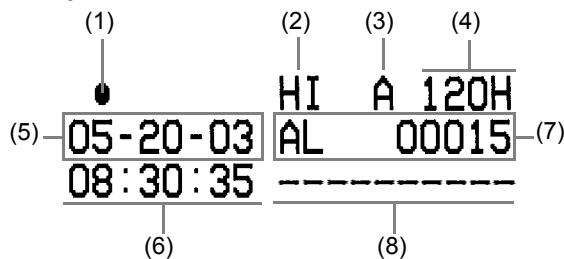

Playback screen

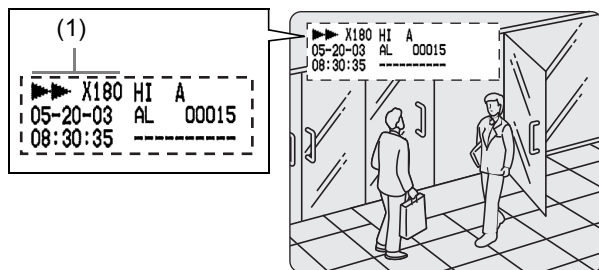

(1) Operating symbol display

Displays the operation (such as recording or playback) and playback speed.

- : Recording
- ▶▶ : Fast-forward playback
- ▶ : Playback
- ◀◀ : Rewind playback
- || : Still
- ||▶ : Slow playback
- ◀◀|| : Reverse slow playback

The playback speed is displayed during fast-forward or fast-rewind playback at 15 times the normal playback speed or faster, and during slow or reverse slow playback.

NOTE

- During simultaneous recording and playback, the display indicates playback (▶).

(2) Image quality display (→P.27)

Displays the quality of the image that can be recorded on the hard disk. Set to "HIGH" in the initial settings.

(3) Audio recording

Displays "A" when audio recording has been set.

(4) Remaining time display

Unless "OVER WRITE" is set for recording, displays the remaining amount of recording time, as shown below.

Remaining time	Displayed increment	Example
1 hour or more	1 hour increments	1H
Less than 1 hour	10 minute increments	10M
Less than 10 minutes	1 minute increments	1M

(5) Date display (→P.13)

Shows the month/day/year.

05-20-03 (month-day-year)

(6) Time display (→P.13)

"00:00:00" is displayed when you turn the power ON for the first time. The digital video recorder uses the date and time to manage recording and playback points.

(7) Alarm display and alarm count display (→P.15)

When you set an alarm using the "Alarm recording" menu item, the alarm display area appears as shown below.

● Alarm display

When alarm recording is set, "Alarm" appears.

During alarm recording, the "Alarm" display flashes.

● Alarm count display

Displays the total number of alarms that have been generated.

(8) Name set for the digital video recorder

Displays the name set for the digital video recorder when it is controlled by a network.

Changing the position of the operating display

Press the [EXIT/OSD] button repeatedly.

Pressing the [EXIT/OSD] button repeatedly lets you move or erase the operation display area.

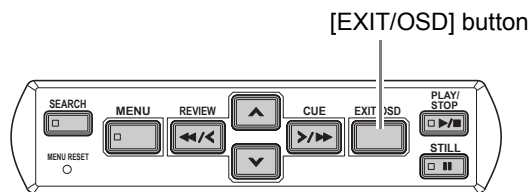

Normal screen

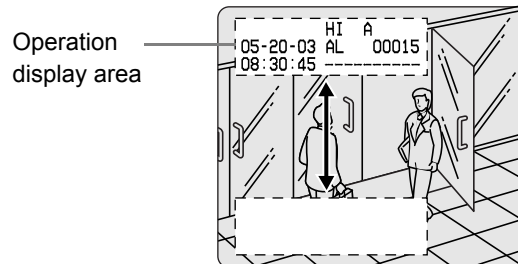

Playback screen

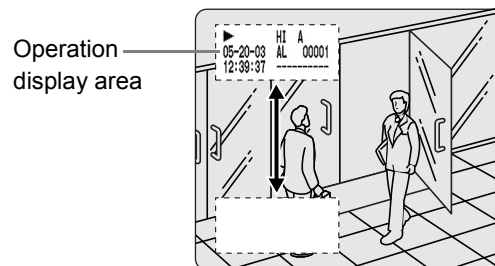

2 SETTING THE LANGUAGE/CLOCK

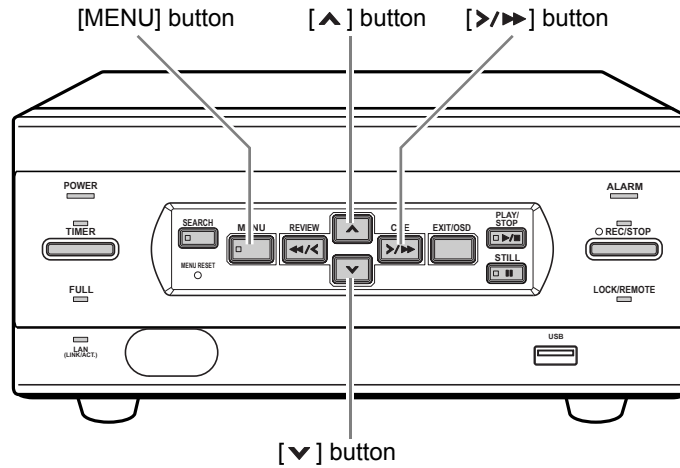

This section describes how to set the language displayed on the monitor and how to set the digital video recorder's internal clock.

[Settings] (◆ indicates initial setting.)

Item	Setting	Description
(1) LANGUAGE	◆ENGLISH	Sets the language to English.
	FRANCAIS	Sets the language to French.
	ESPAÑOL	Sets the language to Spanish.
(2) CLOCK SET		Sets the date and time.

1 Press the [MENU] button.

The [MENU] button lights, and the <MAIN MENU> screen appears.

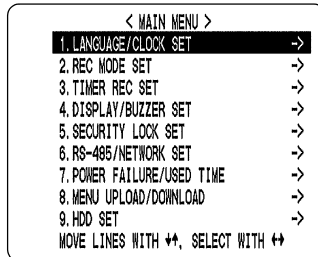

2 Select, "1. LANGUAGE/CLOCK SET", and press the [>/>>] button.

The <LANGUAGE/LANGUE/IDIOMA> screen appears. The cursor is positioned on ENGLISH.

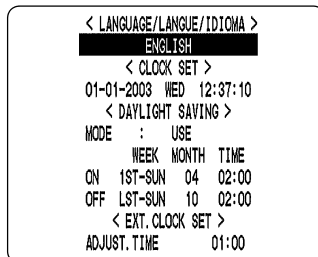

To change the language

3 Press the [>/>>] button, then the [v] or [^] button to select the desired language.

The set item flashes.

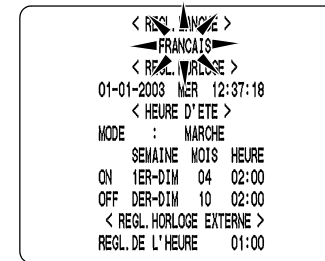

4 When you have made a selection, press the [>/>>] button.

The cursor moves to the date and time.

The language has now been set.

To return to the normal screen, press the [EXIT/OSD] button.

2 SETTING THE LANGUAGE/CLOCK

Setting the time

(Initial setting: 01-01-2003 WED 00:00:00)

Be sure to set the correct date and time. The digital video recorder stores the times of recordings for use in operations such as playback and search/playback.

Example: Setting May 20, 2003, 8:30 AM

- 3 Press the [▼] or [▲] button to move the cursor to the date and time under <CLOCK SET>.**

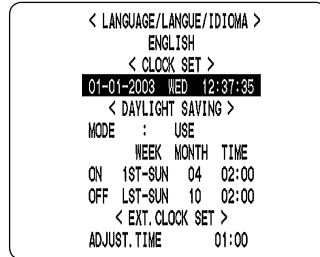

01-01-2003 WED 12:37:35
 MONTH DAY YEAR WEEK TIME

- 4 Press the [>/>>] button.**

"01" (indicating the month) flashes.

01 01-2003 WED 12:37:35

- 5 Press the [▼] or [▲] button to select "05".**

05 01-2003 THU 12:37:35

- 6 Press the [>/>>] button.**

"01" (indicating the day) flashes.

05 01 2003 THU 12:37:35

- 7 Use the same procedure to set the day (20 in this example), year (2003), hour (08) and minute (30)**

05-20-2003 TUE 08:30:00

When you have set the minute, the cursor moves to "MODE" under <DAYLIGHT SAVING>, and the clock starts from 00 seconds.

- "WEEK" is set automatically.
- The time is stopped during clock setting.

- 8 Press the [EXIT/OSD] button.**

The display returns to the normal screen.

3

NORMAL RECORDING/TIMER RECORDING

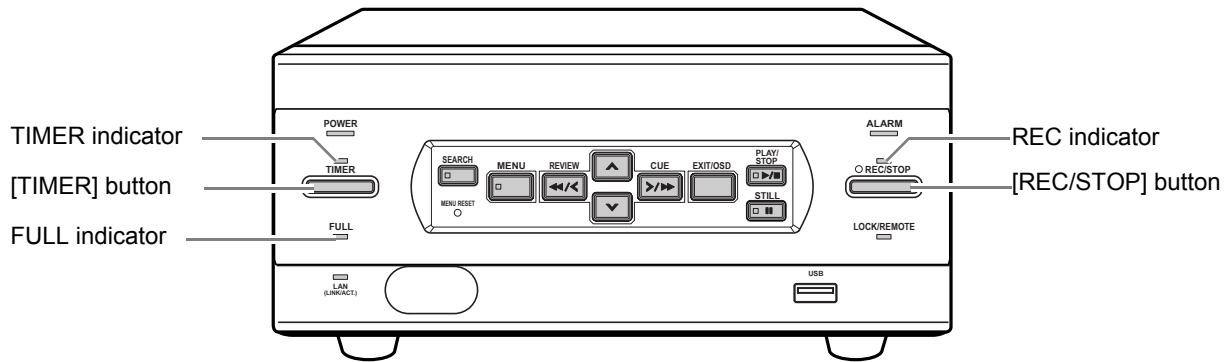

Normal recording

Follow the steps below to record the monitored image onto the hard disk.

1 Press the [REC/STOP] button.

The REC indicator lights. "●" (the recording symbol) appears on the screen, and recording starts.

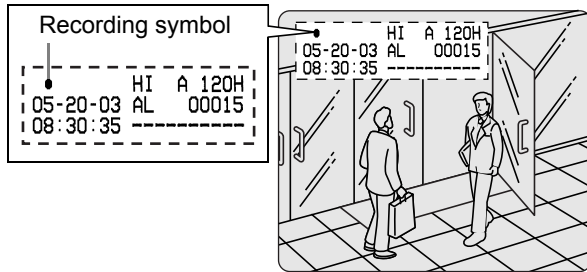

NOTE

- When you record for the first time, the initial settings are used. To change the image quality, see P.27.
- When the remaining space for recording reaches zero, recording ends and the FULL indicator lights. You can start recording from the beginning again by changing the "OVER WRITE" recording setting. (→P.27)
- You can record and play back images at the same time. See P.16 for the procedure.

Ending normal recording

2 Press the [REC/STOP] button for about 3 seconds.

The REC indicator goes out and recording stops.

Timer recording

Follow the steps on the right to record the monitored image onto the hard disk at the set time.

1 Press the [TIMER] button.

The TIMER indicator lights, and the digital video recorder enters timer recording standby mode.

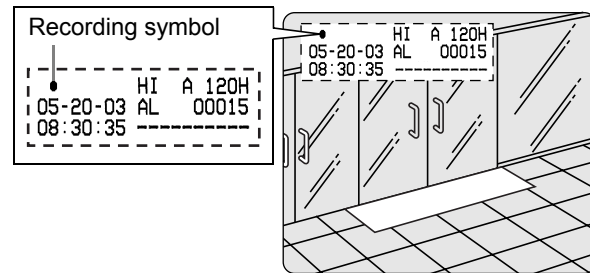

CAUTION

- A warning tone sounds if timer recording hasn't been set.
- (1) See P.29 for how to set timer recording.
 - (2) When the time specified in the timer settings arrives, the REC indicator lights, "●" (the recording symbol) appears in the screen, and recording starts.
 - (3) When the set end time arrives, the REC indicator goes out, and recording stops.

NOTE

- When the remaining memory space for recording reaches zero, recording ends, and the FULL indicator lights. You can start recording from the beginning again by changing the "OVER WRITE" setting. (→P.27)
- You can record and play back images at the same time. See P.16 for the procedure.

Stopping during timer recording

2 Press the [TIMER] button.

The [TIMER] indicator goes out and recording ends.

4 ALARM RECORDING

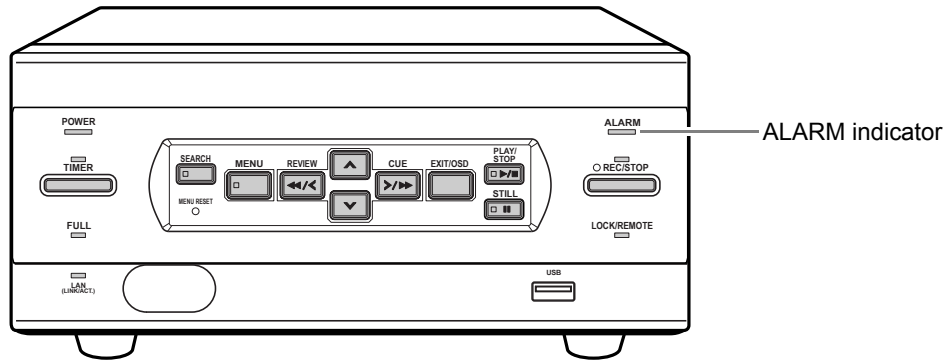

Alarm recording

Follow the steps below to have the digital video recorder record an alarm image only when alarm input is detected during recording.

CAUTION

- Check that the cable of the device required for alarms is connected to the ALARM terminal. (→P.8)

1 Set alarm recording.

The default settings are shown below. See P.27 for how to change these settings.

- **ALARM MODE: "ENABLED"**
Alarm recording is always performed, whether or not timer recording is set.
- **ALARM DURATION: "20SEC"**
Recording is performed for 20 seconds for each alarm signal received.

2 When alarm input is detected.

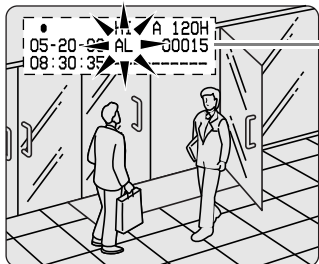

- When an alarm is received, "AL" flashes in the operation display area, the ALARM indicator flashes, and the alarm image is recorded.
- Each time an alarm is received, the alarm count in the operation display area is incremented by 1.

3 Ending alarm recording

When the alarm duration time (default setting: 20 seconds) ends, "AL" disappears from the operating display, the ALARM indicator stops flashing, and recording ends.

NOTE

- When the hard disk's remaining space for recording reaches zero, the FULL indicator lights and recording ends. You can start recording from the beginning again by changing the recording setting. (→P.27)

5 NORMAL RECORDING/TIMER RECORDING PLAYBACK

Follow the steps below to play back images recorded on the hard disk.

Playback

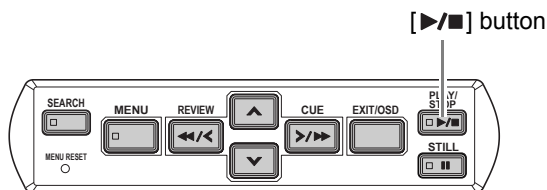

1 Press the [▶/■] button.

The [▶/■] button lights, and “▶” appears in the operation display area. The images stored in the normal recording area are played back.

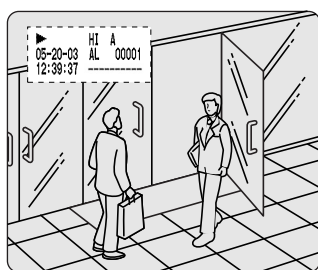

NOTE

- Image playback starts from the point at which recording started.
- If “OVER WRITE” has been set in the normal recording settings, playback starts with the oldest recorded image when the recording is played back for the first time.
- When playback ends, the digital video recorder pauses automatically. The stop display (■) appears in the operation display area, and the [■] button lights.
- After playback is stopped, it will resume from the stopped point the next time it is started.

Ending playback

2 Press the [▶/■] button.

Playback ends.

■ Playing back an image near the point of recording

The digital video recorder prioritizes recording operations, so the playback image may freeze temporarily.

Playback while fast-forwarding/rewinding

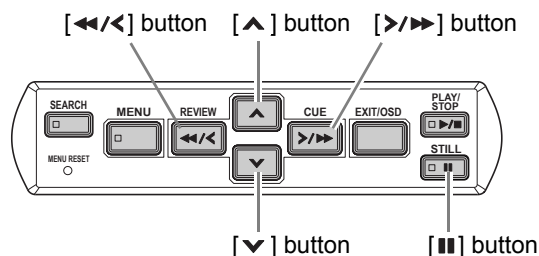

Press the [▶/■] or [◀/▶] button during playback or when a still image is displayed.

When you press the [▶/■] button, ▶ appears in the operating display, and the playback fast-forwards at 7.5 times the normal playback speed.

When you press the [◀/▶] button, ◀ appears in the operating display, and the playback fast-rewinds at 7.5 times the normal playback speed.

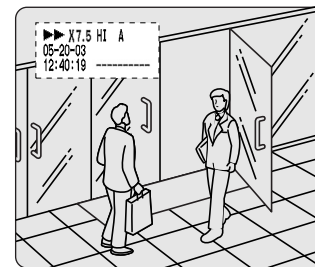

To change the fast-forward speed

Press the [▲] button while fast-forwarding.

Press the button once to increase the speed to 15 times the playback speed, twice to increase the speed to 30 times the playback speed, and 3 times to increase the speed to 180 times the playback speed.

To change the rewind speed

Press the [▼] button while rewinding.

Press the button once to increase the speed to 15 times the playback speed, twice to increase the speed to 30 times the playback speed, and 3 times to increase the speed to 180 times the playback speed.

Ending fast-forward/rewind

Press the [▶/■] button.

Normal playback starts.

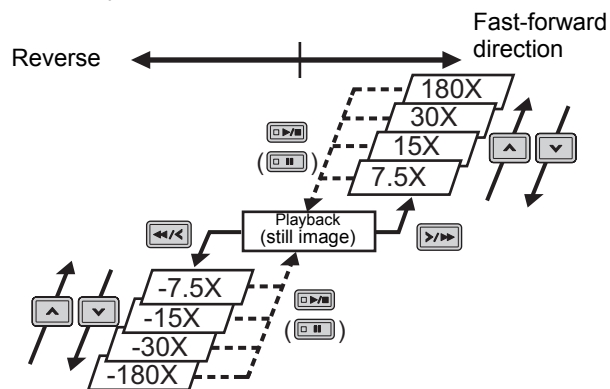

5 NORMAL RECORDING/TIMER RECORDING PLAYBACK

Viewing still images

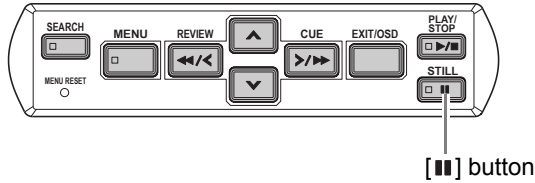

1 During playback, press the [|||] button.

The image becomes a still image (freezes).

||| appears in the operation display area.

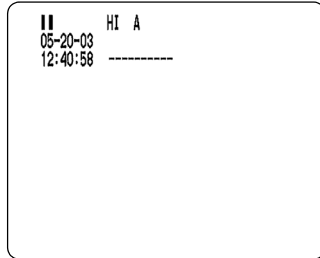

To resume playback

2 Press the [|||] button.

Frame advance (reverse)

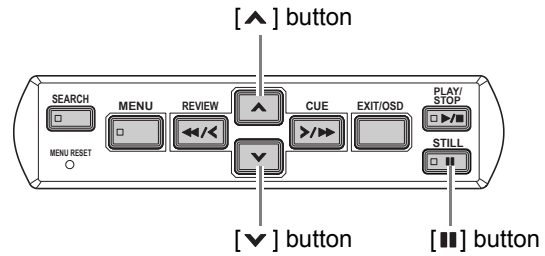

With a still image displayed, press the [^] button.

The still image advances by one frame.

Press the [v] button while a still image is displayed.

The still image moves back three frames.

Slow playback

Press the [^] button for at least 2 seconds.

The playback speed slows to 1/8 the normal speed.

Pressing the [^] button again switches the playback speed to 1/4 the normal speed.

Pressing the button twice switches the playback speed to 1/2 the normal speed.

Slow reverse playback

Press the [v] button for at least 2 seconds.

The playback speed slows to 1/8 the normal speed.

Pressing the [v] button again switches the playback speed to 1/4 the normal speed.

Pressing the button twice switches the playback speed to 1/2 the normal speed.

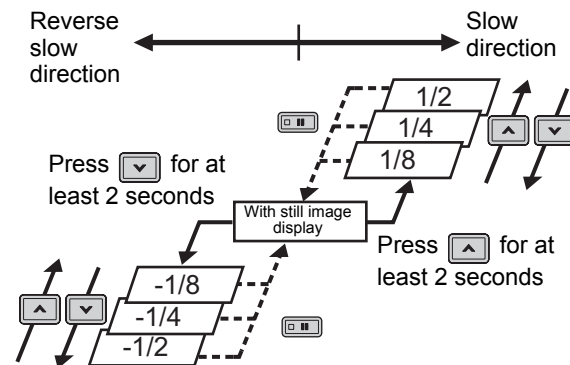

6 SEARCHING FOR RECORDED IMAGES

Images recorded on the hard disk can be searched and played back. There are two search methods available.

Image to search

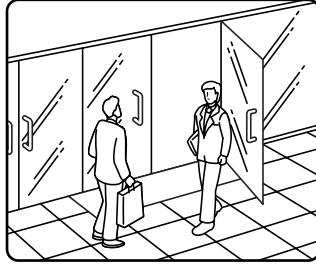

Search in <Search> screen

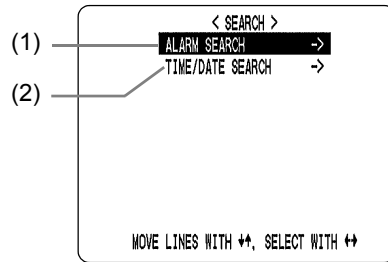

NOTE

- You can use the button operations to freeze, fast-forward or perform other operations on retrieved images being played back.

(9) Alarm search

Lets you search and play back alarm images from the recording list.

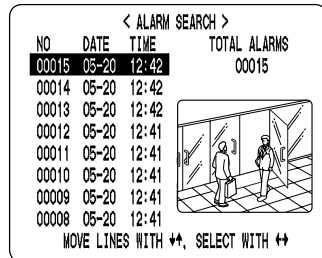

(10) Date/time search (→P.19)

Lets you search and play back recorded images by date/time.

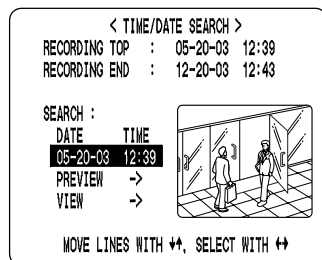

Alarm search

Lets you search and play back all the alarm images on the hard disk.

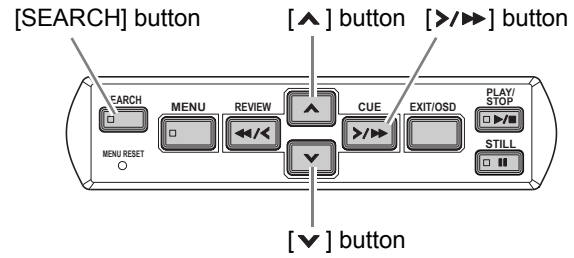

- Press the [SEARCH] button while the digital video recorder is recording or stopped.

The <ALARM SEARCH> screen appears.

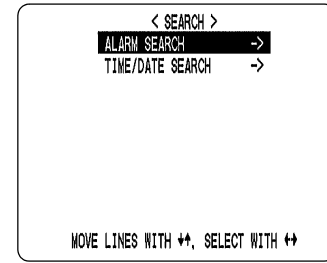

- Check that "ALARM SEARCH" is selected, and press the [>/>>] button.

The search screen appears.

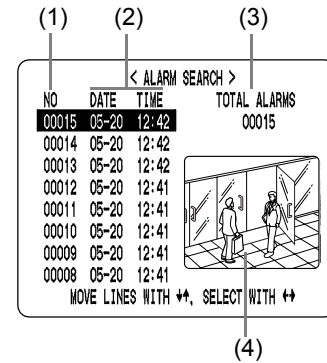

- NO: Displays the alarm number.
- DATE/TIME: Displays the date/time at which the alarm was received and the image recorded.
- Alarm count: Displays the total number of recorded alarm images.
- Preview screen: Displays the selected alarm image.

6 SEARCHING FOR RECORDED IMAGES

3 Press the [▼] or [▲] button to select the image to play back.

The selected alarm image is displayed in the preview screen. You can display up to 8 alarm images.

- **To display the next (previous) image**
Press the [▼] or [▲] button.
- **To display the items on the next page**
Press the [MENU] button. The next 8 items are displayed chronologically.
- **To end search mode**
Press the [EXIT/OSD] button.

4 Press the [▶/▶▶] button.

The image in the preview screen is displayed and played back on the entire screen.

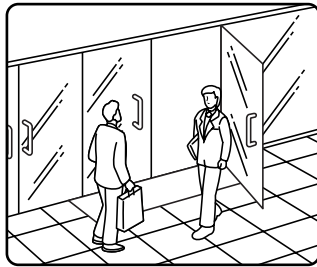

You can also jump to other pages by specifying the desired alarm number.

1 Press the [SEARCH] button.

The "Alarm No." input screen appears. The cursor is positioned in the input field.

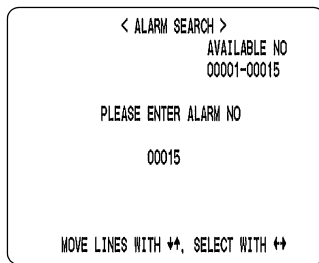

2 Enter the desired alarm number.

"AVAILABLE NO" indicates the numbers that can be searched. Enter the desired number from among the displayed numbers.

Press the [▲] and [▼] buttons to change the number. Press the [▶/▶▶] button to move the cursor.

PLEASE ENTER ALARM NO



3 Press the [▶/▶▶] button.

The page corresponding to the entered alarm number appears.

Date/time search

Follow the steps below to play back an image recorded on the hard disk by specifying its date and time.

[SEARCH] button [▲] button [▶/▶▶] button

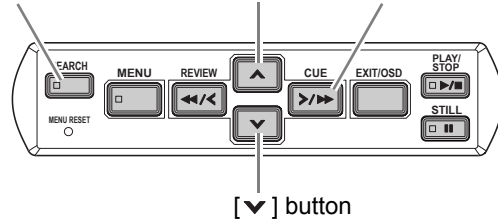

1 Press the [SEARCH] button while the digital video recorder is recording or stopped.

The <ALARM SEARCH> screen appears.

2 Press the [▼] or [▲] button to select "TIME DATE SEARCH".

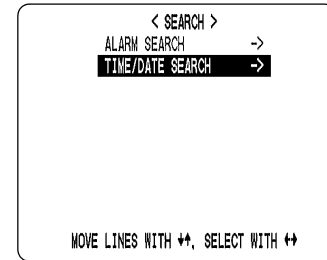

3 Press the [▶/▶▶] button.

The <TIME/DATE SEARCH> screen appears.

The cursor is positioned on the date and time item.

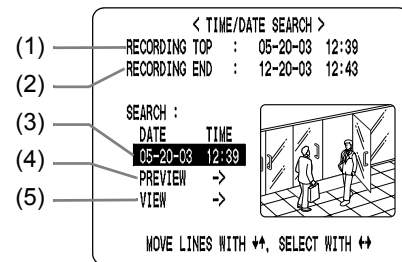

- (1) Recording start:
Displays the date/time of the image recorded first.
- (2) Recording end:
Displays the date/time of the image recorded last (latest image).
- (3) Search:
Enter the date/time of the image to play back.
- (4) Preview:
Select this item to display the preview screen.
- (5) Playback:
Select this item to play back the image on the entire screen.

6 SEARCHING FOR RECORDED IMAGES

4 Press the [>/▶] button, and set the date/time to search.

Example: To search for the image from October 26, 2003, 8:00 PM

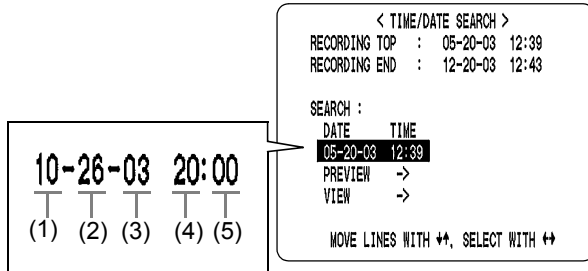

- (1) Press the [▼] or [▲] button to select "10" (October).
- (2) Press the [>/▶] button, and then the [▼] or [▲] button to select "26" (the day).
- (3) Press the [>/▶] button, then the [▼] or [▲] button to select "03" (the year).
- (4) Press the [>/▶] button, and then the [▼] or [▲] button to select "20" (the hour).
- (5) Press the [>/▶] button to select "00" (the minute), then press the [>/▶] button.
 The cursor moves to the preview.

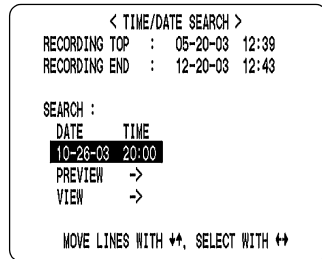

5 Press the [>/▶] button.

- **If no image exists for the specified time**
 The image for the time closest to the selected time is displayed.
- **To end search mode**
 Press the [EXIT/OSD] button.

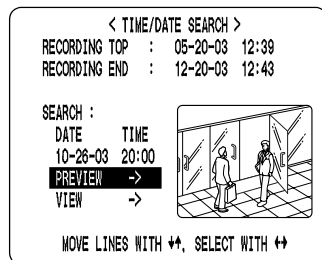

6 Press the [▼] button to select "VIEW", then press the [>/▶] button.

The image in the preview screen is played back on the entire screen.

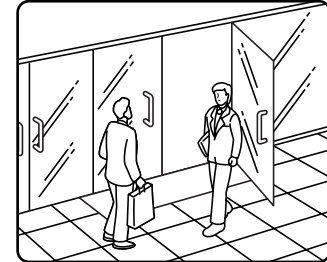

NOTE

- You can enter the desired date and time and select playback to display the retrieved image on the entire screen without showing it in the preview screen first.
- You can use the button operations to freeze, fast-forward or perform other operations on retrieved images being played back.

7

PREVENTING ACCIDENTAL OPERATION (KEY LOCK FUNCTION)

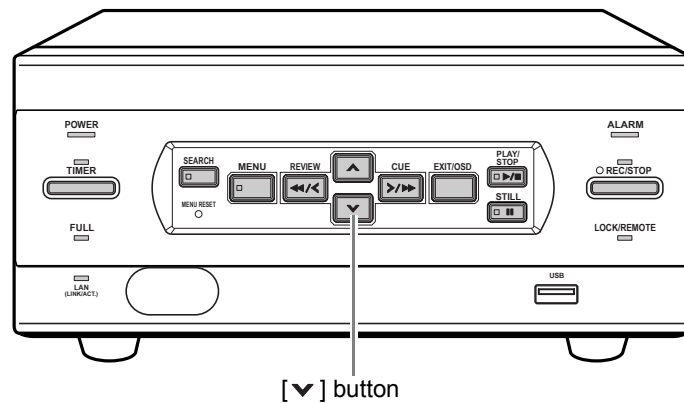

Follow the steps below to set the key lock function, preventing accidental pressing of the operation buttons.

Setting the key lock function

- 1 With the digital video recorder recording or stopped, press the [v] button for about 3 seconds.

When the key lock is set, a confirmation tone sounds, and the LOCK/REMOTE indicator lights.

NOTE

- The key lock setting is not released at power OFF.
- You cannot set the key lock during playback.

Releasing the key lock function

- 1 With the key lock function set, press the [v] button for about 3 seconds.

When the key lock is released, a confirmation tone sounds, and the LOCK/REMOTE indicator goes out.

CAUTION

- When the key lock function has been set, the buttons can't be used for settings or operations.
- When the security lock is set, you cannot set the key lock alone.
- If you have already set the security lock, the password entry screen appears. (→P.36)

MENU CONFIGURATION AND OPERATIONS

This section describes the menu configuration, and which menu item to select for each operation.

Displaying the menu screen and sub-menu screens

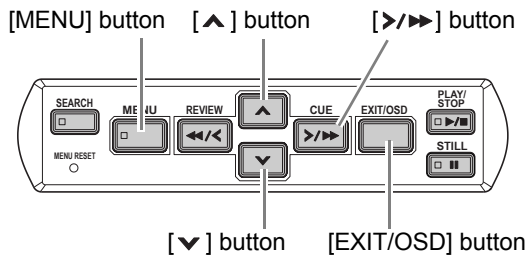

1 Press the [MENU] button.

The <MAIN MENU> screen appears.

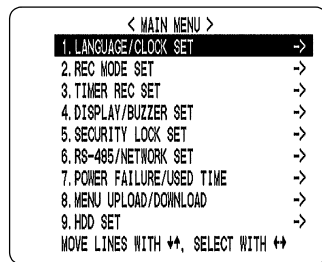

2 Press the [▼] or [▲] button to select the desired sub-menu.

(Example: Selecting "2. REC MODE SET")

When you move the cursor, the selected item is displayed in reverse.

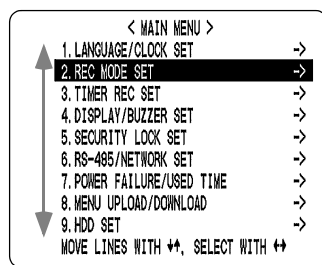

3 Press the [▶/▶▶] button.

The selected sub-menu appears.
The cursor is positioned on the first setting item.

To exit a menu screen

4 Press the [EXIT/OSD] button.

The display returns to the normal screen.

NOTE

- You can also display menu screens while recording.

CAUTION

- You can't change menu settings while recording.

Entering settings in sub-menu screens

In the sub-menu screen, use the [▲] [▼] [◀/▶] [▶/▶▶] buttons to enter the desired setting.

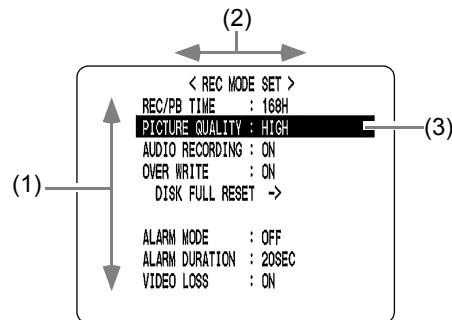

- To move the cursor up/down
Press the [▲] or [▼] button.
- To move the cursor right or to a setting item
Press the [▶/▶▶] or [◀/▶] button.
- To change a setting value
Press the [▲] or [▼] button.

To restore menu setting items to their initial values

Follow the steps below to restore just the currently displayed sub-menu items to their initial values.

1 Display the desired sub-menu screen.

2 Press the [MENU RESET] button.

The displayed settings are restored to their initial values.

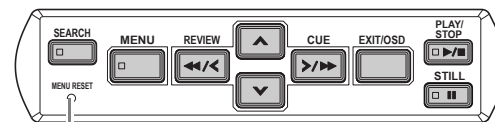

[MENU RESET] button

MENU CONFIGURATION AND OPERATIONS

Overview of sub-menus

The screens below are the sub-menu screens displayed by selecting items from the MAIN MENU. Pressing the [MENU] button while a sub-menu screen is displayed switches the display directly to the next sub-menu screen.

1. LANGUAGE/CLOCK SET (→P.24)

Enables the following settings:

- Screen display language
- Digital video recorder's date and time settings
- Daylight savings time settings
- Time synchronization with external devices

```
< LANGUAGE/LANGUE/IDIOMA >
ENGLISH
< CLOCK SET >
06-20-2003 TUE 12:37:35
< DAYLIGHT SAVING >
MODE : USE
WEEK MONTH TIME
ON 1ST-SUN 04 02:00
OFF LST-SUN 10 02:00
< EXT. CLOCK SET >
ADJUST. TIME 01:00
```

2. REC MODE SET (→P.27)

Lets you make settings for recording and alarms.

```
< REC MODE SET >
REC/PB TIME : 168H
PICTURE QUALITY : HIGH
AUDIO RECORDING : ON
OVER WRITE : ON
DISK FULL RESET ->

ALARM MODE : OFF
ALARM DURATION : 20SEC
VIDEO LOSS : ON
```

3. TIMER REC SET (→P.29)

Used for timer recording settings.

When you set the digital video recorder to record only on holidays, this sub-menu lets you set dates to specify as additional holidays.

```
< TIMER REC SET >
WEEK START STOP SET
SUN ---:--- ---:--- OFF
MON ---:--- ---:--- OFF
TUE ---:--- ---:--- OFF
WED ---:--- ---:--- OFF
THU ---:--- ---:--- OFF
FRI ---:--- ---:--- OFF
SAT ---:--- ---:--- OFF
DLY ---:--- ---:--- OFF
* HOLIDAY SET ->
```

4. DISPLAY/BUZZER SET (→P.32)

Lets you select the text to display in the operation display area. Also lets you sound the buzzer on the following occasions:

- During alarms
- When there is no more available recording space
- When the operation button is pressed
- When there is a hard disk problem
- When there is a fan problem
- When there is a recording problem.
- When there is "VIDEO LOSS"

```
< DISPLAY SET >
DATE/TIME : ON
QUALITY/AUDIO : ON
DVR NAME : OFF
ALARM COUNT : ON
< BUZZER SET >
ALARM ON : ON
DISK FULL : ON
KEY IN : OFF
WARNING : ON
NON REC : OFF
```

5. SECURITY LOCK SET (→P.34)

Lets you set passwords to prevent unauthorized users from operating the digital video recorder.

```
< SECURITY LOCK SET >
LEVEL PASSWORD(4-8) USE
ADMIN ----- OFF
USER ----- OFF
REC CONTROL : ADMIN
```

6. RS-485/NETWORK SET (→P.37)

Used to make the settings needed when connecting the digital video recorder to an external device by RS-485 interface, or to a PC via a network (LAN).

```
< NETWORK SET >
DVR NAME : -----
IP ADDRESS : 192.168. 0. 1

< RS-485 SET >
REMOTE AS : DVR
DATA SPEED : 19200
STATUS INFO : ON
ALARM INFO : ON
ADDRESS : 000
```

7. POWER FAILURE/USED TIME (→P.39)

Lets you check the date/time of power failures and the amount of hard disk operation time.

```
< POWER FAILURE >
FAILURE ----- -:--
RECOVER ----- -:--

< USED TIME >
DISK1 USE : 00011 H
DISK2 USE : ----- H
POWER : 00011 H

FIRMWARE : MAIN 0.02-01 / SUB 0.20-05
```

8. MENU UPLOAD/DOWNLOAD (→P.40)

Lets you save menu setting values onto a CompactFlash card. Also lets you read menu setting values saved on CompactFlash cards.

```
< MENU UPLOAD/DOWNLOAD >
DVR TYPE VER. SAHG-00
SAVE MENUS TO CF ->
LOAD MENUS FROM CF ->
COPY MIRRORING SETTINGS: NO
* IF YOU COPY MIRRORING SETTINGS,
HARD DISK MAY BE INITIALIZED I
```

9. HDD SET (→P.42)

Used to initialize (reformat) the hard disk. Also lets you set mirroring when a second hard disk has been added.

```
< HDD SET >
DISK1 : 120GB
DISK2 : ---GB
DISK INITIALIZE ->
CAUTION : ALL RECORDS WILL BE ERASED!

MIRRORING : OFF
NEXT ->
MOVE LINES WITH ++, SELECT WITH ↔
```

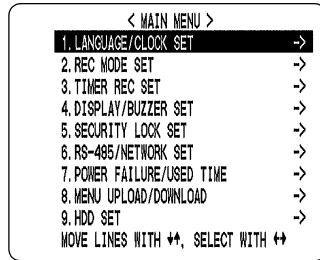

1 LANGUAGE/CLOCK SET

<MAIN MENU>

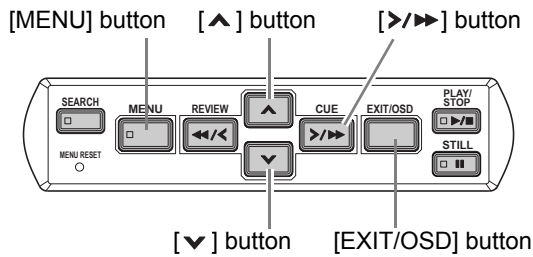

You can perform the following functions:
 Change the language used to display on-screen information.*
 Set the date and time displayed on the normal screen.*
 Set the clock to adjust automatically for daylight savings time.
 Set all the devices to the same time automatically when multiple devices are connected.
 * See P.12.

<DAYLIGHT SAVING> settings



1 Press the [MENU] button.

The [MENU] button lights, and the <MAIN MENU> screen appears.

2 Select "1. LANGUAGE/CLOCK SET", and press the [→/▶▶] button.

The <LANGUAGE/LANGUE/IDIOMA> screen appears with the cursor positioned on ENGLISH.

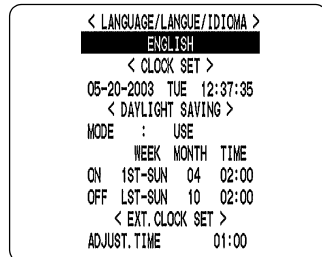

3 Press the [↓] or [↑] button to select "MODE" under <DAYLIGHT SAVING>.

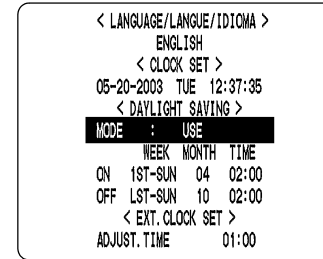

4 Press the [→/▶▶] button.

"USE" flashes.

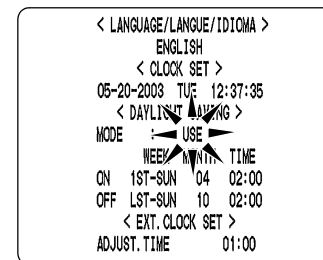

5 Press the [↓] or [↑] button to change the setting.

[Settings] (◆ indicates initial setting.)

◆USE	Time is automatically adjusted to daylight savings time.
NO USE	Time is not adjusted to daylight savings time.

6 Press the [→/▶▶] button.

The cursor moves to the date/time at which to switch from standard time to daylight savings time.

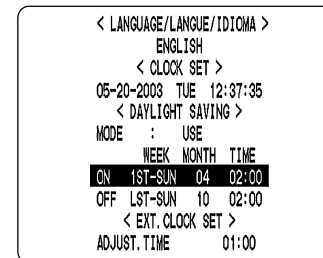

SETTINGS

1 LANGUAGE/CLOCK SET

When "USE" is selected for "MODE" under <DAYLIGHT SAVING>.

You can set the date/time at which the time is switched from standard time to daylight savings time, and the date/time at which the time is switched back again.

The example below is the default value.

Example:

After the clock display reaches April 6, 2003, 01:59, the next clock display is 03:00, putting the clock an hour ahead (daylight savings time).

After the clock display reaches October 26, 2003, 01:59, the next clock display is 01:00, putting the clock an hour behind (back to standard time).

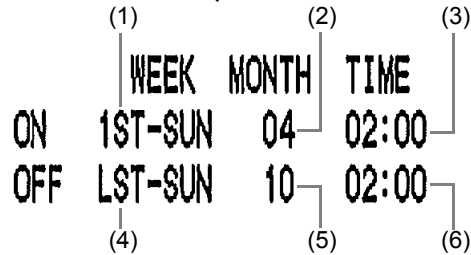

- (1) Sets the week for switching to daylight savings time.
- (2) Sets the month.
- (3) Sets the time.
- (4) Sets the week for ending daylight savings time.
- (5) Sets the month.
- (6) Sets the time.

7 Press the [>/>>] button.

The cursor moves to "1ST".

8 Press the [v] and [^] buttons to select the desired week, then press the [>/>>] button.

The cursor moves to "MONTH".

9 Press the [v] and [^] buttons to select the desired month, then press the [>/>>] button.

The cursor moves to "TIME".

10 Press the [v] and [^] buttons to select the desired time, then press the [>/>>] button.

The cursor moves to the minutes portion of the time. Set the desired minutes in the same manner.

The <DAYLIGHT SAVING> settings are now finished.

<EXT.CLOCK SET> settings

This section describes how to have the time synchronized automatically when two or more digital video recorders are connected. If you set the <EXT.CLOCK SET> time to 5:00, all the connected devices are synchronized to the same time (to the nearest second) every day at 5:00. (Default setting: 01:00)

1 Use a cable to connect the CLOCK ADJ terminal on the rear panel of one digital video recorder to the CLOCK ADJ terminal on the second digital video recorder.

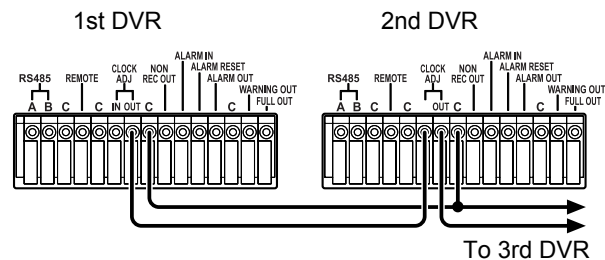

2 Press the [v] or [^] button to move the cursor to "ADJUST TIME".

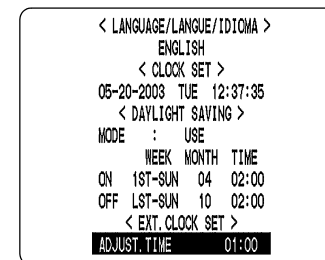

3 Press the [>/>>] button.

"01" flashes.

4 Press the [v] or [^] button to select the desired time, then press the [>/>>] button.

(Example: 05:00)

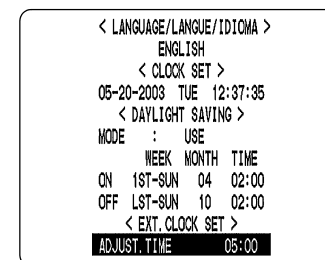

1 LANGUAGE/CLOCK SET

5 Press the [EXIT/OSD] button.

The display returns to the normal screen.

6 Use the same procedure to set the <EXT.CLOCK SET> time on the second digital video recorder.

When you have finished making the settings, the display returns to the normal screen.

- When the digital video recorder is connected to a PC or other external device through a network, you can also set the time from that device. When connected to a PC, see the instructions for the VA-SW800 application software.

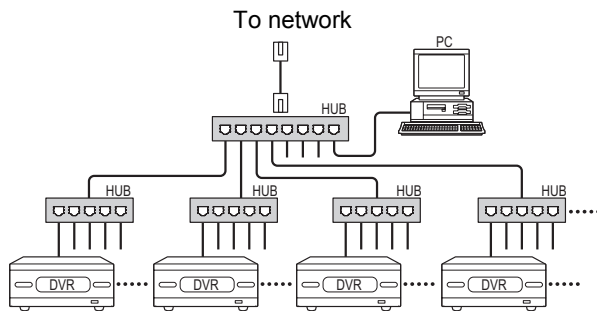

2 REC MODE SET

<MAIN MENU>

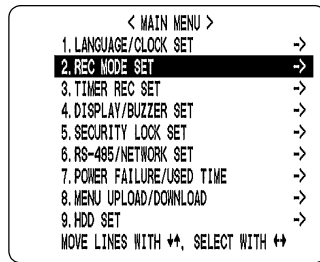

<REC MODE SET> setting items

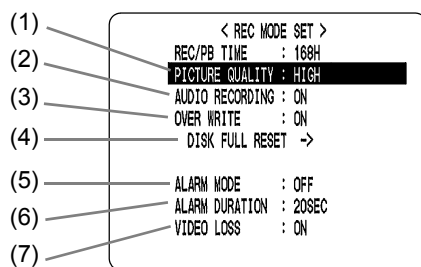

[Settings] (◆ indicates initial setting.)

Item	Setting	Description
(1) PICTURE QUALITY	SUPER	Highest image quality. Recording time: 84 hours or more (120 GB). 168 hours or more (240 GB).
	◆ HIGH	High image quality. Recording time: 168 hours or more (120 GB). 336 hours or more (240 GB).
	STANDARD	Standard image quality. Recording time: 336 hours or more (120 GB). 672 hours or more (240 GB).
(2) AUDIO RECORDING	◆ ON	Audio recording input
	OFF	No audio recording input
(3) OVER WRITE	◆ ON	When the hard disk runs out of space, recording automatically starts again from the beginning, recording over previously recorded images.
	OFF*	When the hard disk runs out of space, FULL indicator flashes and recording stops.
(4) DISK FULL RESET	NO	Images are not recorded over previously recorded images. The <WARNING> screen appears, and "NO" flashes.
	YES	Images can be recorded over previously recorded images once. The <WARNING> screen appears. Press the [▼] or [▲] button to select "YES".
(5) ALARM MODE	◆ OFF	No alarm recording
	ENABLED	Alarm recording is always performed, during timer recording or other recording.
	AL-REC ON TIMER	Alarm recording is only performed during timer recording.
	AL-REC OFF TIMER	Alarm recording is performed only during recording types other than timer recording.
	OLY AL-RC ON TMR	Alarm recording is performed only during timer recording. Normal recording is not performed.
(6) ALARM DURATION	Time selections: CC/5S/10S/20S(◆)/40S/1M/2M/3M/4M/5M/10M/15M Sets the amount of time for recording when a single alarm is received.	
(7) VIDEO LOSS	◆ ON	"VIDEO LOSS" is displayed on the screen when the camera image is interrupted. The WARNING SIGNAL is also output to a rear panel terminal.
	OFF	"VIDEO LOSS" is not displayed on the screen when the camera image is interrupted.

* When item (3) "OVER WRITE" is set to "OFF" and the hard disk becomes full, the digital video recorder performs the operation set by item (4) "DISK FULL RESET". For how to start recording again, see "Starting recording again when the FULL indicator lights" on page 28.

2 REC MODE SET

Settings

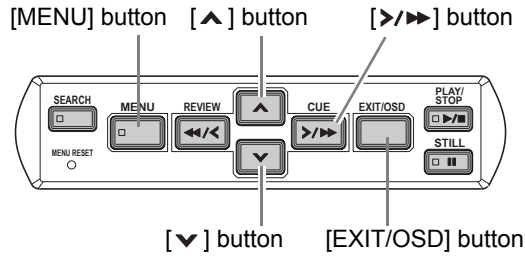

1 Press the [MENU] button.

The [MENU] button lights, and the <MAIN MENU> screen appears.

2 Select "2. REC MODE SET", and press the [>/>>] button.

The <REC MODE SET> screen appears.

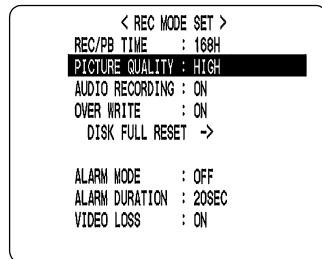

3 Press the [v] and [^] buttons to select the desired item, then press the [>/>>] button.

4 Press the [v] and [^] buttons to change the setting, then press the [>/>>] button.

5 Use the same procedure to set the other items as needed.

6 When you have finished making the settings, press the [EXIT/OSD] button.

The display returns to the normal screen.

Starting recording again when the FULL indicator lights

When "OVER WRITE" is set to "OFF" and the hard disk becomes full, the FULL indicator lights and recording stops. To start recording again, first follow the steps below to erase the images recorded so far.

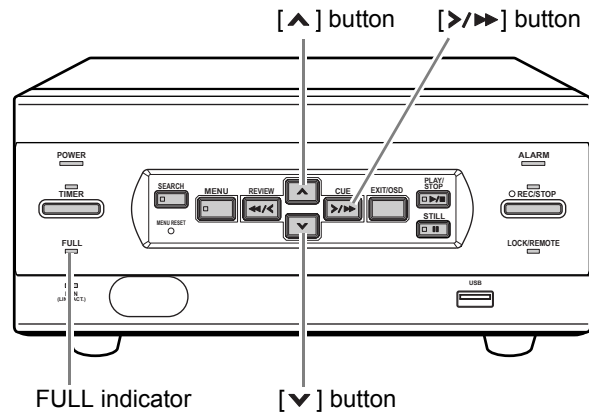

1 Display the <REC MODE SET> screen.

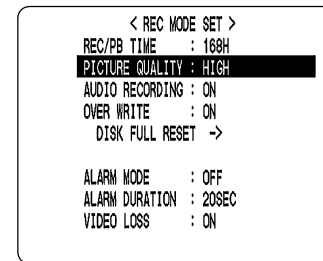

2 Press the [v] or [^] button to select "DISK FULL RESET", then press the [>/>>] button.

The <WARNING> screen appears with "NO" flashing.

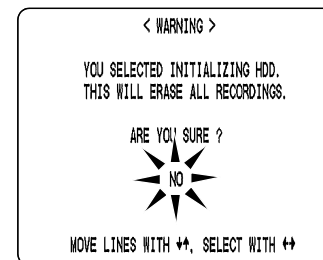

3 Press the [v] or [^] button to select "YES", then press the [>/>>] button.

The images recorded so far are erased, and the display returns to the normal screen.

The FULL indicator goes out, and you can record again until the disk becomes full.

3 TIMER REC SET

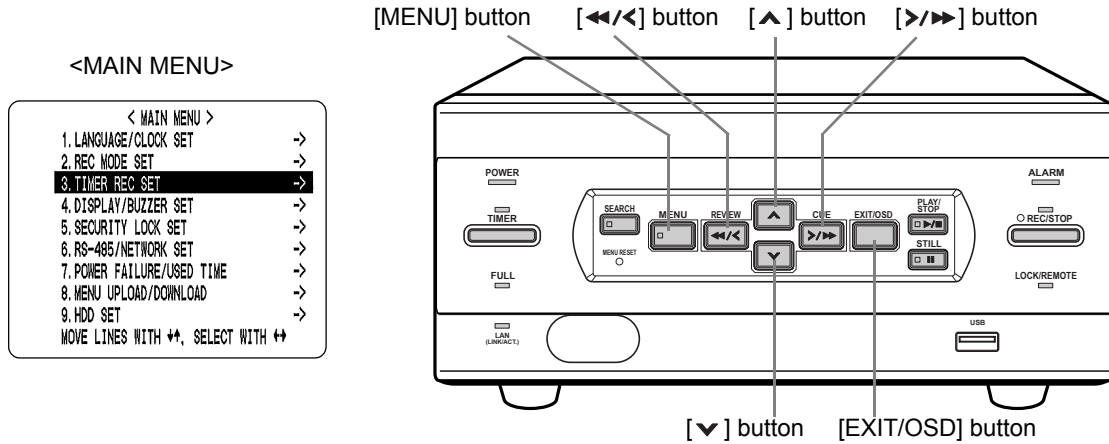

You can set recording start/stop times using the timer function.

Timer setting items

	(1)	(2)	(3)	(4)
	WEEK	START	STOP	SET
	SUN	--:--	--:--	OFF
	MON	--:--	--:--	OFF
	TUE	--:--	--:--	OFF
	WED	--:--	--:--	OFF
	THU	--:--	--:--	OFF
	FRI	--:--	--:--	OFF
(5)	SAT	--:--	--:--	OFF
	DLY	--:--	--:--	OFF
	* HOLIDAY SET			->

You can set times at which to start and stop recording on each specified day of the week.

- (1) WEEK
Used to select the days of the week for timer settings. When each day in the "WEEK" column is flashing, it can be set to other days. The 7th line (initially "SAT") and 8th line (initially "DLY") are used for timer recording settings of over 24 hours.
- (2) START
Enter the time at which to start timer recording.
- (3) STOP
Enter the time at which to stop timer recording.
- (4) ON/OFF
Setting "ON" enables the entered timer recording setting.
Setting "OFF" disables the entered timer recording setting.
- (5) Used for timer recording settings of over 24 hours
Use these lines for timer recording of over 24 hours.
- (6) For holiday settings (→P.31)

Timer reservations every day at the same time with the same image quality

Example:

Timer recording every day from 8:30 AM to 6:30 PM with the same recording speed

1 Press the [MENU] button.

The [MENU] button lights, and the <MAIN MENU> screen appears.

2 Select "3. TIMER REC SET", and press the [>/>>] button.

The <TIMER REC SET> screen appears.

	WEEK	START	STOP	SET
	SUN	--:--	--:--	OFF
	MON	--:--	--:--	OFF
	TUE	--:--	--:--	OFF
	WED	--:--	--:--	OFF
	THU	--:--	--:--	OFF
	FRI	--:--	--:--	OFF
	SAT	--:--	--:--	OFF
	DLY	--:--	--:--	OFF
	* HOLIDAY SET			->

3 Press the [>/>>] button once.

"SUN" under "WEEK" flashes.

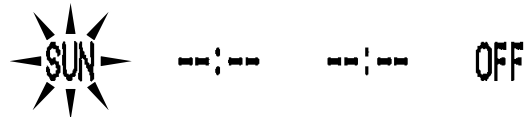

4 Press the [v] or [^] button to change "SUN" to "DLY".

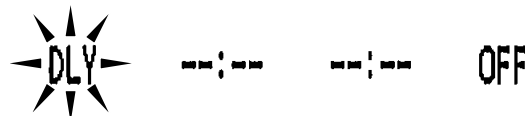

3 TIMER REC SET

5 Press the [➤/➤➤] button to move the cursor to the next item.

Each time you press the [➤/➤➤] button, the cursor moves to the following items:

Day → "START" time (hours, minutes) → "STOP" time (hours, minutes) → "ON"/"OFF".

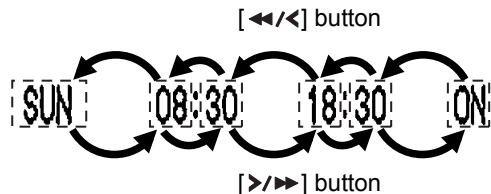

■ **To change a displayed setting item**

Press the [◀/◀] or [➤/➤➤] button to move the flashing area to the item you want to change, then press the [▼] or [▲] button to change the setting.

■ **Timer recording image quality**

The image quality used for recording is set by "PICTURE QUALITY" in the <REC MODE SET> sub-menu screen. (→P.27)

6 When finished making the settings, press the [EXIT/OSD] button.

The display returns to the normal screen.

■ **To set different recording times on each day of the week**

Set the desired recording times for each day.

■ **If timer reservation days overlap**

The timer reservation that starts first will have priority.

To cancel all timer reservations

1 With the <TIMER REC SET> screen displayed, press the [MENU RESET] button.

All the timer settings are erased.

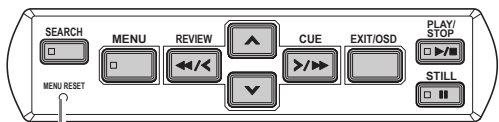

[MENU RESET] button

Timer reservations spanning more than 24 hours

This section describes how to use timer reservations to record for more than 24 hours. These settings are made using lines 7 (initially "SAT") and 8 (initially "DLY") of the <TIMER REC SET> screen.

Example:

Timer recording from 10:30 AM Monday to 8:30 PM Wednesday

1 Press the [▼] or [▲] button to move the cursor to the 7th line, then press the [➤/➤➤] button.

"SAT" in the "WEEK" column flashes.

You can change the setting of the flashing item.

< TIMER REC SET >			
WEEK	START	STOP	SET
SUN	--:--	--:--	OFF
MON	--:--	--:--	OFF
TUE	--:--	--:--	OFF
WED	--:--	--:--	OFF
THU	--:--	--:--	OFF
FRI	--:--	--:--	OFF
SAT	--:--	--:--	OFF
DLY	--:--	--:--	OFF
* HOLIDAY SET	->		

2 Set the items in the "WEEK" and "START" columns.

(1) Press the [▼] or [▲] button to change "SAT" to "MON", then press the [➤/➤➤] button.

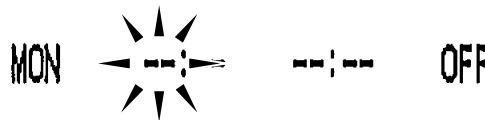

(2) Press the [▼] or [▲] button to change "--" to "10", then press the [➤/➤➤] button.

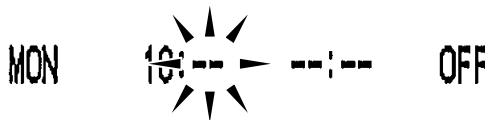

(3) Press the [▼] or [▲] button to change "--" to "30", then press the [➤/➤➤] button.

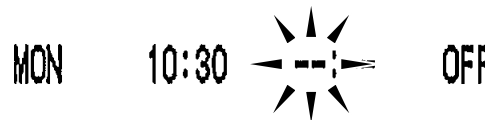

SETTINGS

3 TIMER REC SET

- 3** Press the [▼] or [▲] button to change the "STOP" time from "--:--" to "***:--", then press the [▶/▶▶] button.

The "DLY" item on the 8th line automatically changes to "TUE" (the day after the day set on the 7th line), and flashes. Items that don't need to be set are displayed as asterisks (*).

MON	10:30	**:*	***
TUE	**:*	--:--	OFF

- 4** Set the time at which to stop recording, by setting the day in the "WEEK" column, entering the "STOP" time and changing "OFF" to "ON".

MON	10:30	**:*	***
TUE	**:*	20:30	ON
(1)		(2) (3)	(4)

- Press the [▼] or [▲] button to change "TUE" to "WED", then press the [▶/▶▶] button.
- Press the [▼] or [▲] button to change "--" to "20", then press the [▶/▶▶] button.
- Press the [▼] or [▲] button to change "--" to "30", then press the [▶/▶▶] button.
- Press the [▼] or [▲] button to change "OFF" to "ON".

- 5** Press the [EXIT/OSD] button.

The display returns to the normal screen.

Setting holidays

You can set specific dates as holidays, to have the timer recording operation for Sunday used on those days. Dates such as national holidays and company off days should be set as holidays when you want those dates to have the same security as Sundays.

[Setting conditions]

Be sure to set "START" and "STOP" times for Sunday ("SUN") in the <TIMER REC SET> screen, and to set "ON" for that day. (→P.29)

Example: To set November 17 as a holiday

NOTE

- You can set up to 20 days as holidays.

- 1** Press the [▼] or [▲] button to select "HOLIDAY SET", then press the [▶/▶▶] button.

The <HOLIDAY SET> screen appears, with the cursor positioned on "1".

< TIMER REC SET >			
WEEK	START	STOP	SET
SUN	--:--	--:--	OFF
MON	--:--	--:--	OFF
TUE	--:--	--:--	OFF
WED	--:--	--:--	OFF
THU	--:--	--:--	OFF
FRI	--:--	--:--	OFF
SAT	--:--	--:--	OFF
DLY	--:--	--:--	OFF
* HOLIDAY SET			→

< HOLIDAY SET >	
1. 01-01	11. -----
2. -----	12. -----
3. -----	13. -----
4. -----	14. -----
5. -----	15. -----
6. -----	16. -----
7. -----	17. -----
8. -----	18. -----
9. -----	19. -----
10. -----	20. -----

- 2** Set the month and day in item No. 1.

- Press the [▶/▶▶] button to make "--" (the month) flash.
- Press the [▼] or [▲] button to set "--" to "11".
- Press the [▶/▶▶] button to make "--" (the day) flash.
- Press the [▼] or [▲] button to set "--" to "17".

1. 11-17
 (No.) (the (the day)
 month)

- 3** After entering the setting, press the [▶/▶▶] button.

The cursor moves to "2".

- 4** Use the same procedure to set other holidays as needed.

- 5** Press the [EXIT/OSD] button.

The display returns to the normal screen.

4 DISPLAY/BUZZER SET

<MAIN MENU>

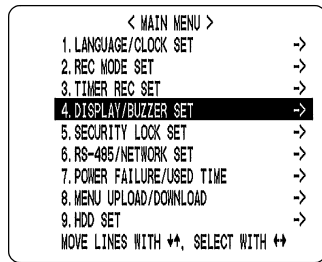

You can erase the date, time or other information from the operation display area of the playback screen. This sub-menu also lets you set a warning buzzer to sound for alarms or when the hard disk space reaches zero. You can set items to "OFF" as needed.

<DISPLAY/BUZZER SET> setting items

<SUB MENU>

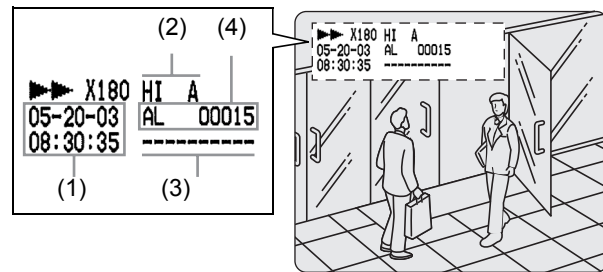
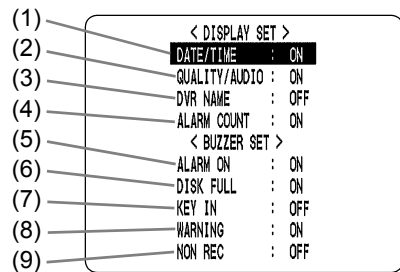

[Settings] (◆ indicates initial setting.)

	Item	Setting	Description
(1)	DATE/TIME	◆ ON	Display date/time in operating display area.
		OFF	Don't display date/time in operating display area.
(2)	QUALITY/AUDIO	◆ ON	Display picture quality and "A" (audio recording) in operation display area.
		OFF	Don't display picture quality or "A" (audio recording) in operation display area.
(3)	DVR NAME	ON	Display name set for digital video recorder.
		◆ OFF	Don't display name set for digital video recorder.
(4)	ALARM COUNT	◆ ON	Display current alarm count in operating display area.
		OFF	Don't display current alarm count in operating display area.
(5)	ALARM ON	◆ ON	Sound buzzer when alarm is received.
		OFF	Don't sound buzzer when alarm is received.
(6)	DISK FULL	◆ ON	When "OVER WRITE" is not set, sound buzzer when remaining hard disk space reaches zero.
		OFF	When "OVER WRITE" is not set, don't sound buzzer when remaining hard disk space reaches zero.
(7)	KEY IN	ON	Sound buzzer when operation button is pressed.
		◆ OFF	Don't sound buzzer when operation button is pressed.
(8)	WARNING	◆ ON	The buzzer sounds in the following cases: Hard disk drive error. Fan error. Recording error. No input signal (camera image interrupted) when VIDEO LOSS is ON.
		OFF	Don't sound buzzer in the following cases: Hard disk drive error. Fan error. Recording error. No input signal (camera image interrupted) when VIDEO LOSS is ON.
(9)	NON REC	ON	Sound buzzer when recording stops, or when recording is intentionally stopped without releasing the lock.
		◆ OFF	Don't sound buzzer when recording stops.

4 DISPLAY/BUZZER SET

Settings

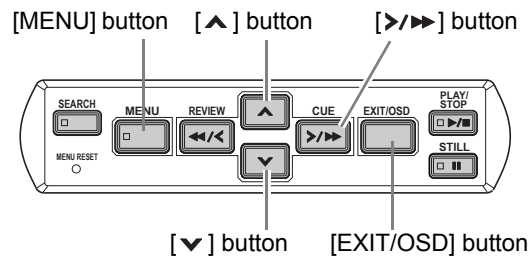

1 Press the [MENU] button.

The [MENU] button lights, and the <MAIN MENU> screen appears.

2 Select "4. DISPLAY/BUZZER SET", and press the [>/>>] button.

The <DISPLAY/BUZZER SET> screen appears.

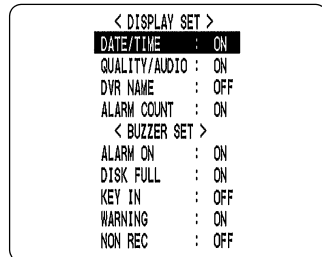

3 Press the [v] and [^] buttons to select the desired function, then press the [>/>>] button.

4 Press the [v] and [^] buttons to change the setting, then press the [>/>>] button.

5 Use the same procedure to set the other functions as needed.

6 When you have finished making the settings, press the [EXIT/OSD] button.

The display returns to the normal screen.

5 SECURITY LOCK SET

<MAIN MENU>

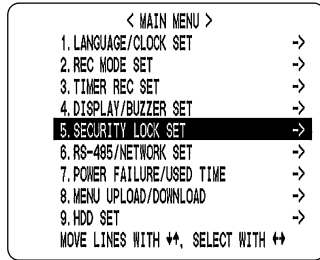

You can set passwords that restrict use of the digital video recorder to administrators and designated users, preventing unauthorized operation. When the security lock is set, a buzzer sounds when an unauthorized user presses any of the digital video recorder's operation buttons. Be sure to make a note of the set passwords.

Password setting example

Two password types can be set, one for administrators and one for users. The table below gives example password setting combinations, and lists how the digital video recorder operates for each.

Setting example	Password	Operation
LEVEL PASSWORD (4-8) USE ADMIN 123456AB ON USER AB123456 ON REC CONTROL :ADMIN	No password is entered.	All operations are locked.
	User enters password.	Only playback operations can be performed.
	Administrator enters password.	All operations can be performed.
ADMIN 123456AB ON USER AB123456 ON REC CONTROL :USER	No password is entered.	All operations are locked.
	User enters password.	Only playback and recording operations can be performed.
	Administrator enters password.	All operations can be performed.
ADMIN 123456AB ON USER ----- OFF REC CONTROL :ADMIN	No password is entered.	Only playback operations can be performed.
	Administrator enters password.	All operations can be performed.
ADMIN 123456AB ON USER ----- OFF REC CONTROL :USER	No password is entered.	Only playback and recording operations can be performed.
	Administrator enters password.	All operations can be performed.
ADMIN ----- OFF USER ----- OFF REC CONTROL :ADMIN	No setting (Default value)	All operations can be performed.
ADMIN ----- OFF USER ----- OFF REC CONTROL :USER	No setting (Default value)	All operations can be performed.

Password setting

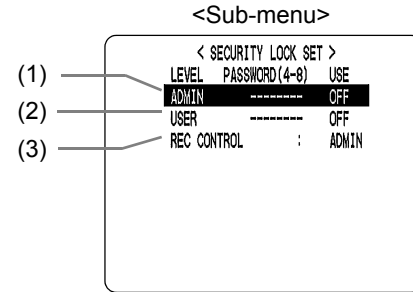

Item	Setting	Description
(1) ADMIN	ON	Used to set password for administrators. Also enables password setting.
	OFF	Disables password setting.
(2) USER	ON	Used to set password for users. Also enables password setting.
	OFF	Disables password setting.
(3) REC CONTROL	ADMIN	Sets authorization for recording operation to "ADMIN" (administrators).
	USER	Sets authorization for recording operation to "USER" (users).

Setting passwords

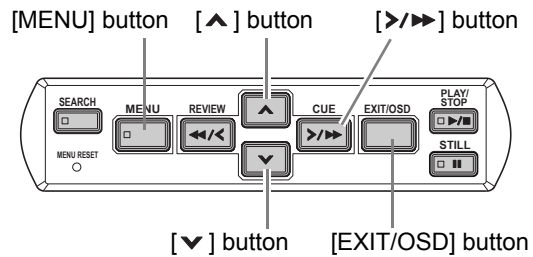

Passwords can be between 4 and 8 alphanumeric characters.

Characters that can be entered in passwords: 0 to 9, A to Z

Example: Setting "123456AB" as a password

1 Press the [MENU] button.

The [MENU] button lights, and the <MAIN MENU> screen appears.

2 Select "5. SECURITY LOCK SET", and press the [>>>] button.

The <SECURITY LOCK SET> screen appears. The cursor is positioned on "ADMIN".

! CAUTION

- "LEVEL PASSWORD (4-8) USE" at the top of the screen is the screen title. You can't move the cursor to this item.

5 SECURITY LOCK SET

3 Press the [➤/➤➤] button.

The first password entry bar “-” flashes.



4 Press the [▼] and [▲] buttons to select the character to enter.

Example:

Selecting “1”

5 Press the [➤/➤➤] button.

The second password entry bar flashes.



6 Use the same procedure to enter the remaining digits (“23456AB” in this example).



NOTE

- To set a 4-digit password
When you have entered four digits, and the fifth password entry bar is flashing, press the [➤/➤➤] button.

7 When you have entered the password, press the [➤/➤➤] button.

The cursor moves to “OFF” (flashing).

8 Press the [▼] and [▲] buttons to select “ON”.

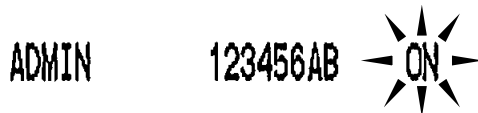

CAUTION

- If you select “OFF” for the “ADMIN” setting, you can’t set the “USER” password.

9 When you have finished making the setting, press the [➤/➤➤] button.

The cursor moves to “USER”.

If you don’t want to set a user password, the password setting is now finished.

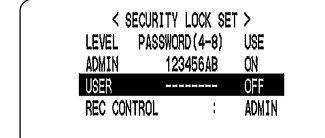

Press the [➤/➤➤] button to move the cursor to “REC CONTROL”, to set the authorization for recording and playback operation. (→P.36)

Setting the user password

Example: Setting “AB123456”

1 Press the [▼] and [▲] buttons to move the cursor to “USER”.

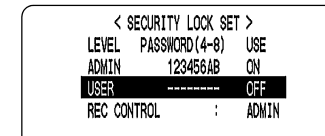

2 Press the [➤/➤➤] button.

The first password entry bar “-” flashes.

(Example: A)

Press the [▲] and [▼] buttons to select “A”.

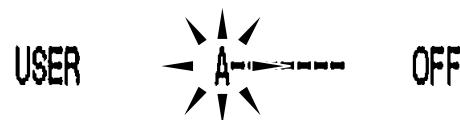

3 Press the [➤/➤➤] button.

The second password entry bar flashes.

Press the [▼] and [▲] buttons to select “B”.

Use the same procedure used to set the administrator password to enter the remaining digits (“123456” in this example).

5 SECURITY LOCK SET

4 When you have finished making the setting, press the [>/▶▶] button.

The cursor moves to "OFF" (which flashes).



5 Press the [▼] and [▲] buttons to select "ON", then press the [>/▶▶] button.

The cursor moves to "REC CONTROL".

Setting the authorization for recording and playback operations

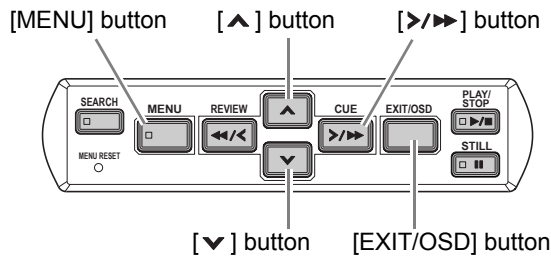

1 Press the [▼] and [▲] buttons to move the cursor to "REC CONTROL".

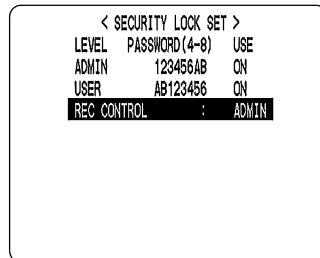

2 Press the [>/▶▶] button.

3 Press the [▼] and [▲] buttons to select "ADMIN" or "USER".

The setting is now finished.

4 Press the [EXIT/OSD] button.

The display returns to the normal screen.

Setting the security lock

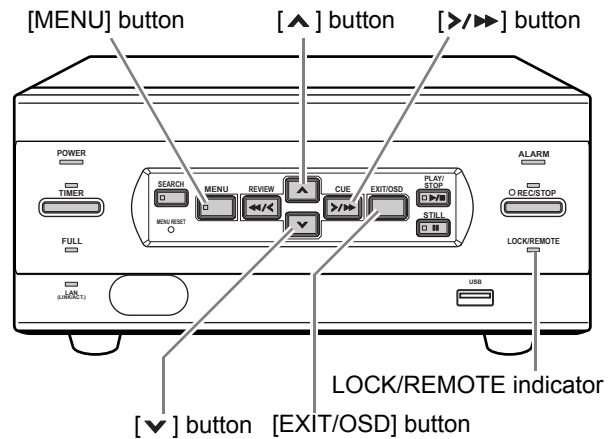

1 With the normal monitoring screen displayed, press the [▼] button for about 3 seconds.

A confirmation tone sounds, the LOCK/REMOTE indicator lights, and the security lock is set.

2 To check the security lock, press any button.

The password entry screen appears for about 5 seconds.



3 While the password entry screen is displayed, enter the password.

Enter the password using the [▼], [▲] and [>/▶▶] buttons.

! CAUTION

- Enter the password set for administrators or users (such as "123456AB").

123456AB

4 Press the [>/▶▶] button.

The setting is now finished.

The LOCK/REMOTE indicator goes out, and the display returns to the normal screen.

6 RS-485/NETWORK SET

This section describes how to make the RS-485 terminal connections/settings needed to connect to an external device, and how to make the network connections needed to connect to a PC.

Network connections and settings

You can make digital video recorder menu settings and monitor images from a PC via a network (LAN). To do so, connect an Ethernet cable to the LAN terminal on the digital video recorder's rear panel.

- To connect a PC directly
(Do not use an Ethernet hub.)

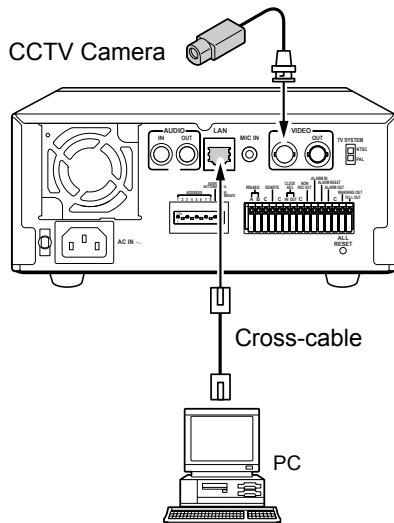

- To connect to an intranet
(Use an Ethernet hub.)

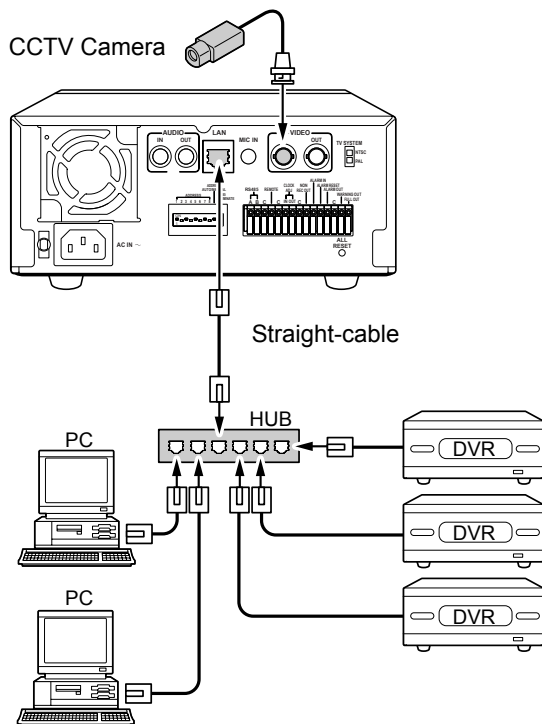

Settings for connecting to a PC or network

■ When setting the IP address automatically in the PC

Set dip switch No. 9 to the top position. The IP address will be set automatically.

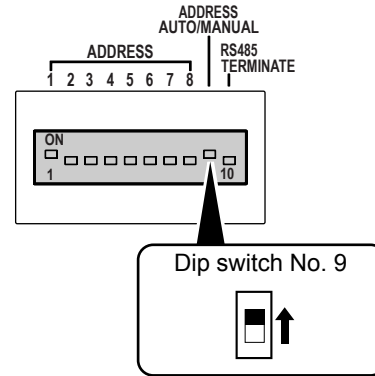

■ When setting the IP address on the digital video recorder

Set the least significant byte of the address (rightmost byte of "192.168.0.1") on the dip switches. You can set a value between 1 and 250. Other settings are read as 250.

- (1) Set dip switch No. 9 to the bottom position.
The IP address set manually on the other dip switches will be used.

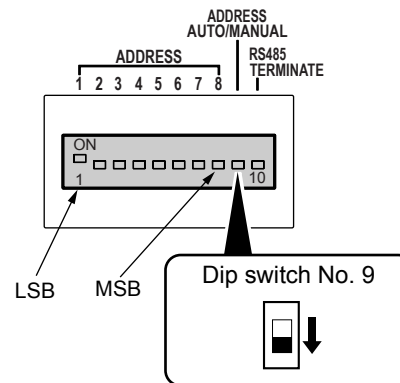

- (2) Use dip switch Nos. 1 to 8 to set the least significant byte of the IP address as a binary number. Setting a dip switch to the top position sets that bit to "1". Setting a dip switch to the bottom position sets that bit to "0".

Example :	MSB	LSB	Set IP Address
	↓	↓	↓
	00000001	1
	00000010	2
	00000011	3
	00000100	4

6 RS-485/NETWORK SET

! CAUTION

- When connecting the digital video recorder to a network, check the IP address with the network administrator.
- Up to 250 digital video recorders can be connected with manually-set IP addresses. To connect more digital video recorders, you must use automatic IP address settings.

The set IP address is displayed in the <NETWORK SET> screen.

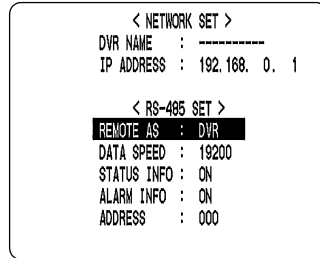

RS-485 connections and settings

Connect the digital video recorder's RS-485 (A, B) control terminals in series to the system controller, hard disk digital recorder or similar device.

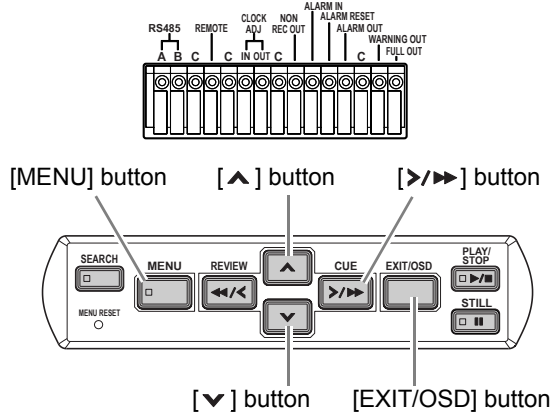

1 Press the [MENU] button.

The [MENU] button lights, and the <MAIN MENU> screen appears.

2 Select "6. RS-485/NETWORK SET", and press the [right arrow] button.

The <NETWORK SET> screen appears.

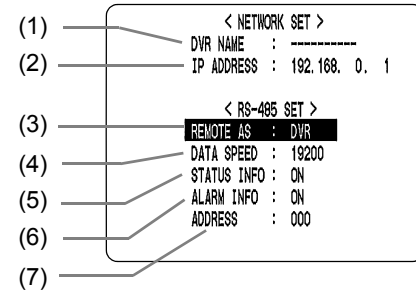

[Settings] (◆ indicates default setting.)

Item	Setting	Description
(1) DVR NAME	Display only	When remote operations software (sold separately) is in use, displays the name of the digital video recorder set in the PC.
(2) IP ADDRESS	Display only	Displays the set address number.
(3) REMOTE AS	VCR	When the digital video recorder is operated from a controller, sets it to operate as a VCR.
	◆ DVR	When the digital video recorder is operated from a controller, sets it to operate as a digital video recorder.
(4) DATA SPEED		Used to select the communication speed. Selections: 19200/2400/4800/9600
(5) STATUS INFO	ON	Enables status information to be sent on the RS-485 line.
	◆ OFF	Not set
(6) ALARM INFO	ON	Enables alarm information to be sent on the RS-485 line.
	◆ OFF	Not set
(7) ADDRESS*	Display only	Displays a number between 0 and 127, based on the IP address set by the dip switches. When connecting multiple recorders, each must have a unique address.

* Values above 127 can be set as the IP address on the dip switches (a setting of 0 or above 250 is read as 250), but only the least significant 7 bits (a value between 0 and 127) are read as the RS-485 address.

3 Press the [down arrow] and [up arrow] buttons to select the desired item, then press the [right arrow] button.

4 Press the [down arrow] and [up arrow] buttons to change the setting, then press the [right arrow] button.

5 Use the same procedure to set the other items as needed.

6 When you have finished making the settings, press the [EXIT/OSD] button.

The display returns to the normal screen.

7

POWER FAILURE/USED TIME

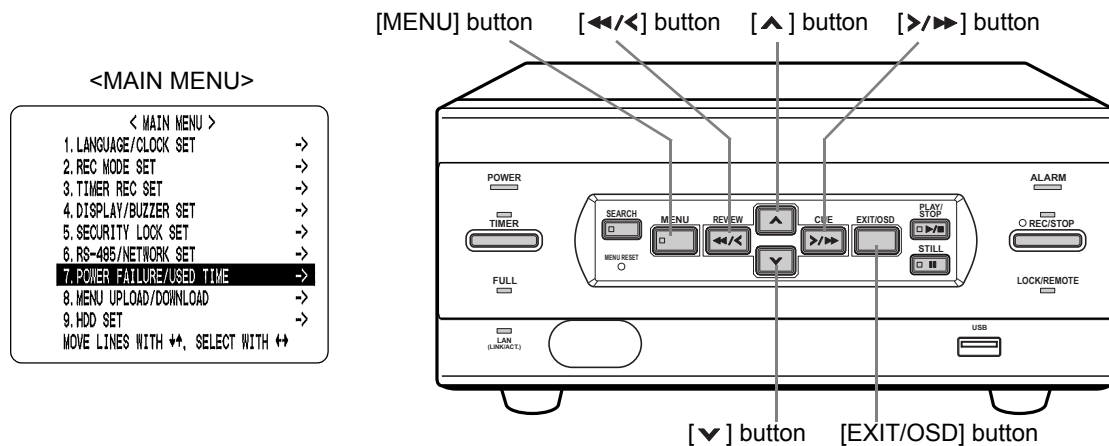

You can check the date/time of power failures and the amount of hard disk operation time.

1 Press the [MENU] button.

The [MENU] button lights, and the <MAIN MENU> screen appears.

2 Select "7. POWER FAILURE/USED TIME", and press the [>/>>] button.

The <POWER FAILURE> screen appears.

Use this screen to check the date/time of power failures and the amount of hard disk operation time.

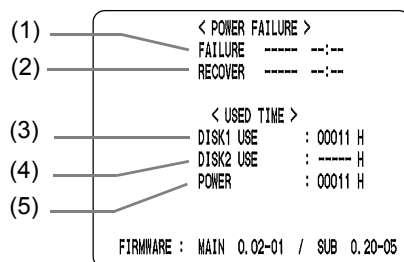

- (1) FAILURE
Displays the date/time at which a power failure occurred.
The number on the left is the number of power failures (example: #020). Resets to "000" after exceeding "999".
- (2) RECOVER
Displays the time at which the power was restored.
- (3) DISK1 USE
Displays the total amount of disk 1 operation time.
- (4) DISK2 USE
Displays the total amount of disk 2 operation time (when second disk has been added).
- (5) POWER
Displays the amount of power ON time for the digital video recorder.

3 Press the [EXIT/OSD] button.

The display returns to the normal screen.

8 MENU UPLOAD/DOWNLOAD

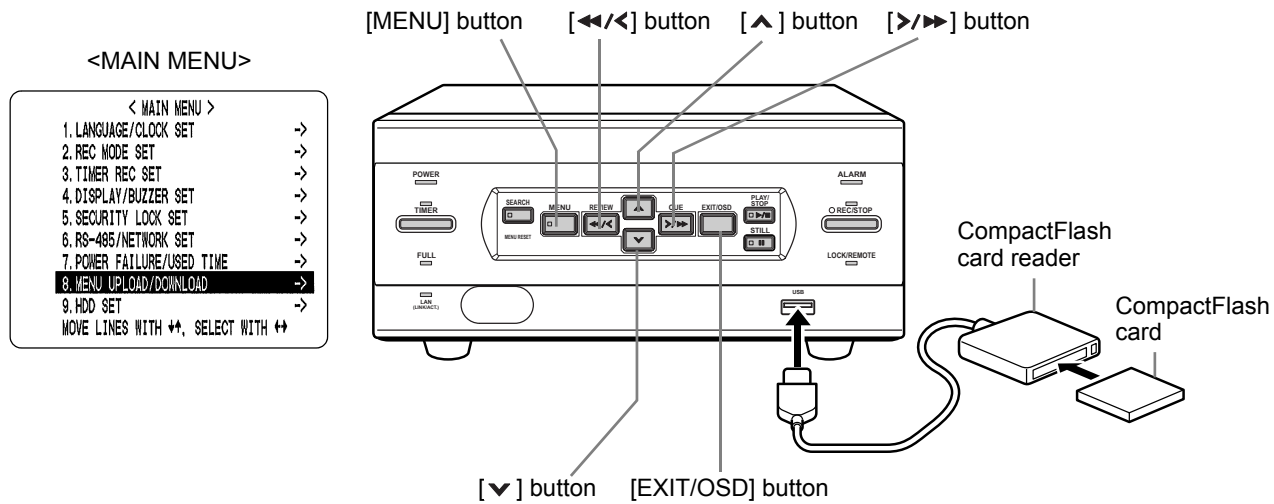

You can save menu setting values onto a CompactFlash card. This sub-menu also lets you read menu setting values saved on CompactFlash cards.

! CAUTION

- If “COPY MIRRORING SETTINGS” is set to “YES”, the hard disk may be initialized. If you don't want to initialize the hard disk, select “NO”.
- Do not turn the power OFF when saving/loading menu items to/from a CompactFlash card.
- Confirm that the light on the CompactFlash card reader is lit before using the card reader with the USB terminal. If used before the light is lit, SAVE and LOAD may not be recognized.
- When the menu cannot be saved to the CompactFlash card consecutively, remove the CompactFlash card, reinsert and try again.

NOTE

- At least 2 KB of available memory space is needed on the CompactFlash card.
- The file name is “M800MENU.txt”.

Settings

You will need a CompactFlash card reader and CompactFlash card (commercially available).

1 Press the [MENU] button.

The [MENU] button lights, and the <MAIN MENU> screen appears.

2 Select “8. MENU UPLOAD/ DOWNLOAD”, and press the [▶/▶▶] button.

The <MENU UPLOAD/DOWNLOAD> screen appears. The cursor is positioned on “SAVE MENUS TO CF”.

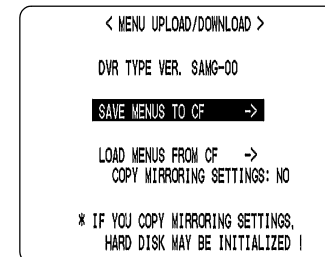

The following two procedures describe the “SAVE MENUS TO CF” and “LOAD MENUS FROM CF” items.

8 MENU UPLOAD/DOWNLOAD

To download menu items

1 Press the [➤/▶▶] button.

The <WARNING> screen appears.
"NO" flashes.

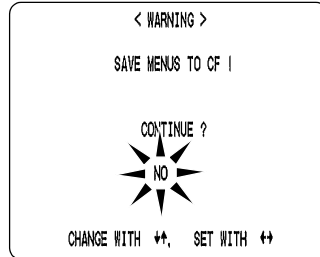

2 Press the [▼] and [▲] buttons to select "YES", then press the [➤/▶▶] button.

Downloading starts.

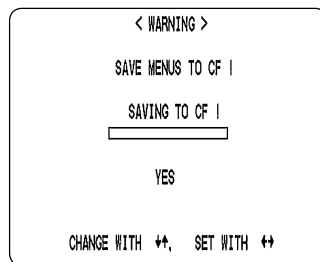

When you have finished loading, the display returns to the <MENU UPLOAD/DOWNLOAD> screen.

To upload menu items

1 Press the [▼] and [▲] buttons to select "LOAD MENUS FROM CF", then press the [➤/▶▶] button.

The <WARNING> screen appears.
"NO" flashes.

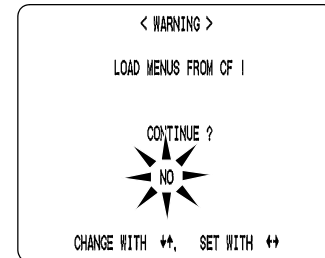

2 Press the [▼] and [▲] buttons to select "YES", then press the [➤/▶▶] button.

Uploading starts.

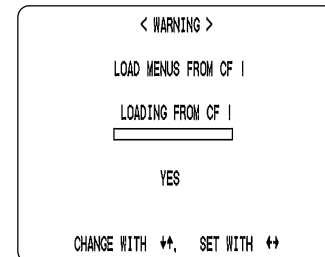

When you have finished saving, the display returns to the <MENU UPLOAD/DOWNLOAD> screen.

To exit

3 Press the [EXIT/OSD] button.

The display returns to the normal screen.

9 INITIALIZE/ADD HDD

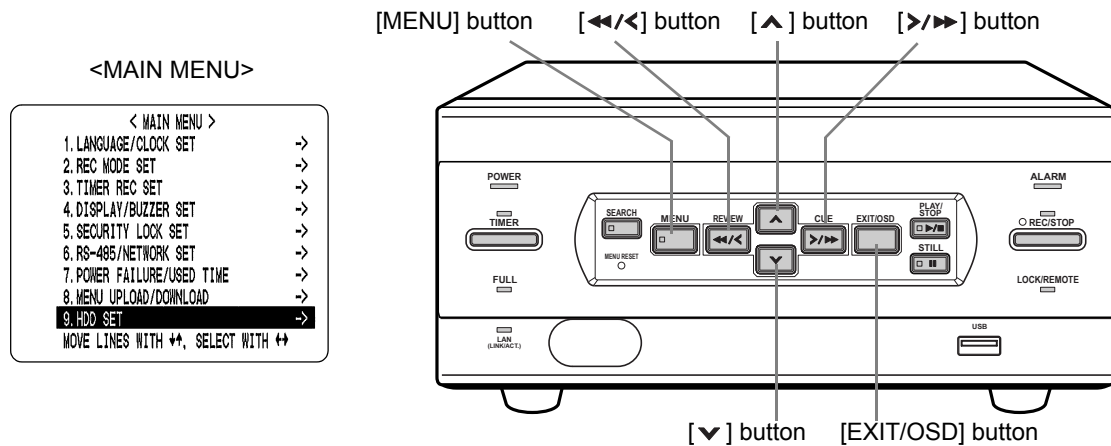

This section describes how to initialize the hard disk or add a hard disk.

Initializing the hard disk

1 Press the [MENU] button.

The [MENU] button lights, and the <MAIN MENU> screen appears.

2 Select "9. HDD SET", and press the [▶/▶] button.

The <HDD SET> screen appears.
The cursor is positioned on "DISK INITIALIZE".

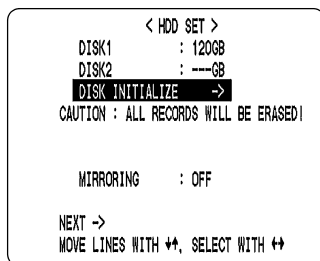

3 Press the [▶/▶] button.

The <WARNING> screen appears, and "NO" flashes.



4 Press the [▼] and [▲] buttons to select "YES", then press the [▶/▶] button.

The "HDD INITIALIZING!" screen appears, and the hard disk is initialized (reformatted). When the process has finished, the display returns to the MENU screen.

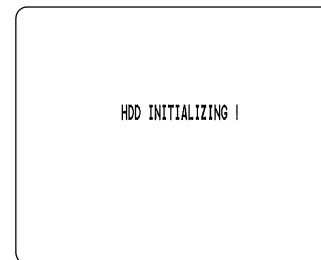

5 Press the [EXIT/OSD] button.

The display returns to the normal screen.

Adding a hard disk (120 GB model only)

To add a hard disk, contact a Sanyo service center. When adding a hard disk, use an add-on type hard disk unit (sold separately).

[Setting conditions]

- After adding a hard disk, be sure to initialize it. Note that both hard disks will be initialized, and any data on the original hard disk will be erased.

NOTE

Hard disk setting screen

- **Mirroring:** After adding a hard disk, you can record the same image on both hard disks. If an image write error occurs on one disk, you can still read the image from the other.
- **Playback disk:** When mirroring is set, the digital video recorder automatically sets which of the two hard disks to read the recorded image from.

1 INTERFACE SPECIFICATIONS

RS-485 specifications

Data format

Mode	Asynchronous
Character length	8 bits
Data transmission speed	2400, 4800, 9600, 19200 bps
Parity check	None
Stop bit	1

Communication protocol

A proprietary Sanyo protocol (SSP: Security Serial Protocol) is used. Use of a special controller for operation is recommended. To obtain this controller, contact a Sanyo service center.

RS-485 termination switch settings

Termination settings

When connecting multiple devices, you must make termination settings on both end devices.

- Set the RS-485 termination switch of both end devices to ON.
- Be sure to set the RS-485 termination switches of all devices in between (devices other than the first and last devices) to OFF.

! CAUTION

- If you don't make the correct termination settings, data will be distorted and will affect other data, making the data transmitted to each device incorrect.

Example

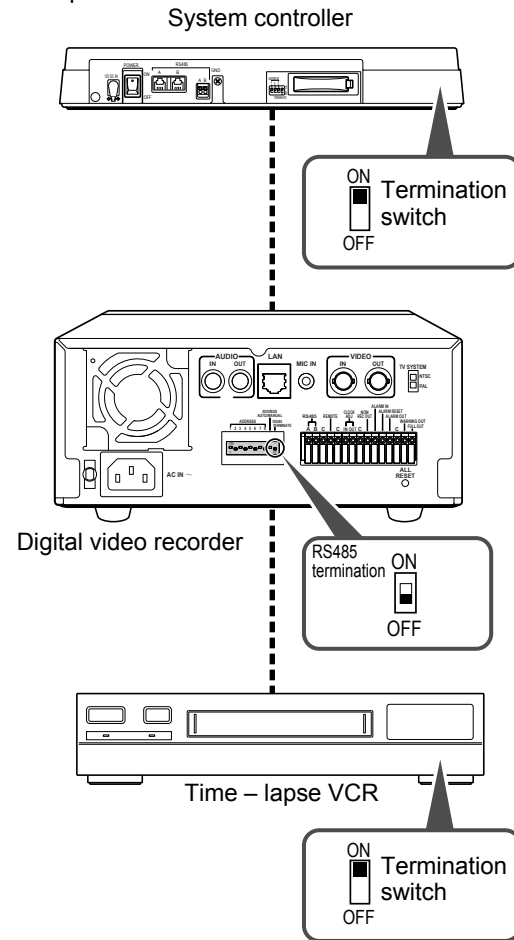

OTHER

1 INTERFACE SPECIFICATIONS

DVR/VCR command table

The table below shows the commands supported by the digital video recorder.

Left digit \ Right digit	0	1	2	3	4	5	6	7
0							TIMER ON/OFF	
1								
2								
3						SHIFT←	SHIFT→	
4						SHIFT↑	SHIFT↓	MENU
5							SHIFT+ /RP UP	
6							SHIFT- /RP DOWN	
7								
8								
9							SECURITY LOCK ON	
A	ACK			PLAY	REV PLAY /SEARCH (DVR)		SECURITY LOCK OFF	
B	NAK							
C							GROUP SET	
D							GROUP CHECK	
E							GROUP CLEAR	
F				STOP	STILL			

Left digit \ Right digit	8	9	A	B	C	D	E	F
0							CLOCK ADJUST	
1							MENU RESET	
2								
3								
4								
5								
6						T/L STATUS SENSE		
7						STATUS SENSE		
8								
9							CLOCK DOWNLOAD	
A					REC			REC/DUB REQUEST
B			FF					
C			REW					
D								RS-485 SEND START
E	OSD/EXIT			STATUS LOG2				RS-485 RCV CMF.
F				STATUS LOG1	REC STOP			

2 SPECIFICATIONS

Hard disk capacity	120 GB or 240 GB	
Television system	NTSC/PAL color signal standard (Switchable)	
Picture resolution	NTSC: 720 x 480 (Super/High), 352 x 480 (Standard) PAL: 720 x 576 (Super/High), 352 x 576 (Standard)	
Compression	MPEG2 (Video), MPEG1 Layer2 (Audio)	
Picture quality	3 levels (Super/High/Standard)	
Recording type	Frame	
Recording speed	1 (NTSC: 30 fps or PAL: 25 fps)	
Recording area	1	
Playback	Playback/Still/Search/Cue/Review/Frame advance/Slow	
Search mode	• Time/date search	Search by time and date
	• Alarm search	Search by alarm event list
Menu language	English/French/Spanish	
Clock settings	Month/Day/Year/Hours/Minutes/seconds	
Video input terminal	1.0 V p-p / 75 Ohm unbalanced (BNC)	
Video output terminal	1.0 V p-p / 75 Ohm unbalanced (BNC)	
Audio input terminal	-8 dbs, 27 k Ohm unbalanced (RCA pin jack)	
Audio output terminal	-8 dbs, 600 Ohm unbalanced (RCA pin jack)	
Microphone input terminal	-60 dBs, 10 k Ohm unbalanced (3.5 mm mini jack)	
LAN terminal	100BASE-TX/10BASE-T (RJ-45)	
USB terminal	For compact flash reader (Front)	
Control connector (Push lock)	RS-485 terminal	3 terminals: A/B/C
	Remote control input terminal	External switch connection or VA-RMN01 remote control
	Clock adjust output terminal	Normal 5 V, Low level active
	Non REC output terminal	Normal 5 V, Low level active
	Alarm input terminal	Normal open, Low level active
	Alarm reset input terminal	Normal open, Low level active
	Alarm output terminal	Normal 5 V, Low level active
	Warning output terminal	Open collector (500 mA), Low level active
	Full out warning terminal	Open collector (50 mA), Low level active
Power	120 V - 240 V AC, 50/60 Hz	
Current consumption	460 mA - 280 mA	
Operating environment	Temperature: 5 °C to 40 °C, Humidity: 10 % to 80 %	
Dimensions	210 (W) x 96 (H) x 391.5 (D) mm	
Weight	3.4 kg	

Note that product appearance and specifications are subject to change without prior notice.

2 SPECIFICATIONS

Dimensions

(mm)

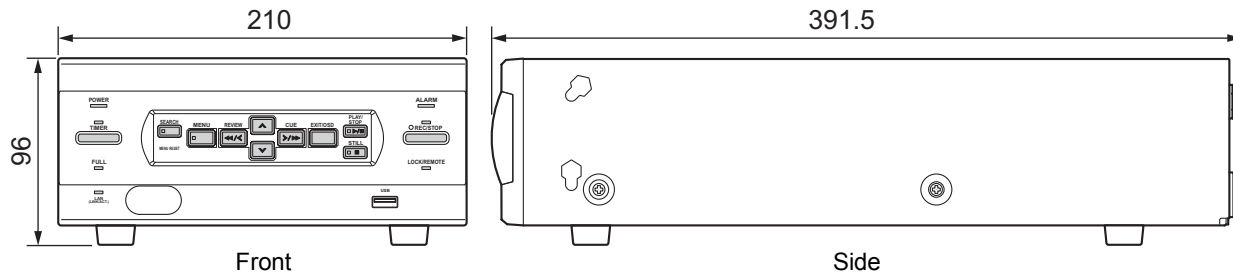

**SANYO INDUSTRIAL
DSR-M800 DIGITAL VIDEO RECORDER WARRANTY**

OBLIGATIONS

In order to obtain warranty service, the product must be delivered to and picked up from an Authorized Sanyo Service Center at the user's expense, unless specifically stated otherwise in this warranty. The names and addresses of Authorized Sanyo Service Centers may be obtained by calling the toll-free number listed below.

For product operation, authorized service center referral, service assistance or problem resolution, call
CUSTOMER INFORMATION 1-800-421-5013
Weekdays 8:30 AM – 5:00 PM Pacific Time

For accessories and/or parts, call
PARTS ORDER INFORMATION 1-800-726-9662
Weekdays 8:30 AM – 5:00 PM Pacific Time

THIS WARRANTY IS VALID ONLY ON SANYO PRODUCTS PURCHASED OR RENTED IN THE UNITED STATES OF AMERICA, EXCLUDING ALL U.S. TERRITORIES AND PROTECTORATES. THIS WARRANTY APPLIES ONLY TO THE ORIGINAL RETAIL PURCHASER OR END-USER. THE ORIGINAL DATED BILL OF SALE, SALES SLIP OR RENTAL AGREEMENT MUST BE SUBMITTED TO THE AUTHORIZED SANYO SERVICE CENTER AT THE TIME WARRANTY SERVICE IS REQUESTED.

Subject to the OBLIGATIONS above and EXCLUSIONS below, SANYO Fisher Company warrants this SANYO product against defects in materials and workmanship for the periods specified below. SFC will repair or replace (at its option) the product and any of its parts which fail to conform to this warranty. The warranty period commences on the date the product was first purchased or rented at retail.

LABOR	PARTS
1 YEAR	1 YEAR

EXCLUSIONS

This warranty does not cover (A) the adjustment of customer-operated controls as explained in the appropriate model's instruction manual, or (B) the repair of any product whose serial number has been altered, defaced or removed.

This warranty shall not apply to the cabinet or cosmetic parts, batteries or routine maintenance.

This warranty does not apply to uncrating, setup, installation, removal of the product for repair or reinstallation of the product 'ter repair.

This warranty does not apply to repairs or replacements necessitated by any cause beyond the control of SFC including, but not limited to, any malfunction, defect or failure caused by or resulting from the use of any products operated outside of the operating temperature ranges stated in our product specification, (i.e., between 41 and 104 degrees Fahrenheit or between 5 and 40 degrees Celsius), unauthorized service or parts, improper maintenance, operation contrary to furnished instructions, shipping or transit accidents, modification or repair by the user, abuse, misuse, neglect, accident, incorrect power line voltage, fire, flood or other Acts of God, or normal wear and tear.

SFC does not guarantee that recorded pictures or information will be maintained on any product sent in for repair or replacement.

The foregoing is in lieu of all other expressed warranties and SFC does not assume or authorize any party to assume for it any other obligation or liability.

SFC DISCLAIMS ALL OTHER WARRANTIES EXPRESS OR IMPLIED, WITH REGARD TO THIS PRODUCT (INCLUDING THE WARRANTIES OF MERCHANTABILITY AND FITNESS). IN NO EVENT SHALL SFC BE LIABLE FOR ANY SPECIAL, INCIDENTAL OR CONSEQUENTIAL DAMAGES ARISING FROM THE OWNERSHIP OR USE OF THIS PRODUCT OR FOR ANY DELAY IN THE PERFORMANCE OF ITS OBLIGATIONS UNDER THIS WARRANTY DUE TO CAUSES BEYOND ITS CONTROL. SFC'S LIABILITY FOR ANY AND ALL LOSSES AND DAMAGES RESULTING FROM ANY CAUSE WHATSOEVER, ARISING OUT OF OR IN CONNECTION WITH THE SALE, USE OR OWNERSHIP OF THIS PRODUCT INCLUDING WARRANTOR'S NEGLIGENCE, ALLEGED DAMAGED OR DEFECTIVE GOODS, WHETHER SUCH DEFECTS ARE DISCOVERABLE OR LATENT, SHALL IN NO EVENT EXCEED THE PURCHASE PRICE OF THE PRODUCT.

ATTENTION

For your protection in the event of theft or loss of this product, please fill in the information below for you own personal records.

Model No. _____

Serial No. _____
(Located on back or bottom side of unit.)

Date of Purchase _____

Purchase Price _____

Where Purchased _____

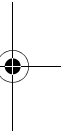
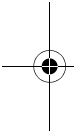
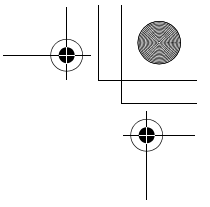
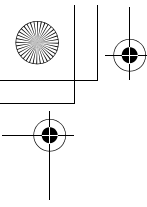

SANYO

SANYO Electric Co., Ltd.

Printed on recycled paper
Imprimé sur du papier recyclé
Impreso en papel reciclado

1AC6P1P2612--C
L8HAC/US, US2 (0302TR-SY)

Printed in Japan

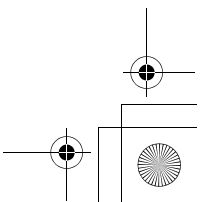
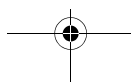
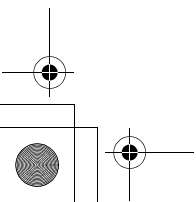

Free Manuals Download Website

<http://myh66.com>

<http://usermanuals.us>

<http://www.somanuals.com>

<http://www.4manuals.cc>

<http://www.manual-lib.com>

<http://www.404manual.com>

<http://www.luxmanual.com>

<http://aubethermostatmanual.com>

Golf course search by state

<http://golfingnear.com>

Email search by domain

<http://emailbydomain.com>

Auto manuals search

<http://auto.somanuals.com>

TV manuals search

<http://tv.somanuals.com>