

INSTRUCTION MANUAL

DSR-M804P

Digital Video Recorder

About this manual

Before installing and using this unit,
please read this manual carefully.
Be sure to keep it handy for later reference.

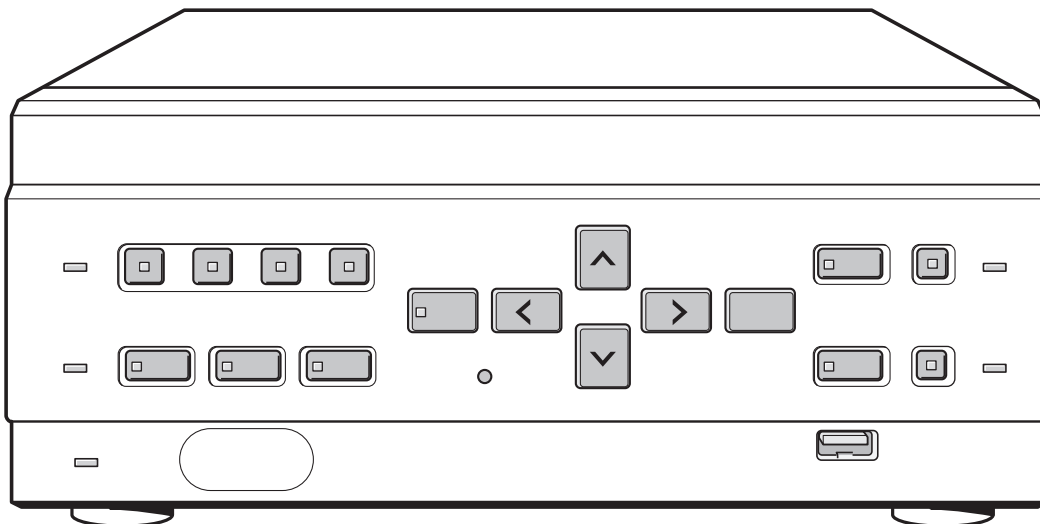

PRECAUTION

WARNING: TO REDUCE THE RISK OF FIRE OR ELECTRIC SHOCK, DO NOT EXPOSE THIS APPLIANCE TO RAIN OR OTHER MOISTURE.
To avoid electrical shock, do not open the cabinet.
Refer servicing to qualified personnel only.
If the power supply cord (AC power cord) of this appliance is damaged, it must be replaced. Return to a SANYO Authorised Service Centre for replacement of the cord.

Location

For safe operation and satisfactory performance of your unit, keep the following in mind when selecting a place for its installation:

Shield it from direct sunlight and keep it away from sources of intense heat.

Avoid dusty or humid places.

Avoid places with insufficient ventilation for proper heat dissipation. Do not block the ventilation holes at the top and bottom of the unit. Do not place the unit on a carpet because this will block the ventilation holes.

Install the unit in a horizontal position only.

Avoid locations subject to strong vibrations.

Avoid moving the unit between cold and hot locations.

Do not place the unit directly on top of a monitor TV, as this may cause playback or recording problems.

Avoiding Electrical Shock and Fire

Do not handle the power cord with wet hands.

Do not pull on the power cord when disconnecting it from an AC wall outlet. Grasp it by the plug.

If any liquid is spilled on the unit, unplug the power cord immediately and have the unit inspected at a factory-authorized service centre.

Do not place anything directly on top of this unit.

SERVICE

This unit is a precision instruments and if treated with care, will provide years of satisfactory performance. However, in the event of a problem, the owner is advised not to attempt to make repairs or open the cabinet. Servicing should always be referred to your dealer or Sanyo Authorized Service Centre.

CAUTION

Danger of explosion if battery is incorrectly replaced.

Replace only with the same or equivalent type recommended by the manufacturer.

Discard used batteries according to the manufacture's instructions.

INTRODUCTION

Main features

This digital video recorder can be used to store images recorded by four monitoring cameras onto its built-in hard disk.

■ Large-capacity (120 GB or 240 GB) hard disk.

Eliminates laborious tape replacement, and offers a long continuous recording time of at least 672 hours (240 GB; standard image quality). (At least 336 hours for 120 GB, standard image quality.)

For the 120 GB model, a hard disk upgrade is available (sold separately) that gives you a total of 240 GB of memory.

■ Complete range of recording/playback functions

- You can play back and record images at the same time.
- You can record and play back audio.
- The timer record function lets you make recordings at different times each day. (→P. 15)
- Images from four cameras can be displayed on a single monitor, in the quad screen.
- The automatic channel switching function (SEQUENCE) lets you display the images from each channel on a single screen sequentially, or display just the desired image on a single screen.
- The motion sensor function automatically records changes in images caused by movements of intruders.

■ Search function – lets you instantly display the desired image. (→P. 19)

- Searching in order of alarm occurrence
- Searching by date/time

■ Security lock function – lets you restrict users, for data and equipment management. (→P. 42)

■ Expandability and PC connection

- The Ethernet terminal lets you connect the digital video recorder to a network, for remote operation/remote monitoring using a PC.
- Network connection lets you control up to 1,000 DVRs (digital video recorder) using up to 4 PCs.
- Can be connected to a system controller (sold separately) using the RS-485 terminal.
- A CompactFlash card reader can be connected using the USB terminal, letting you upload/download menu data.

Accessories

Check that you have all the parts below.

Power cord

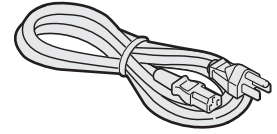

Ferrite core (3)

For: LAN connection cable
DVR power cord
TV monitor power cord

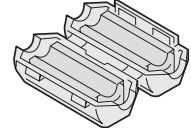

Power cord tie

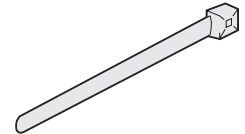

Application software (VA-SW80LITE)

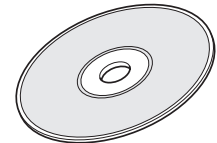

Symbols used in this manual

NOTE Information describing operation methods or how to get the most out of functions

CAUTION Information describing the correct use of the digital video recorder

(→P. xx) Indicates manual page to refer to.

Copyright

- This manual and software are copyrighted by Sanyo Electric Co., Ltd.
- Brand and product names used in this manual are the trademarks or registered trademarks of their respective companies.
- Copyright law prohibits the recording of copyrighted images without the permission of the copyright holder except for personal use.

CONTENTS

INTRODUCTION

1 BEFORE USE.....	5	2 NAMES AND FUNCTIONS OF PARTS	7
Notes on handling internal hard disk drive components	5	Front panel.....	7
Conditions to avoid	5	Rear panel.....	8
The hard disk and cooling fan are expendable items.	5	3 INSTALLATION AND CONNECTIONS	9
Installation conditions.....	5	Basic connections	9
For important recordings.....	5	System controller connections	9
Hard disk protection	6	Connecting a remote control circuit.....	9
Care	6	Connecting cables to the control and alarm terminals.....	10
During extended disuse	6	Connecting to a network	10
Backup battery	6	Connecting the power cord	10
MENU button	6	PAL/NTSC switching.....	10

OPERATION

1 SCREEN DISPLAY AND POSITION	11	5 NORMAL RECORDING/TIMER RECORDING PLAYBACK	17
Operation display area.....	11	Playback.....	17
Changing the position of the operation display.....	12	Playback while fast-forwarding/rewinding	17
To display the quad screen as single screens	12	Viewing still images.....	18
To display the image from a specified channel in a single screen	12	Frame advance (reverse).....	18
2 SETTING THE LANGUAGE/CLOCK.....	13	To playback audio.....	18
To change the language	13	6 SEARCHING FOR RECORDED IMAGES ...	19
Setting the time	14	Alarm search	19
3 NORMAL RECORDING/TIMER RECORDING	15	Date/time search	20
Normal recording	15	7 PREVENTING ACCIDENTAL OPERATION (KEY LOCK FUNCTION).....	22
Timer recording.....	15	Setting the key lock function	22
4 ALARM RECORDING	16	Releasing the key lock function.....	22
Alarm recording.....	16		

SETTINGS

MENU CONFIGURATION AND OPERATIONS 23

- Displaying menu screens and setting screens 23
- To restore menu setting items to their initial values 23
- Overview of sub-menus 24

1 LANGUAGE/CLOCK SET 25

- <SUMMER TIME> settings 25
- <EXT.CLOCK SET> settings 26

2 SCREEN SET MENU 28

- Screen settings 28
- MONITOR SET 29
- Camera title setting 29
- Setting the motion sensor 30

3 RECORDER MENU 32

- Setting items 32
- REC MODE SET 32
- ALARM REC MODE SET 34
- AUDIO REC LEVEL SET 35
- Timer recording settings 35
- Setting holidays 38
- Initializing the hard disk/adding a hard disk .. 38

4 DISPLAY SET 40

- <DISPLAY SET> screen setting items 40
- Settings 40

5 BUZZER SET 41

- <BUZZER SET> screen setting items 41
- Settings 41

6 SECURITY LOCK SET 42

- Password setting example 42
- <SECURITY LOCK SET> screen setting items 42
- Setting passwords 42
- Setting the user password 43
- Setting the authorization for recording and playback operations 44
- Setting the security lock 44

7 RS-485/NETWORK SET 45

- Network connections and settings 45
- RS-485 connections and settings 46

8 POWER FAILURE/USED TIME 47

9 MENU UPLOAD/DOWNLOAD 48

- Settings 48

OTHER

1 INTERFACE SPECIFICATIONS 50

- RS-485 specifications 50
- RS-485 termination switch settings 50
- DVR/VCR command table 51

2 SPECIFICATIONS 52

- Dimensions 53

Notes on handling internal hard disk drive components

This unit has a built-in hard disk drive (HDD).

Be sure to observe the following points carefully when operating, setting-up and servicing the unit.

■ Do not subject the unit to shocks or vibration.

If the unit is subjected to shocks or vibration, it may damage the HDD or cause corruption of the data stored in the HDD.

- Do not move the unit while the power is turned on. Always be sure to turn off the power before removing the unit from or placing it onto the rack.
- When transporting the unit, pack it securely using the specified packing materials. In addition, use a method of transportation that minimizes vibration.
- When placing the unit down on a surface such as a floor, attach the specified feet to the base of the unit and place it down gently. If the feet are not attached, place the unit down very carefully so that it does not make any noise.

■ Do not move the unit for 30 seconds after turning off the power.

After the power is turned off, the disk inside the HDD will continue to spin for a brief period due to inertia, and the heads will be in an unstable state.

During this time, the unit is even more susceptible to shocks and vibration than when power is being supplied. Make sure that the unit is not subjected to even gentle vibration for at least 30 seconds after turning off the power.

■ Do not operate the unit when condensation has formed.

If the unit is operated when condensation has formed, it may cause operating problems.

If sudden changes in the ambient temperature occur, wait for the temperature to stabilize before operating the unit.

■ Notes when replacing the HDD

Be sure to follow the correct replacement procedure when replacing the HDD.

- HDDs that have been removed from their packing may not operate correctly if they are subjected to any shocks and vibration. It is recommended that you place HDD onto a soft, level surface with the printed circuit board facing upward after unpacking it.
- Be careful not to subject the HDD to shocks or vibration when removing and tightening screws as part of the HDD replacement procedure. Make sure that all screws are tightened securely so that they will not become loose. The HDD is sensitive to static electricity, so you should take proper precautions to prevent static electricity buildup.

■ Handling the HDD unit by itself

If transporting or storing the HDD unit by itself, always be sure to pack it in the specified packing first.

In addition, use a method of transportation that minimizes the vibration.

If the HDD becomes damaged, handle the unit and the damaged HDD that has been removed in order for it to be replaced carefully to prevent the problem from being aggravated until as the nature of the problem can be checked and analyzed.

Conditions to avoid

- The hard disk is sensitive to dust, vibrations and shocks, and should also not be used near magnetic objects. To prevent loss of recorded data, observe the following precautions:
- Do not subject the digital video recorder to shocks.
- Do not use the digital video recorder on a vibrating or unstable surface.
- Do not disconnect the power plug from the wall outlet during recording or playback.
- Do not use the digital video recorder in areas of extreme temperature changes (10°C or more per hour).
- Condensation may occur if the digital video recorder is moved to an area of extremely different temperature or high humidity. If the digital video recorder is used with condensation inside it, operating problems may occur.
- Do not install the digital video recorder in areas of constant vibration such as motor vehicles or trains.

The hard disk and cooling fan are expendable items.

Under use in an ambient temperature of 25°C, the hard disk should generally be replaced after 2 years, and the cooling fan after 3 years. These figures are intended as guidelines only, and are not guarantees of part performance.

The POWER indicator flashes if a problem occurs in the hard disk or fan. (→P. 10)

Installation conditions

The digital video recorder has ventilation holes on its left, rear and bottom panels. Make sure these holes are not blocked after installation.

Do not use the unit in an area of poor ventilation such as a bookshelf or box.

When installing the unit in a rack, ensure a gap of at least 5 cm at the top and bottom.

For important recordings

- Always make a test recording beforehand to check that the digital video recorder's playback is normal.
- Note that no compensation will be provided for losses due to recording or playback problems arising from problems with the digital video recorder or its connected devices during operation.

1 BEFORE USE

- To be prepared for malfunctions or accidents, back up important recordings periodically, or record using mirroring.

Hard disk protection

The hard disk is checked automatically at power ON. If a hard disk problem is found, the POWER indicator flashes. To initialize the disk or save images stored on the disk, contact a Sanyo service centre.

Care

- To clean the digital video recorder, unplug the power plug from the wall outlet and wipe the unit lightly with a soft cloth.
- To remove heavy grime, wipe the digital video recorder with a well-wrung cloth soaked in a solution of water and neutral detergent, and then wipe it with a dry cloth.
- Do not clean the unit with benzene or paint thinner. Doing so may break down the finish or strip the paint.
- When using a chemical cloth, be sure to follow the precautions provided with it.
- Do not spray insecticide or other volatile chemicals on the cabinet. Do not allow rubber or vinyl products to come into contact with the digital video recorder for extended periods. Doing so may break down the finish or strip the paint.

During extended disuse

Extended disuse may cause problems in functions, so turn the power on and operate the unit occasionally during such periods.

Backup battery

The digital video recorder comes with a built-in lithium battery. When the digital video recorder has been connected to a wall outlet for at least 48 hours and the date and time have been set, the clock function will continue to operate for up to 30 days after the power plug is disconnected.

When disposing of the digital video recorder, contact a Sanyo service centre for information on how to dispose of the lithium battery.

MENU button

The [MENU] button is disabled when the unit is connected to a PC (VA-SW804/VA-SW80LITE). When the [MENU] button is operative, operations from the PC are disabled.

Front panel

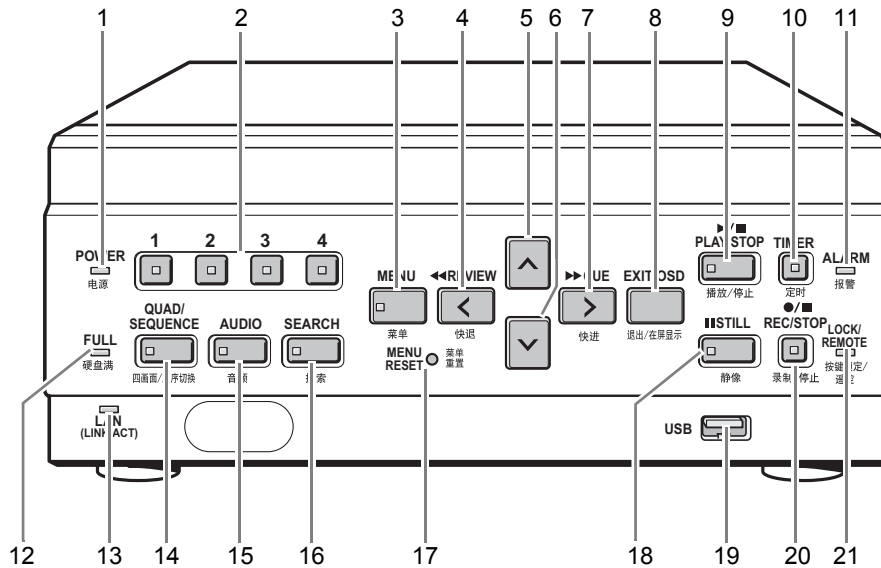

1. **POWER indicator (→P. 10)**
Lights when the power is ON.
Flashes when there is a problem with the hard disk or fan.
2. **CHANNEL buttons and indicators**
Used when switching the image display from the quad screen to a single screen. Pressing a channel button lights its indicator and displays the corresponding image in a single screen.
3. **[MENU] button and indicator**
Used to display the menu screens. The indicator lights when a menu screen is displayed.
4. **[REVIEW] button**
When pressed during playback, lets you rewind the image while watching it on screen. Also used for menu screen operations.
5. **[^] button**
Used to move the cursor in menu screens up. Also used to change setting values.
6. **[v] button**
Used to move the cursor in menu screens down. Also used to change setting values.
7. **[CUE] button**
When pressed during playback, lets you fast-forward the image while watching it on screen. Also used for menu screen operations.
8. **[EXIT/OSD] button (→P. 23)**
Returns the display to the normal screen when the main menu, a sub-menu, or a setting screen is displayed.
9. **[PLAY/STOP] button**
Plays back the normal image (indicator lights). When pressed during playback, stops playback.
10. **[TIMER] button and indicator (→P. 15)**
When the button is pressed while recording or stopped, the digital video recorder enters timer record standby, and the indicator lights. When the set time arrives, the digital video recorder starts timer recording.
11. **ALARM indicator**
Flashes when recording an alarm image.
12. **FULL indicator (→P. 33)**
Lights when the remaining memory in the hard disk's recording area has reached zero and recording has stopped.
13. **LAN indicator**
Lights when the digital video recorder is connected to a network. Flashes when data is being sent and received.
14. **[QUAD/SEQUENCE] button and indicator (→P. 12)**
Switches to the quad screen display, or switches from the quad screen display to each single-screen display in sequence.
15. **[AUDIO] button and indicator**
Switches the audio output channel.
16. **[SEARCH] button and indicator (→P. 19, P. 20)**
When the button is pressed while recording or stopped, the indicator lights, and the search setting screen is displayed.
17. **[MENU RESET] button (→P. 23)**
Used to initialize the currently displayed menu settings, and to set the time.
18. **[STILL] button**
When pressed during playback, freezes the screen image (the indicator lights). Pressing the button again resumes playback.
19. **USB terminal (→P. 48)**
Used to connect a CompactFlash card reader.
20. **[REC/STOP] button and indicator**
Starts normal recording. Indicator lights during recording. During recording, pressing the button for at least 3 seconds stops recording and turns off the indicator.
21. **LOCK/REMOTE indicator (→P. 22, P. 44)**
Lights when operations have been locked by the key lock or security lock setting.
If an operation button is pressed when the security lock is set, a buzzer sounds. The key lock cannot be set during playback.
The indicator flashes at 4Hz when there is a network connection, and flashes at 1Hz when there is a network connection while locked.

Rear panel

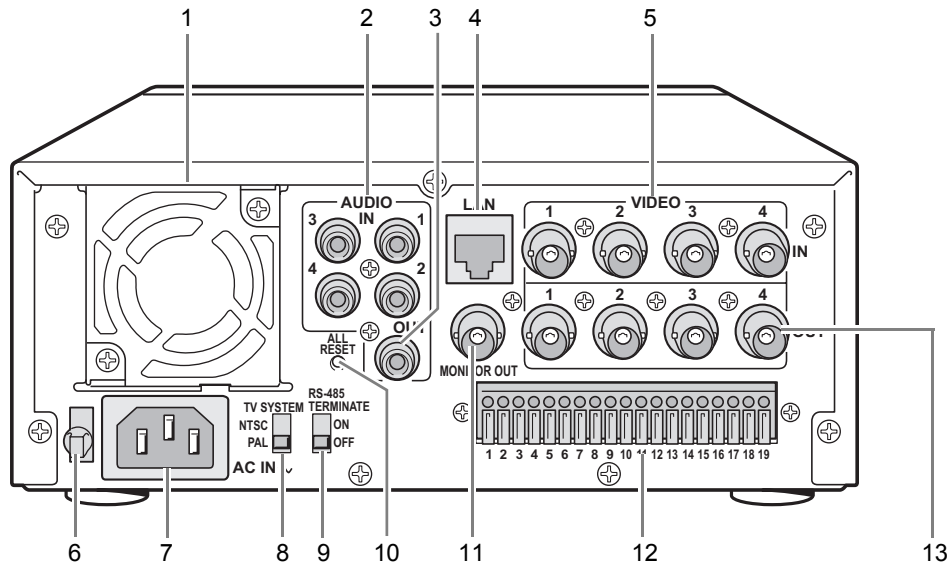

- 1. **FAN**
- 2. **AUDIO IN terminals (4 channels)**
- 3. **AUDIO OUT terminal**
- 4. **LAN terminal (→P. 45)**
- 5. **VIDEO IN terminals (4 channels)**
- 6. **Power cord holder**
Secure the power cord to the holder using the cord tie (accessory) as shown in the illustration.

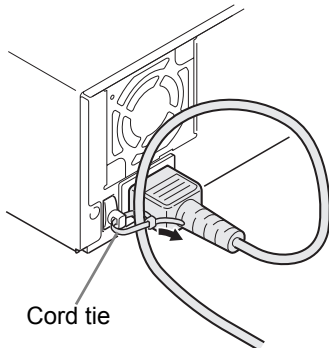

- 7. **AC INLET**
AC power input terminal (3-core)
- 8. **TV SYSTEM selector switch**
Used to select between NTSC and PAL systems for the camera input and monitor output connected to the digital video recorder.

CAUTION

- Turn the power OFF then ON again after selecting NTSC or PAL.
- 9. **RS-485 TERMINATE switch**
Turns RS-485 termination ON/OFF.
- 10. **ALL RESET switch**
Resets the clock and backup mode setting. (Menu settings are maintained)

- 11. **VIDEO MONITOR OUT terminal**
Output terminal that displays quad screen on single monitor.

12. **Control and alarm terminals**

Terminal No.	Pin	Signal
1	RS485A	To RS-485 terminal signal A *1
2	RS485B	To RS-485 terminal signal B *1
3	C	Common
4	REMOTE	Remote Control terminal
5	C	Common
6	CLOCK ADJ IN	Input for clock setting
7	CLOCK ADJ OUT	Output for clock setting
8	C	Common
9	SERIES REC IN	Input terminal used when recording with multiple digital video recorders connected.
10	NON REC OUT/ SERIES REC OUT	Output terminal used when recording with multiple digital video recorders connected.*2
11	ALARM IN 1	Alarm input for channel 1
12	ALARM IN 2	Alarm input for channel 2
13	ALARM IN 3	Alarm input for channel 3
14	ALARM IN 4	Alarm input for channel 4
15	ALARM RESET	Alarm reset input
16	ALARM OUT	Alarm output
17	C	Common
18	WARNING OUT	Warning output *3
19	DISK FULL OUT	Recording area full warning

*1 Used for twisted-pair cable connection.

*2 SERIES REC outputs NON REC OUT when SERIES REC is "OFF".

*3 The following warnings are output:

- Hard disk drive error ● Fan error ● Recording error
- No input signal when VIDEO LOSS is ON.

13. **VIDEO OUTPUT terminals (4 channels)**

Terminals for output of individual video channels directly to the monitor.

This section describes how to connect the digital video recorder to the CCTV camera and other devices. Be sure to read the instruction manuals for each connected device. Make connections carefully. Improper connections can cause smoke or malfunctions.

Basic connections

The connections for cameras (4), TV monitor (1), microphone and PC are shown below.

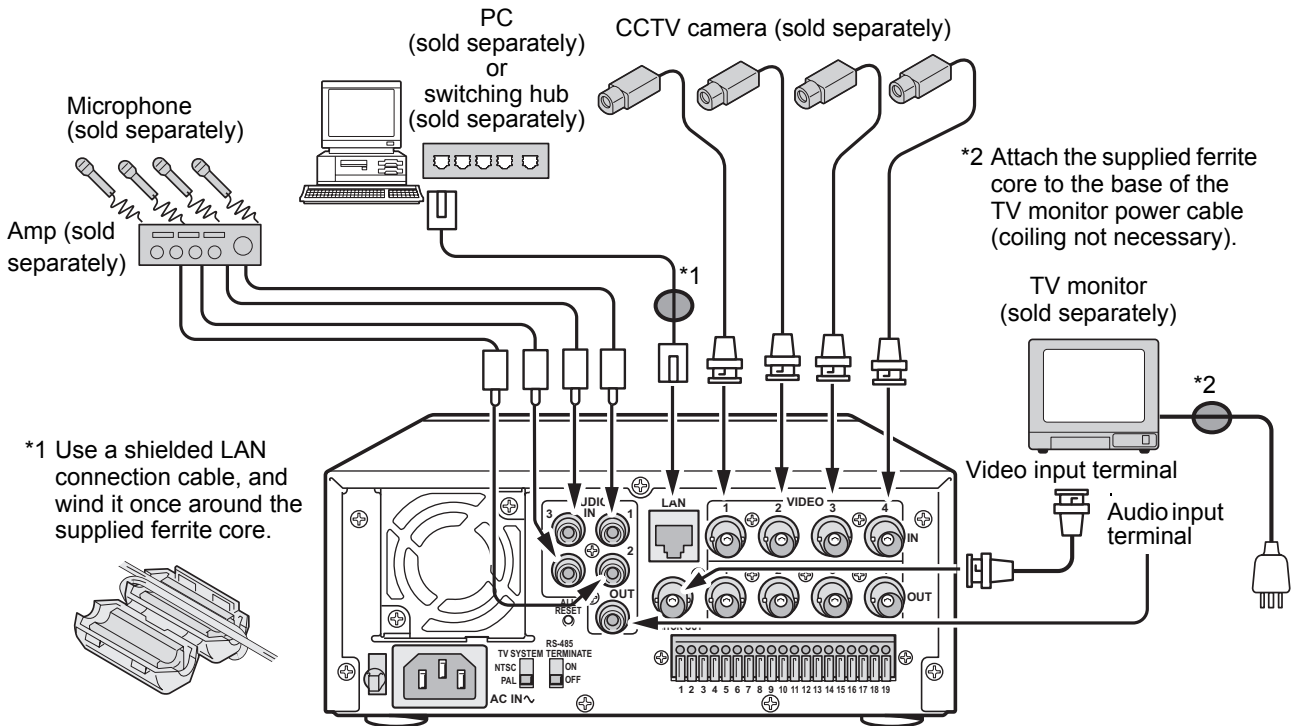

System controller connections

The connections for a system controller are shown below. Use a twisted-pair cable (sold separately) to connect rear panel control terminals A, B and C (ground). Connect signal A to signal A, and signal B to signal B.

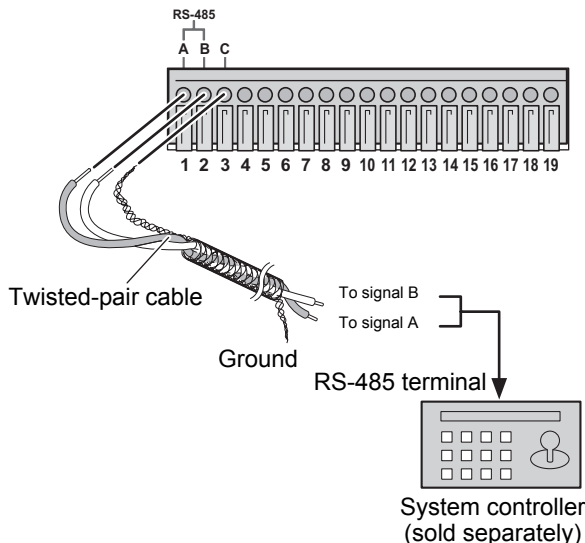

- Twisted-pair cable
Can reduce interference on the signal caused by noise generated by other cables.

Connecting a remote control circuit

The connections for a remote control circuit are shown below. Making the connections shown below lets you operate the digital video recorder by remote control.

- Create the remote control circuit shown in the illustration, and connect it to the remote control input terminals (among the control terminals).

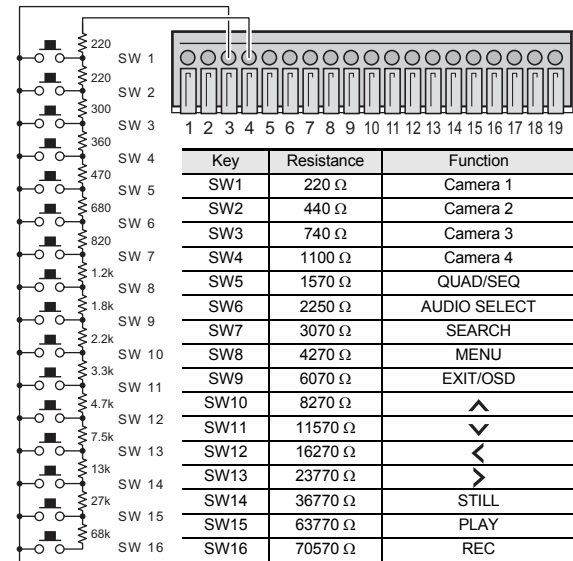

Use a resistance of 1/10 ohms or more and with a D ranking (precision 0.5% or finer).

Connecting cables to the control and alarm terminals

- (1) Push in the lock pin with a flat-blade screwdriver.
 - (2) Insert the cable.
 - (3) Pull out the lock pin with a flat-blade screwdriver.
- The cable is now fixed in place.

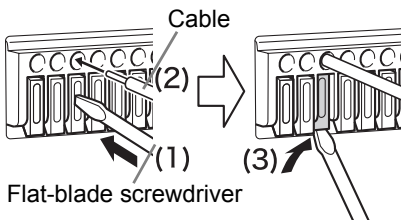

Connecting to a network

The VA-SW804 application software (sold separately) or the VA-SW80LITE application software (accessory) lets you control the digital video recorder, and monitor live images, recorded images and audio through a network.

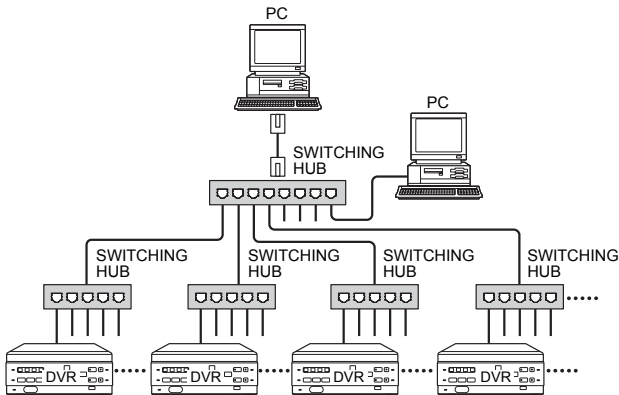

Connecting the power cord

- 1** When you have finished making all the other connections, insert the power plug into the wall outlet.

There is no power switch. The display indicators flash, and after a few moments, the monitor screen displays the camera image.

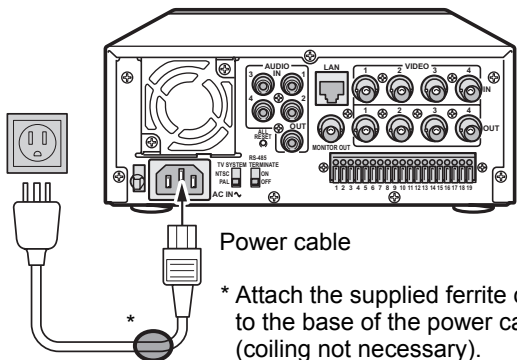

- **When turning the power ON for the first time**
“PLEASE SET THE CLOCK” is flashed on the monitor screen. Follow the steps on page 14 to set the clock.
- **If the clock is already set**
The operation display area is displayed.

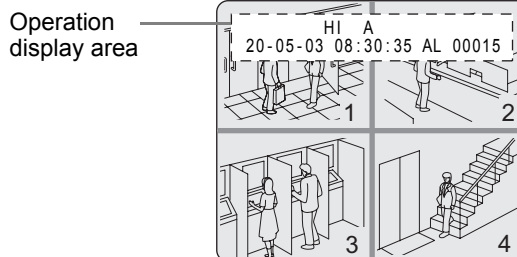

CAUTION

- **If the POWER indicator flashes**
The digital video recorder has a self-check function that indicates problems. If there is a problem at power ON or during operation, the type of problem is indicated by how rapidly the POWER indicator flashes. Contact a Sanyo Authorized Service Centre if the POWER indicator flashes. 4 flashes per second:
The disk is checked automatically at power ON. If a hard disk problem is found, the POWER indicator flashes, and the hard disk must be replaced or reformatted. If you need to save images stored on the disk, contact a Sanyo Authorized Service Centre.
1 flash per second:
Fan problem
- **If you disconnect the power cable**
Do not move the recorder or subject it to vibrations for at least 30 seconds after turning the power OFF. The disk in the hard disk drive briefly keeps spinning after power OFF due to inertia, during which time the head is unstable. At this time, the disk is sensitive to shocks or vibrations, so avoid even light shocks.

PAL/NTSC switching

Set the TV SYSTEM selector switch on the rear panel to “PAL”. (→P. 8)

CAUTION

- Turn the power OFF then ON again after selecting NTSC or PAL.

At power ON, the operation display area appears at the top of the monitor screen. The operation display area shows the date/time, image quality, remaining time, and other information needed for operations.

Operation display area

Example: Normal screen

(1) REC
20-05-03

(2) HI
08:30:35

(3) A
AL

(4) 120H
00015

(5) (6) (7)

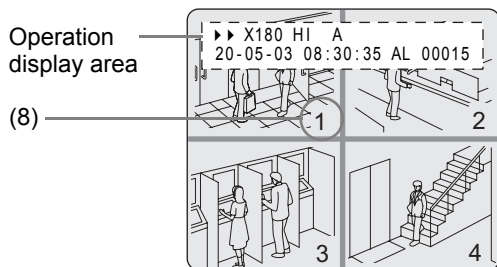

(1) Operation symbol display

Displays symbols for recording, playback, playback speed, etc.

For the meaning of each operation symbol, see "Displayed symbols" on the right.

NOTE

- During simultaneous recording and playback, the display indicates playback (▶).

(2) Image quality display (→P. 33)

Displays the quality of the image that can be recorded on the hard disk. Set to "HIGH" in the default settings.

(3) Audio recording

Displays "A" when audio recording has been set.

(4) Remaining time display

Unless "OVER WRITE" is set for recording, displays the remaining amount of recording time, as shown below.

Remaining time	Displayed increment	Example
1 hour or more	1 hour increments	1H
Less than 1 hour	10 minute increments	10M
Less than 10 minutes	1 minute increments	1M

When there is less than 10 minutes, the remaining time display flashes.

(5) Date display (→P. 14)

Shows the day/month/year.

20-05-03 (day/month/year)

(6) Time display (→P. 14)

"00:00:00" is displayed when you turn the power ON for the first time. The digital video recorder uses the date and time to manage recording and playback points.

(7) Alarm display and alarm count display (→P. 16)

When you set an alarm using the <ALARM REC MODE SET> menu item, the alarm display area displays the following information. (→P. 34)

● Alarm display

When alarm recording is set, "AL" appears.

During alarm recording, the "AL" display flashes.

● Alarm count display

Displays the total number of alarms that have been generated.

(8) Camera title and VIDEO LOSS display

The title set for each camera is displayed.

"VIDEO LOSS" is displayed when there is no video input.

Displayed symbols

The meanings of the symbols shown in the operation display area during recording or playback are listed below.

(1) Operation symbol display	Description
REC	Recording
▶	Playback
	Still
◀◀	Rewind playback
▶▶	Fast-forward playback
▶	Slow playback
◀	Reverse slow playback
Playback speed display	
X7.5	7.5 times the normal playback speed
X15	15 times the normal playback speed
X30	30 times the normal playback speed
X180	180 times the normal playback speed
1/8	1/8 the normal playback speed
1/4	1/4 the normal playback speed
1/2	1/2 the normal playback speed
(2) Image quality display	
SUP	SUPER
HI	HIGH
STD	STANDARD
(3) Audio recording display	
A	Audio recording ON
(None)	Audio recording OFF
(4) Remaining time display	
120H	Displayed in 1 hour increments when the remaining time is 1 hour or more.
(7) Alarm count display	
AL00000	Displays the number of generated alarms.

Changing the position of the operation display

Press the [EXIT/OSD] button repeatedly.

Pressing the [EXIT/OSD] button repeatedly lets you move or erase the operation display area.

[EXIT/OSD] button

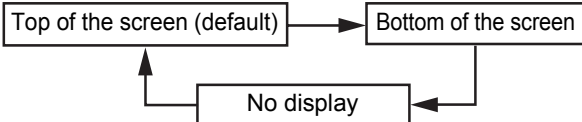
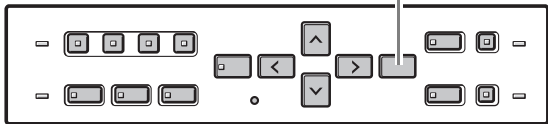

Example: Normal screen

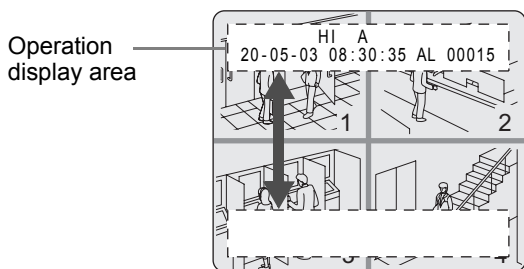

NOTE

- When the operation display is moved to the bottom of the screen, the camera titles are displayed at the top of each channel screen. When the operation display is moved to the top of the screen, the camera titles are displayed at the bottom of each channel screen. Camera titles are not displayed when the operation display is off.

To display the quad screen as single screens

Images are normally displayed in the quad screen. You can use the procedure below to display images in single screens.

To switch screens automatically, displaying each single screen in sequence

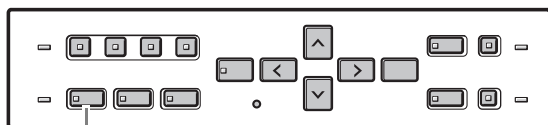

[QUAD/SEQUENCE] button

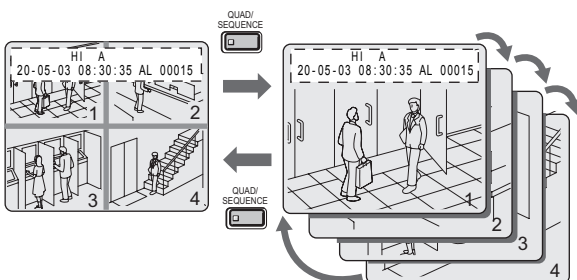

1 Press the [QUAD/SEQUENCE] button.

The image from each channel is displayed sequentially in single screens. Under the default settings, the channel switches automatically every 1 second.

To return to the quad screen

2 Press the [QUAD/SEQUENCE] button.

The quad screen is displayed.

To display the image from a specified channel in a single screen

Follow the steps below to display the image from a specified channel in a single screen.

[CHANNEL] buttons

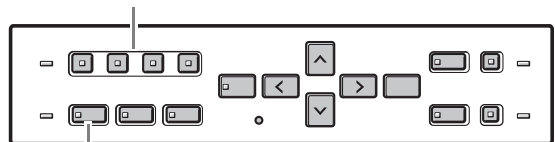

[QUAD/SEQUENCE] button

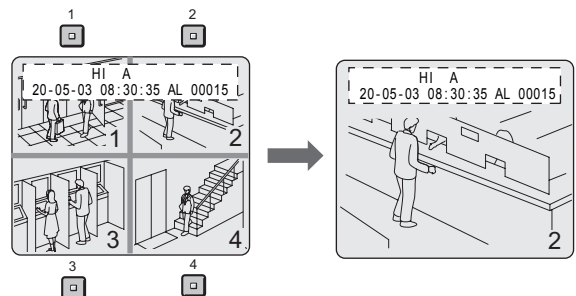

1 Press the desired [CHANNEL] button.

The indicator on the [CHANNEL] button lights. The image for the corresponding channel is displayed in the screen.

To return to the quad screen

2 Press the [QUAD/SEQUENCE] button.

The quad screen is displayed.

NOTE

- While the quad screen is displayed, press the [QUAD/SEQUENCE] button to toggle through single screens in sequence.
- The sequence function cannot be used on the playback screen.

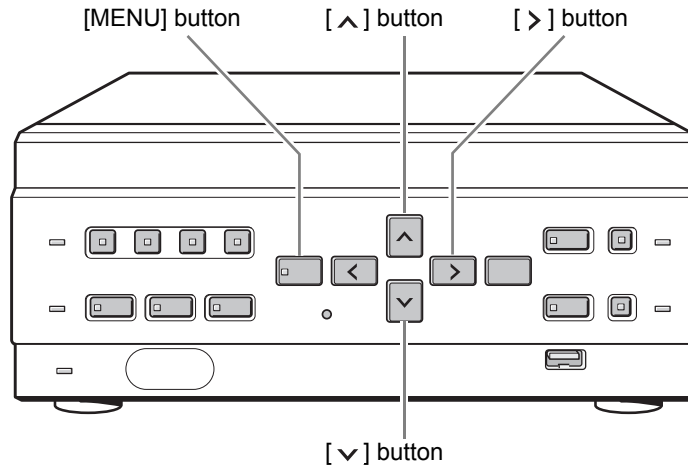

This section describes how to set the language displayed on the monitor and how to set the digital video recorder's internal clock.

[Settings] (◆ indicates default setting.)

Item	Setting	Description
(1) LANGUAGE	ENGLISH	Sets the language to English.
	◆中文	Sets the language to Chinese.
(2) CLOCK SET		Sets the date and time.

1 Press the [MENU] button.

The [MENU] button lights, and the <主菜单> (MAIN MENU) screen is displayed



2 Select, "1. 语言/时钟设置 (LANGUAGE/CLOCK SET)", and press the [>] button.

The <语言/LANGUAGE> screen is displayed. The cursor is positioned on "中文".



To change the language

3 Press the [>] button, then the [v] or [^] button to select the desired language.

The set item flashes.

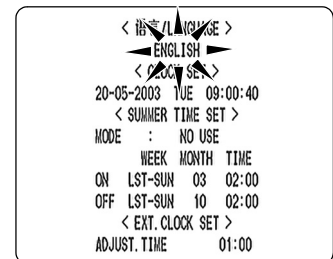

4 When you have made a selection, press the [>] button.

The cursor moves to the date and time.

The language has now been set.

To return to the normal screen, press the [EXIT/OSD] button.

Setting the time

(Default setting: 01-01-2003 WED 00:00:00)
 Be sure to set the correct date and time. The digital video recorder stores the times of recordings for use in operations such as playback and search/playback.

Example: Setting 20 May 2003, 8:30

1 Press the [MENU] button.

The [MENU] button lights, and the <MAIN MENU> screen is displayed

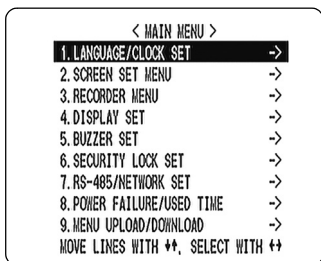

2 Select, “1. LANGUAGE/CLOCK SET”, and press the [>] button.

The <语言/LANGUAGE> screen is displayed. The cursor is positioned on “English”.

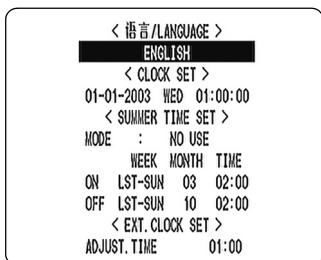

3 Press the [^] or [v] button to move the cursor to the date and time under <CLOCK SET>.

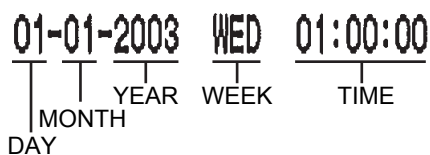
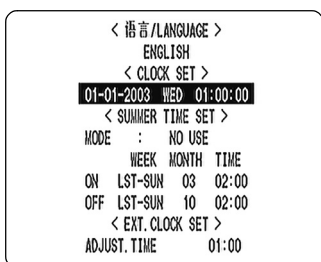

4 Press the [>] button.

“01” (indicating the day) flashes.



5 Press the [^] or [v] button to select “20”.



6 Press the [>] button.

“01” (indicating the month) flashes.



7 Use the same procedure to set the month (5 in this example), year (2003), hour (08) and minute (30).



When you have set the minute, the cursor moves to “MODE” under <SUMMER TIME>, and the clock starts from 00 seconds.

- “WEEK” is set automatically.
- The time is stopped during clock setting.

8 Press the [EXIT/OSD] button.

The display returns to the normal screen.

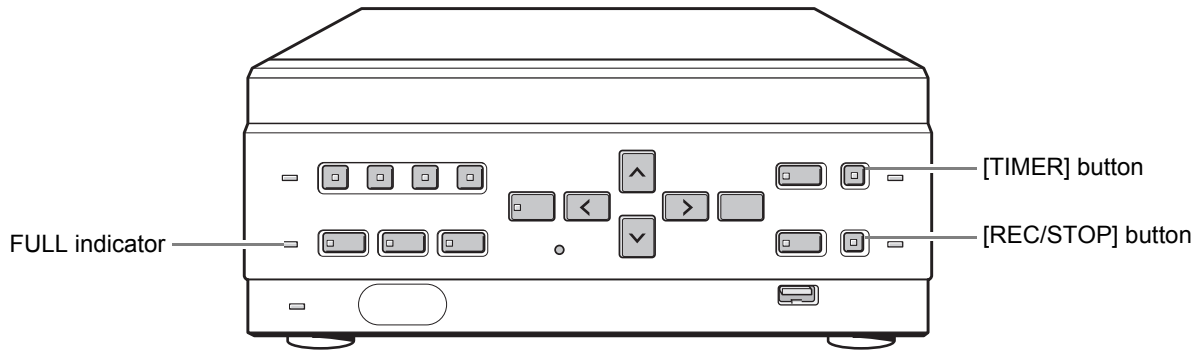

Normal recording

Follow the steps below to record the monitored image onto the hard disk.

! CAUTION

- When using the recorder for the first time, check that the TV SYSTEM selector switch on the rear panel is set to "PAL" correctly. If this switch is set incorrectly, recording will not be performed correctly. (→P. 8)

1 Press the [REC/STOP] button.

The REC/STOP indicator lights. "REC" appears on the screen, and recording starts.

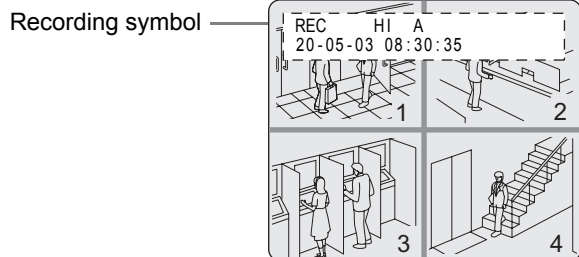

NOTE

- When you record for the first time, the default settings are used. To change the image quality. (→P. 32)
- When the OVER WRITE recording setting is "ON", the DVR starts recording from the beginning again. When it is "OFF" and the remaining space reaches zero, recording stops and the FULL indicator lights. (→P. 33)
- You can record and play back images at the same time. (→P. 17)
- You cannot change the menu during recording.

Ending normal recording

2 Press the [REC/STOP] button for about 3 seconds.

The REC/STOP indicator turns off and recording stops.

Timer recording

Follow the steps below to record the monitored image onto the hard disk at the set time.

1 Press the [TIMER] button.

The TIMER indicator lights, and the digital video recorder enters timer recording standby mode.

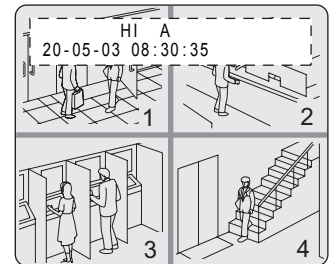

! CAUTION

- A warning tone sounds if timer recording has not been set.
 - See P. 35 for how to set timer recording.
 - When the time specified in the timer settings arrives, the REC/STOP indicator lights, "REC" appears in the screen, and recording starts.
 - When the set end time arrives, the REC/STOP indicator turns off, and recording stops.
 - The following restrictions apply to normal recording and timer recording.
 - After making "PICTURE QUALITY" or "AUDIO RECORDING" menu settings and returning to the camera screen, recording does not start for a maximum of 6 seconds (although normal recording and timer recording operations can be made).
 - After recording finishes (the REC/STOP indicator turns off), recording does not start for a maximum of 10 seconds (although normal recording and timer recording operations can be made).

NOTE

- When the remaining memory space for recording reaches zero, recording stops, and the FULL indicator lights. You can start recording from the beginning again by changing the "OVER WRITE" setting. (→P. 33)
- You can record and play back images at the same time. (→P. 17)

Stopping during timer recording

2 Press the [TIMER] button.

The TIMER indicator turns off and recording stops.

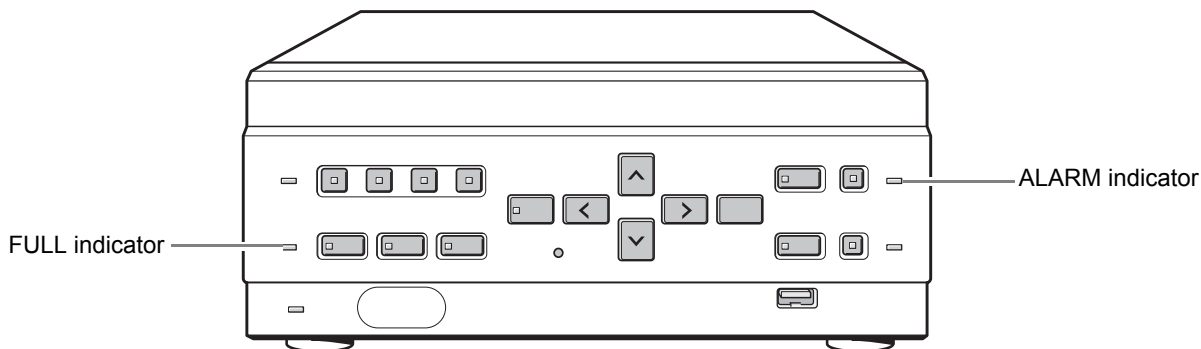

Alarm recording

Follow the steps below to have the digital video recorder record an alarm image only when alarm input is detected.

! CAUTION

- Check that the cable of the device required for alarms is connected to the ALARM terminal. (→P. 8)

NOTE

- When the motion sensor is set, an alarm image is recorded when a moving subject is detected. (→P. 30)

1 Set alarm recording.

The default settings are shown below. See P. 34 for how to change these settings.

- **ALARM MODE: "OFF"**
Alarm recording is disabled.
- **ALARM DURATION: "20SEC"**
Recording is performed for 20 seconds for each alarm signal received while the alarm is set.

2 When alarm input is detected.

When an alarm is generated, the display below appears in the operation display area, and an alarm image is recorded.

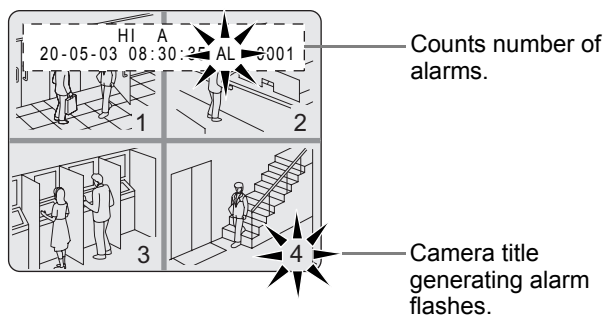

- "AL" appears in the operation display area.
- When an alarm is generated on a channel that is already alarm recording, the alarm recording time is extended counting from that moment. The new alarm is not counted, and the alarm count remains the same. If an alarm is generated on a separate channel, the alarm count increases.
- The latest 19,999 incidents are stored in the alarm history (recording list). Older incidents are erased.
- The camera title generating the alarm flashes.
- The panel's ALARM indicator flashes.

3 Ending alarm recording.

When the alarm duration time (default setting: 20 seconds) ends, "AL" disappears from the operation display, the ALARM indicator stops flashing, and recording stops.

NOTE

- When the hard disk's remaining space for recording reaches zero, the FULL indicator lights and recording stops. You can start recording from the beginning again by changing the recording setting. (→P. 33)
- Alarm recording is taken at the set PICTURE QUALITY (→P. 33)

! CAUTION

- The following restrictions apply to alarm recording.
 - (1) After recording starts (STOP→REC/STOP indicator lights).
 - (2) After making "PICTURE QUALITY" or "AUDIO RECORDING" menu settings and returning to the camera screen.
For (1) and (2):
 - Alarm input is not recognized for a maximum of 4 seconds. Alarm input after the 4 seconds are recognized as usual.
 - Recording does not start for a maximum of 6 seconds regardless of alarm input.
 - (3) After recording finishes (the REC/STOP indicator turns off).
 - Alarm input is not recognized for a maximum of 5 seconds. Alarm input after the 5 seconds are recognized as usual.
 - Recording does not start for a maximum of 10 seconds regardless of alarm input.

Follow the steps below to play back images recorded on the hard disk.

Playback

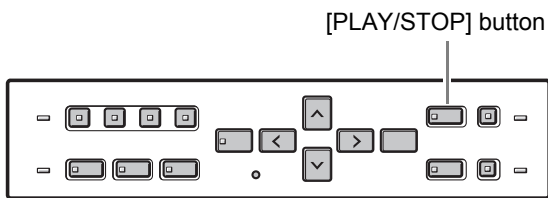

1 Press the [PLAY/STOP] button.

The [PLAY/STOP] button lights, and ► appears in the operation display area. The images recorded on the hard disk are played back in the quad screen.

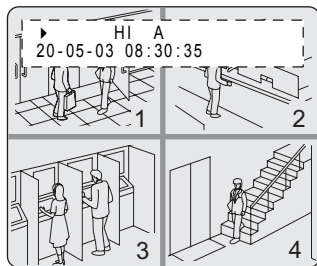

NOTE

- Image playback starts from the point at which recording started.
- If "OVER WRITE" has been set in the normal recording settings, playback starts with the oldest recorded image when the recording is played back for the first time.
- When playback ends, the digital video recorder pauses automatically. The [STILL] button lights, and (■) appears in the operation display area.
- After playback is stopped, it will resume from the stopped point the next time it is started.
- You can display quad screen images in single screens. (→P. 12)

Ending playback

2 Press the [PLAY/STOP] button.

Playback ends.

■ Playing back an image near the point of recording

The digital video recorder prioritizes recording operations, so the playback image may freeze temporarily.

Playback while fast-forwarding/rewinding

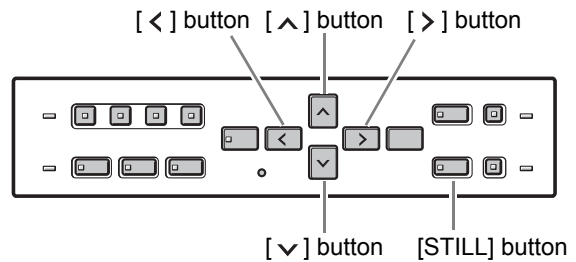

Press the [>] or [<] button during playback or when a still image is displayed.

When you press the [>] button, ►► appears in the operation display, and the playback fast-forwards at 7.5 times the normal playback speed.

When you press the [<] button, ◀◀ appears in the operation display, and the playback fast-rewinds at 7.5 times the normal playback speed.

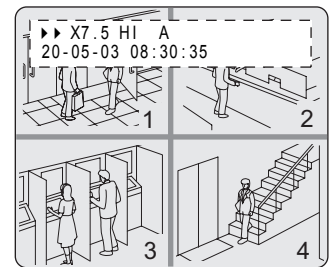

To change the fast-forward speed

Press the [^] button while fast-forwarding.

Press the button once to increase the speed to 15 times the playback speed, twice to increase the speed to 30 times the playback speed, and 3 times to increase the speed to 180 times the playback speed.

To change the fast-rewind speed

Press the [v] button while rewinding.

Press the button once to increase the speed to 15 times the playback speed, twice to increase the speed to 30 times the playback speed, and 3 times to increase the speed to 180 times the playback speed.

Ending fast-forward/rewind

Press the [PLAY/STOP] button.

Normal playback starts.

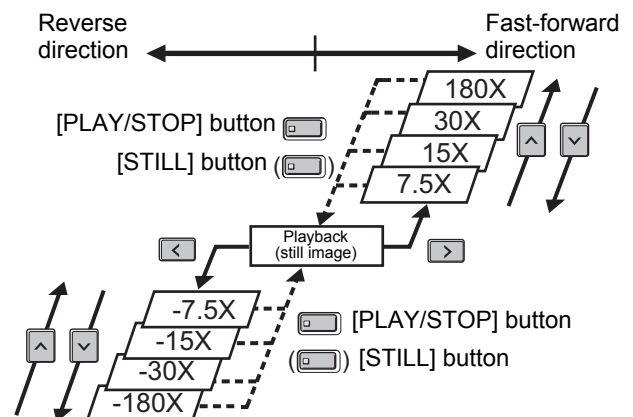

Viewing still images

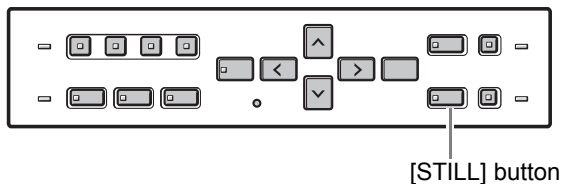

1 During playback, press the [STILL] button.

The image becomes a still image (freezes).

■ appears in the operation display area.

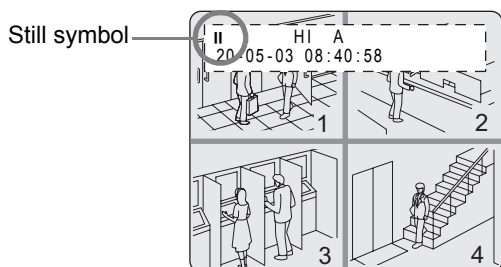

To resume playback

2 Press the [STILL] button.

Frame advance (reverse)

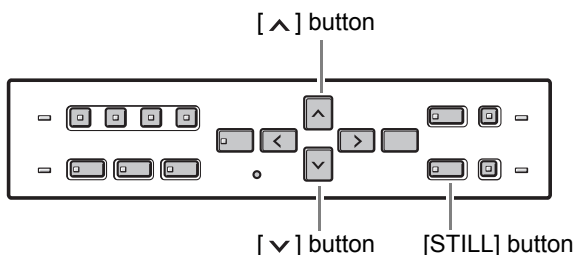

Press the [^] button while a still image is displayed.

The still image advances by one frame.

Press the [v] button while a still image is displayed.

The still image moves back three frames.

Slow playback

Press the [^] button for at least 2 seconds while a still image is displayed.

The playback speed slows to 1/8 the normal speed.

Pressing the [^] button again switches the playback speed to 1/4 the normal speed.

Pressing the button twice switches the playback speed to 1/2 the normal speed.

Slow reverse playback

Press the [v] button for at least 2 seconds while a still image is displayed.

The playback speed slows to 1/8 the normal speed.

Pressing the [v] button again switches the playback speed to 1/4 the normal speed.

Pressing the button twice switches the playback speed to 1/2 the normal speed.

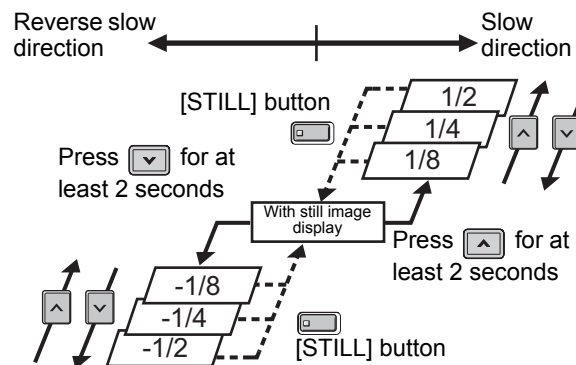

To playback audio

Follow the steps below to turn the audio ON or OFF, or switch the audio channels.

CHANNEL indicators

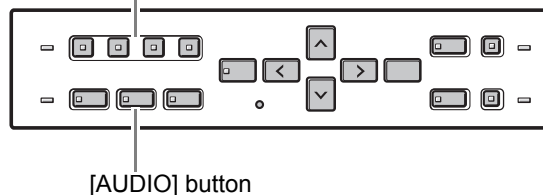

1 Press the [AUDIO] button.

The [AUDIO] button flashes during audio settings mode.

Each time you press the button, the audio channels switch as shown below.

The channel indicator lights when that channel is playing back.

Normal screen

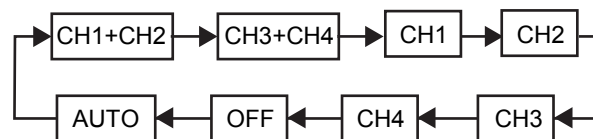

Playback screen

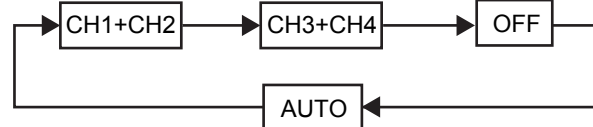

! CAUTION

- On the playback, you cannot playback audio from one specific channel.

Images recorded on the hard disk can be searched and played back. There are two search methods available.

Image to search

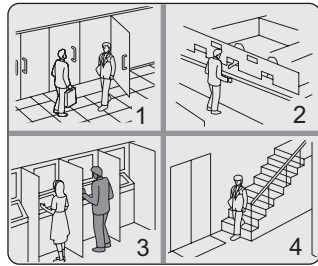

Search in <SEARCH> screen

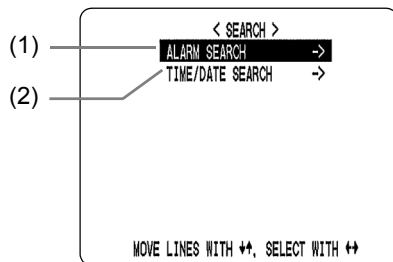

NOTE

- You can use the button operations to freeze, fast-forward or perform other operations on retrieved images being played back.

(1) ALARM SEARCH

Lets you search and play back alarm images from the recording list.

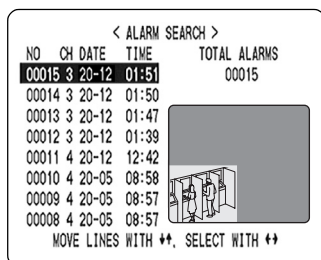

(2) TIME/DATE SEARCH (→P. 20)

Lets you search and play back recorded images by date/time.

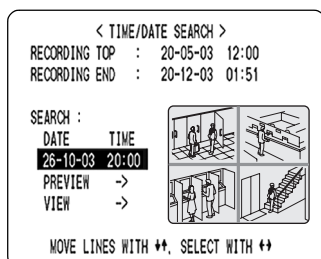

Alarm search

Lets you search and play back all the alarm images on the hard disk.

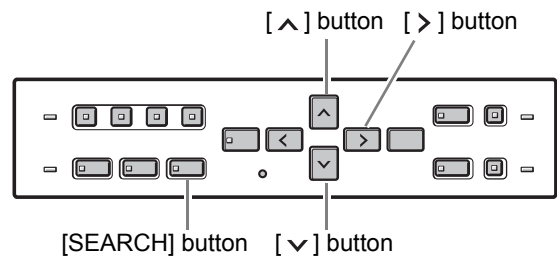

1 Press the [SEARCH] button while the digital video recorder is recording or stopped.

The <SEARCH> screen is displayed.

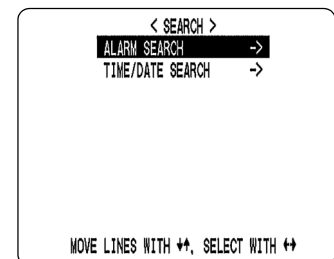

2 Check that "ALARM SEARCH" is selected, and press the [>] button.

The <ALARM SEARCH> screen is displayed.

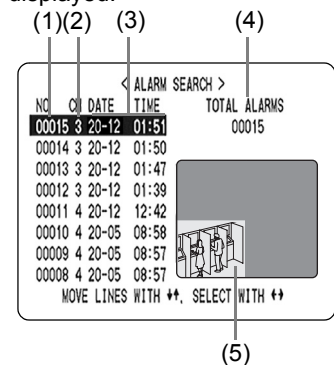

- NO:** Displays the alarm number.
- CH:** Displays the channels of the images that contain alarms.
- DATE/TIME:** Displays the date/time at which the alarm was received and the image recorded.
- TOTAL ALARMS:** Displays the total number of recorded alarm images.
- Preview screen:** The selected alarm image is displayed in the quad screen. (Unselected channels are masked.)

3 Press the [>] button.

The <TIME/DATE SEARCH> screen is displayed.
The cursor is positioned on the date and time item.

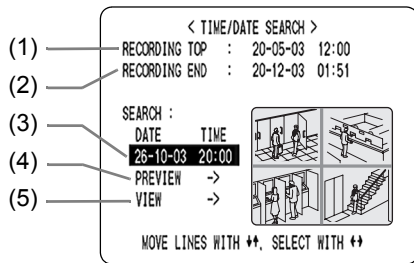

- (1) **RECORDING TOP:**
Displays the date/time of the image recorded first.
- (2) **RECORDING END:**
Displays the date/time of the image recorded last (latest image).
- (3) **SEARCH:**
Enter the date/time of the image to play back.
- (4) **PREVIEW:**
Select this item to display the preview screen.
- (5) **VIEW:**
Select this item to playback the image on the quad screen.

4 Press the [>] button, and set the date/time to search.

Example: To search for the image from 26 October 2003 20:00

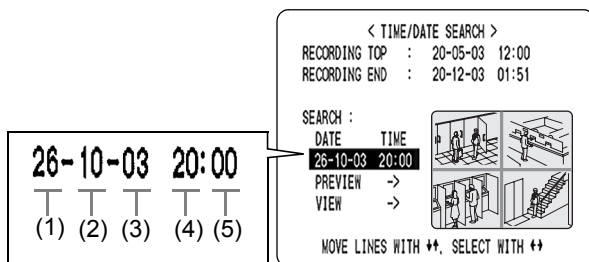

- (1) Press the [^] or [v] button to select "26" (the day).
- (2) Press the [>] button, and then the [^] or [v] button to select "10" (the month).
- (3) Press the [>] button, then the [^] or [v] button to select "03" (the year).
- (4) Press the [>] button, and then the [^] or [v] button to select "20" (the hour).
- (5) Press the [>] button to select "00" (the minute), then press the [>] button.
The cursor moves to PREVIEW.

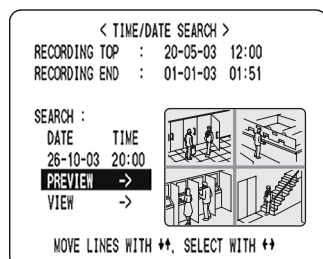

5 Press the [>] button.

- **If no image exists for the specified time**
The newest image for the selected time is displayed.
- **To end search mode**
Press the [EXIT/OSD] button.

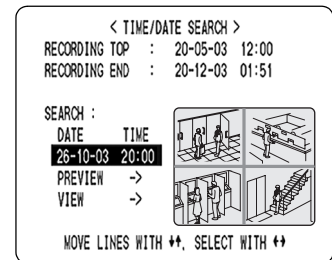

6 Press the [v] button to select "VIEW", then press the [>] button.

The preview screen image is played back in the quad screen.

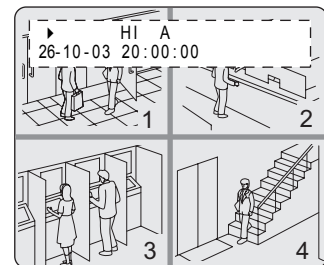

NOTE

- The retrieved image can be displayed in the quad screen format without displaying the preview screen by entering the date and time, and selecting "VIEW."
- You can use the button operations to freeze, fast-forward or perform other operations on retrieved images being played back.
- You can display quad screen images in single screens. (→P. 12)

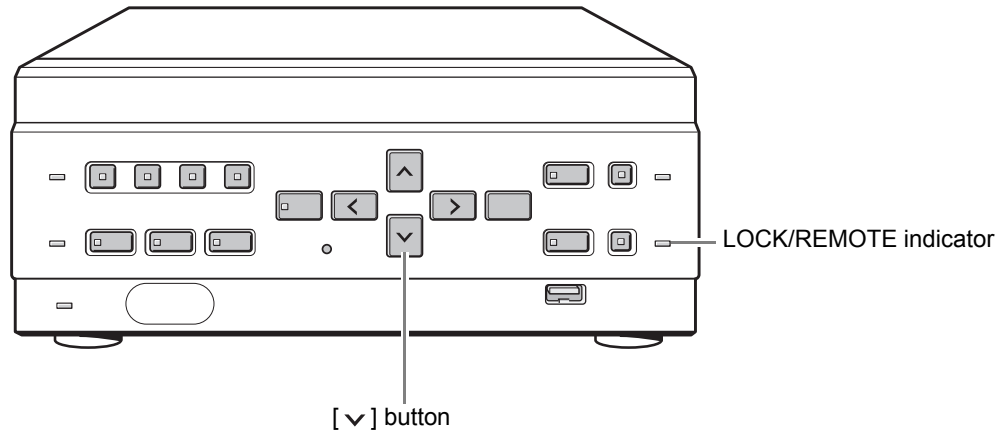

Follow the steps below to set the key lock function, preventing accidental pressing of the operation buttons.

Setting the key lock function

- 1 With the digital video recorder recording or stopped, press the [√] button for about 3 seconds.

When the key lock is set, a confirmation tone sounds, and the LOCK/REMOTE indicator lights.

NOTE

- The key lock setting is not released at power OFF.
- You cannot set the key lock during playback.

Releasing the key lock function

- 1 With the key lock function set, press the [√] button for about 3 seconds.

When the key lock is released, a confirmation tone sounds, and the LOCK/REMOTE indicator turns off.

CAUTION

- When the key lock function has been set, the buttons cannot be used for settings or operations.
- When the security lock is set, you cannot set the key lock alone.
- If you have already set the security lock, the password entry screen is displayed. (→P. 44)

MENU CONFIGURATION AND OPERATIONS

This section describes the menu configuration, and which menu item to select for each operation.

Displaying menu screens and setting screens

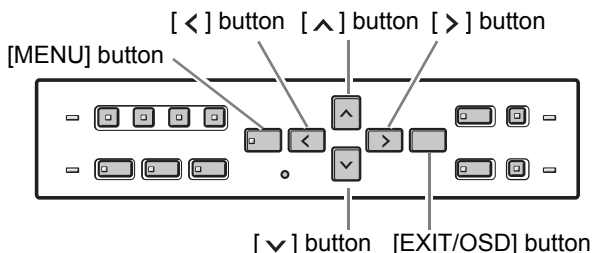

1 Press the [MENU] button.

The <MAIN MENU> screen is displayed.



2 Press the [^] or [v] button to select the desired sub-menu or setting screen.

(Example: Selecting "5. BUZZER SET")

When you move the cursor, the selected item is displayed in reverse.

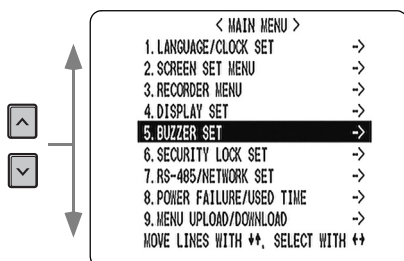

3 Press the [>] button.

The selected sub-menu or setting screen is displayed. The cursor is positioned on the first setting item. For some sub-menus, lower-level menus can be selected.

To exit a menu screen

4 Press the [EXIT/OSD] button.

The display returns to the normal screen.

NOTE

- You can display the menu screen during recording, but not during playback.
- Press the [<] button to return to the menu screen from the sub-menu screen.

CAUTION

- You cannot change menu settings while recording.

Changing settings

Use the [^], [v], [<] and [>] buttons to change settings in setting screens.

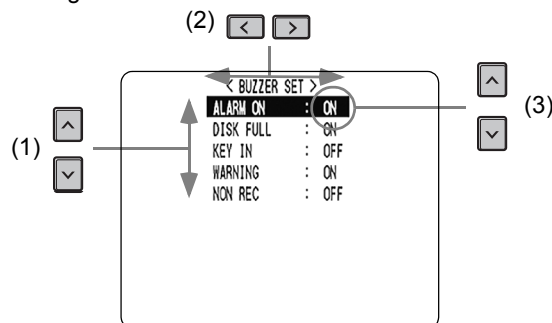

- To move the cursor up/down**
Press the [^] or [v] button.
- To move the cursor right or to a setting item**
Press the [<] or [>] button.
- To change a setting value**
Press the [^] or [v] button.

To restore menu setting items to their initial values

Follow the steps below to restore the settings in the displayed setting screen to their initial values. Only the displayed settings are restored.

- Display the desired setting screen.**
- Press the [MENU RESET] button.**

The displayed settings are restored to their initial values.

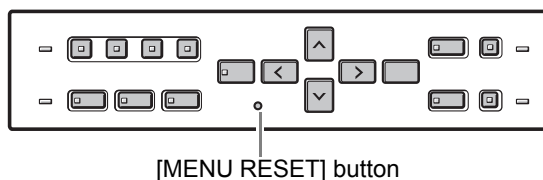

Overview of sub-menus

The screens below are the sub-menu screens or setting screens displayed by selecting items from the <MAIN MENU> screen.

Each time you press the [MENU] button, each of the screens shown on this page is displayed in the order shown.

1. LANGUAGE/CLOCK SET (→P. 25)

Enables the following settings:

- Screen display language
- Digital video recorder's date and time settings
- Summer time settings
- Time synchronization with external devices

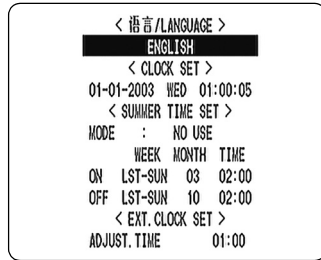

2. SCREEN SET MENU (→P. 28)

Lets you make the following screen-related settings:

- Screen display method
- Camera titles Nos.
- Motion sensor for detecting moving subjects

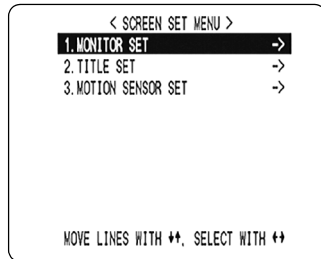

3. RECORDER MENU (→P. 32)

Lets you make various recording settings, and initialize the hard disk.



4. DISPLAY SET (→P. 40)

Lets you display or hide items of information in the operation display area.

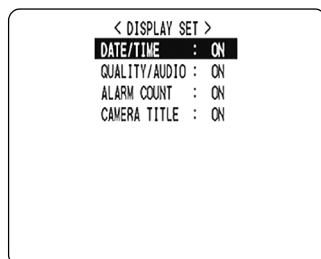

5. BUZZER SET (→P. 41)

Lets you enable or disable alarms for various events.



6. SECURITY LOCK SET (→P. 42)

Lets you set passwords to prevent unauthorized users from operating the digital video recorder.

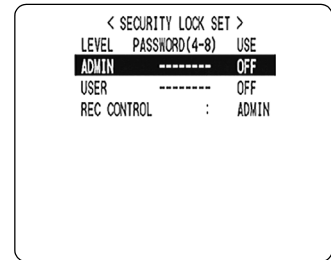

7. RS-485/NETWORK SET (→P. 45)

Used to make the settings needed when connecting the digital video recorder to an external device by RS-485 interface, or to a PC via a network (LAN).

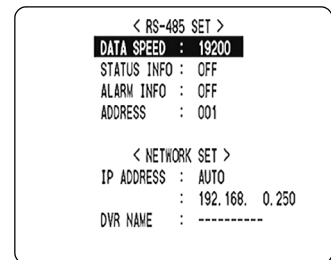

8. POWER FAILURE/USED TIME (→P. 47)

Lets you check the date/time of power failures and the amount of hard disk operation time.

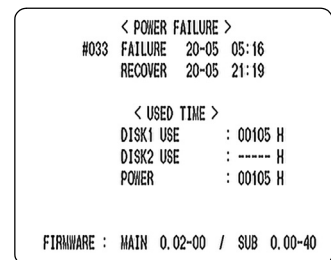

9. MENU UPLOAD/DOWNLOAD (→P. 48)

Lets you save menu setting values onto a CompactFlash card. Also lets you read menu setting values saved on CompactFlash cards. Formats CompactFlash cards.



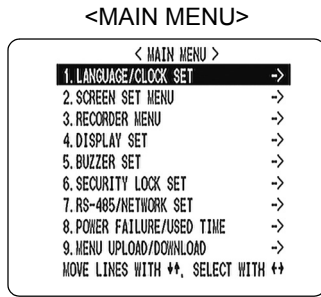

You can perform the following functions:

- Change the language used to display on screen information.*
- Set the date and time displayed on the normal screen.*
- Set the clock to adjust automatically for summer time.
- Set all the devices to the same time automatically when multiple devices are connected.

* See P. 13.

<SUMMER TIME> settings

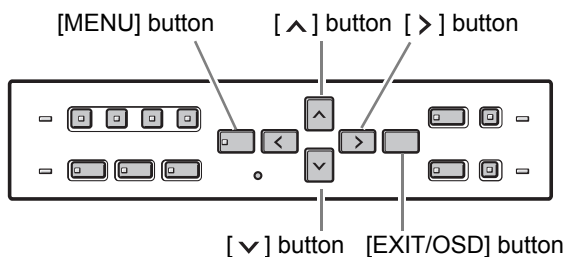

1 Press the [MENU] button.

The [MENU] button lights, and the <MAIN MENU> screen is displayed.

2 Select “1. LANGUAGE/CLOCK SET”, and press the [>] button.

The <语言/LANGUAGE> screen is displayed with the cursor positioned on “ENGLISH”.

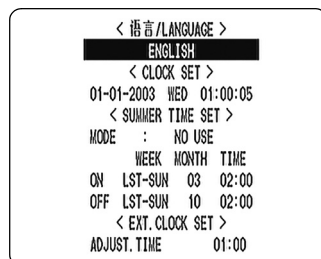

3 Press the [v] or [^] button to select “MODE” under <SUMMER TIME>.

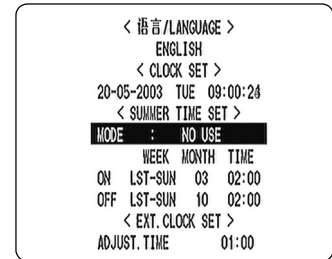

4 Press the [>] button.

“NO USE” flashes.

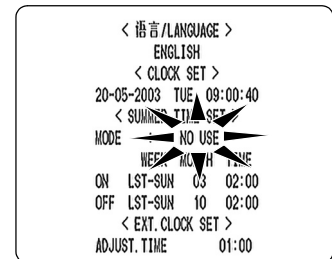

5 Press the [v] or [^] button to change the setting.

[Settings] (◆ indicates default setting.)

Setting	Description
USE	Time is automatically adjusted to summer time.
◆ NO USE	Time is not automatically adjusted to summer time.

6 Press the [>] button.

The cursor moves to the date/time at which to switch from standard time to summer time.

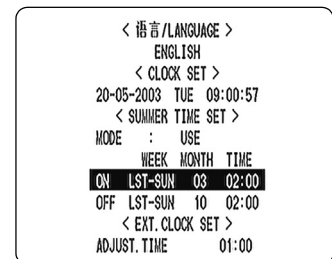

When "USE" is selected for "MODE" under <SUMMER TIME>.

You can set the date/time at which the time is switched from standard time to summer time, and the date/time at which the time is switched back again. The example below is the default value.

Example:

After the clock display reaches 30 March 2003, 01:59, the next clock display is 03:00, putting the clock an hour ahead (summer time).

After the clock display reaches 26 October 2003, 01:59, the next clock display is 01:00, putting the clock an hour behind (back to standard time).

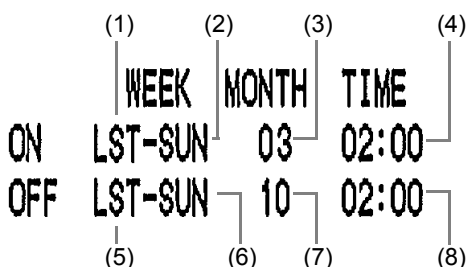

- (1) Sets the week for switching to summer time.
- (2) Sets the day of the week.
- (3) Sets the month.
- (4) Sets the time.
- (5) Sets the week for ending summer time.
- (6) Sets the day of the week.
- (7) Sets the month.
- (8) Sets the time.

7 Press the [>] button.

The cursor moves to "LST".

8 Press the [v] and [^] buttons to select the desired week, then press the [>] button.

The cursor moves to the day of the week.

9 Press the [v] and [^] buttons to select the desired day of the week, then press the [>] button.

The cursor moves to "MONTH".

10 Press the [v] and [^] buttons to select the desired month, then press the [>] button.

The cursor moves to "TIME".

11 Press the [v] and [^] buttons to select the desired time, then press the [>] button.

The cursor moves to the minutes portion of the time. Set the desired minutes in the same manner. The <SUMMER TIME> settings are now finished.

<EXT.CLOCK SET> settings

This section describes how to have the time synchronized automatically when two or more digital video recorders are connected. If you set the <EXT.CLOCK SET> time to 5:00, all the connected devices are synchronized to the same time (to the nearest second) every day at 5:00. (Default setting: 01:00)

1 Use a cable to connect the CLOCK ADJ OUT terminal on the rear panel of one digital video recorder to the CLOCK ADJ IN terminal on the second digital video recorder.

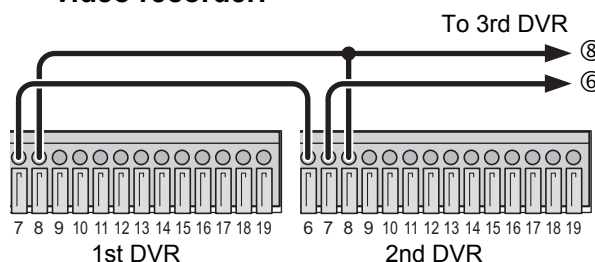

- Terminal No.
- 6: CLOCK ADJ IN
 - 7: CLOCK ADJ OUT
 - 8: COMMON

! CAUTION

- Do not use a loop connection.

2 Press the [v] and [^] button to move the cursor to "ADJUST. TIME".

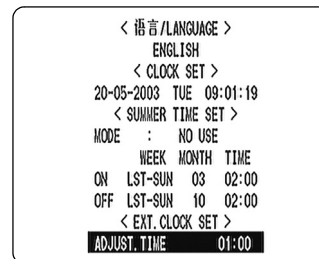

3 Press the [>] button.

"01" flashes.

4 Press the [v] and [^] button to select the desired time, then press the [>] button.

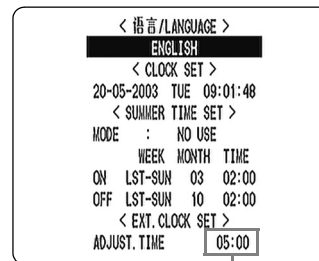

Set the time

5 Press the [EXIT/OSD] button.

The display returns to the normal screen.

6 Repeat procedures 2 to 5 to set the time on the second digital video recorder.

When you have finished making the settings, the display returns to the normal screen.

When the digital video recorder is connected to a PC or other external device through a network, you can also set the time from that device. When connected to a PC, see the instructions for the VA-SW804/VA-SW80LITE application software.

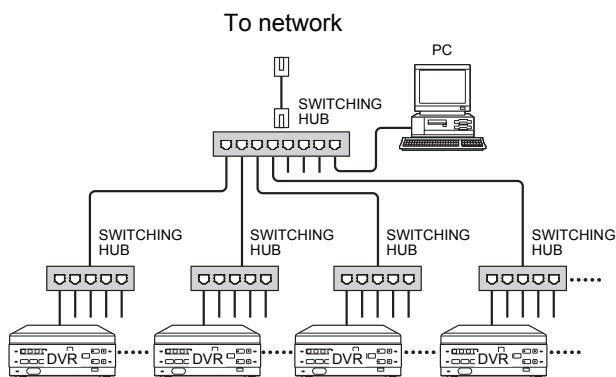

! CAUTION

- Subsequent digital video recorders must be synchronized with the first unit for "ADJUST. TIME."
- Do not use a loop connection.

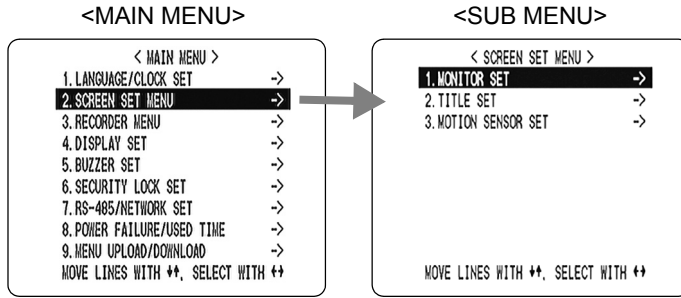

Screen settings

MONITOR SET

- “SEQUENCE” is used to set the time interval used for switching screens when displaying the image from each channel sequentially.

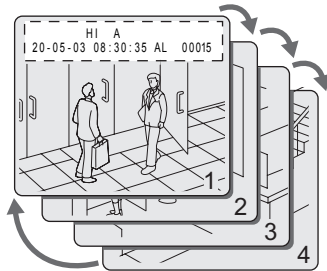

- “DISPLAY” setting is used when an alarm is generated. It sets whether to display the image from the channel that generated the alarm on a single screen, or whether to display on the quad screen.

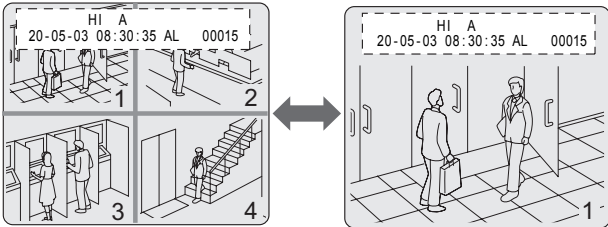

- “ALARM PRIORITY” sets the display method for alarm recording screens when an alarm is generated on another channel during alarm recording.

Example 1: Displays screens in order of alarms.

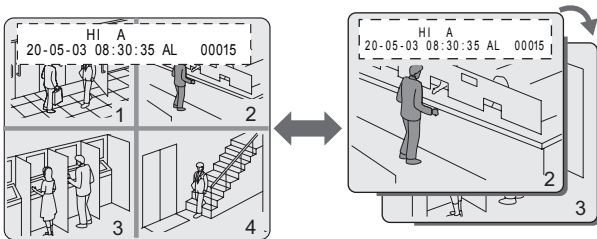

Example 2: Displays alarm recordings on the single screen sequentially.

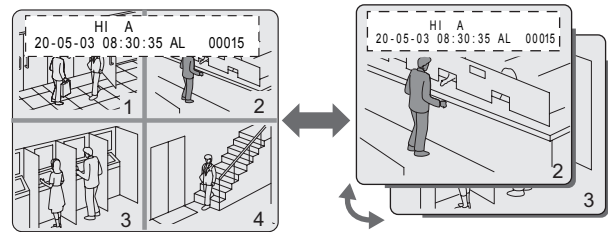

- “MASK SET” is used to hide the monitor display of some channel images in the normal screen and playback screen.

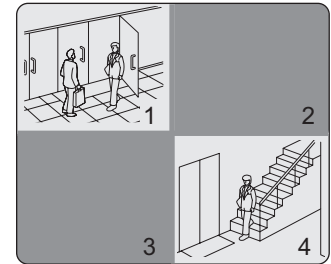

TITLE SET

- Lets you set titles for camera Nos.

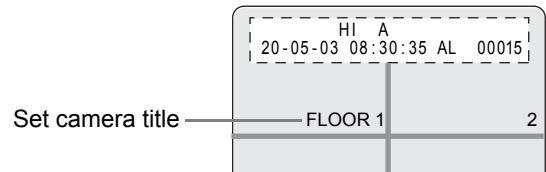

MOTION SENSOR SET

- If the motion sensor is set on the monitor, enables alarm recording when a moving subject is detected.

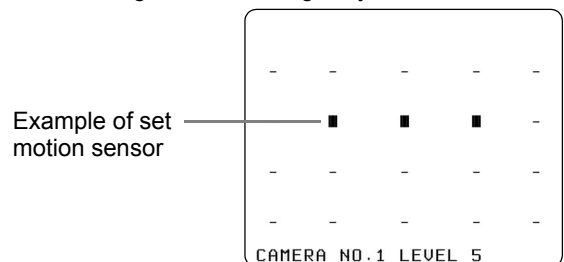

MONITOR SET

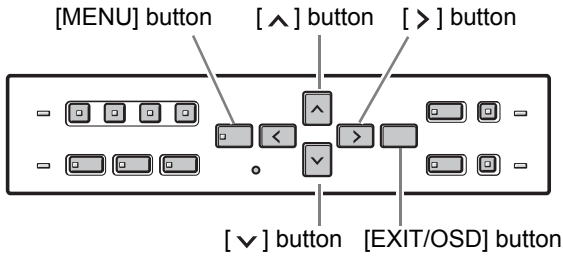

1 Press the [MENU] button.

The [MENU] button lights, and the <MAIN MENU> screen is displayed.

2 Select "2. SCREEN SET MENU", and press the [>] button.

The <SCREEN SET MENU> screen is displayed.

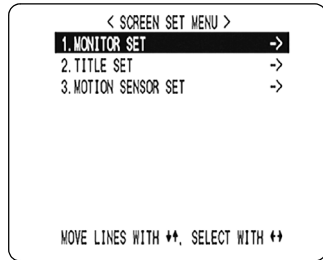

3 Select "1. MONITOR SET", and press the [>] button.

The <MONITOR SET> screen is displayed.

4 Press the [v] or [^] buttons to select the desired item, then press the [>] button.

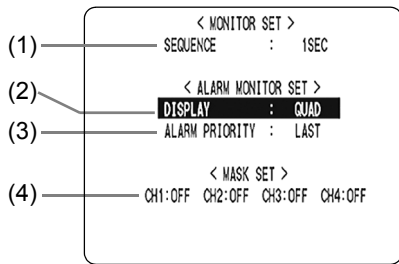

[Settings] (◆ indicates default setting.)

Item	Setting	Description
(1) SEQUENCE	1 to 30 seconds (1 second units) ◆1SEC	Sets time interval used for switching screens when displaying image from each channel sequentially.
(2) DISPLAY	FULL	When alarm occurs, displays image from channel that generated alarm in single screen.
	◆QUAD	When alarm occurs, displays images in quad screen.

Item	Setting	Description
(3) ALARM PRIORITY	◆LAST	Displays alarm images in order starting with the most recent when multiple alarms are generated.
	FIRST	Displays the first alarm image only when multiple alarms are generated.
	SWITCH	Flashes through alarm images in one second intervals when multiple alarms are generated.
(4) MASK SET CH1/2/3/4	ON	Masks image and sound of set channel.
	◆OFF	Plays image and sound.

NOTE

- "ALARM PRIORITY" settings are active only when the "DISPLAY" settings are "FULL."

5 Press the [v] or [^] buttons to change the setting, then press the [>] button.

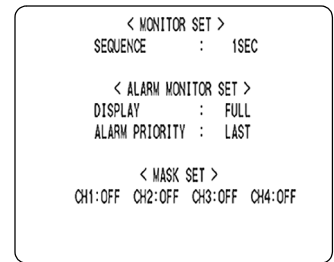

6 Repeat procedures 4 to 5 to set other items as needed.

7 When you have finished making the settings, press the [EXIT/OSD] button.

The display returns to the normal screen.

Camera title setting

Camera titles can be up to 10 characters in length. You can enter the following characters and symbols: 0 to 9, A to Z, - (hyphen), : (colon), . (period), / (slash), * (asterisk), _ (underbar), (space)

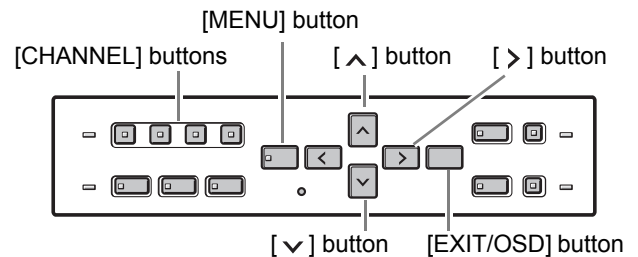

1 Press the [MENU] button.

The [MENU] button lights, and the <MAIN MENU> screen is displayed.

2 Select “2. SCREEN SET MENU”, and press the [>] button.

The <SCREEN SET MENU> screen is displayed.

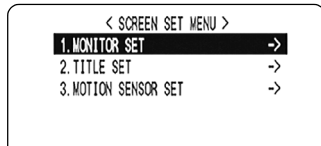

3 Select “2. TITLE SET”, and press the [>] button.

The <CAMERA NO.1> screen is displayed.

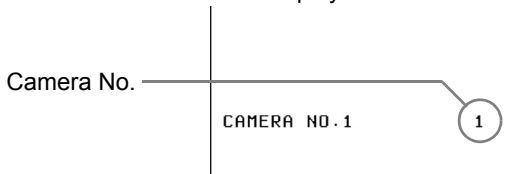

The default values are shown below.

CAMERA No.	Default value
CAMERA NO.1	1
CAMERA NO.2	2
CAMERA NO.3	3
CAMERA NO.4	4

4 Press the desired [CHANNEL] button to select the desired camera No.

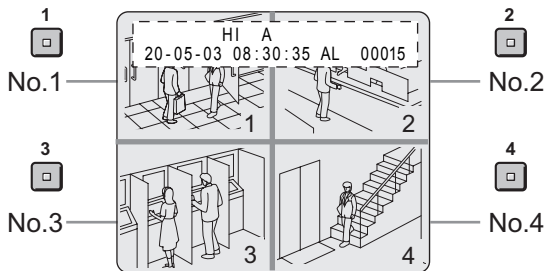

5 Press the [>] button to make “■” flash.



6 Press the [v] or [^] button to start entering the camera title.

You can enter up to 10 characters/symbols. Each time you press the [^] or [v] button, the display toggles as follows:

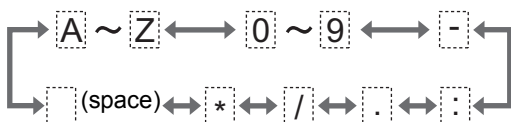

Input example: “FLOOR 1”



7 Press the [>] button.

The characters are entered, and the cursor moves to the right.

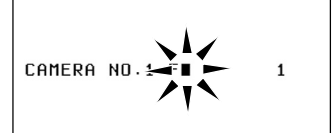

8 Repeat procedures 6 to 7 to enter the second and subsequent characters.



9 When you have finished making the settings, press the [EXIT/OSD] button.

The display returns to the normal screen. The screen displays the set camera title.

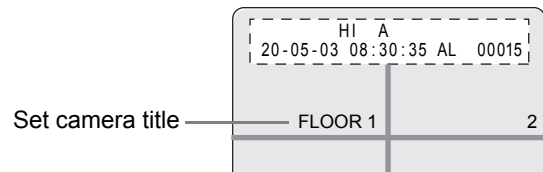

Setting the motion sensor

By setting the motion sensor on the monitor, any movement by the subject will automatically activate alarm recording.

You can set the following items:

- Motion detection position on screen
- No. of camera for which to set motion sensor
- Motion sensor level (Default setting is OFF.)

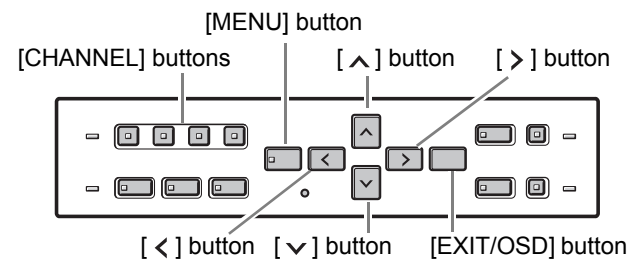

1 Press the [MENU] button.

The [MENU] button lights, and the <MAIN MENU> screen is displayed.

2 Select “2. SCREEN SET MENU”, and press the [>] button.

The <SCREEN SET MENU> screen is displayed.

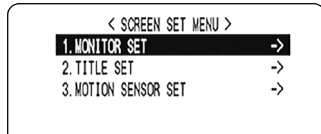

3 Select “3. MOTION SENSOR SET”, and press the [>] button.

The motion sensor setting screen for camera No. 1 appears.

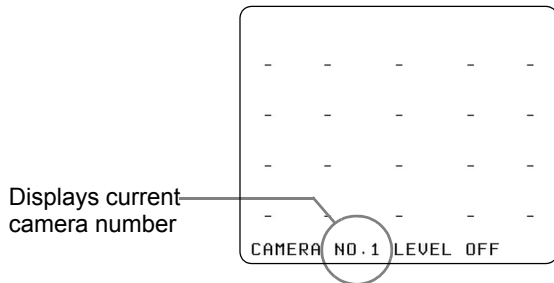

4 Press the desired [CHANNEL] button to select the desired camera No.

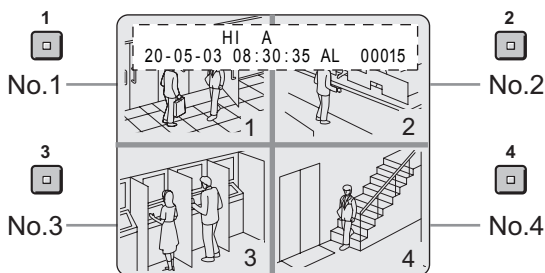

5 Press the [>] or [<] button to select “LEVEL,” then press the [v] or [^] button to set the sensitivity.

The level can be set to a value between 1 and 10. The lower the value, the higher the sensitivity. (Default setting: OFF)

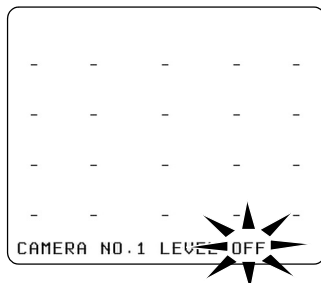

NOTE

- A confirmation tone sounds when making sensor settings.

6 Press the [>] or [<] button to select a sensor operation position, then press the [v] or [^] button to set the selection (you can set up to 20 positions).

You can set sensor operation positions at any screen position.

● Moving the cursor

Each time you press the [>] button, the cursor moves from left to right in the top row. After the cursor has reached the end of the row, it moves from left to right in the row below. You can press the [<] button to move the cursor in the opposite direction.

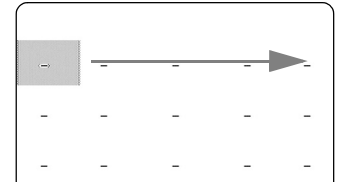

Pressing and holding the [>] or [<] button moves the cursor as follows:

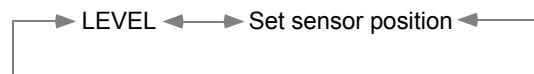

● Setting sensor operation positions

Pressing the [v] or [^] button once enables the currently selected position to set (displays ■). Pressing the [v] or [^] button again disables the setting (displays -).

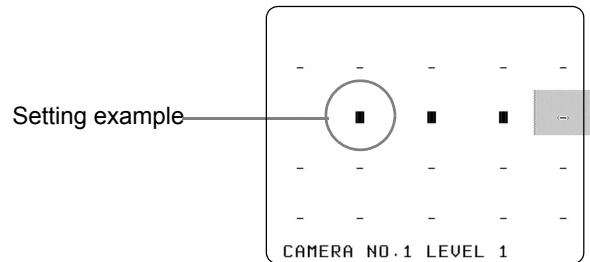

NOTE

● Operation position setting example

If you set an area near the centre of the image, the sensor operates and recording starts when a moving subject near the centre of the screen is detected.

7 When you have finished making the settings, press the [EXIT/OSD] button.

The display returns to the normal screen.

NOTE

- To activate alarm recording when the motion sensor detects movement, display the <RECORD MENU>, and set the “ALARM TRIGGER” in “ALARM REC MODE SET” to “SENSOR.” (→P. 34)

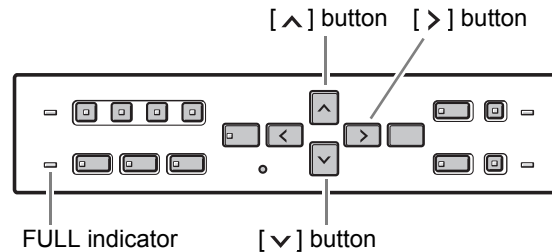
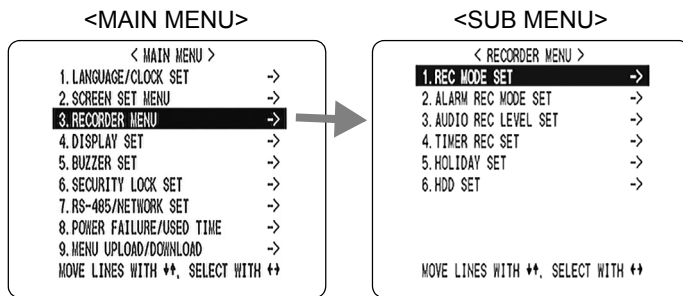

Setting items

The <RECORDER MENU> screen lets you make the following recording-related settings:

	Item	Description
1	REC MODE SET	<ul style="list-style-type: none"> Changes the recording image quality. Turns audio recording ON/OFF. Sets whether to stop recording or to record over previously recorded images, when the hard disk becomes full. When multiple digital video recorders are connected, sets recording to continue automatically on the second and subsequent hard disks when the first hard disk becomes full.
2	ALARM REC MODE SET	<ul style="list-style-type: none"> Turns alarm recording ON/OFF. Sets the amount of time to record for when an alarm is generated. Sets alarm trigger Sets the operation to perform when the camera image is interrupted.
3	AUDIO REC LEVEL SET	Sets audio sensitivity level for each channel. Set high value for high sensitivity.
4	TIMER REC SET	Sets timer recording.
5	HOLIDAY SET	Lets you set specific work days as holidays.
6	HDD SET	Initializes the hard disk, or used when adding a hard disk.

To record in series when multiple digital video recorders are connected

Connect the control terminals by cables as shown below.

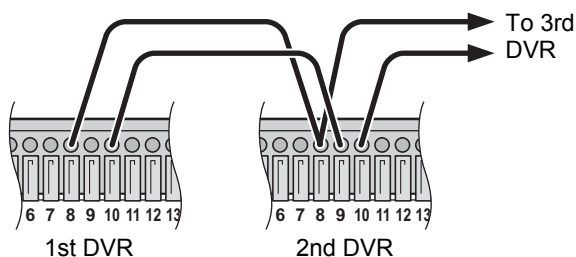

Terminal No.
 8: COMMON
 9: SERIES REC IN
 10: NON REC OUT/SERIES REC OUT

REC MODE SET

1 Press the [MENU] button.

The [MENU] button lights, and the <MAIN MENU> screen is displayed.

2 Select "3. RECORDER MENU", and press the [>] button.

The <RECORDER MENU> screen is displayed, with the cursor positioned on "1. REC MODE SET".



3 Press the [>] button.

THE <REC MODE SET> screen is displayed, with the cursor positioned on "PICTURE QUALITY".

4 Press the [v] or [^] buttons to select the desired item, then press the [>] button.

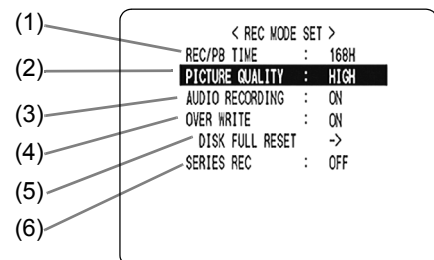

NOTE

- "REC/PB TIME" changes automatically according to the "PICTURE QUALITY" set.

[Settings] (◆ indicates default setting.)

	Item	Setting	Description
(1)	REC/PB TIME	-	Displays the possible recording time.
(2)	PICTURE QUALITY	SUPER (SUP)	Highest image quality. Recording time: At least 84 hours (120 GB), or at least 168 hours (240 GB)
		◆ HIGH (HI)	High image quality. Recording time: At least 168 hours (120 GB), or at least 336 hours (240 GB)
		STANDARD (STD)	Standard image quality. Recording time: At least 336 hours (120 GB), or at least 672 hours (240 GB)
(3)	AUDIO RECORDING	◆ ON	Performs audio recording.
		OFF	Doesn't perform audio recording.
(4)	OVER WRITE	◆ ON	When the hard disk runs out of space, recording automatically starts again from the beginning, recording over previously recorded images.
		OFF	When the hard disk runs out of space, the FULL indicator flashes and recording stops.
(5)	DISK FULL RESET	◆ NO	Does not overwrite. The <WARNING> screen is displayed, and "NO" flashes.
		YES	Images can be recorded over previously recorded images once. The <WARNING> screen is displayed. Press the [∨] or [∧] button to select "YES".
(6)	SERIES REC	◆ OFF	Doesn't perform series recording.
		-1M	When multiple digital video recorders are connected, about 1 minute before the first recorder's hard disk becomes full, the second recorder's hard disk starts recording.
		-2M	When multiple digital video recorders are connected, about 2 minutes before the first recorder's hard disk becomes full, the second recorder's hard disk starts recording.
		-3M	When multiple digital video recorders are connected, about 3 minutes before the first recorder's hard disk becomes full, the second recorder's hard disk starts recording.

* If the hard disk becomes full when item (4) OVER WRITE is set to "OFF", the operation performed is determined by the setting of item (5) DISK FULL RESET. For how to set this item, see "Resetting when the FULL indicator lights" on the right.

* (6) SERIES REC can be set when the OVER WRITE is set to "OFF".

5 Press the [∨] or [∧] button to change the setting, then press the [>] button.

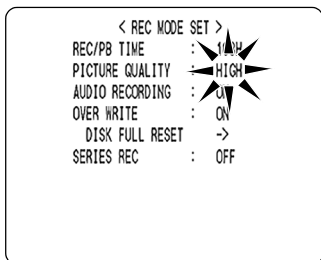

6 Repeat procedures 4 to 5 to set other items as needed.

7 When you have finished making the settings, press the [EXIT/OSD] button.

The display returns to the normal screen.

Resetting when the FULL indicator lights

When "OVER WRITE" is set to "OFF" and the hard disk becomes full, the FULL indicator lights and recording stops. To start recording again, follow the steps below to overwrite recorded images.

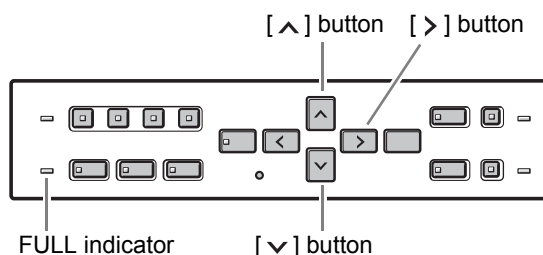

1 Display the <REC MODE SET> screen.

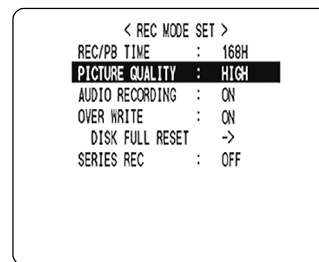

2 Press the [∨] or [∧] button to select "DISK FULL RESET", then press the [>] button.

The <WARNING> screen is displayed, with "NO" flashing.



3 Press the [∨] or [∧] button to select "YES", then press the [>] button.

The normal screen is displayed, and the FULL indicator turns off. The DVR is ready to record again.

ALARM REC MODE SET

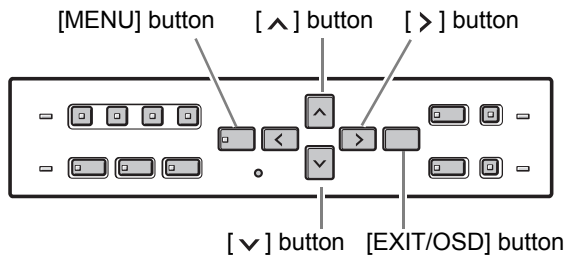

1 Press the [MENU] button.

The [MENU] button lights, and the <MAIN MENU> screen is displayed.

2 Select "3. RECORDER MENU", and press the [>] button.

The <RECORDER MENU> screen is displayed.



3 Press the [^] or [v] button to select "2. ALARM REC MODE SET", then press the [>] button.

The <ALARM REC MODE SET> screen is displayed, with the cursor positioned on "ALARM MODE".

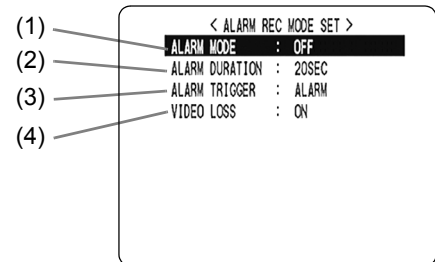

[Settings] (◆ indicates default setting.)

	Item	Setting	Description
(1)	ALARM MODE	◆ OFF	Doesn't perform alarm recording.
		ENABLED	Always performs alarm recording, whether or not timer recording is being performed.
		AL-REC ON TIMER	Performs alarm recording only during timer recording.
		AL-REC OFF TIMER	Performs alarm recording only when timer recording is not being performed.
		OLY AL-RC ON TMR	Performs alarm recording only for the amount of time set by the timer. Doesn't return to timer recording standby.
(2)	ALARM DURATION	Time selections*: CC/5SEC/10SEC/20SEC(◆)/40SEC/1MIN/2MIN/3MIN/4MIN/5MIN/10MIN/15MIN Sets the amount of time for recording when a single alarm is generated.	
(3)	ALARM TRIGGER	Selects how to detect intruders.	
		◆ ALARM	Performs alarm recording when an external alarm is generated (when a switch is attached to the alarm input terminal on the rear panel, and the switch is activated).
		SENSOR	Performs alarm recording when the motion sensor detects movement. See the information on setting the motion sensor. (→P. 30)
		ALARM OR SENSOR	Performs alarm recording when either the external alarm or motion sensor is activated.
(4)	VIDEO LOSS	◆ ON	Displays "VIDEO LOSS" on the screen when the camera image is interrupted. Also outputs the WARNING signal to a rear panel terminal.
		OFF	Doesn't display "VIDEO LOSS" on the screen when the camera image is interrupted.

*CC: Operates while alarm is active. (Operates for more than 5 seconds per alarm.)

4 Press the [∨] or [∧] button to select the desired item, then press the [>] button.

The setting flashes.

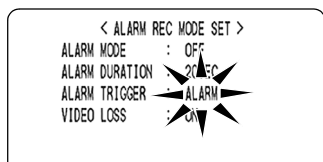

5 Press the [∨] or [∧] button to change the setting, then press the [>] button.

6 Repeat procedures 4 to 5 to set other items as needed.

7 When you have finished making the settings, press the [EXIT/OSD] button.

The display returns to the normal screen.

AUDIO REC LEVEL SET

1 Press the [MENU] button.

The [MENU] button lights, and the <MAIN MENU> screen is displayed.

2 Select “3. RECORDER MENU”, and press the [>] button.

The <RECORDER MENU> screen is displayed.

3 Press the [∨] or [∧] button to select “3. AUDIO REC LEVEL SET”, then press the [>] button.

The <AUDIO REC LEVEL SET> screen is displayed.

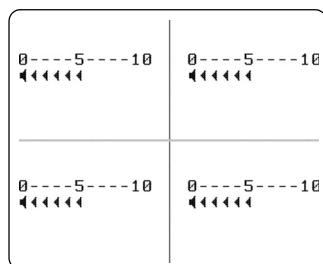

4 Select the channel and change sensitivity

Each time you press the [>] button, the display switches between possible channels. The sensitivity marks on the screen flashes for the selected channel.

To increase level: Use the [∧] button.

To decrease level: Use the [∨] button.

NOTE

- Many sensitivity marks indicate high sensitivity.

5 When you have finished making the settings, press the [EXIT/OSD] button.

The display returns to the normal screen.

Timer recording settings

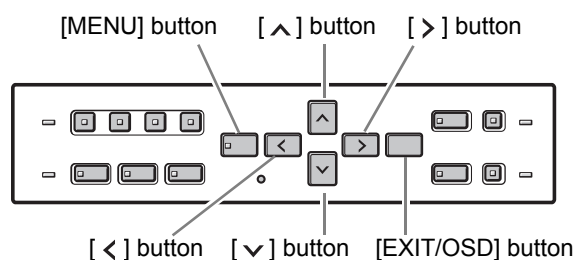

Timer setting items

You can use the timer functions to set recording start/stop times.

	(1)	(2)	(3)	(4)
	WEEK	START	STOP	SET
	SUN	--:--	--:--	OFF
	MON	--:--	--:--	OFF
	TUE	--:--	--:--	OFF
	WED	--:--	--:--	OFF
	THU	--:--	--:--	OFF
	FRI	--:--	--:--	OFF
(5)	SAT	--:--	--:--	OFF
	DLY	--:--	--:--	OFF

You can set times at which to start and stop recording on each specified day of the week.

- (1) WEEK:** Used to select the days of the week for timer settings. When each day in the “WEEK” column is flashing, it can be set to other days. The lines 7 (initially “SAT”) and 8 (initially “DLY”) are used for timer recording settings spanning more than 24 hours.
- (2) START:** Enter the time at which to start timer recording.
- (3) STOP:** Enter the time at which to stop timer recording.
- (4) SET:** Setting “ON” enables the entered timer recording setting. Setting “OFF” disables the entered timer recording setting.
- (5) SAT, DLY:** Use these lines for timer recording spanning more than 24 hours.

Making timer reservations every day at the same time with the same image quality

Example:

Making a timer recording every day from 8:30 to 18:30 with the same recording speed

1 Press the [MENU] button.

The [MENU] button lights, and the <MAIN MENU> screen is displayed.

2 Select “3. RECORDER MENU”, and press the [>] button.

The <RECORDER MENU> screen is displayed, with the cursor positioned on “1. REC MODE SET”.



3 Select “4. TIMER REC SET” and press the [>] button.

The <TIMER REC SET> screen is displayed.

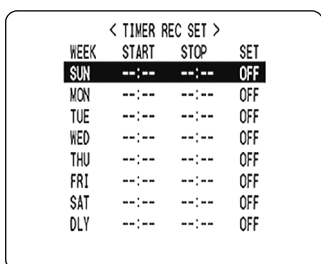

4 Press the [>] button once.

“SUN” under “WEEK” flashes.



5 Press the [v] or [^] button to change “SUN” to “DLY”.

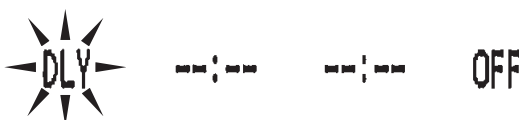

6 Press the [>] button to move the cursor to the next item.

Each time you press the [>] button, the cursor moves to the following items:

Day → “START” time (hours, minutes) → “STOP” time (hours, minutes) → “ON”/“OFF”

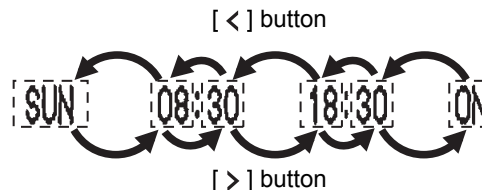

■ To change a displayed setting item

Press the [<] or [>] button to move the flashing area to the item you want to change, then press the [^] or [v] button to change the setting.

■ Timer recording image quality

The image quality is determined by the “PICTURE QUALITY” setting in the <REC MODE SET> screen. (→P. 33)

7 When finished making the settings, press the [EXIT/OSD] button.

The display returns to the normal screen.

■ To set different recording times on each day of the week

Set the desired recording times for each day.

■ If timer reservation days overlap

The timer reservation that starts first will have priority.

To cancel all set timer reservations

1 Press the [MENU] button.

The [MENU] button lights, and the <MAIN MENU> screen is displayed.

2 Select “3. RECORDER MENU”, and press the [>] button.

The <RECORDER MENU> screen is displayed, with the cursor positioned on “1. REC MODE SET”.

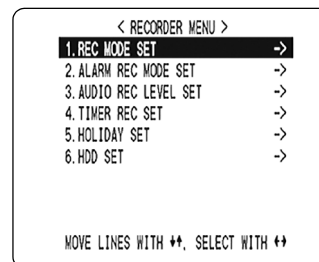

3 Select “4. TIMER REC SET”, and press the [>] button.

The <TIMER REC SET> screen is displayed.

< TIMER REC SET >			
WEEK	START	STOP	SET
SUN	--:--	--:--	OFF
MON	--:--	--:--	OFF
TUE	--:--	--:--	OFF
WED	--:--	--:--	OFF
THU	--:--	--:--	OFF
FRI	--:--	--:--	OFF
SAT	--:--	--:--	OFF
DLY	--:--	--:--	OFF

4 With the <TIMER REC SET> screen displayed, press the [MENU RESET] button.

All the timer settings are erased.

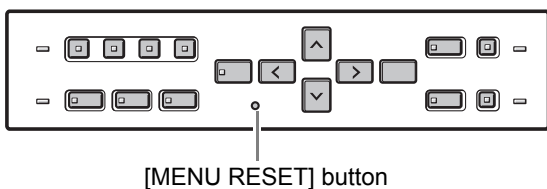

Setting timer reservations spanning more than 24 hours

Follow the steps below to set timer recordings spanning more than 24 hours. These settings are made using lines 7 (initially “SAT”) and 8 (initially “DLY”) of the <TIMER REC SET> screen.

Example:
Timer recording from 10:30 Monday to 20:30 Wednesday

1 Press the [v] or [^] button to move the cursor to the line 7 (SAT), then press the [>] button.

“SAT” in the “WEEK” column flashes. You can change the setting of the flashing item.

< TIMER REC SET >			
WEEK	START	STOP	SET
SUN	--:--	--:--	OFF
MON	--:--	--:--	OFF
TUE	--:--	--:--	OFF
WED	--:--	--:--	OFF
THU	--:--	--:--	OFF
FRI	--:--	--:--	OFF
SAT	--:--	--:--	OFF
DLY	--:--	--:--	OFF

Line 7

2 Set the items in the “WEEK” and “START” columns.

- Press the [v] or [^] button to change “SAT” to “MON”, then press the [>] button.

MON	⬅️⬆️⬇️⬇️⬇️⬆️⬅️	--:--	OFF
-----	----------------	-------	-----

- Press the [v] or [^] button to change “--” to “10”, then press the [>] button.

MON	⬅️⬆️⬇️⬇️⬇️⬆️⬅️	10:--	OFF
-----	----------------	-------	-----

- Press the [v] or [^] button to change “--” to “30”, then press the [>] button.

MON	⬅️⬆️⬇️⬇️⬇️⬆️⬅️	10:30	OFF
-----	----------------	-------	-----

3 Press the [v] or [^] button to change the “STOP” time from “--:--” to “*::*”, then press the [>] button.

The “DLY” item on the line 8 automatically changes to “TUE” (8 days after “MON” on line 7), and flashes. Items that don’t need to be set are displayed as asterisks (*).

MON	10:30	**:*	***
TUE	**:*	--:--	OFF

4 Set the end “WEEK” and “STOP” time. Switch “SET” to “ON”.

MON	10:30	**:*	***
TUE	**:*	20:30	ON

(1) (2) (3) (4)

- Press the [v] or [^] button to change “TUE” to “WED”, then press the [>] button.
- Press the [v] or [^] button to change “--” to “20”, then press the [>] button.
- Press the [v] or [^] button to change “--” to “30”, then press the [>] button.
- Press the [v] or [^] button to change “OFF” to “ON”.

5 Press the [EXIT/OSD] button.

The display returns to the normal screen.

Setting holidays

You can set specific dates as holidays, to have the timer recording operation for Sunday used on those days. Dates such as national holidays and company off days should be set as holidays when you want those dates to have the same security as Sundays.

[Setting conditions]

After completing timer settings for Sunday (SUN), make sure to switch "SET" to "ON". (→P. 35)

Example: To set 17 November as a holiday

NOTE

- You can set up to 20 days as holidays.

1 Press the [MENU] button.

The [MENU] button lights, and the <MAIN MENU> screen is displayed.

2 Select "3. RECORDER MENU", and press the [>] button.

The <RECORDER MENU> screen is displayed, with the cursor positioned on "1. REC MODE SET".



3 Select "5. HOLIDAY SET", and press the [>] button.

The <HOLIDAY SET> screen is displayed, with the cursor positioned on "1".

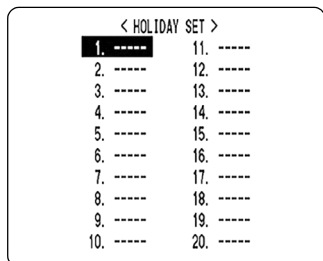

4 Set the month and day in item No. 1.

- Press the [>] button to make "--" (the day) flash.
- Press the [v] or [^] button to set "--" to "17".
- Press the [>] button to make "--" (the month) flash.
- Press the [v] or [^] button to set "--" to "11".

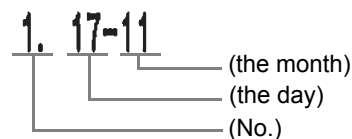

5 After entering the setting, press the [>] button.

The cursor moves to "2".

6 Repeat procedure 4 to set other holidays as needed.

7 Press the [EXIT/OSD] button.

The display returns to the normal screen.

Initializing the hard disk/adding a hard disk

This section describes how to initialize the hard disk or add a hard disk.

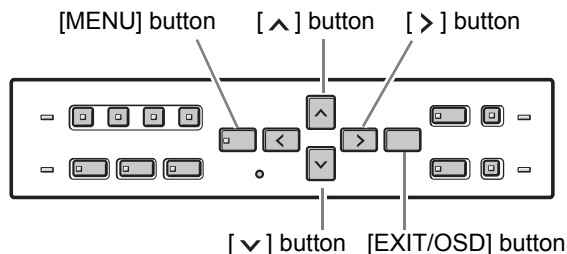

Initializing the hard disk

1 Press the [MENU] button.

The [MENU] button lights, and the <MAIN MENU> screen is displayed.

2 Select "3. RECORDER MENU", and press the [>] button.

The <RECORDER MENU> screen is displayed, with the cursor positioned on "1. REC MODE SET".

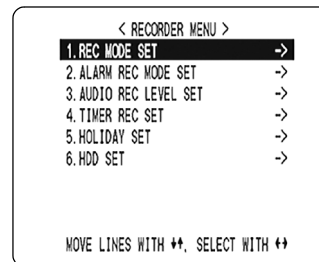

3 Press the [v] or [^] button to select "6. HDD SET", then press the [>] button.

The <HDD SET> screen is displayed, with the cursor positioned on "DISK INITIALIZE".



4 Press the [>] button.

The <WARNING> screen is displayed, with "NO" flashing.



5 Press the [v] or [^] button to select "YES", then press the [>] button.

The "HDD INITIALIZING!" screen is displayed, and the hard disk is initialized.

When the process has finished, the display returns to the MENU screen.

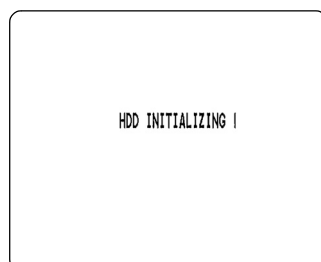

6 Press the [EXIT/OSD] button.

The display returns to the normal screen.

Adding a hard disk (120 GB model only)

To add a hard disk, contact a Sanyo service centre. When adding a hard disk, use an add-on type hard disk unit (sold separately).

[Setting conditions]

After adding a hard disk, be sure to initialize it. Note that both hard disks will be initialized, and any data on the original hard disk will be erased.

NOTE

Hard disk setting screen

- **MIRRORING:** After adding a hard disk, you can record the same image on both hard disks by setting "MIRRORING" to "ON". If an image write error occurs on one disk, you will still be able to read the image from the other disk.
- **Playback disk:** When mirroring is set, the digital video recorder automatically sets which of the two hard disks to read the recorded image from.

<MAIN MENU>

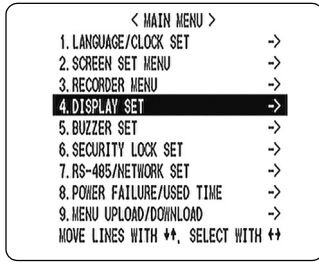

The <DISPLAY SET> screen lets you turn off the display of the date, time or other information in the operation display area of the playback screen. Use this screen to make settings as needed.

<DISPLAY SET> screen setting items

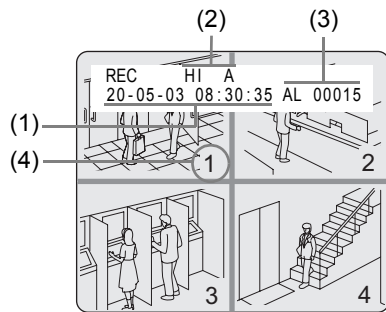
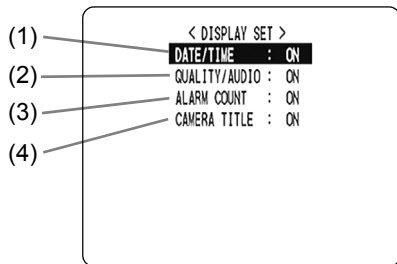

[Settings] (◆ indicates default setting.)

Item	Setting	Description
(1) DATE/TIME	◆ ON	Turns on display of date/time in operation display area.
	OFF	Turns off display of date/time in operation display area.
(2) QUALITY/AUDIO	◆ ON	Turns on display of image quality and "A" for audio recording in operation display area.
	OFF	Turns off display of image quality and "A" for audio recording in operation display area.
(3) ALARM COUNT	◆ ON	Turns on display of current alarm count in operation display area.
	OFF	Turns off display of current alarm count in operation display area.
(4) CAMERA TITLE	◆ ON	Turns on display of camera title on the screen.
	OFF	Turns off display of camera title on the screen.

Settings

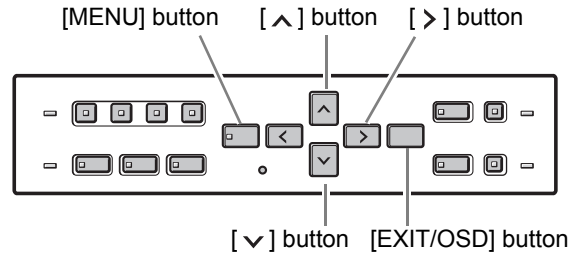

1 Press the [MENU] button.

The [MENU] button lights, and the <MAIN MENU> screen is displayed.

2 Select "4. DISPLAY SET", and press the [>] button.

The <DISPLAY SET> screen is displayed.

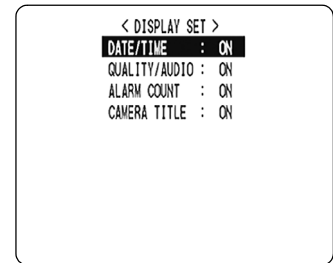

3 Press the [v] or [^] buttons to select the desired function, then press the [>] button.

The setting flashes.

4 Press the [v] or [^] buttons to change the setting, then press the [>] button.

5 Repeat procedures 3 to 4 to set other functions as needed.

6 When you have finished making the settings, press the [EXIT/OSD] button.

The display returns to the normal screen.

<MAIN MENU>

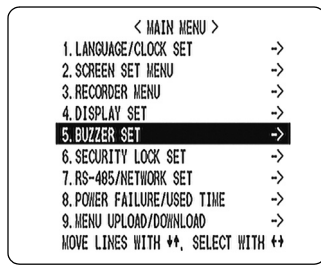

The <BUZZER SET> screen lets you set a warning buzzer to sound when events occur such as alarms being generated or the remaining hard disk space reaching zero. Use this screen to make settings as needed.

<BUZZER SET> screen setting items

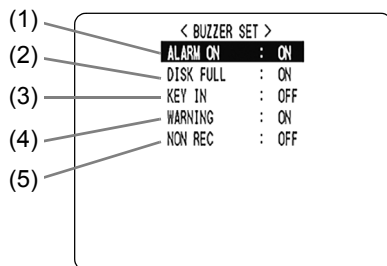

[Settings] (◆ indicates default setting.)

	Item	Setting	Description
(1)	ALARM ON	◆ ON	Sounds buzzer when alarm is generated.
		OFF	Doesn't sound buzzer when alarm is generated.
(2)	DISK FULL	◆ ON	When "OVER WRITE" is not set, sounds buzzer when remaining hard disk space reaches zero.
		OFF	When "OVER WRITE" is not set, doesn't sound buzzer when remaining hard disk space reaches zero.
(3)	KEY IN	ON	Sounds buzzer when operation button is pressed.
		◆ OFF	Doesn't sound buzzer when operation button is pressed.
(4)	WARNING	◆ ON	Sounds buzzer in following cases: ● Hard disk drive error ● Fan error ● Recording error
		OFF	Doesn't sound buzzer in following cases: ● Hard disk drive error ● Fan error ● Recording error
(5)	NON REC	ON	Sounds buzzer when recording is stopped.
		◆ OFF	Does not sound buzzer when recording is stopped.

NOTE

- Press any button to stop the BUZZER sounding.

Settings

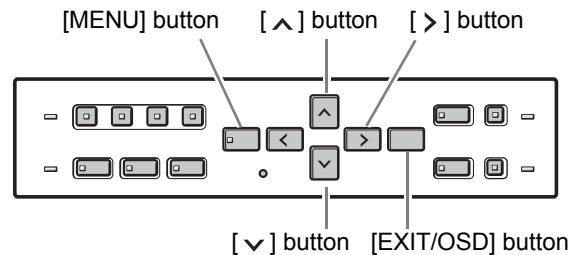

1 Press the [MENU] button.

The [MENU] button lights, and the <MAIN MENU> screen is displayed.

2 Select "5. BUZZER SET", and press the [>] button.

The <BUZZER SET> screen is displayed.

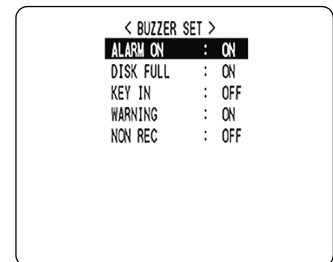

3 Press the [v] or [^] buttons to select the desired function, then press the [>] button.

The setting flashes.

4 Press the [v] or [^] buttons to change the setting, then press the [>] button.

5 Repeat procedures 3 to 4 to set other functions as needed.

6 When you have finished making the settings, press the [EXIT/OSD] button.

The display returns to the normal screen.

<MAIN MENU>

< MAIN MENU >	
1. LANGUAGE/CLOCK SET	->
2. SCREEN SET MENU	->
3. RECORDER MENU	->
4. DISPLAY SET	->
5. BUZZER SET	->
6. SECURITY LOCK SET	->
7. RS-485/NETWORK SET	->
8. POWER FAILURE/USED TIME	->
9. MENU UPLOAD/DOWNLOAD	->
MOVE LINES WITH ↑↓, SELECT WITH →	

You can set passwords that restrict use of the digital video recorder to administrators and designated users, preventing unauthorized operation. When the security lock is set, a buzzer sounds when an unauthorized user presses any of the digital video recorder's operation buttons. Be sure to make a note of the set passwords.

Password setting example

Two password types can be set, one for administrators and one for users. The table below gives example password setting combinations, and lists how the digital video recorder operates for each.

Setting example	Operation
LEVEL PASSWORD (4-8) USE ADMIN 123456AB ON USER AB123456 ON REC CONTROL : ADMIN	All operations are locked until you enter a password. Enter the user password to enable playback operations. Enter the administrator password to enable all operations.
ADMIN 123456AB ON USER AB123456 ON REC CONTROL : USER	All operations are locked until you enter a password. Enter the user password to enable playback and recording operations. Enter the administrator password to enable all operations.
ADMIN 123456AB ON USER ----- OFF REC CONTROL : ADMIN	Only playback operations enabled unless password is entered. Enter the administrator password to enable all operations.
ADMIN 123456AB ON USER ----- OFF REC CONTROL : USER	Only playback and recording operations enabled unless password is entered. Enter the administrator password to enable all operations.
ADMIN ----- OFF USER ----- OFF REC CONTROL : ADMIN	All operations enabled. Also functions as key lock. (→P. 22)
ADMIN ----- OFF USER ----- OFF REC CONTROL : USER	All operations enabled. Also functions as key lock. (→P. 22)

<SECURITY LOCK SET> screen setting items

<SUB MENU>

< SECURITY LOCK SET >		
(1)	LEVEL PASSWORD (4-8) USE	ADMIN ----- OFF
(2)	USER	----- OFF
(3)	REC CONTROL	: ADMIN

[Settings] (◆ indicates default setting.)

Item	Setting	Description
(1) ADMIN	ON	Used to set password for administrators. Also enables password setting.
	◆OFF	Disables password setting.
(2) USER	ON	Used to set password for users. Also enables password setting.
	◆OFF	Disables password setting.
(3) REC CONTROL	◆ADMIN	Sets authorization for recording operation to "ADMIN" (administrators).
	USER	Sets authorization for recording operation to "USER" (users).

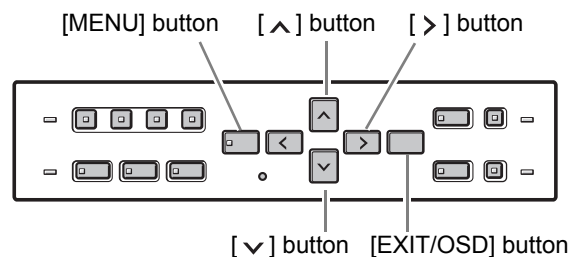
Setting passwords

Passwords can be between 4 and 8 alphanumeric characters.

Characters that can be entered in passwords: 0 to 9, A to Z

Example: Setting "123456AB" as a password**1 Press the [MENU] button.**

The [MENU] button lights, and the <MAIN MENU> screen is displayed.

2 Select "6. SECURITY LOCK SET", and press the [>] button.

The <SECURITY LOCK SET> screen is displayed. The cursor is positioned on "ADMIN".

NOTE

- "LEVEL PASSWORD (4-8) USE" at the top of the screen is the screen title. You cannot move the cursor to this item.

3 Press the [>] button.

The first password entry bar “-” flashes.

**4 Press the [v] and [^] buttons to select the character to enter.**

Example:

Selecting “1”

5 Press the [>] button.

The second password entry bar flashes.

**6 Repeat procedures 4 to 5 to enter the remaining digits (“23456AB” in this example).****NOTE**

- To set a 4-digit password
When you have entered four digits, and the fifth password entry bar is flashing, press the [>] button.

7 When you have entered the password, press the [>] button.

The cursor moves to “OFF” (flashing).

8 Press the [v] and [^] buttons to select “ON”.**CAUTION**

- If you select “OFF” for the “ADMIN” setting, you cannot set the “USER” password.

9 When you have finished making the setting, press the [>] button.

The cursor moves to “USER”.
If you do not want to set a user password, the password setting is now finished.

Press the [v] and [^] button to move the cursor to “REC CONTROL”, to set the authorization for recording and playback operation. (→P. 44)

```

< SECURITY LOCK SET >
LEVEL  PASSWORD(4-8)  USE
ADMIN  123456AB      ON
USER   -----      OFF
REC CONTROL      :  ADMIN
  
```

Setting the user password**Example: Setting “AB123456”**

Perform Steps 1 and 2 on P. 42

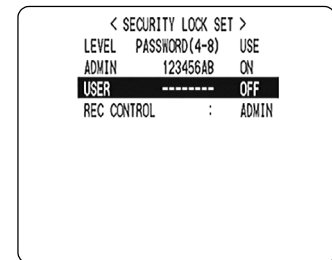
3 Press the [v] and [^] buttons to move the cursor to “USER”.**4 Press the [>] button.**

The first password entry bar “-” flashes.

Example: A

Press the [v] and [^] buttons to select “A”.

**5 Press the [>] button.**

The second password entry bar flashes.
Press the [v] and [^] buttons to select “B”.

Use the procedures as “Administrator password” to set “123456.”

6 When you have finished making the setting, press the [>] button.

The cursor moves to “OFF” (which flashes).

**7 Press the [v] and [^] buttons to select “ON”, then press the [>] button.**

The cursor moves to “REC CONTROL”.

Setting the authorization for recording and playback operations

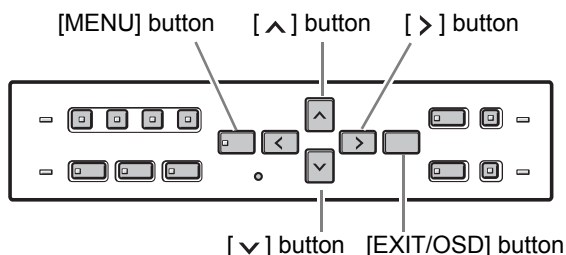

Perform Steps 1 and 2 on P. 42

- 3 Press the [v] and [^] buttons to move the cursor to "REC CONTROL".



- 4 Press the [>] button.

- 5 Press the [v] and [^] buttons to select "ADMIN" or "USER".

The setting is now finished.

- 6 Press the [EXIT/OSD] button.

The display returns to the normal screen.

Setting the security lock

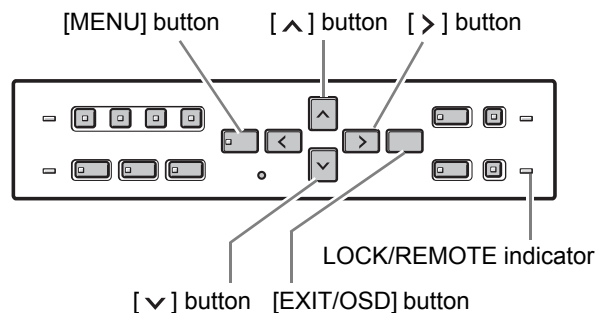

- 1 With the normal monitoring screen displayed, press the [v] button for about 3 seconds.

A confirmation tone sounds, the LOCK/REMOTE indicator lights, and the security lock is set.

- 2 To check the security lock, press any button.

The password entry screen is displayed for about 5 seconds.



- 3 While the password entry screen is displayed, enter the password.

Enter the password using the [v], [^] and [>] buttons.

! CAUTION

- Enter the password set for administrators or users (such as "123456AB").

123456AB

- 4 Press the [>] button.

The setting is now finished.

The LOCK/REMOTE indicator turns off, and the display returns to the normal screen.

This section describes how to make the RS-485 terminal connections/settings needed to connect to an external device, and how to make the network connections needed to connect to a PC.

Network connections and settings

You can make digital video recorder menu settings and monitor images from a PC via a network (LAN). To do so, connect an Ethernet cable to the LAN terminal on the digital video recorder's rear panel.

- **To connect a PC directly**
(Do not use an Ethernet hub.)

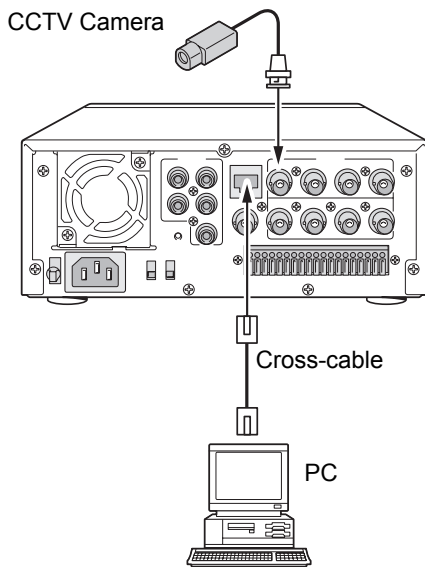

- **To connect to an intranet**
(Use an Ethernet hub.)

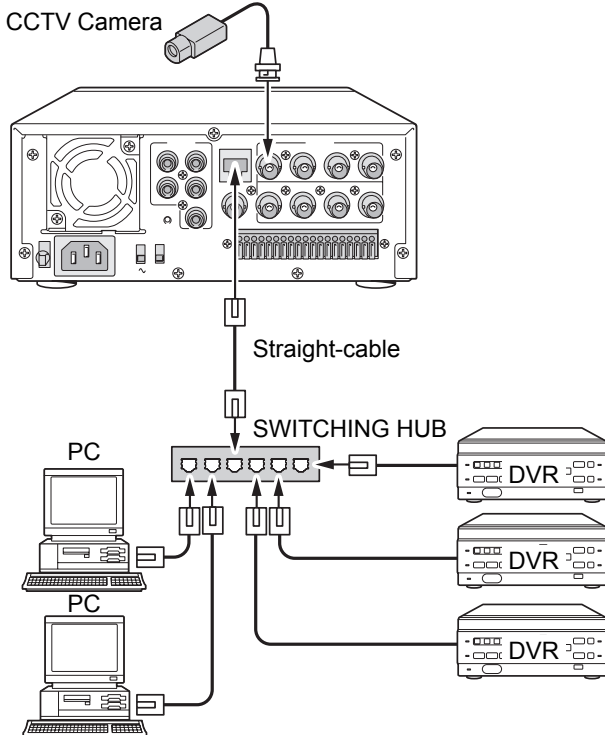

Settings for connecting to a PC or network

How to set the IP address

In the default setting, the IP address is set automatically by the PC.

To set the IP address manually, follow the procedures below.

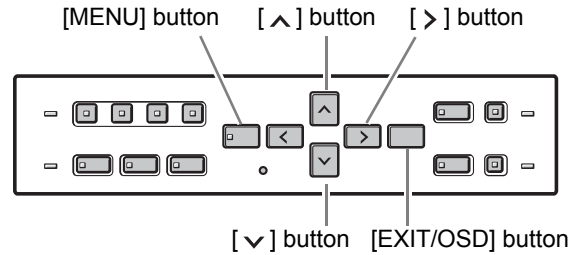

1 Press the [MENU] button.

The [MENU] button lights, and the <MAIN MENU> screen is displayed.

2 Select "7. RS-485/NETWORK SET", and press the [>] button.

The <NETWORK SET> screen is displayed.

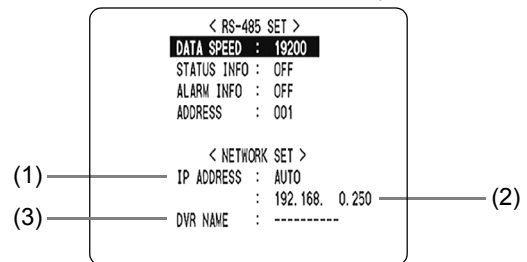

[Settings] (◆ indicates default setting.)

	Item	Setting	Description
(1)	IP ADDRESS	◆AUTO	Automatically set by the PC.
		MANUAL	You can set the last 3 digits between 1 and 250 from the unit.
(2)	ADDRESS	001 to 250 (◆250)	In "AUTO," the address set by the PC is displayed. In "MANUAL," set the address for each recorder connected.
(3)	DVR NAME (Display only)		Set at the PC.

3 Press the [v] and [^] buttons to select the "IP ADDRESS" item, then press the [>] button.

"AUTO" flashes.

- 4** Press the [∨] and [∧] buttons to select “MANUAL,” then press the [>] button twice.

The last 3 digits of the address flash.

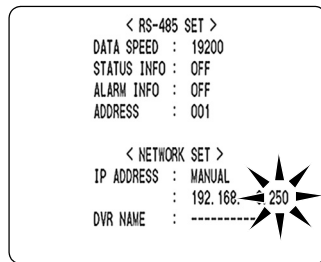

- 5** Press the [∨] and [∧] buttons to change the setting, then press the [>] button.

The cursor moves to “DATA SPEED”.

- 6** When you have finished making the settings, press the [EXIT/OSD] button.

RS-485 connections and settings

Connect the digital video recorder's RS-485 (A, B) control terminals to the system controller, hard disk digital recorder or similar device.

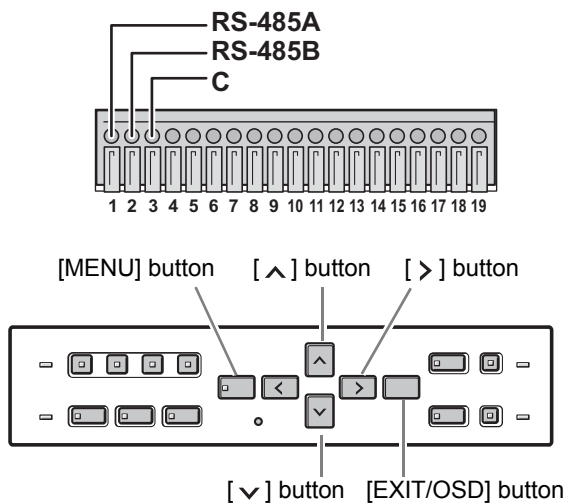

- 1** Press the [MENU] button.

The [MENU] button lights, and the <MAIN MENU> screen is displayed.

- 2** Select “7. RS-485/NETWORK SET”, and press the [>] button.

The <RS-485 SET> screen is displayed.

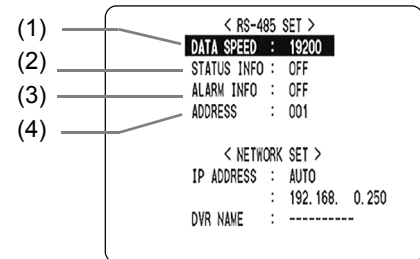

[Settings] (◆ indicates default setting.)

	Item	Setting	Description
(1)	DATA SPEED	2400 4800 9600 ◆19200	Used to select the communication speed. (Unit: bps)
(2)	STATUS INFO	ON	Enables status information to be sent on the RS-485 line.
		◆OFF	Not set
(3)	ALARM INFO	ON	Enables alarm information to be sent on the RS-485 line.
		◆OFF	Not set
(4)	ADDRESS	000 to 127 (◆001)	When connecting multiple recorders, different address numbers are set for each.

- 3** Press the [∨] and [∧] buttons to select the desired item, then press the [>] button.

- 4** Press the [∨] and [∧] buttons to change the setting, then press the [>] button.

- 5** Repeat procedures 3 to 4 to set the other items as needed.

- 6** When you have finished making the settings, press the [EXIT/OSD] button.

The display returns to the normal screen.

<MAIN MENU>

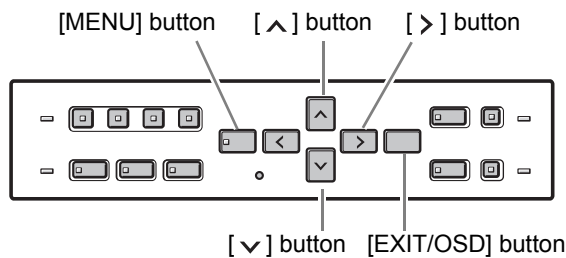

You can check the date/time of power failures and the amount of hard disk operation time.

1 Press the [MENU] button.

The [MENU] button lights, and the <MAIN MENU> screen is displayed.

2 Select "8. POWER FAILURE/USED TIME", and press the [>] button.

The <POWER FAILURE> screen is displayed.

Use this screen to check the date/time of power failures and the amount of hard disk operation time.

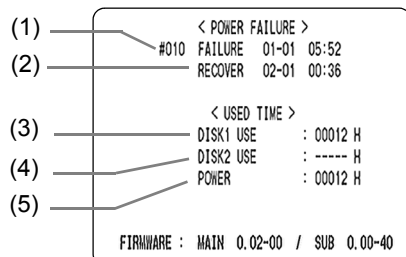

(1) FAILURE:

Displays the date/time at which a power failure occurred.

The number on the left is the number of power failures (example: #010). Resets to "000" after exceeding "999".

(2) RECOVER:

Displays the time at which the power was restored.

(3) DISK1 USE:

Displays the total amount of disk 1 operation time.

(4) DISK2 USE:

Displays the total amount of disk 2 operation time (when second disk has been added).

(5) POWER:

Displays the amount of power ON time for the digital video recorder.

NOTE

- The most recent power failure and recovery times are displayed.

3 Press the [EXIT/OSD] button.

The display returns to the normal screen.

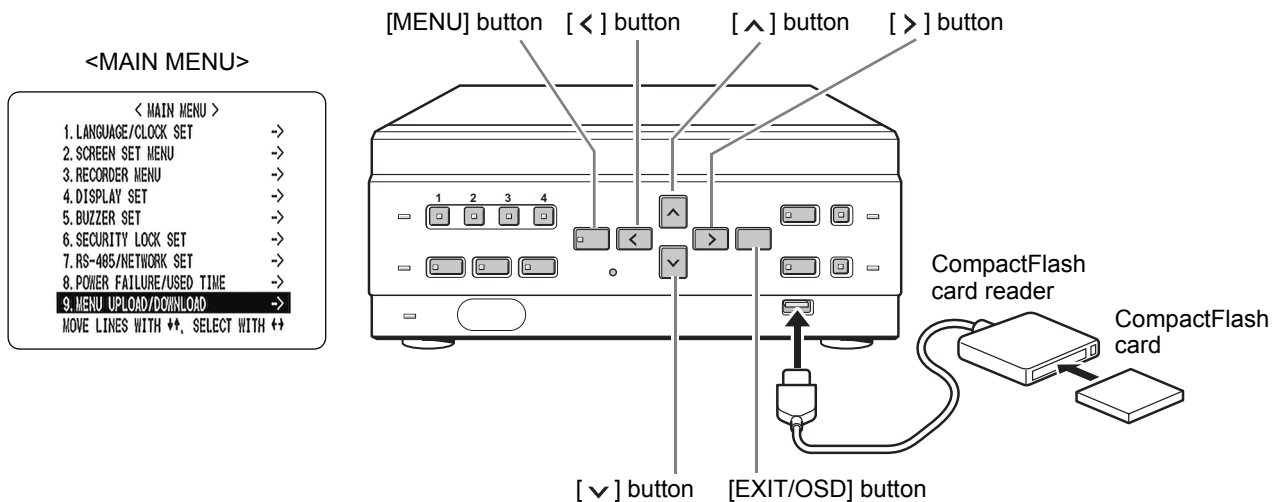

You can save menu setting values onto a CompactFlash card. Also, you can download menu settings saved on CompactFlash cards to the DVR.

! CAUTION

- Do not turn the power OFF when saving/loading menu items to/from a CompactFlash card.
- Confirm that the light on the CompactFlash card reader is lit before using the card reader with the USB terminal. If used before the light is lit, SAVE and LOAD may not be recognized.
- After saving menu settings to a CompactFlash card, you may not be able to repeat the operation. If this problem occurs, redo the operation after ejecting and reinserting the CompactFlash card.

NOTE

- At least 4 KB of available memory space is needed on the CompactFlash card.
- For the recommended CompactFlash card reader, see our website at "www.sanyosecurity.com."

Settings

You will need a CompactFlash card reader and CompactFlash card (commercially available).

1 Press the [MENU] button.

The [MENU] button lights, and the <MAIN MENU> screen is displayed.

2 Select "9. MENU UPLOAD/DOWNLOAD", and press the [>] button.

The <MENU UPLOAD/DOWNLOAD> screen is displayed.

The cursor is positioned on "SAVE MENUS TO CF".

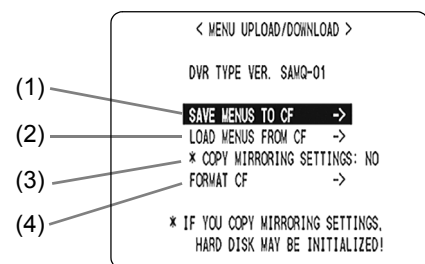

	Item	Description
(1)	SAVE MENUS TO CF	Saves menu settings to CompactFlash card.
(2)	LOAD MENUS FROM CF	Reads menu settings saved on CompactFlash card.
(3)	COPY MIRRORING SETTINGS	Sets whether to apply "MIRRORING ON/OFF" setting saved on CompactFlash card when "LOAD MENUS FROM CF" is selected.
(4)	FORMAT CF	Initializes CompactFlash card.

! CAUTION

- If "COPY MIRRORING SETTINGS" is set to "YES", the hard disk may be initialized. If you don't want to initialize the hard disk, select "NO".

To download menu items

- 1 Press the [∨] and [∧] buttons to select “SAVE MENUS TO CF”, then press the [>] button.

The <WARNING> screen is displayed.
“NO” flashes.

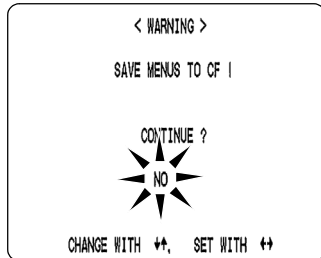

- 2 Press the [∨] and [∧] buttons to select “YES”, then press the [>] button.

Downloading starts.

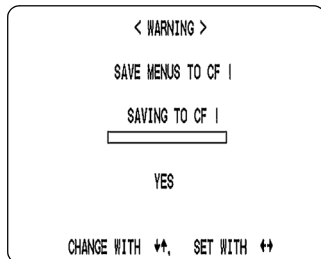

When you have finished loading, the display returns to the <MENU UPLOAD/DOWNLOAD> screen.

NOTE

- A file named “M804MENU.txt” is created on the CompactFlash card.

To upload menu items

- 1 Press the [∨] and [∧] buttons to select “LOAD MENUS FROM CF”, then press the [>] button.

The <WARNING> screen is displayed.
“NO” flashes.

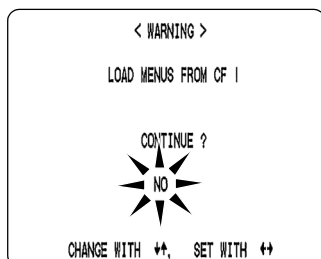

- 2 Press the [∨] and [∧] buttons to select “YES”, then press the [>] button.

Uploading starts.

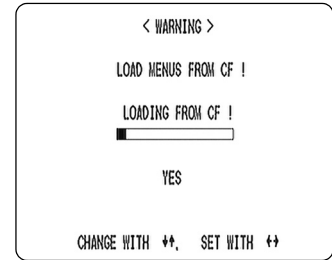

When you have finished saving, the display returns to the <MENU UPLOAD/DOWNLOAD> screen.

Formatting CompactFlash cards

- 1 Press the [∨] and [∧] buttons to select “FORMAT CF”, then press the [>] button.

The <WARNING> screen is displayed.
“NO” flashes.



- 2 Press the [∨] and [∧] buttons to select “YES”, then press the [>] button.

CompactFlash card formatting starts.



When formatting has finished, the display returns to the <MENU UPLOAD/DOWNLOAD> screen.

! CAUTION

- Formatting a CompactFlash card erases all the data stored on it. To cancel formatting, select “NO”.

To exit

- 1 Press the [EXIT/OSD] button.

The display returns to the normal screen.

RS-485 specifications

Data format

Mode	Asynchronous
Character length	8 bits
Data transmission speed	2400, 4800, 9600, 19200 bps
Parity check	None
Stop bit	1

Communication protocol

A proprietary Sanyo protocol (SSP: Security Serial Protocol) is used. Use of a special controller for operation is recommended. To obtain this controller, contact a Sanyo service centre.

RS-485 termination switch settings

Termination settings

When connecting multiple devices, you must make termination settings on both end devices.

- Set the RS-485 termination switch of both end devices to ON.
- Be sure to set the RS-485 termination switches of all devices in between (devices other than the first and last devices) to OFF.

! CAUTION

- If you don't make the correct termination settings, data will be distorted and will affect other data, making the data transmitted to each device incorrect.

Example

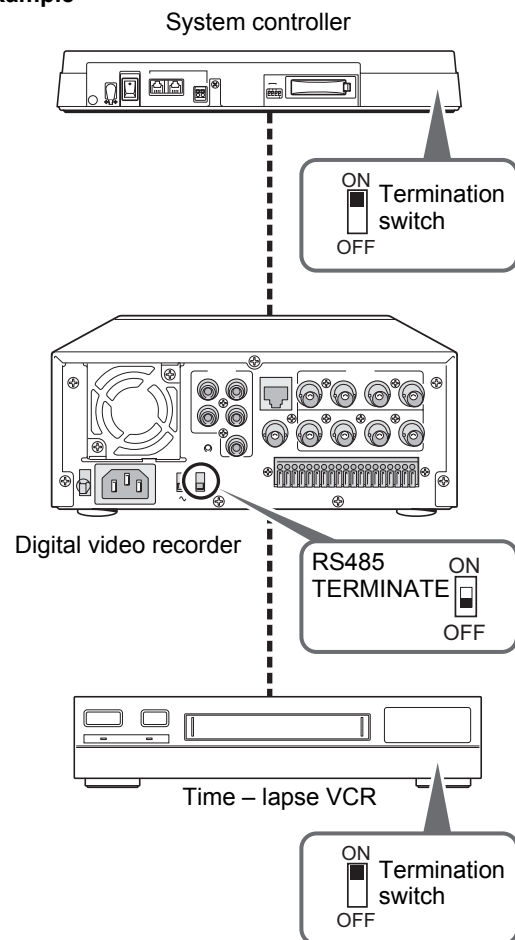

DVR/VCR command table

The table below shows the commands supported by the digital video recorder.

Left digit \ Right digit	0	1	2	3	4	5	6	7
0							TIMER ON/OFF	
1								
2			AUDIO					
3						SHIFT←	SHIFT→	
4						SHIFT↑	SHIFT↓	MENU
5							SHIFT+ /RP UP	
6							SHIFT- /RP DOWN	
7								
8								
9							SECURITY LOCK ON	
A				PLAY	REV PLAY /SEARCH (DVR)		SECURITY LOCK OFF	
B								
C							GROUP SET	
D							GROUP CHECK	
E							GROUP CLEAR	
F				STOP	STILL			

Left digit \ Right digit	8	9	A	B	C	D	E	F
0		CAMERA1					CLOCK ADJUST	
1		CAMERA2					MENU RESET	
2		CAMERA3						
3	QUAD	CAMERA4						
4								
5								
6								
7	SEQUENCE					STATUS SENSE		
8								
9							CLOCK DOWNLOAD	
A					REC			REC/DUB REQUEST
B			FF					
C			REW					
D								
E	OSD/EXIT							
F				STATUS LOG1	REC STOP			

The command is only used during RS-485 control.

2 SPECIFICATIONS

Hard disk capacity		120 GB
Television system		NTSC/PAL color signal standard (Switchable)
Picture resolution		NTSC: 720 x 480 (Super/High/Standard) PAL: 720 x 576 (Super/High/Standard)
Compression	Video	MPEG2
	Audio	MPEG1 Audio Layer2
Picture quality		3 levels (Super/High/Standard)
Recording type		Frame
Recording speed		NTSC: 30 fps or PAL: 25 fps
Screen		Single screen/Quad screen
Playback		Playback, Still, Search, Cue, Review, Slow/reverse, Frame advance/reverse
Recording	Normal recording	Records on quad screen
	Timer recording	Records on quad screen
	Alarm recording	Records on quad screen
Search mode	Time/date search	Search by time and date
	Alarm search	Search by alarm event list or alarm thumbnail list
Menu language		English/Chinese (Simplified)
Clock settings		Day/Month/Year/Hours/Minutes/Seconds
Miscellaneous functions		Motion sensor, Security lock (with password function)
Video input terminal		1V (p-p), 75 Ohm unbalanced, 4 BNC connectors
Video output terminal		1V (p-p), 75 Ohm unbalanced, 4 BNC connectors
Video monitor out terminal		1V (p-p), 75 Ohm unbalanced, 1 BNC connector
Audio input terminal		-8 dbs, 47 k Ohm unbalanced (4 RCA pin jacks)
Audio output terminal		-8 dbs, 600 Ohm unbalanced (1 RCA pin jack)
LAN terminal		100BASE-TX (RJ-45)
USB terminal		For CompactFlash card reader
Control connector (Push lock)	RS-485 terminal	3 terminals (A, B, GND)
	Remote control terminal	Resistance ladder
	Clock adjust input terminal	Normal open, Low level active
	Clock adjust output terminal	Normal 5 V, Low level active
	Series rec input terminal	Normal open, Low level active
	Non rec output/Series rec output terminal	Normal 5 V, Low level active
	Alarm input terminal	Normal open, Low level active (4 channels)
	Alarm reset terminal	Normal open, Low level active
	Alarm output terminal	Normal 5 V, Low level active
	Warning output terminal	Open collector (500 mA), Low level active
	Full out warning terminal	Open collector (50 mA), Low level active
Power		120 – 240 V AC, 50/60 Hz
Current consumption		36 W
Dimensions		210 (W) x 96 (H) x 380 (D) mm
Weight		3.7 kg

Note that product appearance and specifications are subject to change without prior notice.

Dimensions

(mm)

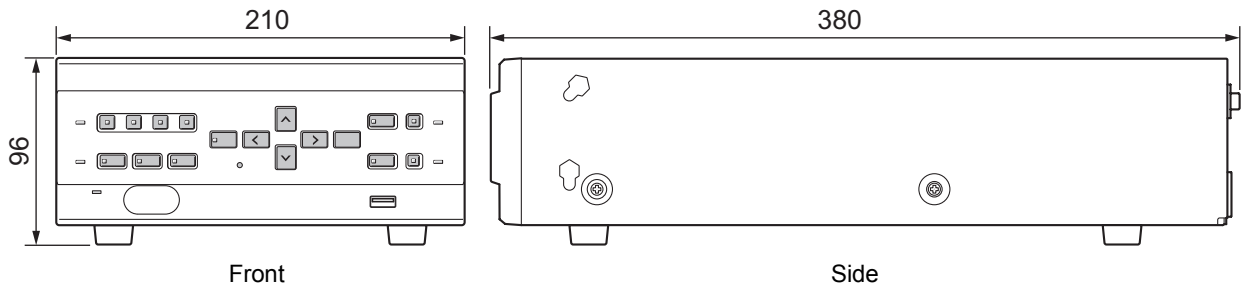



SANYO Electric Co., Ltd.

Printed in Japan

Printed on recycled paper

1AC6P1P2694--
L8HBC/HD (0803TR-SY)

Free Manuals Download Website

<http://myh66.com>

<http://usermanuals.us>

<http://www.somanuals.com>

<http://www.4manuals.cc>

<http://www.manual-lib.com>

<http://www.404manual.com>

<http://www.luxmanual.com>

<http://aubethermostatmanual.com>

Golf course search by state

<http://golfingnear.com>

Email search by domain

<http://emailbydomain.com>

Auto manuals search

<http://auto.somanuals.com>

TV manuals search

<http://tv.somanuals.com>