

SANYO

Digital Video Recorder

DSR-M814

Instruction manual	English	GB
Manuel D'instructions	Français	F
Manuel de Instrucciones	Español	E

About this manual

Before installing and using this unit, please read this manual carefully. Be sure to keep it handy for later reference.

À propos de ce manuel



Avant d'installer et d'utiliser cet appareil, veuillez lire ce manuel attentivement. Assurez-vous de le garder à portée de la main pour référence ultérieure.

Acerca de este manual

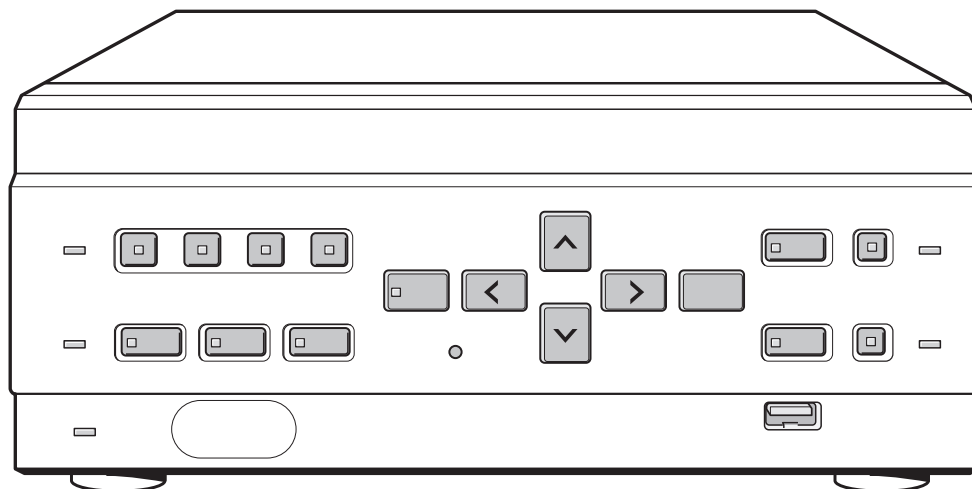
Antes de instalar y usar este aparato, lea detenidamente este manual. Asegúrese de guardarlo a mano para futuras referencias.





PRECAUTION

	CAUTION RISK OF ELECTRIC SHOCK DO NOT OPEN	
<p>CAUTION: TO REDUCE THE RISK OF ELECTRIC SHOCK, DO NOT REMOVE COVER (OR BACK). NO USER-SERVICEABLE PARTS INSIDE. REFER SERVICING TO QUALIFIED SERVICE PERSONNEL.</p>		

WARNING: To reduce the risk of fire or electric shock, do not expose this appliance to rain or moisture.

CAUTION: Changes or modifications not expressly approved by the manufacturer may void the user's authority to operate this equipment.

	The lightning flash with arrowhead symbol, within an equilateral triangle, is intended to alert the user to the presence of uninsulated "dangerous voltage" within the product's enclosure that may be of sufficient magnitude to constitute a risk of electric shock to persons.
	The exclamation point within an equilateral triangle is intended to alert the user to the presence of important operating and maintenance (servicing) instructions in the literature accompanying the product.

This equipment has been tested and found to comply with the limits for a Class B digital device, pursuant to part 15 of the FCC Rules.

These limits are designed to provide reasonable protection against harmful interference in a residential installation. This equipment generated, uses and can radiate radio frequency energy and, if not installed and used in accordance with the instructions, may cause harmful interference to radio communications. However, there is no guarantee that interference will not occur in a particular installation.

If this equipment does cause harmful interference radio or television reception, which can be determined by turning the equipment off and on, the user is encouraged to try to correct the interference by one or more of the following measures:

- Reorient or relocate the receiving antenna.
- Increase the separation between the equipment and receiver.
- Connect the equipment into an outlet on a circuit different from that to which the receiver is connected.
- Consult the dealer or an experienced radio/TV technician for help.

For the customers in Canada

This class B digital apparatus complies with Canadian ICES-003.

CAUTION

Danger of explosion if battery is incorrectly replaced. Replace only with the same or equivalent type recommended by the manufacturer. Discard used batteries according to the manufacture's instructions.

Declaration of Conformity

Model Number : DSR-M814
 Trade Name : SANYO
 Responsible party : SANYO FISHER COMPANY
 Address : 21605 Plummer Street,
 Chatsworth, California 91311
 Telephone No. : (818) 998-7322

- This device complies with Part 15 of the FCC Rules. Operation is subject to the following two conditions:
 - (1) this device may not cause harmful interference, and
 - (2) this device must accept any interference received, including interference that may cause undesired operation.

Location

For safe operation and satisfactory performance of your unit, keep the following in mind when selecting a place for its installation:

- Shield it from direct sunlight and keep it away from sources of intense heat.
- Avoid dusty or humid places.
- Avoid places with insufficient ventilation for proper heat dissipation. Do not block the ventilation holes at the top and bottom of the unit. Do not place the unit on a carpet because this will block the ventilation holes.
- Install the unit in a horizontal position only.
- Avoid locations subject to strong vibrations.
- Avoid moving the unit between cold and hot locations.
- Do not place the unit directly on top of a monitor TV, as this may cause playback or recording problems.

Avoiding Electrical Shock and Fire

- Do not handle the power cord with wet hands.
- Do not pull on the power cord when disconnecting it from an AC wall outlet. Grasp it by the plug.
- If any liquid is spilled on the unit, unplug the power cord immediately and have the unit inspected at a factory-authorized service center.
- Do not place anything directly on top of this unit.

SERVICE

This unit is a precision instruments and if treated with care, will provide years of satisfactory performance.

However, in the event of a problem, the owner is advised not to attempt to make repairs or open the cabinet.

Servicing should always be referred to your dealer or Sanyo Authorized Service Centre.

BEFORE USE

Notes on handling internal hard disk drive components

This unit uses an internal hard disk drive (HDD). Be sure to observe the following points carefully when operating, setting-up and servicing the unit.

Conditions to avoid

The hard disk is sensitive to dust, vibrations and shocks, and should also not be used near magnetic objects. To prevent loss of recorded data, observe the following precautions:

- Do not subject the digital video recorder to shocks.
- Do not use the digital video recorder on a vibrating or unstable surface.
- Do not disconnect the power plug from the wall outlet during recording or playback.
- Do not use the digital video recorder in areas of extreme temperature changes (10°C or more per hour).
- Condensation may occur if the digital video recorder is moved to an area of extremely different temperature or high humidity. If the unit is operated when condensation has formed, it may cause operating problems. If sudden changes in the ambient temperature occur, wait for the temperature to stabilize before operating the unit.
- Do not install the digital video recorder in areas of constant vibration such as motor vehicles or trains.
- The digital video recorder has ventilation holes. Make sure these holes are not blocked after installation.
- Do not use the digital video recorder in areas with poor ventilation, such as a bookshelf or box.
- The digital video recorder is designed to be placed horizontally. Do not place it in an upright position.
- When installing the digital video recorder in a rack, ensure a gap of at least 5 cm at the top and bottom.
- When placing the unit down on a surface such as a floor, attach the feet to the base of the unit and place it down gently. If the feet are not attached, place the unit down very carefully.

Do not move the unit for 30 seconds after disconnecting the power.

After the power is disconnected, the disk inside the HDD will continue to spin for a brief period due to inertia, and the heads will be in an unstable state. During this time, the unit is even more susceptible to shocks and vibration than when power is being supplied. Make sure that the unit is not subjected to even gentle vibration for at least 30 seconds after disconnecting the power.

Notes on transporting

When transporting the unit, pack it securely using the packing materials. In addition, use a method of transportation that minimizes vibration.

Notes when replacing the HDD

Be sure to follow the correct replacement procedure when replacing the HDD.

- HDDs that have been removed from their packing may not operate correctly if they are subjected to any shocks and vibration. It is recommended that you place HDD onto a soft, level surface with the printed circuit board facing upward after unpacking it.
- Be careful not to subject the HDD to shocks or vibration when removing and tightening screws as part of the HDD replacement procedure. Make sure that all screws are tightened securely so that they will not become loose. The HDD is sensitive to static electricity, so you should take proper precautions to prevent static electricity buildup.

Handling the HDD unit by itself

If transporting or storing the HDD unit by itself, always be sure to pack it in the packing first. In addition, use a method of transportation that minimizes the vibration.

If the HDD becomes damaged, handle the unit and the damaged HDD that has been removed in order for it to be replaced carefully to prevent the problem from being aggravated until as the nature of the problem can be checked and analyzed.

The hard disk and cooling fan are consumable items.

Under use in an ambient temperature of 25°C, the hard disk should generally be replaced after 2 years, and the cooling fan after 3 years. These figures are intended as guidelines only, and are not guarantees of part performance. The POWER indicator flashes if a problem occurs in the hard disk or fan. (→P.11)

For important recordings

- Always make a test recording beforehand to check that the digital video recorder's playback is normal.
- Note that no compensation will be provided for losses due to recording or playback problems arising from problems with the digital video recorder or its connected devices during operation.
- To be prepared for malfunctions or accidents, back up important recordings periodically, or record using mirroring.

Hard disk protection

The hard disk is checked automatically at power ON. If a hard disk problem is found, the POWER indicator flashes. To initialize the disk or save images stored on the disk, contact a Sanyo service center.

Care

- To clean the digital video recorder, unplug the power plug from the wall outlet and wipe the unit lightly with a soft cloth.
- To remove heavy grime, wipe the digital video recorder with a well-wrung cloth soaked in a solution of water and neutral detergent, and then wipe it with a dry cloth.
- Do not clean the unit with benzene or paint thinner. Doing so may break down the finish or strip the paint.
- When using a chemical cloth, be sure to follow the precautions provided with it.
- Do not spray insecticide or other volatile chemicals on the cabinet. Do not allow rubber or vinyl products to come into contact with the digital video recorder for extended periods. Doing so may break down the finish or strip the paint.

When not in use for an extended period of time

Not using the unit for an extended period of time may cause problems in functions. Power on the unit and operate it occasionally during such periods.

Backup battery

The digital video recorder comes with a built-in lithium battery. When the digital video recorder has been connected to a wall outlet for at least 48 hours and the date and time have been set, the clock function will continue to operate for up to 30 days after the power plug is disconnected.

When disposing of the digital video recorder, contact a Sanyo service center for information on how to dispose of the lithium battery.

MENU button

The [MENU] button is disabled when the unit is connected to a PC (VA-SW814/VA-SW81LITE). When the [MENU] button is operative, operations from the PC are disabled.

Symbols used in this manual

NOTE Information describing operation methods or how to get the most out of functions.

CAUTION Information describing the correct use of the digital video recorder.

(→P.□□) Indicates manual page to refer to.

Copyright

- This manual and software are copyrighted by Sanyo Electric Co., Ltd.
- Brand and product names used in this manual are the trademarks or registered trademarks of their respective companies.

Copyright law prohibits the recording of copyrighted images without the permission of the copyright holder except for personal use.

CONTENTS

BEFORE USE

INTRODUCTION

1. MAIN FEATURES	6
2. ACCESSORIES	6
3. NAMES AND FUNCTIONS OF PARTS	7
Front panel	7
Rear panel	8
4. INSTALLATION AND CONNECTIONS	9
When installing	9
Check the setting	9
Basic connections	9
Connecting to a network	10
Connecting the power	11
Securing the power cord	11
System controller connections	11
Remote control connections	11
Alarm sensor connections	11
Series recording connections	11

OPERATION

1. ADJUSTING THE DISPLAY	12
Operation display area	12
Changing the position of the operation display	13
Displaying four screens in sequence automatically	13
Displaying the image from a specified channel in a single screen	14
2. RECORDING	15
Recording	15
Recording with the timer (timer recording)	16
Recording upon alarm detection	17
Setting alarm recording	17
When an alarm input is detected	17
Ending alarm recording	18

3. PLAYING BACK VIDEOS	19
Playback	19
Fast-forwarding or rewinding during playback ..	19
Viewing still images	20
Frame advance (reverse)	20
Switching audio channels	21
4. SEARCHING FOR RECORDED VIDEOS ..	22
Alarm search	22
Date and time search	24
5. PREVENTING ACCIDENTAL OPERATION (KEY LOCK FUNCTION)	26
Setting the key lock function	26
Releasing the key lock function	26
6. COPYING RECORDED VIDEOS TO EXTERNAL MEDIA	27
Copying to external media	27
Formatting a CompactFlash card or CD-RW ..	29

SETTINGS

1. MENU CONFIGURATION	30
Operating menu screens	30
Restoring items to the default settings	31
Overview of settings	31
2. SETTING THE LANGUAGE AND TIME	33
Changing the language	33
Setting the time	34
<DAYLIGHT SAVING> settings	34
Synchronizing the time with other DSR-M814 DVRs (with two or more DVRs connected)	36
3. SCREEN SET MENU	38
Screen settings	38
MONITOR SET	39
Naming the cameras	40
Setting the motion sensor	41

INTRODUCTION

OPERATION

SETTINGS

APPENDIX

4. RECORDER MENU	43	4. SPECIFICATIONS	70
Recording settings	43	Dimensions.....	71
Basic recording settings.....	43	Cautions when adding a hard disk	71
Alarm recording settings	46		
Setting the audio level.....	47		
Setting the day and time for timer recording	47		
Setting holidays.....	50		
Initializing the hard disk/adding a hard disk	51		
5. DISPLAY SET	53		
Settings	53		
Customizing the operation display area	53		
6. BUZZER SET	54		
Settings	54		
Setting the buzzer for each condition.....	54		
7. SECURITY LOCK SET	55		
Password setting example	55		
Settings	55		
Setting the administrator password.....	55		
Setting the user password	57		
Setting the password for recording and playback operations	57		
Preventing copying to CD-R/RWs and CompactFlash cards	58		
Setting the security lock	58		
8. RS-485/NETWORK SET.....	59		
Network connections and settings	59		
RS-485 connections and settings	61		
9. POWER LOSS/USED TIME	62		
10. MENU UPLOAD/DOWNLOAD	63		
Settings	63		

APPENDIX

1. CONTROL TERMINAL SPECIFICATIONS	66
System controller connections	66
Remote control connections	67
Alarm sensor connections.....	67
Series recording connections.....	67
2. RS-485 SPECIFICATIONS	68
RS-485 termination switch settings.....	68
3. INTERFACE SPECIFICATIONS.....	69
DVR/VCR command table	69

INTRODUCTION

1. MAIN FEATURES

■ Control for 4 monitoring cameras

This digital video recorder can record images from four monitoring cameras onto an internal hard disk.

■ Upgrade to large-capacity hard disk upgrade available

Up to two, 300 GB hard disks can be installed. Offers a long, continuous recording time of 336 hours or more with a 120 GB hard disk installed (standard image quality). Recording time varies depending on the size of the hard disk installed.

■ Protect data with mirroring

When two hard disks of the same size are installed, mirroring can be used to protect your data.

■ Complete range of recording/playback functions

- You can play back and record images at the same time.
- You can record and play back audio.
- The timer record function lets you make recordings at different times each day. (→P.16)
- Images from four cameras can be displayed on a single monitor, in the quad screen.
- The automatic channel switching function (SEQUENCE) lets you display the images from each channel on a single screen sequentially, or display just the desired image on a single screen.

- The motion sensor function allows you to automatically record images containing movements of intruders or others.

■ Search function - lets you instantly display the desired video (→P.22)

- Search in order of alarm occurrence.
- Search by date and time.

■ Security lock function – lets you restrict users, for data and equipment management (→P.55)

■ Expandability and PC connection

- The LAN terminal lets you connect the digital video recorder to a network, for remote operation/remote monitoring using a PC.
- Network connection lets you control up to 4000 DVRs (digital video recorder) using up to 8 PCs.*
- Can be connected to a system controller (sold separately) using the RS-485 terminal.
- A CD-R/RW drive or CompactFlash card reader can be connected using the USB port. Recorded videos can be copied to external media, and menu data can be transferred to multiple DSR-M814 digital video recorders using external media.

* VA-SW81LITE Ver.2 (supplied) or VA-SW814 Ver.2 (sold separately) software is required. (Some functions are not available with VA-SW81LITE Ver.2.)

2. ACCESSORIES

Check that you have all the parts below.

Power cord

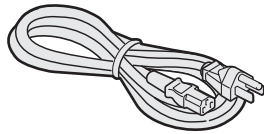

Ferrite core (1)

For: LAN connection cable

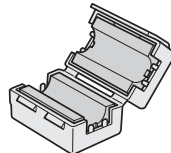

Power cord tie

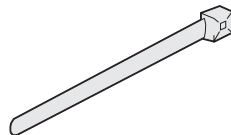

Application software (VA-SW81LITE Ver.2)

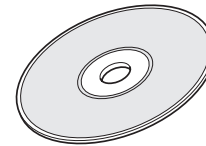

Instruction manual

- DSR-M814
- VA-SW81LITE

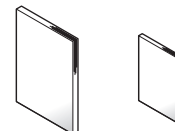

GNU GPL Open Software License Agreement



3. NAMES AND FUNCTIONS OF PARTS

Front panel

INTRODUCTION

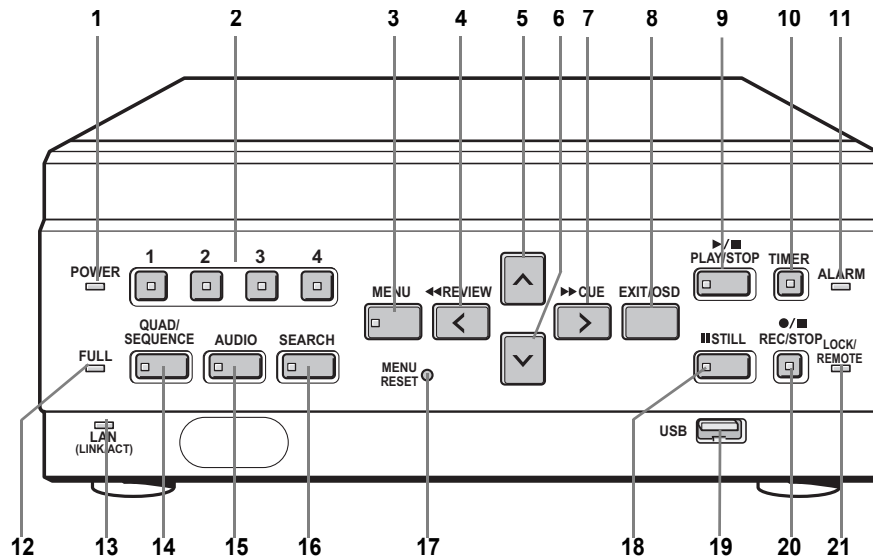

1. POWER indicator (→P.11)

Lights when the power is ON.
Flashes when there is a problem with the hard disk or fan.

2. CHANNEL buttons and indicators

Used when switching the image display from the quad screen to a single screen. Pressing a channel button lights its indicator and displays the corresponding image in a single screen.

3. [MENU] button and indicator

Used to display the menu screens. The indicator lights when a menu screen is displayed.

4. [REVIEW] button

When pressed during playback, lets you rewind the image while watching it on screen. Also used for menu screen operations.

5. [^] button

Used to move the cursor in menu screens up. Also used to change setting values.

6. [v] button

Used to move the cursor in menu screens down. Also used to change setting values.

7. [CUE] button

When pressed during playback, lets you fast-forward the image while watching it on screen. Also used for menu screen operations.

8. [EXIT/OSD] button (→P.30)

Returns the display to the normal screen when the main menu, a sub-menu, the search screen, or a setting screen is displayed.

9. [PLAY/STOP] button

Plays back the normal image (indicator lights). When pressed during playback, stops playback.

10. [TIMER] button and indicator (→P.16)

When the button is pressed while recording or stopped, the digital video recorder enters timer record standby, and the indicator lights. When the set time arrives, the digital video recorder starts timer recording.

11. ALARM indicator

Flashes when recording an alarm image.

12. FULL indicator (→P.44)

Lights when the remaining memory in the hard disk's recording area has reached zero and recording has stopped.

13. LAN indicator

Lights when the digital video recorder is connected to a network. Flashes when data is being sent and received.

14. [QUAD/SEQUENCE] button and indicator (→P.13)

Switches to the quad screen display, or switches from the quad screen display to each single-screen display in sequence.

15. [AUDIO] button and indicator

Switches the audio output channel.

16. [SEARCH] button and indicator (→P.22, P.24)

When the button is pressed while recording or stopped, the indicator lights, and the search setting screen is displayed.

17. [MENU RESET] button (→P.31)

Used to initialize the currently displayed menu settings, and to set the time.

18. [STILL] button

When pressed during playback, pauses the screen image (the indicator lights). Pressing the button again resumes playback.

19. USB port (→P.27, P.63)

Used to connect a CompactFlash card reader or CD-R/RW drive. You can copy settings (CompactFlash card only) and recorded videos.

20. [REC/STOP] button and indicator

Starts normal recording. Indicator lights during recording. During recording, pressing the button for at least 3 seconds stops recording and turns off the indicator.

21. LOCK/REMOTE indicator (→P.26, P.58)

Lights when operations have been locked by the key lock or security lock setting.

If an operation button is pressed when the security lock is set, a buzzer sounds. The key lock cannot be set during playback.

The indicator flashes at 4 times per second when there is a network connection, and flashes at 1 time per second when there is a network connection while locked.

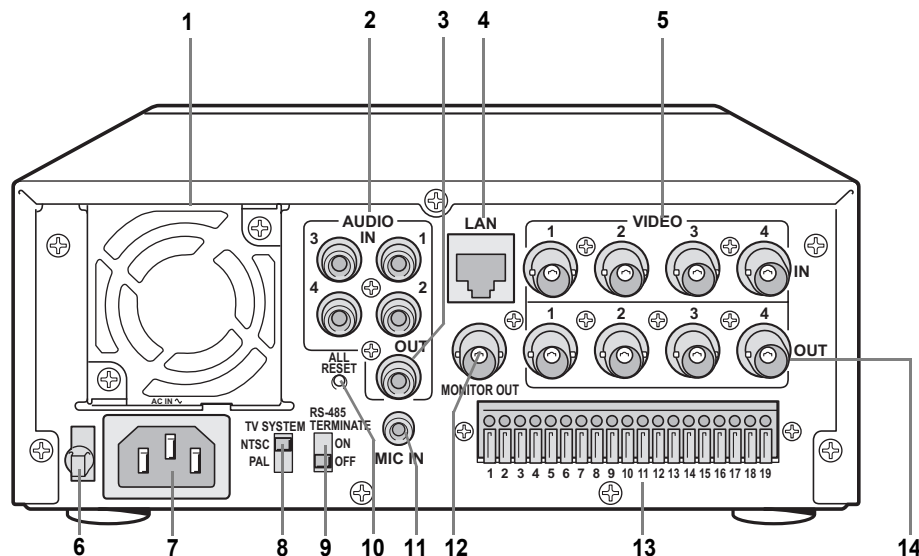
Rear panel**1. FAN****2. AUDIO IN terminals (4 channels)****3. AUDIO OUT terminal****4. LAN terminal (→P.59)****5. VIDEO IN terminals (4 channels)****6. Power cord holder**

Secure the power cord to the holder using the supplied cord tie. (→P.11)

7. AC INLET

AC power input terminal (3-core)

8. TV SYSTEM selector switch

Used to select between NTSC and PAL systems for the camera input and monitor output connected to the digital video recorder.

! CAUTION

Disconnect the power and then connect it again after selecting NTSC or PAL.

9. RS-485 TERMINATE switch

Turns RS-485 termination ON/OFF.

10. ALL RESET switch

Resets the clock and camera titles setting and restarts the unit. (Menu settings are maintained)

11. MIC IN terminal**12. VIDEO MONITOR OUT terminal**

Output terminal that displays quad screen on a single monitor.

13. Control and alarm terminals

Used to connect other digital video recorders and external devices, such as a system controller, remote control, and alarm sensors. (→P.66, P.67)

14. VIDEO OUT terminals (4 channels)

Terminals for output of individual video channels directly to the monitor.

4. INSTALLATION AND CONNECTIONS

When installing

The digital video recorder has ventilation holes. Make sure these holes are not blocked after installation. Do not use the unit in areas with poor ventilation, such as a bookshelf or box. When installing the unit in a rack, ensure a gap of at least 5 cm at the top and bottom.

Check the setting

Make sure the TV SYSTEM selector switch on the rear panel is set to "NTSC". (→P.8)



Disconnect the power and then connect it again after selecting NTSC or PAL.

Basic connections

This section describes how to connect the digital video recorder to CCTV cameras and other devices. Be sure to read the instruction manuals for each connected device. Make connections carefully. Improper connections can cause smoke or malfunctions.

The connections for cameras (4), TV monitor (1), microphone and PC are shown below.

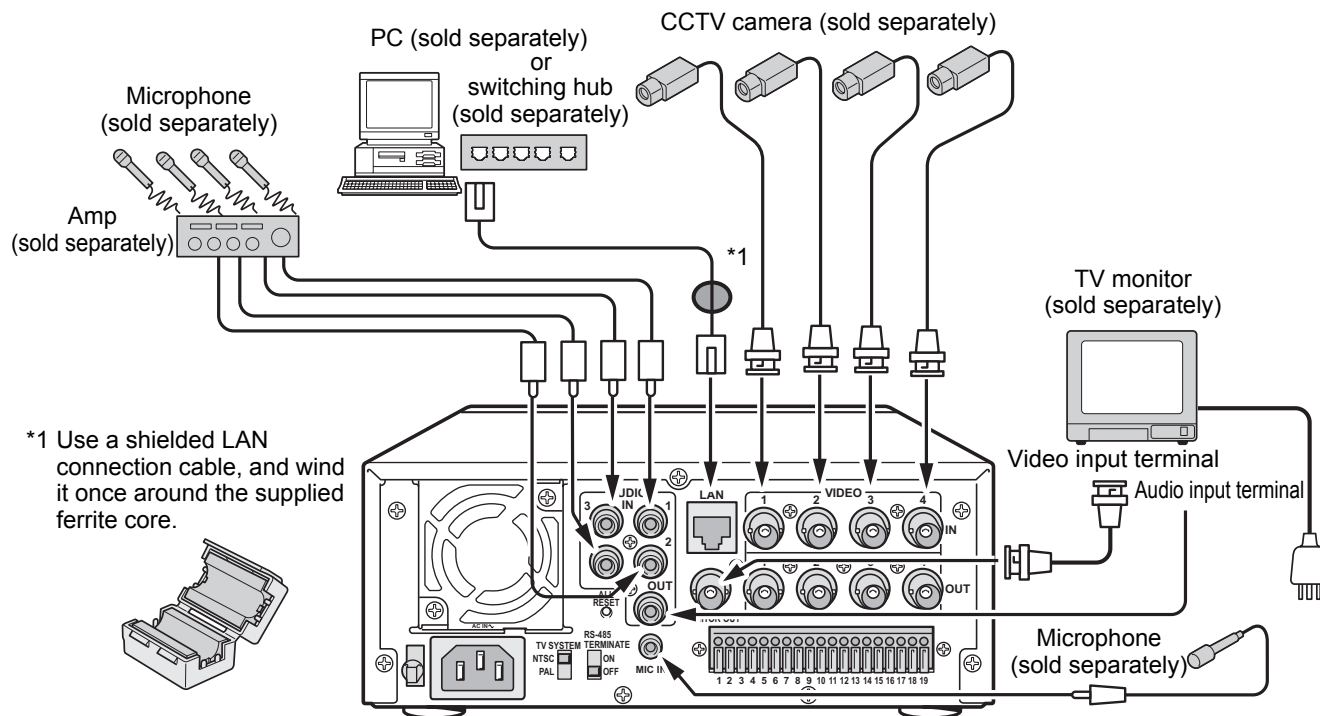

Connecting to a network

The digital video recorder can be connected to a 100BASE-TX network using the LAN terminal on the rear panel.

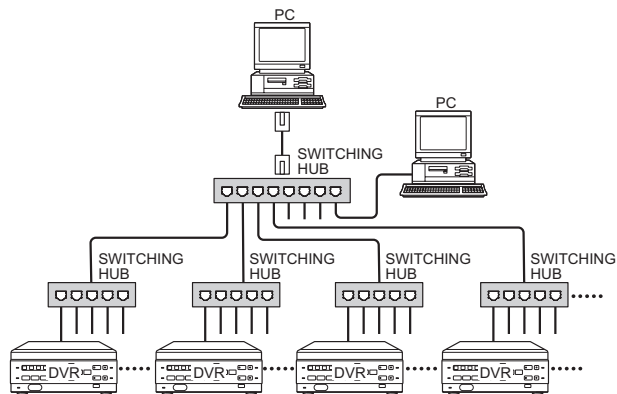

Up to 4000 digital video recorders (DVR) can be connected to a network, and the remote operation software, VA-SW81LITE Ver.2 (supplied) or VA-SW814 Ver.2 (sold separately) allows you to control all connected DVRs, and monitor live video and recorded audio and video from a PC. Multiple PCs can also be connected to the network. (Some functions are not available with VA-SW81LITE Ver.2.)

INSTALLATION AND CONNECTIONS

Connecting the power

When you have finished making all the other connections, insert the power plug into the wall outlet.

There is no power switch. The display indicators flash, and after a few moments, the monitor screen displays the camera image.

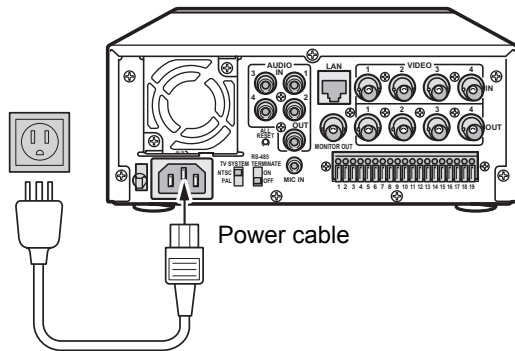

- **When turning the power ON for the first time**
“PLEASE SET THE CLOCK” is flashed on the monitor screen. Follow the steps on page 34 to set the clock.
- **If the clock is already set**
The operation display area is displayed.

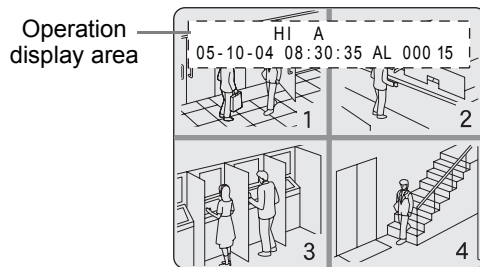

! CAUTION

- If a problem occurs when connecting the power or during operation, the POWER indicator flashes as follows to indicate the type of problem. Contact a Sanyo Authorized Service Center if this happens.

POWER indicator	Problem
Flashes 4 times per second	A problem has been found on the hard disk. The hard disk must be replaced or formatted. If you need to save videos stored on the hard disk, contact a Sanyo Authorized Service Center.
Flashes 1 time per second	There is a problem with the fan.

- After disconnecting the power cable, do not move the unit or subject it to vibration for at least 30 seconds. The disk in the hard disk drive briefly keeps spinning after the power is disconnected due to inertia. During this time the head is unstable, and the disk is more sensitive to shocks and vibrations than usual, so avoid even the lightest shocks.

Securing the power cord

Secure the power cord to the holder using the supplied power cord tie as shown in the illustration.

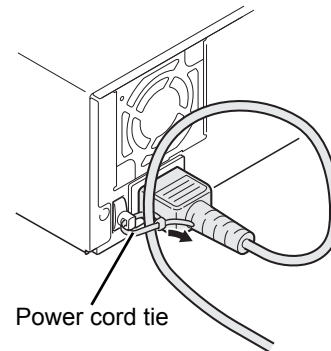

System controller connections

A single system controller (sold separately) allows you to set up multiple digital video recorders at the same time. (→P.66)

Remote control connections

A remote control can be used to perform the operations of the buttons on the front panel. To perform remote control operations, you must construct your own remote control. (→P.67)

Alarm sensor connections

Commercially available alarm sensors (normal open, low-level at detection) can be connected to the ALARM IN (1 to 4) terminals on the rear panel. (→P.67)

Series recording connections

When connecting this unit to additional digital video recorders, recording continues automatically on the next recorder when the hard disk of the first recorder is full. (→P.67)

OPERATION

1. ADJUSTING THE DISPLAY

At power ON, the operation display area appears at the top of the monitor screen. The operation display area shows the date/time, image quality, remaining time, and other information needed for operations.

Operation display area

Example: Normal screen

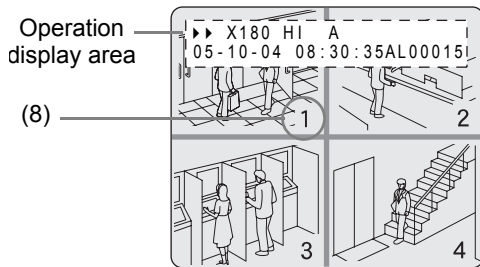
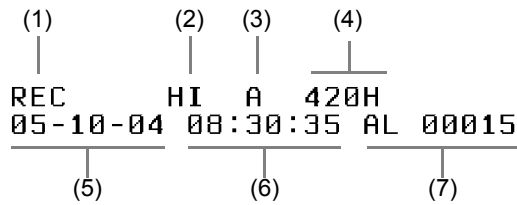

- (1) Operation symbol display
Displays symbols for recording, playback, playback speed, etc.
For the meaning of each operation symbol, see "Displayed symbols" on the right.

NOTE

During simultaneous recording and playback, the display indicates playback (▶).

- (2) Picture quality display (→P.44)
Displays the quality of the image that can be recorded on the hard disk. Set to "HIGH" in the default settings.
- (3) Audio recording
Displays "A" when audio recording has been set.
- (4) Remaining time display
Unless "OVER WRITE" is set for recording, displays the remaining amount of available recording time, as shown below.

Remaining time	Displayed increment	Example
1 hour or more	1 hour increments	1H
Less than 1 hour	10 minute increments	10M
Less than 10 minutes	1 minute increments	1M

- (5) Date display (→P.34)
Shows the month/day/year.
05-10-04 (month/day/year)
- (6) Time display (→P.34)
"PLEASE SET THE CLOCK" is displayed when you turn the power ON for the first time. The digital video recorder uses the date and time to manage recording and playback points.
- (7) Alarm display and alarm count display (→P.17)
When you set an alarm using the <ALARM REC MODE SET> menu item, the alarm display area displays the following information. (→P.46)
 - Alarm display
When alarm recording is set, "AL" appears. During alarm recording, the "AL" display flashes.
 - Alarm count display
Displays the total number of alarms that have been generated.
- (8) Camera title and VIDEO LOSS display
The title set for each camera is displayed. "VIDEO LOSS" is displayed when there is no video input.

ADJUSTING THE DISPLAY

Displayed symbols

The meanings of the symbols shown in the operation display area during recording or playback are listed below.

(1) Operation symbol display	Description
REC	Recording
▶	Playback
⏸	Still
◀◀	Rewind playback
▶▶	Fast-forward playback
⏪▶	Slow playback
◀◀⏪	Reverse slow playback
Playback speed display	
X2	2 times the normal playback speed
X7.5	7.5 times the normal playback speed
X15	15 times the normal playback speed
X30	30 times the normal playback speed
X180	180 times the normal playback speed
1/8	1/8 the normal playback speed
1/4	1/4 the normal playback speed
1/2	1/2 the normal playback speed
(2) Image quality display	
SU+	SUPER+
SUP	SUPER
HI	HIGH
STD	STANDARD
(3) Audio recording display	
A	Audio recording ON
(None)	Audio recording OFF
(4) Remaining time display	
000H	Displayed in 1 hour increments when the remaining time is 1 hour or more.
(7) Alarm count display	
AL00000	Displays the number of generated alarms.

OPERATION

Changing the position of the operation display

Press the [EXIT/OSD] button repeatedly.

Pressing the [EXIT/OSD] button repeatedly lets you move or hide the operation display area.

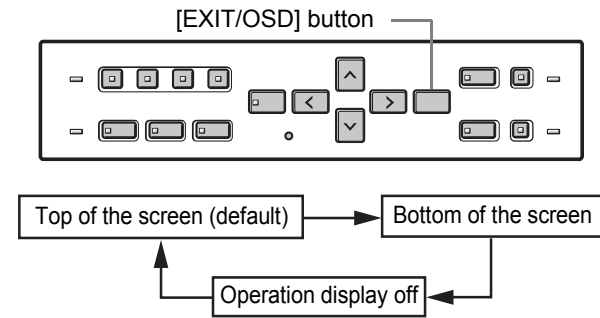

Example: Normal screen

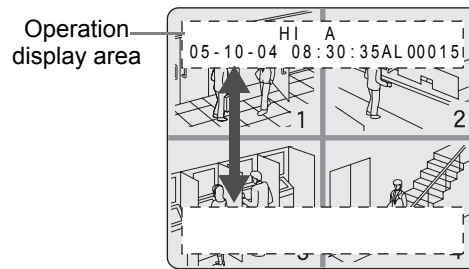

Displaying four screens in sequence automatically

Images are normally displayed in the quad screen. You can use the procedure below to display images in single screens.

To switch screens automatically, displaying each single screen in sequence

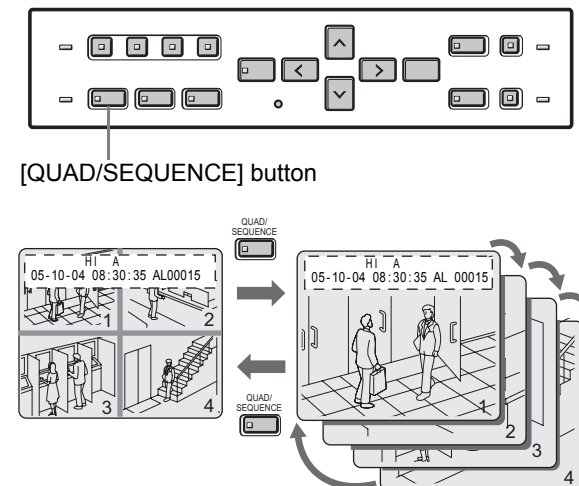

1 Press the [QUAD/SEQUENCE] button.

The image from each channel is displayed sequentially in single screens. Under the default settings, the channel switches automatically every 1 second.

To return to the quad screen**2 Press the [QUAD/SEQUENCE] button.**

The quad screen is displayed.

Displaying the image from a specified channel in a single screen

Follow the steps below to display the image from a specified channel in a single screen.

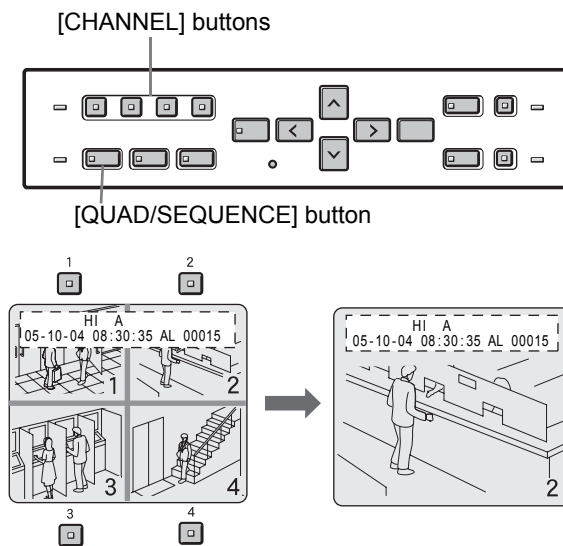
**1 Press the desired [CHANNEL] button.**

The indicator on the [CHANNEL] button lights. The image for the corresponding channel is displayed in the screen.

To return to the quad screen**2 Press the [QUAD/SEQUENCE] button.**

The quad screen is displayed.

NOTE

While the quad screen is displayed, press the [QUAD/SEQUENCE] button to toggle through single screens in sequence.

2. RECORDING

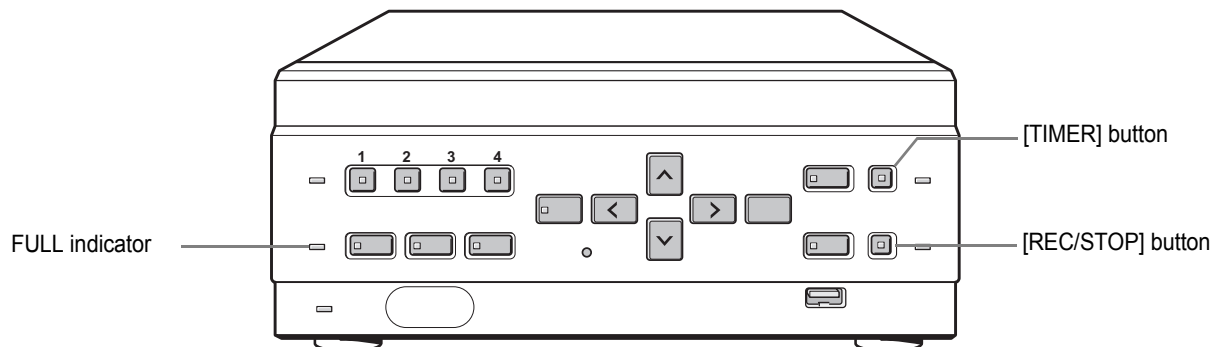

OPERATION

Recording

Follow the steps below to record the monitored image onto the hard disk.

! CAUTION

When using the recorder for the first time, check that the TV SYSTEM selector switch on the rear panel is set to "NTSC" correctly. If this switch is set incorrectly, recording will not be performed correctly. (→P.8)

1 Press the [REC/STOP] button.

The REC/STOP indicator lights. "REC" appears on the screen, and recording starts.

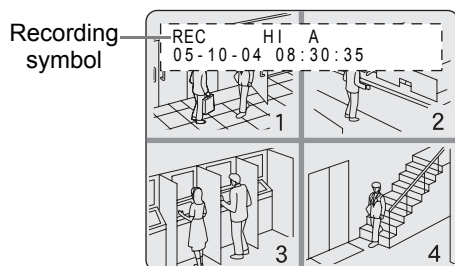

NOTE

- When you record for the first time, the default settings are used. To change the image quality. (→P.43)
- When the OVER WRITE recording setting is "ON", the DVR starts recording from the beginning again. When it is "OFF" and the remaining space reaches zero, recording stops and the FULL indicator lights. (→P.44)
- You can record and play back images at the same time. (→P.19)
- You cannot change the menu during recording.

To end recording

2 Press the [REC/STOP] button for about 3 seconds.

The REC/STOP indicator turns off and recording stops.

Recording with the timer (timer recording)

Follow the steps below to record the monitored image onto the hard disk at the set time.

1 Press the [TIMER] button.

The TIMER indicator lights, and the digital video recorder enters timer recording standby mode.

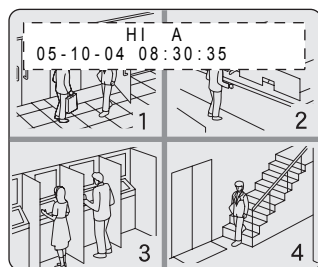

! CAUTION

- A warning tone sounds if timer recording has not been set.

- (1) See P.47 for how to set timer recording.
- (2) When the time specified in the timer settings arrives, the REC/STOP indicator lights, "REC" appears in the screen, and recording starts.
- (3) When the set end time arrives, the REC/STOP indicator turns off, and recording stops.
- (4) The following restrictions apply to normal recording normal and timer recording.
 - After making "PICTURE QUALITY" or "AUDIO RECORDING" menu settings and returning to the camera screen, recording does not start for a maximum of 6 seconds (although normal recording and timer recording operations can be made).
 - After recording finishes (the REC/STOP indicator turns off), recording does not start for a maximum of 10 seconds (although normal recording and timer recording operations can be made).

NOTE

- When the remaining memory space for recording reaches zero, recording stops, and the FULL indicator lights. You can start recording from the beginning again by changing the "OVER WRITE" setting. (→P.44)
- You can record and play back images at the same time. (→P.19)

To stop during timer recording

2 Press the [TIMER] button.

The TIMER indicator turns off and recording stops.

RECORDING

Recording upon alarm detection

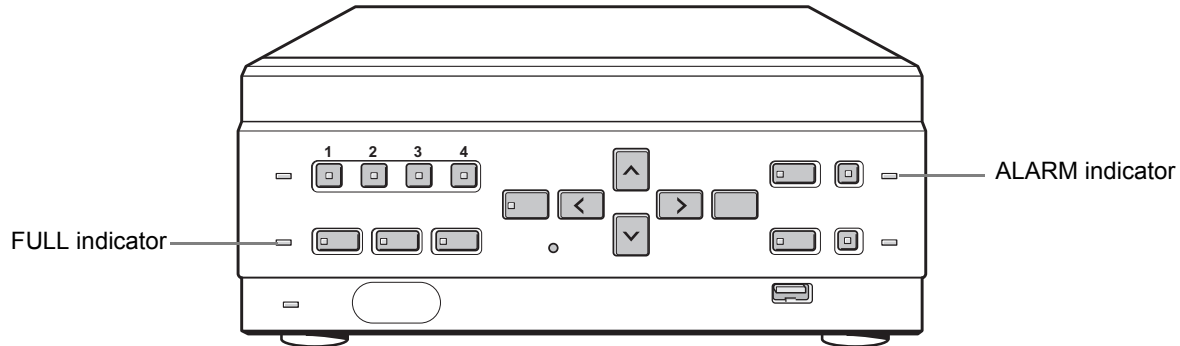

OPERATION

The digital video recorder can make an alarm recording when the motion sensor on the screen or an alarm sensor connected to an ALARM IN terminal detects an alarm condition.

! CAUTION

Check that the cable of the device required for alarms is connected to the ALARM terminal. (→P.8)

NOTE

When the motion sensor is set, an alarm is recorded when a moving subject is detected. (→P.41)

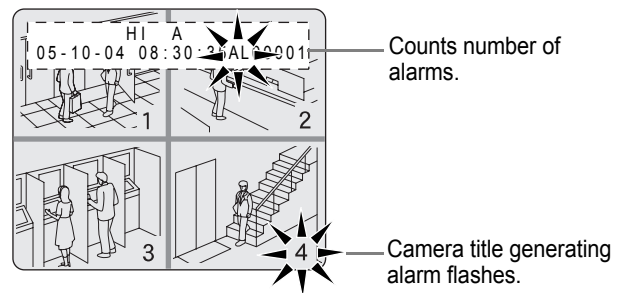

- “AL” appears in the operation display area.
- When an alarm is generated on a channel that is already alarm recording, the alarm recording time is extended counting from that moment. The new alarm is not counted, and the alarm count remains the same. If an alarm is generated on a separate channel, the alarm count increases.
- The 49,999 most recent incidents are stored in the alarm history (recording list). Older incidents are erased.
- The camera title generating the alarm flashes.
- The panel’s ALARM indicator flashes.

Setting alarm recording

Display the <3. RECORDER MENU> screen, and set “ALARM MODE” in “ALARM REC MODE SET” to something other than “OFF”, and set the conditions for the alarm trigger. (→P.46)

The default settings are shown below.

ALARM MODE	OFF	Alarm recording is disabled.
ALARM DURATION	20SEC	Recording is performed for 20 seconds for each alarm signal received while the alarm is set.
ALARM TRIGGER	ALARM	Performs alarm recording when an external alarm is generated.
VIDEO LOSS	ON	Displays “VIDEO LOSS” on the screen when the camera image is interrupted. Also outputs the WARNING OUT signal to a rear panel terminal.

When an alarm input is detected...

When a specified alarm trigger is detected, the following display appears in the operation display area, and an alarm image is recorded.

Ending alarm recording

When the alarm duration time (default setting: 20 seconds) ends, "AL" disappears from the operation display, the ALARM indicator stops flashing, and recording stops.

NOTE

- When the hard disk's remaining space for recording reaches zero, the FULL indicator lights and recording stops. You can start recording from the beginning again by changing the recording setting. (→P.44)
- Alarm recording is taken at the [PICTURE QUALITY] setting made in [3.RECORDER MENU]>[1.REC MODE SET]. (→P.43)

CAUTION

The following restrictions apply to alarm recording.

- (1) After recording starts (Standby→REC/STOP indicator lights).
- (2) After making "PICTURE QUALITY" or "AUDIO RECORDING" menu settings and returning to the camera screen.
For (1) and (2):
 - Alarm input is not recognized for a maximum of 4 seconds. Alarm input after the 4 seconds are recognized as usual.
 - Recording does not start for a maximum of 6 seconds regardless of alarm input.
- (3) After recording finishes (the REC/STOP indicator turns off).
 - Alarm input is not recognized for a maximum of 5 seconds. Alarm input after the 5 seconds are recognized as usual.
 - Recording does not start for a maximum of 10 seconds regardless of alarm input.

3. PLAYING BACK VIDEOS

Follow the steps below to play back videos recorded on the hard disk.

Playback

[PLAY/STOP] button

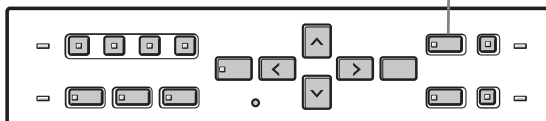

OPERATION

1 Press the [PLAY/STOP] button.

The [PLAY/STOP] button lights, and ► appears in the operation display area. The videos recorded on the hard disk are played back in the quad screen.

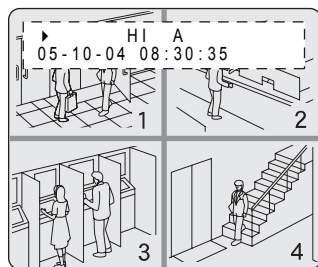

NOTE

- Video playback starts from the point at which recording started.
- If "OVER WRITE" has been set in the normal recording settings, playback starts with the oldest recorded video when the recording is played back for the first time.
- When playback ends, the digital video recorder pauses automatically.
The [STILL] button lights, and (||) appears in the operation display area.
- After playback is stopped, it will resume from the stopped point the next time it is started.
- You can display quad screen images in single screens. (→P.13)

To end playback

2 Press the [PLAY/STOP] button.

Playback ends.

■ Playing back a video near the point of recording

The digital video recorder prioritizes recording operations, so the playback image may pause temporarily.

Fast-forwarding or rewinding during playback

[<] (REVIEW) button [^] button [>] (CUE) button

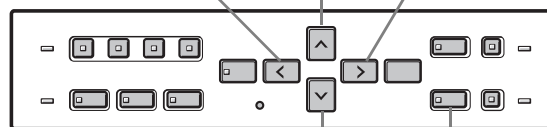

[v] button [STILL] button

Press the [>] (CUE) or [<] (REVIEW) button during playback or when a still image is displayed.

When you press the [>] (CUE) button, ►► appears in the operation display, and the playback fast-forwards at 2 times the normal playback speed. When you press the [<] (REVIEW) button, ◀◀ appears in the operation display, and the playback fast-rewinds at 2 times the normal playback speed.

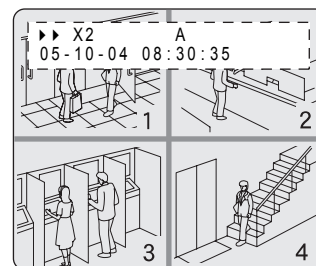

To change the fast-forward speed

Press the [^] button while fast-forwarding.

Press the button once to increase the speed to 7.5 times the playback speed, twice to increase the speed to 15 times the playback speed, 3 times to increase the speed to 30 times the playback speed, and 4 times to increase the speed to 180 times the playback speed.

To change the fast-rewind speed

Press the [∇] button while rewinding.

Press the button once to increase the speed to 7.5 times the playback speed, twice to increase the speed to 15 times the playback speed, 3 times to increase the speed to 30 times the playback speed, and 4 times to increase the speed to 180 times the playback speed.

To end fast-forward/rewind

Press the [PLAY/STOP] button.

Normal playback starts.

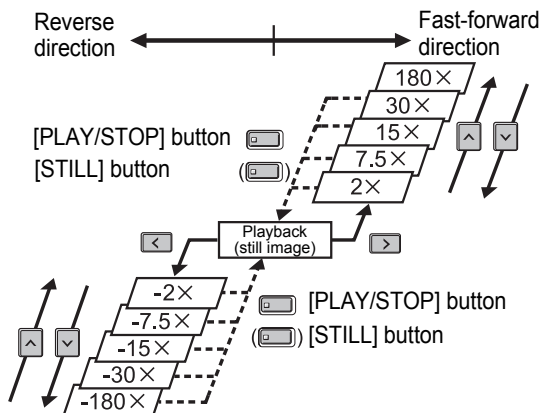

Viewing still images

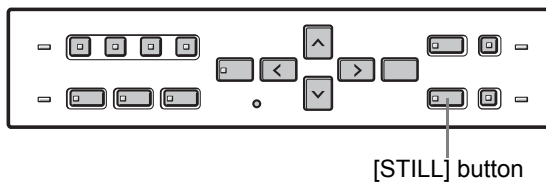

1 During playback, press the [STILL] button.

The video becomes a still image (pauses).
 ■■ appears in the operation display area.

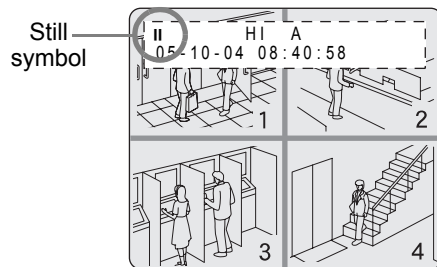

To resume playback

2 Press the [STILL] button.

Frame advance (reverse)

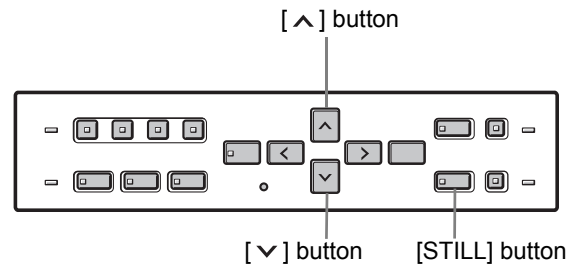

Press the [^] button while a still image is displayed.

The still image advances by one frame.

Press the [∇] button while a still image is displayed.

The still image moves back three frames.

Slow playback

Hold down the [^] button for at least 2 seconds while a still image is displayed.

The playback speed slows to 1/8 the normal speed.
 Pressing the [^] button again switches the playback speed to 1/4 the normal speed.
 Pressing the button twice switches the playback speed to 1/2 the normal speed.

Slow reverse playback

Hold down the [∇] button for at least 2 seconds while a still image is displayed.

The playback speed slows to 1/8 the normal speed.
 Pressing the [∇] button again switches the playback speed to 1/4 the normal speed.
 Pressing the button twice switches the playback speed to 1/2 the normal speed.

PLAYING BACK VIDEOS

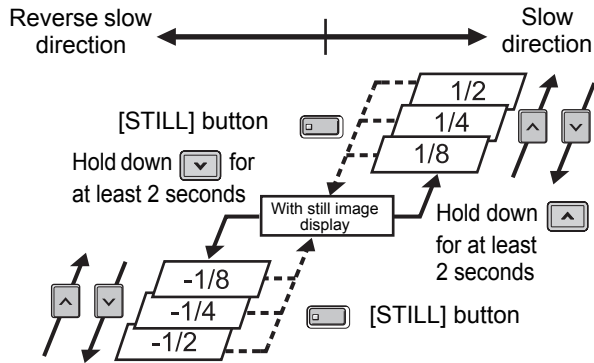

OPERATION

Switching audio channels

Follow the steps below to turn the audio ON or OFF, or switch the audio channels.

CHANNEL indicators

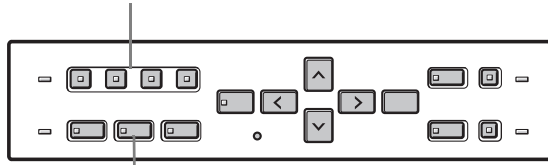

Press the [AUDIO] button.

The [AUDIO] button flashes during audio settings mode. Each time you press the button, the audio channels switch as shown below. The channel indicator lights when that channel is playing back.

During recording

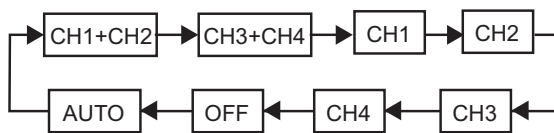

During playback

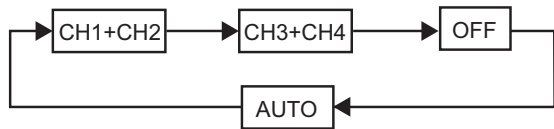

! CAUTION

During playback, you cannot playback audio from one specific channel.

4. SEARCHING FOR RECORDED VIDEOS

Videos recorded on the hard disk can be searched for and played back. There are two search methods available.

Video to search

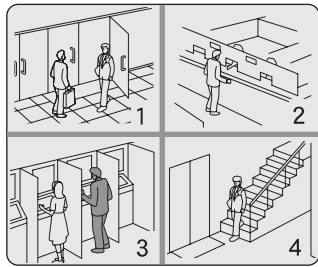

Search in <SEARCH> screen

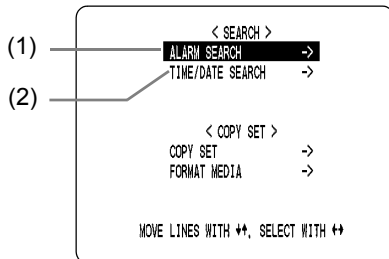

NOTE

You can use the button operations to pause, fast-forward or perform other operations on retrieved images being played back.

Alarm search

Lets you search for and play back any alarm recording on the hard disk.

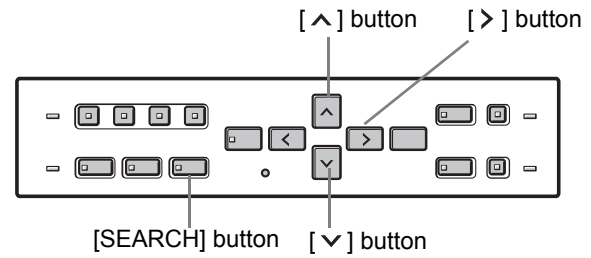

- 1 Press the [SEARCH] button while the digital video recorder is recording or stopped.

The <SEARCH> screen is displayed.

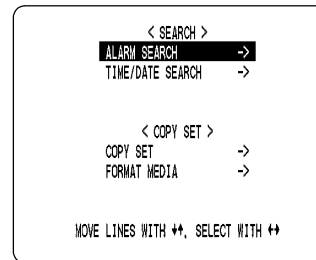

(continued)

(1) ALARM SEARCH

Lets you search for and play back alarm recordings.

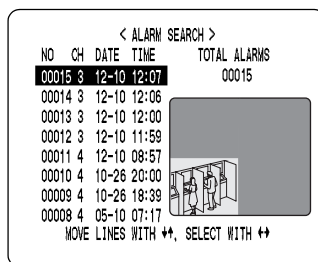

(2) TIME/DATE SEARCH (→P.24)

Lets you search and play back recorded videos by date and time.

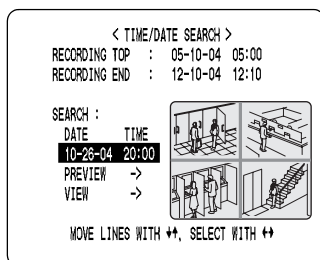

SEARCHING FOR RECORDED VIDEOS

OPERATION

2 Select "ALARM SEARCH", and press the [>] button.

The <ALARM SEARCH> screen is displayed.

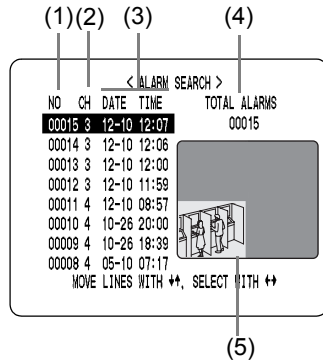

- (1) NO:
Displays the alarm number.
- (2) CH:
Displays the channels of the images that contain alarms.
- (3) DATE/TIME:
Displays the date and time at which the alarm was received and the video recorded.
- (4) TOTAL ALARMS:
Displays the total number of alarm recordings.
- (5) Preview screen:
The selected alarm recording is displayed in the quad screen.

3 Press the [^] or [v] button to select the image to play back.

The selected alarm image is displayed in the preview screen. You can list up to 8 alarm recordings.

- To display the next (previous) video
Press the [^] or [v] button.
- To display the items on the next page
Press the [MENU] button. The next 8 videos are listed chronologically.
- To end search mode
Press the [EXIT/OSD] button.

4 Press the [>] button.

The video is played back on the full screen.

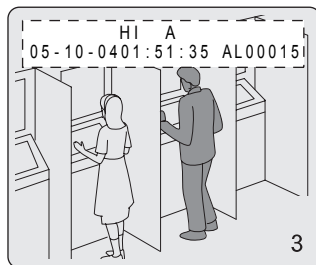

To display an alarm recording by entering the alarm number directly

1 Press the [SEARCH] button while the digital video recorder is recording or stopped.

The <SEARCH> screen is displayed.

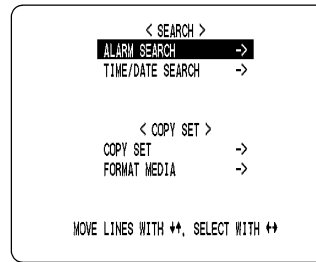

2 Select "ALARM SEARCH", and press the [>] button.

The <ALARM SEARCH> screen is displayed.

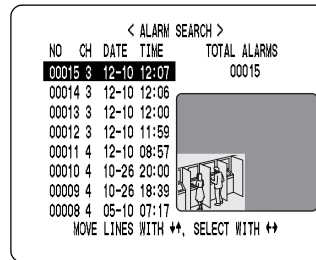

3 Press the [SEARCH] button.

The "ALARM NO" input screen is displayed.

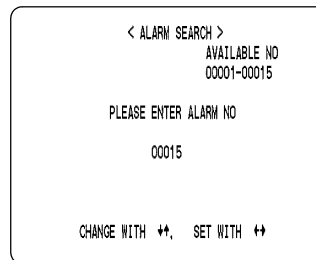

SEARCHING FOR RECORDED VIDEOS

4 Enter the alarm number of the desired video.

“AVAILABLE NO” indicates the numbers that can be searched. Enter the approximate number of the desired image.

Press the [^] and [v] buttons to change the number.

Press the [>] button to move the cursor.

PLEASE ENTER ALARM NO



5 Press the [>] button.

The page with the input alarm number is displayed.

Date and time search

Follow the steps below to play back a video recorded on the hard disk by specifying its date and time.

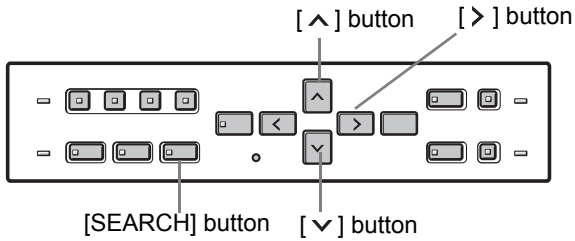

1 Press the [SEARCH] button while the digital video recorder is recording or stopped.

The <SEARCH> screen is displayed.

2 Press the [^] or [v] button to select “TIME/DATE SEARCH”.

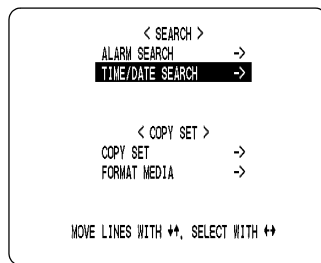

3 Press the [>] button.

The <TIME/DATE SEARCH> screen is displayed.

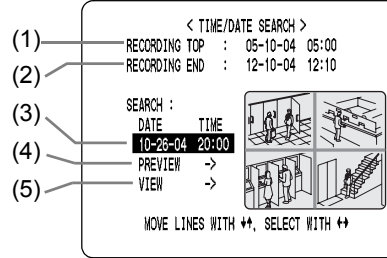

- (1) RECORDING TOP: Displays the date and time of the video recorded first.
- (2) RECORDING END: Displays the date and time of the video recorded last (most recent video).
- (3) SEARCH: Enter the date and time of the video to play back.
- (4) PREVIEW: Select this item to display the preview screen.
- (5) VIEW: Select this item to play back the video on the quad screen. (continued)

OPERATION

SEARCHING FOR RECORDED VIDEOS

OPERATION

4 Press the [>] button, and set the date and time to search.

Example: To search for the video from October 26 2004 20:00

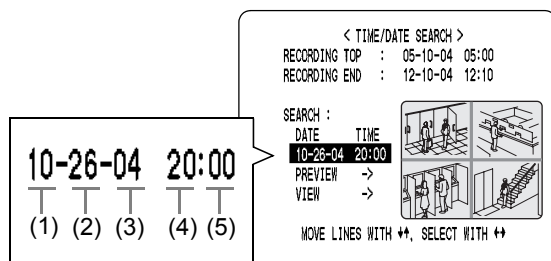

- (1) Press the [^] or [v] button to select "10" (the month).
- (2) Press the [>] button, and then the [^] or [v] button to select "26" (the day).
- (3) Press the [>] button, then the [^] or [v] button to select "04" (the year).
- (4) Press the [>] button, and then the [^] or [v] button to select "20" (the hour).
- (5) Press the [>] button to select "00" (the minutes), then press the [>] button.
The cursor moves to PREVIEW.

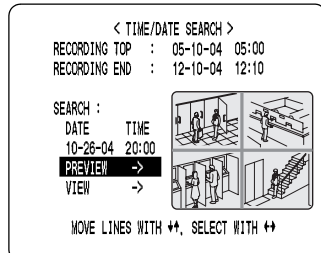

5 Press the [>] button.

- If no video exists for the specified time
The video closest to the selected time is displayed.
- To end search mode
Press the [EXIT/OSD] button.

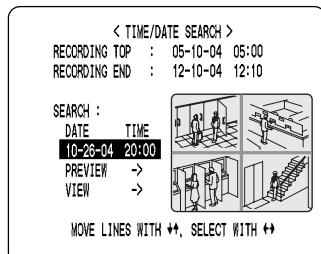

6 Press the [v] button to select "VIEW", then press the [>] button.

The preview screen image is played back in the quad screen.

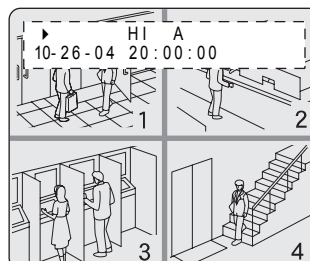

NOTE

- The retrieved video can be displayed in the quad screen format without displaying the preview screen by entering the date and time, and selecting "VIEW".
- You can use the button operations to pause, fast-forward or perform other operations on retrieved videos being played back.
- You can display quad screen videos in single screens. (→P.13)

5. PREVENTING ACCIDENTAL OPERATION (KEY LOCK FUNCTION)

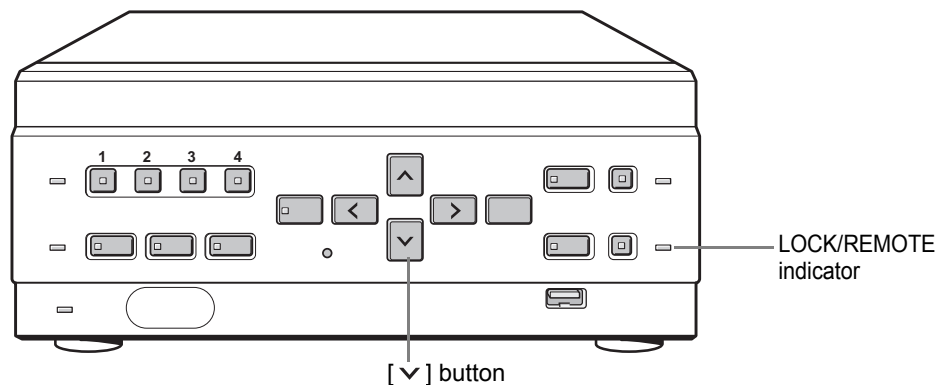

Follow the steps below to set the key lock function, preventing accidental pressing of the operation buttons.

Setting the key lock function

With the digital video recorder recording or stopped, hold down the [∨] button for about 3 seconds.

When the key lock is set, a confirmation tone sounds, and the LOCK/REMOTE indicator lights.

NOTE

- The key lock setting is not released at power OFF.
- You cannot set the key lock during playback.

Releasing the key lock function

With the key lock function set, hold down the [∨] button for about 3 seconds.

When the key lock is released, a confirmation tone sounds, and the LOCK/REMOTE indicator turns off.

CAUTION

- When the key lock function has been set, the buttons cannot be used for settings or operations.
- If you have already set the security lock, the password entry screen is displayed. (→P.58)
- When the security lock is set, you cannot set the key lock alone.

6. COPYING RECORDED VIDEOS TO EXTERNAL MEDIA

OPERATION

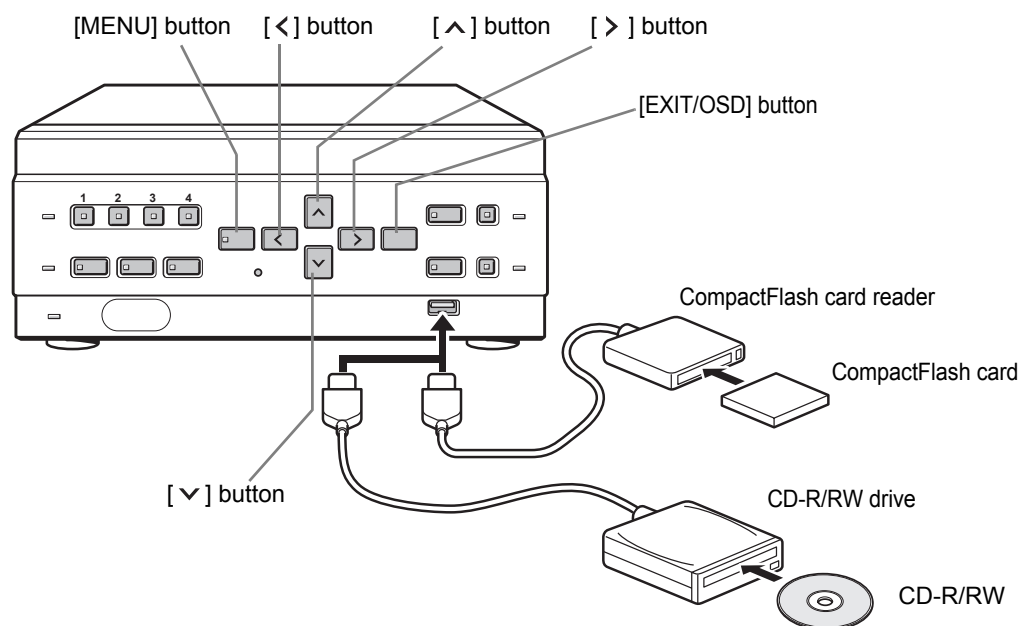

Use the following procedure to copy recorded videos to a CompactFlash card or CD-R/RW. CompactFlash cards and CD-R/Ws can also be formatted as described below.

! CAUTION

- Do not turn off the power while a video is being copied.
- Data is written to CD-R/RWs using single-session recording. Once data has been written, therefore, it will not be possible to add additional data to a disc, even if free space is available.
- When a large amount of data is to be copied, it can be divided between a number of different discs or cards.
- At least 2MB of available space is required when copying to a CompactFlash card.

NOTE

- The digital video recorder can automatically detect whether the copy destination is a CompactFlash card or a CD-R/RW disc.
- Set the security lock setting for COPY TO CD-R/CF to "USE". (→P.55)

Copying to external media

Connect either a CompactFlash card reader or a CD-R/RW drive to the USB port on the front of the digital video recorder.

- 1 Press the [SEARCH] button while the digital video recorder is recording or stopped.

The <SEARCH/COPY> screen appears.

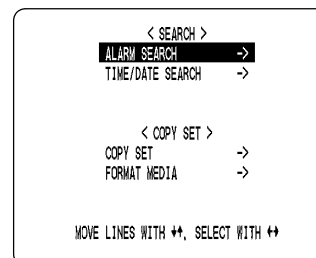

2 Press the [^] and [v] buttons to select "COPY SET" and press the [>] button.

The <COPY SET> screen appears.

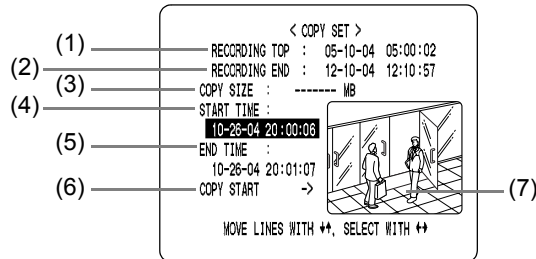

- (1) RECORDING TOP:
Displays the date and time of the video recorded first.
- (2) RECORDING END:
Displays the date and time of the video recorded last.
- (3) COPY SIZE:
Displays the amount of data between "START TIME" and "END TIME" in MB.
If this data is less than 1 MB in size, "----" is displayed and "COPY START" will not be possible.
- (4) START TIME:
Specifies the date and time for the start of copying.
- (5) END TIME:
Specifies the date and time for the end of copying.
A date and time earlier than "START TIME" cannot be specified.
- (6) COPY START:
Starts copying when selected.
- (7) Preview:
Displays the image corresponding to the date and time set by "START TIME" or "END TIME".

3 Press the [^] and [v] buttons to specify "START TIME" and "END TIME", and then press the [>] button.

4 Press the [^] and [v] buttons to select "COPY START", and then press the [>] button.

Copying of video starts.

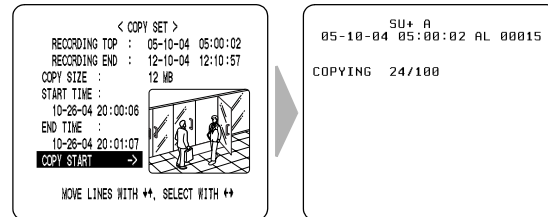

When copying has been completed, "COPY FINISHED" appears, and the screen will return to the live video display when any button is pressed.

NOTE

- A video is copied to the CompactFlash card, CD-R/RW as follows.
Example: Copying from 10:15 on April 25th with a DVR NAME of "FRONT"
- CompactFlash card, CD-R/RW
- ```

├── FRONT (1)
│ ├── 0425-1015.mp2
│ └── 0425-1015-1.mp2
│ └── 0425-1015-2.mp2 (2)

```
- (1) A folder is created for the DVR NAME on the CompactFlash card, or CD-R/RW.
  - (2) A file is created inside that folder with its name reflecting the date and time.
- If "DVR NAME" has not been set, the name "DSR-M814" will be used when creating folders.
  - The character "+" will be used to replace any slash (/), semi-colon (;), asterisk (\*), period (.), or colon (:), characters appearing in "DVR NAME".
  - When adding data to the same CompactFlash card, folders such as "Folder name-1" will be created.
  - For information on CompactFlash readers and CD-R/RW drives that can be connected, contact the dealer or Sanyo service center.

## COPYING RECORDED VIDEOS TO EXTERNAL MEDIA

### Formatting a CompactFlash card or CD-RW

OPERATION

- 1 Press the [SEARCH] button while the digital video recorder is recording or stopped.

The <SEARCH/COPY> screen appears.

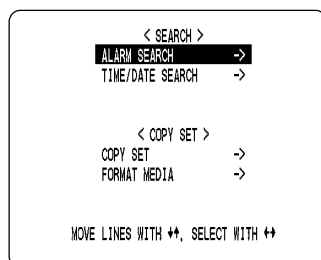

- 2 Press the [^] and [v] buttons to select "FORMAT MEDIA" and press the [>] button.

The <WARNING> screen appears.  
"NO" flashes.

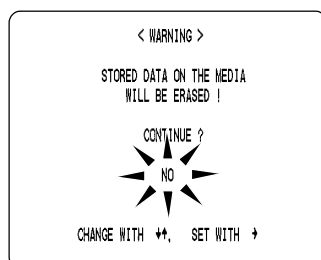

- 3 Press the [^] and [v] buttons to select "YES" and press the [>] button.

Formatting of the media starts.

When formatting has been completed, "FORMAT FINISHED" appears, and press the [<] button to return to the <SEARCH/COPY> screen.

# SETTINGS

## 1. MENU CONFIGURATION

This section describes the menu configuration, and which menu item to select for each operation.

### Operating menu screens

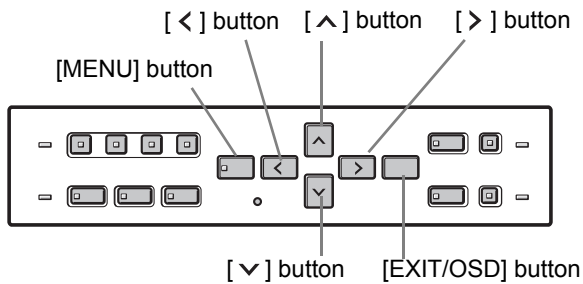

#### 1 Press the [MENU] button.

The <MAIN MENU> screen is displayed.

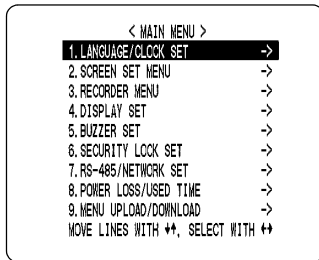

#### 2 Press the [^] or [v] button to select the desired item.

(Example: Selecting "5. BUZZER SET")  
When you move the cursor, the selected item is displayed in reverse.

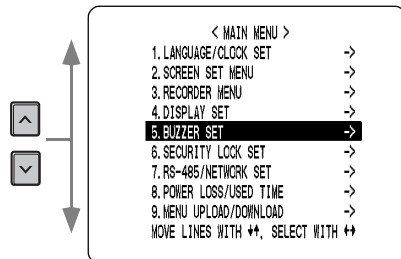

#### 3 Press the [ > ] button.

The setting screen of the selected item is displayed.  
For some items, lower-level menus can be selected.

### To change the settings

Use the [ ^ ], [ v ], [ < ] and [ > ] buttons to change the settings in each setting screen.

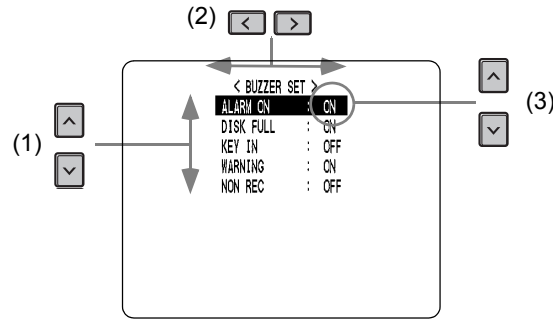

- (1) To move the cursor up or down  
Press the [ ^ ] or [ v ] button.
- (2) To move the cursor right or to a setting item  
Press the [ < ] or [ > ] button.
- (3) To change a setting value  
Press the [ ^ ] or [ v ] button.

#### 4 When you are finished changing the settings, press the [EXIT/OSD] button to end.

The display returns to the normal screen.

#### NOTE

- You can display the menu screen during recording, but not during playback.
- Press the [ < ] button to return to the menu screen from the sub-menu screen.

#### CAUTION

You cannot change menu settings while recording.

## MENU CONFIGURATION

### Restoring items to the default settings

Follow the steps below to restore the settings in the displayed setting screen to the default settings. Only the displayed settings are restored.

#### 1 Display the setting screen you want to restore.

#### 2 Press the [MENU RESET] button.

The displayed settings are restored to the default settings.

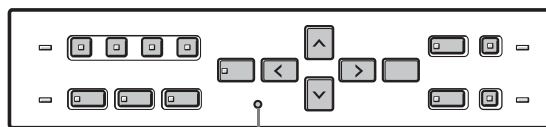

[MENU RESET] button

### 3. RECORDER MENU (→P.43)

Lets you make various recording settings, and initialize the hard disk.

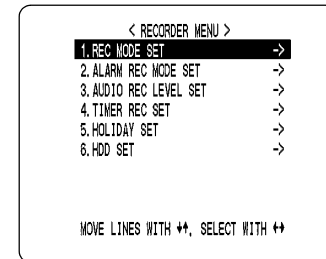

### 4. DISPLAY SET (→P.53)

Lets you display or hide information items in the operation display area.

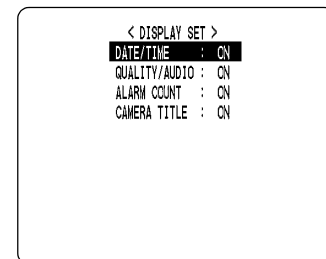

### 5. BUZZER SET (→P.54)

Lets you enable or disable audible alarms for various events.

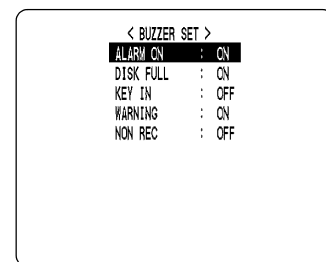

### 6. SECURITY LOCK SET (→P.55)

Lets you set passwords to prevent unauthorized users from operating the digital video recorder.

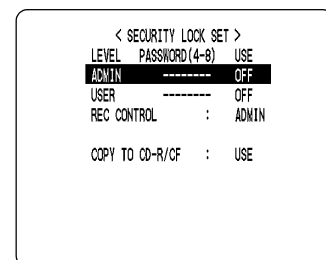

### 7. RS-485/NETWORK SET (→P.59)

Used to make the settings needed when connecting the digital video recorder to an external device by RS-485 interface, or to a PC via a network (LAN).

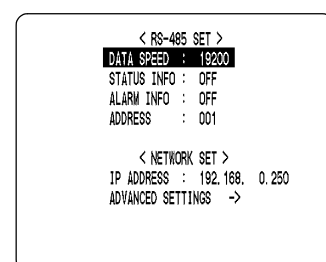

## SETTINGS

### Overview of settings

The following screens are setting screens displayed by selecting items from the <MAIN MENU> screen. Each time you press the [MENU] button, each of the screens shown on this page is displayed in the order shown.

#### 1. LANGUAGE/CLOCK SET (→P.33)

Enables the following settings:

- Screen display language
- Digital video recorder's date and time settings
- Daylight Saving time settings
- Time synchronization with external devices

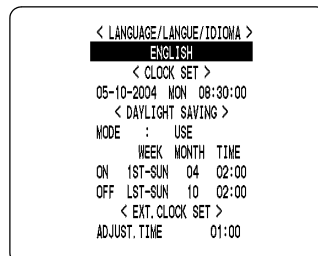

#### 2. SCREEN SET MENU (→P.38)

Lets you make the following screen-related settings:

- Screen display method
- Camera titles
- Motion sensor for detecting moving subjects

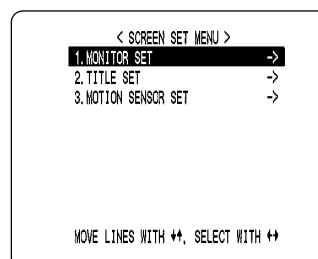



### 8. POWER LOSS/USED TIME (→P.62)

Lets you check the date and time of power failures and the elapsed amount of hard disk operation time.

```

< POWER LOSS/USED TIME >
POWER LOSS RECOVER
#004 09-09 11:16 09-09 13:17
 09-09 10:48 09-09 10:49
 09-09 10:40 09-09 10:41
 09-09 12:53 09-09 10:10
DISK1 USE : 00012 H
DISK2 USE : ----- H
POWER : 00012 H

FIRMWARE : MAIN 0.50-00 / SUB 0.50-00

```

### 9. MENU UPLOAD/DOWNLOAD (→P.63)

Lets you save menu setting values onto a CompactFlash card. Also lets you read menu setting values saved on CompactFlash cards. Formats CompactFlash cards.

```

< MENU UPLOAD/DOWNLOAD >
DVR TYPE VER. SAMQ-02

SAVE MENUS TO CF ->
LOAD MENUS FROM CF ->
* COPY MIRRORING SETTINGS: NO
FORMAT CF ->

* IF YOU COPY MIRRORING SETTINGS,
 HARD DISK MAY BE INITIALIZED!

```

## 2. SETTING THE LANGUAGE AND TIME

<MAIN MENU>

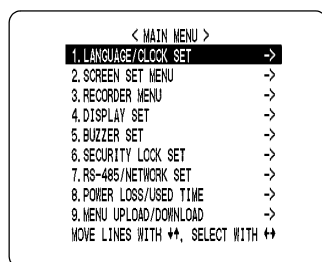

You can perform the following functions:

- Change the language used to display on screen information.
- Set the date and time displayed on the normal screen.
- Set the clock to adjust automatically for Daylight Saving time.
- Set all the devices to the same time automatically when multiple devices are connected.

### Changing the language

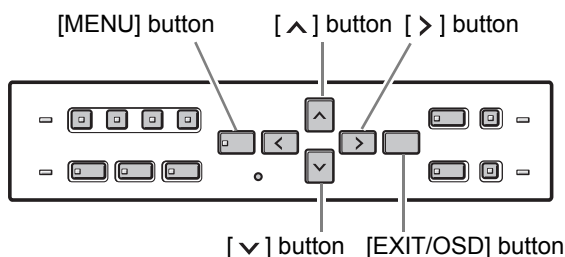

#### 1 Press the [MENU] button.

The [MENU] button lights, and the <MAIN MENU> screen is displayed.

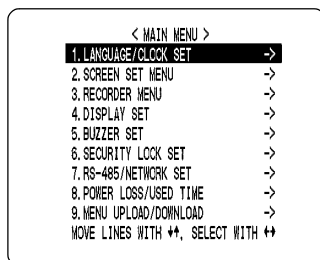

#### 2 Select, "1. LANGUAGE/CLOCK SET", and press the [ > ] button.

The <LANGUAGE/LANGUE/IDIOMA> screen is displayed.

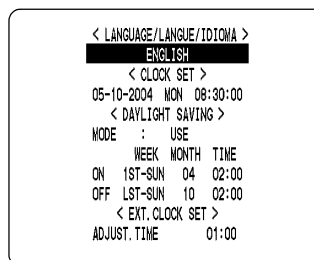

Settings (◆ indicates default setting.)

| Setting   | Description                   |
|-----------|-------------------------------|
| ◆ ENGLISH | Sets the language to English. |
| FRANCAIS  | Sets the language to French.  |
| ESPAÑOL   | Sets the language to Spanish. |

#### 3 Press the [ > ] button, then the [ ^ ] or [ v ] button to select the desired language.

The set item flashes.



#### 4 When you have made a selection, press the [ > ] button.

The language has now been set. To return to the normal screen, press the [EXIT/OSD] button.

#### 5 Press the [EXIT/OSD] button.

The display returns to the normal screen.

## Setting the time

(Default setting: 01-01-2004 THU 00:00:00)  
 Be sure to set the correct date and time. The digital video recorder stores the times of recordings for use in operations such as playback and search/playback.

**Example: Setting May 10, 2004, 8:30**

### 1 Press the [MENU] button.

The [MENU] button lights, and the <MAIN MENU> screen is displayed.

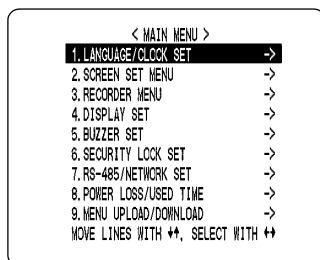

### 2 Select, "1. LANGUAGE/CLOCK SET", and press the [ > ] button.

The <LANGUAGE/LANGUE/IDIOMA> screen is displayed.



### 3 Press the [ ^ ] or [ v ] button to move the cursor to the date and time under <CLOCK SET>.



01-01-2004 THU 01:00:00  
 MONTH DAY YEAR WEEK TIME

### 4 Press the [ > ] button.

"01" (indicating the month) flashes.

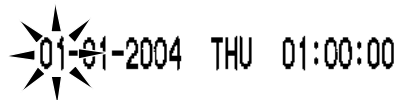

### 5 Press the [ ^ ] or [ v ] button to select "05".

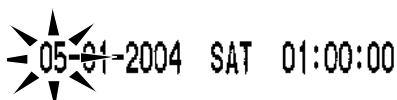

### 6 Press the [ > ] button.

"01" (indicating the day) flashes.

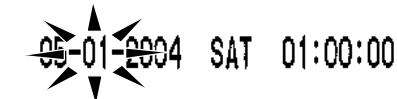

### 7 Use the same procedure to set the day (10 in this example), year (2004), hour (08) and minutes (30).

05-10-2004 MON 08:30:00

- "WEEK" is set automatically.
- The time is stopped during clock setting.

### 8 Press the [EXIT/OSD] button.

The display returns to the normal screen.

## <DAYLIGHT SAVING> settings

### 1 Press the [MENU] button.

The [MENU] button lights, and the <MAIN MENU> screen is displayed.

### 2 Select, "1. LANGUAGE/CLOCK SET", and press the [ > ] button.

The <LANGUAGE/LANGUE/IDIOMA> screen is displayed.

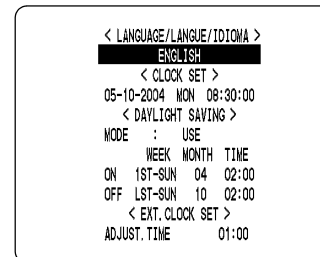

(continued)

SETTING THE LANGUAGE AND TIME

SETTINGS

**3** Press the [ ^ ] or [ v ] button to select "MODE" under <DAYLIGHT SAVING>.



**4** Press the [ > ] button.

"USE" flashes.

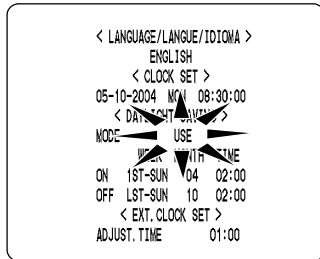

**5** Press the [ ^ ] or [ v ] button to change the setting.

Settings (◆ indicates default setting.)

| Setting | Description                                                 |
|---------|-------------------------------------------------------------|
| ◆ USE   | Time is automatically adjusted to Daylight Saving time.     |
| NO USE  | Time is not automatically adjusted to Daylight Saving time. |

**6** Press the [ > ] button.

The cursor moves to the date time at which to switch from standard time to Daylight Saving time.

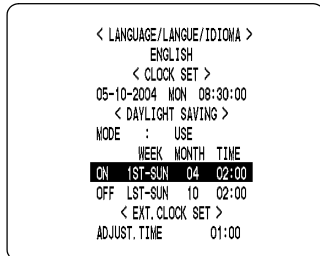

**When "USE" is selected for "MODE" under <DAYLIGHT SAVING>**

You can set the date and time at which the time is switched from standard time to Daylight Saving time, and the date and time at which the time is switched back again. The example below is the default value.

**Example:**

After the clock display reaches April 4, 2004, 01:59, the next clock display is 03:00, putting the clock an hour ahead (Daylight Saving time).

After the clock display reaches October 31, 2004, 01:59, the next clock display is 01:00, putting the clock an hour behind (back to standard time).

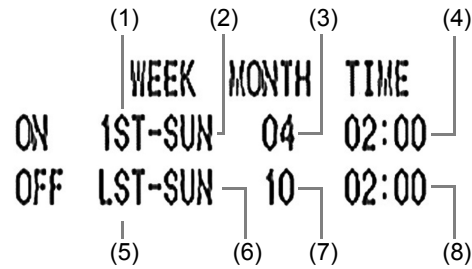

- (1) Sets the week for switching to Daylight Saving time.
- (2) Sets the day of the week.
- (3) Sets the month.
- (4) Sets the time.
- (5) Sets the week for ending Daylight Saving time.
- (6) Sets the day of the week.
- (7) Sets the month.
- (8) Sets the time.

**7** Press the [ > ] button.

The cursor moves to "1ST".

**8** Press the [ v ] or [ ^ ] button to select the desired week, then press the [ > ] button.

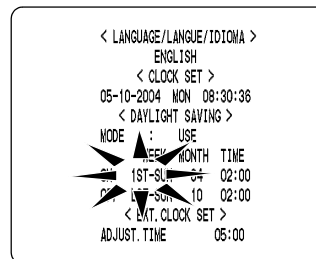

**9** Press the [ ^ ] or [ v ] button to select the desired day of the week, then press the [ > ] button.

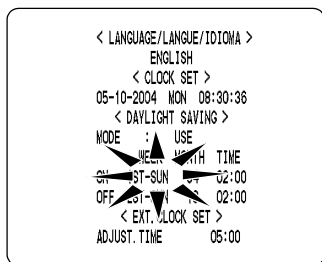

**10** Press the [ ^ ] or [ v ] button to select the desired month, then press the [ > ] button.

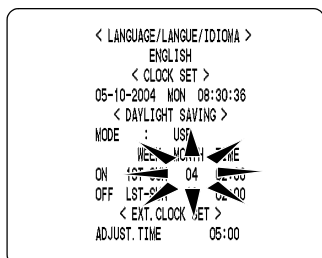

**11** Press the [ ^ ] or [ v ] button to select the desired time, then press the [ > ] button.

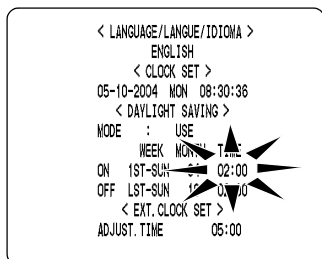

Set the desired minutes in the same manner. The <DAYLIGHT SAVING> settings are now finished.

### Synchronizing the time with other DSR-M814 DVRs (with two or more DVRs connected)

This section describes how to have the time synchronized automatically when two or more digital video recorders are connected. If you set the <EXT.CLOCK SET> time to 5:00, all the connected devices are synchronized to the same time (to the nearest second) every day at 5:00. (Default setting: 01:00)

**1** Use a cable to connect the **CLOCK ADJ OUT** terminal on the rear panel of one digital video recorder to the **CLOCK ADJ IN** terminal on the second digital video recorder.

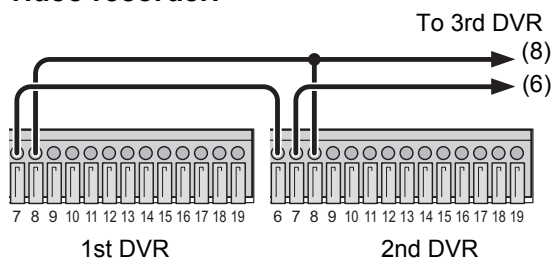

Terminal number  
 6: CLOCK ADJ IN  
 7: CLOCK ADJ OUT  
 8: C (ground)

**NOTE**

Do not use a loop connection.

**2** Press the [ v ] or [ ^ ] button to move the cursor to “ADJUST. TIME”.

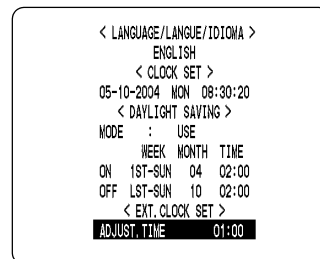

**3** Press the [ > ] button.

“01” flashes.

(continued)

## SETTING THE LANGUAGE AND TIME

- 4** Press the [∨] or [∧] button to select the desired time, then press the [>] button.

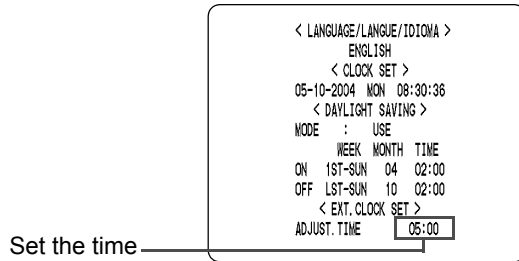

- 5** After you are finished changing the settings, press the [EXIT/OSD] button.

The display returns to the normal screen.

- 6** Repeat steps 2 to 5 to set the time on the second digital video recorder.

When you have finished making the settings, the display returns to the normal screen.

When the digital video recorder is connected to a PC or other external device through a network, you can also set the time from that device. When connected to a PC, see the instructions for the VA-SW814 Ver.2/VA-SW81LITE Ver.2 software.

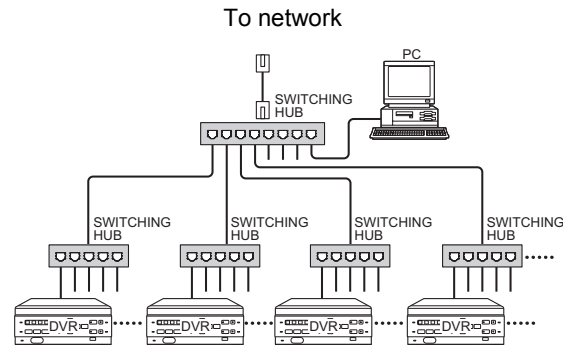

- Subsequent digital video recorders must be synchronized with the first unit for "ADJUST. TIME".
- Do not use a loop connection.

### 3. SCREEN SET MENU

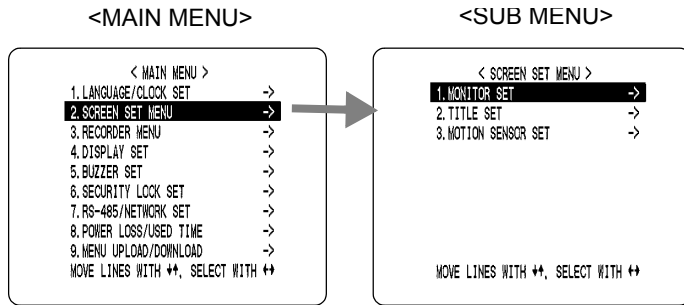

#### Screen settings

##### MONITOR SET

- “SEQUENCE” is used to set the time interval used for switching screens when displaying the image from each channel sequentially.

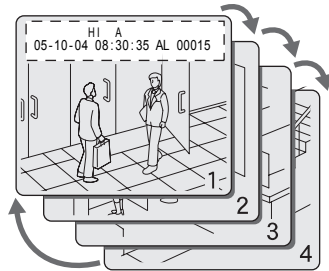

- “DISPLAY” setting is used when an alarm is generated. It sets whether to display the image from the channel that generated the alarm on a single screen, or whether to display on the quad screen.

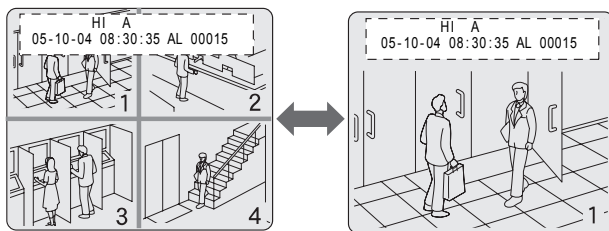

- “ALARM PRIORITY” sets the display method for alarm recording screens when an alarm is generated on another channel during alarm recording.

##### Example 1: Display screens in order of alarms.

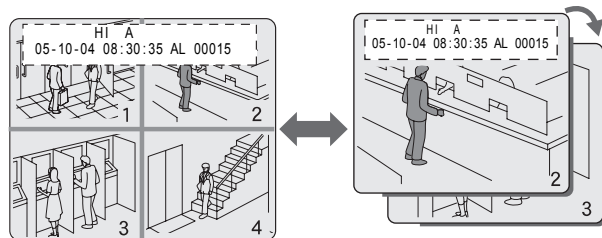

##### Example 2: Display alarm recordings on the single screen sequentially.

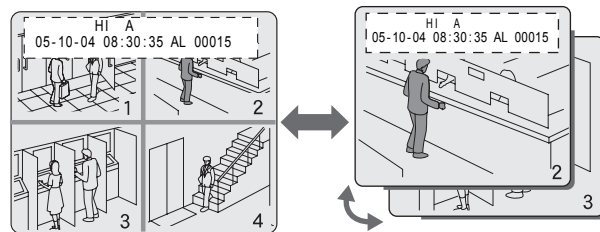

- “MASK SET” is used to hide the monitor display of some channel images in the normal screen and playback screen.

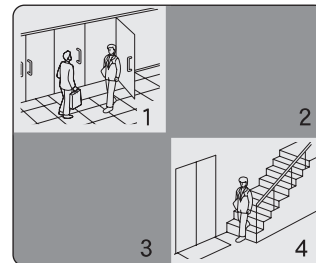

##### TITLE SET

- Lets you set titles for the cameras.

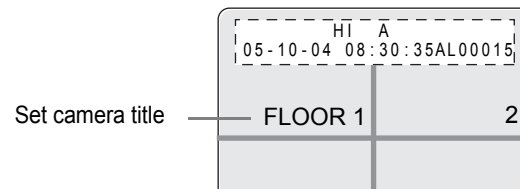

## SCREEN SET MENU

### MOTION SENSOR SET

- If the motion sensor is set on the monitor, alarm recording is enabled when a moving subject is detected.

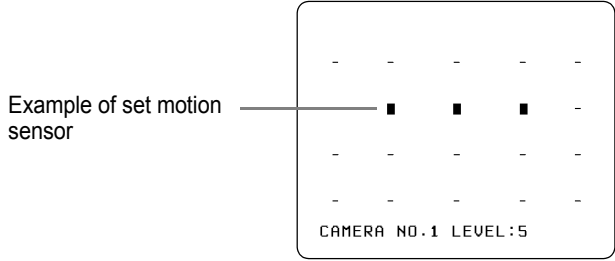

**4** Press the [∨] or [∧] buttons to select the desired item, then press the [>] button.

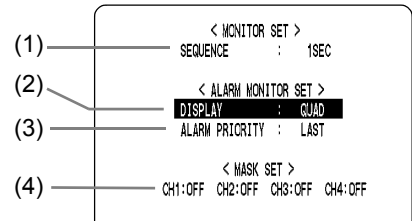

Settings (◆ indicates default setting.)

| Item                      | Setting                                   | Description                                                                                         |
|---------------------------|-------------------------------------------|-----------------------------------------------------------------------------------------------------|
| (1) SEQUENCE              | 1 to 30 seconds (1 second units)<br>◆1SEC | Sets time interval used for switching screens when displaying image from each channel sequentially. |
| (2) DISPLAY               | FULL                                      | When alarm occurs, displays image from channel that generated alarm in single screen.               |
|                           | ◆QUAD                                     | When alarm occurs, displays images in quad screen.                                                  |
| (3) ALARM PRIORITY        | ◆LAST                                     | Displays alarm images in order starting with the most recent when multiple alarms are generated.    |
|                           | FIRST                                     | Displays the first alarm image only when multiple alarms are generated.                             |
|                           | SWITCH                                    | Cycles through alarm images in one second intervals when multiple alarms are generated.             |
| (4) MASK SET<br>CH1/2/3/4 | ON                                        | Masks image and sound of set channel.                                                               |
|                           | ◆OFF                                      | Plays image and sound.                                                                              |

### MONITOR SET

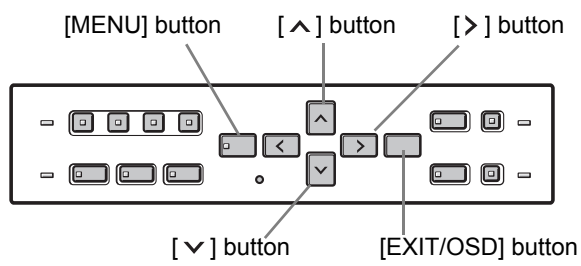

SETTINGS

**1** Press the [MENU] button.  
The [MENU] button lights, and the <MAIN MENU> screen is displayed.

**2** Select "2. SCREEN SET MENU", and press the [>] button.  
The <SCREEN SET MENU> screen is displayed.

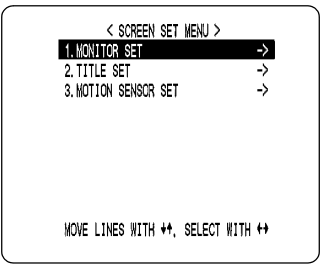

**3** Select "1. MONITOR SET", and press the [>] button.  
The <MONITOR SET> screen is displayed.

**NOTE** "ALARM PRIORITY" settings are active only when the "DISPLAY" setting is "FULL."

**5** Press the [∨] or [∧] buttons to change the setting, then press the [>] button.

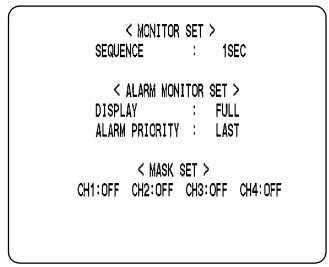

**6** Repeat steps 4 to 5 to set other items as needed.

**7** When you have finished making the settings, press the [EXIT/OSD] button.  
The display returns to the normal screen.



### Naming the cameras

Camera titles can be up to 10 characters long. You can enter the following characters and symbols: 0 to 9, A to Z, - (hyphen), : (colon), . (period), / (slash), \* (asterisk), \_ (underbar), (space)

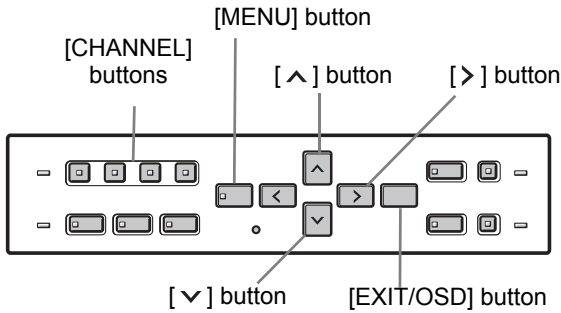

#### 1 Press the [MENU] button.

The [MENU] button lights, and the <MAIN MENU> screen is displayed.

#### 2 Select "2. SCREEN SET MENU", and press the [>] button.

The <SCREEN SET MENU> screen is displayed.

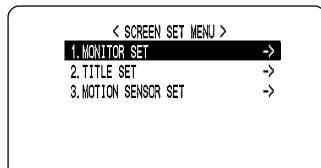

#### 3 Select "2. TITLE SET", and press the [>] button.

The <CAMERA NO.1> screen is displayed.

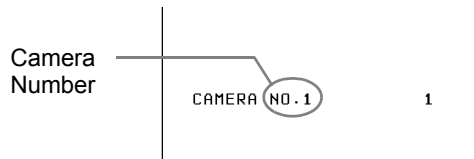

The default values are shown below.

| CAMERA Number | Default value |
|---------------|---------------|
| CAMERA NO.1   | 1             |
| CAMERA NO.2   | 2             |
| CAMERA NO.3   | 3             |
| CAMERA NO.4   | 4             |

#### 4 Press the desired [CHANNEL] button to select the desired camera number.

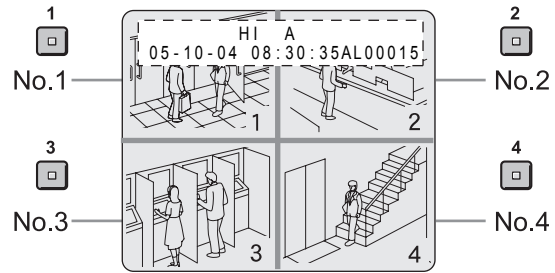

#### 5 Press the [>] button to enter text.



#### 6 Press the [v] or [^] button to start entering the camera title.

You can enter up to 10 characters/symbols. Each time you press the [^] or [v] button, the display toggles as follows:

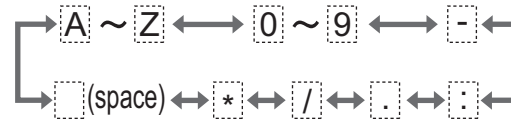

Input example: "FLOOR 1"



#### 7 Press the [>] button.

The character is entered, and the cursor moves to the right.



#### 8 Repeat steps 6 to 7 to enter additional characters.



(continued)

SETTINGS

**SCREEN SET MENU**

**9** When you have finished making the settings, press the [EXIT/OSD] button.

The display returns to the normal screen.  
The screen displays the set camera title.

Set camera title — FLOOR 1 2

**Setting the motion sensor**

By setting the motion sensor on the screen, any movement by the subject will automatically activate alarm recording. You can set the following items:

- Motion detection position on screen
- Number of camera for which to set motion sensor
- Motion sensor sensitivity (Default setting is OFF.)

SETTINGS

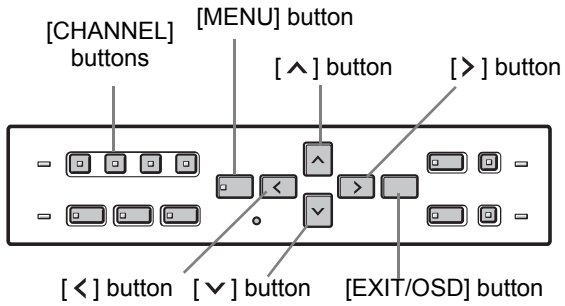

**1** Press the [MENU] button.

The [MENU] button lights, and the <MAIN MENU> screen is displayed.

**2** Select “2. SCREEN SET MENU”, and press the [ > ] button.

The <SCREEN SET MENU> screen is displayed.

< SCREEN SET MENU >  
1. MONITOR SET ->  
2. TITLE SET ->  
3. MOTION SENSOR SET ->

**3** Select “3. MOTION SENSOR SET”, and press the [ > ] button.

The motion sensor setting screen for CAMERA NO. 1 appears.

Displays current camera number

**4** Press the desired [CHANNEL] button to select the desired camera number.

**5** Press the [ > ] or [ < ] button to select “LEVEL,” then press the [ v ] or [ ^ ] button to set the sensitivity.

The level can be set to a value between 1 and 10. The lower the value, the higher the sensitivity. (Default setting: OFF)

**NOTE** A confirmation tone sounds when making sensor settings.

**6 Press the [ > ] or [ < ] button to select a sensor operation position, then press the [ v ] or [ ^ ] button to set the selection (you can set up to 20 positions).**

You can set sensor operation positions at any screen position.

- Moving the cursor

Each time you press the [ > ] button, the cursor moves from left to right in the top row. After the cursor has reached the end of the row, it moves from left to right in the row below.

You can press the [ < ] button to move the cursor in the opposite direction.

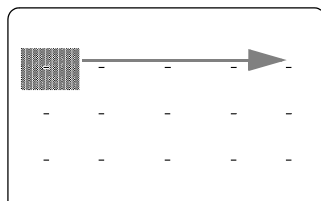

Holding down the [ > ] or [ < ] button moves the cursor as follows:

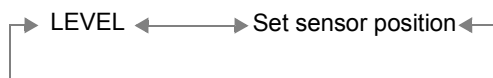

- Setting sensor operation positions

Pressing the [ v ] or [ ^ ] button once enables the currently selected position (displays ■). Pressing the [ v ] or [ ^ ] button again disables the setting (displays -).

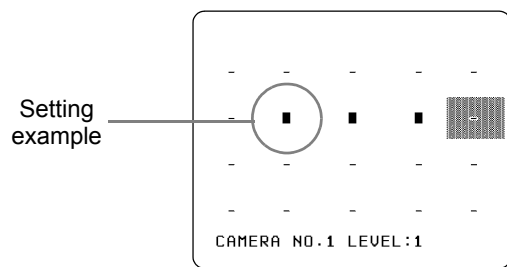

**NOTE**

**Operation position setting example**  
If you set an area near the center of the screen, the sensor operates and recording starts when a moving subject near the center of the screen is detected.

**7 When you have finished making the settings, press the [EXIT/OSD] button.**

The display returns to the normal screen.

**! CAUTION**

To activate alarm recording when the motion sensor detects movement, display the <RECORDER MENU>, and set the "ALARM TRIGGER" in "ALARM REC MODE SET" to a setting other than "ALARM." (→P.46)

## 4. RECORDER MENU

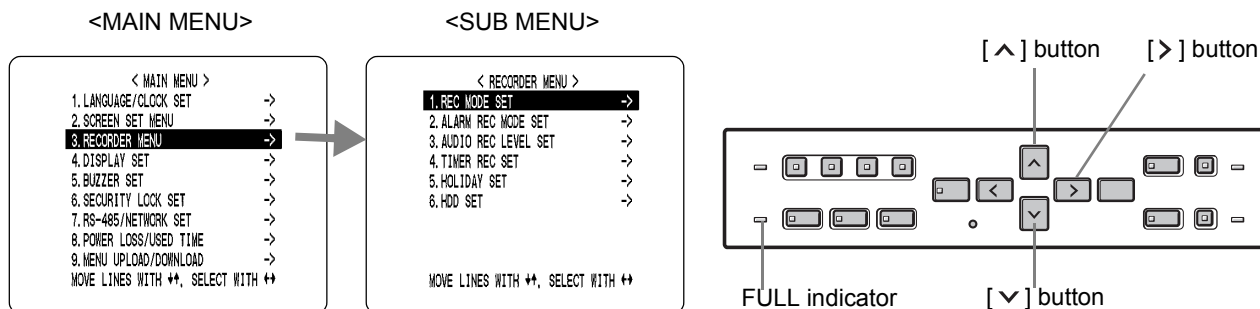

### Recording settings

The <RECORDER MENU> screen lets you make the following recording-related settings:

| Item                  | Description                                                                                                                                                                                                                                                                                       |
|-----------------------|---------------------------------------------------------------------------------------------------------------------------------------------------------------------------------------------------------------------------------------------------------------------------------------------------|
| 1 REC MODE SET        | <ul style="list-style-type: none"> <li>Changes the recording image quality.</li> <li>Turns audio recording ON/OFF.</li> <li>Sets whether to stop recording or to record over previously recorded videos, when the hard disk becomes full.</li> <li>Sets the series recording settings.</li> </ul> |
| 2 ALARM REC MODE SET  | <ul style="list-style-type: none"> <li>Turns alarm recording ON/OFF.</li> <li>Sets the amount of time to record for when an alarm is generated.</li> <li>Sets alarm trigger.</li> <li>Sets the operation to perform when the camera image is interrupted.</li> </ul>                              |
| 3 AUDIO REC LEVEL SET | Sets audio level for each channel.                                                                                                                                                                                                                                                                |
| 4 TIMER REC SET       | Sets timer recording.                                                                                                                                                                                                                                                                             |
| 5 HOLIDAY SET         | Lets you set specific days other than Sundays as holidays.                                                                                                                                                                                                                                        |
| 6 HDD SET             | Initializes the hard disk, or sets the mirroring settings when an additional hard disk is installed.                                                                                                                                                                                              |

### To record in series when multiple digital video recorders are connected

When multiple digital video recorders are connected, you can automatically continue recording to the second and subsequent digital video recorders when the first hard disk becomes full.

Display the <REC MODE SET> screen, and set "OVER WRITE" to "OFF", and "SERIES REC" to "-1M", "-2M", or "-3M". (→P.44)

### Basic recording settings

#### 1 Press the [MENU] button.

The [MENU] button lights, and the <MAIN MENU> screen is displayed.

#### 2 Select "3. RECORDER MENU", and press the [ > ] button.

The <RECORDER MENU> screen is displayed.

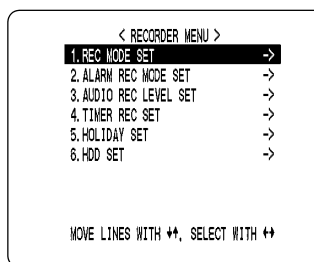

#### 3 Press the [ > ] button.

THE <REC MODE SET> screen is displayed.

#### 4 Press the [ v ] or [ ^ ] buttons to select the desired item, then press the [ > ] button.

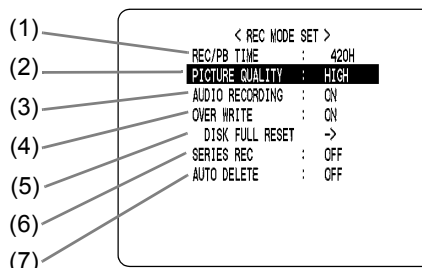

#### NOTE

"REC/PB TIME" changes automatically according to the "PICTURE QUALITY" set.

**Settings** (◆ indicates default setting.)

|     | Item            | Setting        | Description                                                                                                                                                                |
|-----|-----------------|----------------|----------------------------------------------------------------------------------------------------------------------------------------------------------------------------|
| (1) | REC/PB TIME     | -              | Displays the possible recording time.                                                                                                                                      |
| (2) | PICTURE QUALITY | SUPER+ (SU+)   | Highest image quality. Recording time: At least 56 hours (120 GB), or at least 112 hours (240 GB)                                                                          |
|     |                 | SUPER (SUP)    | Super high image quality. Recording time: At least 84 hours (120 GB), or at least 168 hours (240 GB)                                                                       |
|     |                 | ◆ HIGH (HI)    | High image quality. Recording time: At least 168 hours (120 GB), or at least 336 hours (240 GB)                                                                            |
|     |                 | STANDARD (STD) | Standard image quality. Recording time: At least 336 hours (120 GB), or at least 672 hours (240 GB)                                                                        |
| (3) | AUDIO RECORDING | ◆ ON           | Performs audio recording.                                                                                                                                                  |
|     |                 | OFF            | Does not perform audio recording.                                                                                                                                          |
| (4) | OVER WRITE      | ◆ ON           | When the hard disk runs out of space, recording automatically starts again from the beginning, recording over previously recorded videos.                                  |
|     |                 | OFF            | When the hard disk runs out of space, the FULL indicator lights and recording stops.                                                                                       |
| (5) | DISK FULL RESET | ◆ NO           | Does not overwrite. The <WARNING> screen is displayed, and "NO" flashes.                                                                                                   |
|     |                 | YES            | Videos can be recorded over previously recorded videos once. The <WARNING> screen is displayed. Press the [▼] or [▲] button to select "YES".                               |
| (6) | SERIES REC      | ◆ OFF          | Does not perform series recording.                                                                                                                                         |
|     |                 | -1M            | When multiple digital video recorders are connected, about 1 minute before the first recorder's hard disk becomes full, the second recorder's hard disk starts recording.  |
|     |                 | -2M            | When multiple digital video recorders are connected, about 2 minutes before the first recorder's hard disk becomes full, the second recorder's hard disk starts recording. |
|     |                 | -3M            | When multiple digital video recorders are connected, about 3 minutes before the first recorder's hard disk becomes full, the second recorder's hard disk starts recording. |
| (7) | AUTO DELETE     | ◆ OFF          | Does not automatically delete data.                                                                                                                                        |
|     |                 | 1-99 DAYS      | Automatically deletes data after the specified number of days has passed.                                                                                                  |

\* If the hard disk becomes full when item (4) OVER WRITE is set to "OFF", the operation performed is determined by the setting of item (5) DISK FULL RESET. For how to set this item, see "Resetting when the FULL indicator lights" on the right.

\* (6) SERIES REC can be set when the OVER WRITE is set to "OFF".

**5** Press the [▼] or [▲] button to change the setting, then press the [>] button.

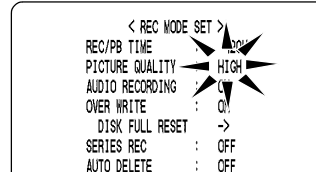

**6** Repeat steps 4 to 5 to set other items as needed.

**7** When you have finished making the settings, press the [EXIT/OSD] button.

The display returns to the normal screen.

**To reset the DNR when the FULL indicator lights**

When "OVER WRITE" is set to "OFF" and the hard disk becomes full, the FULL indicator lights and recording stops. To start recording again, follow the steps below to overwrite recorded videos.

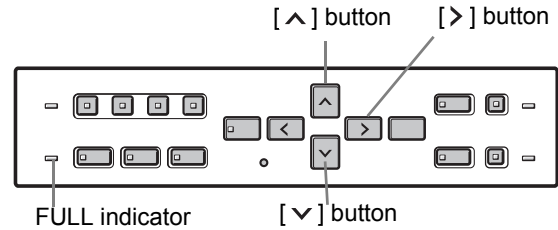

**1** Press the [MENU] button.

The [MENU] button lights, and the <MAIN MENU> screen is displayed.

**2** Select "3. RECORDER MENU", and press the [>] button.

The <RECORDER MENU> screen is displayed.

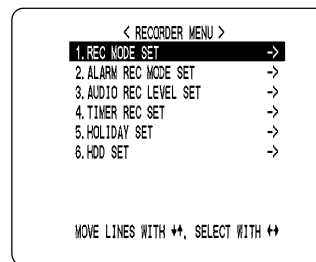

(continued)

## RECORDER MENU

### 3 Press the [ > ] button.

THE <REC MODE SET> screen is displayed.

### 4 Press the [ ∨ ] or [ ∧ ] button to select "DISK FULL RESET", then press the [ > ] button.

The <WARNING> screen is displayed, with "NO" flashing.

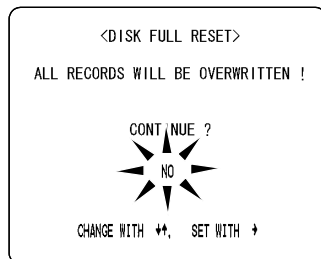

### 5 Press the [ ∨ ] or [ ∧ ] button to select "YES", then press the [ > ] button.

The normal screen is displayed, and the FULL indicator turns off. The DVR is ready to record again.

#### **!** CAUTION

DISK FULL RESET is only available when "OVER WRITE" is set to "OFF", and the hard disk is full.

SETTINGS

### Alarm recording settings

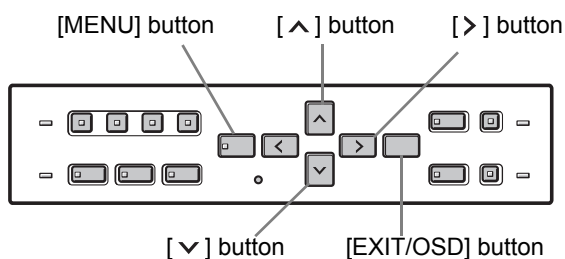

#### 1 Press the [MENU] button.

The [MENU] button lights, and the <MAIN MENU> screen is displayed.

#### 2 Select "3. RECORDER MENU", and press the [ > ] button.

The <RECORDER MENU> screen is displayed.

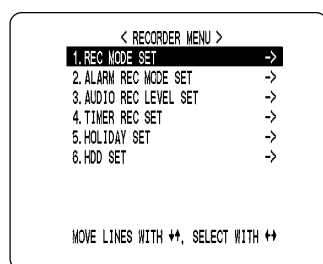

#### 3 Press the [ ^ ] or [ v ] button to select "2. ALARM REC MODE SET", then press the [ > ] button.

The <ALARM REC MODE SET> screen is displayed.

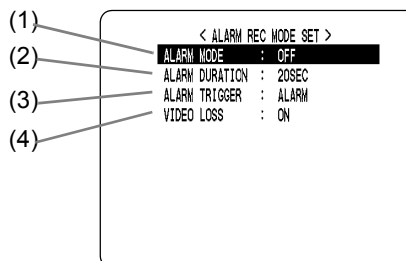

(continued)

#### Settings (◆ indicates default setting.)

|     | Item           | Setting                                                                                                                                                        | Description                                                                                                                                                          |
|-----|----------------|----------------------------------------------------------------------------------------------------------------------------------------------------------------|----------------------------------------------------------------------------------------------------------------------------------------------------------------------|
| (1) | ALARM MODE     | ◆ OFF                                                                                                                                                          | Does not perform alarm recording.                                                                                                                                    |
|     |                | ENABLED                                                                                                                                                        | Always performs alarm recording, whether or not timer recording is being performed.                                                                                  |
|     |                | AL-REC ON TIMER                                                                                                                                                | Performs alarm recording only during timer recording.                                                                                                                |
|     |                | AL-REC OFF TIMER                                                                                                                                               | Performs alarm recording only when timer recording is not being performed.                                                                                           |
|     |                | ONLY AL-RC ON TMR                                                                                                                                              | Performs alarm recording only for the amount of time set by the timer. Does not return to timer recording standby.                                                   |
| (2) | ALARM DURATION | Time selections*: CC/5SEC/10SEC/20SEC(◆)/40SEC/1MIN/2MIN/3MIN/4MIN/5MIN/10MIN/15MIN<br>Sets the amount of time for recording when a single alarm is generated. |                                                                                                                                                                      |
| (3) | ALARM TRIGGER  | Selects how to detect intruders.                                                                                                                               |                                                                                                                                                                      |
|     |                | ◆ ALARM                                                                                                                                                        | Performs alarm recording when an external alarm is generated (when a switch is attached to the alarm input terminal on the rear panel, and the switch is activated). |
|     |                | SENSOR                                                                                                                                                         | Performs alarm recording when the motion sensor detects movement. See the information on setting the motion sensor. (→P.41)                                          |
|     |                | ALARM OR SENSOR                                                                                                                                                | Performs alarm recording when either the external alarm or motion sensor is activated.                                                                               |
| (4) | VIDEO LOSS     | ◆ ON                                                                                                                                                           | Displays "VIDEO LOSS" on the screen when the camera image is interrupted. Also outputs the WARNING signal to a rear panel terminal.                                  |
|     |                | OFF                                                                                                                                                            | Doesn't display "VIDEO LOSS" on the screen when the camera image is interrupted.                                                                                     |

\* CC: Operates while alarm is active. (Operates for more than 5 seconds per alarm.)

## RECORDER MENU

**4** Press the [∨] or [^] button to select the desired item, then press the [>] button.

The setting flashes.

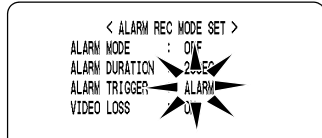

**5** Press the [∨] or [^] button to change the setting, then press the [>] button.

**6** Repeat steps 4 to 5 to set other items as needed.

**7** When you have finished making the settings, press the [EXIT/OSD] button.

The display returns to the normal screen.

**4** Select the channel and change the audio level.

Each time you press the [>] button, the display switches between possible channels. The audio level marks on the screen flash for the selected channel.

To increase level: Use the [^] button.

To decrease level: Use the [∨] button.

**NOTE**

Many audio level marks (◀) indicate high sensitivity.

**5** When you have finished making the settings, press the [EXIT/OSD] button.

The display returns to the normal screen.

SETTINGS

### Setting the audio level

**1** Press the [MENU] button.

The [MENU] button lights, and the <MAIN MENU> screen is displayed.

**2** Select “3. RECORDER MENU”, and press the [>] button.

The <RECORDER MENU> screen is displayed.

**3** Press the [∨] or [^] button to select “3. AUDIO REC LEVEL SET”, then press the [>] button.

The <AUDIO REC LEVEL SET> screen is displayed.

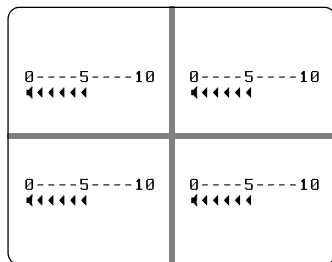

### Setting the day and time for timer recording

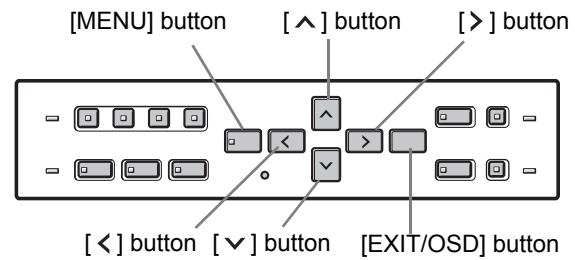

### Timer setting items

You can use the timer functions to set recording start/stop times.

|     | (1)  | (2)   | (3)   | (4) |
|-----|------|-------|-------|-----|
|     | WEEK | START | STOP  | SET |
|     | SUN  | --:-- | --:-- | OFF |
|     | MON  | --:-- | --:-- | OFF |
|     | TUE  | --:-- | --:-- | OFF |
|     | WED  | --:-- | --:-- | OFF |
|     | THU  | --:-- | --:-- | OFF |
|     | FRI  | --:-- | --:-- | OFF |
| (5) | SAT  | --:-- | --:-- | OFF |
|     | DLY  | --:-- | --:-- | OFF |

You can set times at which to start and stop recording on each specified day of the week.

(1) WEEK:

Used to select the days of the week for timer recording. The day in the “WEEK” column can be changed to other days. Use line 7 (SAT) and 8 (DLY) when setting timer recordings that span more than 24 hours.

(2) START:

Enter the time at which to start timer recording.



- (3) STOP:  
Enter the time at which to stop timer recording.
- (4) SET:  
Setting "ON" enables the entered timer recording setting.  
Setting "OFF" disables the entered timer recording setting.
- (5) SAT, DLY:  
Use these lines for timer recording spanning more than 24 hours.

**Recording every day, at the same time, with the same image quality**

**Example:**  
Setting a timer recording for every day from 8:30 to 18:30 with the same image quality.

- 1 Press the [MENU] button.**  
The [MENU] button lights, and the <MAIN MENU> screen is displayed.
- 2 Select "3. RECORDER MENU", and press the [ > ] button.**  
The <RECORDER MENU> screen is displayed.
- 3 Select "4. TIMER REC SET" and press the [ > ] button.**  
The <TIMER REC SET> screen is displayed.
 

| WEEK | START | STOP  | SET |
|------|-------|-------|-----|
| SUN  | --:-- | --:-- | OFF |
| MON  | --:-- | --:-- | OFF |
| TUE  | --:-- | --:-- | OFF |
| WED  | --:-- | --:-- | OFF |
| THU  | --:-- | --:-- | OFF |
| FRI  | --:-- | --:-- | OFF |
| SAT  | --:-- | --:-- | OFF |
| DLY  | --:-- | --:-- | OFF |
- 4 Press the [ > ] button once.**  
"SUN" under "WEEK" flashes.

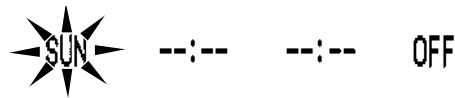

- 5 Press the [∨] or [∧] button to change "SUN" to "DLY".**



- 6 Press the [ > ] button to move the cursor to the next item.**

Each time you press the [ > ] button, the cursor moves to the following items:  
Day → "START" time (hours, minutes) → "STOP" time (hours, minutes) → "ON"/"OFF"

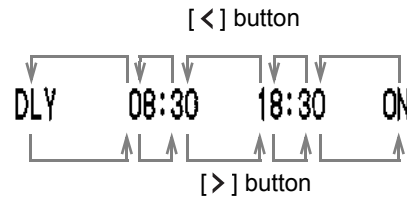

- **To change a setting**  
Press the [ < ] or [ > ] button to move the flashing area to the item you want to change, then press the [ ∨ ] or [ ∧ ] button to change the setting.
- **Timer recording image quality**  
The image quality is determined by the "PICTURE QUALITY" setting in the <REC MODE SET> screen. (→P.44)
- 7 When you have finished making the settings, press the [EXIT/OSD] button.**  
The display returns to the normal screen.
- **To set different recording times for each day of the week**  
Set the desired recording times for each day.
- **If timer setting days overlap**  
The timer setting that starts first will have priority.

SETTINGS

## RECORDER MENU

### To cancel all timer recording settings

**1 Press the [MENU] button.**

The [MENU] button lights, and the <MAIN MENU> screen is displayed.

**2 Select “3. RECORDER MENU”, and press the [ > ] button.**

The <RECORDER MENU> screen is displayed.

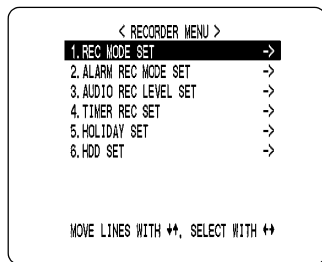

**3 Select “4. TIMER REC SET”, and press the [ > ] button.**

The <TIMER REC SET> screen is displayed.

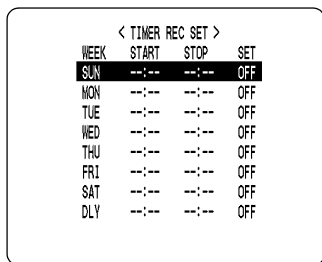

**4 With the <TIMER REC SET> screen displayed, press the [MENU RESET] button.**

All the timer settings are erased.

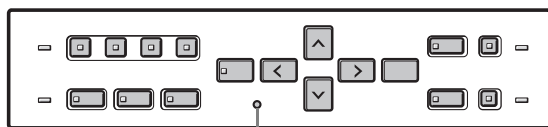

[MENU RESET] button

### To set timer recordings spanning more than 24 hours

Follow the steps below to set timer recordings spanning more than 24 hours. These settings are made using lines 7 (initially “SAT”) and 8 (initially “DLY”) of the <TIMER REC SET> screen.

**Example:**

Setting a timer recording from 10:30 Monday to 20:30 Wednesday.

**1 Press the [MENU] button.**

The [MENU] button lights, and the <MAIN MENU> screen is displayed.

**2 Select “3. RECORDER MENU”, and press the [ > ] button.**

The <RECORDER MENU> screen is displayed.

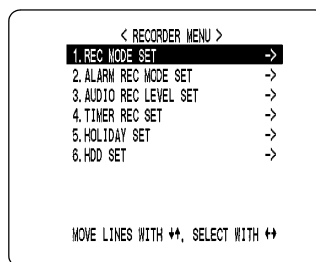

**3 Select “4. TIMER REC SET” and press the [ > ] button.**

The <TIMER REC SET> screen is displayed.

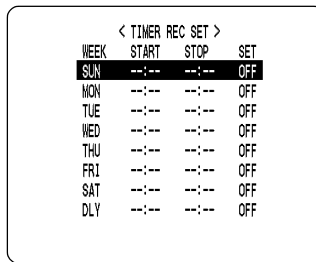

**4 Press the [∨] or [∧] button to move the cursor to the line 7 (SAT), then press the [ > ] button.**

“SAT” in the “WEEK” column flashes.

You can change the setting of the flashing item.

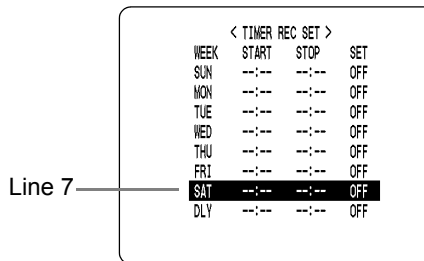

Line 7

SETTINGS

**5 Set the items in the “WEEK” and “START” columns.**

- (1) Press the [∇] or [∧] button to change “SAT” to “MON”, then press the [➤] button.

MON  --:-- OFF

- (2) Press the [∇] or [∧] button to change “--” to “10”, then press the [➤] button.

MON 10:  --:-- OFF

- (3) Press the [∇] or [∧] button to change “--” to “30”, then press the [➤] button.

MON 10:30  OFF

**6 Press the [∇] or [∧] button to change the “STOP” time from “--:--” to “\*\*:\*”, then press the [➤] button.**

The “DLY” item on line 8 automatically changes to “TUE” (the next day), and flashes. Items that do not need to be set are displayed as asterisks (\*).

MON 10:30 \*\*:\*\* \*\*\*  
 \*TUE \*\*:\* --:-- OFF

**7 Set the end “WEEK” and “STOP” time. Switch “SET” to “ON”.**

MON 10:30 \*\*:\*\* \*\*\*  
 TUE \*\*:\* 20:30 ON

(1) (2) (3) (4)

- (1) Press the [∇] or [∧] button to change “TUE” to “WED”, then press the [➤] button.  
 (2) Press the [∇] or [∧] button to change “--” to “20”, then press the [➤] button.  
 (3) Press the [∇] or [∧] button to change “--” to “30”, then press the [➤] button.  
 (4) Press the [∇] or [∧] button to change “OFF” to “ON”.

**8 Press the [EXIT/OSD] button.**

The display returns to the normal screen.

**Setting holidays**

You can set specific dates as holidays, to have the timer recording operation for Sunday used on those days. Dates such as national holidays and company off days should be set as holidays when you want those dates to have the same security as Sundays.

**! CAUTION**

After completing timer settings for Sunday (SUN), make sure to switch “SET” in the <TIMER REC SET> menu to “ON”. (→P.47)

**NOTE**

You can set up to 20 days as holidays.

**Example: Setting November 17 as a holiday**

**1 Press the [MENU] button.**

The [MENU] button lights, and the <MAIN MENU> screen is displayed.

**2 Select “3. RECORDER MENU”, and press the [➤] button.**

The <RECORDER MENU> screen is displayed.

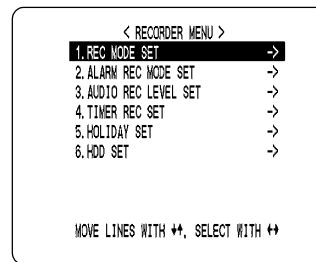

**3 Select “5. HOLIDAY SET”, and press the [➤] button.**

The <HOLIDAY SET> screen is displayed.

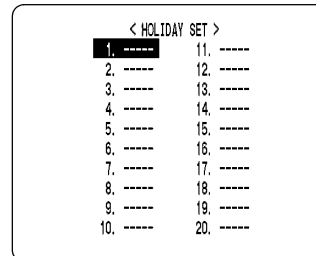

(continued)

SETTINGS

## RECORDER MENU

### 4 Set the month and day for item No. 1.

- (1) Press the [ > ] button to make "--" (the month) flash.
- (2) Press the [ √ ] or [ ^ ] button to set "--" to "11".
- (3) Press the [ > ] button to make "--" (the day) flash.
- (4) Press the [ √ ] or [ ^ ] button to set "--" to "17".

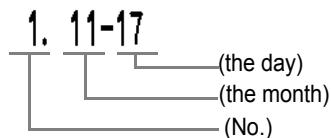

### 5 After entering the setting, press the [ > ] button.

The cursor moves to "2".

### 6 Press the [EXIT/OSD] button.

The display returns to the normal screen.

## Initializing the hard disk/adding a hard disk

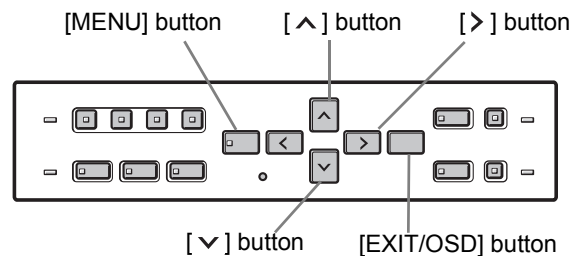

### To initialize the hard disk

#### 1 Press the [MENU] button.

The [MENU] button lights, and the <MAIN MENU> screen is displayed.

#### 2 Select "3. RECORDER MENU", and press the [ > ] button.

The <RECORDER MENU> screen is displayed.

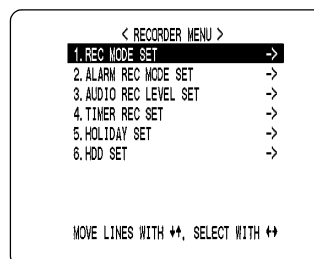

#### 3 Press the [ √ ] or [ ^ ] button to select "6. HDD SET", then press the [ > ] button.

The <HDD SET> screen is displayed.

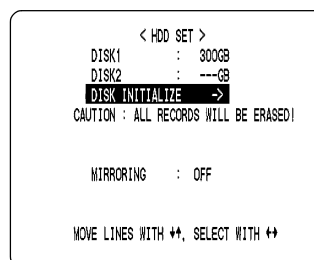

**4 Press the [ > ] button.**

The <WARNING> screen is displayed, with "NO" flashing.



- Playback disk  
When mirroring is set, the digital video recorder automatically sets which of the two hard disks to read the recorded image from.

**5 Press the [ v ] or [ ^ ] button to select "YES", then press the [ > ] button.**

The "HDD INITIALIZING!" screen is displayed, and the hard disk is initialized.

When the process has finished, the display returns to the MENU screen.

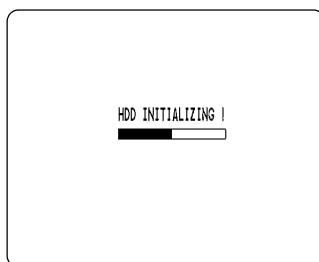
**6 Press the [EXIT/OSD] button.**

The display returns to the normal screen.

**To add a hard disk**

To add a hard disk, contact a Sanyo service center. When adding a hard disk, use an add-on type hard disk unit (sold separately).

**[Setting conditions]**

After adding a hard disk, a message appears at the next startup, confirming whether you want to initialize the newly installed hard disk. Select "Yes" to initialize the hard disk. If you select "No", the hard disk cannot be used.

**NOTE****Hard disk setting screen**

- MIRRORING  
After adding a hard disk, you can record the same images on both hard disks by setting "MIRRORING" to "ON". If an image write error occurs on one disk, you will still be able to read the image from the other disk.

## 5. DISPLAY SET

### <MAIN MENU>

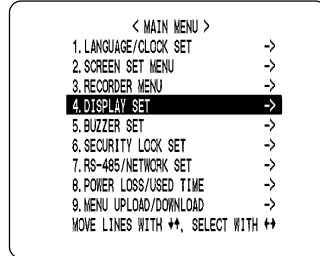

The <DISPLAY SET> screen lets you turn off the display of the date, time or other information in the operation display area of the playback screen. Use this screen to make settings as needed.

### Settings

SETTINGS

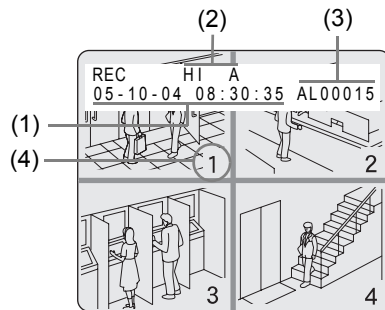
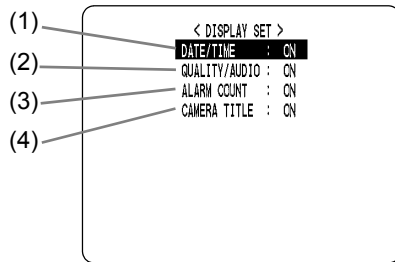

Settings (◆ indicates default setting.)

|     | Item          | Setting | Description                                                                               |
|-----|---------------|---------|-------------------------------------------------------------------------------------------|
| (1) | DATE/TIME     | ◆ ON    | Turns on display of date and time in operation display area.                              |
|     |               | OFF     | Turns off display of date/time in operation display area.                                 |
| (2) | QUALITY/AUDIO | ◆ ON    | Turns on display of image quality and "A" for audio recording in operation display area.  |
|     |               | OFF     | Turns off display of image quality and "A" for audio recording in operation display area. |
| (3) | ALARM COUNT   | ◆ ON    | Turns on display of current alarm count in operation display area.                        |
|     |               | OFF     | Turns off display of current alarm count in operation display area.                       |
| (4) | CAMERA TITLE  | ◆ ON    | Turns on display of camera title on the screen.                                           |
|     |               | OFF     | Turns off display of camera title on the screen.                                          |

### Customizing the operation display area

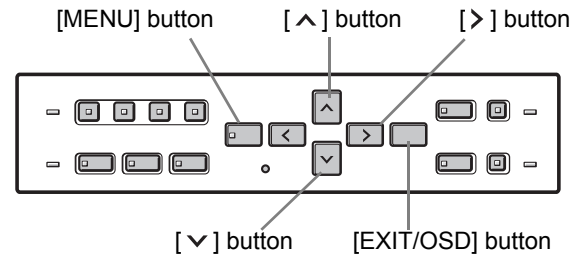

#### 1 Press the [MENU] button.

The [MENU] button lights, and the <MAIN MENU> screen is displayed.

#### 2 Select "4. DISPLAY SET", and press the [ > ] button.

The <DISPLAY SET> screen is displayed.

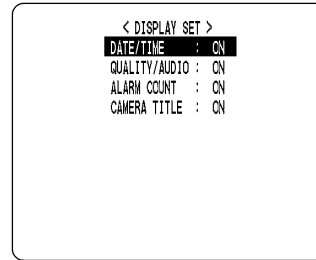

#### 3 Press the [v] or [^] buttons to select the desired item, then press the [ > ] button.

The setting flashes.

#### 4 Press the [v] or [^] buttons to change the setting, then press the [ > ] button.

#### 5 Repeat steps 3 to 4 to set other items as needed.

#### 6 When you have finished making the settings, press the [EXIT/OSD] button.

The display returns to the normal screen.

## 6. BUZZER SET

### <MAIN MENU>

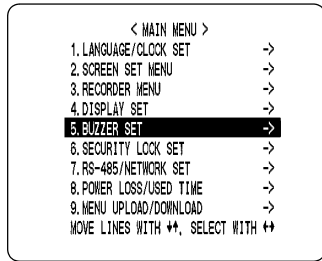

The <BUZZER SET> screen lets you set a warning buzzer to sound when events occur such as alarms being generated or the remaining hard disk space reaching zero. Use this screen to make settings as needed.

### Settings

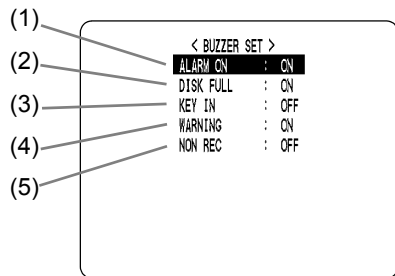

Settings (◆ indicates default setting.)

|     | Item      | Setting | Description                                                                                           |
|-----|-----------|---------|-------------------------------------------------------------------------------------------------------|
| (1) | ALARM ON  | ◆ ON    | Sounds buzzer when alarm is generated.                                                                |
|     |           | OFF     | Does not sound buzzer when alarm is generated.                                                        |
| (2) | DISK FULL | ◆ ON    | When "OVER WRITE" is not set, sounds buzzer when remaining hard disk space reaches zero.              |
|     |           | OFF     | When "OVER WRITE" is not set, does not sound buzzer when remaining hard disk space reaches zero.      |
| (3) | KEY IN    | ON      | Sounds buzzer when operation button is pressed.                                                       |
|     |           | ◆ OFF   | Does not sound buzzer when operation button is pressed.                                               |
| (4) | WARNING   | ◆ ON    | Sounds buzzer in following cases:<br>● Hard disk drive error<br>● Fan error ● Recording error         |
|     |           | OFF     | Does not sound buzzer in following cases:<br>● Hard disk drive error<br>● Fan error ● Recording error |
| (5) | NON REC   | ON      | Sounds buzzer when recording is stopped.                                                              |
|     |           | ◆ OFF   | Does not sound buzzer when recording is stopped.                                                      |

#### NOTE

Press any button to stop the BUZZER sounding.

### Setting the buzzer for each condition

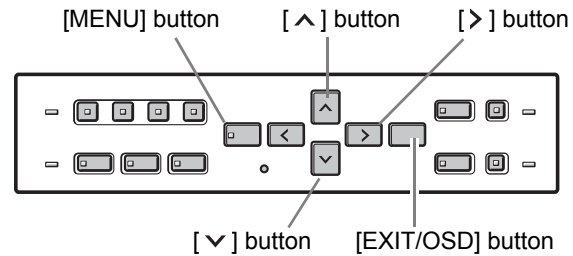

#### 1 Press the [MENU] button.

The [MENU] button lights, and the <MAIN MENU> screen is displayed.

#### 2 Select "5. BUZZER SET", and press the [ > ] button.

The <BUZZER SET> screen is displayed.

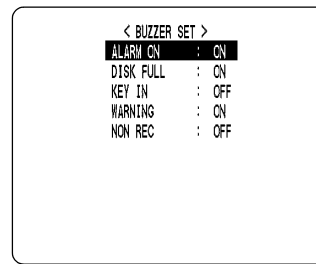

#### 3 Press the [v] or [^] buttons to select the desired item, then press the [ > ] button.

The setting flashes.

#### 4 Press the [v] or [^] buttons to change the setting, then press the [ > ] button.

#### 5 Repeat steps 3 to 4 to set other items as needed.

#### 6 When you have finished making the settings, press the [EXIT/OSD] button.

The display returns to the normal screen.

## 7. SECURITY LOCK SET

### <MAIN MENU>

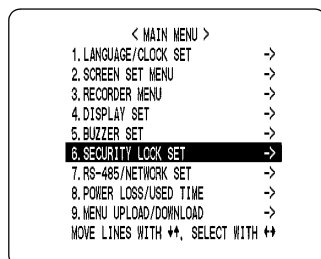

You can set passwords that restrict use of the digital video recorder to administrators and designated users, preventing unauthorized operation. When the security lock is set, a buzzer sounds when an unauthorized user presses any of the digital video recorder's operation buttons. Be sure to make a note of the set passwords.

### Password setting example

Two password types can be set, one for administrators and one for users. The table below gives example password setting combinations, and lists how the digital video recorder operates for each.

| Setting example                                                                         | Operation                                                                                                                                                                                   |
|-----------------------------------------------------------------------------------------|---------------------------------------------------------------------------------------------------------------------------------------------------------------------------------------------|
| LEVELPASSWORD (4-8) USE<br>ADMIN 123456AB ON<br>USER AB123456 ON<br>REC CONTROL : ADMIN | All operations are locked until you enter a password.<br>Enter the user password to enable playback operations.<br>Enter the administrator password to enable all operations.               |
| ADMIN 123456AB ON<br>USER AB123456 ON<br>REC CONTROL : USER                             | All operations are locked until you enter a password.<br>Enter the user password to enable playback and recording operations.<br>Enter the administrator password to enable all operations. |
| ADMIN 123456AB ON<br>USER ----- OFF<br>REC CONTROL : ADMIN                              | Only playback operations enabled unless password is entered.<br>Enter the administrator password to enable all operations.                                                                  |
| ADMIN 123456AB ON<br>USER ----- OFF<br>REC CONTROL : USER                               | Only playback and recording operations enabled unless password is entered.<br>Enter the administrator password to enable all operations.                                                    |
| ADMIN ----- OFF<br>USER ----- OFF<br>REC CONTROL : ADMIN                                | All operations enabled. Also functions as key lock. (→P.26)                                                                                                                                 |
| ADMIN ----- OFF<br>USER ----- OFF<br>REC CONTROL : USER                                 | All operations enabled. Also functions as key lock. (→P.26)                                                                                                                                 |

### Settings

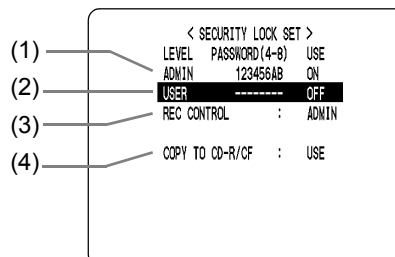

Settings (◆ indicates default setting.)

|     | Item            | Setting | Description                                                             |
|-----|-----------------|---------|-------------------------------------------------------------------------|
| (1) | ADMIN           | ON      | Used to set password for administrators. Also enables password setting. |
|     |                 | ◆ OFF   | Disables password setting.                                              |
| (2) | USER            | ON      | Used to set password for users. Also enables password setting.          |
|     |                 | ◆ OFF   | Disables password setting.                                              |
| (3) | REC CONTROL     | ◆ ADMIN | Sets authorization for recording operation to "ADMIN" (administrators). |
|     |                 | USER    | Sets authorization for recording operation to "USER" (users).           |
| (4) | COPY TO CD-R/CF | ◆ USE   | Enable the CD-R/RW and CF copy function.                                |
|     |                 | NO USE  | Disable the CD-R/RW and CF copy function.                               |

### Setting the administrator password

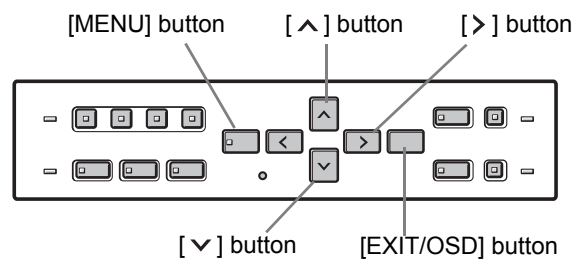

Passwords can be between 4 and 8 alphanumeric characters.  
Characters that can be entered in passwords: 0 to 9, A to Z

#### Example: Setting "123456AB" as a password

#### 1 Press the [MENU] button.

The [MENU] button lights, and the <MAIN MENU> screen is displayed.



## 2 Select "6. SECURITY LOCK SET", and press the [ > ] button.

The <SECURITY LOCK SET> screen is displayed.

### NOTE

"LEVEL PASSWORD (4-8) USE" at the top of the screen is the screen title. You cannot move the cursor to this item.

## 3 Press the [ > ] button.

The first password entry bar "-" flashes.

ADMIN  OFF

## 4 Press the [ v ] and [ ^ ] buttons to select the character to enter.

Example:  
Selecting "1"

## 5 Press the [ > ] button.

The second password entry bar flashes.

ADMIN  OFF

## 6 Repeat steps 4 to 5 to enter the remaining digits ("23456AB" in this example).

ADMIN 123456AB OFF

### NOTE

#### To set a 4-digit password

When you have entered four digits, and the fifth password entry bar is flashing, press the [ > ] button.

## 7 When you have entered the password, press the [ > ] button.

The cursor moves to "OFF" (flashing).

## 8 Press the [ v ] or [ ^ ] button to select "ON".

ADMIN 123456AB ON

### ! CAUTION

If you select "OFF" for the "ADMIN" setting, you cannot set the "USER" password.

## 9 When you have finished making the setting, press the [ > ] button.

The cursor moves to "USER".

If you do not want to set a user password, the password setting is now finished.

Press the [ v ] or [ ^ ] button to move the cursor to "REC CONTROL", to set the authorization for recording and playback operation. (→P.57)

```

< SECURITY LOCK SET >
LEVEL PASSWORD(4-8) USE
ADMIN 123456AB ON
USER ----- OFF
REC CONTROL : ADMIN
COPY TO CD-R/CF : USE

```

## SECURITY LOCK SET

### Setting the user password

**Example: Setting "AB123456"**

Perform steps 1 and 2 on P.55 and 56.

- 3** Press the [∨] or [^] button to move the cursor to "USER".

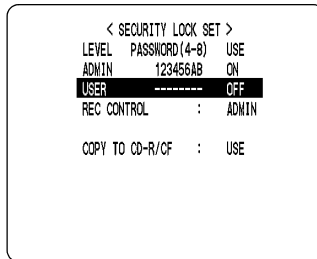

- 4** Press the [>] button.

The first password entry bar "-" flashes.

**Example: A**

Press the [∨] or [^] button to select "A".



- 5** Press the [>] button.

The second password entry bar flashes.

Press the [∨] or [^] button to select "B".

Use the same procedure as "Settings the administrator password" to set "123456."

- 6** When you have finished making the setting, press the [>] button.

The cursor moves to "OFF" (which flashes).

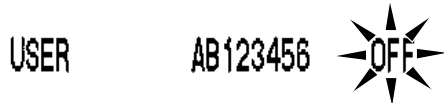

- 7** Press the [∨] or [^] button to select "ON", then press the [>] button.

The cursor moves to "REC CONTROL".

### Setting the password for recording and playback operations

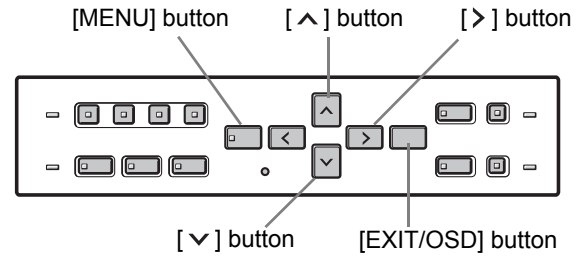

Perform steps 1 and 2 on P.55 and 56.

- 3** Press the [∨] or [^] button to move the cursor to "REC CONTROL".

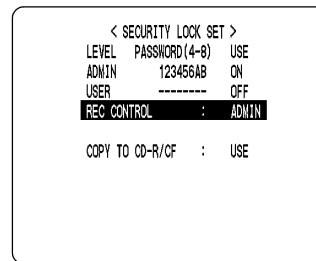

- 4** Press the [>] button.

- 5** Press the [∨] or [^] button to select "ADMIN" or "USER".

The setting is now finished.

- 6** Press the [EXIT/OSD] button.

The display returns to the normal screen.

### Preventing copying to CD-R/RWs and CompactFlash cards

Making the following settings prevents the copying of videos to a CD-R/RW or CompactFlash card for anyone except the administrator.

- Set the administrator password.
- Set COPY TO CD-R/CF to "NO USE".
- Set the security lock.

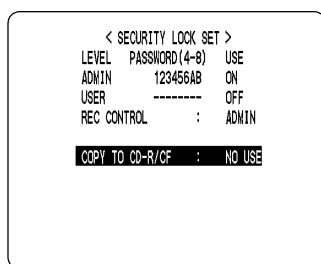

### 3 While the password entry screen is displayed, enter the password.

Enter the password using the [v], [^] and [>] buttons.



Enter the password set for administrators or users (such as "123456AB").

123456AB

### 4 Press the [ > ] button.

The setting is now finished. The LOCK/REMOTE indicator turns off, and the display returns to the normal screen.

### Setting the security lock

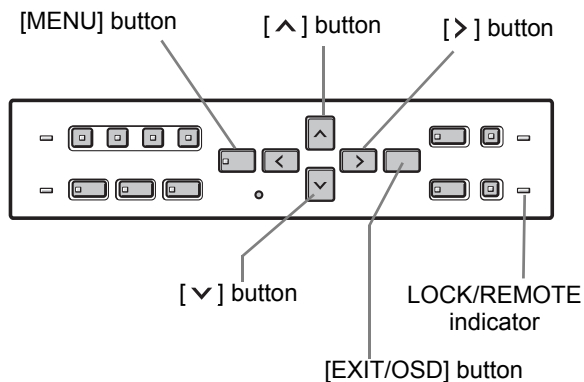

### 1 With the normal monitoring screen displayed, press the [v] button for about 3 seconds.

A confirmation tone sounds, the LOCK/REMOTE indicator lights, and the security lock is set.

### 2 To check the security lock, press any button.

The password entry screen is displayed for about 5 seconds.



## 8. RS-485/NETWORK SET

This section describes how to make the RS-485 terminal connections/settings needed to connect to an external device, and how to make the network connections needed to connect to a PC.

### Network connections and settings

You can make digital video recorder menu settings and monitor images from a PC via a network (LAN). To do so, connect an Ethernet cable to the LAN terminal on the digital video recorder's rear panel.

\* The VA-SW81LITE Ver.2 or VA-SW814 Ver.2 (sold separately) software must be installed on the PC.

- To connect a PC directly  
(Do not use an Ethernet hub.)

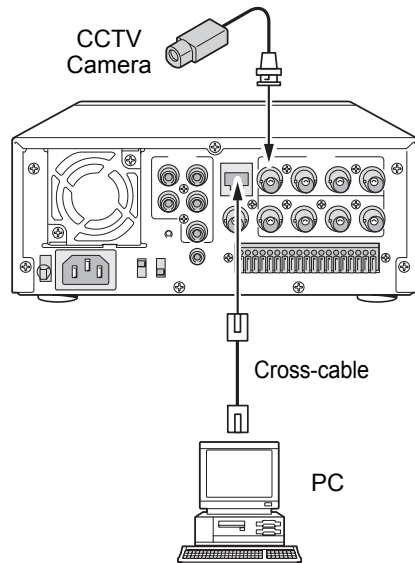

SETTINGS

- To connect to an intranet  
(Use an Ethernet hub.)

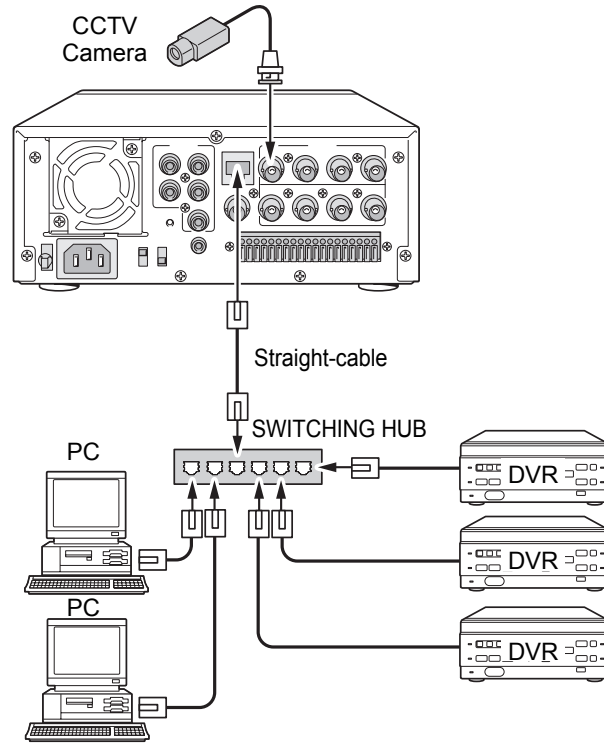

### Settings for connecting to a PC or network

This section describes how to set the IP address. In the default setting, the IP address is set automatically by the PC.

To set the IP address manually, follow the procedures below.

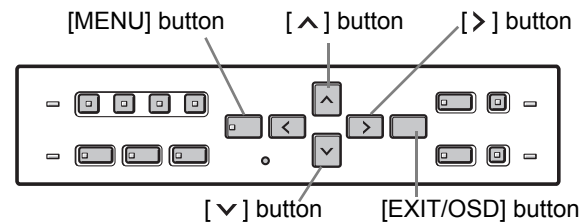

#### 1 Press the [MENU] button.

The [MENU] button lights, and the <MAIN MENU> screen is displayed.

**2 Select “7. RS-485/NETWORK SET”, and press the [ > ] button.**

The <NETWORK SET> screen is displayed.

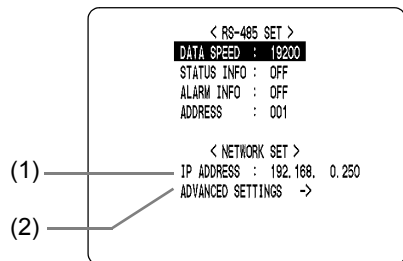

**Settings**

|     | Item             | Description                                                       |
|-----|------------------|-------------------------------------------------------------------|
| (1) | IP ADDRESS       | Displays the IP address that has been set.                        |
| (2) | ADVANCED SETTING | Set whether to set IP address on digital video recorder or on PC. |

**3 Press the [ ^ ] or [ v ] button to select “ADVANCED SETTING” and press the [ > ] button.**

The <NETWORK SET-ADVANCED> screen appears.

The cursor moves to “ADDRESS SET”.

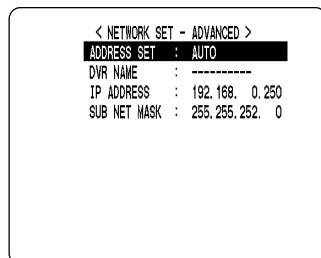

**4 Press the [ > ] button, then press the [ ^ ] or [ v ] button to select “MANUAL”.**

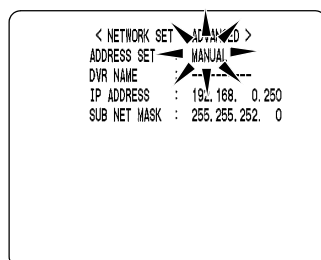

**Settings ( ◆ indicates default setting.)**

| Setting | Description                                                                                                                                                                               |
|---------|-------------------------------------------------------------------------------------------------------------------------------------------------------------------------------------------|
| ◆ AUTO  | When either the VA-SW814 Ver.2 or VA-SW81LITE Ver.2 remote control software is used, the digital video recorder's [STILL] button can be pressed to have the IP address set automatically. |
| MANUAL  | The “DVR NAME”, “IP ADDRESS” and “SUB NET MASK” are set on the digital video recorder.                                                                                                    |

**5 Set “DVR NAME”, “IP ADDRESS”, and “SUB NET MASK” using the [ > ], [ ^ ], and [ v ] buttons.**

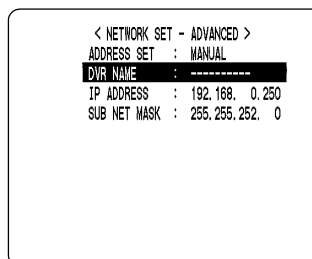

**6 Press the [EXIT/OSD] button.**

The display returns to the normal screen.

**NOTE**

When a new IP address is set using the digital video recorder, it will become valid upon leaving the <RS-485/NETWORK/REMOTE SET> screen.

**CAUTION**

When connecting the digital video recorder to a network, check the IP address with the network administrator.

The set IP address is displayed in the <RS-485/NETWORK/REMOTE SET> screen.

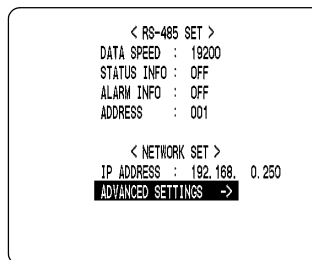

## RS-485/NETWORK SET

### RS-485 connections and settings

Connect the digital video recorder's RS-485 (A, B) control terminals to the system controller, hard disk digital recorder or similar device.

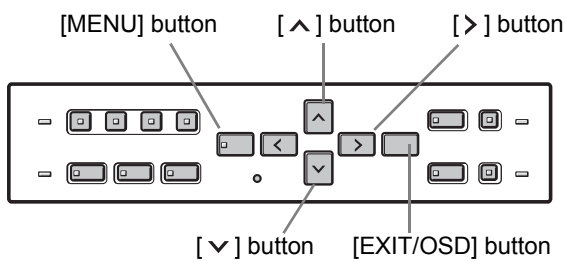
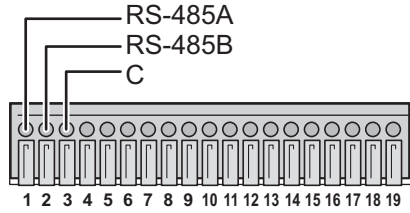

SETTINGS

#### 1 Press the [MENU] button.

The [MENU] button lights, and the <MAIN MENU> screen is displayed.

#### 2 Select "7. RS-485/NETWORK SET", and press the [ > ] button.

The <RS-485 SET> screen is displayed.

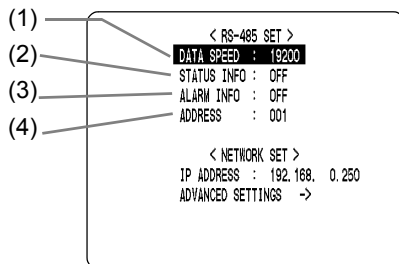

Settings (◆ indicates default setting.)

|     | Item        | Setting                         | Description                                                                     |
|-----|-------------|---------------------------------|---------------------------------------------------------------------------------|
| (1) | DATA SPEED  | 2400<br>4800<br>9600<br>◆ 19200 | Used to select the communication speed. (Unit: bps)                             |
| (2) | STATUS INFO | ON                              | Enables status information to be sent on the RS-485 line.                       |
|     |             | ◆ OFF                           | Not set                                                                         |
| (3) | ALARM INFO  | ON                              | Enables alarm information to be sent on the RS-485 line.                        |
|     |             | ◆ OFF                           | Not set                                                                         |
| (4) | ADDRESS     | 000 to 127<br>(◆001)            | When connecting multiple recorders, different address numbers are set for each. |

**3** Press the [v] and [^] buttons to select the desired item, then press the [ > ] button.

**4** Press the [v] and [^] buttons to change the setting, then press the [ > ] button.

**5** Repeat steps 3 to 4 to set the other items as needed.

**6** When you have finished making the settings, press the [EXIT/OSD] button.

The display returns to the normal screen.

## 9. POWER LOSS/USED TIME

### <MAIN MENU>

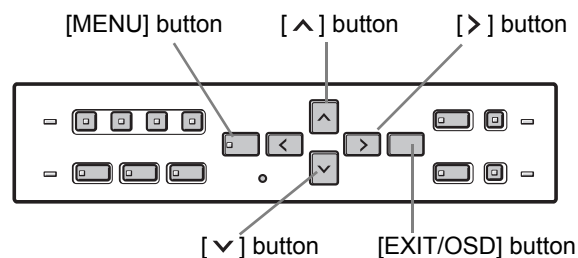
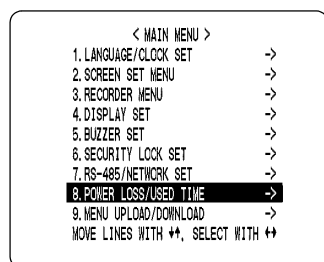

You can check the date/time of power failures and the amount of used hard disk operation time.

### 1 Press the [MENU] button.

The [MENU] button lights, and the <MAIN MENU> screen is displayed.

### 2 Select "8. POWER LOSS/USED TIME", and press the [ > ] button.

The <POWER LOSS/USED TIME> screen is displayed.

| < POWER LOSS/USED TIME >              |             |           |       |
|---------------------------------------|-------------|-----------|-------|
| POWER                                 | LOSS        | RECOVER   |       |
| #004                                  | 09-09 11:16 | 09-09     | 13:17 |
|                                       | 09-09 10:48 | 09-09     | 10:49 |
|                                       | 09-09 10:40 | 09-09     | 10:41 |
|                                       | 09-09 12:53 | 09-09     | 10:10 |
| (2)                                   | DISK1 USE   | : 00012 H |       |
| (3)                                   | DISK2 USE   | : ----- H |       |
| (4)                                   | POWER       | : 00012 H |       |
| FIRMWARE : MAIN 0.50-00 / SUB 0.50-00 |             |           |       |

#### (1) LOSS/RECOVER:

Displays the date and time of the last 4 power failures and the date/time of recovery.  
Displays the date/time at which a power failure occurred.

The number on the left is the number of power failures (example: #010). This number is reset to "000" after exceeding "999".

#### (2) DISK1 USE:

Displays the total used amount of disk 1 operation time.

#### (3) DISK2 USE:

Displays the total used amount of disk 2 operation time (when second disk has been added).

#### (4) POWER:

Displays the amount of power ON time for the digital video recorder.

### 3 Press the [EXIT/OSD] button.

The display returns to the normal screen.

## 10. MENU UPLOAD/DOWNLOAD

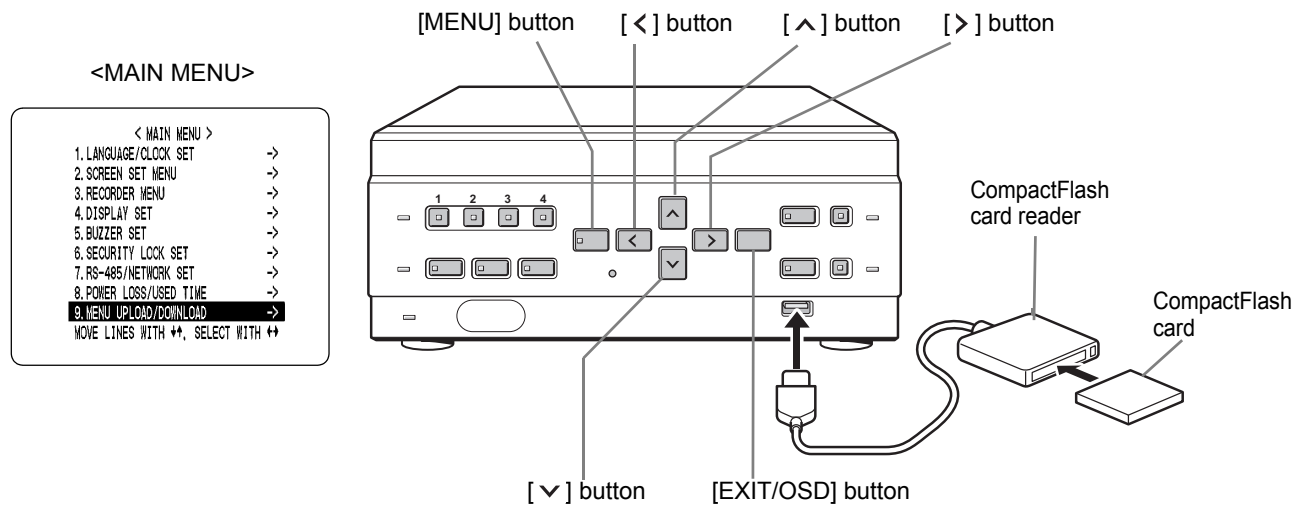

You can save the settings onto a CompactFlash card. Also, you can load settings saved on CompactFlash cards to the DVR.

### ! CAUTION

- Do not turn the power OFF when saving/loading menu items to/from a CompactFlash card.
- Confirm that the light on the CompactFlash card reader is lit before using the card reader with the USB port. If the card reader is used before the light is lit, SAVE and LOAD may not be available.
- After saving the settings to a CompactFlash card, you may not be able to repeat the operation. If this problem occurs, redo the operation after ejecting and reinserting the CompactFlash card.

### NOTE

- At least 4 KB of available memory space is needed on the CompactFlash card.
- For the recommended CompactFlash card reader, see our website at “[www.sanyosecurity.com](http://www.sanyosecurity.com)”.

## Settings

You will need a CompactFlash card reader and CompactFlash card (commercially available).

### 1 Press the [MENU] button.

The [MENU] button lights, and the <MAIN MENU> screen is displayed.

### 2 Select “9. MENU UPLOAD/DOWNLOAD”, and press the [ > ] button.

The <MENU UPLOAD/DOWNLOAD> screen is displayed.

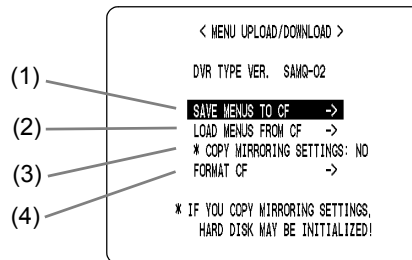

|     | Item                    | Description                                                                                                       |
|-----|-------------------------|-------------------------------------------------------------------------------------------------------------------|
| (1) | SAVE MENUS TO CF        | Saves the settings to CompactFlash card.                                                                          |
| (2) | LOAD MENU FROM CF       | Reads the settings saved on CompactFlash card.                                                                    |
| (3) | COPY MIRRORING SETTINGS | Sets whether to apply “MIRRORING ON/OFF” setting saved on CompactFlash card when “LOAD MENU FROM CF” is selected. |
| (4) | FORMAT CF               | Initializes CompactFlash card.                                                                                    |

### ! CAUTION

If “COPY MIRRORING SETTINGS” is set to “YES”, the hard disk may be initialized. If you don’t want to initialize the hard disk, select “NO”.



**To save settings to a CompactFlash card**

**1** Press the [∨] or [∧] button to select “SAVE MENUS TO CF”, then press the [>] button.

The <WARNING> screen is displayed. “NO” flashes.

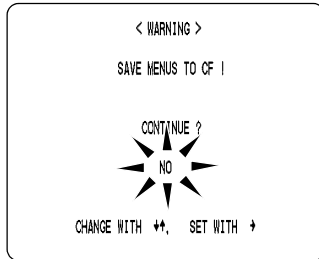

**2** Press the [∨] or [∧] button to select “YES”, then press the [>] button.

Saving starts.

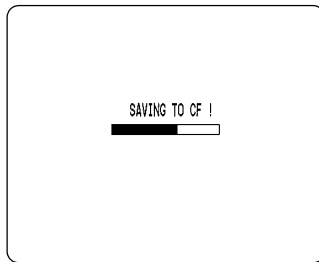

When you have finished loading, the display returns to the <MENU UPLOAD/DOWNLOAD> screen.

**NOTE**

A file named “M814MENU.txt” is created on the CompactFlash card.

**To load settings from a CompactFlash card**

**1** Press the [∨] or [∧] button to select “LOAD MENUS FROM CF”, then press the [>] button.

The <WARNING> screen is displayed. “NO” flashes.

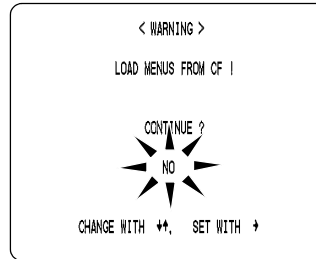

**2** Press the [∨] or [∧] button to select “YES”, then press the [>] button.

Loading starts.

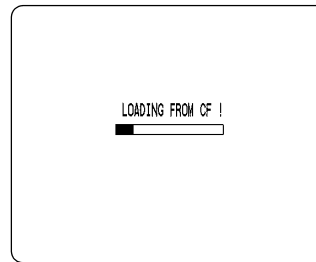

When you have finished loading, the display returns to the <MENU UPLOAD/DOWNLOAD> screen.

SETTINGS

**To format CompactFlash cards**

**1** Press the [∨] or [∧] button to select “FORMAT CF”, then press the [>] button.

The <WARNING> screen is displayed. “NO” flashes.

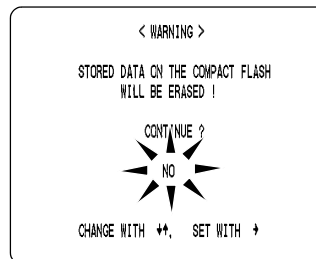

(continued)

## MENU UPLOAD/DOWNLOAD

**2** Press the [∨] or [∧] button to select “YES”, then press the [>] button.

CompactFlash card formatting starts.



When formatting has finished, the display returns to the <MENU UPLOAD/DOWNLOAD> screen.

**! CAUTION**

Formatting a CompactFlash card erases all the data stored on it. To cancel formatting, select “NO”.

---

### To exit

---

Press the [EXIT/OSD] button.

The display returns to the normal screen.

SETTINGS

## APPENDIX

# 1. CONTROL TERMINAL SPECIFICATIONS

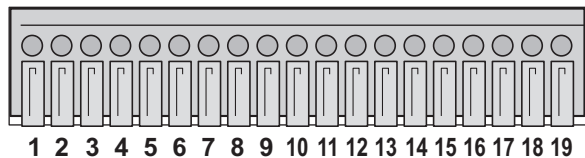

| Terminal No. | Name                       | Signal                                         | Function                                                                               |
|--------------|----------------------------|------------------------------------------------|----------------------------------------------------------------------------------------|
| 1            | RS-485A                    | RS-485                                         | To RS-485 terminal signal A*1                                                          |
| 2            | RS-485B                    | RS-485                                         | To RS-485 terminal signal B*1                                                          |
| 3            | C                          |                                                | Common                                                                                 |
| 4            | REMOTE                     | Resistance ladder connection                   | Remote Control terminal                                                                |
| 5            | C                          |                                                | Common                                                                                 |
| 6            | CLOCK ADJ IN               | Normal open, Low level active                  | Input for clock setting                                                                |
| 7            | CLOCK ADJ OUT              | Normal resistance 5V DC/57kΩ, Low level active | Output for clock setting                                                               |
| 8            | C                          |                                                | Common                                                                                 |
| 9            | SERIES REC IN              | Normal open, Low level active                  | Input terminal used when recording with multiple digital video recorders connected.    |
| 10           | NON REC OUT/SERIES REC OUT | Normal resistance 5V DC/57kΩ, Low level active | Output terminal used when recording with multiple digital video recorders connected.*2 |
| 11           | ALARM IN 1                 | Normal open, Low level active                  | Alarm input for channel 1                                                              |
| 12           | ALARM IN 2                 | Normal open, Low level active                  | Alarm input for channel 2                                                              |
| 13           | ALARM IN 3                 | Normal open, Low level active                  | Alarm input for channel 3                                                              |
| 14           | ALARM IN 4                 | Normal open, Low level active                  | Alarm input for channel 4                                                              |
| 15           | ALARM RESET                | Normal open, Low level active                  | Alarm reset input                                                                      |
| 16           | ALARM OUT                  | Normal resistance 5V DC/57kΩ, Low level active | ALARM OUT                                                                              |
| 17           | C                          |                                                | Common                                                                                 |
| 18           | WARNING OUT                | Open collector (500 mA), Low level active      | Warning output*3                                                                       |
| 19           | DISK FULL OUT              | Open collector (500 mA), Low level active      | Recording area full warning                                                            |

\*1 Used for twisted-pair cable connection.

\*2 Outputs SERIES REC OUT when OVER WRITE in REC MODE SET is "OFF", and SERIES REC is "-1M", "-2M", or "-3M". Outputs NON REC OUT when SERIES REC is "OFF".

\*3 The following warnings are output:

- Hard disk drive error
- Fan error
- Recording error
- No input signal when VIDEO LOSS is ON.

### Connecting cables to the control terminals

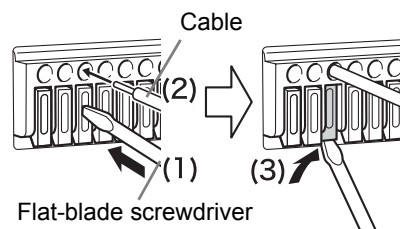

- (1) Push in the lock pin with a flat-blade screwdriver.
- (2) Insert the cable.
- (3) Pull out the lock pin with a flat-blade screwdriver. The cable is now secured in place.

### System controller connections

The connections for a system controller are shown below. Insert a twisted-pair cable (sold separately) into the RS-485A, RS-485B and C (ground) terminals on the rear panel. Connect the RS-485A and RS-485B output to signal A and signal B respectively of the system controller.

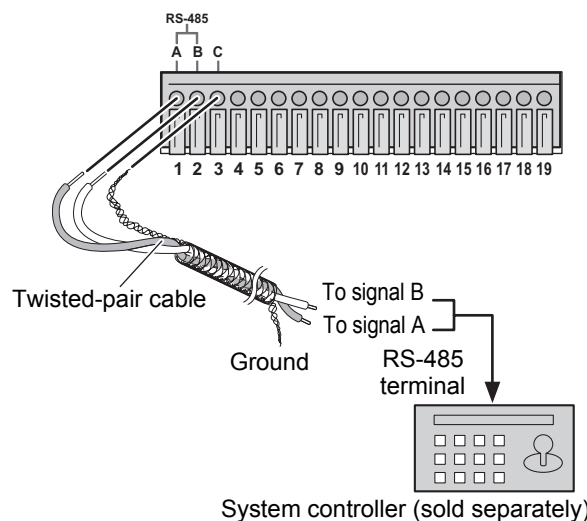

- **Twisted-pair cable**  
Reduces signal interference caused by noise from other cables.
- For information about the system controller, contact your local dealer.

## CONTROL TERMINAL SPECIFICATIONS

### Remote control connections

The connections for a remote control circuit are shown below. Connect the remote control to the REMOTE terminal and C (ground) terminal.

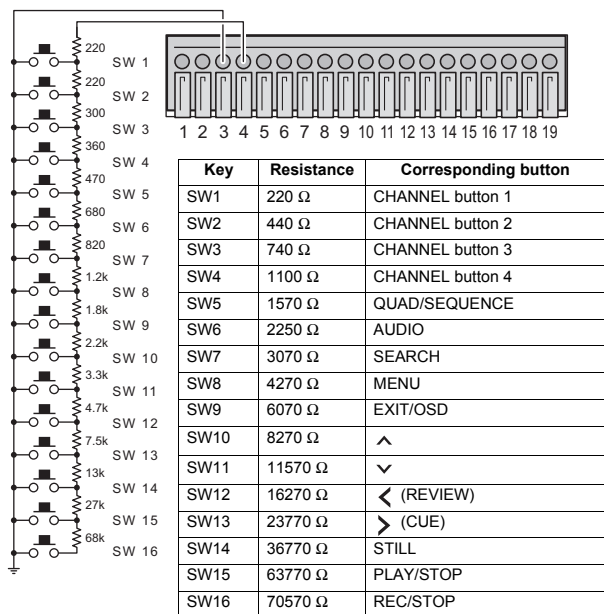

Use a resistance of 1/10 ohms or more and with a D ranking (precision 0.5% or finer).

SW16 operates the same as the [REC/STOP] button on the digital video recorder. When the switch is turned on while not recording, recording begins. When the switch is kept on for 2 seconds or more while recording, recording is stopped.

### Alarm sensor connections

Alarm sensors can be connected to the ALARM IN 1 to 4 terminals and C (ground) terminal.

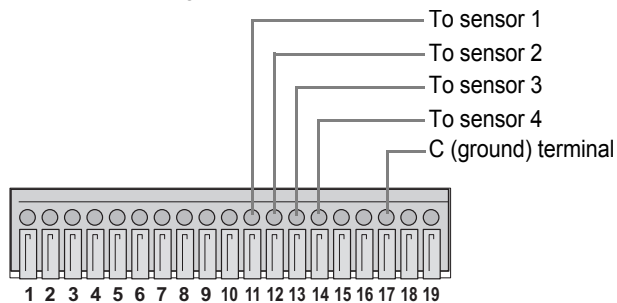

### Series recording connections

Connect the control terminals by cables as shown below.

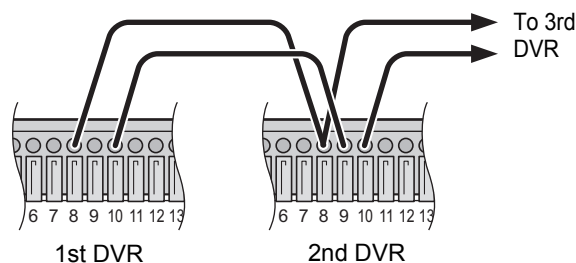

Terminal No.  
 8: COMMON  
 9: SERIES REC IN  
 10: NON REC OUT/SERIES REC OUT

## 2. RS-485 SPECIFICATIONS

### Data format

|                         |                             |
|-------------------------|-----------------------------|
| Mode                    | Asynchronous                |
| Character length        | 8 bits                      |
| Data transmission speed | 2400, 4800, 9600, 19200 bps |
| Parity check            | None                        |
| Stop bit                | 1                           |

### Communication protocol

A proprietary Sanyo protocol (SSP: Security Serial Protocol) is used. Use of a special controller for operation is recommended. To obtain this controller, contact your local dealer or a Sanyo service center.

### RS-485 termination switch settings

#### Termination settings

When connecting multiple devices, you must make termination settings on both end devices.

- Set the RS-485 termination switch of both end devices to ON.
- Be sure to set the RS-485 termination switches of all devices in between (devices other than the first and last devices) to OFF.

#### **!** CAUTION

If you don't make the correct termination settings, data will be distorted and will affect other data, making the data transmitted to each device incorrect.

### Example

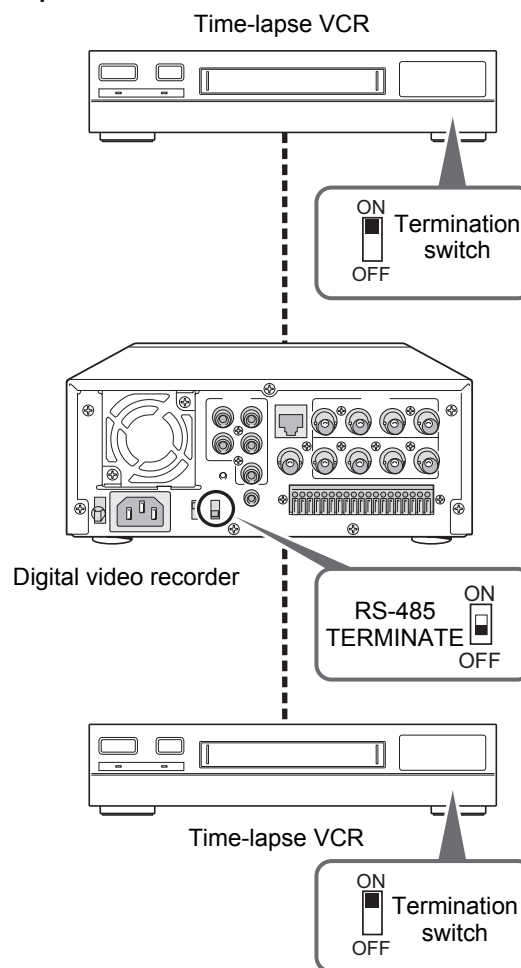

### 3. INTERFACE SPECIFICATIONS

#### DVR/VCR command table

The table below shows the commands supported by the digital video recorder.

| Left digit<br>Right digit | 0 | 1 | 2     | 3    | 4                            | 5      | 6                    | 7    |
|---------------------------|---|---|-------|------|------------------------------|--------|----------------------|------|
| 0                         |   |   |       |      |                              |        | TIMER<br>ON/OFF      |      |
| 1                         |   |   |       |      |                              |        |                      |      |
| 2                         |   |   | AUDIO |      |                              |        |                      |      |
| 3                         |   |   |       |      |                              | SHIFT← | SHIFT→               |      |
| 4                         |   |   |       |      |                              | SHIFT↑ | SHIFT↓               | MENU |
| 5                         |   |   |       |      |                              |        | SHIFT+<br>/RP UP     |      |
| 6                         |   |   |       |      |                              |        | SHIFT-<br>/RP DOWN   |      |
| 7                         |   |   |       |      |                              |        |                      |      |
| 8                         |   |   |       |      |                              |        |                      |      |
| 9                         |   |   |       |      |                              |        | SECURITY<br>LOCK ON  |      |
| A                         |   |   |       | PLAY | REV PLAY<br>/SEARCH<br>(DVR) |        | SECURITY<br>LOCK OFF |      |
| B                         |   |   |       |      |                              |        |                      |      |
| C                         |   |   |       |      |                              |        | GROUP SET            |      |
| D                         |   |   |       |      |                              |        | GROUP<br>CHECK       |      |
| E                         |   |   |       |      |                              |        | GROUP<br>CLEAR       |      |
| F                         |   |   |       | STOP | STILL                        |        |                      |      |

| Left digit<br>Right digit | 8        | 9        | A   | B              | C        | D               | E                 | F                  |
|---------------------------|----------|----------|-----|----------------|----------|-----------------|-------------------|--------------------|
| 0                         |          | CAMERA 1 |     |                |          |                 | CLOCK<br>ADJUST   |                    |
| 1                         |          | CAMERA 2 |     |                |          |                 | MENU<br>RESET     |                    |
| 2                         |          | CAMERA 3 |     |                |          |                 |                   |                    |
| 3                         | QUAD     | CAMERA 4 |     |                |          |                 |                   |                    |
| 4                         |          |          |     |                |          |                 |                   |                    |
| 5                         |          |          |     |                |          |                 |                   |                    |
| 6                         |          |          |     |                |          |                 |                   |                    |
| 7                         | SEQUENCE |          |     |                |          | STATUS<br>SENSE |                   |                    |
| 8                         |          |          |     |                |          |                 |                   |                    |
| 9                         |          |          |     |                |          |                 | CLOCK<br>DOWNLOAD |                    |
| A                         |          |          |     |                | REC      |                 |                   | REC/DUB<br>REQUEST |
| B                         |          |          | FF  |                |          |                 |                   |                    |
| C                         |          |          | REW |                |          |                 |                   |                    |
| D                         |          |          |     |                |          |                 |                   |                    |
| E                         | OSD/EXIT |          |     |                |          |                 |                   |                    |
| F                         |          |          |     | STATUS<br>LOG1 | REC STOP |                 |                   |                    |

APPENDIX

## 4. SPECIFICATIONS

|                                  |                                               |                                                                                                           |
|----------------------------------|-----------------------------------------------|-----------------------------------------------------------------------------------------------------------|
| Hard disk capacity               |                                               | Upgradeable to two (2), maximum 300 GB hard disks                                                         |
| Television system                |                                               | NTSC/PAL color signal standard (Switchable)                                                               |
| Picture resolution               |                                               | NTSC: 720 x 480 pixels (Super+/Super/High/Standard)<br>PAL: 720 x 576 pixels (Super+/Super/High/Standard) |
| Compression                      | Video                                         | MPEG2                                                                                                     |
|                                  | Audio                                         | MPEG1 Audio Layer2                                                                                        |
| Picture quality                  |                                               | 4 levels (Super+/Super/High/Standard)                                                                     |
| Recording type                   |                                               | Frame                                                                                                     |
| Recording speed                  |                                               | NTSC: 30 fps or PAL: 25 fps                                                                               |
| Screen                           |                                               | Single screen/Quad screen                                                                                 |
| Playback                         |                                               | Playback, Still, Search, Cue, Review, Slow/reverse, Frame advance/reverse                                 |
| Recording                        | Normal recording                              | Records on quad screen                                                                                    |
|                                  | Timer recording                               | Records on quad screen                                                                                    |
|                                  | Alarm recording                               | Records on quad screen                                                                                    |
| Search mode                      | Time/date search                              | Search by time and date                                                                                   |
|                                  | Alarm search                                  | Search by alarm event list                                                                                |
| Menu language                    |                                               | English/French/Spanish                                                                                    |
| Clock settings                   |                                               | Month/Day/Year/Hours/Minutes/Seconds                                                                      |
| Miscellaneous functions          |                                               | Motion sensor, Security lock (with password function)                                                     |
| Video input terminal             |                                               | 1V (p-p), 75 Ohm unbalanced, 4 BNC connectors                                                             |
| Video output terminal            |                                               | 1V (p-p), 75 Ohm unbalanced, 4 BNC connectors                                                             |
| Video monitor out terminal       |                                               | 1V (p-p), 75 Ohm unbalanced, 1 BNC connector                                                              |
| Audio input terminal             |                                               | -8 dbs, 47 k Ohm unbalanced (4 RCA pin jacks)                                                             |
| Audio output terminal            |                                               | -8 dbs, 600 Ohm unbalanced (1 RCA pin jack)                                                               |
| Microphone input terminal        |                                               | -60 dbs, 10 k Ohm unbalanced (3.5 mm mono jack)                                                           |
| LAN terminal                     |                                               | 100BASE-TX (RJ-45)                                                                                        |
| USB port                         |                                               | For external storage unit (CompactFlash card reader, CD-R/RW drive)                                       |
| Control connector<br>(Push lock) | RS-485 terminal                               | 3 terminals (A, B, GND)                                                                                   |
|                                  | Remote control terminal                       | Resistance ladder                                                                                         |
|                                  | Clock adjust input terminal                   | Normal open, Low level active                                                                             |
|                                  | Clock adjust output terminal                  | Normal 5 V, Low level active                                                                              |
|                                  | Series rec input terminal                     | Normal open, Low level active                                                                             |
|                                  | Non rec output/<br>Series rec output terminal | Normal 5 V, Low level active                                                                              |
|                                  | Alarm input terminal                          | Normal open, Low level active (4 channels)                                                                |
|                                  | Alarm reset terminal                          | Normal open, Low level active                                                                             |
|                                  | Alarm output terminal                         | Normal 5 V, Low level active                                                                              |
|                                  | Warning output terminal                       | Open collector (500 mA), Low level active                                                                 |
|                                  | Full out warning terminal                     | Open collector (50 mA), Low level active                                                                  |
| Power                            |                                               | 120 – 240 V AC, 50/60 Hz                                                                                  |
| Current consumption              |                                               | 480 mA                                                                                                    |
| Operating temperature            |                                               | 5°C to 40°C (41°F to 104°F)                                                                               |
| Operating humidity               |                                               | 10% to 80%                                                                                                |
| Dimensions                       |                                               | 210 (W) x 96 (H) x 391.5 (D) mm                                                                           |
| Weight                           |                                               | 3.7 kg                                                                                                    |

Note that product appearance and specifications are subject to change without prior notice.

## SPECIFICATIONS

### Dimensions

(mm)

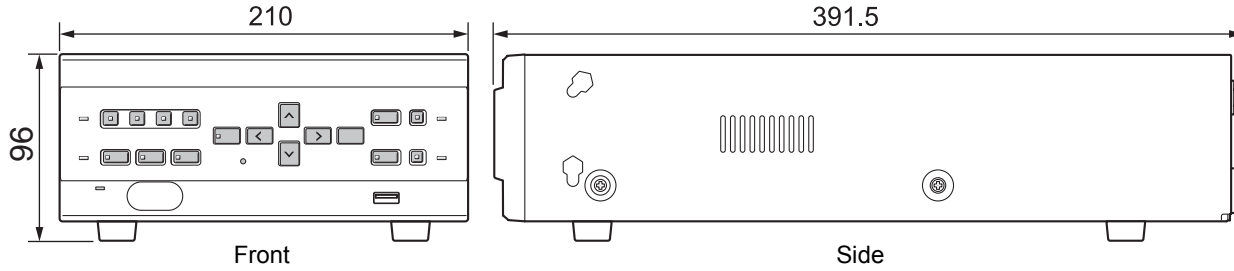

### Cautions when adding a hard disk

The fan is located below the space for the additional hard disk. When adding a hard disk, perform the following procedures to ensure that the harnesses are not entangled in the fan.

#### Before installation

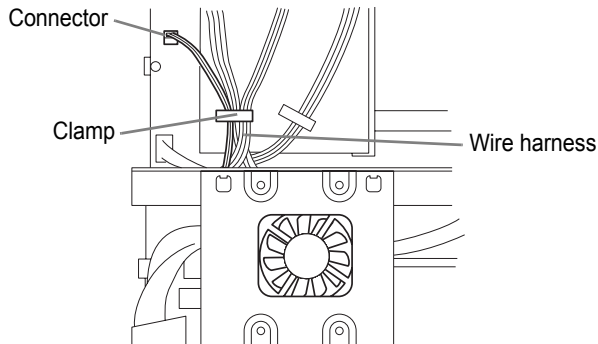

Unplug the fan connector and remove the fan harness from the clamp.

#### During installation

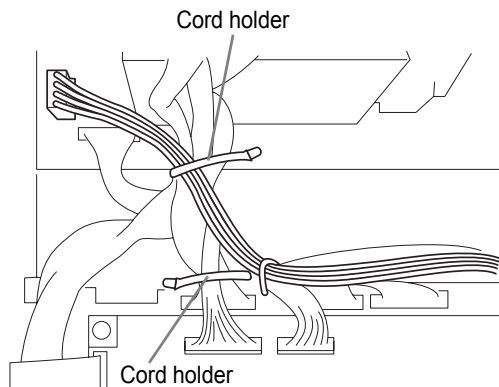

After connecting the wire harness to the second hard disk, secure each wire harness in place.

#### After installation

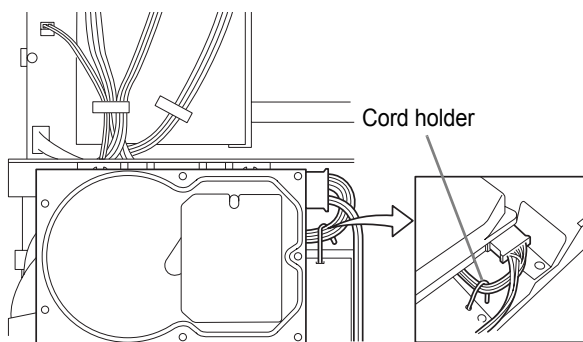

After installing the hard disk, secure its power harness in place with the cord holder, and reattach the fan harness and connector.

APPENDIX



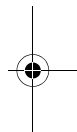
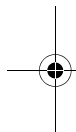
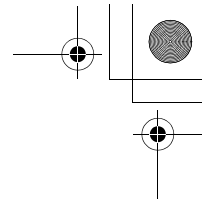
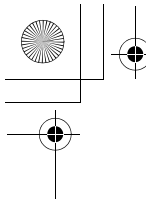

**SANYO**

**SANYO Electric Co., Ltd.**

Printed in Japan

Printed on recycled paper  
Imprimé sur du papier recyclé  
Impreso en papel reciclado

1AC6P1P2857--  
L8HBJ/US, US2, US3 (1104PS-SY)

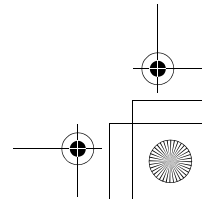
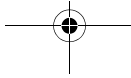
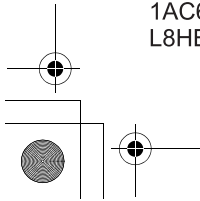

## Free Manuals Download Website

<http://myh66.com>

<http://usermanuals.us>

<http://www.somanuals.com>

<http://www.4manuals.cc>

<http://www.manual-lib.com>

<http://www.404manual.com>

<http://www.luxmanual.com>

<http://aubethermostatmanual.com>

Golf course search by state

<http://golfingnear.com>

Email search by domain

<http://emailbydomain.com>

Auto manuals search

<http://auto.somanuals.com>

TV manuals search

<http://tv.somanuals.com>