

SANYO

INSTRUCTION MANUAL

DVR-H200UK

HDD/DVD Recorder



VIDEOplus

dts
DIGITAL OUT

RW
DVD+ReWritable

DVD
VIDEO

COMPACT
disc
DIGITAL AUDIO

DOLBY
DIGITAL

MP3
MPEG AUDIO

Problems with set-up?

Call 0870 240 7475

Calls cost a maximum of 8p per minute during peak periods, based on BT rates of April 2004.

TABLE OF CONTENTS

GETTING STARTED

Accessories	1
Important safety instructions	2
Warnings, cautions and others	3
Disc information	4

CONTROLS AND DISPLAYS

Remote control	5
Front panel connections	6
Display window	6
Rear panel connections	7

CONNECTIONS

Connecting the antenna cable and television	8
For better video quality	9
Component out	9
For better audio quality	10
Connection to a stereo audio amplifier or receiver	10
Connection to a digital audio device	10
Digital out optical	10
Digital out coaxial	10

SETTING UP

Setup menu	11
------------------	----

TV CHANNEL SETUP

TV channel search	12
Fine-tuning TV channels manually	12
Editing TV channels manually	12
Channel Editor	13

SETTING UP VIDEO PLUS+[®] SYSTEM

Setting up VIDEO Plus+ [®] System	14
--	----

EASY GUIDER

Playback	15
Record	16
Timer record	17
Copy	19

RECORDING

Before recording	20
Recording television programs	20
Adding new recordings	21
Changing chapter intervals	21
Playing back the last recorded session	21
Recording from a VCR or Camcorder	22
One touch record	23
DV recording	23
DV control	24
Recording on a CD-R/CD-RW disc	25

TIMER RECORDING

Setting the timer	26
Recording TV programs with VIDEO Plus+ [®] System	27

TIME SHIFT

Pausing Live TV Broadcast	29
Record and Play	29

PLAYBACK

Basic playback	30
POWER, OPEN/CLOSE, PLAY, FF, REV	30
NEXT, PREVIOUS	30
PAUSE/STEP, STOP, DISPLAY	30
DISC MENU, PLAYLIST	30
Navigation operation	31
REPEAT, ZOOM	31
SLOW, SEARCH	31
A-B REPEAT, SUBTITLE	31
AUDIO, ANGLE	31
INFORMATION	31
Video title playback	32
Music file playback	33
Picture file playback	33
Audio CD playback	34
Playback pictures with music	34

COPY

Copy from DVD to HDD	35
Copy from HDD to DVD	35

EDIT

DVD menu and Edit menu	36
Naming a title	36
Protecting a title	36
Overwriting a title	36
Splitting a title	37
Merging titles	37
Erasing a title	37
Setting a title thumbnail	37
Chapter marks relevant setting	38

DISC TOOLS

Erase	40
Finalize	40
Clean up	41
Defragment	41

GUI OPERATION

FIRMWARE UPDATE





GLOSSARY

SPECIFICATIONS

TROUBLESHOOTING GUIDE

Accessories

Please check and identify the supplied accessories.

- | | | | |
|--|---|---|---|
| <input type="checkbox"/> 1x Remote control |  | <input type="checkbox"/> 1x Audio/Video cable |  |
| <input type="checkbox"/> 1x Power Cord |  | <input type="checkbox"/> 2x Batteries |  |
| <input type="checkbox"/> 1x RF Cable |  | | |

Used batteries

The batteries in the remote controller of your HDD/DVD Recorder do not contain mercury. However, Sanyo recommends that you do not dispose of used batteries with domestic refuse. Please, contact your dealer or your local authorities for information regarding the disposal of used batteries or take them to your nearest collection point.

IMPORTANT SAFETY INSTRUCTIONS

- 1) **Read instructions.** Read all the safety and operating instructions before operating the product.
- 2) **Retain instructions.** Keep the safety and operating instructions for future reference.
- 3) **Heed warnings.** Adhere to all warnings on the product and in the operating instructions.
- 4) **Follow instructions.** Follow all operating and use instructions.
- 5) **Cleaning** - Unplug this product from the wall outlet before cleaning. Do not use liquid cleaners or aerosol cleaners. Use a damp cloth for cleaning.
- 6) **Attachments** - Do not use attachments not recommended by the product manufacturer as they may cause hazards.
- 7) **Water and Moisture** - Do not use this product near water for example, near a bathtub, washbowl, kitchen sink, or laundry tub, in a wet basement, or near a swimming pool.
- 8) **Accessories** - Do not place this product on an unstable cart, stand, tripod, bracket, or table. The product may fall, causing serious injury to a child or adult, and serious damage to the product. Use only with a cart, stand, tripod, bracket, or table recommended by the manufacturer or sold with the product. Any mounting of the product should follow the manufacturer's instructions and should use a mounting accessory recommended by the manufacturer.
- 9) **CART** - A product and cart combination should be moved with care. Quick stops, excessive force, and uneven surfaces may cause the product and cart combination to overturn.
- 10) **Ventilation** - Slots and openings in the cabinet provide ventilation, ensure reliable operation of the product, and protect it from overheating. Do not block or cover these openings. The openings should never be blocked by placing the product on a bed, sofa, rug, or other similar surface. Do not place this product in a built-in installation such as a bookcase or rack unless proper ventilation is provided or the manufacturer's instructions have been adhered to.
- 11) **Power Sources** - This product should be operated only from the type of power source indicated on the marking label. If you are not sure of the type of power supply to your home, consult your product dealer or local power company. For products intended to operate from battery power, or other sources, refer to the operating instructions.
- 12) **LOCATION** - The appliance should be installed in a stable location.
- 13) **NONUSE PERIODS** - The power cord of the appliance should be unplugged from the outlet when left unused for a long period of time.
- 14) **Grounding or Polarization** -
 - If this product is equipped with a polarized alternating current line plug (a plug having one blade wider than the other), it will fit into the outlet only one way. This is a safety feature. If you are unable to insert the plug fully into the outlet, try reversing the plug. If the plug should still fail to fit, contact your electrician to replace your obsolete outlet. Do not defeat the safety purpose of the polarized plug.
 - If this product is equipped with a three-wire grounding type plug, it will only fit into a grounding type power outlet. This is a safety feature. If you are unable to insert the plug into the outlet, contact your electrician to replace your obsolete outlet. Do not defeat the safety purpose of the grounding type plug.
- 15) **Power-Cord Protection** - Power-supply cords should be routed so that they are not likely to be walked on or pinched by items placed upon or against them, paying particular attention to cords at plugs, convenience receptacles, and the point where they exit from the product.
- 16) **Outdoor Antenna Grounding** - If an outside antenna or cable system is connected to the product, be sure the antenna or cable system is grounded so as to provide some protection against voltage surges and built-up static charges. Article 810 of the National Electrical Code, ANSI/NFPA 70, provides information with regard to proper grounding of the mast and supporting structure, grounding of the lead-in wire to an antenna discharge unit, size of grounding conductors, location of antenna-discharge unit, connection to grounding electrodes, and requirements for the grounding electrode.
- 17) **Lightning** - For added protection of this product during a lightning storm, or when it is left unattended and unused for long periods of time, unplug it from the wall outlet and disconnect the antenna or cable system. This will prevent damage to the product due to lightning and power-line surges.
- 18) **Power Lines** - An outside antenna system should not be located in the vicinity of overhead power lines or other electric lights or power circuits, or where it can fall into such power lines or circuits. When installing an outside antenna system, take extreme care to keep it from touching power lines or circuits. Contact with them might be fatal.
- 19) **Overloading** - Do not overload wall outlets, extension cords, or integral convenience receptacles. This can result in a risk of fire or electric shock.
- 20) **Objects and Liquids** - Do not push objects of any kind into this product through openings. They may touch dangerous voltage points or short out parts, resulting in a fire or electric shock. Liquids of any kind should not be used on or around this product.
- 21) **Servicing** - Do not attempt to service this product yourself. Opening or removing covers may expose you to dangerous voltage or other hazards. Refer all servicing to qualified service personnel.
- 22) **Damage Requiring Service** - Unplug this product from the wall outlet and refer servicing to qualified service personnel under the following conditions:
 - When the power supply cord or plug is damaged,
 - If liquid has spilled or objects have fallen into the product,
 - If the product has been exposed to rain or water,
 - If the product does not function properly after following the operating instructions, contact Customer Service for technical support.
 - If the product has been dropped or damaged in any way,
 - When the product exhibits a distinct change in performance.This indicates a need for service.
- 23) **Replacement Parts** - When replacement parts are required, be sure the service technician uses replacement parts specified by the manufacturer or having the same characteristics as the original part. Unauthorized substitutions may result in fire, electric shock, or other hazards.
- 24) **Safety Check** - Upon completion of any service or repairs to this product, ask the service technician to perform safety checks to determine that the product is in proper operating condition.
- 25) **Wall or Ceiling Mounting** - Mount the product to a wall or ceiling only as recommended by the manufacturer.
- 26) **Heat** - Keep this product away from heat sources, such as radiators, heat registers, stoves, or amplifiers.
- 27) **Battery Usage** - Battery leakage may result in bodily injury or damage to the unit. In order to avoid battery problems, please follow these instructions.
 - Install all batteries correctly, with + and - aligned as marked on the unit.
 - Do not mix batteries (old/new, carbon/alkaline, etc.).
 - Remove batteries when the unit is not used for a long time.

WARNINGS, CAUTIONS AND OTHERS



CAUTION
RISK OF ELECTRIC SHOCK
DO NOT OPEN



CAUTION!

TO REDUCE THE RISK OF ELECTRIC SHOCK,
DO NOT REMOVE THE COVER OF THIS UNIT.
THERE ARE NO USER SERVICEABLE PARTS INSIDE.
REFER SERVICING TO QUALIFIED SERVICE PERSONNEL.



The lightning flash with arrowhead symbol, within an equilateral triangle, is intended to alert the user to the presence of uninsulated "dangerous voltage" within the product's enclosure that may be of sufficient magnitude to constitute a risk of electric shock to humans.



The exclamation point within an equilateral triangle is intended to alert the user to the presence of important operating and maintenance (servicing) instructions in the literature accompanying the appliance.

CAUTION!

THIS PRODUCT UTILIZES A LASER.
USE OF CONTROLS OR ADJUSTMENTS OR PERFORMANCE OF PROCEDURES OTHER THAN THOSE SPECIFIED HEREIN MAY RESULT IN HAZARDOUS RADIATION EXPOSURE. DO NOT OPEN THE COVER AND DO NOT REPAIR YOURSELF. REFER SERVICING TO QUALIFIED SERVICE PERSONNEL.

WARNING:

TO REDUCE THE RISK OF FIRE, ELECTRIC SHOCK OR PRODUCT DAMAGE, DO NOT EXPOSE THIS APPARATUS TO MOISTURE AND ENSURE THAT OBJECTS FILLED WITH LIQUIDS, SUCH AS VASES, SHALL BE PLACED AWAY FROM THE APPARATUS.

CAUTION! — ⏻STANDBY/ON button

Disconnect the main plug to shut the power off completely. The ⏻STANDBY/ON button in any position does not disconnect the main line. Power can be controlled from the remote.

PRODUCTS WITH 625P PROGRESSIVE SCAN OUTPUTS NOTICE REQUIREMENTS

"CONSUMERS SHOULD NOTE THAT NOT ALL HIGH DEFINITION TELEVISION SETS ARE FULLY COMPATIBLE WITH THIS PRODUCT AND MAY CAUSE ARTIFACTS TO BE DISPLAYED IN THE PICTURE. IN CASE OF 625 PROGRESSIVE SCAN PICTURE PROBLEMS, IT IS RECOMMENDED THAT THE USER SWITCH THE CONNECTION TO THE "STANDARD DEFINITION" OUTPUT. IF THERE ARE QUESTIONS REGARDING OUR TV SET COMPATIBILITY WITH THIS MODEL 625P DVD PLAYER, PLEASE CONTACT OUR CUSTOMER SERVICE CENTER."

VIDEO Plus+

VIDEO Plus+ and PlusCode are registered trademarks of Gemstar Development Corporation. The VIDEO Plus+ system is manufactured under license from Gemstar Development Corporation.

IMPORTANT FOR LASER PRODUCTS

- 1) CLASS 1 LASER PRODUCT
- 2) **DANGER:** Visible and invisible laser radiation when open and interlock failed or defeated. Avoid direct exposure to beam.
- 3) **CAUTION:** Do not open the top cover. There are no user serviceable parts inside the Unit; leave all servicing to qualified service personnel.

CAUTION!

- CD-R/RW discs recorded using a personal computer or a CD Recorder may not play if the disc is damaged or dirty, or if there is dirt or condensation on the player's lens.
- Unfinalized CD-R/RW discs can be played, but not all time information (playing time, etc.) will be displayed.
- Check the copyright laws in your country before recording from DVD VIDEO, SVCD, Video CD, Audio CD, MP3 and JPEG discs. Recording of copyrighted material may infringe copyright laws.

Legal Notices Regarding Macrovision's Property Rights

"U.S. Patent Nos. 4,631,603; 4,577,216; 4,819,098; 4,907,093; and 6,516,132."

"This product incorporates copyright protection technology that is protected by U.S. patents and other intellectual property rights. Use of this copyright protection technology must be authorized by Macrovision, and is intended for home and other limited viewing uses only unless otherwise authorized by Macrovision. Reverse engineering or disassembly is prohibited."

Manufactured under license from Dolby Laboratories.
"Dolby" and the double-D symbol are trademarks of Dolby Laboratories.

"DTS" and "DTS Digital Out" are trademarks of Digital Theater Systems Inc.

This unit complies with the European Directives 89/336/EEC and 73/23/EEC.

The apparatus shall not be exposed to dripping or splashing. No objects filled with liquids, such as vases, shall be placed on the apparatus.

DISC INFORMATION

■ Playable Disc types

Disc Types	Logos	Characteristics
DVD-VIDEO		This unit can playback DVD-Video discs and the region code is printed on the rear of the unit.
DVD+R/+RW DVD-R/-RW		DVD-R, DVD-RW and DVD+R, DVD+RW, discs written in the DVD-Video format and finalized.
Video CD (VCD) Super Video CD (SVCD)		Video with CD sound, VHS quality, MPEG-1 & MPEG-2 compression technology.
Audio CD		CD is recorded as a Digital Signal with better audio quality, less distortion and less deterioration of audio quality over time.
CD-R/RW (JPEG/BMP/MP3)		This unit can play CD-R and CD-RW discs recorded with Audio CD or Video CD format, or with JPEG/BMP/MP3 files. Close the sessions or finalize the disc after recording.

■ Recordable Disc types

Disc Types	Logos	Characteristics
DVD+R/+RW		DVD+R disc written in the DVD+VR format. DVD+RW disc written in the DVD+VR format.
CD-R/-RW		CD-R/CD-RW disc written in the MPEG1 or MPEG2 video format or written in PCM Audio mode.

Note:

The DVD-Video/DVD+RW/DVD+R/DVD-R/DVD-RW Logos are trademarks of the respective companies.

For best results, use discs with the above logos. The unit may not playback other discs correctly. Do not use irregular-shaped discs (e.g. heart-shaped), as these can damage the unit.

It may not be possible to play CD-R, CD-RW, DVD-R, DVD-RW, DVD+R, DVD+RW in all cases due to the type of disc or condition of the recording.

Unplayable disc types

The unit does not play back disc type listed below. If you try to play back these discs, excessive noise may cause damage to your speakers.

1) Unfinalized discs from other DVD/CD recorders.

2) DVD AUDIO, PHOTO CD, SACD, HDCD

(When placing an unplayable disc on the disc tray, the DVD recorder will display "Unknown Disc" on the display panel after attempts of trying to loading the disc fail.)

■ Region code of DVD-Video

This unit can play back DVD-VIDEO discs compatible with the region code printed on the rear of the unit.

Example of playable DVD-VIDEO discs:



If you try to play any other discs, the message "Invalid Region Code" will appear on TV screen.

■ Audio System

DOLBY DIGITAL Dolby Digital Linear PCM

DTS (Digital Theater Systems)

■ Video System (PAL)

This DVD recorder accepts PAL system.

■ Aspect Ratio

LB 4:3 (Letter Box) Standard

4:3 4:3 Pan & Scan

16:9 16:9 (Wide-Screen)

■ Others

6 Audio : Appears at the beginning of a scene recorded with multiple audio languages.

3 Subtitle : Appears at the beginning of a scene recorded with multiple subtitle languages.

3 Angle : Appears at the beginning of a scene recorded from multiple angles.

CONTROLS AND DISPLAYS

Remote Control

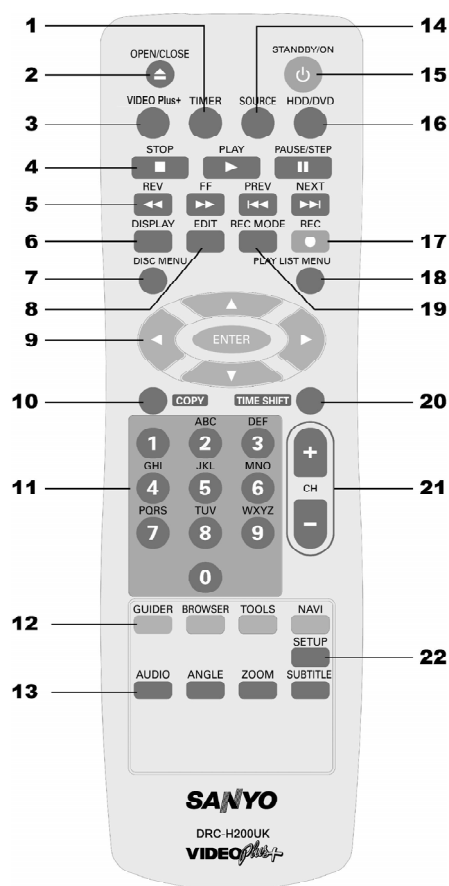

- 1) Timer button (TIMER)
- 2) Open / Close button (▲ OPEN / CLOSE)
- 3) VIDEO Plus+ button (VIDEO Plus+)
- 4) Stop button (■ STOP)
Play button (▶ PLAY)
Pause / Step button (|| PAUSE / STEP)
- 5) REV/ FF buttons (◀◀ REV / ▶▶ FF)
Skip buttons (◀◀ PREV / ▶▶ NEXT)
- 6) Display button (DISPLAY)
- 7) Disc Menu button (DISC MENU)
- 8) Edit button (EDIT)
- 9) Cursor (▲▼◀▶), Enter buttons (ENTER)
- 10) Copy button (COPY)
- 11) Number buttons (1~9,0)
- 12) Easy Guider Menu button (GUIDER)
Browser button (BROWSER)
Disc Tools button (TOOLS)
Navigation button (NAVI)
- 13) Audio button (AUDIO)
Angle button (ANGLE)
Zoom button (ZOOM)
Subtitle button (SUBTITLE)
- 14) Source button (SOURCE)
- 15) Power button (⏻ STANDBY/ON)
- 16) HDD/DVD button (HDD/DVD)
- 17) Record button (● REC)
- 18) Play List Menu button (PLAY LIST MENU)
- 19) Record Mode button (REC MODE)
- 20) Time shift button (TIME SHIFT)
- 21) CH Up / Down buttons (CH+ / CH-)
- 22) Setup button (SETUP)

To install batteries

- Open the battery compartment and insert the batteries. Make sure the polarities (+ and -) match the marks indicated inside the remote control.
- Do not use rechargeable type batteries.

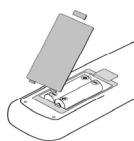

Remote sensor

The remote has a range of approximately 7M and works best when pointed directly at the unit horizontally at angles up to 30° from the front of the unit.

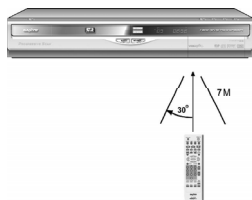

Do not dispose of the batteries in your domestic or any other waste bin! Instead, bring them to the nearest collection site, e.g. at your retail dealer or supermarket: you will find special collection boxes there for used batteries. All collected batteries will be recycled. Please help to conserve our environment. Thank you.

CONTROLS AND DISPLAYS

Front panel connections

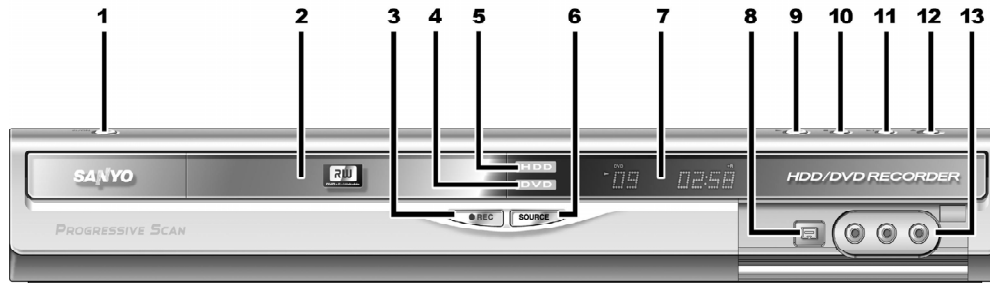

Names of parts and controls

- | | |
|---|--|
| <p>1) POWER ON/OFF Button (⏻/ON)
Turns the recorder on and off.</p> <p>2) DISC TRAY
Holds discs securely during recording or playback.</p> <p>3) RECORD Button (● REC)
Starts recording.</p> <p>4) DVD Indicator
Lights up when DVD is set as the playback/record device.</p> <p>5) HDD Indicator
Lights up when HDD is set as the playback/record device.</p> <p>6) SOURCE Button (SOURCE)
Selects equipment connected to the line inputs.</p> | <p>7) DISPLAY Window
Operation indicators are displayed here.</p> <p>8) DV IN Jack
Connects digital video camcorders to this DVD Recorder.</p> <p>9) OPEN/CLOSE Button (▲ OPEN / CLOSE)
Opens or closes the disc tray.</p> <p>10) PLAY Button (▶ PLAY)
Plays a disc.</p> <p>11) STOP Button (■ STOP)
Stops playing or recording a disc.</p> <p>12) HDD/DVD Button (HDD/DVD)
Press to switch between HDD and DVD.</p> <p>13) VIDEO IN/AUDIO IN L/R Jacks
Connect the output of external equipment.</p> |
|---|--|

Display window

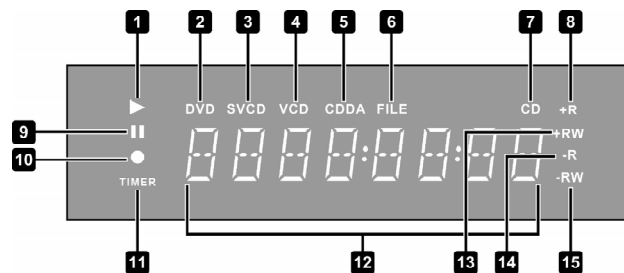

- | | |
|---|--|
| <p>1) Play indicator</p> <p>2) DVD indicator</p> <p>3) SVCD indicator</p> <p>4) VCD indicator</p> <p>5) CDDA indicator</p> <p>6) FILE indicator</p> <p>7) CD indicator</p> | <p>8) DVD+R indicator</p> <p>9) Pause indicator</p> <p>10) Record indicator</p> <p>11) Timer record mode</p> <p>12) Multi-information window</p> <p>13) DVD+RW indicator</p> <p>14) CD-R/DVD-R indicator</p> <p>15) CD-RW/DVD-RW indicator</p> |
|---|--|

CONTROLS AND DISPLAYS

Rear panel connections

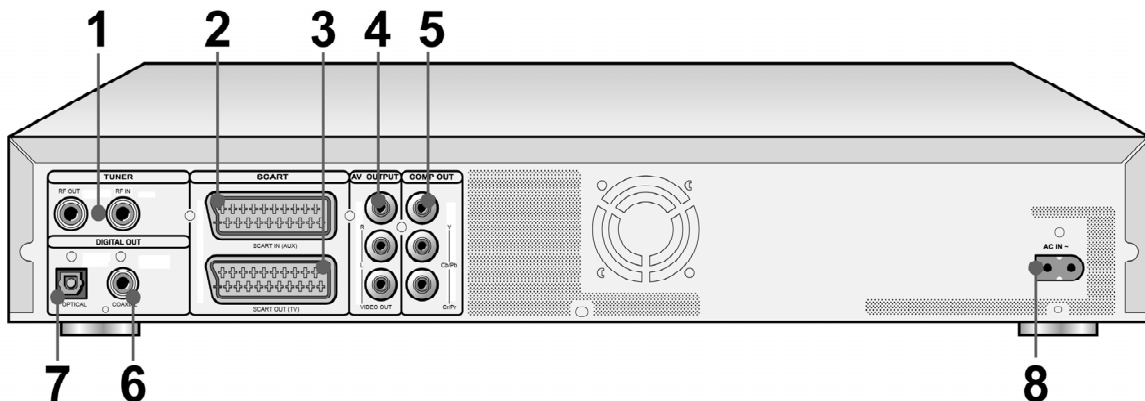

Names of parts

1) **TUNER(RF OUT/RF IN) Jacks**

Antenna cables input and output.

Note: DVD signals don't go through here. Make proper connections before use.

2) **SCART IN Jack**

Composite/RGB signal input.

3) **SCART OUT Jack**

Composite/RGB/S-Video signal output.

4) **AV OUTPUT Jacks**

Composite signal output.

5) **COMP OUT Jacks**

Component signal output.

6) **DIGITAL OUT (COAXIAL) Jack**

Connect to an amplifier or a receiver having a digital input jack.

7) **DIGITAL OUT (OPTICAL) Jack**

Connect to an amplifier or a receiver having a digital input jack.

8) **AC IN Terminal**

Connect the power cord.

CONNECTIONS

Before making connections

- 1) Do not plug the AC power cord into the outlet until all other connections are made.
- 2) Connect VIDEO OUT of the unit directly to the video input of your TV. Connecting VIDEO OUT of the unit to a TV via a VCR may cause a viewing problem when playing back a copy-protected disc. You may also have a viewing problem when connecting the unit to an integrated TV/Video system.

Connecting to the antenna outlet and the television

Before using the unit, follow the steps below to connect the unit to the antenna cable and TV.

Connecting to a TV with SCART jack

Use the antenna cable (supplied) to connect the RF IN on the unit to the antenna outlet.

Use the antenna cable (not supplied) to connect the RF OUT on the unit to the RF input on the television.

Use a SCART cable to connect the **SCART OUT** jack on the unit to the SCART IN jack on the television.

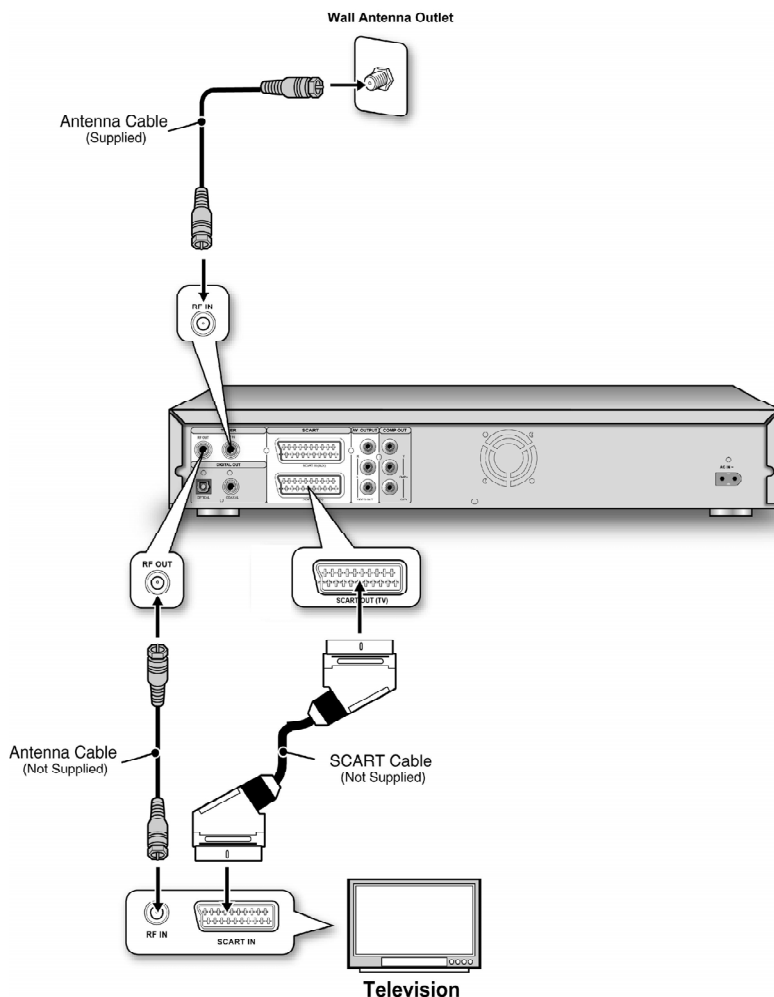

Notes:

1. Do not place this unit on top of other equipment that may generate heat. Excessive heat may cause this unit to malfunction.
2. For Digital Cable and Satellite TV users please connect your decoder's output to this unit's input.

FOR BETTER VIDEO QUALITY

If your TV has Component Video inputs, you can enjoy superior picture quality.

Connecting to a TV via COMPO OUT

Connecting to a TV with component jacks

Use COMPONENT cable (not supplied) to connect the **COMPO OUT** on the unit to the COMPONENT input on the television.

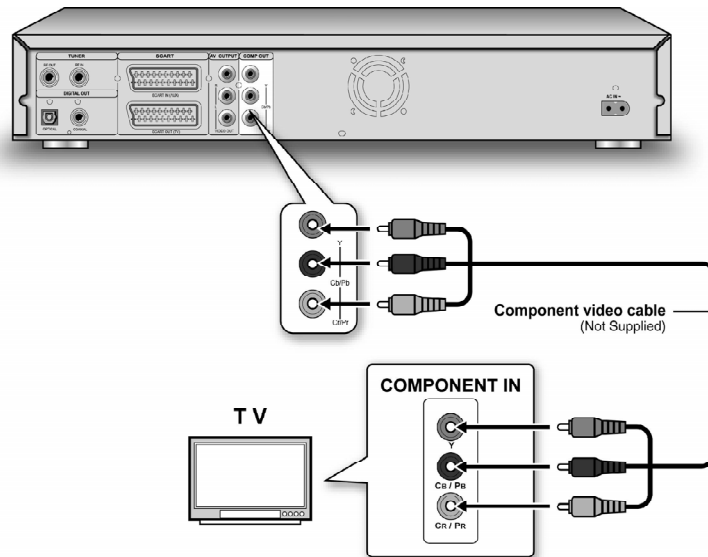

Notes:

1. Enter system setup to enable COMPO OUT (refer to the section titled "Quick Setup").
2. When using COMPO OUT connections, please remove all other video output connections.
3. In this configuration, the Red and White audio connections are required.

FOR BETTER AUDIO QUALITY

There are two types of audio connections, analog and digital.

Connecting to a stereo audio amplifier or receiver

Use an audio cable to connect the **L/R AV OUTPUT** on the unit to the audio inputs on a stereo amplifier or a receiver.

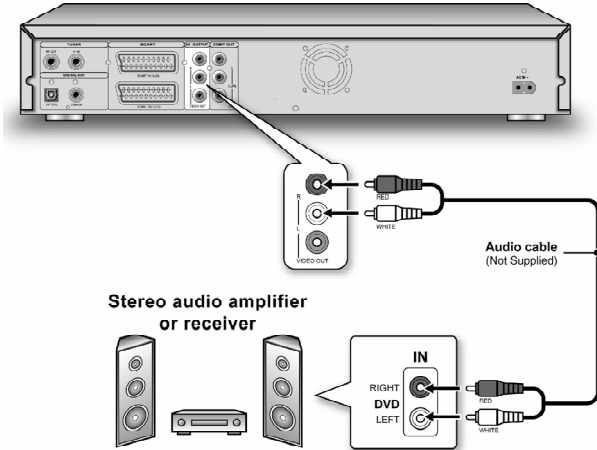

Connecting to a digital audio device

Connect an amplifier with Dolby Digital and DTS decoders to enjoy surround sound.

Digital out optical

Use an optical digital cable (not supplied) to connect the **DIGITAL OUT OPTICAL** (digital optical output) on the unit to the digital optical input on an stereo amplifier or a receiver.

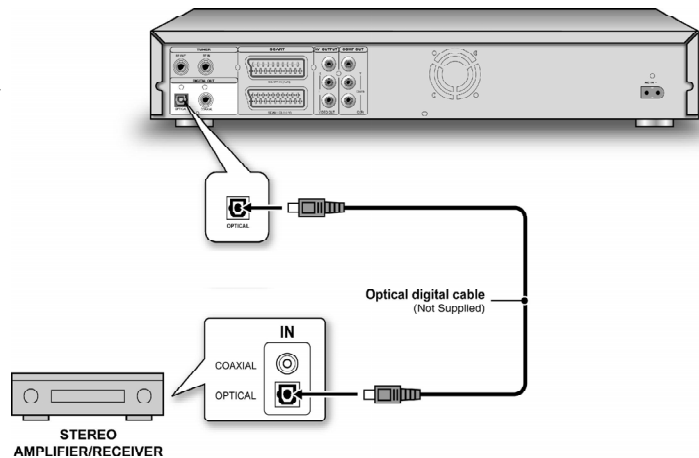

Digital out coaxial

Use a coaxial digital cable (not supplied) to connect the **DIGITAL OUT COAXIAL** (coaxial digital output) on the unit to the coaxial digital input on an stereo amplifier or a receiver.

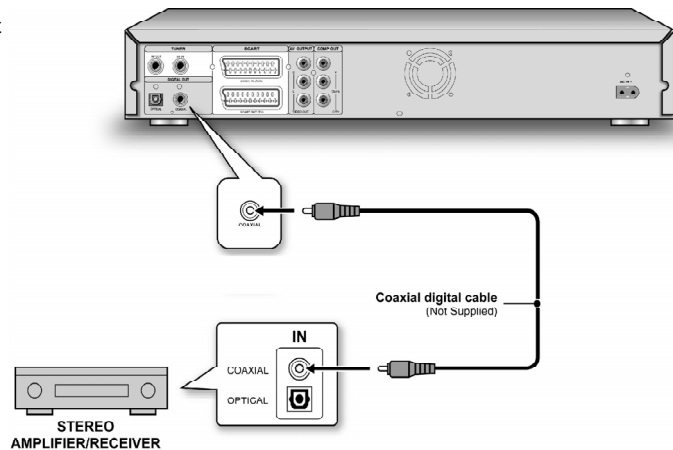

SETUP MENU

Remote Control & Setup menu

Follow the steps below to reset personal preferences for using the DVD recorder. Confirm that all connections are secured properly.

1. Press [STANDBY/ON] to turn on the unit.
2. Press [SETUP] to display the system menu.
3. Press [▲] [▼] to select "System," "Language," "Playback," "Record," "Audio," "TV Tuner" or "Exit" and press [◀] or [▶] to move to the next or previous menu.
4. Press [▲] [▼] to select the item you want to change.
(Refer to the "GUI operation" section for detailed menu)
5. Press [ENTER] to confirm the setting.
6. Press [SETUP] to exit the setup menu or press [◀] to return to the previous menu.

Notes:

1. To record TV programs using the Timer Record feature, you must set the time accurately.
2. Please see also "GUI(Graphical User Interface) Operation" on page 42/43 for further information.

Setting the date and time

Check that the clock is correctly set before initiating the timer recording function. If the clock is set incorrectly, Timer Record results may not be accurate.

Set the date

1. Press [SETUP] and the setup menu will be displayed.
2. Select "System" using [▲] or [▼] and press [ENTER].
3. Select "Date" using [▲] or [▼] and press [ENTER].
4. Change the day/month/year in the highlighted field using [▲] or [▼] or the numbered buttons (0~9) on your remote control and confirm by pressing [ENTER].
5. When all settings are correct, press [◀] to return to the main menu.
6. To exit the setup menu, press [SETUP].

Set the time

1. Press [SETUP]. The setup menu will appear.
2. Select "System" using [▲] or [▼] and press [ENTER].
3. Select "Time" using [▲] or [▼] and press [ENTER].
4. Change the "hour/minute/second" in the highlighted field using [▲] or [▼] or the numbered buttons (0~9) on your remote control.
5. When all settings are correct, press [◀] until returning to the main menu.
6. To exit the setup menu, press [SETUP].

Setting video output

1. Press [SETUP] and the setup menu will be displayed.
2. Select "System" using [▲] or [▼] and press [ENTER].
3. Select "Video Output" as "Scart S-Video," "Scart RGB" "Component" or "Progressive" using [▲] or [▼] and press [ENTER]. (Refer to "GUI operation" section for details)
4. When all settings are correct, press [◀] to return to the main menu.
5. To exit the setup menu, press [SETUP].

Progressive Scan mode

You can change the video output mode when you press [SETUP] and select "System-->Video Output-->Progressive."

Video output mode:

576i: Interlace video 576p: Progressive video



You must connect the component output on the unit to a 576p compatible television.

Note:

If you accidentally set "Progressive" as the Video Output when not connecting to a progressive scan-compatible TV, you may lose the video signal on your TV instantly. To get the picture back, press [▶] (Cursor Right) and the numbered buttons "5," "0," "2" and "0" on the remote control and then [ENTER]. In about 8 seconds, you can re-set the video output.

Setting Aspect ratio

Press [SETUP] and select "Playback"-->"Aspect Ratio."

Select "4:3" (regular) or "16:9" (widescreen) to suit your television. If you have a regular 4:3 television, you can also select how video title on some discs is presented.

4:3 L.Box (4:3 Letter Box)

Select when you connect the unit to a normal (4:3) TV.

When playing back a DVD-VIDEO disc recorded in wide picture format, the picture is shown with black bars at the top and bottom.



4:3 Pan (4:3 Pan & Scan)

Select when you connect the unit to a normal (4:3) TV.

When playing back a DVD-VIDEO disc recorded in wide picture format, the picture is zoomed to fill the screen vertically, and the left and right sides of the image are chopped off. Note, however, that the picture will be shown in the 4:3 L.Box (4:3 Letter Box) mode even if you select the 4:3 Pan (4:3 Pan & Scan) mode depending on the disc.



16:9 Wide (16:9 Wide Screen)

Select when you connect the unit to a wide-screen (16:9) TV.



Setting Audio

Press [SETUP] and select "Audio."

Digital Output

PCM Bit Stream

(Enable digital audio output with PCM or encoded data)

DTS Out

On / Off

Surround

Stereo DOLBY DTS

TV sound Bilingual

Main Sub

MPEG

PCM Bit Stream

Note:

When stereo broadcasting is received, L, R or MONO cannot be selected for output audio.

TV CHANNEL SETUP

TV channel scanning

When the "Scan Channel" function is activated, the TV channels are searched and stored in a specific order. If the channel assignment of your TV content provider is changed or if you are reinstalling this DVD recorder, you may need to start this procedure again. This will replace the TV channel stored with the new ones.

Before scanning channel, set the "TV Signal" and "Country" for initiation.

1. Ensure the antennas are securely connected to the DVD recorder.
2. Switch on the TV set and the DVD recorder.
3. Press [SETUP] to display the setup menu, press [▲] or [▼] to select the "TV Tuner" icon and press [▶].
4. Press [▲] / [▼] to select "TV Signal" and press [▶].
5. Press [▲] / [▼] to select "Cable," "Antenna" or "Auto" depending on how you receive your terrestrial TV channels and press [ENTER]. Press [◀] to return to the previous menu and save the setting.

If you select "Auto," the unit will automatically scan both channels available at cable and antenna connections, which might take longer than needed.

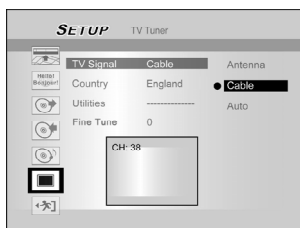

6. Press [▲] / [▼] to select "Country" and press [▶]. Press [▲] / [▼] and [ENTER] to select the country of your residence from the list. Press [◀] to return to the previous menu and save the setting.

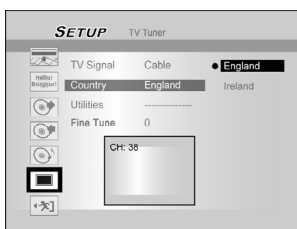

7. Press [▲] / [▼] to select "Utilities" and press [▶].
8. Press [▲] / [▼] to select "Scan Channel" and press [ENTER] to start channel scanning.

If you wish to stop scanning, move to "Stop Scan" and press [ENTER]. The scanning process will be discontinued.

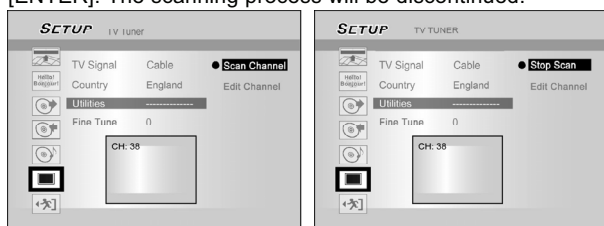

9. The channel scanning starts. This process may take a few minutes.

10. When all the TV channels have been searched and stored, press [SETUP] to exit.

Notes:

1. If the available channel number in your residence area exceeds the maximum receivable channel numbers of this DVD Recorder, the scan will be discontinued. The maximum receivable channel numbers are:
 - Antenna: 168 (chs)
 - Cable: 104 (chs)
 - Auto: 176 (chs)
2. It would take more time for auto channel scanning depending on the receiving condition of your antenna.

Fine-tuning TV channels manually

After you have performed the channel scanning, you may like to fine-tune the TV channel signal manually. Follow the steps below to complete fine tune.

1. Press [SETUP] to display the "Setup", press [▲] or [▼] to select the "TV Tuner" icon and press [▶].
2. Press [▲] or [▼] to select "Fine Tune" and press [▶].
3. Press [▲] or [▼] to fine-tune the channel signal.

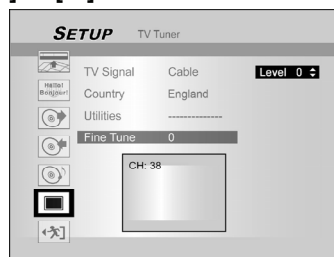

4. When complete, press [SETUP] to exit the setup menu.

Editing TV channels manually

After you have performed channel scanning, you may like to further edit the TV channels. This function allows manually adding/deleting channels, swapping channel order, inserting a channel to a specific order, renaming the channels and so on.

1. Press [SETUP] to display the "Setup", press [▲] or [▼] to select the "TV Tuner" icon and press [▶].
2. Press [▲] or [▼] to select "Utilities" and press [▶].
3. Press [▲] or [▼] to select "Edit Channel" and press [ENTER]. The CHANNEL EDITOR menu will be displayed.

For detailed operation instructions on the "Channel Editor" menu, refer to the "CHANNEL EDITOR" section.

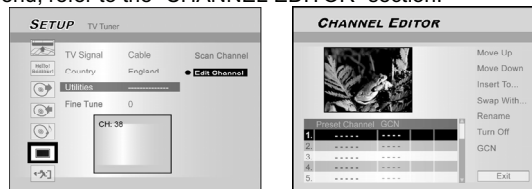

CHANNEL EDITOR

To access to the Channel Editor menu, press [SETUP], select "TV Tuner," "Utilities," "Edit Channel" and press [ENTER]. Or, press [SOURCE] to set "TV" as the input signal source and press [EDIT]. Either way, the Channel Editor menu will be displayed.

Moving up or moving down the TV channel

1. Press [▲] [▼] to select one of the TV channels and press [▶].
2. Press [▲] [▼] to select "Move Up" or "Move Down" and press [ENTER].

The order of the TV channel will be changed. Each time you press [▲] or [▼] and the item changes as follows:

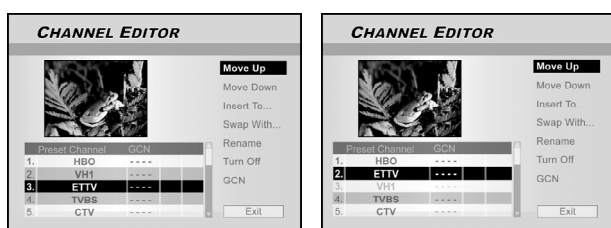

3. To move the location of other TV channels, repeat step 1~2 to complete the settings.
4. Press [◀] [▶] [▲] [▼] to select "Exit," press [ENTER] to save the setting and exit the "CHANNEL EDITOR" menu.

Inserting TV channels

1. Press [▲] [▼] to select a TV channels and press [▶].
2. Press [▲] [▼] to select "Insert To" and press [ENTER].
3. Press [◀] [▶] [▲] [▼] to enter the "Channel number," and press [ENTER]. The channel will be moved to the desired location.

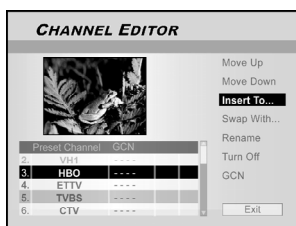
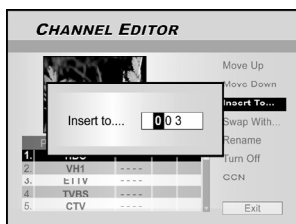

4. To change the locations of other TV channels, repeat step 1~3 to complete the settings.
5. Press [◀] [▶] [▲] [▼] to select "Exit," press [ENTER] to save the setting and exit the "CHANNEL EDITOR" menu.

Swapping TV channels

This function allows you to manually swap the TV channel order stored in the unit to match the TV channel order stored in your TV set.

1. Press [▲] [▼] to select a TV Channel and press [▶].
2. Press [▲] [▼] to select "Swap With" and press [ENTER].
3. Press [◀] [▶] [▲] [▼] to enter the "Channel number," and press [ENTER] to swap. The order of the channels will be swapped with the channel number entered.
4. To swap other TV channels, repeat step 1~3 to complete the settings.
5. Press [◀] [▶] [▲] [▼] to select "Exit," press [ENTER] to save the setting and exit the "CHANNEL EDITOR" menu.

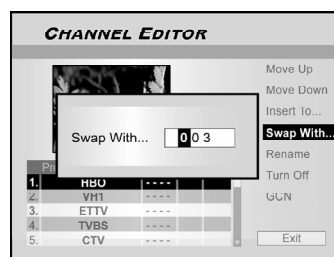

Renaming TV channels

1. Press [▲] / [▼] to select a TV channel and press [▶].
2. Press [▲] [▼] to select "Rename" and press [ENTER].
The display for entering a title name appears.
3. Select the desired characters from the keypad. Press [ENTER] after each entry.
4. When you finish entering the title name, press [◀] [▶] [▲] [▼] to select "Finish" and press [ENTER].



Notes:

1. You can only enter up to 10 characters for a name.
2. If you wish to enter "space", select a blank on the keypad and press [ENTER].

CHANNEL EDITOR

Turning on or turning off TV channels manually

After you have performed the channel scanning process, you may like to add or delete some of the TV channels. This function allows turning on the channel not found at channel scanning or turning off the channel found manually.

1. Press [▲] [▼] to select a TV Channel not found at channel scanning and press [▶].
2. Press [▲] [▼] to select "Turn On" and press [ENTER]. The TV channel selected will be turned on.

To turn off the TV channel, move to "Turn Off" and press [ENTER]. The TV channel selected will be turned off.

3. To turn on other TV channels, repeat step 1~2 to complete the settings.
4. Press [◀] [▶] [▲] [▼] to select "Exit," press [ENTER] to save the setting and exit the "CHANNEL EDITOR" menu.



Setting up VIDEO Plus+® system

Thanks to this programming system, you no longer need to tediously enter the date, programme number, start and end times. All the information needed by the DVD recorder for programming is contained in the VIDEO Plus+® programming number. This 9-digit PlusCode number is found in most TV listings magazines.

Before setting up, confirm that the all cables are securely connected.

Setting up the VIDEO Plus+® system

1. Press [SOURCE] to set TV as the input signal source.
2. Press [EDIT] to display the "CHANNEL EDITOR" menu.
3. Press [▲] [▼] to go to a channel and press [ENTER].
4. Press [◀] [▶] [▲] [▼] to go to "GCN" and press [ENTER].

The menu to enter GCN is displayed.

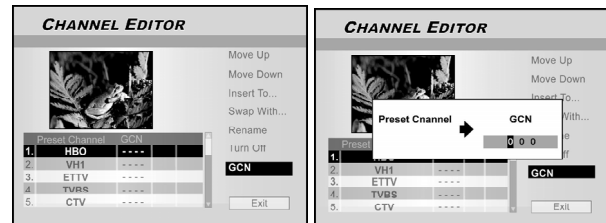

5. Use the numbered buttons (1~9) to enter the GCN and press [ENTER] when done.

Press [◀] [▶] to go back to advance/return to the previous/next digit.

6. To set GCN for other channels, repeat step 3~5.

7. When complete, press [▲] / [▼] to go to "Exit" and press [ENTER] to exit the channel editor menu.

PDC

"PDC" (program delivery control) are used to control the start and duration of TV channel recordings. If a TV program starts earlier or ends later than was scheduled, the DVD recorder will then turn on and off at the correct time. Refer to "Timer Record using the VIDEO Plus+ system" section for details about setting.

Notes:

1. You must enter the start time exactly to the minute. If you want to program a time that is different from the PDC time, you must switch off PDC.
2. Only on TV program of a TV channel can be controlled using "PDC" at a time. If you want to record two or more TV programs on a TV channel using "PDC," you need to program these as two separate recordings.
3. Since the DVD recorder requires a certain lead time for getting the disc up to speed and positioning the laser before recording can start, it is possible that the recorder will miss the first few seconds of a TV show recorded with PDC. In this case, disable PDC and enter a start time one minute earlier.

EASY GUIDER

Easy Guider menu is a unique user interface to guide you through basic functions of this recorder. By using the Easy Guider menu, it is less time-consuming to operate this system. Users no longer need to go through normal operations that may require far more steps and different interfaces.

Playback video files

1. Press [GUIDER] to display the Easy Guider menu.
2. Press [▲] [▼] to select "Playback" and then press [ENTER].

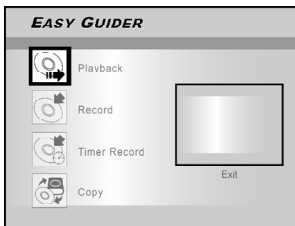

3. Press [▲] [▼] to select DVD or HDD and then press [ENTER].

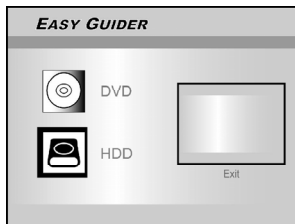

4. Press [▲] [▼] to select "Video" and press [ENTER].

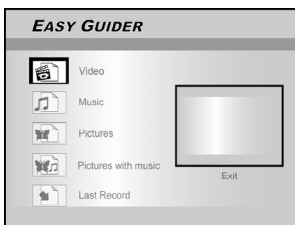

5. The selected file screen appears. Press [▲] [▼] [◀] [▶] to select a video file to start playback with and press [ENTER].

If you want to go to the next page or return to the previous page, you can select the [◀◀] [▶▶] icon or the page number icon.

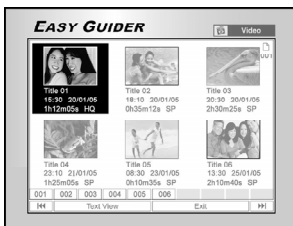

6. Press [|| PAUSE/STEP] to pause playback. Press [▶ PLAY] to resume normal playback. Press [■ STOP] to stop playback at a marked stop. Press [■ STOP] twice to bring the playback to a full stop.

Playback music files

1. Press [GUIDER] to display the Easy Guider menu.
2. Press [▲] [▼] to select "Playback" and then press [ENTER].
3. Press [▲] [▼] to select DVD or HDD and then press [ENTER].
4. Press [▲] [▼] to select "Music" and press [ENTER].



5. The selected file screen appears. Press [▲] [▼] [◀] [▶] to select a music file to start playback with and press [ENTER].

If you want to go to the next page or to the return previous page, you can select the [◀◀] [▶▶] icon or the page number icon.

6. Press [|| PAUSE/STEP] to pause playback. Press [▶ PLAY] to resume normal playback. Press [■ STOP] to stop playback at a marked stop. Press [■ STOP] twice to bring the playback to a full stop.

Playback picture files

1. Press [GUIDER] to display the Easy Guider menu.
2. Press [▲] [▼] to select "Playback" and then press [ENTER].
3. Press [▲] [▼] to select DVD or HDD and then press [ENTER].
4. Press [▲] [▼] to select "Pictures" and press [ENTER].



5. The selected file screen appears. Press [▲] [▼] [◀] [▶] to select a picture file to start playback with and press [ENTER].

If you want to go to the next page or return to the previous page, you can select the [◀◀] [▶▶] icon or the page number icon.

6. Press [|| PAUSE/STEP] to pause playback. Press [▶ PLAY] to resume normal playback. Press [■ STOP] to stop playback.

EASY GUIDER

Playback pictures with music

1. Press [GUIDER] to display the Easy Guider menu.
2. Press [▲] [▼] to select "Playback" and then press [ENTER].
3. Press [▲] [▼] to select DVD or HDD and then press [ENTER].
4. Press [▲] [▼] to select "Pictures With Music" and press [ENTER].

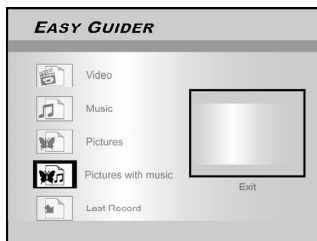

5. The selected file screen appears. Press [▲] [▼] [◀] [▶] to select a picture file to start playback with and press [ENTER].
6. Press [▲] [▼] [◀] [▶] to select a music file to start playback with and press [ENTER]. Playback will start.
7. Press [▲]/[▼] to select "Rotate RIGHT" or "Rotate LEFT" and "Rotate UP" "Rotate down." Press [◀] or [▶] to skip the picture. Press [▶▶] [NEXT] or [◀◀] [PREV] to skip the MP3 file.
8. Press [||] [PAUSE/STEP] to pause playback. Press [▶] [PLAY] to resume normal playback. Press [■] [STOP] to stop playback.

Playback the last recorded title (on HDD only)

1. Press [GUIDER] to display the Easy Guider menu.
2. Press [▲] [▼] to select "Playback" and then press [ENTER].
3. Press [▲] [▼] to select HDD and press [ENTER].
4. Press [▲] [▼] to select "Last Record" and press [ENTER].

Playback of the title last recorded on your HDD will begin.



5. Press [||] [PAUSE/STEP] to pause playback. Press [▶] [PLAY] to resume normal playback. Press [■] [STOP] to stop playback at a marked stop. Press [■] [STOP] twice to bring the playback to a full stop.

Record on the HDD

1. Press [GUIDER] to display the Easy Guider menu.
2. Press [▲] [▼] to select "Record" and then press [ENTER].

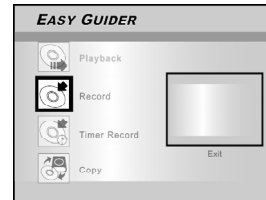

3. Press [▲] [▼] to select the Signal-Input (TV, AV1-front, AV2-rear, DV-in) and press [ENTER]. If you select "TV," press [▲] [▼] to select the channel you want to record and press [ENTER]. Press [▲] [▼] and [ENTER] to set the PDC mode off.

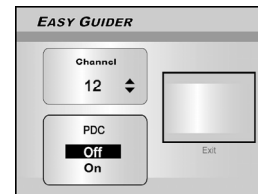

4. Press [▲] [▼] to select "HDD" and press [ENTER].

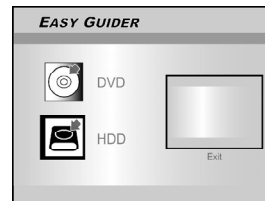

5. Press [▲] [▼] to select "Recording mode" and then press [ENTER].

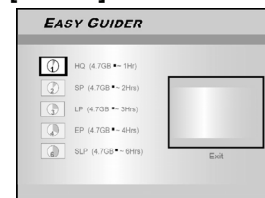

If you select "TV" in step 3, press [▲] [▼] to select the desired TV sound and press [ENTER].

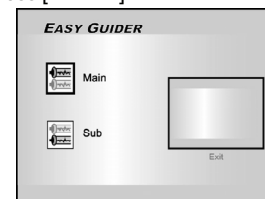

6. Press [ENTER] to start recording. Press [■] [STOP] to stop recording. Press [||] [PAUSE/STEP] to pause recording.

Notes:

1. You can press [GUIDER] to exit the Easy Guider menu.
2. Bilingual TV program which input through AV input terminal is recorded on DVD disc (HDD) as stereo TV program. When this title is played back, the both Main and Sub sound can be heard from the speakers. Please choose the desired sound which you want to enjoy on the TV side.
3. Stereo broadcasting is recorded by stereo and monaural one is recorded by mono.

EASY GUIDER

Record on DVD

Make sure a recordable disc is inserted before recording.

1. Press [GUIDER] to display the Easy Guider menu.
2. Press [▲] [▼] to select "Record" and then press [ENTER].

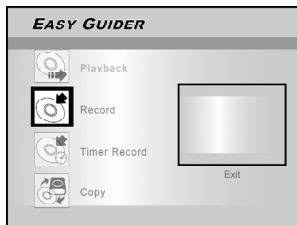

3. Press [▲] [▼] to select the Signal-Input (TV, AV1-front, AV2-rear, DV-in) and press [ENTER].
If you select "TV," press [▲] [▼] to select the channel you want to record and press [ENTER].
4. Press [▲] [▼] to select "DVD" and press [ENTER].
5. Press [▲] [▼] to select a disc format and press [ENTER].

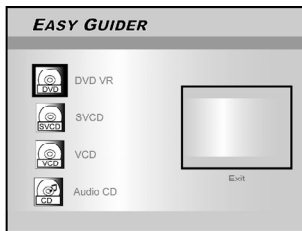

If you select "TV" in step 3, press [▲] [▼] to select the desired TV sound and press [ENTER].

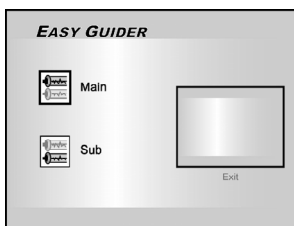

"Go !" is selected.

6. Press [ENTER] to start recording.
Press [■ STOP] to stop recording.
Press [II PAUSE/STEP] to pause recording.

Notes:

1. If a new recordable CD-R or a newly erased CD-RW is used for recording, press [◀] [▶] [▲] [▼] to select a disc format the disc is to be prepared as and press [ENTER]: SVCD, VCD, Audio CD or Data CD.
2. Stereo broadcasting is recorded by stereo and monaural one is recorded by mono.

Timer Record (Date/Time Setting)

1. Press [GUIDER] to display the Easy Guider menu.
2. Press [▲] [▼] to select "Timer Record" and then press [ENTER].

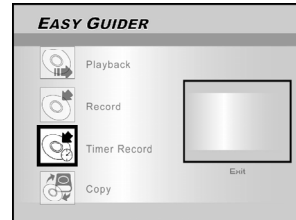

3. Press [▲] [▼] to select "Date/Time Setting" and press [ENTER].

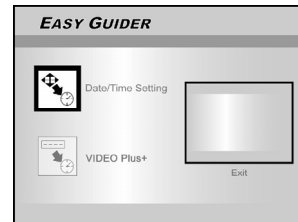

4. Press [▲] [▼] to select the Signal-Input (TV, AV1-front, AV2-rear, DV-in) and press [ENTER].
If you select "TV," press [▲] [▼] to select the channel you want to record and press [ENTER]. Press [▲] [▼] and [ENTER] to set the PDC mode on or off.

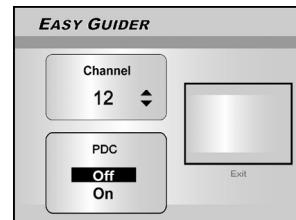

If you select "AV1-front or AV2-rear," press [▲] [▼] to set PDC mode on or off.

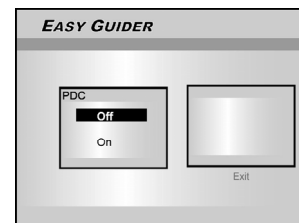

5. Press [▲][▼] to select "Once," "Daily," or "Weekly."

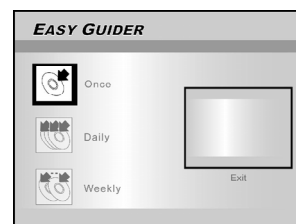

EASY GUIDER

6. Press [▲][▼] [◀] [▶] or the numbered buttons (0~9) to set the date and press [ENTER] when done.

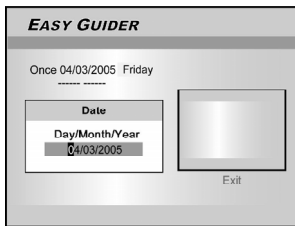

7. Press [▲][▼] [◀] [▶] or the numbered buttons (0~9) to set the time and press [ENTER] when done.

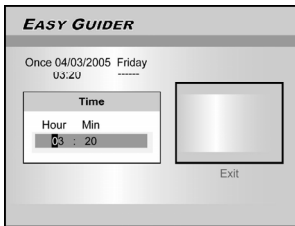

8. Press [▲][▼] to set "Length" and then press [ENTER].

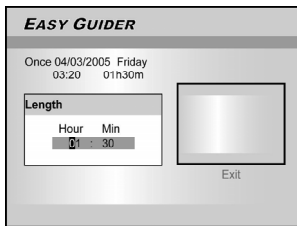

9. Press [▲][▼] to select "HDD" or "DVD" and then press [ENTER].

10. Press [▲][▼] to select a disc format and press [ENTER]. (For DVD disc only)

11. Press [▲] [▼] to select a recording mode and press [ENTER].

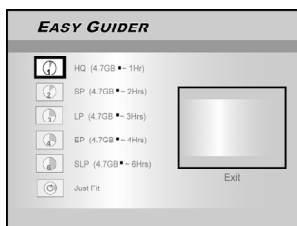

12. Press [▲] [▼] to select the desired TV sound and press [ENTER].

13. The "Timer Record information" will appear and press [ENTER] to exit the timer record settings.

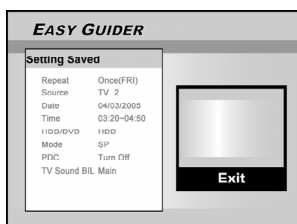

Note:

For Timer Record, there are six recording modes available: HQ, SP, LP, EP, SLP and Just Fit. When the recording mode is set to be "Just Fit," the recording mode will be automatically adjusted depending on how much recording space is available on the disc/HDD.

13. Press [⏻] [STANDBY/ON] to turn the recorder off to activate Timer Record function.

Note:

When you first play a recordable CD-R disc or an empty CD-RW disc on the disc tray, select a disc format the disc is to be prepared as: SVCD, VCD, Audio CD or Data CD. The format selected determines the recording quality.

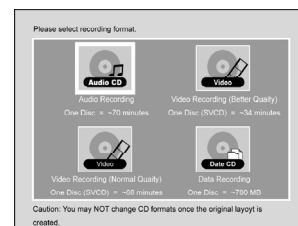

Timer Record (VIDEO Plus+® Setting)

1. Press [GUIDER] to display the Easy Guider menu.

2. Press [▲] [▼] to select "Timer Record" and then press [ENTER].

3. Press [▲] [▼] to select "VIDEO Plus+" and press [ENTER].

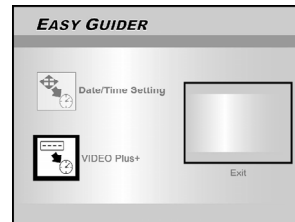

4. Press [▲] [▼] to select once, daily or weekly and press [ENTER].

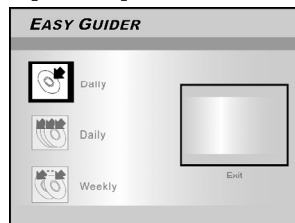

5. Use the numbered buttons to enter the PlusCode number and then press [ENTER]. Press [▲][▼] to set the PDC mode on or off and press [ENTER].

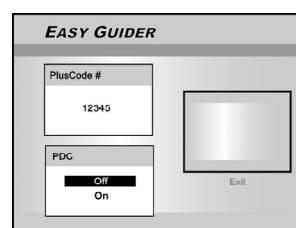

EASY GUIDER

6. After entering the PlusCode number, the “GCN” and “Present Channel” will be displayed. Press [ENTER] to preset the channel.

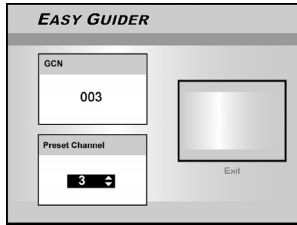

7. Press [▲][▼] to select “DVD” or “HDD” and then press [ENTER] .

8. Press [▲] [▼] to select a disc format and then press [ENTER].

If a CD-R or CD-RW is used for recording, you need to select SVCD, VCD or Audio CD. If a DVD disc is used for recording, you need to select “DVD VR” format.

9. Press [▲] [▼] to select “Recording mode” and then press [ENTER].

For CD-R/RW, the format selected determines the recording quality.

10. Press [▲] [▼] to select TV audio and press [ENTER].

11. The “Timer Record information” will be displayed. Press [ENTER] to exit the timer record settings for VIDEO Plus+®.

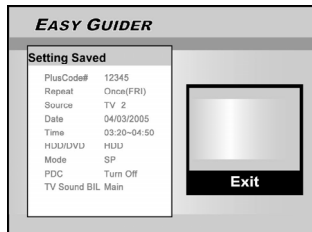

12. Press [⏻] STANDBY/ON] to turn the recorder off to activate Timer Record function.

Note:

When you first play a recordable CD-R disc or an empty CD-RW disc on the disc tray, select a disc format the disc is to be prepared as: SVCD, VCD, Audio CD or Data CD. The format selected determines the recording quality.

Copy (From HDD to DVD)

Press [▲ OPEN/CLOSE] to open the disc tray and insert a recordable DVD disc. Press the button again to close the tray.

1. Press [GUIDER] to display the Easy Guider menu.
2. Press [▲] [▼] to select “Copy” and press [ENTER].

Note:

You can only copy picture files (in JPEG or BMP formats), audio files (in MP3 or WAV format) and recorded video titles. Reference the “Copy” section for the right disc to use.

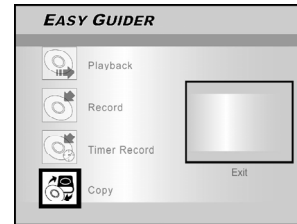

3. Press [▲] [▼] to select “HDD to DVD” and press [ENTER].

The disc preparation process will take place in the background. This process only takes a few moments.

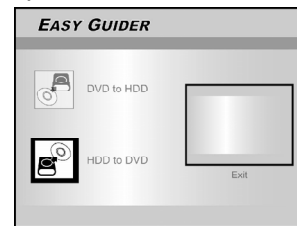

4. Press [▲] [▼] to select the type of the file: Video, Pictures or Music and press [ENTER].

5. The selected file screen appears. Press [▲] [▼] [◀] [▶] to select the file to copy and press [ENTER].

6. When complete, go to “Exit” and press [ENTER].

Copy (From DVD to HDD)

Press [▲ OPEN/CLOSE] to open the disc tray and insert a disc with recorded contents on it. Press the button again to close the tray.

1. Press [GUIDER] to display the Easy Guider menu.
2. Press [▲] [▼] to select “Copy” and press [ENTER].
3. Press [▲] [▼] to select “DVD to HDD” and press [ENTER].

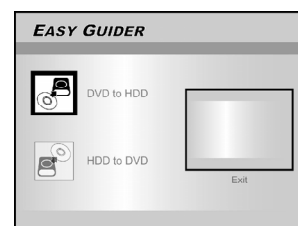

4. Press [▲] [▼] to select the type of the file: Video, Music, Pictures or All and press [ENTER].

5. Press [▲] [▼][◀] [▶] to select the file to copy and press [ENTER].

6. When complete, go to “Exit” and press [ENTER].

Notes:

1. You can only copy picture files (in JPEG or BMP formats), audio files (in MP3 or WAV format). Sanyo has no right to grant such permission. Permission should always be sought from the copyright owner.
2. The title of DVD-Video cannot be copied from DVD to HDD.

RECORDING

Before recording

Cautions:

1. This DVD recorder records on DVD+R/+RW, CD-R/RW discs and the built-in HDD. Please use recommended recordable discs to ensure the best recording quality.
2. DVD+R and CD-R are write-once discs.
3. DVD+RW and CD-RW are a re-writable discs.
4. You cannot add new recording sessions to DVD+R discs after the discs are finalized.
5. In some cases, you may not be able to add new recording (s) to a recordable DVD disc that contains contents written on other DVD recorders.
6. A disc records 49 video titles maximum. A title recorded on a DVD disc contains 99 chapter marks maximum. And a disc contains 254 chapter marks totally maximum.
7. A title recorded on the built-in HDD contains 999 chapter marks maximum.

Recording television programs

1. Press [STANDBY/ON] to turn the unit on.

2. Press [HDD/DVD] to set the target device as "HDD" or "DVD."

If "DVD" is selected as the target device, press [OPEN/CLOSE] to open the disc tray and insert a recordable disc. Press the button again to close the tray.

When you insert a new recordable DVD disc, the DVD recorder automatically starts the disc preparation process.

When you insert a new recordable CD-R or CD-RW disc, press [] [] [] [] to select the disc format the disc is to be prepared as.

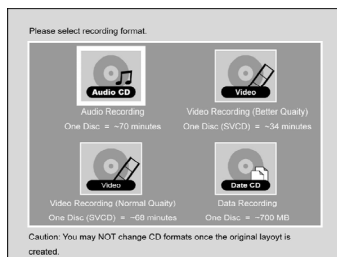

3. Press [REC MODE] continuously to select the desired recording quality.

HQ ↔ SP ↔ LP ↔ EP ↔ SLP

Press [SOURCE] and press [] [] to select "TV" as the signal-input source.

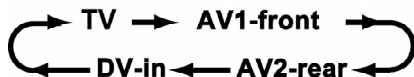

4. Press [CH + or -] or press [] [] to select the TV channel you want to record.



Note:

You can also use the numbered buttons to select a channel.

5. Press [REC] to start recording.

When recording is completed it may take a few moments for the session to close.



Recording continues until you stop the recording or when the disc or the HDD is full.

To stop recording

When you press [STOP], it may take a few moments for recording to stop and the session to close.



To pause recording

Press [PAUSE/STEP] to pause recording, and press [PAUSE/STEP] again to resume recording.



To change the recording mode before recording:

Press [SETUP] button.



To change the TV Audio setting before recording:

Press [SETUP] button.



Note:

The new setting can't change the current recording mode but will be activated during the next recording session.

To check the disc status while recording

Press [DISPLAY], the recording information appears.

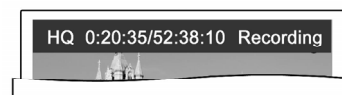

RECORDING

Adding new recordings

Adding new recordings after other recording sessions.

Press [● REC] to start recording, and press [■ STOP] at the point you want to stop.

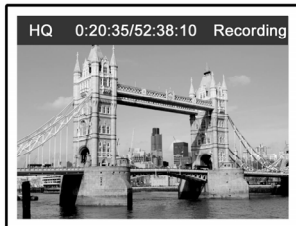

Note:

Each new recording session is placed after the previous session unless a certain recording title is set to be overwritten. (Reference the "Overwrite" function in the "Editing" section for additional details.)

Change Chapter Intervals

Creating chapters while recording

The DVD recorder can automatically divide a session into chapters by inserting chapter marks at 5/10/15/20/25/30-minute interval during the recording process.

1. Press [SETUP] to display the setup menu.
2. Press [▲] [▼] to select "Record" and press [▶].
3. Press [▲] [▼] to select "Chapter Mark" to set up the interval time.



4. Press [SETUP] to exit the setup menu.

Notes:

1. During recording, press [EDIT] to add chapter mark(s) in the recorded session manually.
2. You can also start recording using the "Easy Guider" Menu. Press [GUIDER], select "Record" and press [ENTER]. Follow the steps to set the recording mode.
3. Before you start, please ensure that the recordable disc or hard disk has enough available space for the recording session.
4. You cannot change the channel or recording mode during recording.

Playback the last recorded title (on HDD only)

Press [▶PLAY] or [GUIDER] to start the playback of the last recorded title.

This function is only available when the desired title resides on the HDD.

Using [▶PLAY]

1. Press [▶PLAY] and the last recorded title will start playback.

Using [GUIDER]

1. Press [GUIDER] and select the "Playback" icon.
2. Confirm that the playback device is HDD.
3. Press [▲] [▼] to go to the "Last Record" icon and press [ENTER]. The playback will start.

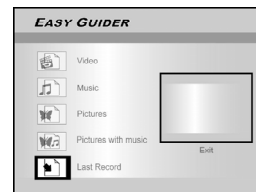
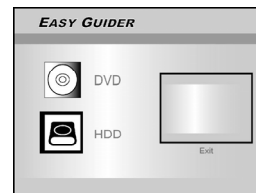
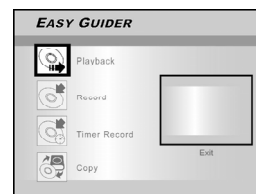

Notes:

1. If a power failure occurs, the program you are recording may be lost.
2. Before you start, please check that the recordable disc or hard disk has enough available space for the recording.
3. You can not change the recording mode during recording.
4. Before playing a DVD+R, CD-R, CD-RW disc on another player, you first need to **finalize** the disc.

RECORDING

Recording from a VCR or Camcorder

Before starting to record

This DVD recorder can accept standard CVBS (RCA) analog audio/video cable or IEEE-1394 cable and record Camcorder onto DVD in the digital video format of your choice. The unit functions much like a digital VCR. Examples of use include archiving videotapes or transferring from a Video Cassette Recorder or Camcorder to a recordable DVD disc or hard disk drive. This DVD recorder allows basic DV control with the DVD Recorder's remote control when connected via the DV Link.

The front panel and rear panel connection

Connect a Video Cassette Recorder or Camcorder to the unit's input terminals.

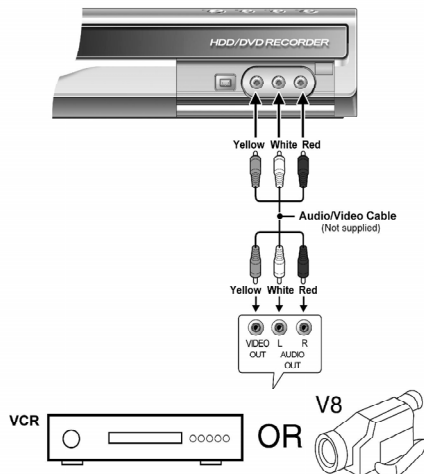
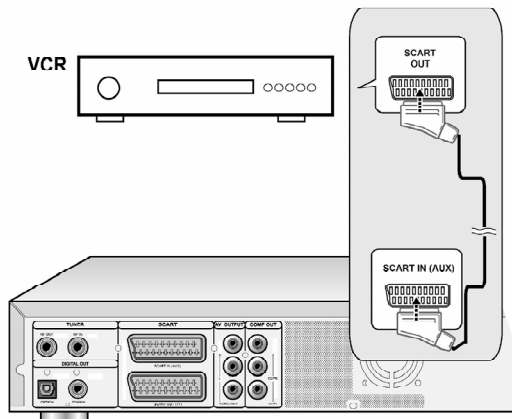

Note:

When connected to VCR or other external devices, there will be no outputting S-Video signal from the DVD recorder, if the DVD recorder is switched off.

To start recording

1. Press [HDD/DVD] to set the target device for the recording.

If "DVD" is set as the target device, press [▲ OPEN/CLOSE] to open the disc tray and insert a recordable DVD disc with the label side facing up.

If a new recordable CD-R or CD-RW is used for recording, press [◀] [▶] [▲] [▼] to select the disc format and press [ENTER].

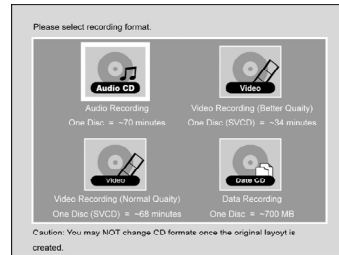

2. Press [SOURCE] to select the signal-input (TV, AV1-front, AV2-rear, DV-in).



3. Start to play on the VCR or Camcorder.

4. Press [● REC] on the DVD recorder to capture your video/audio signal from the VCR or Camcorder onto a recordable DVD disc or hard disk.



5. Press [■ STOP] to stop recording.

To pause recording

Press [|| PAUSE/STEP] to pause recording. If you want to restart recording, press [|| PAUSE/STEP] to resume recording.

RECORDING

One-touch recording

Use "One-touch recording" to start recording immediately in 30-minute blocks. Press [●REC] twice to start a 30-minute recording session. Press [●REC] repeatedly to record longer timed recordings, up to 6 hours in thirty-minute increments. Pressing [●REC] when the timed recording exceeds the 6-hour constraint automatically sets "one-touch recording" off. For recording on DVD discs, the length of recording depends on the current recording mode/speed and the amount of time available on the disc. For recording on the built-in HDD, the length of recording is 6 hours maximum.

DV recording

Before you start to record DV contents

This DVD recorder allows basic DV control functions with the remote control. The DVD recorder is equipped with a camcorder control (Play, Stop, FF or REV) feature via the DV Link connection. Simply move the screen cursor to the desired function on the DV input screen and press [ENTER] on the remote control.

Use "Easy Guider" Menu to record DV signal

If you are to record DV signals on a disc, press [▲ OPEN/CLOSE] to open the disc tray and insert a recordable disc. If a new recordable CD-R or CD-RW is used for recording, press [◀] [▶] [▲] [▼] to select the disc format the disc is to be prepared as and press [ENTER].

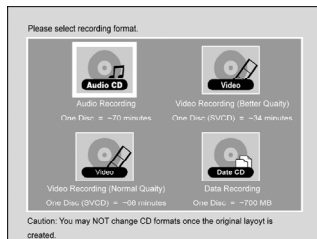

1. Power on your TV and this DVD recorder.
2. Connect the DV cable (IEEE-1394 4-pin to 4-pin cable) to both the DV Camcorder and the DVD-Recorder.

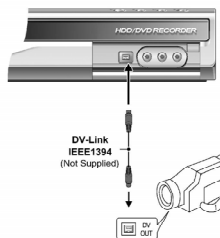

3. Power on the DV Camcorder. Start "Playback mode" on the DV Camcorder.
4. "Pause" the DV Camcorder at where you want to record.
5. Press [GUIDER] on the remote control. This activates the Easy Guider menu.
6. Press [▲] [▼] to select the "Record" icon, and press [ENTER] to start recording.

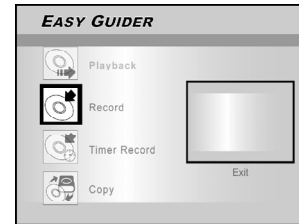

7. Press [▲] [▼] to select "DV" Input, and press [ENTER] to confirm.

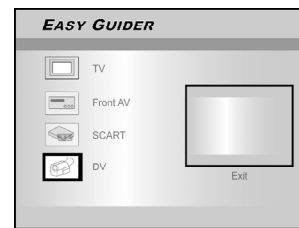

8. Press [▲] [▼] to select a recording mode and press [ENTER]. (For DVD disc or HDD only)

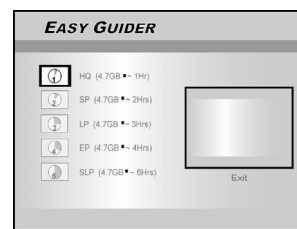

9. "Go!" is selected. Press [ENTER] to start recording.

Note:

This DVD-Recorder will stay in "Pause" mode when no DV input signal is detected.

10.To pause recording.

Press [|| PAUSE/STEP] on the remote control to pause recording. Press [|| PAUSE/STEP] again, if you want to resume recording.

11.To stop recording.

Press [■ STOP]

Note:

Before playing a DVD+R disc on another player, you will first need to finalize the disc. Reference the "finalize" function in the "Disc Tools" section for additional information.

RECORDING

DV Recording -- One-Touch Recording

Before you start to record DV contents

This unit allows basic DV control on screen. The on screen functions are accessed using the DVD recorder remote control.

1. Power on your TV and this DVD recorder.
2. Press [HDD/DVD] to set the target device for the recording.

If "DVD" is set as the target device, press [▲ OPEN/CLOSE] to open the disc tray and insert a recordable disc with the label side facing up.

If a new recordable CD-R or CD-RW is used for recording, press [◀] [▶] [▲] [▼] to select the disc format. The disc is to be prepared as and press [ENTER].



3. Connect the DV Cable (IEEE-1394 4-pin to 4-pin cable) to both the DV Camcorder and this DVD recorder.
4. Power on the DV Camcorder. Set "Playback mode" on the DV Camcorder.
5. "Pause" the DV Camcorder at where you want to record.
6. Press [SOURCE] to change the "Signal-Input source" and select the "DV-in" input.

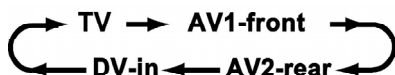

7. Resume DV Camcorder playback and press [● REC] on the DVD Recorder to start recording.

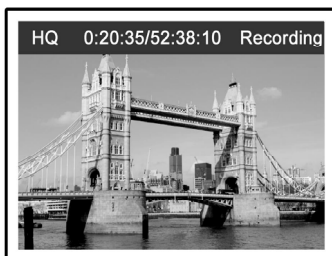

8. To pause recording.

Press [|| PAUSE/STEP] on the remote control to pause recording. Press [|| PAUSE/STEP] again, if you want to resume recording.

9. To stop recording.

Press [■ STOP] to stop recording.

DV control

After recording is stopped, a DV control bar will appear on the screen. This allows basic DV control utilizing this DVD recorder's remote control.



1. Press [◀] [▶] to select "▶" and press [ENTER] to start the DV Camcorder playing.
2. Press [◀] [▶] to select "▶▶" and press [ENTER] during playback mode to forward search the DV Camcorder.
3. Press [◀] [▶] to select "◀◀" and press [ENTER] during playback mode to backward search the DV Camcorder.
4. Press [◀] [▶] to select "■" and press [ENTER] during playback mode to stop the DV Camcorder playing.
5. Press [◀] [▶] to select "||" and press [ENTER] during playback mode to pause the DV Camcorder playing.

Notes:

1. The DV-Link input jack on this unit is for use with DV compatible camcorders only.
2. Only DV signals can be input to the DV-Link jack on this DVD recorder.
3. Do not connect a MICRO MV format video camcorder to this DV-Link (IEEE-1394) jack.

RECORDING

Record on a CD-R/CD-RW disc

Before starting to record

The DVD recorder can also record video in either VCD/ SVCD or Audio CD format on CD-R/RW discs. Before you start to record, please use qualified recordable disc to ensure the best recording quality.

Note:

Ensure to prepare the disc in the desired disc format before you started to record.

Creating a correct disc format

1. Press [**▲** OPEN/CLOSE] to open the disc tray and insert a recordable CD-R or CD-RW disc with the label side facing up.
2. Press [**◀**] [**▶**] [**▲**] [**▼**] to select the disc format. The disc is to be prepared as and press [ENTER].
3. The disc preparation process will start. When done, the disc is ready to be used for recording.

Create the disc format using the Disc Tools menu

1. Press [TOOLS] to display the "DISC TOOLS" menu, press [**▲**] [**▼**] to select the "Erase" icon and then press [ENTER].



Recording mode (on an empty 700MB disc)

Recording Mode	Recording Time (on empty 700MB disc)
VCD	68 minutes
SVCD	34 minutes
Audio CD	70 minutes

2. Press [**▲**] [**▼**] to select the desired recording format. "Go!" is selected and then press [ENTER].
3. When the disc is well-prepared, select the "Exit" icon and press [ENTER] to exit the erase menu.

VCD/SVCD recording

1. Place a prepared CD-R or CD-RW disc onto the tray with the disc's label facing up.
2. Press [GUIDER] to display the Easy Guider menu, press [**▲**] [**▼**] to select "Record" and then press [ENTER].
3. Press [**▲**] [**▼**] to select the signal-input (TV, AV1-front, AV2-rear, DV-in) and press [ENTER].
4. Press [**▲**] [**▼**] to select VCD or SVCD as the desired recording format and then press [ENTER].
5. Press [**▲**] [**▼**] to select the desired TV Sound and then press [ENTER].

Notes:

- 1.You can't perform any record before the CD-R/CD-RW disc is prepared.
- 2.Only single format is allowed on a single disc.
- 3.You can't change the format of CD-R disc after preparing it.
- 4.To change the format of the CD-RW disc, you must use the "Erase" function at the "DISC TOOLS" menu.
- 5.All contents in the disc will be deleted after erasing it.
- 6.You must finalize the disc before you can playback the disc on other DVD / VCD / SVCD player or DVD-ROM on PC.

6. "Go!" is selected. Press [ENTER] to record your signal onto the disc.

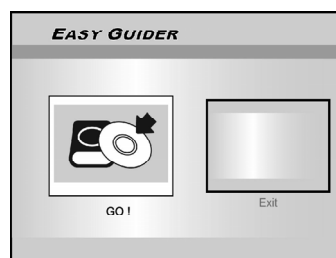

7. Press [**■** STOP] to stop recording.

To pause recording

Press [|| PAUSE/STEP] to pause recording, and if you want to restart recording, press [|| PAUSE/STEP] again or [● REC].

Audio CD recording

1. Place a well-prepared CD-R / CD-RW disc onto the tray with the disc's label face up.
2. Press [GUIDER] to display the Easy Guider menu, press [**▲**] [**▼**] to select "Record" and then press [ENTER].
3. Press [**▲**] [**▼**] to select the audio signal input (TV, AV1-front, AV2-rear, DV-in) and press [ENTER].
4. Press [**▲**] [**▼**] to select "Audio CD" as the desired recording format and then press [ENTER].
5. Press [**▲**] [**▼**] to select the desired TV Sound and then press [ENTER].
6. "Go!" is selected. Press [ENTER] to record your audio signal into a recordable CD disc.
7. Press [EDIT] to create a new audio track into disc during recording.
8. Press [**■** STOP] to stop audio recording.

Notes:

- 1.Single press of [EDIT] key will automatically create a new audio track by 2 sec interval.
- 2.Audio source input during these 2 sec will be recorded onto the beginning of the next track.
- 3.You must finalize the disc before you can playback the disc on other Audio CD / DVD / VCD / SVCD player or CD / DVD-ROM on a PC.

TIMER RECORD

Prior to timer record

Please ensure that the recordable disc or the HDD has enough available space for the Timer Record function. Before you start to record, follow the steps to set the date, time, picture quality and channel of the program or input source manually. You can set up 16 individual sessions in the Timer Recording function.

Setting the timer

1. Press [⏻ STANDBY/ON] to turn the unit on.
2. Press [TIMER] to display the "TIMER RECORD" menu.

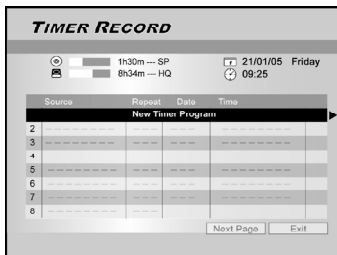

3. Press [▲][▼] to select an item from the timer setting list and press [ENTER] to activate the system setup menu for the Timer Record function.



4. Press [◀] [▶] [▲][▼] to select "Source (Signal Source)," and then press [ENTER] to bring up the list.

Press [▲] [▼] and [ENTER] to make your selection.

5. Press [◀] [▶] [▲][▼] to select "Channel (TV Channel)," and then press [ENTER] to bring up the list. This step only applies when the "TV" is selected as the source.

Press [▲] [▼] and [ENTER] to make your selection.

6. Press [◀] [▶] [▲][▼] to select "HDD/DVD," and then press [ENTER] to bring up the list.

Press [▲] [▼] and [ENTER] to make your selection.

7. Press [◀] [▶] [▲][▼] to select "Mode (Recording Quality)," and then press [ENTER] to bring up the list.

Press [◀] [▶] [▲] [▼] and [ENTER] to make your selection.

Recording quality for timer recording on DVD discs and HDD:

HQ <-> EP <-> LP <-> SP <-> SLP <-> Just Fit

Recording quality for timer recording on CD discs:

Audio CD <-> VCD <-> SVCD

8. Press [◀] [▶] [▲][▼] to select "Repeat (Once, Daily or Weekly)," and then press [ENTER] to bring up the list.

If you select "Once," you need to set the date. Move the cursor to highlight "date" and press [ENTER]. Use the numbered buttons (0~9) or [▲] [▼] [◀] [▶] to enter the date.



If you select "Daily," you do not need to set the date since the Timer Record is set for each day until the timer recording item is cancelled or the media is full.



If you select "Weekly," a weekly calendar will display on-screen for you to select the day. Press [▲] [▼] [◀] [▶] to move the cursor to highlight the desired day and press [ENTER] to make your selection. When completed, move the cursor to "OK" and press [ENTER] to save the desired setting.



Note:

If the mode is set as "Daily" or "Weekly," press [◀] [▶] [▲] [▼] to move the highlighted cursor to the "Advanced" icon and press [ENTER]. You can choose to apply the setting "Without Restriction" or "With Restriction." When "With Restriction" is selected, enter the "Start" date and "End" date to set the period of time for a valid setting. Move the highlighted cursor to "OK" and press [ENTER] to confirm the setting or to "Cancel" and press [ENTER] for resetting.



TIMER RECORD

9. Press [◀] [▶] [▲] [▼] to select “Start (Start Time),” and then press [ENTER].

Use the numbered buttons (0~9) or press [▲] [▼] [◀] [▶] to enter the start time.

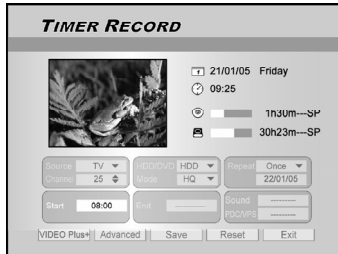

10. Press [◀] [▶] [▲] [▼] to select “End (End Time),” and then press [ENTER].

Use the numbered buttons (0~9) or press [▲] [▼] [◀] [▶] to enter the end time.



If you enter a wrong selection

Press [◀] [▶] to re-select the item you want to change.

11. Press [◀] [▶] [▲] [▼] to select “Sound (TV Sound BIL)” and then press [ENTER] to bring up the list.

12. Press [◀] [▶] [▲] [▼] to select the “PDC” and then press [ENTER] to set it on or off.

Press [▲] [▼] and [ENTER] to make your selection.

13. Press [▲] [▼] to select “OK” and press [ENTER] to save the setting for the timer record item and go back to the Timer Record list.

Press [◀] to [Reset] if you want to reset the timer record item.

14. Press [▲] [▼] to go to another item on the list and press [ENTER] if you want to set up for more Timer Record programs.

If not, move to the “Exit” icon and press [ENTER] or press [TIMER] to exit the Timer Record List.

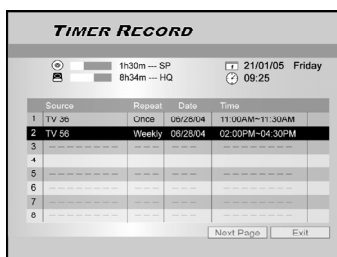

15. Press [⏻ STANDBY/ON] to turn off the unit and activate the “Timer Record” function.

To stop recording during Timer Record

When you press [■ STOP], it may take a few seconds for the record to stop.

To check the recording status while Timer Record is active

Press [DISPLAY] and the Timer Record information appears on-screen.

Notes:

- When the Timer Record function is active, the “TIMER LED” on the DVD Recorder front panel will illuminate.
- The DVD recorder must be turned off to activate the Timer Record function.
- Make sure that a recordable DVD disc or a well-prepared CD-R/RW disc is placed before the scheduled time, corresponding to the selected recording quality.

Timer Record using the VIDEO Plus+® system

1. Press [⏻ STANDBY/ON] to turn the unit on.

2. Press [TIMER] to display the “TIMER RECORD” menu.

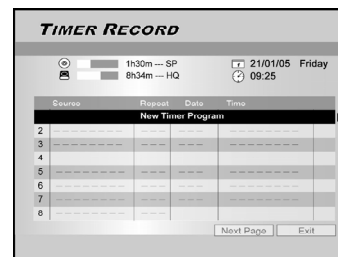

3. Press [▲] [▼] to select an item from the timer setting list and press [ENTER] to activate the setup menu for the Timer Record function.

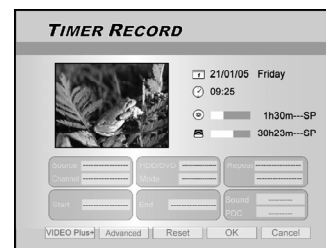

4. Press [◀] [▶] [▲] [▼] to select “VIDEO Plus+” and then press [ENTER] to bring up setup menu.

Or press [VIDEO Plus+] to bring up the VIDEO Plus+ menu.

5. Press [◀] [▶] [▲] [▼] to select “Repeat (Once, Daily or Weekly),” and then press [ENTER] to bring up the list.

Press [▲] [▼] [◀] [▶] and [ENTER] to make your selection.

TIMER RECORD

6. Press [◀] [▶] [▲][▼] to select “PlusCode# (PlusCode number),” and then press [ENTER] to enter the number.

Use the numbered buttons (0~9) or [▲][▼][◀] [▶] to enter the PlusCode number.

Note:

If the Preset Channel of this GCN is not set, the following screen will appear. Use the numbered buttons (0~9) or [▲][▼][◀] [▶] to enter the Preset Channel and press [ENTER] to confirm.

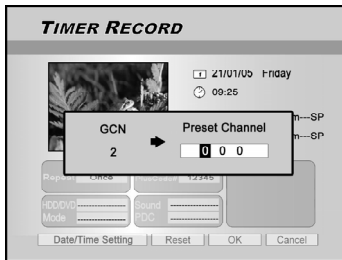

7. Press [◀] [▶] [▲][▼] to select “HDD/DVD,” and then press [ENTER] to bring up the list.

Press [▲] [▼][◀] [▶] and [ENTER] to make your selection. If “DVD” is set as the target device, press [▲ OPEN/CLOSE] to open the disc tray and insert a recordable DVD disc.

8. Press [◀] [▶] [▲][▼] to select “Mode (Recording Quality),” and then press [ENTER] to bring up the list.

Press [▲] [▼][◀] [▶] and [ENTER] to make your selection. Press [◀] [▶] to re-select the item you want to change.

Recording quality for timer recording on DVD discs and the HDD:

HQ <-> EP <-> LP <-> SP <-> SLP <-> Just Fit

Recording quality for timer recording on CD discs:

Audio CD <-> VCD <-> SVCD

9. Press [◀] [▶] [▲][▼] to select “Sound (TV Sound BIL)” and then press [ENTER] to bring up the list.

10. Press [◀] [▶] [▲][▼] to select “PDC” and then press [ENTER] to set it on or off.

Press [▲] [▼][◀] [▶] and [ENTER] to make your selection.

11. Press [▲][▼] to select “OK” and [ENTER] to save the setting or the timer record item and go back to the Timer Record list.

Press [◀] to [Reset] if you want to reset the timer record item.

12. Press [▲] [▼] to go to another item on the list and press [ENTER] if you want to set up for more Timer Record programs.

If not, move to the “Exit” icon and press [ENTER] to exit the Timer Record List.

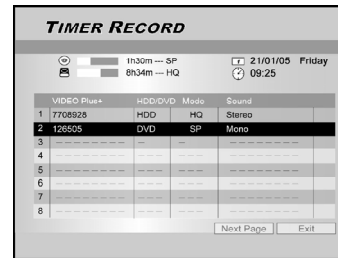

13. Press [⏻ STANDBY/ON] to turn off the unit and activate the “Timer Record” function.

Notes:

1. When the Timer Record function is active, the “TIMER LED” on the DVD Recorder front panel will illuminate.
2. The DVD recorder must be turned off to activate the Timer Record function.
3. Make sure that a recordable DVD disc or a well-prepared CD-R/RW disc is placed before the scheduled time, corresponding to the selected recording quality.
4. When “Once” timer recording is set, it cannot be changed to “Weekly” timer recording. Select “Weekly” first in case of “Weekly” timer recording.

TIME SHIFT

The "Time Shift" feature allows you to "Pause Live TV" and resume viewing at the point of interruption, at your leisure.

Note: "Pause Live TV" is constrained within 3 hours.

Pausing Live TV Broadcast

1. Press [⏻ STANDBY/ON] to turn the unit on.
2. Switch on your TV and set the video input to this recorder.
3. Press [CH + or -] buttons on the recorder's remote control to select the desired channel.

Since the TV's video input is set to be the recorder, channel selection HAS to be made with the recorder's remote control. To turn the audio volume up and down, use the TV's remote control.

4. When you choose to leave your TV and must stop watching, press [TIME SHIFT].

When [TIME SHIFT] is pressed the video broadcast on TV is set in pause mode. The scene displayed on the TV is the last picture shown when you press [TIME SHIFT].



5. When you are back in front of the TV and ready to resume viewing, press [▶PLAY] and the TV program will begin playing starting from the interrupted scene.
6. Press [▶▶FF] or [◀◀REV] to perform fast-forward or fast rewind scanning (to the point where [TIME SHIFT] begins). Press [⏸ PAUSE/STEP] to pause viewing. Press [⏸ PAUSE/STEP] again if you want to resume viewing.
7. Press [TIME SHIFT] to turn the time shift function off and switch to viewing live TV broadcast.

Record and Play

Follow the steps below to start playback of the recorded program/Timer Record program before the recording is scheduled to end.

1. During recording/Timer Record on the HDD, press [▶PLAY].

Playback will start from the beginning of the recorded program.



2. Press [▶▶FF] or [◀◀REV] to perform fast-forward or fast rewind scanning. Press [⏸ PAUSE/STEP] to pause playback. Press [⏸ PAUSE/STEP] again if you want to resume viewing.



- Press [■ STOP] to stop playback/viewing.



Note:

If you press [■ STOP] again, the recording function will be turned off.

3. If you want to stop recording, press [■ STOP] for a second time.



Note:

Record and Play only functions when the contents are to be recorded on the HDD.

PLAYBACK

DVD/VCD/SVCD video disc playback

Before you begin to enjoy the digital world of audio and video on DVDs, please ensure that you have made the correct settings in the Setup menus. These settings should correspond to the capabilities of your home system. Having made the correct settings, you are now ready to use the DVD recorder to enjoy DVDs, Video CDs, and CDs.

Basic playback

Turn on the television and select the appropriate video input on the television to suit the connections for the player.

■ Press [STANDBY/ON] to turn on the unit.

Press to turn the unit on or off.

■ Press [OPEN/CLOSE] to open the disc tray. Place the disc in the tray, label-side up.

■ Press [PLAY] to start playback.

■ Press [FF] to perform fast forward scanning.

Press repeatedly to play the disc forward at 2x, 4x, 8x, or 16x speeds.



■ Press [REV] to perform fast reverse scanning.

Press repeatedly to play the disc reverse at 1x, 2x, 4x, 8x, or 16x speeds.

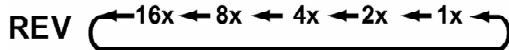

■ Press [NEXT] to advance to the next chapter/track.

Press repeatedly to skip to the next chapter during playback.

■ Press [PREV] to reverse to the previous chapter.

Press repeatedly to return to the beginning of previous chapters during playback.

■ Press [PAUSE/STEP] to pause playback.

■ Press [PAUSE/STEP] again to start “frame by frame mode.”

Press repeatedly to advance DVDs and Video CDs frame by frame during playback in pause mode. Press [PLAY] to restart normal playback.

■ Press [BROWSER] to browse the contents of a DVD disc or the HDD.

■ Press [HDD/DVD] to select HDD or DVD to playback the contents saved.

■ Press [STOP] to stop playback.

At a marked stop, press [PLAY] to resume playback. Press [STOP] twice to bring the playback to a full stop. Press [PLAY] to start playback from the beginning of the disc.

■ Press [DISPLAY] to display disc status during playback.

■ Press [DISC MENU] to display the thumbnail icons menu on the TV screen.

Press to return to the DVD's title or disc root menu for the current title during playback.

VCD

SVCD

Press [0, 1~9] the numbered buttons to select an item of the title menu.

DVD

Press [] [] [] [] to select an item and press [ENTER].

DVD TITLE

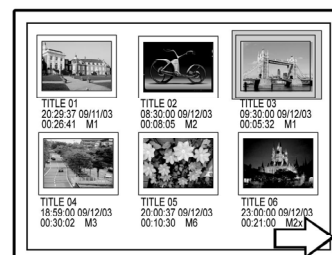

Sample Thumbnail display

■ Press [PLAY LIST MENU] to display the title menu on the TV screen.

Press [] [] [] [] to select an item and press [ENTER].

Note:

The [PLAY LIST MENU] button only functions while the unit is in playback mode. Depressing this button during other operations won't work on this unit.

PLAYBACK

Navigation operation

During playback, press [NAVI] to display the "Navigation" menu.

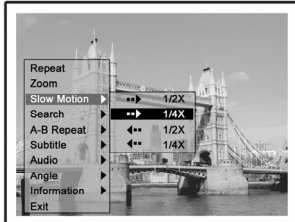

Repeat Repeat playback. Move the highlighted cursor to "Repeat" and press [ENTER] repeatedly to choose a repeat option. Depending on the type of Disc, you may choose to play the Track, Title, file or Disc repeatedly.

Note:

For DVD, the repeat options are:
1 TRACK <-> Repeat Off
For VCD and SVCD, the repeat options are:
ALL TRACK <-> Repeat Off
For CDDA (audio CD) and data discs, the repeat options are:
1 TRACK (except for picture files) <-> ALL TRACK
<-> Shuffle Mode <-> Repeat Off

Zoom Press [ZOOM] during playback or still playback to activate zoom function. Enables zoom in or out the selected viewing at 1x, 2x, 3x and 4x. Press [◀][▶][▲][▼] to move the highlighted cursor to the desired selection on the on-screen panel and press [ENTER].

Slow Motion Enables the selection of a slow-motion speed. You can choose to play the Disc at 1/2x and 1/4x.

Search Initiates the search capability for locating a desired position in the current title or track (time search). Press the numeric buttons (0 to 9) to enter the desired time or title.

Example (for DVD-VIDEO)
To playback from
TITLE:CHAPTER : 001/001
or **TIME:0 1 : 2 7 : 3 3 (H:M:S)**

Example (for SVCD/VCD)
To playback from
TIME:0 1 : 2 7 : 3 3
Press [◀] to correct a mistake.
Press [◀] repeatedly to move back to the digit where you entered a wrong number, and reenter the correct one.
Press [ENTER] to start playback from the specified time.

Note:

Moving the cursor left through each menu takes you to the previous level. Moving the cursor left at the first menu selection closes the dialog box.

A-B Repeat Repeating a desired part. Select "Set Point A" at the beginning of the part you want to repeat. Select "Set Point B" at the end of the part you want to repeat.

The unit locates "A" and starts repeat playback between "A" and "B."
Select [Cancel]. The A-B repeat mode turns off, then normal playback continues.

Subtitle During playback to select a subtitle language from those available on the current disc. Press [SUBTITLE] repeatedly during playback to see the different subtitle languages.

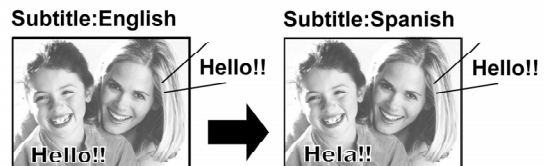

Note:

Some DVDs include subtitles in different languages. If you want to choose subtitles, follow these steps.

Audio To select a different audio language or soundtrack during DVD playback. Press [AUDIO] repeatedly to hear a different audio languages or audio tracks.



Note:

Multiple languages or soundtracks must be available on the DVD.

Angle To select a different camera angle during DVD playback. Press [ANGLE] repeatedly during playback to select a desired angle.

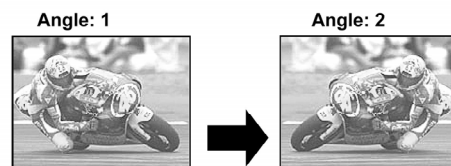

Note:

The Multiple Angles capability must be available on the DVD. (within the current title) or track for playback.

PLAYBACK

Information

To enable or disable the DVD/VCD/SVCD disc information.

TO EXIT NAVIGATION

Press [NAVI] again or repeatedly press [◀] to exit the "Navi" menu. Or go to "Exit" and press [ENTER].

Playing back video title (By Browser)

This unit can play video titles recorded on the HDD or the recordable DVD disc.

1. Place a disc with recorded video titles on the tray or make sure that the video titles are saved on the HDD.

2. Press [HDD/DVD] to select HDD or DVD.

3. Press [BROWSER] and this will bring up the browser menu with thumbnails.

If you want to view the text menu, move the cursor to the "Text View" icon and press [ENTER].

If you want to change the playback device, press [◀] [▶] to move the highlight to the "HDD" icon or "DVD" icon (depending what the source is set as) and press [ENTER] to change the setting.

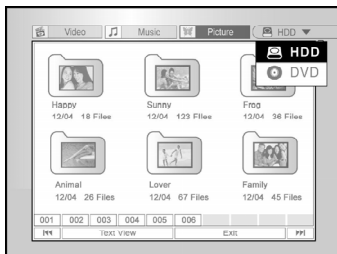

4. Press [◀] [▶] to move the highlight to the "Video" icon and press [ENTER] to view the file menu with thumbnails.



If you want to view the text menu, move the highlight to the "Text View" icon and press [ENTER].

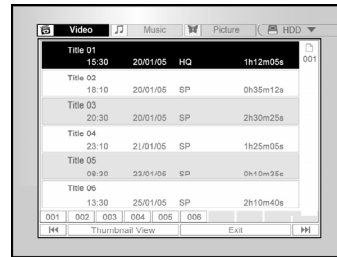

5. Press [▲] [▼] [◀] [▶] to move the highlight to the file you want to start playback from and press [ENTER].

6. Press [|| PAUSE/STEP] to pause playback.

Press [■ STOP] to stop playback at a market stop.

Press [■ STOP] twice to bring the playback to a full stop.

Note:

The index page numbers shown on the bottom of the browse menu varies with the number of titles/files saved on the HDD/ DVD disc and do not always follow the numeric order. This is designed for easier access to each page when there are more titles/files available.

MUSIC FILE PLAYBACK, PICTURE FILE PLAYBACK (BY BROWSER)

The unit can play an Audio CD, JPEG/BMP or MP3/WAV files on a disc or from the HDD.

Playing back music files

Playing back MP3/WAV files.

1. Place a music disc on the tray or save the music files to the HDD. Music files residing on the HDD can be played from the hard disc.
2. Press [HDD/DVD] to select HDD or DVD.
3. Press [BROWSER] on the list and this will bring up the browser menu with thumbnails.
If you want to change the playback device, press [◀] [▶] [▲] [▼] to move the highlighted cursor to the "HDD" icon or "DVD" icon (depending which source your desire) and press [ENTER] to change the setting.
4. Press [◀] [▶] to move the highlighted cursor to the "Music" icon and press [ENTER] to view the file menu with thumbnails.

If you want to view the text menu, move the highlighted cursor to the "Text View" icon and press [ENTER].

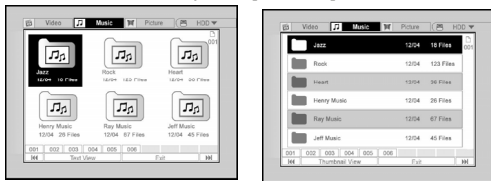

5. Press [▲] [▼] [◀] [▶] to move the highlighted cursor to the file you want to start playback from and press [ENTER].
Or, use the numbered buttons and [ENTER] to select the music file to start playback.

6. During playback, press [▶▶] NEXT or [◀◀] PREV to advance to the next or return to the previous file.

7. Press [||] PAUSE/STEP to pause playback.

8. Press [■] STOP to stop playback at a market stop.
Press [■] STOP twice to bring the playback to a full stop.

Notes:

1. If a MP3 file name includes any 2-byte character, the unit may not display the file name correctly.
2. The unit cannot support ID3 tag.
3. The unit does not support MP3-Pro files.
4. The unit supports discs recorded with multiple sessions.
5. The unit can only playback picture or tracks with the following file extensions; JPG or jpg, BMP or bmp, MP3 or mp3, WAV or wav and etc.
6. The time required for reading disc contents may vary for different discs. This is dependent upon the numbers of groups (folders) and tracks (files) recorded and etc.
7. You cannot advance or reverse playback by pressing [▶▶FF] or [◀◀REV] during picture file playback.
8. This unit supports MP3 file bitrates of: 32Kbps ~ 320Kbps.
9. Customers should also note that permission is required in order to download MP3 files and music from internet. Sanyo has no right to grant such permission. Permission should always be sought from the copyright owner.

10. For JPEG files: The previous files of the selected file cannot be played back.

Playing back picture files

Playing back JPEG/BMP files.

1. Place a picture disc on the tray or save the picture files to the HDD. Picture files residing on the HDD can be played from the hard disk.
2. Press [HDD/DVD] to select HDD or DVD.
3. Press [BROWSER] on the list and this will bring up the browser menu with thumbnails.
If you want to change the playback device, press [◀] [▶] [▲] [▼] to move the highlighted cursor to the "HDD" icon or "DVD" icon (depending what the source is set as) and press [ENTER] to change the setting.

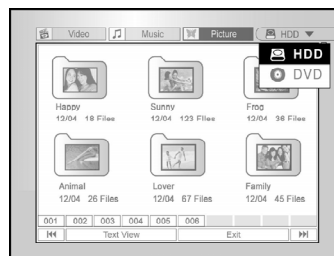

4. Press [◀] [▶] to move the highlighted cursor to the "Picture" icon and press [ENTER] to view the file menu with thumbnails.

If you want to view the text menu, move the highlighted cursor to the "Text View" icon and press [ENTER].

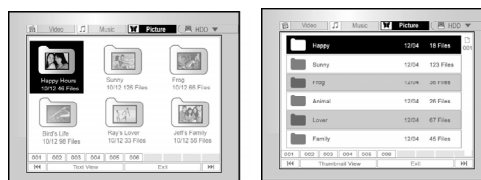

5. Press [▲] [▼] [◀] [▶] to move the highlighted cursor to the file you want to start playback from and press [ENTER].

6. During playback, press [◀] [▶] to advance to the next or return to the previous file.



7. Press [▲] [▼] to select "Rotate RIGHT" or "Rotate LEFT" and "Rotate UP" or "Rotate DOWN."

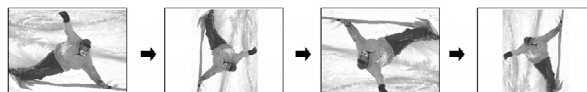

8. Press [||] PAUSE/STEP to pause playback.
9. Press [■] STOP to stop playback.

AUDIO CD PLAYBACK, PLAYBACK PICTURES AND MUSIC

Audio CD playback

Playing Audio CDs

1. Place the Audio CD on the tray.

The disc will begin playback automatically.

2. Press [▶▶|NEXT] or [◀◀PREV] to advance to the next track or reverse to the previous track.

3. Press [||PAUSE/STEP] to pause playback.

4. Press [■STOP] to stop playback.

5. Enter the numbered button (0~9) to select the desired audio track, and press [ENTER].

Begin playing from a selected track.

8. During playback, press [▶▶|NEXT] or [◀◀PREV] to advance to the next or return to the previous music file.

9. Press [◀|▶] to go to the next or return to the previous picture file.
Press [▲][▼] to select "Rotate RIGHT" or "Rotate LEFT" and "Rotate UP" or "Rotate DOWN."

10. Press [||PAUSE/STEP] to pause the playback.
Press [■STOP] to stop the playback.

Slide show (Pictures with Music)

Concurrent playing of pictures and music files on the same disc.

1. Place the disc with the audio and the picture files on the tray or make sure that the audio and picture files are saved onto the HDD. The saved audio and music files can be played from the hard disk.

2. Press [GUIDER] for the Easy Guider Menu.

3. Press [▲][▼] to go to the "Playback" icon and press [ENTER].

4. Press [▲][▼] to select HDD or DVD to play the files from and press [ENTER].

Note:

Music and picture files can be played concurrently when these files are saved onto the same device.

5. Press [▲][▼] to go to the "Pictures with music" icon and press [ENTER].

The browser menu of picture files will be displayed first.



6. Press [▲][▼][◀|▶] to select the picture file to start playback with and press [ENTER].

The browser menu of audio files will be displayed.

7. Press [▲][▼][◀|▶] to select the music file to start playback with and press [ENTER].

Playback will start.

COPY

This DVD recorder is equipped with "One Touch Copy" feature, which allows you to copy recorded files from the HDD to DVD or from DVD to HDD. This function is only applicable to JPEG, BMP, VOB, MP3 and WAV files and recorded video titles(HDD to DVD only).

Note:

As for the audio CD copied on HDD, there are no relations to the original track number, the music which played back first may be indicated with "01".

When playback musics of audio CD which are copied to HDD; SHUFFLE playback

Shuffle playback can only be played back after the selected music.

PREVIEW

The previous musics of the selected music cannot be played back.

Copying from DVD to HDD

1. Press [⏻ STANDBY/ON] to turn the unit and your TV on.
2. Press [▲ OPEN/CLOSE] to open the disc tray and place the disc with the label side up.
3. Press [HDD/DVD] and select "DVD."
4. Press [BROWSER] to browse the files.
5. Press [▲] [▼][◀] [▶] to move the highlight cursor to the file to be copied and press [COPY].
The file is then copied to your HDD.

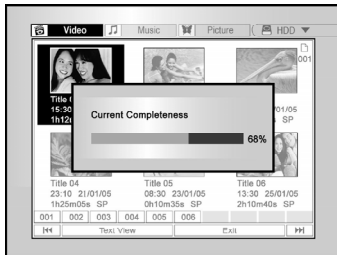

Notes:

1. Contents recorded on a VCD/SVCD disc can not be copied to the HDD before the disc is finalized.
2. The title of DVD-Video cannot be copied from DVD to HDD.
3. You can't use the One Touch Copy function to copy a title if any part of the title is copy-once protected.
4. You may use this product only to reproduce or copy materials for which you own the copyright or have which obtained permission to copy from the copyright owner or for you otherwise have a legal right to reproduce or copy. Unless you own the copyright or have obtained permission from the copyright owner or otherwise have a legal right to reproduce or copy, you may be violating the law, including copyright law, and may be subject to payment of damages and other remedies.

Copying from HDD to DVD

1. Press [⏻ STANDBY/ON] to turn the unit and your TV on.
2. Press [▲ OPEN/CLOSE] to open the disc tray and place a recordable DVD disc with the label side up. Make sure to insert a recordable DVD disc. Press the button again to close the tray. When you insert a new recordable DVD disc, the DVD recorder automatically starts the disc preparation process.
3. Press [HDD/DVD] and select "HDD."
4. Press [BROWSER] to browse the files.
5. Press [▲] [▼][◀] [▶] to move the highlighted cursor to the file to be copied and press [COPY].
The file is then copied to the DVD disc.

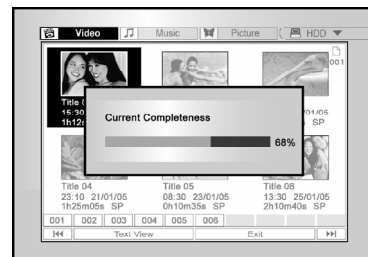

Notes:

1. Video files with "DVD-Video" in its file name and the thumbnail below can only be copied to an emptied/new DVD+R/+RW disc.
2. Video files with "VCD-Video" in its file name and the thumbnail above can only be copied to a CD-R/RW prepared as a VCD disc.
3. Video files with "SVCD-Video" in its file name and the thumbnail above can only be copied to a CD-R/RW prepared as a SVCD disc.



4. Before copying other files to a disc, reference the below:

	Recorded Titles (*1)	Data File			Note
		Vob · mpg and dat files with	Music Files	Picture Files	
Recordable disc media					
CD-R/RW: VCD-format					
CD-R/RW: SVCD-format					
CD-R/RW: Data CD-format		V	V	V	
CD-R/RW: Audio CD-format			V		(*2)
Blank DVD+R/+RW	V	V	V	V	(*3)
Media CD (CD or DVD)		V	V	V	

*1. Recorded titles are titles with recording quality (HQ, SP, LP, EP, SLP) information in the browser menu.

*2. CD-R/RW disc prepared in the Audio CD format can only be used to copy WAV music files. When copying is completed, you need to first "finalize" the disc before you can play the disc on a compatible device.

*3. If you copy recorded titles to a blank DVD+R/+RW disc, you can't use the same disc to copy data files. If you copy data files to a blank DVD+R/+RW disc, you can't use the same disc to copy recorded video titles.

EDIT

Before starting to edit

This section explains the basic editing functions on the unit. Please finish all the editing before finalizing the disc. You cannot edit the contents on a finalized disc.

You can perform the editing functions on video titles only.

Notes:

- For DVD+R discs, after performing editing function of inserting, renaming or hiding chapter marks to a video title, the setting will NOT be valid when playing the disc(s) on another DVD player/recorder.
- Editing functions introduced in this chapter is NOT applicable to video titles recorded on CD-R or CD-RW discs.

Browser menu

- Press [⏻ STANDBY/ON] and press [HDD/DVD] to select the "DVD" or "HDD" to browse from.
- Press [BROWSER] to display the "BROWSER" menu.
- Press [◀] [▶] [▲] [▼] to select the title you want to edit, and press [EDIT] to go to the edit screen.



Naming a title (HDD and DVD)

- Press [▲] [▼] to select "Rename" and then press [ENTER].

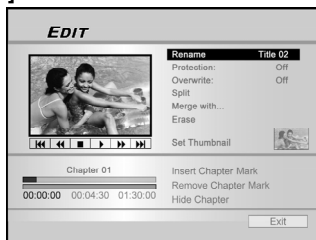

- The menu for the title naming is displayed.



- Press [▲] [▼] to select the "Clear" icon first and then press [ENTER] before start entering the new title. Press [◀] [▶] [▲] [▼] to select "Back" to delete characters.
- Use [◀] [▶] [▲] [▼] and [ENTER] on the remote control to select desired characters.
- When you finish entering the title, press [◀] [▶] [▲] [▼] to select "Finish" and press [ENTER].

Notes:

- You only can enter up to 30 characters for a name. You can not leave the title column blank.
- If you wish to enter "space", select a blank on the keypad and press [ENTER].

Protecting a title (HDD and DVD)

You can protect the title from accidental erasure or editing when you activate the protect function.

When protection is turned "ON," the title can't be edited or erased.

If you do need to edit it, you must first unlock the file.

- Press [BROWSER] to display the "Browser" menu.
- Press [◀] [▶] [▲] [▼] to select the title you want to edit and then press [EDIT] to go to the edit screen.
- Press [▲] [▼] to select "Protection" and then press [ENTER].
- Press [ENTER] to select "On" or "Off."



- Press [▲] [▼] to select "Exit" and then press [ENTER].

Note:

You CANNOT protect the recorded title(s) on a DVD+R disc if the disc is finalized.

Overwriting a title (DVD only)

- Press [HDD/DVD] to select the "DVD."
- Press [BROWSER] to display the "Browse" menu.
- Press [◀] [▶] [▲] [▼] to select the title you want to edit and then press [EDIT] to go to the edit screen.
- Press [▲] [▼] to go to "Overwrite" and then press [ENTER] to set it on or off. The "Overwrite" mode is set.



- Press [▲] [▼] to select "Exit" and then press [ENTER].

Note:

The "overwrite" function is not applicable to video titles saved on the HDD or a DVD+R disc that is finalized.

EDIT

Splitting a title (HDD or DVD+RW only)

Use this function to divide a title into two distinct sessions. After splitted, the new title can still be merged again. This function is only applicable to titles with length longer than 6 seconds.

1. Press [BROWSER] to display the "Browser" menu.
2. Press [◀] [▶] [▲] [▼] to select the title you want to edit and then press [EDIT] to go to the edit screen.
3. Press [▶PLAY] to start the title playback first. Press [▶▶NEXT] or [◀◀PREV] to advance to the next chapter or the previous chapter. Press [▶▶FF] or [◀◀REV] to perform fast forward or fast rewind scanning.
4. Move the highlighted cursor to "Split" and press [ENTER] for confirmation.
The title is splitted into two titles at where you press [ENTER] during playback.
5. When complete, the browser menu will be displayed.
6. To split more titles, repeat from step 2 to 4. Or press [▲] [▼] to select "Exit" and then press [ENTER] to exit the setting.

Note:

The split function is only applicable to video titles longer than 6 seconds.

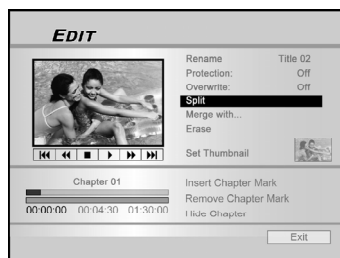

Merging two titles into one (HDD or DVD+RW only)

Use this function to merge two titles into one. After merged, the new title can still be splitted again.

1. Press [BROWSER] to display the "Browser" menu.
2. Press [◀] [▶] [▲] [▼] to select the title you want to edit and then press [EDIT] to go to the edit screen.
3. Press [▲] [▼] to select "Merge with..." and then press [ENTER].
A menu shows all the titles applicable to this function will display.
4. Press [◀] [▶] [▲] [▼] to select the title to merge and then press [ENTER].

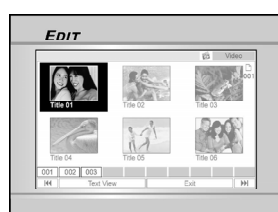
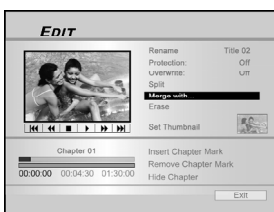

5. To merge more titles, repeat from step 2 to 4. Or press [▲] [▼] to select "Exit" and then press [ENTER] to exit the setting.

Notes:

1. For video titles recorded on a DVD+RW disc, you can only merge the title with its previous/next title and only when the previous/next title has the same recording quality, TV signal, audio and video settings. Otherwise, the function will not be applicable.
2. For video titles recorded on the built-in HDD, you can merge the title with any of the titles recorded on the HDD with the same recording quality, TV signal, audio and video setting.

Erasing a title (HDD and DVD only)

Use this function to erase a title.

Note that once erased, the title(s) cannot be retrieved.

1. Press [BROWSER] to display the "Browser" menu.
2. Use [◀] [▶] [▲] [▼] to select the title you want to edit and then press [EDIT] to go to the edit screen.
3. Press [▲] [▼] to select "Erase".
4. Press [ENTER] to confirm your setting.
The title selected is erased.

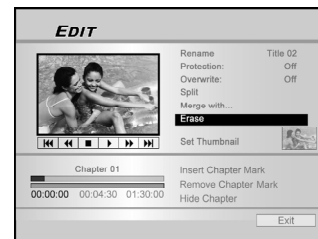

5. To erase more titles, repeat from step 2 to 4. Or press [▲] [▼] to select "Exit" and then press [ENTER] to exit the setting.

Note:

You CANNOT erase recorded title(s) on a DVD+R disc if the disc is finalized.

Setting a title thumbnail (HDD and DVD only)

Normally the first picture of a recording is used as the index picture. However, you can choose any picture from the recording as the index picture.

1. Press [BROWSER] to display the "Browser" menu.
2. Use [◀] [▶] [▲] [▼] to select the title you want to edit and then press [EDIT] to go to the edit screen.
3. Press [▶PLAY] to start the title playback first. Press [▶▶NEXT] or [◀◀PREV] to advance to the next chapter or the previous chapter. Press [▶▶FF] or [◀◀REV] to perform fast forward or fast rewind scanning.
Press repeatedly to play the title forward or reverse.

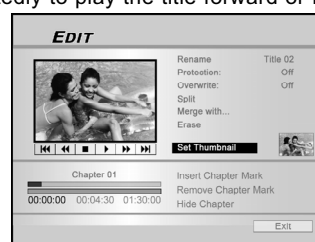

EDIT

4. Press [▲] [▼] to select “Set Thumbnail.”

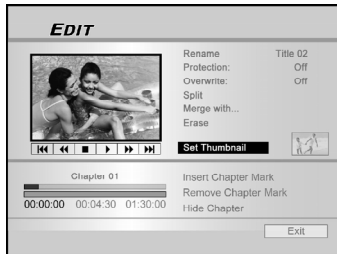

5. Press [ENTER] to select the image during playback and set it as the video title thumbnail.
6. To set thumbnails for more titles, repeat from step 2 to 5. Or press [▲] [▼] to select “Exit” and then press [ENTER] to exit the setting.

Note:

You CANNOT set the thumbnail for the recorded title(s) on a DVD+R disc if the disc is finalized.

Inserting chapter mark (HDD and DVD only)

During playback you can set and erase chapter mark(s) within a title.

1. Press [BROWSER] to display the “Browser” menu.
2. Press [◀] [▶] [▲] [▼] to select the title you want to edit, and then press [EDIT] to go to the edit screen.

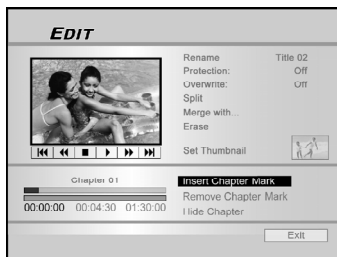

3. Press [▲] [▼] to select “Insert Chapter Mark”.
4. Press [▶] [PLAY] to start the title playback first. Press [▶▶] [NEXT] or [◀◀] [PREV] to advance to the next chapter or the previous chapter. Press [▶▶] [FF] or [◀◀] [REV] to perform fast forward or fast rewind scanning. Press repeatedly to play the title forward or reverse.
5. Press [ENTER] to insert chapter marks at where you want to during playback.
6. To insert thumbnails in more titles, repeat from step 2 to 5. Or press [▲] [▼] to select “Exit” and then press [ENTER] to exit the setting.

Notes:

1. You CANNOT insert chapter marks to recorded title(s) on a DVD+R disc if the disc is finalized.
2. When not in the EDIT menu, press [EDIT] during normal recording can add chapter marks in the recorded session(s) manually.

Erasing Chapter Mark (HDD and DVD only)

During playback you can set and erase chapter mark(s) within a title.

1. Press [BROWSER] to display the “Browser” menu.
2. Press [◀] [▶] [▲] [▼] to select the title you want to edit, and then press [EDIT] to go to the edit screen.

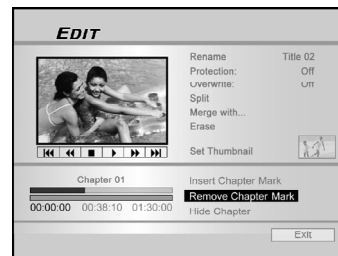

3. Press [▲] [▼] to select “Remove Chapter Mark”.
4. Press [▶] [PLAY] to start the title playback first. Press [▶▶] [NEXT] or [◀◀] [PREV] to advance to the next chapter or the previous chapter. Press [▶▶] [FF] or [◀◀] [REV] to perform fast forward or fast rewind scanning. Press repeatedly to play the title forward or reverse.
5. During playback you can press [ENTER] to erase the chapter mark.
6. To erase chapter marks in more titles, repeat from step 2 to 5. Or press [▲] [▼] to select “Exit” and then press [ENTER] to exit the setting.

Notes:

1. This function is not applicable to files without any chapter marks.
2. The first chapter mark within a video title can not be erased.

EDIT

Hiding Chapter (HDD and DVD only)

During playback you can set and hide chapters within a title.

1. Press [BROWSER] to display the "Browser" menu.
2. Press [◀] [▶] [▲] [▼] to select the title you want to edit, and then press [EDIT] to go to the edit screen.

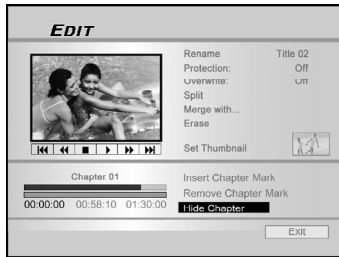

3. Press [▲] [▼] to select "Hide Chapter."
4. Press [▶] [▶] [▶] to start the title playback first. Press [▶] [▶] [▶] [NEXT] or [◀] [◀] [◀] [PREV] to advance to the next chapter or the previous chapter. Press [▶] [▶] [▶] [FF] or [◀] [◀] [◀] [REV] to perform fast forward or fast rewind scanning. Press repeatedly to play the title forward or reverse.
5. During playback you can press [ENTER] to hide a chapter.
6. To show (un-hide) the hidden chapter, press [▲] [▼] to go to "Show Chapter" and press [ENTER] during the playback of the hidden chapter. Press [▶] [▶] [▶] [NEXT] or [◀] [◀] [◀] [PREV] to advance to the next chapter or the previous chapter.
7. To hide more chapters within the title, repeat from step 2 to 5. Or press [▲] [▼] to select "Exit" and then press [ENTER] to exit the setting.

Notes:

1. You CANNOT hide chapters within recorded title(s) on a DVD+R disc if the disc is finalized.
2. This function is not applicable to titles without chapter marks.
3. After performing this function, the chapter marks within the title are hidden only during playback.
4. In Edit mode, a hidden chapter mark is displayed in a darker color. A message "hidden" is also displayed at the left bottom corner of the PIP.

Showing Chapter (HDD and DVD only)

During playback you can choose to show chapter(s) currently hidden within a title.

1. During playback, press EDIT to display the Edit menu.
2. On the Edit menu, press [▶] [▶] [▶] [NEXT] or [◀] [◀] [◀] [PREV] to select the hidden chapter you would like to show again.

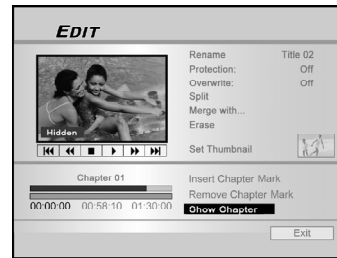

Notes:

1. On the Edit menu, a hidden chapter mark is displayed in a darker color. A message "Hidden" is also displayed at the left bottom corner of the PIP window.
2. You can press [||] [PAUSE/STEP] to pause playback before you go on to step 3 and 4 to show the hidden chapter.
3. Select the "Show Chapter" by using cursor button then press [ENTER] for showing chapter again.
4. To show more chapters within the title, repeat steps 1 to 3. Or press [▲] [▼] to select "EXIT", then press [ENTER] to exit the setting.

DISC TOOLS

Erase

Before you begin erasing any contents on a disc or the HDD, please ensure that all important contents are safely backed-up. All contents will be permanently erased.

CAUTIONS:

For DVD+RW and CD-RW discs, you can erase the contents and create a new format with the erase function. You can use the erase function to empty the HDD as well.

1. Press [TOOLS] to display the "DISC TOOLS" Menu.
2. Press [▲] [▼] to select "Erase" and then press [ENTER].

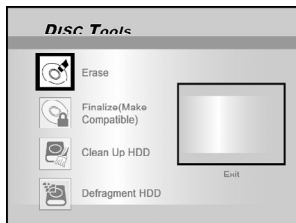

3. Press [▲] [▼] to select "DVD" or "HDD" and press [ENTER].

4. Press [ENTER] to start erasing.
The erasing process will take place.



5. When complete, go to "Exit" and press [ENTER].

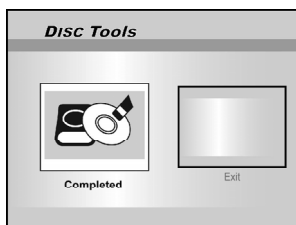

Note:

If a new recordable CD-R or a newly-erased CD-RW is used for recording, press [◀] [▶] [▲] [▼] to select a disc format the disc is to be prepared as and press [ENTER] : SVCD, VCD, Audio CD or Data CD.

Finalize (make compatible)

CAUTIONS:

For DVD+R/CD-R/CD-RW discs:

Finalizing a disc is a necessary step when you want to share your digital content with others. Once a DVD+R or a CD-R/RW disc is finalized, it can be played back on other DVD players or on PCs.

Note:

For DVD+RW discs, finalizing is NOT required.

1. Press [TOOLS] to display the "DISC TOOLS" Menu.
2. Press [▲] [▼] to select the "Finalize" icon and then press [ENTER].

The finalization process will take place.



3. When complete, go to "Exit" and press [ENTER].

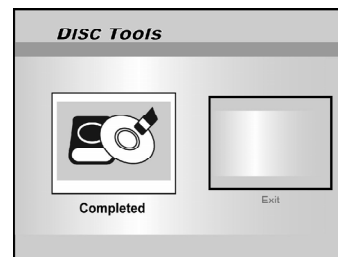

DISC TOOLS

CleanUp Disc (HDD only)

1. Press [TOOLS] to display the “DISC TOOLS” Menu.
2. Press [▲] [▼] to select the “Clean Up HDD,” and then press [ENTER].



3. Press [▲] [▼] to select the “Delete Older Files,” “Delete Larger Files,” “Delete Seldom Played Files,” “Delete Album” or “Delete All” and then press [ENTER].

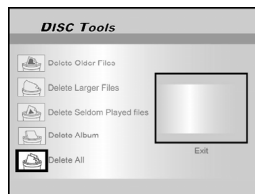
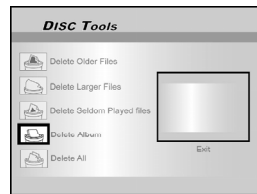
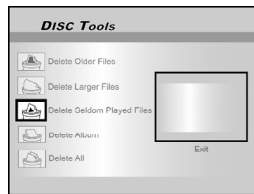
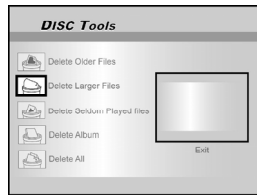

4. The clean up process will take place.

You will be asked to confirm the operation step by step by pressing [ENTER] to each question.

5. When complete, move the highlighted cursor to “Exit” and press [ENTER] to exit.

Notes:

1. The “Cleanup” operation will permanently delete the files selected.
2. It would take more time for the “Cleanup” operation depending on the recorded condition.

Defragment (HDD only)

The “Defragment” process reorganizes the contents of the HDD creating continuous blocks of available space.

1. Press [TOOLS] to display the “DISC TOOLS” Menu.
2. Press [▲] [▼] to select “Defragment” and then press [ENTER]. “Go !” is selected and press [ENTER].

The defragment operation begins.



3. When the “Defragment” process is completed, press [ENTER] to exit the “DISC TOOLS” menu.

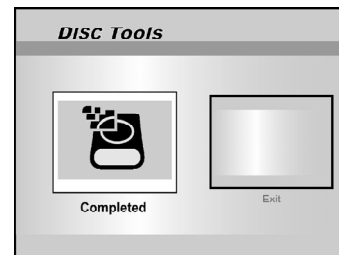

Notes:

1. Contents of the HDD will not be lost during this process.
2. Frequent “defragment” operations are recommended to improve performance.
3. During the defragment operation, you can press [TOOLS] or move to “Exit” and press [ENTER] to exit the defragment menu.

GUI(GRAPHICAL USER INTERFACE) OPERATION

System

Video Output

Switch video output signal.

- Component
- Scart S-Video
- Scart RGB(**Default**)
- Progressive

Note: If you are connecting the DVD recorder to the TV via the SCART OUT jack, set the VIDEO OUTPUT as either "Scart S-Video" or "Scart-RGB." If you are connecting the DVD recorder to the TV via the COMP OUT jack, set the VIDEO OUTPUT as "Component."

Date

Set the date of the system clock.

Time

Set the time of the system clock.

HH:MM:SS

Auto-Sleep

Off/30/60/90/120mins(**Default: Off**)

Note: "Auto sleep" sets how long the DVD recorder is switched to "STANDBY" mode when no operation of the system is detected (e.g. recording, playback, timer record or editing).

Restore

---- (Off) Restore

Audio

Digital Out

Settings of digital audio output.

- PCM (Enable digital audio output with PCM data)
- Bit Stream (Enable digital audio output with encode data)(**Default**)

DTS Out

Enable/Disable Digital Theater System output.

- ON (Enable Digital Theater System mode)
- OFF (Disable Digital Theater System mode) (**Default**)

Surround

Stereo Dolby(**Default**) DTS

TV Sound Bilingual

Main(**Default**) Sub (Second Audio Program)

MPEG

PCM (**Default**) Bit Stream

Language

Menu Language

Select a menu operating language. The options are :
English, French, German, Italian, Spanish

Audio Language

Select an audio operating language. The options are :
English, French, German, Italian, Spanish

Subtitle Language

Select a subtitle operating language. The options are :
English, French, German, Italian, Spanish, Off

Playback

Aspect Ratio

Settings of audio and video parameters when playing back.
16:9 Wide 4:3 Pan 4:3 L.Box (**Default**)

Parental Lock

Set content control for supported DVD.
Set Level (Off , 1~8) (**Default: off**)

The parental control levels are:

- | | | |
|-------------|----------|------------------------|
| 1: Kid Safe | 2: G | 3: PG |
| 4: PG-13 | 5: PG-R | 6: R |
| 7: NC-17 | 8: Adult | Off (Default) |

Password

Set a system protect password. Password is needed for the changing the setting.

OLD Password (XXXX) NEW Password (XXXX)
Confirm (XXXX) ***(Default:0000)**

Slide Time

Set the slide show interval while playing JPEG files.
Off 3~99 Seconds (**Default: 5**)

VCD PBC

Enable/Disable play back control for VCD and SVCD.
ON (**Default**) OFF

GUI(GRAPHICAL USER INTERFACE) OPERATION

Record

Mode(Record Quality)

Set the default quality of recording.

HQ SP (Default) LP
EP SLP

Chapter Mark

Set the interval of chapter auto-insertion while recording.

Off 5/10/15/20/25/30 mins (Default: 5mins)



Recording Mode

Quality	Rec. Time (DVD)	Rec. Time (160GB HDD)
HQ	1 Hour	33 Hours
SP	2 Hours	66 Hours
LP	3 Hours	99 Hours
EP	4 Hours	132 Hours
SLP	6 Hours	198 Hours

- 1) Press [SETUP] to display the setup menu.
- 2) Press [▲] [▼] to select "System," "Language," "Playback," "Record," "Audio," "TV Tuner" or "Exit" and press [▶] or press [◀] to return to previous layer.
- 3) Press [▲] [▼] to select the item and press [▶] or [ENTER].
- 4) Press [▲] [▼] to set the option and press [ENTER].

To exit the SETUP menu

Press [SETUP] or press [◀] until you return to the main menu.

TV Tuner

TV Signal ---> Antenna or Cable or Auto

(Select the type of antenna input)

Country ---> Select your location

Utilities ---> Scan channel or Edit channel

(Select to start rescanning channel or edit a channel)

Fine Tune --> -24 ~ -1 0 +1 ~ +24

(Select to fine tune the channel frequency manually)

GLOSSARY

576i/576p

Indicates the number of scanning lines and scanning format of an image signal.

576i indicates 576 scanning lines with interlace format, and 576p indicates 576 scanning lines with progressive format.

Aspect ratio

Aspect ratio refers to the length to height ratio of TV screens. The ratio of a standard TV is 4:3, while the ratio of a high-definition or wide TV is 16:9. The letter box allows you to enjoy a picture with a wider perspective.

Bitstream

The digital form of multi-channel audio data (e.g., 5.1-channel) before it is decoded into its various channels.

Chapter / Title

Chapter is the smallest division and title is the largest division on a DVD VIDEO. A chapter is a division of a title and similar to a track for Video CD or Audio CD.

Component video

Video signals with three channels of separate information that makes up the picture. There are some types of component video, such as R/G/B and Y/Cb(Pb)/Cr(Pr).

Composite video

A single video signal commonly used in most consumer video products that contains all luminance, color, and synchronization information.

Dolby Digital®

A six-channel system consisting of left, center, right, left rear, right rear and LFE (Low-Frequency Effect channel, for use with a sub-woofer) channels. It requires a Dolby Digital® decoder, either in the player or in an external receiver to regenerate the sound. All processing is done in the digital domain. Not all Dolby Digital discs contain six (5.1) channels of information.

DTS® (Digital Theater Systems)

DTS® stands for Digital Theater Systems. DTS® is a Digital Surround audio encoding format configured with six (5.1) channels, similar to Dolby Digital®. It requires a DTS® decoder, either in the player or in an external receiver to regenerate the sound. All processing is done in the digital domain. Not all DTS discs contain six (5.1) channels of information.

DVD-R

DVD-R is a recordable disc that is the same size as a DVD-Video. Contents can be recorded only once to a DVD-R, and will have the same format as a DVD-Video.

DVD-RW

DVD-RW is a recordable and rewritable disc that is the same size as a DVD-Video. DVD-RW has two different modes: VR mode and Video mode. DVD created in video mode has the same format as a DVD-Video, while discs created in VR (Video Recording) mode allow the contents to be programmed or edited.

DVD+R

DVD+R is a recordable disc that is the same size as a DVD-Video. Contents can be recorded only once to a DVD+R, and will have the same format as a DVD-Video.

DVD+RW

DVD+RW is a recordable and rewritable disc. Recording can be erased and you can record on the same disc again for the maximum of 1,000 times. DVD+RW use a recording format that is comparable to a DVD-Video format.

Interlace output

NTSC, the video signal standard, has 480 interlaced (I) scan lines. The Interlaced scanning system places lines of the second half of the picture in-between lines of the first half of the picture.

JPEG

A popular file format for still image compression and storage. JPEG stands for "Joint Photographic Experts Group". There are two sub-types of the JPEG format as follows.

- Baseline JPEG: used for digital cameras, the web, etc.
- Lossless JPEG: an old type, rarely used now.

Linear PCM audio

PCM stands for "Pulse Code Modulation". Linear PCM is the usual method for digitally encoding audio without compression, and is used for the audio tracks on DVD VIDEO discs, Audio CDs, etc.

MP3

MP3 (MPEG1 audio layer 3) is a compressed audio file format. Files are recognized by their file extension ".mp3" or ".MP3".

MPEG

MPEG stands for "Motion Picture Experts Group". This is an international standard for compression of moving images. On some DVDs, digital audio has been compressed and recorded in this format.

NTSC (National Television System Committee)

The initials stand for National Television Standards Committee. This is the committee that established the standards for television systems in the United States. The NTSC standard broadcasts 525 or 480 lines of resolution per second, and 30 frames per second of refresh rate, 60 Hz field frequency. NTSC TV system is widely used in USA, Canada, Latin America and Taiwan etc.

PAL (Phase Alternation by Line)

PAL (Phase Alteration Line) is the color television broadcast standard throughout the Western Europe (except in France, where SECAM is the standard), Australia, China, Singapore and Malaysia etc. It has 625 lines of vertical resolution per second and 25 frames per second refresh rate, 50 Hz field frequency.

PBC

Playback Control. A special feature on a Video CD or Super VCD that enables interactive use.

S-Video

A video signal which improves picture quality over standard composite connections. Used on Super VHS, DVD, high end TV monitors, etc.

Track

SVCD, VCD, Audio CD discs use tracks to divide up the content of a disc.

SPECIFICATIONS

DISC TYPES SUPPORTED (Read Only):

DVD-R/RW, DVD+R/RW, CD-R/RW

CONTENT FORMAT SUPPORTED :

- 1) DVD-Video
- 2) DVD+VR (DVD+VR format is compatible with DVD-Video in most case)
- 3) Video CD
- 4) Super VCD
- 5) Audio CD
- 6) VOB/MPG/DAT
- 7) MP3/WAV
Maximum number of files recognizable : 9999 files
Compression rate : between 32 kbps and 320 kbps
- 8) JPEG/BMP
Maximum number of pictures recognizable : 9999 files

RECORDABLE MEDIA SUPPORTED:

- 1) Built-in HDD (DVD+VR mode)
- 2) DVD+R/DVD+RW (DVD+VR Mode)
- 3) CD-R/CD-RW (VCD/SVCD mode)

VIDEO RECORDING MODE

Mode	DVD	160GB HDD
HQ	1hr	33hrs
SP	2hrs	66hrs
LP	3hrs	99hrs
EP	4hrs	132hrs
SLP	6hrs	198hrs
Just Fit	Variable	N/A

Mode	CD-R/CD-RW
VCD	68 mins
SVCD	34 mins
Audio CD	66 mins

VIDEO RECORDING FORMAT

MPEG2: DVD+VR (HQ/SP/LP/EP mode), SVCD
MPEG1: DVD+VR (SLP mode), VCD

AUDIO RECORDING FORMAT

DVD+VR (HQ/SP/LP/EP/SLP mode) : Dolby Digital 2-channel
VCD/SVCD : MPEG1 Layer2
CD-DA : PCM

VIDEO PERFORMANCE

DA Converter	10-bit / 54MHz
Composite Output	1 Vpp 75 Ohm
Components Output	Y : 1 Vpp 75 Ohm P _b : 0.7 Vpp 75 Ohm P _r : 0.7 Vpp 75 Ohm

AUDIO FORMAT SUPPORTED - Playback

Analog output	2channel
Digital output	coaxial/optical
Format supported	LPCM Dolby Digital dts (only digital out) MPEG

AUDIO PERFORMANCE

DA Converter	24-bit/96KHZ
AD Converter	24-bit/96KHZ
Signal-Noise (1kHz)	≥90dB
Dynamic Range (1kHz)	≥80dB
Cannel Separation (1kHz)	≥110dB
Total Harmonic Distortion (1kHz)	≤65dB

TUNER

TV format	PAL-B/G, PAL-D/K, PAL-I/I or SECAM-L/L
-----------	---

(This recorder is designed to record and play back using the PAL coloring system.)

TV sound	Main / Sub
----------	------------

CONNECTIONS

FRONT PANEL

Video Input	Cinch (yellow) x1
Audio L/R Input	Cinch (white/red) x1
DV Input	IEEE 1394 4-pin x1

REAR PANEL

Video Output	Cinch (yellow) x1
Audio L/R Output	Cinch (white/red) x1
Component /	Y, P _b , P _r (Green/Blue/Red) x1
Progressive Scan Output	576p output

SCART 1	CVBS/RGB/S-Video out
SCART 2	CVBS/RGB in

Digital Audio Output	Coaxial x1 Optical x1
----------------------	--------------------------

GENERAL

Power Supply	AC100~240V 50/60Hz
Power Consumption	50W (Operation mode) Less than 5W (Standby mode)
Operating Temperature	+5°C to +40°C
Operating Humidity	5% to 80% RH
Dimensions(W/H/D):	430 x 66 x 316 mm
Net Weight:	Approx. 4.5 kg

Note:

The specifications and design of this product are subject to change without notice.

TROUBLESHOOTING GUIDE

Picture

The image from this unit does not appear on the television.

- > Make sure that the TV is connected to the AV OUTPUT, SCART OUT or COMP OUT terminals on this unit. (refer to "CONNECTIONS" section)
- > Make sure that the television's input setting is correct.
- > Make sure that a disc is well-placed on the disc tray and is compatible to the local TV system (PAL)
- > Check whether the recorder is set to progressive with an incompatible TV. Reset by pressing [▶], "5," "0," "2," and "0" on the remote control and then press [ENTER].

The image from this unit appears with noises.

- > The disc is distorted or flawed.
- > If the picture output signal from the recorder passes through your VCR to get to your TV, or if you are connected to a combination T V/VIDEO player, the copy protection signal applied to some DVD programs could affect picture quality. If you still experience this problem even when you connect your recorder to your TV, try connecting your recorder to your TV's S-VIDEO output.

The image from an external input is distorted.

- > If the video signal from the external component is copy-protected, you can not connect via the recorder. Connect the component directly to your TV.

Sound

There is no sound

- > Check the audio cable connection.
- > Check if the audio cord is damaged.
- > The input source setting on the amplifier is incorrect.
- > There's no sound when the picture is paused or during scanning (even forwards at regular playback speed) or slow motion play. Press [▶PLAY] to resume regular playback.
- > If the audio signal does not come through the DIGITAL OUT (OPTICAL or COAXIAL) jacks, check the AUDIO OUT settings.

The sound from this unit is not presented properly or is distorted.

- > Check the audio cable connection.
- > Check if the audio cord is damaged.
- > Make sure that the amplifier/receiver or TV is set to the correct input and the volume is turned on.
- > If the sound is distorted, try cleaning the cable plugs.

Playback

Can't playback a disc recorded using this recorder or another player

- > If the disc was recorded in video mode, make sure that it's finalized.
- > Some players will not play recordable DVD discs when recorded in video mode and finalized.
- > Discs recorded with copy-once material cannot be played on non-CPRM compatible players.

The recorder starts playing the disc automatically.

- > The DVD VIDEO features an auto playback function.

No playback on DVD recorder.

- > There's no recording on the disc. Check the disc first.
- > A unplayable disc type is inserted. Check the playable disc type list.
- > The way you inserted the disc is wrong. Insert the disc with the label side facing up. If there's no label on the disc, check the disc retailer.
- > Wrong region code: The region code on the recorder and the disc must match.
- > Parental control is on: you have to unlock it first. (default code of the recorder: 0000)
- > Check of the cables are secured between the TV set and the recorder.

Timer Recording

Timer recording does not work properly

- > The timer program is incorrect. Correct the program.
- > Different timer program times overlap.
- > The clock setting is wrong. Go to setup to set the right time and date.
- > An already finalized DVD+R has been inserted: change disc.

The timer program remains even after recording finishes.

- > The timer program remains if set to daily or weekly.

Recording

Can't record.

- > You haven't inserted a disc or the disc you inserted cannot be recorded on. Insert a disc the unit can record onto.

An alternate audio track cannot be recorded.

- > Second Audio Program (SAP) is not available for all programs.
- > The recorder does not feature "Second Audio Program (SAP)" function.

Recording does not start immediately after you press [● REC].

- > Disc preparation process is taking place and will take a short while. (applicable to DVD+R/RW discs)

Can't record on HDD.

- > If there is a power failure or the plug is disconnected from the household AC outlet while recording or editing, the HDD may become unusable. You will have to go to "DISC TOOLS" to "Erase" the contents on the HDD. Data recovery is NOT guaranteed.

TV channel

TV channels cannot be changed.

- > Switch the input signal source of the recorder to "TV."
- > Connect the antenna cables correctly.

Others

The disc does not open/close.

- > Contact your local dealer or local authorized service facility.

The unit stops at "HELLO" and does not respond to any other commands.

- > Turn the unit off and turn it on again. If the unit still does not respond to any commands, unplug the power cord, reconnect it and turn it on again. Contact local dealer or authorized service facility if the unit still does not work.

If you forget the password...

- > Please enter "8008" on password setting mode for password clear.



P/N: 87819901114--

Free Manuals Download Website

<http://myh66.com>

<http://usermanuals.us>

<http://www.somanuals.com>

<http://www.4manuals.cc>

<http://www.manual-lib.com>

<http://www.404manual.com>

<http://www.luxmanual.com>

<http://aubethermostatmanual.com>

Golf course search by state

<http://golfingnear.com>

Email search by domain

<http://emailbydomain.com>

Auto manuals search

<http://auto.somanuals.com>

TV manuals search

<http://tv.somanuals.com>