



## INSTRUCTION MANUAL

# SRT-600P

---

### 24-Hour Real Time Video Recorder

---

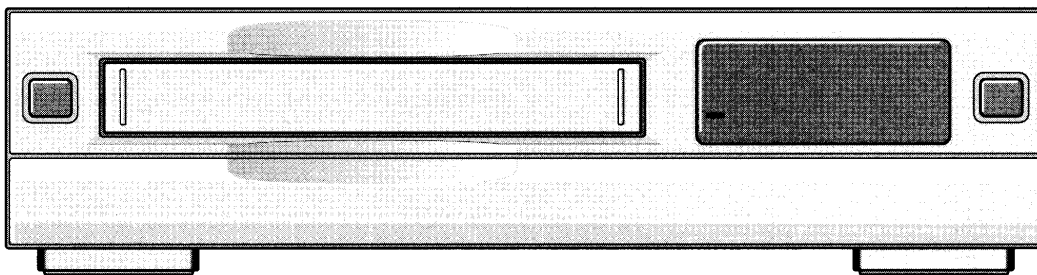

# PRECAUTIONS

**WARNING:** TO REDUCE THE RISK OF FIRE OR ELECTRIC SHOCK, DO NOT EXPOSE THIS APPLIANCE TO RAIN OR OTHER MOISTURE. To avoid electrical shock, do not open the cabinet. Refer servicing to qualified personnel only. If the power supply cord (AC power cord) of this appliance is damaged, it must be replaced. Return to a SANYO Authorised Service Centre for replacement of the cord.

**CAUTION:** Do not put your hand or other objects in the cassette loading slot because of risk of injury or accident. Be sure to keep small children away from the VCR.

## Location

For safe operation and satisfactory performance of your VCR, keep the following in mind when selecting a place for its installation:

- Shield it from direct sunlight and keep it away from sources of intense heat.
- Avoid dusty or humid places.
- Avoid places with insufficient ventilation for proper heat dissipation. Do not block the ventilation holes at the top and bottom of the VCR. Do not place the unit on a carpet because this will block the ventilation holes.
- Install the VCR in a horizontal position only.
- Avoid locations subject to strong vibrations.
- Avoid moving the VCR between cold and hot locations (see "Moisture Condensation Problems", this page).
- Do not place the VCR directly on top of the TV, as this may cause playback or recording problems.

## Avoiding Electrical Shock and Fire

- Do not handle the power cord with wet hands.
- Do not pull on the power cord when disconnecting it from an AC wall outlet. Grasp it by the plug.
- If any liquid is spilled on the VCR, unplug the power cord immediately and have the unit inspected at a factory-authorized service centre.
- Do not place anything directly on top of this VCR.

## Moisture Condensation Problems

### Cause:

When the VCR is first installed, moved from a cold area to a warm area or placed in a location with high humidity, dew (moisture) may form in the unit. The Dew indicator (d d d d) blinks. If you operate the VCR with dew inside, damage may result.

### Prevention:

- 1 Make all necessary connections.
- 2 Plug the power cord into a 220 – 240 V AC outlet.
- 3 Do not operate the VCR for approximately 2 hours.

When the VCR reaches room temperature, the Dew indicator (d d d d) will turn off and the VCR will be ready to operate.

## Power on/stand-by mode

The power on/stand-by mode is selected by pressing the **STANDBY/ON** button.

### VCR display

Stand-by mode



Power on mode



"Stand-by mode" is the condition in which only the time is displayed.

Do not forget that even in the stand-by mode there is an electrical voltage inside the VCR as long as it is connected to a wall socket.

Disconnect the power cord from the wall socket if the VCR is not to be used for a long time.

Bij dit produkt zijn batterijen geleverd. Wanneer deze leeg zijn, moet u ze niet weggooien maar inleveren als KCA.

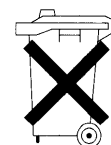

# FEATURES

- Clog detection
- Field recording/playback
- 8, 24-hour mode recording audio playback
- Autorepeat recording
- Series recording function
- Alarm recording function
- On-screen mode setting
- Integrated time date generator
- Day/Time search mode
- Alarm scan/search function
- Forward/Reverse field advance function
- 30-day memory backup
- Security lock
- Recording check function
- Head-cleaning function

# ACCESSORIES

Check to make sure that all the accessories listed below have been included with your VCR.

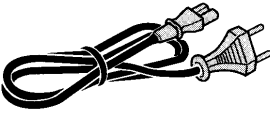
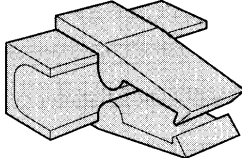
Power cord	Holder
	

# CONTENTS

PRECAUTIONS .....	1
FEATURES .....	2
ACCESSORIES .....	2
LOCATIONS OF CONTROLS AND INDICATORS .....	3
CONNECTIONS .....	6
VIDEO CASSETTE TAPES .....	8
TYPES OF ON-SCREEN DISPLAYS AND DISPLAY SEQUENCE .....	9
SETTING THE CLOCK AND LANGUAGE .....	10
CHANGING THE ON-SCREEN DISPLAY .....	11
NORMAL RECORDING .....	12
AUTOREPEAT RECORDING .....	13
PROGRAMME TIMER RECORDING .....	14
RECORDING USING AN EXTERNAL TIMER INPUT .....	16
ALARM RECORDING .....	17
SERIES RECORDING .....	19
NORMAL PLAYBACK .....	20
SPECIAL PLAYBACK .....	21
TAPE COUNTER .....	23
SETTING THE SECURITY LOCK .....	23
SETTING THE SW OUT TERMINAL OUTPUT .....	24
SETTING THE BUZZER .....	24
(OTHERS) MENU SETTINGS AND SETUP .....	25
SETTING THE HOLIDAYS .....	26
CLOCK ADJUSTMENT .....	27
(EJECT SET) MENU SETTINGS AND SETUP .....	28
CHECKING USAGE DURATION, POWER FAILURE AND FAILURE DUE TO CONDENSATION .....	29
CHECKING THE ALARM RECORDINGS TIME .....	29
ABOUT THE OUTPUT TERMINALS .....	30
DAILY INSPECTION .....	31
TROUBLESHOOTING GUIDE .....	32
SPECIFICATIONS .....	33

# LOCATIONS OF CONTROLS AND INDICATORS

## Front Panel

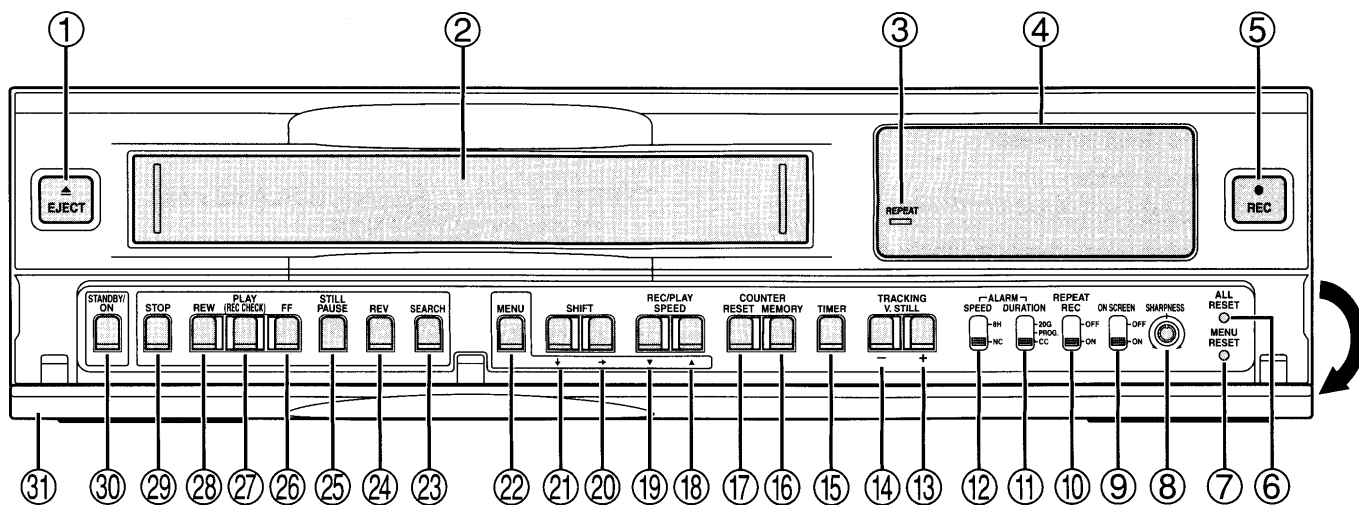

- ① **EJECT** button
- ② Cassette loading slot
- ③ **REPEAT** LED (autorepeat recording indicator)
- ④ Digital display panel
- ⑤ **REC** (record) button
- ⑥ **ALL RESET** button
- ⑦ **MENU RESET** button
- ⑧ **SHARPNESS** control
- ⑨ **ON SCREEN** switch
- ⑩ **REPEAT REC** (autorepeat recording) switch
- ⑪ **ALARM DURATION** (alarm recording time) switch
- ⑫ **ALARM SPEED** (alarm recording speed) switch
- ⑬ **TRACKING/V. STILL +** button
- ⑭ **TRACKING/V. STILL -** button
- ⑮ **TIMER** button
- ⑯ **COUNTER MEMORY** button
- ⑰ **COUNTER RESET** button
- ⑱ **REC/PLAY SPEED ▲** button  
(increase recording/playback speed)
- ⑲ **REC/PLAY SPEED ▼** button  
(decrease recording/playback speed)
- ⑳ **SHIFT →** (display position right) button
- ㉑ **SHIFT ↓** (display position down) button
- ㉒ **MENU** button
- ㉓ **SEARCH** button
- ㉔ **REV** (reverse playback) button
- ㉕ **STILL/PAUSE** button
- ㉖ **FF** (fast forward/cue) button
- ㉗ **PLAY (REC CHECK)** button
- ㉘ **REW** (rewind/review) button
- ㉙ **STOP** button
- ㉚ **STANDBY/ON** button
- ㉛ Front door

# LOCATIONS OF CONTROLS AND INDICATORS

## Digital Display

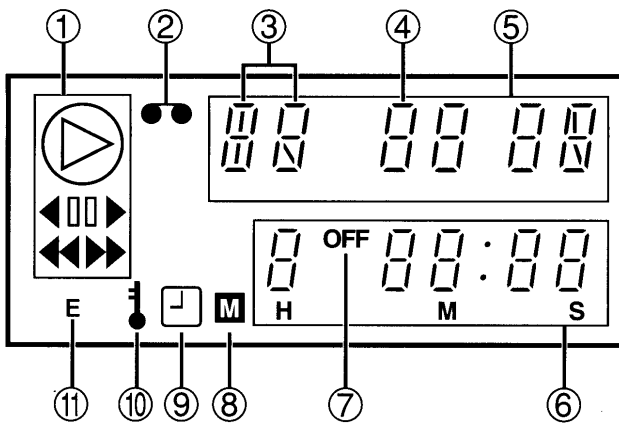

- ⑤ Mode display
- Recording/playback speed mode
  - Alarm search mode

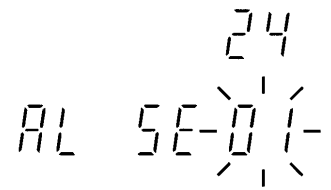

- Alarm scan mode
- Time/Date search mode

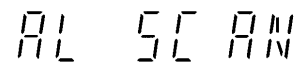

- Dew display

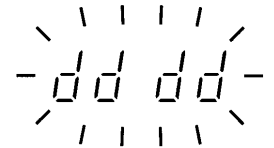

## ① Operation Indicators

- They display the actual operation mode.

Operation Mode	Indicator
Record (REC)	○
Record pause (REC PAUSE)	○ + [stop icon]
Playback (PLAY)	▷
Still image (STILL)	▷ + [stop icon]
Fast forward (FF)	▶▶
Rewind (REW)	◀◀
Cue (CUE)	▷ + ▶▶
Review (REVIEW)	▷ + ◀◀
Reverse playback (RVS PLAY)	▷ + [stop icon]
Field shift forward (FIELD SHIFT +)	▷ + [stop icon] + ▶
Field shift backward (FIELD SHIFT -)	▷ + [stop icon] + ◀

- ⑥ Counter display
- Time display

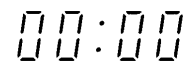

- Linear time counter display



- ⑦ OFF indicator OFF

Comes on when the tape end has been reached after a recording, except during autorepeat recording mode.

- ⑧ Memory Stop indicator [M]

Comes on when the memory stop function is engaged.

- ⑨ Timer Recording indicator [T]

Comes on when in timer recording stand-by mode, or during a timer recording.

- ⑩ Security lock indicator [lock icon]

Comes on when the security lock is engaged.

- ⑪ External input indicator E

Comes on when recording using the **EXT TIMER IN** input terminal.

- Clog detection indicator [sun icon]

Flashes when the recording quality deteriorates due to dirty VCR heads.

- ② Cassette indicator [cassette icon]

Comes on when a cassette is loaded.

- ③ Alarm indicator

Flashes when an alarm is being recorded:



Comes on after the alarm has been recorded:



- ④ Power Loss indicator [P]

Comes on after a power loss.

# LOCATIONS OF CONTROLS AND INDICATORS

## Back Panel

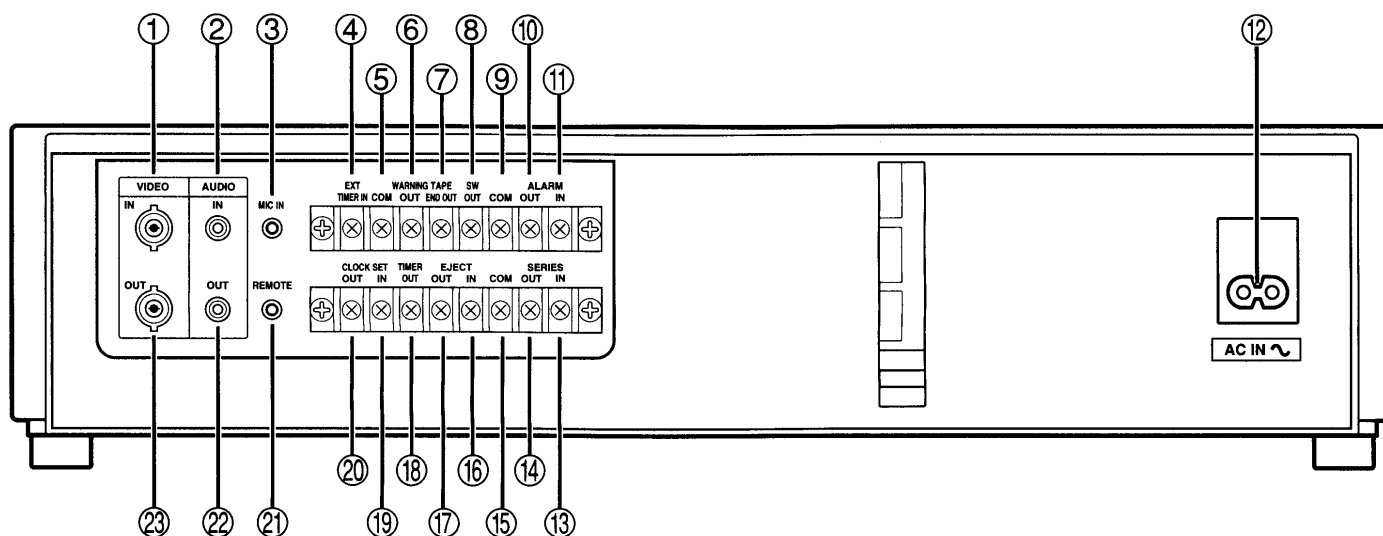

- ① VIDEO IN (video input) jack
- ② AUDIO IN (audio input) jack
- ③ MIC IN (microphone input) jack
- ④ EXT TIMER IN (external timer input) terminal
- ⑤ COM (common) terminal
- ⑥ WARNING OUT (warning output) terminal
- ⑦ TAPE END OUT (tape end output) terminal
- ⑧ SW OUT (switch output) terminal
- ⑨ COM (common) terminal
- ⑩ ALARM OUT (alarm output) terminal
- ⑪ ALARM IN (alarm input) terminal
- ⑫ AC Power input
- ⑬ SERIES IN (series recording trigger input) terminal
- ⑭ SERIES OUT (series recording trigger output) terminal
- ⑮ COM (common) terminal
- ⑯ EJECT IN (eject trigger input) terminal
- ⑰ EJECT OUT (eject trigger output) terminal
- ⑱ TIMER OUT (timer recording output) terminal
- ⑲ CLOCK SET IN (external clock set trigger input) terminal
- ⑳ CLOCK SET OUT (external clock set trigger output) terminal
- ㉑ REMOTE (remote control input) jack
- ㉒ AUDIO OUT (audio output) jack
- ㉓ VIDEO OUT (video output) jack

# CONNECTIONS

Connect the video camera and monitor TV as shown in the figure below.

**NOTE:** Before making the connections, make sure all the devices are disconnected from the power outlet.

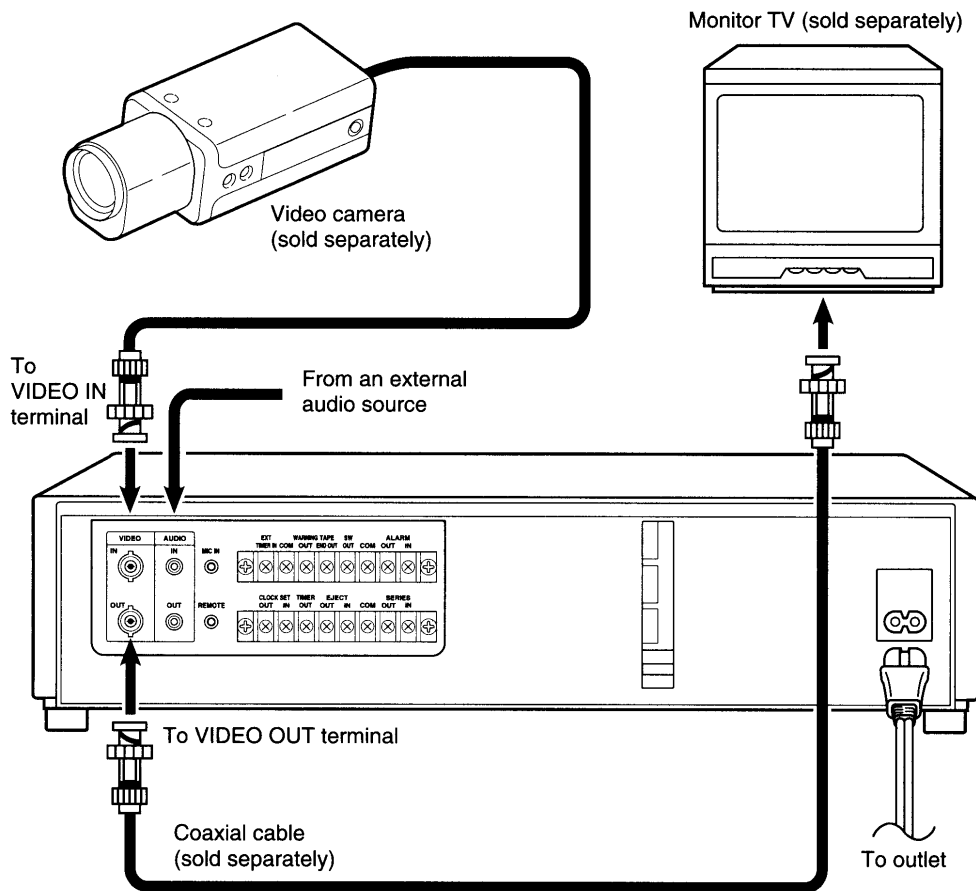

## IMPORTANT NOTE (U. K. Only)

The wires in the mains lead are coloured according to the following code:

**Blue: Neutral**

**Brown: Live**

If the colours of the wires in the mains lead of this apparatus do not correspond with the colour markings identifying the terminals in your plug, proceed as follows:

- The wire which is coloured blue must be connected to the terminal which is marked with the letter **N** or coloured blue or black.
- The wire which is coloured brown must be connected to the terminal which is marked with the letter **L** or coloured brown or red.
- Do not connect either wire to the **Earth** terminal.

## NOTE:

- For more details, please refer to the manuals accompanying all other devices. If the connections are not made properly, it may cause a fire or damage the equipment.

## CONNECTIONS

### Power cord

- 1 Plug the power cord (supplied) into the AC power input (AC IN ~) on the VCR back panel. Insert the plug straight and firmly.
- 2 Install the AC power cord into the holder.

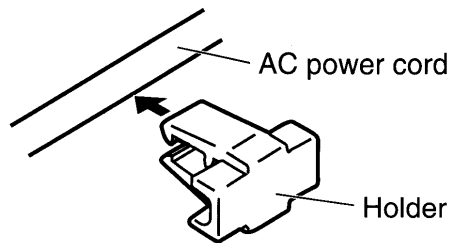

- 3 Fix the holder to the VCR back panel.

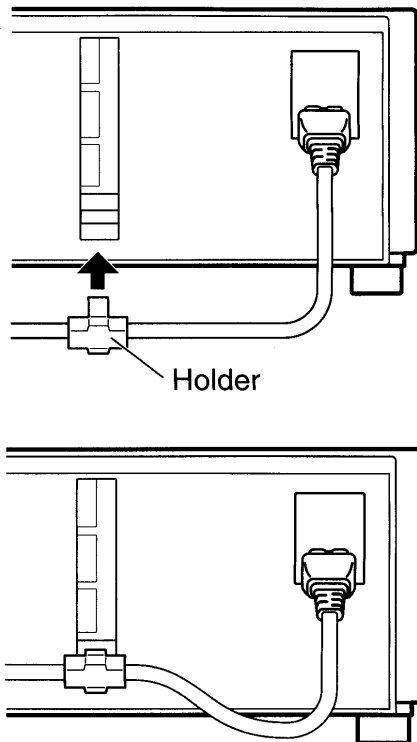

### About the memory reset

If the VCR location is changed or to cancel previous settings, please reset the memory as described below. The time and date will be reset.

To reset the memory, press the **ALL RESET** button.



# VIDEO CASSETTE TAPES

Use only video cassette tapes bearing the **VHS**. This VCR was primarily designed for use with E-240 cassette tapes, it is recommended to use E-240 VHS video cassette tapes for optimal performance.

## Handling Cassette Tapes

The cassette tapes should always be stored vertically, in their cases, away from high temperatures, magnetic fields, direct sunlight, dirt, dust and locations subject to mold formation.

Do not tamper with the cassette mechanism and never touch the tape with your fingers.

Protect the cassette tapes from shocks or strong vibrations.

## To Protect your Recordings

After having recorded a tape, if you wish to keep the recording, use a flathead screwdriver to break off the erasure-prevention tab on the cassette.

To record again on a tape without erasure-prevention tab, cover the hole with adhesive tape.

### NOTES:

- If you try to record on a cassette without erasure-prevention tab, the VCR will eject the cassette.
- If the **TIMER** button is pressed when a cassette without erasure-prevention tab is loaded, the timer recording indicator (□) will start flashing and a buzzer will sound.

## Erasure-prevention tab

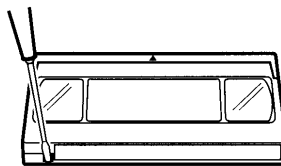

To prevent accidental erasure, remove the tab after recording.

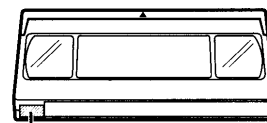

To record again, cover the hole with vinyl tape.

## Loading

- 1 Place the cassette, label side up, in the loading slot. Gently push the centre of the cassette until it is loaded automatically.
  - When the cassette is loaded, the cassette indicator "●●" will light on the digital display.
  - The time display will switch to the reset counter "0<sub>H</sub> 00<sub>M</sub> 00<sub>S</sub>" display.

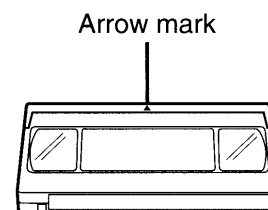
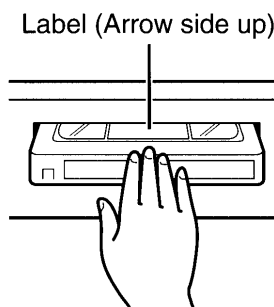

## Unloading

- 1 In STOP mode, press the **EJECT** button.
  - The cassette is automatically ejected.

### NOTES:

- Do not insert any object in the cassette loading slot, as that may cause injury and damages to the VCR.
- If your hand gets stuck in the cassette loading slot, unplug the power cord and consult the dealer where the unit was bought. Do not forcibly pull the hand out as that may cause severe injuries.

# TYPES OF ON-SCREEN DISPLAYS AND DISPLAY SEQUENCE

## NOTES:

- If the VCR is in timer recording stand-by mode (the "□" indicator displayed on the digital display), the on-screen displays will not be available. First press the **TIMER** button, to cancel the recording stand-by mode, then proceed with the VCR programming. When finished, press the **TIMER** button again to return the VCR to timer recording stand-by mode.
- When a menu is displayed, recording will not be possible.
- Press the **SEARCH** button, the setting procedure is now completed then the normal screen is displayed.
- During recording or playback the menus cannot be displayed.
- To reset the settings of a menu to their original values, select the desired menu then press the **MENU RESET** button. The MENU 7 (USED TIME) data cannot be reset.

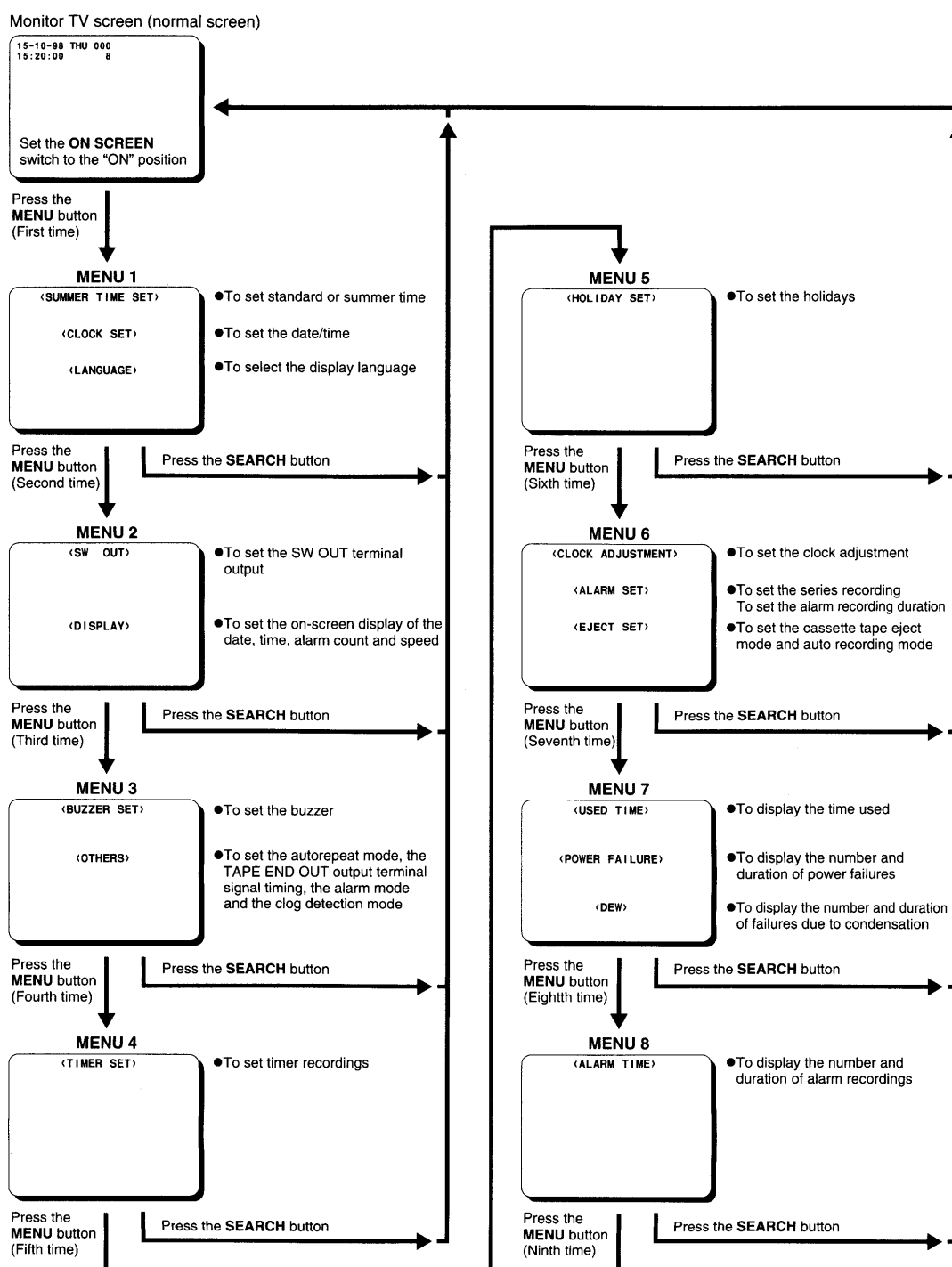

**Example:** To set the clock to October 15, 1998 at 3:20 PM (15:20).

### Clock and Language Setting

- 1 Turn the power on to all devices used.
- 2 Press the **MENU** button, the MENU 1 (CLOCK SET) is displayed.

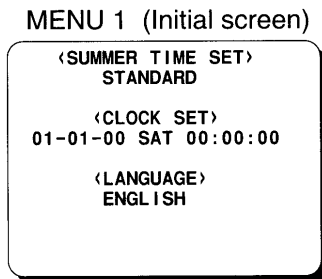

- 3 Press the **REC/PLAY SPEED** ▼ (or ▲) button, to set STANDARD (standard time)/SUMMER TIME (summer time).
- 4 Press the **SHIFT** ↓ button.
- 5 Press the **REC/PLAY SPEED** ▼ (or ▲) button, to set the day (ex: 15), then press the **SHIFT** → button.
  - *The day of the week is set automatically.*
- 6 Press the **REC/PLAY SPEED** ▼ (or ▲) button, to set the month (ex: 10), then press the **SHIFT** → button.
- 7 Press the **REC/PLAY SPEED** ▼ (or ▲) button, to set the year (ex: 98 for 1998), then press the **SHIFT** → button.

#### NOTE:

- The last 2 digits only are displayed.

- 8 Press the **REC/PLAY SPEED** ▼ (or ▲) button, to set the hours (ex: 15 for 3 PM), then press the **SHIFT** → button.
- 9 Press the **REC/PLAY SPEED** ▼ (or ▲) button, to set the minutes (ex: 20), then press the **SHIFT** → button.
- 10 For accurate clock setting, press the **REC/PLAY SPEED** ▼ button timed with a time broadcast, or other accurate time signal, this will start the seconds counting from 00.
- 11 Press the **SHIFT** ↓ button.

- 12 Press the **REC/PLAY SPEED** ▼ (or ▲) button, to set the language.
  - *Each time the REC/PLAY SPEED ▼ (or ▲) button is pressed, a different language, ENGLISH – FRANCAIS – DEUTSCH, is selected.*

#### MENU 1 Example setting

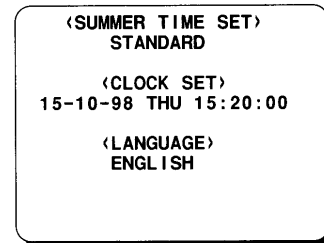

- 13 Press the **SEARCH** button, the normal screen is displayed.
  - *The setting procedure is now completed.*

#### NOTE:

- If a cassette tape is not loaded, you can reset the seconds to "00", by pressing the **COUNTER RESET** button.

### Standard/Summer Time Adjustment

The clock time can be changed to summer time (by adding one hour) or standard time (by subtracting one hour).

- 1 Press the **MENU** button, the MENU 1 (SUMMER TIME SET) is displayed.

#### MENU 1 Example setting

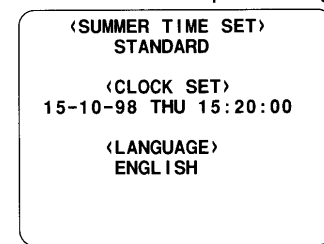

- 2 Press the **REC/PLAY SPEED** ▼ (or ▲) button.
  - *The display changes to SUMMER TIME (or STANDARD).*
  - *One hour is added to (or subtracted from) the current time.*
- 3 Press the **SEARCH** button, the normal screen is displayed.
  - *The setting procedure is now completed.*

# CHANGING THE ON-SCREEN DISPLAY MENU 2

## Selecting the On-screen Display

You can select to display or not the date, time, the number of alarm triggers and tape speed.

- 1 Turn the power on to all devices used.
- 2 Press the **MENU** button, the MENU 2 (DISPLAY) is displayed.

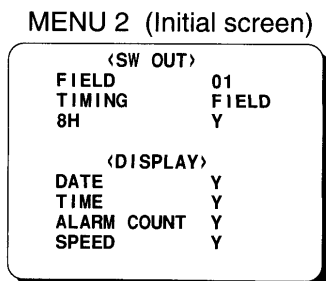

- 3 Press the **SHIFT ↓** button, until the desired item for which the display function will be set is flashing.
- 4 Press the **REC/PLAY SPEED ▼** (or **▲**) button to set "Y" for the functions described below.
  - DATE ..... The Day-Month-Year is displayed
  - TIME ..... The time is displayed
  - ALARM COUNT ... The number of alarm triggers is displayed
  - SPEED ..... The recording/playback speed is displayed
- 5 Press the **SEARCH** button, the normal screen is displayed.
  - *The setting procedure is now completed.*

### NOTE:

- If the **ON SCREEN** switch is set to the "ON" position, the items for which "Y" is set are recorded. The items for which "N" was set at step 4 above are not recorded.

## Changing the Date/Time Display Position

- 1 Turn the power on to all devices used.
- 2 Set the **ON SCREEN** switch to the "ON" position.
  - *The date and time are displayed.*

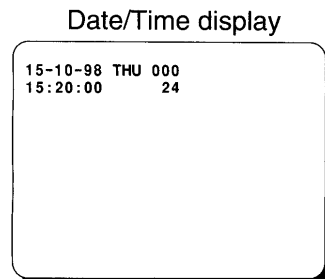

- 3 Press the **SHIFT →** (or **↓**) button.
  - *The display will move towards the right (or the bottom).*

### NOTE:

- If the **SHIFT →** (or **↓**) button is kept pressed for 1 second or more the display will move at a faster speed.

# NORMAL RECORDING

## Normal Recording

- 1 Turn the power on to all devices used.
- 2 Load a cassette tape with erasure-prevention tab.

### NOTE:

- If in the MENU 6 (EJECT SET), AUTO REC is set to "Y", recording will start.

- 3 Set the **ON SCREEN** switch to the "ON" position.
- 4 Press the **REC/PLAY SPEED** ▼ (or ▲) button to set the recording speed.

- *The recording speed is displayed on-screen and on the digital display.*

- 5 Press the **REC** button.

- *The "O" indicator is displayed on the digital display and recording starts.*

### NOTES:

- If the **REPEAT REC** switch is set to the "OFF" position, recording will continue to the end of the tape, then the VCR will rewind the tape to the beginning then stop. ("OFF" will be displayed on the digital display.)
- If in the MENU 3 (BUZZER SET), TAPE END is set to "Y", the buzzer will be heard as long as "OFF" is displayed on the digital display.
- To cancel the "OFF" display, press the **EJECT**, **PLAY**, **STOP**, **FF** or **REW** button.

- 6 To stop recording, press the **STOP** button.

### NOTES:

- A tape recorded on this VCR cannot be played back on another make of time lapse VCR.
- If you press on the **REC** button and the loaded cassette has no erasure-prevention tab, the VCR will eject the cassette.
- During recording, the **MENU** button will not function (the menu cannot be displayed).
- During recording, the tape speed cannot be changed.

## [Recording Speed]

Recording speed	Maximum recording duration (with an E-240 cassette tape)		Recording interval	Audio recording	Tape motion
8	Standard mode	8 hours	1/50 second	Possible	Continuous
24	Real time mode	24	3/50		

## Record Pause

Recording can be interrupted temporarily.

- 1 Press the **STILL/PAUSE** button during recording.
  - *The "O" and "|||" indicators are displayed on the digital display.*

### NOTES:

- The image appears on-screen but it is not recorded.
  - If a recording pause continues for 5 minutes or more, the VCR will go into stop mode to avoid damaging the tape.
- 2 To resume recording, press the **REC** button, or press the **STILL/PAUSE** button again.

## Recording Check

The image being recorded can be checked.

- 1 During recording, press the **PLAY (REC CHECK)** button.
  - *The tape will be rewound and then played back. The VCR will then return to the previous recording mode.*

### NOTE:

- During recording check operations, recording is suspended momentarily.

## Clog Detection

The recording quality is monitored automatically. When the heads are dirty and the recording quality deteriorates, the output at the WARNING OUT terminal becomes 0V (Low), the "O" indicator flashes on the digital display, and the buzzer sounds.

For more information on how to set this function, refer to (OTHERS) MENU SETTINGS AND SETUP on page 25.

### NOTES:

- To cancel the "O" indicator display and reset the WARNING OUT terminal output, press the **STOP** or **EJECT** button.
- Clog detection is not possible if recording in 8-hour recording mode.

### Autorepeat Recording

The same tape can be recorded over many times.

- 1 Press the **MENU** button to display the MENU 3 (OTHERS).

MENU 3 (Initial screen)

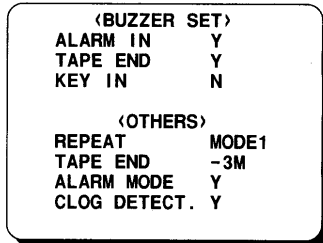

- 2 Press the **SHIFT ↓** button, until the "REPEAT" setting is flashing.
- 3 Press the **REC/PLAY SPEED ▼** (or **▲**) button to set the desired autorepeat recording mode.
  - MODE 1 ..... The autorepeat mode is automatically canceled if there is an alarm trigger
  - MODE 2 ..... Autorepeat recording takes place even if there is an alarm trigger
- 4 Press the **SEARCH** button, the normal screen is displayed.
  - *The setting procedure is now completed.*
- 5 Set the **REPEAT REC** switch to the "ON" position.
  - *The REPEAT LED will light.*
  - ON ..... Autorepeat recording function on
  - OFF ..... Autorepeat recording function off
- 6 Press the **REC** button.
  - *Recording will start. When the tape end is reached, the VCR will rewind it to the beginning regardless of the counter memory, and recording will resume.*

### NOTES:

- If during autorepeat recording mode, the **REPEAT REC** switch is set to the "OFF" position, the recording will continue to the end of the tape then it will be rewound to the beginning and stop. "OFF" will be displayed on the digital display.
- If during autorepeat recording there is an alarm trigger, "AL" is displayed on the digital display and alarm recording will take place. (Please refer to page 17, "ALARM RECORDING".)
- If the "REPEAT" setting is MODE 1, the REPEAT LED will go off if there is an alarm trigger.

# PROGRAMME TIMER RECORDING ① MENU 4

There are two programme timer recording methods, daily recording or recording on certain days of the week.

**Example 1:** To record on every Saturday from 9:00 AM to 5:00 PM (17:00), in 24-hour mode (recording speed).

- ① Make sure that the set date and time are correct.
- ② Load a cassette tape with erasure-prevention tab.
- ③ Press the **MENU** button to display the MENU 4 (TIMER SET).
  - "SUN" (Sunday) will be flashing.

MENU 4 (Initial screen)

<TIMER SET>			
	START	STOP	SPD
SUN	---	---	N
MON	---	---	N
TUE	---	---	N
WED	---	---	N
THU	---	---	N
FRI	---	---	N
SAT	---	---	N
DLY	---	---	N
EXT	*****	*****	N

- ④ Press the **SHIFT** ↓ button, until "SAT" (Saturday) is flashing.
- ⑤ Press the **SHIFT** → button.
  - The recording start hour position starts flashing.
- ⑥ Press the **REC/PLAY SPEED** ▼ (or ▲) button to set the recording start hour (ex: 09), then press the **SHIFT** → button.
  - The recording start minutes position starts flashing.
- ⑦ Press the **REC/PLAY SPEED** ▼ (or ▲) button to set the recording start minutes (ex: 00), then press the **SHIFT** → button.
  - The recording stop hour position starts flashing.
- ⑧ Press the **REC/PLAY SPEED** ▼ (or ▲) button to set the recording stop hour (ex: 17), then press the **SHIFT** → button.
  - The recording stop minutes position starts flashing.

**NOTE:**

- If the set stop time is earlier than or the same time as the set start time, the VCR will consider the stop time to be the following day, and "T" will be displayed next to the recording stop time.

- ⑨ Press the **REC/PLAY SPEED** ▼ (or ▲) button to set the recording stop minutes (ex: 00), then press the **SHIFT** → button.
  - The "SPD" (recording speed) position will start flashing.
- ⑩ Press the **REC/PLAY SPEED** ▼ (or ▲) button to select the recording speed (ex: 24), then press the **SHIFT** → button.
  - "N" will start flashing.
- ⑪ Press the **REC/PLAY SPEED** ▼ (or ▲) button to select "Y".

Y . . . . . recording will take place  
 N . . . . . recording will not take place

Programmed timer recording Example 1

<TIMER SET>			
	START	STOP	SPD
SUN	---	---	N
MON	---	---	N
TUE	---	---	N
WED	---	---	N
THU	---	---	N
FRI	---	---	N
SAT	09:00	17:00	24 Y
DLY	---	---	N
EXT	*****	*****	N

- Repeat steps ④ to ⑪ to programme timer recordings for other days of the weeks.
- ⑫ Press the **SEARCH** button, the normal screen is displayed.
  - ⑬ Press the **TIMER** button.
    - The timer recording indicator "☐" will light on the digital display, the VCR is now in timer recording stand-by mode.

**NOTES:**

- To modify, cancel or stop timer recording, press the **TIMER** button to cancel the timer recording mode.
- A timer recording of more than 24 hours can only be set on the last two (7th and 8th) lines. On the 7th line, set the recording start time and set "★★" for the rest of the line. On the 8th line, set "★★" for the START time position, then set the recording stop time, recording speed, and select "Y" or "N".

# PROGRAMME TIMER RECORDING ② MENU 4

## Changing a Programme Timer Recording

- 1 Press the **MENU** button to display the MENU 4 (TIMER SET).
- 2 Press the **SHIFT** → (or ↓) button, until the setting to correct is flashing.
- 3 Press the **REC/PLAY SPEED** ▼ (or ▲) button, to correct the setting.
- 4 Press the **SEARCH** button, the normal screen is displayed.
- 5 Press the **TIMER** button.

## To Cancel a Programme Timer Recording

- 1 Press the **MENU** button to display the MENU 4 (TIMER SET).
- 2 Press the **SHIFT** → (or ↓) button, until the "Y" corresponding to the timer recording to cancel is flashing.
- 3 Press the **REC/PLAY SPEED** ▼ (or ▲) button, to select "N".
- 4 Press the **SEARCH** button, the normal screen is displayed.
- 5 Press the **TIMER** button.

## To Cancel all Programme Timer Recordings

- 1 Press the **MENU** button to display the MENU 4 (TIMER SET).
- 2 Press the **MENU RESET** button.
  - All programmed timer recordings are erased.
- 3 Press the **SEARCH** button, the normal screen is displayed.

## NOTES:

- During timer recording or timer recording stand-by, all the buttons on the VCR, except the **TIMER** button, are disabled.
- If the power fails, the recording will be interrupted. When the power is restored, the recording will resume if the stop time has not yet been reached, and "P" will be displayed on the digital display. The VCR internal battery is completely recharged after the VCR has been connected to a live outlet for 48 hours, and it will maintain all the VCR settings memory for up to 30 days.
- Set the timer recordings so that the recording times do not overlap. If they do, the one with the earliest recording start time will have priority. (See chart below.)

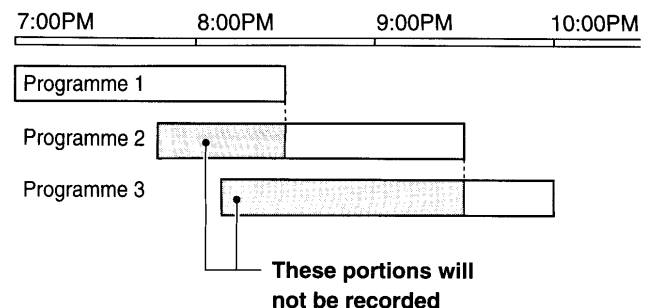

- To set two or more timer recordings for a same day of the week, press the **SHIFT** → (or ↓) button, until the day of the week for the second recording is flashing, then press the **REC/PLAY SPEED** ▼ (or ▲) button, to set the desired day of the week.
- If no timer recording is set, when the **TIMER** button is pressed the timer recording indicator "□" will start flashing and a buzzer will be heard.
- If "OFF" is displayed on the digital display, timer recording is not possible in order to prevent the recorded tape to be recorded over.



# RECORDING USING AN EXTERNAL TIMER INPUT

MENU 4

Recording can be controlled by an external start/stop signal input at the **EXT TIMER IN** terminal.

**Example 2:** To record using the signal input at the **EXT TIMER IN** terminal, in 24-hour mode.

## NOTES:

- External timer input recording can only be set on the 9th line ("EXT") of the MENU 4 (TIMER SET).
- When there is a single being input at the **EXT TIMER IN** terminal, "E" will be displayed on the digital display and recording is conducted.

- 1 Follow steps 1 to 3 under "PROGRAMME TIMER RECORDING ①".

MENU 4 (Initial screen)

<TIMER SET>			
	START	STOP	SPD
SUN	---:--	---:--	--- N
MON	---:--	---:--	--- N
TUE	---:--	---:--	--- N
WED	---:--	---:--	--- N
THU	---:--	---:--	--- N
FRI	---:--	---:--	--- N
SAT	---:--	---:--	--- N
DLY	---:--	---:--	--- N
EXT	*****	*****	--- N

← 9th line

- 2 Press the **SHIFT ↓** button, until "EXT" (External) setting is flashing.
  - The "SPD" (recording speed) position will start flashing.
- 3 Press the **REC/PLAY SPEED ▼** (or **▲**) button to select the recording speed (ex: 24), then press the **SHIFT →** button.
  - "N" will start flashing.
- 4 Press the **REC/PLAY SPEED ▼** (or **▲**) button to select "Y".

Example 2

<TIMER SET>			
	START	STOP	SPD
SUN	---:--	---:--	--- N
MON	---:--	---:--	--- N
TUE	---:--	---:--	--- N
WED	---:--	---:--	--- N
THU	---:--	---:--	--- N
FRI	---:--	---:--	--- N
SAT	---:--	---:--	--- N
DLY	---:--	---:--	--- N
EXT	*****	*****	24 Y

- 5 Follow steps 12 and 13 under "PROGRAMME TIMER RECORDING ①".

- When an external signal is input, "E" will light on the digital display and recording will take place.

## NOTES:

- Other timer recordings using the standard procedure can also be programmed.
- The external input signal must be input at the **EXT TIMER IN** input terminal.

By connecting the **ALARM IN** terminal to a door switch, an interphone, etc., a recording can be done only when necessary.

### Alarm Recording Setting

Alarm recording is performed when there is an input (trigger) at the **ALARM IN** terminal, "AL" is displayed on the digital display.

- ❶ Make all necessary connections.
- ❷ Press the **MENU** button to display the MENU 3 (OTHERS).
- ❸ Press the **SHIFT ↓** button, until the "ALARM MODE" setting is flashing.
  - Please refer to page 25, on how to set the "ALARM MODE" in the menu "OTHERS".
- ❹ Set the **ALARM SPEED** switch to the desired recording speed.
  - 8H . . . . . 8-hour mode recording
  - NC . . . . . Recording at the speed already set
- ❺ Set the **ALARM DURATION** switch to the desired recording duration.
  - 20S . . . . . 20-second recording
  - PROG. . . . . Recording for the duration set for the "DURATION" item in the MENU 6 (ALARM SET).
  - CC . . . . . Recording as long as the alarm signal is being input (minimum recording of 5 seconds)
- ❻ Press the **MENU** button to display the MENU 6 (ALARM SET).

MENU 6 (Initial screen)

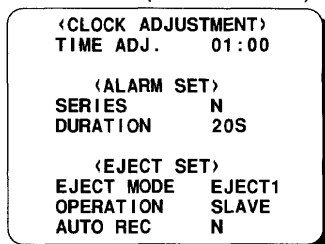

- ❼ Press the **SHIFT ↓** button, until the "SERIES" (series recording) setting is flashing.
- ❽ Press the **REC/PLAY SPEED ▼** (or ▲) button to select "Y" or "N".
  - N . . . . . The alarms are received while in recording, stop and stand-by modes.
  - Y . . . . . The alarms are received while in recording mode only.

#### NOTE:

- If the **ALARM DURATION** switch is set to the "PROG." position, please continue with steps ❸ and ❹.
- ❾ Press the **SHIFT ↓** button, the "DURATION" (alarm recording duration) setting starts flashing.
  - ❿ Press the **REC/PLAY SPEED ▼** (or ▲) button to select the desired alarm recording duration (20 seconds – 5 minutes or CC).
  - ⓫ Press the **SEARCH** button, the normal screen is displayed.
    - *The setting procedure is now completed.*

#### NOTES:

- During alarm recording all buttons are disabled.
- If "OFF" is displayed on the digital display, alarm recording is not possible in order to prevent the recorded tape to be recorded over.
- If an alarm trigger is received while alarm recording is in progress, recording duration for the second alarm will be calculated from that point. The alarm counter will register the alarm, but it will not be found during alarm scan or alarm search.
- If there is a power failure during alarm recording, and the power is restored within the recording set duration, alarm recording will continue.
- If the alarm scan or alarm search functions will be used to review the recordings, set the recording speed to 8-hour mode and the recording duration to 20 seconds or more.

# ALARM RECORDING

## Alarm Recording Counter Display

- During alarm recording, "RL" will be flashing on the digital display.
- If the **ON SCREEN** switch is set to the "ON" position, the number of alarms will flash on the monitor screen.
- The maximum display number of alarm triggers is "999", at the next alarm recording the counter will indicate "000".
- When the MENU 8 (ALARM TIME) is displayed, press the **MENU RESET** button to reset the alarm counter to "000" (all the data of MENU 8 is reset).

## Connections to the ALARM IN/OUT Terminals

- Alarm input signal  
Connect a make-contact (no voltage) switch between the **ALARM IN** and **COM** terminals.
- Alarm output signal  
Normally DC 5V are output between the **ALARM OUT** and the **COM** terminals. When an alarm input (trigger) is received and the unit is recording, the output falls to 0V. Once the alarm recording is over, the output returns to DC 5V.

# SERIES RECORDING

Using 2 VCRs or more, the series recording function lets you switch recording from one unit to the next (only with VCRs of the same model as this one).

## Series Recording Setup

- ❶ Connect 2 VCRs or more as illustrated below.
- ❷ Set the following items as indicated.

Item	VCR No.1	VCR No.2 and on
Cassette tape	Loaded	Loaded
Operation mode	Stop	Stop
REPEAT REC switch	OFF	OFF
Counter memory	Canceled	Canceled
"SERIES" (in MENU6 (ALARM SET))	Y (YES)	Y (YES)
Timer recording	OFF (not set)	OFF (not set)
Power	ON	Stand-by
Security lock	Canceled	Set

- ❸ Press the **REC** button on VCR No.1.
  - Recording will start in series recording mode.
- ❹ Set the security lock on VCR No.1.
  - When the counter on VCR No.1 reaches 7<sub>H</sub>57<sub>M</sub>00<sub>S</sub> or if the end of the tape is reached, the output at the **SERIES OUT** connector will switch from High to Low. This will turn on the power on VCR No.2 and recording will start.
  - When the end of the tape is reached on VCR No.1, the tape will rewind and stop. ("OFF" will be displayed on the digital display.)

### NOTES:

- During series recording, autorepeat recording or timer recording are not possible.
- If the counter reading on VCR No.1 is 7<sub>H</sub>57<sub>M</sub>00<sub>S</sub> or more, when the **REC** button is pressed (step ❸), it will turn the power on and recording will start on VCR No.2.

## Series recording connections

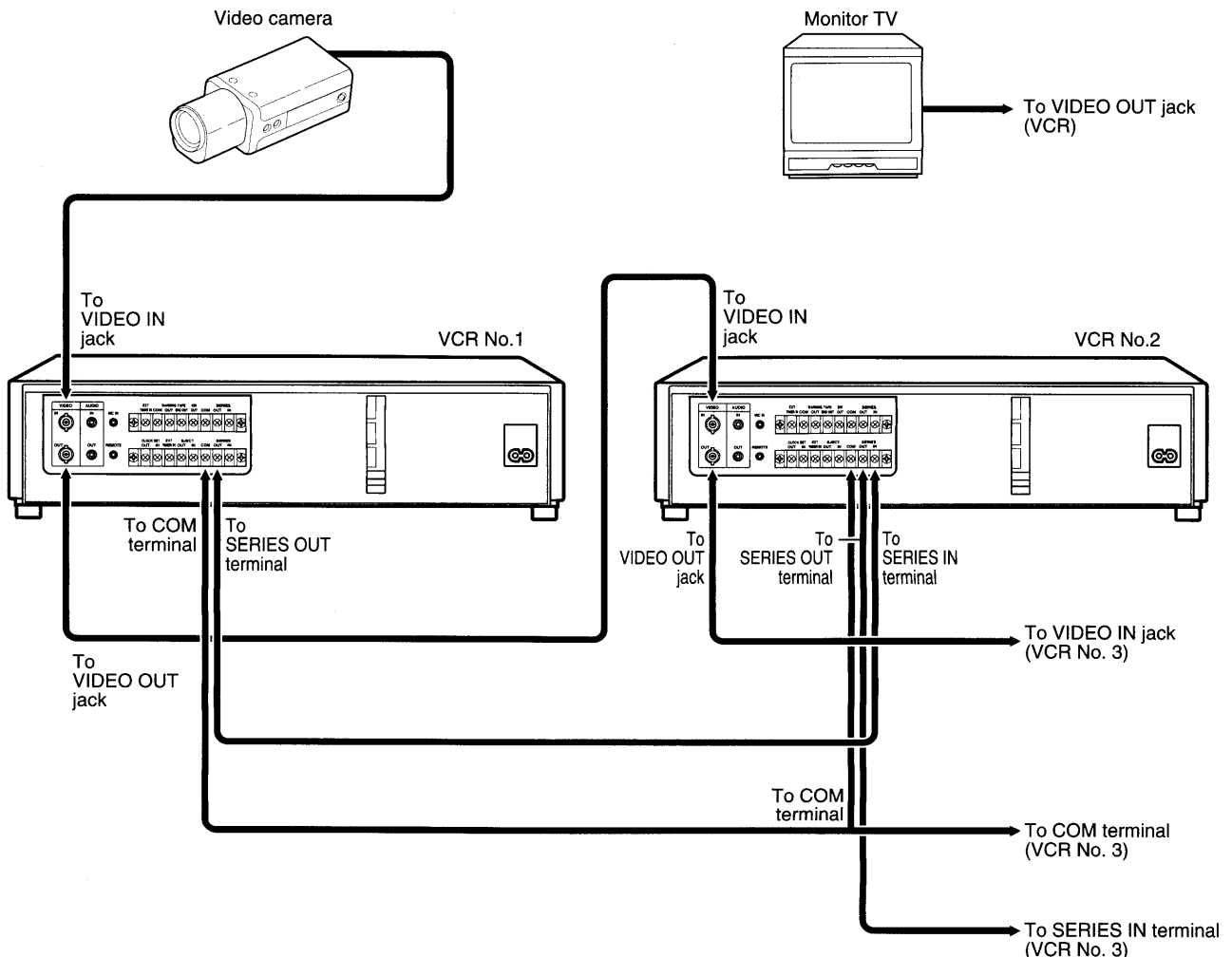

# NORMAL PLAYBACK

## Normal Playback

- ❶ Turn on the power to the VCR and TV monitor.
- ❷ Load the video cassette tape.
- ❸ Press the **REC/PLAY SPEED** ▼ (or ▲) button to select the playback speed.
  - *The selected playback speed is displayed on the digital display.*

### NOTE:

- A slow motion effect or accelerated playback effect can be achieved by using a slower or faster playback speed than the speed used for recording.
- ❹ Press the **PLAY** button.
    - *Playback starts.*
    - *If necessary, adjust the tracking to eliminate the noise from the picture.*
  - ❺ To stop playback, press the **STOP** button.
    - *To advance or rewind the tape, press the **FF** or **REW** button.*

### NOTES:

- A tape recorded on another make of time lapse VCR cannot be played back on this unit.
- A tape recorded on this VCR cannot be played back on another make of time lapse VCR.
- If a tape recorded in SP mode on a standard VCR is loaded, playback will be done in 3-hour mode.

## Tracking Control

If there is noise in the image during playback,

- ❶ While looking at the playback picture, press and hold the **TRACKING/V. STILL+** button to minimize the noise.
- ❷ If it cannot be minimized, press the **TRACKING/V. STILL-** button.

## Sharpness Control

Adjust the **SHARPNESS** control towards "SHARP" or "SOFT" for the desired sharpness of the image.

## Audio Playback

- The playback speed has to be the same as the recording speed, for normal playback of the audio.

### NOTE:

- Noise will appear in the image when audio playback is used.

# SPECIAL PLAYBACK ①

## Picture Search

- 1 Press the **FF** (or **REW**) button, during normal playback.
  - *The image can be seen while the tape is advanced (or rewound) at high speed.*
- 2 To return to normal playback, press the **PLAY** button.

### NOTES:

- During picture search, noise (horizontal bars) will appear in the picture.
- The sound is muted.

## Still Image

- 1 Press the **STILL/PAUSE** button, during normal playback.
  - *A still image can be viewed.*
- 2 To return to normal playback, press the **PLAY** button.

### NOTES:

- If still mode continues for 5 minutes or more, the VCR will go into stop mode to avoid damaging the tape.
- If the image is unstable (rolling vertically), adjust the vertical lock control to correct.

## Vertical Lock Control

During still image mode,

- 1 Press and hold the **TRACKING/V. STILL+** button to reduce the vertical rolling of the image.
- 2 If it cannot be corrected, press the **TRACKING/V. STILL-** button.

## Frame Advance

- 1 Press the **FF** (or **REW**) button, during still image mode.
  - *The still image is advanced (or rewinded) of one image (field).*
- 2 To return to normal playback, press the **PLAY** button.

### NOTE:

- During reverse frame advance, noise will appear in the picture.

## Reverse Playback

- 1 Press and hold the **REV** button, during normal playback.
  - *Reverse playback will start.*
- 2 To return to normal playback, release the **REV** button.

### NOTES:

- During reverse playback, noise will appear in the picture.
- Reverse playback is only possible during 8-hour playback speed mode.
- The sound is muted.

# SPECIAL PLAYBACK ②

## Alarm Search

To go to the beginning of a desired alarm recording.

- 1 Press the **SEARCH** button during stop mode.
  - "AL SEARCH 01" will be displayed on screen.
- 2 Press the **REC/PLAY SPEED** ▼ (or ▲) button to set the desired alarm number (1 to 99), then press the **FF** (or **REW**) button.
  - The desired alarm is searched and a still image of the beginning of the alarm recording will appear on-screen.

### NOTE:

- The alarm number is relative to the actual tape position. (Please refer to the illustration below.)

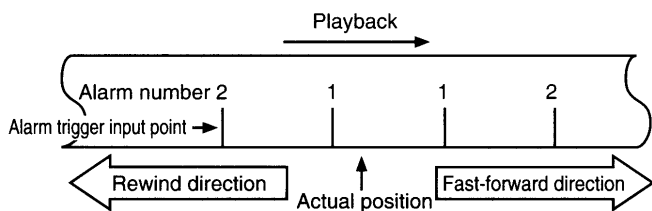

- 3 Press the **PLAY** button.
  - Playback will start.

## Alarm Scan

To look for an alarm recording by viewing the first 5 seconds of each alarm recording.

- 1 Press the **SEARCH** button twice during stop mode.
  - "AL SCAN" will be displayed on screen.
- 2 Press the **FF** (or **REW**) button.
  - The unit will advance (or rewind) the tape at high speed and playback the first 5 seconds of every alarm recording.
  - To cancel the alarm scan mode, press the **STOP** button.
- 3 While the desired recording is being played back, press the **PLAY** button.
  - Playback will start, alarm scan mode is cancelled.

### NOTE:

- The alarm scan and alarm search functions will only be possible if the recording speed was set to 8-hour mode and the recording duration to 20 seconds or more.

## Day/Time Search

To search for a recording when the date and time the recording was performed on are known.

- 1 Press the **SEARCH** button three times during stop mode.
  - "T/D SEARCH 01 00" will be displayed on screen.

### Date/Time Search Example

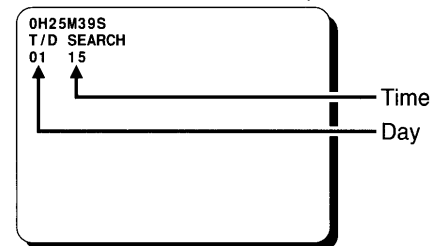

- 2 Press the **REC/PLAY SPEED** ▼ (or ▲) button to set the desired day, then press the **SHIFT** → button.
- 3 Press the **REC/PLAY SPEED** ▼ (or ▲) button to set the desired hour.
- 4 Press the **FF** (or **REW**) button.
  - The desired day/time is searched and a still image of the recording will appear on-screen.
- 5 Press the **PLAY** button.
  - Playback will start.

### NOTES:

- If during a search the end of the tape is reached, the tape will rewind and stop. If the beginning of the tape is reached, it will stop.
- Day/time search may not function properly on tapes used for alarm recording.
- The day/time search function may not operate correctly if searching for a timer recording time or CLOCK ADJUSTMENT time.

# TAPE COUNTER

Using the counter, it is easy to find a desired recording.

- ❶ Press the **COUNTER RESET** button, at the beginning of the desired recording.
  - *The counter will be reset to "0<sub>H</sub> 00<sub>M</sub> 00<sub>S</sub>".*
- ❷ Press the **COUNTER MEMORY** button.
  - *"M" is displayed on the digital display.*
  - *To cancel the counter memory function, press the **COUNTER MEMORY** button a second time.*
- ❸ After recording or playback, press the **REW** button in stop mode.
  - *The tape is rewound to the counter "0<sub>H</sub> 00<sub>M</sub> 00<sub>S</sub>" reading.*
  - *If you rewind the tape past the "0<sub>H</sub> 00<sub>M</sub> 00<sub>S</sub>" position, press the **FF** button.*

## NOTES:

- There is no tape counter indication for the blank portions of the tape.
- In the 8-hour recording speed mode only, the tape counter indicates real hours, minutes and seconds.
- In the other recording speed modes, the tape counter indication is a ratio of the 8-hour mode base indication. (In 24-hour recording mode, each "second" of the tape counter actually represents approximately  $24/8 = 3$  real seconds.)
- There may be a slight discrepancy between the position shown on the tape counter and the actual tape position.
- When rewinding the tape past the "0<sub>H</sub> 00<sub>M</sub> 00<sub>S</sub>" position, a minus (-) sign will be displayed.

# SETTING THE SECURITY LOCK

The security lock function is designed to prevent accidental stopping of recording if the **STOP** button is pressed inadvertently.

- ❶ While holding the **SHIFT** → button, press the **REC/PLAY SPEED** ▲ button.
    - *"1" is displayed on the digital display.*
- To cancel the security lock, while holding the **SHIFT** → button, press the **REC/PLAY SPEED** ▼ button, "1" will be erased from the digital display.

## NOTES:

- While the security lock is engaged all commands, except the one to cancel the security lock, are disabled.
- The security lock cannot be engaged while a menu is displayed.



# SETTING THE SW OUT TERMINAL OUTPUT

## MENU 2

While recording, different outputs can be selected for the SW OUT terminal.

- 1 Press the **MENU** button, the MENU 2 (SW OUT) is displayed.

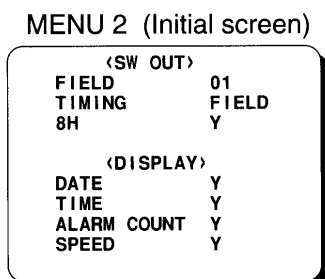

- 2 Press the **REC/PLAY SPEED** ▼ (or ▲) button to set the "FIELD" (or "FRAME").
  - With each press of the button, the setting will change as indicated below.

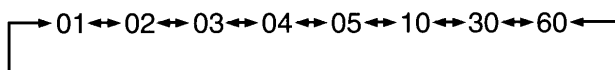

### NOTE:

- If "TIMING" is set to FRAME (see step 4), "FRAME" will be indicated instead of "FIELD".

- 3 Press the **SHIFT** ↓ button.
  - The "TIMING" setting starts flashing.

- 4 Press the **REC/PLAY SPEED** ▼ (or ▲) button to set the "TIMING".
  - FIELD . . . 1 pulse is output after each set number of fields.
  - FRAME . . . 1 pulse is output after each set number of frames.

- 5 Press the **SHIFT** ↓ button.
  - The "8H" setting starts flashing.
- 6 Press the **REC/PLAY SPEED** ▼ (or ▲) button to set the "8H".
  - Y . . . . . When recording in 8-hour mode, a pluse signal is output.
  - N . . . . . When recording in 8-hour mode, a pulse signal is not output.
- 7 Press the **SEARCH** button, the normal screen is displayed.
  - The setting procedure is now completed.

# SETTING THE BUZZER

## MENU 3

If desired a buzzer can warn you when an alarm recording is taking place, when the tape has reached the end or when buttons are being pressed on the VCR.

- 1 Press the **MENU** button to display the MENU 3 (BUZZER SET).

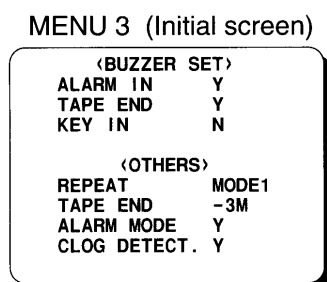

- 2 Press the **SHIFT** ↓ button, until the desired item for which the buzzer function will be set is flashing.

- 3 Press the **REC/PLAY SPEED** ▼ (or ▲) button to set "Y" for the functions described below.
  - ALARM IN . . . . . The buzzer will be heard during alarm recording.
  - TAPE END . . . . . The buzzer will be heard when the end of the tape is reached during recording.
  - KEY IN . . . . . The buzzer will be heard when one of the VCR buttons is pressed.
- 4 Press the **SEARCH** button, the normal screen is displayed.
  - The setting procedure is now completed.

### NOTES:

- If "N" is set, the buzzer will not be heard.
- During timer recording mode, security lock engaged mode and alarm recording mode, the buzzer will not be heard when a button related to one of these modes is pressed, even if "Y" is set for the "KEY IN" item.

# (OTHERS) MENU SETTINGS AND SETUP

## MENU 3

The (OTHERS) menu lets you setup the autorepeat mode, the TAPE END OUT output terminal signal timing, the alarm mode and the clog detection mode.

- 1 Press the **MENU** button to display the MENU 3 (OTHERS).

MENU 3 (Initial screen)

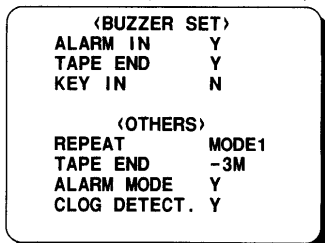

### Autorepeat Recording Mode Setup

- 2 Press the **SHIFT ↓** button, until the "REPEAT" setting is flashing.
  - 3 Press the **REC/PLAY SPEED ▼** (or **▲**) button to set the desired autorepeat recording mode.
    - MODE 1 ..... The autorepeat mode is automatically canceled if there is an alarm trigger.
    - MODE 2 ..... Autorepeat recording takes place even if there is an alarm trigger.
- Press the **SEARCH** button to complete the setting procedure and return to the normal screen display.

### TAPE END OUT Terminal Output Setup

- 4 Press the **SHIFT ↓** button.
    - The "TAPE END" setting starts flashing.
  - 5 Press the **REC/PLAY SPEED ▼** (or **▲**) button to set the desired recording TAPE END OUT terminal output mode.
    - 3M ..... The output at the TAPE END OUT terminal will become 0 V (Low) when the tape counter reaches "7H57M00S" and/or when the tape reaches the end.
    - END ..... The output at the TAPE END OUT terminal will become 0 V (Low) when the tape reaches the end.
- Press the **SEARCH** button to complete the setting procedure and return to the normal screen display.

### Alarm Mode Setup

- 6 Press the **SHIFT ↓** button.
    - The "ALARM MODE" setting starts flashing.
  - 7 Press the **REC/PLAY SPEED ▼** (or **▲**) button to set the desired alarm mode.
    - Y ..... Alarm recording is done when there is an alarm trigger.
    - Y1 ..... Alarm recording is done only when there is an alarm trigger during programmed timer recording.
    - Y2 ..... Alarm recording is done only if there is an alarm trigger and the VCR is not in programmed timer recording mode.
    - N ..... Alarm recording is not performed even if there is an alarm trigger.
- Press the **SEARCH** button to complete the setting procedure and return to the normal screen display.

### Clog Detection Setup

- 8 Press the **SHIFT ↓** button.
    - The "CLOG DETECT." setting starts flashing.
  - 9 Press the **REC/PLAY SPEED ▼** (or **▲**) button to set the desired mode.
    - Y ..... The recording quality is monitored automatically. When the heads are dirty and the recording quality deteriorates, the output at the WARNING OUT terminal becomes 0V (Low), the "O" indicator flashes on the digital display, and the buzzer sounds.
    - N ..... The recording quality is not monitored.
- 10 Press the **SEARCH** button, the normal screen is displayed.
    - The setting procedure is now completed.

By setting the holidays, timer recording will be conducted on those days, as set for Sundays.

- 1 Press the **MENU** button to display the MENU 5 (HOLIDAY SET).

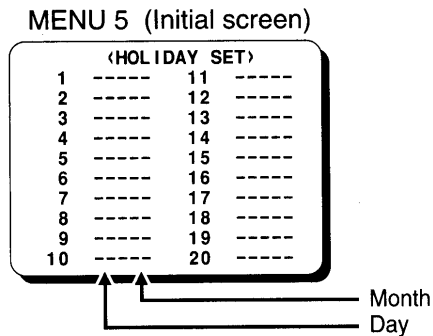

- 2 Press the **REC/PLAY SPEED** ▼ (or ▲) button to set the month of the holiday, then press the **SHIFT** → button.
- 3 Press the **REC/PLAY SPEED** ▼ (or ▲) button to set the day of the holiday.

- 4 Press the **SHIFT** → (or ↓) button, the next line to set starts flashing.
  - Repeat steps 2 to 4 to set up to 20 holidays.
- 5 Press the **SEARCH** button, the normal screen is displayed.
  - The setting procedure is now completed.

### NOTE:

- If setting holidays, be sure that a timer recording is set for Sunday. If not, this function will not operate.

### Example of timer recording with a holiday setting (the holiday falling on the Wednesday)

	Tuesday	Wednesday	Sunday
Example 1			
Normal timer recording	8H →	8H →	24H →
With holiday setting	8H →	24H →	24H →
Example 2			
Normal timer recording	8H →	8H →	24H →
With holiday setting	8H →	24H →	24H →

When using 2 or more VCRs of this same model, the clock on the second VCR and on, can be synchronized with the clock on the first VCR, using the **CLOCK ADJUSTMENT** function.

- 1 Connect the **CLOCK SET OUT** terminal on VCR 1 to the **CLOCK SET IN** terminal on VCR 2.
- 2 Repeat the procedure for all the other VCRs, connecting the **CLOCK SET OUT** terminal on VCR 2 to the **CLOCK SET IN** terminal on VCR 3, and so on.
- 3 Press the **MENU** button to display the MENU 6 (CLOCK ADJUSTMENT).
- 4 Press the **REC/PLAY SPEED ▼** (or **▲**) button to set the hour at which the adjustment will be conducted.

### NOTES:

- Be sure to set the same time on all the VCRs.
- The clock adjustment cannot be set to "00:00".

### MENU 6 Example setting (VCR 1)

〈CLOCK ADJUSTMENT〉	
TIME ADJ.	03:00
〈ALARM SET〉	
SERIES	N
DURATION	20S
〈EJECT SET〉	
EJECT MODE	EJECT 1
OPERATION	SLAVE
AUTO REC	N

- 5 Press the **SEARCH** button, the normal screen is displayed.
  - *The setting procedure on the first VCR is now completed.*
- 6 Repeat the procedure for all the other VCRs, setting "TIME ADJ." (to the same time as set on the first VCR).

### NOTE:

- Connect the **COM** terminal on all VCRs used.

# (EJECT SET) MENU SETTINGS AND SETUP

MENU 6

- 1 Press the **MENU** button to display the MENU 6 (EJECT SET).

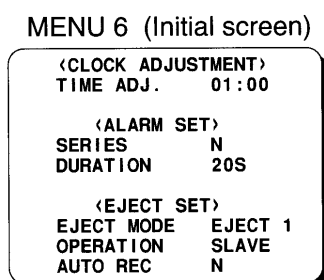

## Cassette Eject Setup

- When using 2 VCRs or more, the cassette tape of all the VCRs or some of the VCRs can be ejected, if the EJECT terminals on the VCRs are connected as indicated.
- 2 Press the **SHIFT ↓** button, until the “EJECT MODE” setting is flashing.
  - 3 Press the **REC/PLAY SPEED ▼** (or **▲**) button to set the desired cassette eject mode.
 

EJECT1	.....	The cassette is ejected only if the VCR is not in recording mode.
EJECT2	.....	The cassette is ejected.
EJECT3	.....	The cassette is first rewound then ejected.
  - 4 Press the **SHIFT ↓** button.
    - The “OPERATION” setting starts flashing.
  - 5 Press the **REC/PLAY SPEED ▼** (or **▲**) button to set the operation.
 

SLAVE	.....	When the <b>EJECT</b> button is pressed, the cassette tape of that VCR only will be ejected.
MASTER	.....	When the <b>EJECT</b> button is pressed, the cassette tape of that VCR and of any VCR connected after it will be ejected.

## EJECT terminal connection

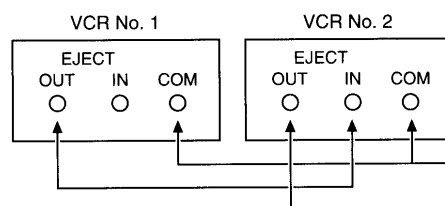

- Press the **SEARCH** button to complete the setting procedure and return to the normal screen display.

## NOTE:

- The **EJECT** button will not be operative during timer recording and alarm recording.

## Auto-Recording Setup

- 6 Press the **SHIFT ↓** button.
  - The “AUTO REC” setting starts flashing.
- 7 Press the **REC/PLAY SPEED ▼** (or **▲**) button to set the desired auto-recording mode.
 

N	.....	When a cassette tape is loaded, the VCR will stay in stop mode.
Y	.....	When a cassette tape with an erasure-prevention tab is loaded, recording will start automatically.
- 8 Press the **SEARCH** button, the normal screen is displayed.
  - The setting procedure is now completed.

## NOTE:

- If the indicator “” is displayed, the AUTO REC function will not operate.

# CHECKING USAGE DURATION, POWER FAILURE AND FAILURE DUE TO CONDENSATION

MENU 7

- 1 Press the **MENU** button to display the MENU 7 (USED TIME), (POWER FAILURE), (DEW).
  - (USED TIME) . . . . . The video heads usage duration and the power on duration are displayed.
  - (POWER FAILURE) . . . The number of power failures, and the date and time of the most recent power failure and recovery are displayed.
  - (DEW) . . . . . The number of failures due to condensation, and the date and time of the most recent failure and recovery are displayed.

MENU 7 Sample display

```
      <USED TIME>
VIDEO      00003H
POWER      00007H

      <POWER FAILURE>
002 FAILURE 12-10 07:15
RECOVERY 12-10 07:30
      <DEW>
001 FAILURE 12-10 11:00
RECOVERY 12-10 12:00
```

- 2 Press the **SEARCH** button, the normal screen is displayed.

**NOTE:**

- If the **MENU RESET** button is pressed while the MENU 7 is displayed, the (POWER FAILURE) and (DEW) data is erased. The (USED TIME) data cannot be reset.  
“P” will be erased from the digital display.

# CHECKING THE ALARM RECORDINGS TIME

MENU 8

- 1 Press the **MENU** button to display the MENU 8 (ALARM TIME).
  - *The number of alarm triggers, and the 8 most recent alarm recording times are displayed.*

MENU 8 Sample display

```
      <ALARM TIME>
010 03-12 19:00
    01-11 23:00
    25-10 15:00
    25-10 08:00
    25-10 06:00
    15-10 20:00
    15-10 16:35
    15-10 10:52
```

**NOTE:**

- The data for the previous alarm recordings is erased.
- 2 Press the **SEARCH** button, the normal screen is displayed.

**NOTE:**

- If the **MENU RESET** button is pressed while the MENU 8 is displayed, the displayed data is erased.  
“AL” will be erased from the digital display.

# ABOUT THE OUTPUT TERMINALS

## TAPE END OUT Terminal

- During recording, when the end of the tape is reached or when the tape counter reading indicates 7 hours 57 minutes or more, the output becomes 0V (Low). When the end of the tape is reached, "OFF" will be displayed on the digital display.
- If the **REPEAT REC** switch is set to the "ON" position, the output becomes 0V (Low) for about 2 seconds only.
- To reset the output, press the **STOP** or **EJECT** button.

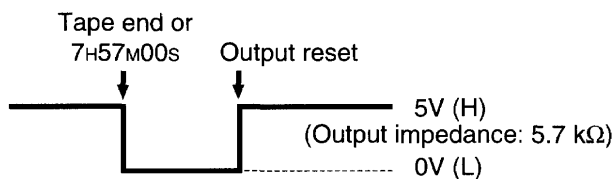

## WARNING OUT Terminal

- If the tape stops or other problem, the output becomes 0V (Low).
- To reset the output, unplug the power cord then plug it back in or press the **ALL RESET** button.

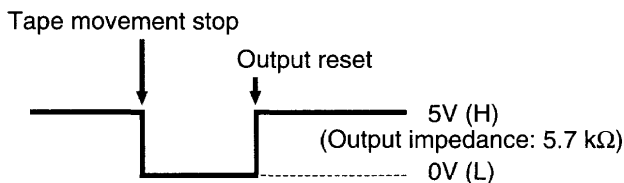

### NOTE:

- If the output is 0V (Low) due to the clog detect function, it can be reset by simply pressing the **STOP** button.

## TIMER OUT Terminal

- During timer recording DC 12 V (High) are output. (During timer recording stand-by mode, the output is 0V (Low).)

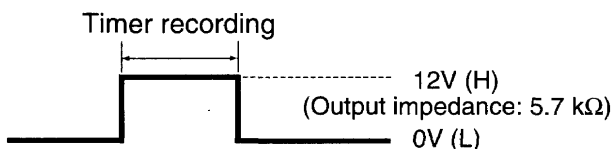

## COM Terminal

- Common GND (ground) terminal when connecting other terminals to external devices.

## SW OUT Terminal

When recording, a pulse signal is output at the **SW OUT** terminal after each recording period.

This terminal is usually connected to the switch input (SW IN) of devices like a camera switcher unit, or a quad compressor.

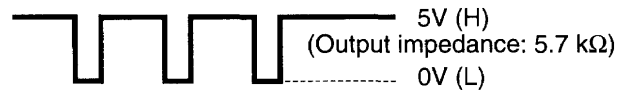

## REMOTE Jack

- Remote control of the VCR is possible by connecting a remote controller with a circuit such as indicated below, to the **REMOTE** jack.
- Use a 3.5 mm mini-jack type plug.
- The connection should be done using a shielded cable no more than 5 meters long.

Remote control circuit

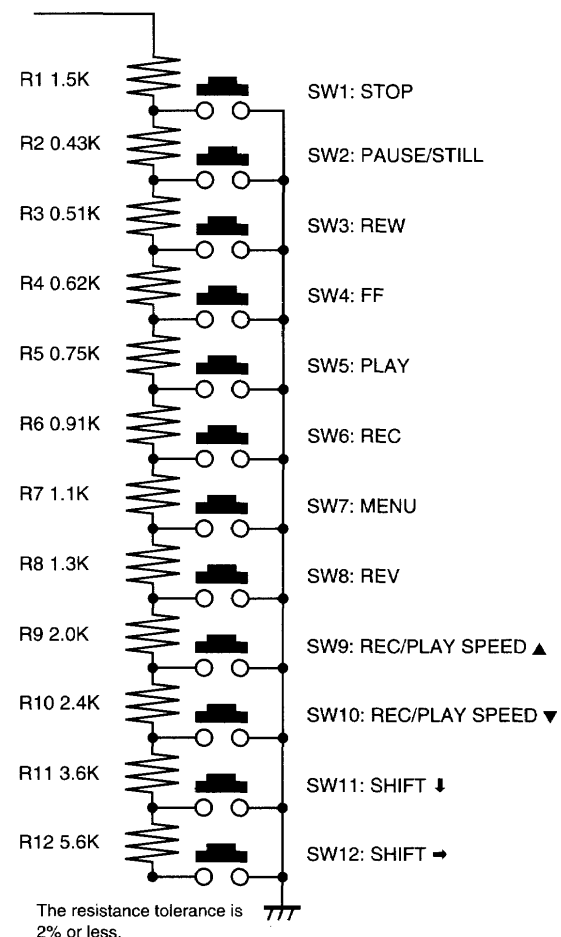

# DAILY INSPECTION

The following daily inspections are recommended in order to assure long-term and trouble-free operation of the unit.

The daily inspections are particularly important if using autorepeat recording.

## Inspection Procedure

- ❶ Turn on the power to the VCR, camera, TV monitor and other connected devices.
- ❷ Check that the image received on the TV monitor is correct.
- ❸ Check that the on-screen display of the date and time is correct.
- ❹ Press the **REW** button to rewind the recorded tape a few seconds.
- ❺ Press the **PLAY** button and check that the playback image is correct.
- ❻ Check that the recorded date and time are correct.

## NOTES:

- If the security lock is engaged, it has to be released before proceeding to the inspection.
- If any problem is discovered during the inspection, turn off the VCR, unplug the power cord then consult your dealer.



# TROUBLESHOOTING GUIDE

If the unit does not operate normally when you follow the instructions indicated in the manual, please refer to the table below.

SYMPTOM	POSSIBLE CAUSE	CORRECTIVE ACTION
No power	The power cord is not correctly connected to the wall outlet	Connect the power cord firmly into the wall outlet
No image displayed on the monitor TV	The connections are not correct	Check that all connections are correct
	The power to the camera and/or monitor TV is not turned on	Turn all connected devices power on
The buttons do not respond	A cassette tape is not loaded	Load a cassette and turn the power on
	All functions are suspended due to condensation	Wait for the "ddd" indicator to go off
	Alarm recording	Wait for the alarm recording to end
	The security lock is engaged	Cancel the security lock
Recording is not possible (the tape is ejected)	The loaded cassette has no erasure-prevention tab	Load a cassette tape with erasure-prevention tab or cover the tab hole with adhesive tape
Autorepeat recording is not possible	"RL" is displayed on the digital display	Display MENU 8, then press the <b>MENU RESET</b> button to turn off the "RL" indicator
Timer recording is not possible	The date and time are not set correctly	Set the date and time correctly
	The unit is not set to timer recording stand-by mode	Press the <b>TIMER</b> button to display "☐" on the digital display
	"N" is selected for the timer recordings	Be sure to select "Y" for the programmed timer recordings
Alarm recording is not possible	"OFF" is displayed on the digital display	Press the <b>EJECT, STOP, FF, REW</b> or <b>PLAY</b> button to turn the indicator off
Noise in the playback picture	The video heads need cleaning	Clean the video heads
The date and time are not recorded	The <b>ON SCREEN</b> switch is set to the "OFF" position	Set the <b>ON SCREEN</b> switch to the "ON" position
The cassette tape cannot be ejected	Problem with the system	Turn the power off, then on again

## Periodic Inspection and Maintenance

Periodic inspection and maintenance should be referred to your dealer.

If there is noise in the playback picture, and it cannot be corrected using the tracking control, it may indicate that the video heads need cleaning.

The video heads should be inspected every 1,000 hours of use to determine if they need to be replaced.

The video heads usage can be checked using the MENU 7 (USED TIME).

## After a Power Failure

If after a power failure the recording speed is reset to 8-hour mode, it is due to insufficient backup battery charge. This is not a malfunction.

## System Down

If the unit does not function at all, try the following.

- ❶ Unplug the power cord then plug it back in.
- ❷ Reset the memory. (Press the **ALL RESET** button. Under normal conditions, do not touch the **ALL RESET** button.)
- ❸ If the problem is not corrected after performing steps ❶ and ❷ a few times, consult your dealer.

# SPECIFICATIONS

## General Specifications

Recording method	Dual-azimuth 2-head rotating helical scanning system
Audio recording	In 8- and 24-hour modes
Tape speed	11.70 mm /sec (8-hour mode)
Specified video cassette tape	VHS 1/2 inch video cassette tape
Recording/playback time	8 and 24 hours (when using E-240 tape)
Fast forward/rewind time	approximately 5 minutes 30 seconds (when using E-240 tape)
Television system	PAL colour TV system

## Video

Recording method	Luminance signal: FM recording
	Chrominance signal: Down-converted direct recording
Video input	1 Vp-p, BNC, 75 $\Omega$ , unbalanced
Video output	1 Vp-p, BNC, 75 $\Omega$ , unbalanced
Horizontal resolution	Black & white mode 350 line or more
	Colour mode 250 line or more

## Audio

Input	-8 dBs, RCA pin jack, 27 k $\Omega$ , unbalanced
Output	-8 dBs, RCA pin jack, 600 $\Omega$ , unbalanced
Microphone input	-60 dBs, 3.5 mm mini jack, 10 k $\Omega$ , unbalanced

## Connectors

Alarm input	Contact closes with no voltage
Alarm output	DC 5 V ( $\pm 0.5$ )/5.7 k $\Omega$
Tape end output	DC 5 V ( $\pm 0.5$ )/5.7 k $\Omega$
Warning output	DC 5 V ( $\pm 0.5$ )/5.7 k $\Omega$
Switch output	DC 5 V ( $\pm 0.5$ )/5.7 k $\Omega$
Timer output	DC 12 V ( $\pm 0.5$ )/5.7 k $\Omega$
Clock set input	Contact closes with no voltage
Clock set output	DC 5 V ( $\pm 0.5$ )/5.7 k $\Omega$
Ext timer input	Contact closes with no voltage
Series input	Contact closes with no voltage
Series output	DC 5V ( $\pm 0.5$ )/5.7 k $\Omega$
Eject input	Contact closes with no voltage
Eject output	DC 5V ( $\pm 0.5$ )/5.7 k $\Omega$
Common	0 V (GND)
Remote control input	3.5 mm mini jack

## Other Specifications

Operating temperature range	5°C to 40°C
Operating humidity range	80% or less
Power requirements	220 – 240 V AC, 50 Hz
Power consumption	20 W
Dimensions	360 (W) x 91 (H) x 338 (D) mm
Weight	approximately 4.8 kg

**NOTE:** The specifications and external appearance of this unit are subject to change without notice.





---

**SANYO Electric Co., Ltd.**

1AC6P1P1447--  
ER4Q/EX  
(0397KP-NI-SY01)

Issue No. 1

Copyright SANYO, 1997 All rights reserved.

Printed in Japan

## Free Manuals Download Website

<http://myh66.com>

<http://usermanuals.us>

<http://www.somanuals.com>

<http://www.4manuals.cc>

<http://www.manual-lib.com>

<http://www.404manual.com>

<http://www.luxmanual.com>

<http://aubethermostatmanual.com>

Golf course search by state

<http://golfingnear.com>

Email search by domain

<http://emailbydomain.com>

Auto manuals search

<http://auto.somanuals.com>

TV manuals search

<http://tv.somanuals.com>