



INSTRUCTION MANUAL
(Warranty attached)

VCC-4794

Color CCD Camera

About this manual

Before installing and using the camera, please read this manual carefully. Be sure to keep it handy for later reference.

DIMENSIONS

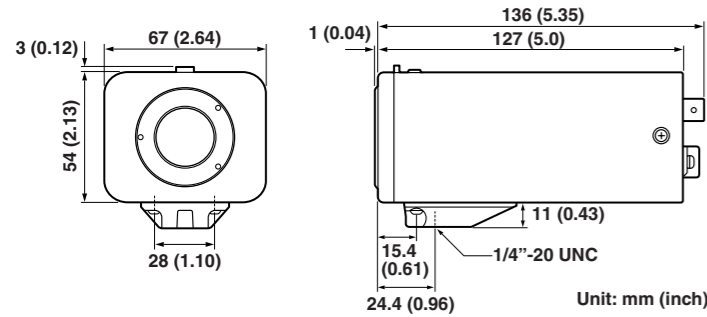

Depending on the conditions of use, installation and environment, please be sure to make the appropriate settings and adjustments. If you need help with installation and/or settings, please consult your dealer or an Authorized Sanyo Service Center.

SPECIFICATIONS

Scanning system	: NTSC standard 525 lines, 60 fields/sec.
Image sensor	: 1/3" interline transfer method CCD
Number of effective pixels	: 768 (H) x 494 (V)
Horizontal resolution	: More than 520 TV lines
Minimum illumination (approx.)	: Gain high: 0.01 lx (F 1.2, B/W mode), 0.45 lx (F1.2, color mode) Gain normal: 0.02 lx (F 1.2, B/W mode), 0.6 lx (F1.2, color mode)
Video output	: 1.0 V(p-p)/75 Ω, composite, BNC
Video S/N ratio	: More than 48 dB (AGC off: More than 50 dB)
Backlight compensation	: OFF, Multi-spot metering (Normal/High), Center zone metering
White balance	: ATW/Manual
Gain control	: Normal/High
Light control	: Optical auto iris lens/Electronic iris (indoor use)
Lens mount	: CS mount
Flange back	: 12.5 mm ± 0.5 mm adjustment
Aperture compensation	: Normal/Sharp
Sync system	: Internal sync/Line lock
Day/Night mode	: Auto (Low/High), Manual (at CONTROL terminal)
Operating Environment	: Temperature: -10°C – +50°C (14°F – 122°F) Humidity: less than 90 % RH (no condensation)
Power supply	: 24 V AC ±10%, 60 Hz/ 12 – 15 V DC
Power consumption (approx.)	: 3.7 W (with auto-iris lens)
Weight (approx.)	: 400 g (14.1 oz) (without lens)

Appearance and specifications are subject to change without prior notice or obligations.

Printed on recycled paper

1AC6P1P2978--
L5BG2/US (0805KP-SY)



SANYO Electric Co., Ltd.
Printed in Japan

INFORMATION TO USER

Safety Guard



WARNING:
TO PREVENT THE RISK OF FIRE OR ELECTRIC SHOCK, DO NOT EXPOSE THIS APPLIANCE TO RAIN OR MOISTURE.

For the customers in Canada
This Class B digital apparatus complies with Canadian ICES-003.
Pour la clientèle canadienne
Cet appareil numérique de la Classe B est conforme à la norme NMB-003 du Canada.

This installation should be made by a qualified service person and should conform to all local codes.

This equipment has been tested and found to comply with the limits for a Class B digital device, pursuant to Part 15 of the FCC Rules. These limits are designed to provide reasonable protection against harmful interference in a residential installation. This equipment generates, uses, and can radiate radio frequency energy and, if not installed and used in accordance with the instructions, may cause harmful interference to radio communications. However, there is no guarantee that interference will not occur in a particular installation. If this equipment does cause harmful interference to radio or television reception, which can be determined by turning the equipment off and on, the user is encouraged to try to correct the interference by one or more of the following measures:

- Reorient or relocate the receiving antenna.
- Increase the separation between the equipment and receiver.
- Connect the equipment into an outlet on a circuit different from that to which the receiver is connected.
- Consult the dealer or an experienced radio/TV technician for help.

This device complies with Part 15 of the FCC Rules. Operation is subject to the following two conditions: (1) This device may not cause harmful interference, and (2) this device must accept any interference received, including interference that may cause undesired operation.

Changes or modifications not expressly approved by **Sanyo** may void the user's authority to operate this camera.

PRECAUTIONS

In case of a problem

Do not use the unit if smoke or a strange odor comes from the unit, or if it seems not to function correctly. Turn off the power immediately and disconnect the power cord, and then consult your dealer or an Authorized Sanyo Service Center.

Do not open or modify

Do not open the cabinet, as it may be dangerous and cause damage to the unit. For repairs, consult your dealer or an Authorized Sanyo Service Center.

Do not put objects inside the unit

Make sure that no metal objects or flammable substance get inside the unit. If used with a foreign object inside, it could cause a fire, a short-circuit or damage. Be careful to protect the unit from rain, sea water, etc. If water or liquid gets inside the unit, turn off the power immediately and disconnect the power cord, and then consult your dealer or an Authorized Sanyo Service Center.

Be careful when handling the unit

To prevent damage, do not drop the unit or subject it to strong shock or vibration.

Do not install this unit close to magnetic fields

The magnetic fields may result in unstable operation.

Protect from humidity and dust

To prevent damage, do not install the unit where there is greasy smoke or steam, where the humidity may get too high, or where there is a lot of dust.

Protect from high temperatures

Do not install close to stoves, or other heat sources, such as spotlights, etc., or where it could be subject to direct sunlight, as this could cause deformation, discoloration or other damages.

Be careful when installing close to the ceiling, in a kitchen or boiler room, as the temperature may rise to high levels.

Cleaning

- Dirt can be removed from the cabinet by wiping it with a soft cloth. To remove stains, wipe with a soft cloth moistened with a soft detergent solution and wrung dry, then dry by wiping with a soft cloth.
- Do not use benzine, thinner or other chemical products on the cabinet, as this may cause deformation and paint peeling. Before using a chemical cloth, make sure to read all accompanying instructions. Make sure that no plastic or rubber material comes into contact with the cabinet for a long period of time, as this may cause damage or paint peeling.

TROUBLESHOOTING

Before sending the camera out for repair, check the items below. If the problem persists after checking these items, consult your dealer or an Authorized Sanyo Service Center.

If no image appears

- Is the coaxial cable attached securely?
- Are the power and voltage normal?
- Has the iris of the lens been adjusted correctly (with the LEVEL dial)?
- Is there adequate illumination?

If the image is unclear

- Is the monitor adjusted correctly?
- Is the flange-back position correctly set?
- Is the lens in focus?
- Is the lens clean?
Dirt or fingerprints on the lens can adversely affect the image. Gently wipe any dirt or fingerprints off the lens with a soft cloth or lens cleaning paper and cleaning fluid (commercially available).

SERVICE

The camera is a precision instrument. Handle it carefully and always follow the safety precautions. If the camera requires service, never try to repair it yourself or open the casing.

For servicing, maintenance, or repairs, consult your dealer or an Authorized Sanyo Service Center.

EXCLUSIONS

This warranty does not cover (A) the adjustment of customer-operated controls as explained in the appropriate model's instruction manual, or (B) the repair of any product whose serial number has been altered, defaced or removed. This warranty shall not apply to the cabinet or cosmetic parts, batteries or routine maintenance. This warranty does not apply to uncrating, setup, installation, removal of the product for repair or reinstallation of the product after repair. This warranty does not apply to repairs or replacements necessitated by any cause beyond the control of SFC including, but not limited to, any malfunction, defect or failure caused by or resulting from unauthorized service or parts, improper maintenance, operation contrary to furnished instructions, shipping or transit accidents, modification or repair by the user, abuse, misuse, neglect, accident, incorrect power line voltage, fire, flood or other Acts of God, or normal wear and tear. The foregoing is in lieu of all other expressed warranties and SFC does not assume or authorize any party to assume for it any other obligation or liability. SFC DISCLAIMS ALL OTHER WARRANTIES EXPRESS OR IMPLIED, WITH REGARD TO THIS PRODUCT (INCLUDING THE WARRANTIES OF MERCHANTABILITY AND FITNESS). IN NO EVENT SHALL SFC BE LIABLE FOR ANY SPECIAL, INCIDENTAL OR CONSEQUENTIAL DAMAGES ARISING FROM THE OWNERSHIP OR USE OF THIS PRODUCT OR FOR ANY DELAY IN THE PERFORMANCE OF ITS OBLIGATIONS UNDER THIS WARRANTY DUE TO CAUSES BEYOND ITS CONTROL. SFC'S LIABILITY FOR ANY AND ALL LOSSES AND DAMAGES RESULTING FROM ANY CAUSE WHATSOEVER, ARISING OUT OF OR IN CONNECTION WITH THE SALE, USE OR OWNERSHIP OF THIS PRODUCT INCLUDING WARRANTOR'S NEGLIGENCE, ALLEGED DAMAGED OR DEFECTIVE GOODS, WHETHER SUCH DEFECTS ARE DISCOVERABLE OR LATENT, SHALL IN NO EVENT EXCEED THE PURCHASE PRICE OF THE PRODUCT.

ATTENTION

For your protection in the event of theft or loss of this product, please fill in the information below for you own personal records.

Model No. _____ Serial No. _____
(Located on back or bottom side of unit.)

Date of Purchase _____ Purchase Price _____

Where Purchased _____

**SANYO INDUSTRIAL VIDEO
COLOR CCD CAMERA LIMITED WARRANTY**

OBLIGATIONS

In order to obtain warranty service, the product must be delivered to and picked up from an Authorized Sanyo Service Center at the user's expense, unless specifically stated otherwise in this warranty. The names and addresses of Authorized Sanyo Service Centers may be obtained by calling the toll-free number listed below.

For product operation, authorized service center referral, service assistance or problem resolution, call

CUSTOMER INFORMATION 1-800-421-5013
Weekdays 8:30 AM - 5:00 PM Pacific Time

For accessories and/or parts, call

PARTS ORDER INFORMATION 1-800-726-9662
Weekdays 8:30 AM - 5:00 PM Pacific Time

THIS WARRANTY IS VALID ONLY ON SANYO PRODUCTS PURCHASED OR RENTED IN THE UNITED STATES OF AMERICA, EXCLUDING ALL U.S. TERRITORIES AND PROTECTORATES. THIS WARRANTY APPLIES ONLY TO THE ORIGINAL RETAIL PURCHASER OR END-USER. THE ORIGINAL DATED BILL OF SALE, SALES SLIP OR RENTAL AGREEMENT MUST BE SUBMITTED TO THE AUTHORIZED SANYO SERVICE CENTER AT THE TIME WARRANTY SERVICE IS REQUESTED.

Subject to the OBLIGATIONS above and EXCLUSIONS below, SANYO Fisher Company warrants this SANYO product against defects in materials and workmanship for the periods specified below. SFC will repair or replace (at its option) the product and any of its parts which fail to conform to this warranty. The warranty period commences on the date the product was first purchased or rented at retail.

LABOR	PARTS	IMAGE DEVICE
3 YEARS	3 YEARS	3 YEARS

CONNECTIONS AND ADJUSTMENTS

■ Attaching the lens

Use any DC type and CS mounting lens equipped with an auto iris (sold separately).

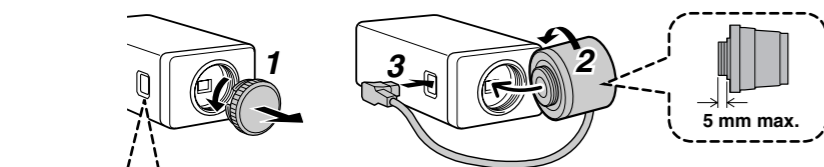

Pin layout for LENS terminal

Brake coil (-) Drive coil (+)
Brake coil (+) Drive coil (-)

- Depending on the type of the lens, the shape of the lens plug may differ. In this case, consult your dealer or an Authorized Sanyo Service Center.
- Apply adapter ring (sold separately) when you use any C mounting lens.

■ Camera attachment

When attaching the camera, make sure to verify that the attachment surface will allow full tightening of the screws. Plaster board, etc., may not give a strong enough attachment, and it is recommended to use a reinforcement, or other method so that the screws are anchored securely.

- When monitoring lighting or other extremely bright objects (which exceed the maximum required illumination), smearing may occur in the vertical or horizontal direction (either above and below the high-brightness object or as a perpendicular band). In such a case, adjust the angle of illumination and other factors while observing the monitor.

Changing the bracket upside out

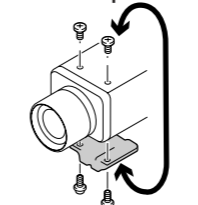

Make sure to use the screws to secure the bracket.

■ Flange-back adjustment

This normally does not need adjustment. If the picture is out of focus at the telephoto position, adjust the flange-back position as described below.

3 Set to the maximum wide-angle position and focus the picture.

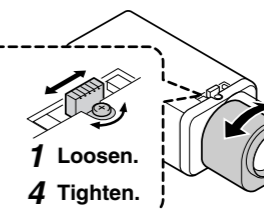

Repeat steps 2 and 3 until the image stays in-focus when changing from a wide-angle position to a telephoto position.

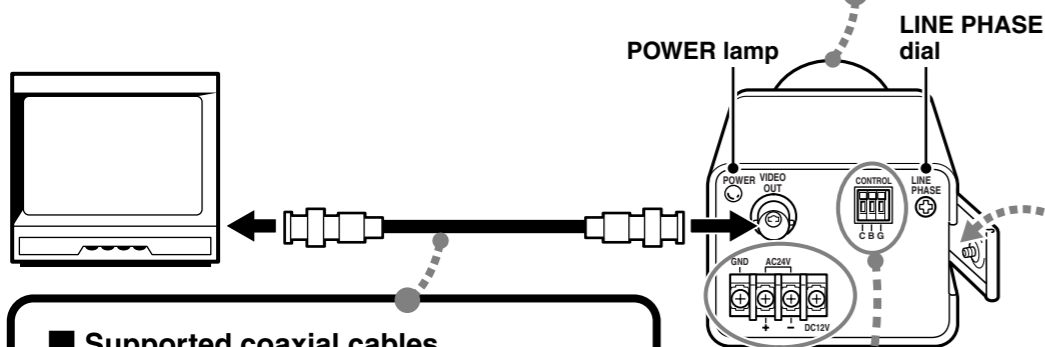

■ Supported coaxial cables

Cable type – Length: RG-59U (3C-2V) – 250 m max., RG-6U (5C-2V) – 500 m max., RG-11U (7C-2V) – 600 m max.

- When using an RG-59U (3C-2V) cable, do not use it on piping or air wiring.
- If you use a cable other than the type above, the image or sync signal will be attenuated and will not be transmitted correctly.

■ Power cable

<AC 24 V connection>

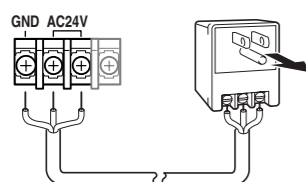

- To prevent a fire hazard use any UL listed wire rated VW-1.

<DC 12 V connection>

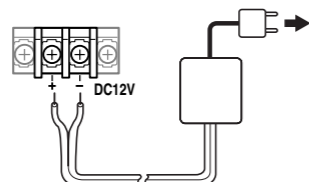

- Check that polarity is correct.

■ When a hunting reaction occurs

Under near infrared lighting or other similar conditions, hunting reaction may occur because the Day/Night function is not carried out normally. In such case, refer to the following diagram for cable connection to fix the image either to color or black-and-white by using an external switch, etc.

Fixing the image to color

Fixing the image to back-and-white

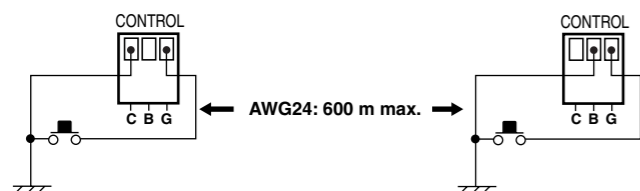

- You cannot control the switchover operation by using an external switch, etc., while switching between color and black-and-white images is actually in progress by the Day/Night function.

■ Camera adjustments/settings

The camera comes pre-adjusted and ready to install at the time of factory shipment, but you can make adjustments or settings if you need.

If you have trouble adjusting the camera, consult your dealer or an Authorized Sanyo Service Center.

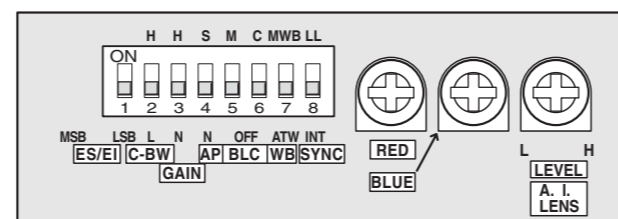

<ES/EI> Iris setting

Use of an auto-iris lens	Use of a manual or fixed iris lens (for indoor use)

- Set the lens aperture to the shortest F-stop.
- When using a manual or fixed iris lens under fluorescent light, the image may flicker.
- When using an auto-iris lens, if the entire image is too dark or too bright, adjust the contrast by using the LEVEL dial.

<C-BW> Day/Night function switchover point

This switch is used to set the timing for automatic switching between color and black-and-white images.

- Set the switchover point to brighter side so that the automatic switch may trip in brighter condition for switchover between color and black-and-white images.

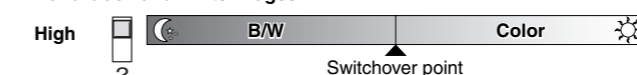

- Set the switchover point to darker side so that the automatic switch may trip in darker condition for switchover between color and black-and-white images.

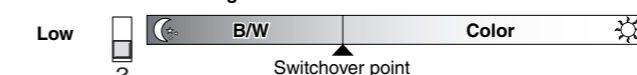

- The color image will be displayed first when the power is turned on.
- When switching between color and black-and-white images automatically, it is normal for movement of the optical filter to be heard and for a vertical black band to move across the screen.
- Switching from black-and-white to color may occur if there is a significant degree of reflection from the object when using infrared illumination in black-and-white image. Adjust the illumination to avoid switching to color image.
- The focus setting position may differ between color and black-and-white images. Carry out adjustment to ensure that the focus for both images is in the optimum position.

<GAIN> Auto gain control (AGC)

High sensitivity	Normal sensitivity
Increased electronic sensitivity to obtain a bright image in a lower illuminance*	

* This setting causes noise generation and a grainy image.

<AP> Aperture compensation

Sharp outline	Normal outline

<BLC> Backlight compensation

Only when using an auto-iris lens



Multi-spot metering	Center zone metering	OFF
Backlight compensation to the entire screen*	Backlight compensation to the central portion of the screen	
High Normal		

* If the background of the object is extremely dark, set to Center zone metering.

<WB> White balance (color compensation)

Manual White Balance	Auto-Tracing White balance
Turn clockwise to augment the color.	

<SYNC> Sync setting

Line-Lock	Internal sync
(Only when using an AC power supply) Synchronizes the unit with power frequency*	
LINE PHASE (Rear panel)	

* Adjust the roll by turning the LINE PHASE dial on the second and subsequent cameras.

- If the vertical roll cannot be corrected by adjusting the LINE PHASE dial on the second and subsequent cameras, try adjusting the LINE PHASE dial on the first camera. If it still cannot be corrected, please check that the polarity of the power cords of all connected devices is correct.

<LEVEL> Lens iris level adjustment

When using an auto-iris lens, if the entire image is too dark or too bright, adjust the contrast.

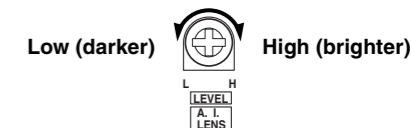

Free Manuals Download Website

<http://myh66.com>

<http://usermanuals.us>

<http://www.somanuals.com>

<http://www.4manuals.cc>

<http://www.manual-lib.com>

<http://www.404manual.com>

<http://www.luxmanual.com>

<http://aubethermostatmanual.com>

Golf course search by state

<http://golfingnear.com>

Email search by domain

<http://emailbydomain.com>

Auto manuals search

<http://auto.somanuals.com>

TV manuals search

<http://tv.somanuals.com>