

SANYO

INSTRUCTION MANUAL

VPC-E6EX
VPC-E6
VPC-E6GX

Digital Camera

Xacti

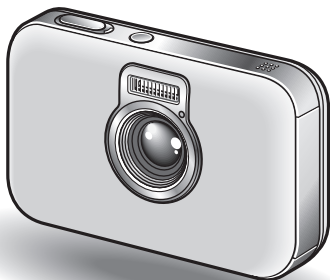

Important note

This manual explains how to safely operate the VPC-E6EX, VPC-E6 and VPC-E6GX.

Any information regarding only one of these products will be labeled as such.

Please read these instructions carefully before using the camera.
Make sure to read and understand the separate booklet "SAFETY MANUAL".
Keep this manual in a safe place for later reference.

Download from [Www.Somanuals.com](http://www.Somanuals.com). All Manuals Search And Download.

Warning

TO PREVENT THE RISK OF FIRE OR ELECTRIC SHOCK, DO NOT EXPOSE THIS APPLIANCE TO RAIN OR MOISTURE

FOR AMERICAN USERS

The following advisory is included in accordance with the laws of the State of California (USA):

WARNING:

This product contains chemicals, including lead, known to the State of California to cause cancer, and birth defects or other reproductive harm.

Wash hands after handling.

- This equipment has been tested and found to comply with the limits for a Class B digital device, pursuant to Part 15 of the FCC Rules. These limits are designed to provide reasonable protection against harmful interference in a residential installation. This equipment generates, uses and can radiate radio frequency energy and, if not installed and used in accordance with the instructions, may cause harmful interference to radio communications. However, there is no guarantee that interference will not occur in a particular installation. If this equipment does cause harmful interference to radio or television reception, which can be determined by turning the equipment off and on, the user is encouraged to try to correct the interference by one or more of the following measures:
 - Reorient or relocate the receiving antenna.
 - Increase the separation between the equipment and receiver.
 - Connect the equipment into an outlet on a circuit different from that to which the receiver is connected.
 - Consult the dealer or an experienced radio/TV technician for help.
- Changes or modifications not expressly approved by the party responsible for compliance could void the user's authority to operate the equipment.

Declaration of Conformity

Model number: VPC-E6

Trade Name: SANYO

Responsible party: SANYO FISHER COMPANY

Address: 21605 Plummer Street, Chatsworth, California 91311

Telephone No.: (818) 998-7322

This device complies with Part 15 of the FCC Rules. Operation is subject to the following two conditions:

- (1) this device may not cause harmful interference, and
- (2) this device must accept any interference received, including interference that may cause undesired operation.

FOR CANADIAN USERS

- This Class B digital apparatus complies with Canadian ICES-003.

FOR EU USERS



Note:

- This symbol mark and recycle system apply only to EU countries and do not apply to the countries in the other areas of the world.

Your SANYO product is designed and manufactured with high quality materials and components which can be recycled and reused.

This symbol means that electrical and electronic equipment, at their end-of-life, should be disposed of separately from your household waste.

Please dispose of this equipment at your local community waste collection/recycling centre.

In the European Union there are separate collection systems for used electrical and electronic products.

Please help us to conserve the environment we live in!

Symbols used in this manual

- HINT** Points giving some extended instructions or special points to pay attention to.
- CAUTION** Points that require special attention.
- (page xx)** Refer to the page indicated for detailed information.

You may find the answers to questions or problems concerning camera operation in the sections "COMMONLY ASKED QUESTIONS" (page 150) and "TROUBLESHOOTING" (page 157).

GETTING UP AND RUNNING

Install the battery pack

1 Open the battery slot cover, and insert the battery pack.

- The battery slot cover is located on the bottom of the camera.

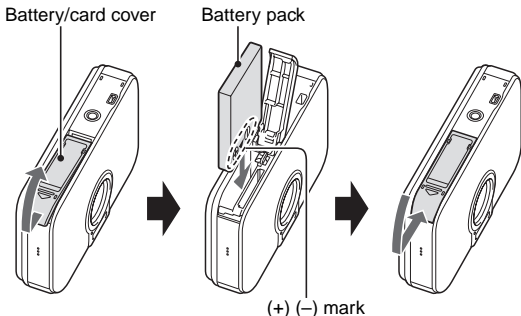

2 Use the supplied AC adaptor to charge the battery pack.

- Charging will take approximately 90 minutes.

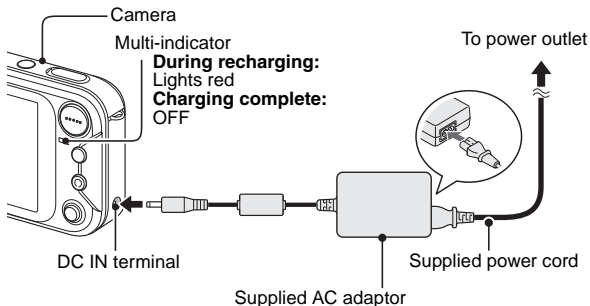

Playback

■ Still image playback

- 1 Press the playback button [▶].**
 - The display switches to the Playback Screen.
 - To view other images, toggle the SET button to the left or right.
 - If the playback button [▶] is pressed, the display returns to the Shooting Screen.

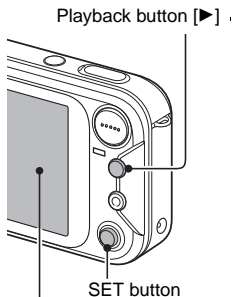

■ Video clip playback

- 1 Press the playback button [▶].**
 - The display switches to the Playback Screen.
 - Toggle the SET button to the left or right to display the video clip you wish to play back.
 - Video clips are indicated by a video clip pattern along the top and bottom of the screen.
- 2 Press the SET button.**
 - Playback of the selected video clip begins.
 - If the playback button [▶] is pressed again, the display changes to the Shooting Screen.



When you are finished taking pictures...

Press the ON/OFF button to turn the camera off.

QUICK SEARCH BY OPERATION

Your camera has an abundance of convenient features and functions. From creating precisely the photo you want, to viewing images using various techniques, you can locate the exact operation for your purposes in the following table.

	Basic operation	Convenient functions	Additional functions
Shooting/recording	Getting started shooting/recording <ul style="list-style-type: none">• "Recording a video clip" on page 38• "Shooting single shots" on page 33• "Shooting sequential shots" on page 72• "MAKE AN AUDIO RECORDING" on page 65	Change the setting to sequential shots <ul style="list-style-type: none">• "How to use the best shot feature" on page 51 Log the date and time of your photos <ul style="list-style-type: none">• "DATE AND TIME SETTING" on page 23 Zoom in on the subject <ul style="list-style-type: none">• "USING THE ZOOM" on page 42 Close-up photography <ul style="list-style-type: none">• "FOCUS RANGE" (supermacro mode) on page 67	For more accurate focus <ul style="list-style-type: none">• "FOCUS RANGE" (manual focus) page 68 Set the focus to a narrow range <ul style="list-style-type: none">• "FOCUS AREA SETTING" on page 76 Check the focus status <ul style="list-style-type: none">• "ZOOM JUMP PLAYBACK" on page 92
	Optimize the photo quality <ul style="list-style-type: none">• "RESOLUTION SETTING" on page 64	Reduce video clip flicker <ul style="list-style-type: none">• "FLICKER-REDUCTION SETTING" on page 81	

	Basic operation	Convenient functions	Additional functions
Shooting/recording	Capture fast-moving subjects		
	<ul style="list-style-type: none"> • "SCENE SELECT" (sports mode) on page 48 		
	Shoot in bright conditions		
	<ul style="list-style-type: none"> • "EXPOSURE CORRECTION" on page 45 • "FLASH SETTING" on page 43 • "SCENE SELECT" (night view mode/fireworks mode/lamp mode) on page 48 		
			Increase the camera's sensitivity
	<ul style="list-style-type: none"> • "ISO SENSITIVITY" on page 78 		
	Photographing people		
<ul style="list-style-type: none"> • "SCENE SELECT" (portrait mode/night view mode) on page 48 • "SHUTTER OPERATION SETTING" (ID photos) on page 75 • "FILTERS" (cosmetic filter) on page 52 • "FLASH SETTING" (red-eye reduction) on page 43 			
Photographing landscapes			
<ul style="list-style-type: none"> • "SCENE SELECT" (landscape mode/night view mode) on page 48 • "FOCUS RANGE" (telephoto mode) on page 67 			
Take a self-photo			
<ul style="list-style-type: none"> • "SELF-TIMER" on page 69 			
	Make images lighter or darker	Measure the brightness of a specific area	
	<ul style="list-style-type: none"> • "EXPOSURE CORRECTION" on page 45 	<ul style="list-style-type: none"> • "LIGHT-MEASURING MODE SETTING" on page 77 	
		Adjust the camera's sensitivity	
		<ul style="list-style-type: none"> • "ISO SENSITIVITY" on page 78 	

	Basic operation	Convenient functions	Additional functions	
Shooting/recording		Change the color of the images <ul style="list-style-type: none"> “FILTERS” (monochrome filter/sepia filter) on page 52 	Make white appear natural <ul style="list-style-type: none"> “WHITE BALANCE” on page 79 	
		Add an audio track to still image data <ul style="list-style-type: none"> “ADDING A VOICE MEMO” on page 82 “ADDING/DELETING A VOICE MEMO” on page 97 		
		Create a schedule from a captured still image <ul style="list-style-type: none"> “Making a schedule shot” on page 73 		
Playback	Getting started viewing images <ul style="list-style-type: none"> “Playing back the video clip” on page 39 	Adjust the speaker volume <ul style="list-style-type: none"> “PLAYBACK VOLUME” on page 91 		
	<ul style="list-style-type: none"> “Viewing still images” on page 35 	Search for image/audio data <ul style="list-style-type: none"> 9-image/36-image display playback on page 36 Magnify an image <ul style="list-style-type: none"> “Magnifying (zooming in) the image” on page 37 	Check the focus status <ul style="list-style-type: none"> “ZOOM JUMP PLAYBACK” on page 92 Change the angle of view <ul style="list-style-type: none"> “ROTATE IMAGE” on page 100 	
	<ul style="list-style-type: none"> “Playing back audio recordings” on page 66 	Adjust the speaker volume <ul style="list-style-type: none"> “PLAYBACK VOLUME” on page 91 		
	Slideshow playback <ul style="list-style-type: none"> “SLIDESHOW PLAYBACK” on page 111 			
	Adjust the LCD monitor brightness <ul style="list-style-type: none"> “LCD MONITOR BRIGHTNESS” on page 125 			
	Playback on a TV <ul style="list-style-type: none"> “CONNECTING TO A TV” (for playback) on page 140 		Set the TV system <ul style="list-style-type: none"> “TV SYSTEM SETTING” on page 127 	

	Basic operation	Convenient functions	Additional functions
Data managing/processing	Search for image/audio data <ul style="list-style-type: none"> • "9-image/36-image display playback" on page 36 		
	Delete data <ul style="list-style-type: none"> • "ERASING DATA" on page 89 	Protect images from accidental erasure <ul style="list-style-type: none"> • "IMAGE PROTECT" on page 87 Format a card <ul style="list-style-type: none"> • "INITIALIZING THE CARD MEMORY AND INTERNAL MEMORY" on page 133 	
	Add an audio track to still image data <ul style="list-style-type: none"> • "ADDING A VOICE MEMO" on page 82 • "ADDING/DELETING A VOICE MEMO" on page 97 		
	Create a schedule from a captured still image <ul style="list-style-type: none"> • "Making a schedule shot" on page 73 • "ENTER AN IMAGE IN THE SCHEDULE" on page 94 		
	Specify the number of prints, index print, and date imprint <ul style="list-style-type: none"> • "PRINT SETTINGS" on page 104 		
	View the settings that were in effect when the image/audio data was recorded <ul style="list-style-type: none"> • "DISPLAYING IMAGE PROPERTIES (INFORMATION SCREEN)" on page 113 		

CONTENTS

GETTING UP AND RUNNING	iii
QUICK SEARCH BY OPERATION	1
CONTENTS	5
CHECKING THE INCLUDED ACCESSORIES	9
GETTING THE MOST OUT OF YOUR CAMERA	11
SYSTEM MAP	13

■ SETUP

PARTS NAMES	14
INSTALLING THE CARD	16
POWER FOR THE CAMERA	18
TURNING THE CAMERA ON AND OFF	21
DATE AND TIME SETTING	23

■ BASIC OPERATION

ABOUT THE 2WAY SHOOTING GUIDE (Guidance display)	26
BEFORE TAKING PICTURES	28
CAPTURING AND PLAYING BACK STILL IMAGES	33
VIDEO CLIP RECORDING AND PLAYBACK	38
USING THE ZOOM	42
FLASH SETTING	43
EXPOSURE CORRECTION	45

■ SHOOTING (EASY SETTING MODE)

EASY SETTINGS SCREEN	46
OVERVIEW OF THE EASY SETTINGS SCREEN	47
SCENE SELECT	48
FILTERS	52

■ SHOOTING (SHOOTING SETTING SCREEN)

ACCESSING THE SHOOTING SETTING SCREEN	53
TOUCH SENSOR (TOUCH FOCUS) SETTING	63
RESOLUTION SETTING	64
MAKE AN AUDIO RECORDING	65
FOCUS RANGE	67
SELF-TIMER	69
SHUTTER OPERATION SETTING	71
FOCUS AREA SETTING	76
LIGHT-MEASURING MODE SETTING	77
ISO SENSITIVITY	78
WHITE BALANCE	79
FLICKER-REDUCTION SETTING	81
ADDING A VOICE MEMO	82

■ PLAYBACK

DISPLAYING THE PLAYBACK SETTING SCREENS	83
IMAGE PROTECT	87
ERASING DATA	89
PLAYBACK VOLUME	91
ZOOM JUMP PLAYBACK	92
DISPLAYING THE SCHEDULE	93
ENTER AN IMAGE IN THE SCHEDULE	94
ADDING/DELETING A VOICE MEMO	97
CHANGING IMAGE SIZE (RESIZE)	99
ROTATE IMAGE	100
EXTRACTING A STILL IMAGE FROM A VIDEO CLIP	101
COPY DATA	102
PRINT SETTINGS	104
SLIDESHOW PLAYBACK	111
DISPLAYING IMAGE PROPERTIES (INFORMATION SCREEN)	113

■ OPTION SETTINGS

DISPLAYING THE OPTION SCREEN	114
SET THE 2WAY SHOOTING GUIDE SETTING	117
SELECT THE STARTUP DISPLAY	118
OPERATION SOUNDS	119
HELP DISPLAY	121
POST-VIEW SETTING	122
ZOOM SETTINGS	123
LCD MONITOR BRIGHTNESS	125
SCREEN LANGUAGE	126
TV SYSTEM SETTING	127
POWER SAVE FUNCTION	128
FILE No. RESET FUNCTION	130
INITIALIZING THE CARD MEMORY AND INTERNAL MEMORY	133
RESETTING THE CAMERA SETTINGS	135
CHECKING THE REMAINING INTERNAL MEMORY AND CARD MEMORY	136
CHECKING THE REMAINING BATTERY PACK CHARGE	138

■ OTHER DEVICES AND CONNECTIONS

CONNECTING TO A TV	140
DIRECT PRINTING	141

■ APPENDICES

COMMONLY ASKED QUESTIONS	150
TROUBLESHOOTING	157
SPECIFICATIONS	165
HINTS FOR TAKING PICTURES	175

CHECKING THE INCLUDED ACCESSORIES

- Handstrap: 1
- SANYO Software Pack (CD-ROM): 1
- Li-ion battery pack: 1
- Dedicated AV interface cable: 1
- Dedicated USB interface cable: 1
-

Attaching the handstrap

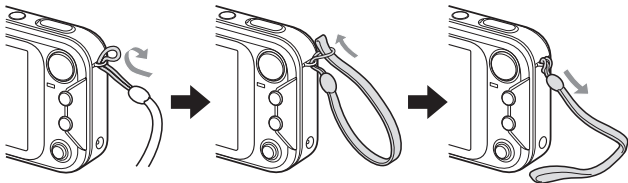

Media cards that can be used with this camera

The types of card that can be inserted into and used with this camera are:

- SD Memory Card
- Multi Media Card

What “card” means in this manual

- In this manual, SD Memory Cards and Multi Media Cards that can be used in this digital camera are referred to as “card”.
- The cards in the illustrations in this manual are SD Memory Cards, but all installation, removal, and formatting procedures are the same for both SD Memory Cards and Multi Media Cards.

GETTING THE MOST OUT OF YOUR CAMERA

Your camera can not only take still photos, it can also record video clips and make audio recordings.

It's loaded with lots of functions that are possible only in a digital camera, including a super-quick focus, an easy-to-understand guidance display on a large screen, a schedule-making function that incorporates your captured images, and more.

Never again miss a great shot, thanks to the quick focus: Touch focus (see page 28)

Just touch the shutter button lightly, and the touch sensor automatically focuses the image (touch focus).

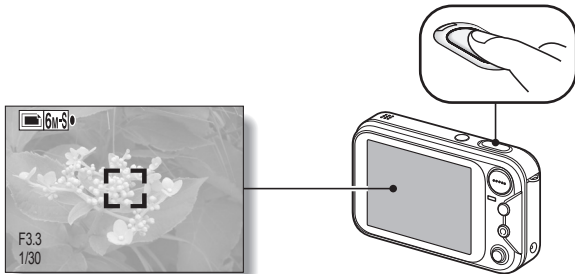

Complex operation made easy with the guidance feature: Shooting Guide display (see page 26)

The current shooting settings are visible right on the Shooting Screen. When the camera detects a possible problem—such as camera shake due to a slower shutter speed or an underexposed subject due to light from behind—the appropriate countermeasures are shown on the display. Use the suggestions, or not, as you wish to get exactly the photo you want.

Mode Select Screen

Switch between the still photo shooting and video clip recording modes with a single on-screen action. Accessing the Shooting Setting Screen has never been so fast.

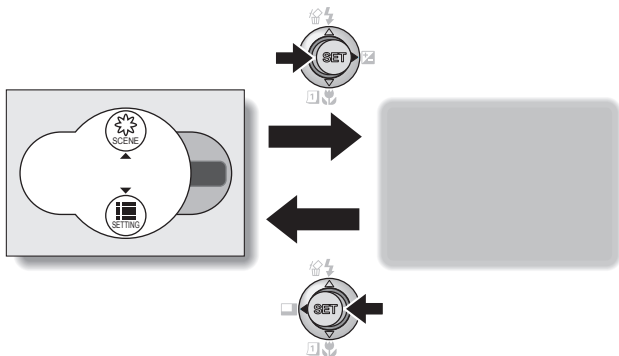

Create a schedule from your photos: schedule-making feature (see page 73)

Enter your photos in the calendar to create a custom image-based schedule. For example, you could snap a photo of a movie poster and record it in the calendar on the date of the movie's premiere.

SYSTEM MAP

The included accessories can be used to connect your camera to a computer, printer or TV. By connecting the camera to your computer, you can, for example, copy your photos to the computer's hard disk. You can connect it to a printer for direct printing of your photos. Or take the card to a photo shop to have your photos printed there.

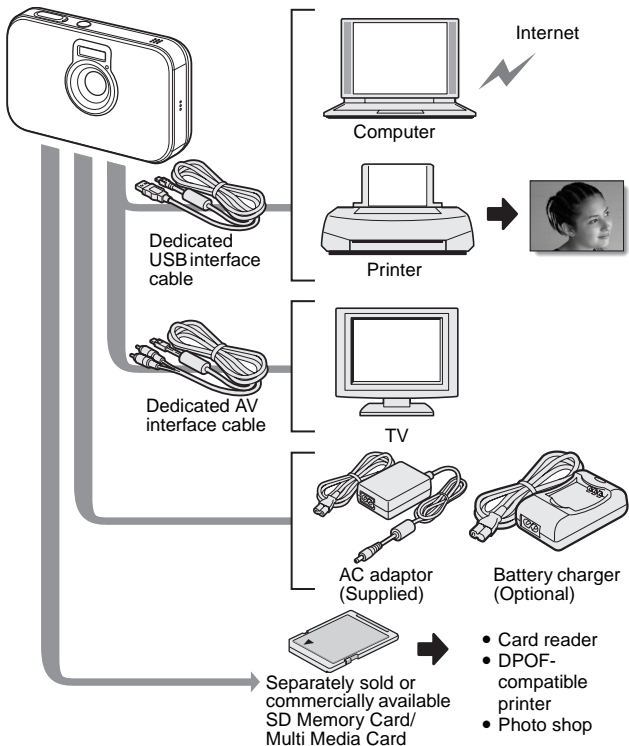

PARTS NAMES

Front

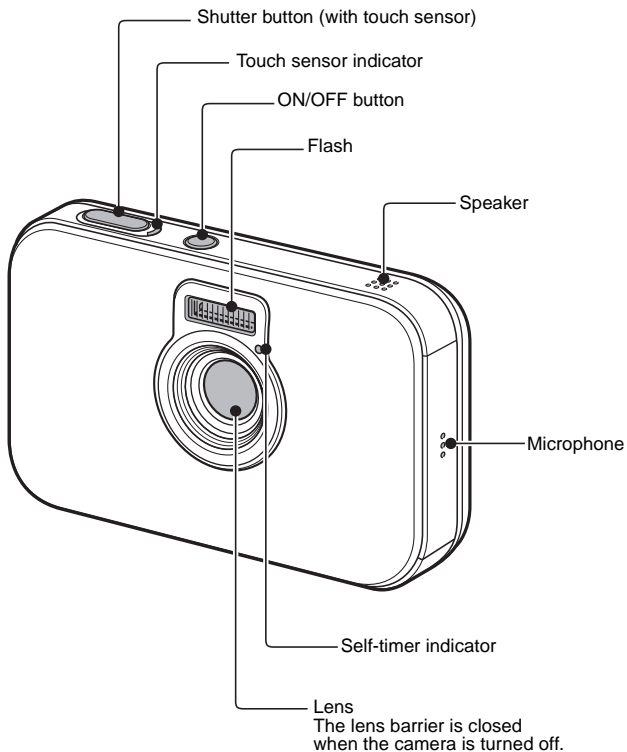

PARTS NAMES

Rear

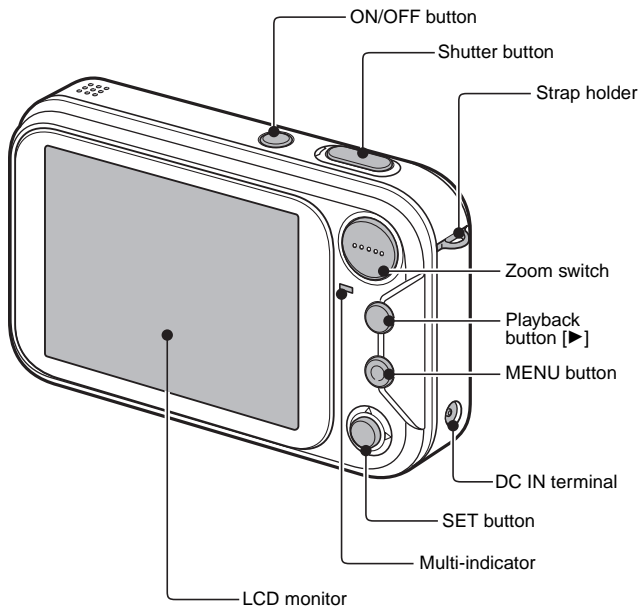

Bottom

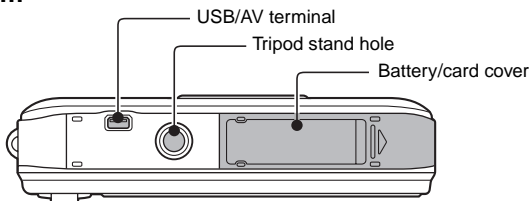

INSTALLING THE CARD

Your camera has an internal 16MB memory, when means that you can take photos (record image data) even when no card is installed. By using a card, however, you will be able to take many more photos. The card can be used after it has been formatted with the camera (page 133).

1 Open the battery/card cover.

- While gently pressing the battery/card cover, slide it open.

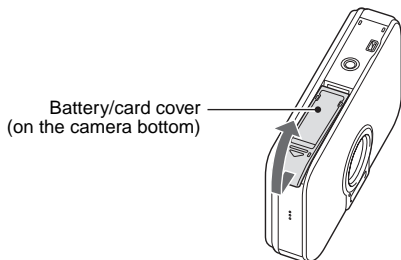

2 Insert the card, and close the battery/card cover.

- Firmly insert the card until it clicks into place.

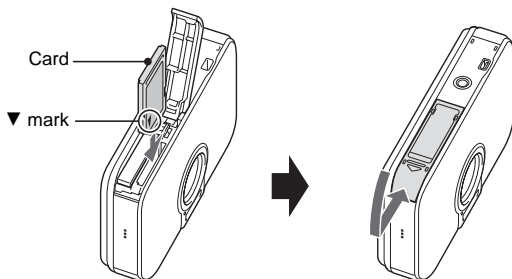

INSTALLING THE CARD

When removing the card...

- To remove the card, press it down, and then release. The card will protrude slightly, and you can then pull it out.

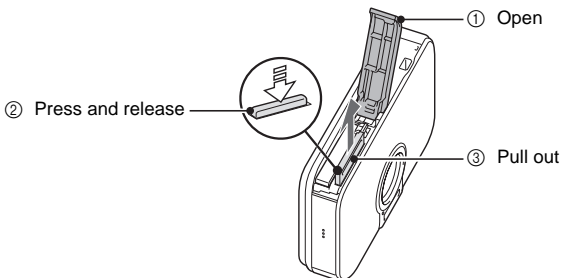

CAUTION

- Do not attempt to forcibly remove the card.
- Never remove the card when the multi-indicator is flashing red quickly. In doing so, you risk losing the data stored in the card.

HINT

Shooting without a card installed

- The camera has a 16MB internal memory that lets you photograph and playback images even when there is no card installed. When the camera is turned on with no card installed, the internal memory icon  is shown on the LCD monitor to let you know that the images you capture will be saved to the camera's internal memory.

POWER FOR THE CAMERA

The supplied AC adaptor is used not only as the camera's AC adaptor, but also to charge the battery installed in the camera.

Using the battery pack

At the time of purchase, the battery pack is not charged. The battery pack must be charged before it can be used in the camera. Also, if the battery power becomes depleted when the camera is being used (see CHECKING THE REMAINING BATTERY PACK CHARGE [page 138]), it should be recharged as soon as possible.

1 Install the battery pack.

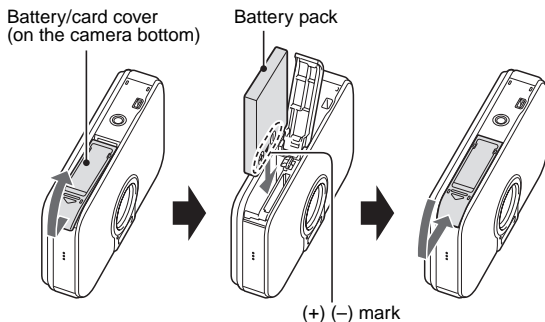

POWER FOR THE CAMERA

2 Turn the camera off, and connect the AC adaptor to the camera.

- Charging begins as soon as the AC adaptor is connected to the camera. However, the camera does not charge when it is set to the shooting mode.
- The camera's multi-indicator lights red during charging.
- Charging will take approximately 90 minutes.
- The multi-indicator will turn off when the battery pack is fully charged.

ON/OFF button

- Turn the camera off.

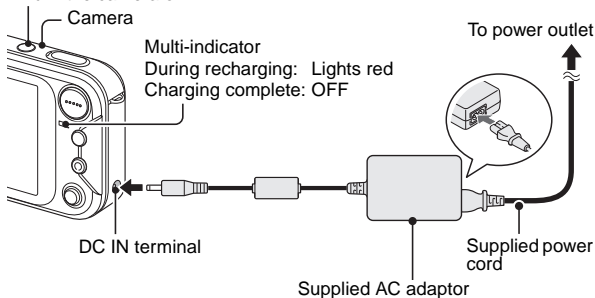

3 Disconnect the AC adaptor after charging is completed.

Using a power outlet

When the supplied AC adaptor is connected to the camera, power can be supplied from a power outlet.

HINT

About the internal backup battery

- This camera's internal battery serves to maintain the date and time settings, as well as the shooting settings. The backup battery will be fully charged when the battery pack is kept in the camera continuously for about 2 days. In the fully charged state, the backup battery will maintain the camera settings for about 7 days.

When not using the camera for a long time, remove the battery pack

- A small amount of power is still used even if the camera is turned off, and it is therefore recommended that the battery pack be removed from the camera if it is not going to be used for a long time. Note that when the battery pack is removed for a long period, the time and date settings may be cleared. Before using your camera again, be sure to confirm that the camera settings are correct.

TURNING THE CAMERA ON AND OFF

Turning on the camera

In the shooting mode

- 1 **Press the ON/OFF button.**
 - The camera turns on.
 - The camera turns on in the shooting mode that was active before it was last turned off.

In the playback mode

- 1 **Press the playback button [▶] for at least one second.**
 - The Playback Screen appears on the LCD monitor (page 35).

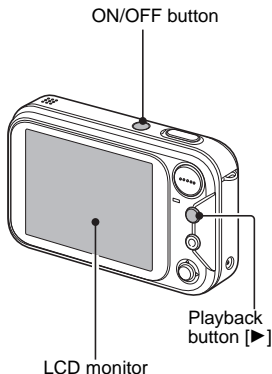

Turning off the camera

- 1 **Press the ON/OFF button.**
 - The camera turns off.
 - <If the camera was turned on by pressing the playback button [▶]>**
 - When the playback button [▶] or ON/OFF button is pressed, the camera turns off.

Turning on the camera when the power save (sleep) function is active

In order to preserve battery pack power, the power save (sleep) function will automatically turn off the camera after one minute of no use during shooting, or five minutes of no use during playback (factory-preset setting).

- When the power save function is active, you can restore the power by any of the following methods:
 - Press the playback button [▶].
 - Press the SET or MENU button.
 - Press the shutter button.
 - Press the ON/OFF button.
- When the AC adaptor is connected, the power save function will become active about 10 minutes after the camera is turned on (factory-preset setting).
- The user can specify the time elapsed before the power save function is activated (page 128).
- When the camera is connected to a computer or printer using the dedicated USB interface cable, the power save function is disabled, and the camera turns off after about 12 hours.

HINT

If the  icon appears...

- When a picture is taken, the date and time it was captured is recorded with it. When the date and time cannot be recorded with the image because the date and time have not yet been set (page 23), the  icon appears. To have the date and time recorded with images, please make this setting before capturing images.

G

audio recording is
therefore, before
are set.

2005

and press the MENU

5 Set the date.

- 1 Select "DATE".
- 2 Press the SET button.
 - The Set Date Screen appears.
- 3 Set the date to "2005/12/24".
 - The date is set in the following order: Set the year → Set the month → Set the day.
 - Toggle the SET button left or right to select year, month or day. Toggle the SET button up or down to increase or decrease the number.
- 4 Press the SET button.

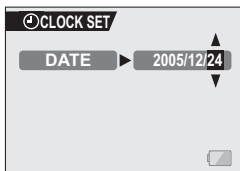

6 Set the time.

- 1 Select "TIME".
- 2 Press the SET button.
 - The Set Time Screen appears.
- 3 Set the time to "19:30".
 - The time is set in the following order: Set the hour → Set the minute.
 - A 24-hour clock is used for the time display.
- 4 Press the SET button.

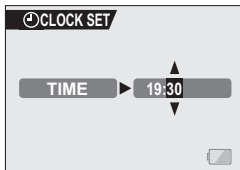

7 Set the order in which the date is displayed during playback.

- 1 Select "DISP".
- 2 Press the SET button.
 - The Set Date Format Screen appears.
- 3 Toggle the SET button up or down.
 - Toggle the SET button up to change the displayed date order as follows:

→ year/month/day → month/day/year → day/month/year → DISP OFF (no display)

Toggle the SET button down to change it in the reverse order.

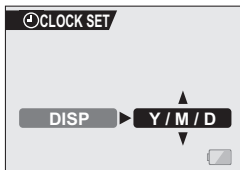

DATE AND TIME SETTING

- If "DISP OFF" is selected, the date the image was captured is not shown during playback.
- ④ Press the SET button.

8 Select "EXIT", and press the SET button.

- The date and time setting is completed, and you are returned to the Option Screen.
- To return to the Shooting Screen, press the MENU button.

HINT

- Under normal conditions, while the battery pack is being replaced, an internal battery will maintain the date and time settings. However, there is a small chance the settings may be lost. (The backup will last for about 7 days.) It is recommended to check that the date and time settings are still correct after replacing the battery pack and before shooting or recording of any type (follow steps **1** and **4**).

To correct the date and time settings

- After steps **1** and **4**, select the line of the setting that you want to change, press the SET button, and follow the steps in the respective paragraphs above to change the setting.

ABOUT THE 2WAY SHOOTING GUIDE

(Guidance display)

Your camera features a “2WAY Shooting Guide” settings and a next-step guide are shown or

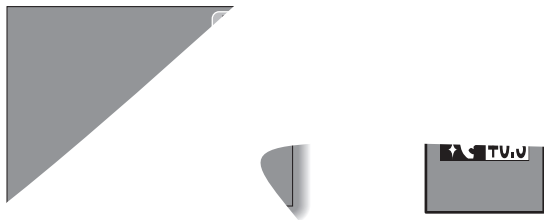

④

⑤

- Exposure correction (page 45)
- Internal memory icon (page 16)
- Shooting operation setting (page 43)
- White balance select setting (page 48)
- White balance setting (page 52)
- White balance mode display

ABOUT THE 2WAY SHOOTING GUIDE (Guidance display)

To display the 2WAY Shooting Guide

- Toggle the SET button to the left, and the Shooting Screen will be displayed full-screen. Toggle the SET button to the left again to display the 2WAY Shooting Guide.



- By selecting the 2WAY shooting guide icon  from the Option Screen, you can set the camera to display the 2WAY Shooting Guide (page 117).

In this manual...

- For the purpose of clarity, the LCD monitor display examples are shown with the 2WAY Shooting Guide turned off. Please note, however, that the actual operation is the same even when the 2WAY Shooting Guide is displayed.

BEFORE TAKING PICTURES

How to hold the camera

Hold the camera securely, keeping your elbows close to your body and making sure the camera is stable.

Correct hold



Incorrect hold



A finger is blocking the lens or flash.

Make sure that the lens and flash are not blocked by your fingers or the handstrap.

HINT

- Images captured in the still image shooting mode can be rotated when they are played back (page 100).
- When the optical zoom is used or when the autofocus is operating, the image may appear to waver, but this is not a malfunction.

About the touch sensor (touch focus)

With the touch sensor, the image is focused simply by a light finger-touch on the shutter button (focus lock). With the subject in focus, just gently press the shutter button to take the picture for a perfectly focused image.

At the same time, the touch sensor is temporarily deactivated whenever the Mode Select Screen (page 31) or Shooting Setting Screen is displayed, thereby facilitating operation of these screens.

Furthermore, you can also deactivate the touch sensor so that the autofocus operates only when you press the shutter button halfway (page 63).

BEFORE TAKING PICTURES

Using the autofocus

The autofocus will work in almost all situations; however, there are certain conditions that may cause the autofocus function to not work properly. If the autofocus function is not working properly, set the focus range to capture images (page 67).

■ Conditions that may cause incorrect focus

The following examples are some of the situations where the autofocus function may not work.

- **Subjects with low contrast, very bright subjects at the center of the image or dark subjects or locations**

Use the focus-lock function to lock the focus on an object with contrast at the same distance as the desired subject.



- **Subjects without vertical lines**

Use the focus-lock function to lock the focus on the subject while holding the camera vertically.

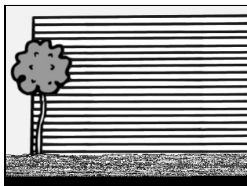

The following examples are some of the situations where the autofocus function may work, but not as desired.

- **When both near and far objects are present**

Use the focus-lock function to lock the focus on an object at the same distance as the desired subject, then reposition the camera to compose the picture.



- **Fast-moving subjects**

Use the focus-lock function to lock the focus on an object at the same distance as the desired subject, then reposition the camera to compose the picture.

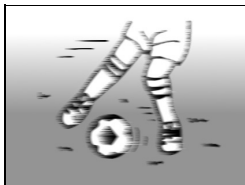

BEFORE TAKING PICTURES

How to switch the shooting mode

Your camera can both capture still photos (still image shooting mode) and record video clips (video clip recording mode). When shooting, you can switch the shooting mode on the Mode Select Screen.

1 Press the ON/OFF button to turn the camera on, and press the MENU button.

- The Mode Select Screen appears.

2 Toggle the SET button to the left or right.

- The shooting mode is switched.

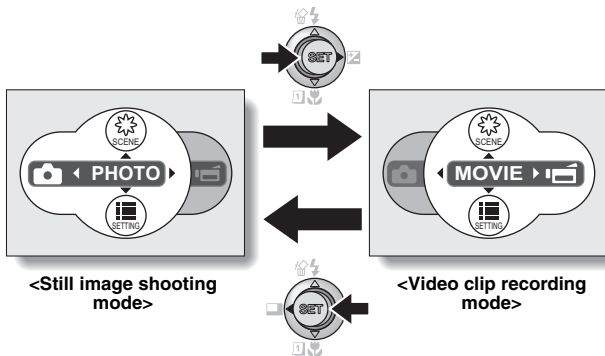

3 Press the MENU button.

- The display changes to the Shooting Screen.

Hints for taking pictures

Muting the operation sounds

- The operation sounds that are generated, for example, when the shutter button, MENU button or SET button is pressed, as well as the audio guidance when you switch the mode, can be muted (page 119).

Where is the image and audio data saved?

- All the image and sound data is recorded in the camera's internal memory or on the card installed in the camera.
- When a card is installed in the camera, the data is recorded on the card. If no card is installed, the data is recorded in the camera's internal memory.

Taking pictures in backlight conditions...

- When taking pictures with the light coming from behind the subject, due to the characteristics of the CCD, light lines or ghost patterns (flare phenomenon) may appear in the captured image. In this situation, it is recommended that you avoid taking pictures with the subject lit from behind.

While the image data is being recorded...

- While the multi-indicator is flashing red quickly, the image data is being written to the memory, during which time it is not possible to capture another image. Another image can be captured after the flashing red indicator turns off. However, even when the multi-indicator is flashing red, depending on the camera's internal memory remaining capacity, in some cases the next image can be captured about 2 seconds after shooting.

CAPTURING AND PLAYING BACK STILL IMAGES

Your camera can both capture still images and record video clips. There are two modes for capturing still images. In the normal still image mode, one image is captured each time the shutter button is pressed. In the sequential shots mode, when you press the shutter button, several successive images are captured. For more information about taking sequential shots, please see page 72.

Shooting single shots

1 Press the ON/OFF button to turn the camera on.

- The Still Image Shooting Screen appears.

2 Rest your finger on the shutter button.

- If the touch sensor (page 63) has been set to ON, when the shutter button is touched, the autofocus operates and the image is focused (focus lock).



<If the touch sensor is set to OFF>

- Engage the autofocus by pressing the shutter button halfway.

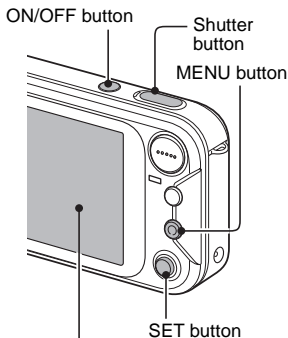

<Still Image Shooting Screen>

3 Gently press the shutter button.

- Press the shutter button gently, taking care not to move the camera.
- The image that was captured appears on LCD monitor as long as the shutter button is kept pressed (post view).

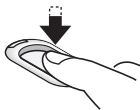

4 Release your finger from the shutter button.

- The captured image is recorded.

HINT

What is the camera focusing on?

- A target mark  on the LCD monitor shows the area the camera is focusing on.
- The camera automatically determines the correct focus by measuring from 9 different focus points within the shooting area. If the target mark is at a position that is different from the point you wish to focus on, you can refocus, for example, by changing the shooting angle.
- The large target mark appears when the camera focuses on a wide area in the center of the screen.

Focus indicator

Target mark

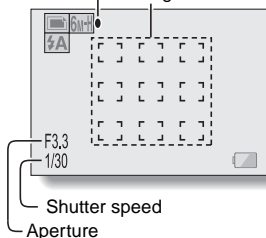

About the focus indicator

- A green focus indicator appears when the subject is successfully focussed, or a red focus indicator when the camera was not able to focus the subject.

The shutter speed and aperture are displayed

- When the camera focuses and the target mark appears, at the same time, the shutter speed and aperture settings are also displayed. You can use them as a reference when shooting.

Motion alert icon

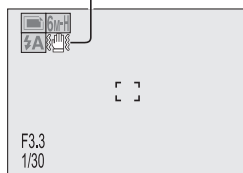

If the motion alert icon appears...

- During still image shooting, if the shutter speed is slow and the possibility that the image may be blurred due to camera shake becomes high, the motion alert icon may appear on the LCD monitor. In this case, use a tripod to stabilize the camera when shooting, or set the flash operation mode to automatic (page 43).
- When shooting with the scene select function set to the fireworks  mode, the motion alert icon always appears, but this is normal.

CAPTURING AND PLAYING BACK STILL IMAGES

Viewing still images

The steps for viewing both single shots and sequential shots are the same.

5 Press the playback button [▶].

- The image most recently captured appears on the LCD monitor.

6 View other images.

- Toggle the SET button to the left or right to display the previous or next image.
To display the previous image:

Toggle the SET button to the left.

To display the next image:

Toggle the SET button to the right.

- To return to Shooting Screen, press the playback button [▶].

<If the camera was turned on by pressing the playback button [▶]>

- When the playback button [▶] or ON/OFF button is pressed, the camera turns off.

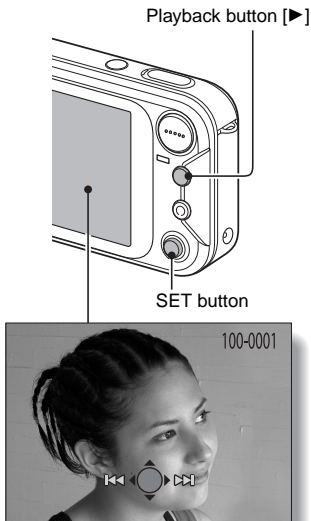

When you are finished viewing images...

- Press the ON/OFF button to turn the camera off.

HINT

For still images with voice memo (page 82 and 97)...

- When the shutter button is pressed, the voice memo is played back.

9-image/36-image display playback

- 1 Press the playback button** [▶].

- 2 Press [W] ([) on the zoom switch.**

- The 9-image display appears.
- When [W] on the zoom switch is pressed again, the 36-image display appears. To return to the 9-image display, press [T] on the zoom switch.

- 3 Select the image to play back.**

- Toggle the SET button up, down, left or right to move the orange frame to the desired image, and press the SET button.
- When the 9-image display is shown, instead of pressing the SET button, you can press [T] ([) on the zoom switch to show the image full screen.

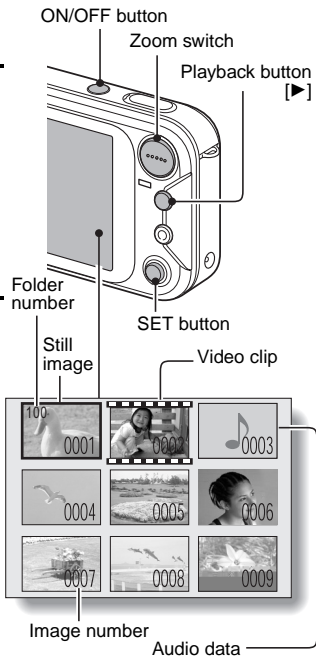

CAPTURING AND PLAYING BACK STILL IMAGES

Magnifying (zooming in) the image

1 Display the image that you want to magnify.

2 Press [T] ([) on the zoom switch.

- Magnification is enabled.
- The image is magnified, and the central portion of image is displayed.
- Toggle the SET button to view different parts of the magnified image.

To magnify:

Magnification increases with each press of [T] ([) on the zoom switch.

To return to normal size:

Magnification decreases with each press of [W] ([) on the zoom switch.

- Press the SET button to return to the normal (100%) view.



HINT

The magnified portion of the image can be saved as a separate image.

- Press the shutter button. The magnified portion is saved as a new still image.

VIDEO CLIP RECORDING AND PLAYBACK

VIDEO CLIP RECORDING AND PLAYBACK

Playing back the video clip

6 Press the playback button [▶].

- The video clip just recorded appears on the LCD monitor.
- Video clips are indicated by a video clip pattern along the top and bottom of the screen.

7 Press the SET button.

- Video clip playback begins.

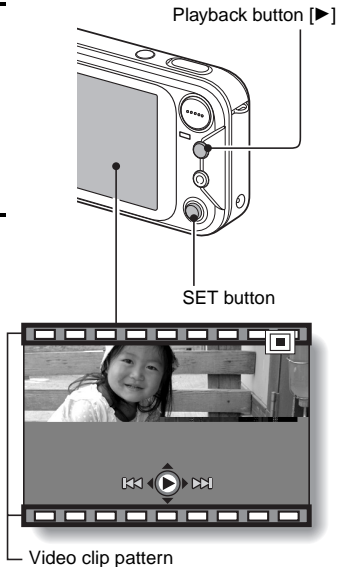

Outline of playback operation

To do this...		Do this
Pause		During playback, press the SET button.
To play back one image at a time (single-frame step)	During forward playback	After pausing playback, toggle the SET button to the right.
	During reverse playback	After pausing playback, toggle the SET button to the left.
Slow playback	During forward playback	After pausing playback, press and hold the SET button to the right.
	During reverse playback	After pausing playback, press and hold the SET button to the left.
To accelerate playback	Forward playback	During forward playback, toggle the SET button to the right. * The playback speed changes each time the SET button is toggled to the right, as follows: Normal playback → 2x → 5x → 10x Toggle the SET button to the left to resume normal playback speed.
	Reverse playback	During forward playback, toggle the SET button to the left. * The playback speed changes each time the SET button is toggled to the left, as follows: 10x ← 5x Toggle the SET button to the right to resume normal playback speed.
Return to normal playback speed		Press the SET button.
Adjusting the volume		Louder: During playback, press [T] on the zoom switch. Softer: During playback, press [W] on the zoom switch.

When you are finished viewing video clips...

- Press the ON/OFF button to turn the camera off.

VIDEO CLIP RECORDING AND PLAYBACK

HINT

Adjusting the LCD monitor brightness

- While the Shooting Screen is active, you can quickly access the screen for adjusting the brightness of the LCD monitor by pressing the MENU button for at least 1 second.

Display the video clip playback point

- During video clip playback, press the MENU button for at least 1 second to display a bar showing the current playback point in the video clip.
- Press the MENU button for about 1 second to cancel the bar.

CAUTION

If no audio is heard...

- The audio is not played back when the video clip is played back in the frame-by-frame playback or reverse playback mode.

During video clip playback, the sound of a motor is audible

- During recording, the sound of the optical zoom movement or autofocus movement was recorded. This is not a malfunction.

The data for a video clip is very large.

- Therefore, be aware that if the video clip is uploaded to a computer to be played back, the computer may not be able to play back the video fast enough, making it appear jerky. (The video will always be displayed properly on the LCD monitor or a television.)

When the remaining card memory becomes 10 percent or less of the total card capacity...

- The remaining memory icon appears on the LCD monitor.
- Depending on the card, shooting may end even before the possible shooting time indicated.

USING THE ZOOM

Your camera has two zoom functions: optical zoom and digital zoom. You can specify whether or not the digital zoom is enabled, and whether or not the optical zoom during video clip recording is enabled (page 123).

1 Point the camera lens at the subject.

2 Press [T] or [W] on the zoom switch to compose the desired image.

[T]: Zoom in on the subject.

[W]: Zoom out.

- When the zoom switch is pressed, the zoom bar appears on the LCD monitor.
- When the optical zoom factor is at maximum, zooming stops temporarily. When [T] on the zoom switch is pressed again, the mode changes to the digital zoom mode and zooming continues.

3 Take the picture.

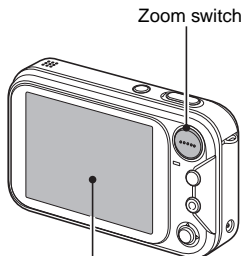

LCD monitor

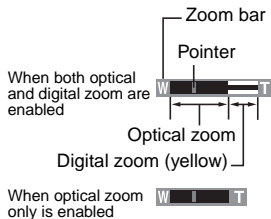

CAUTION

- If the optical zoom is used during video clip recording, the noise from the movement of the lens may be audible in the recording.

FLASH SETTING

The flash is used not only for taking pictures where there is insufficient light, but also when the subject is in shade or in backlight conditions. Your camera's flash has four modes of operation (automatic flash mode, forced flash mode, flash off mode, and red-eye reduction mode). Select the flash mode that is appropriate for the surrounding conditions. The flash can be enabled only when taking single-shot still images.



1 Display the Still Image Shooting Screen (page 33).

2 Toggle the SET button up.

- The flash setting changes.
- The flash setting appears on the LCD monitor.
- The flash setting can also be changed from the Shooting Screen (page 56).

No flash indication:

The camera will detect the subject brightness and use the flash only when required. In a backlight situation, if only the center of the image is very dark, the flash will operate to compensate (auto flash).

- : The flash will operate with every image captured regardless of the conditions. Use this setting under backlight conditions, when the subject is in shade, under fluorescent lighting conditions, etc. (forced flash).
- : The flash will not operate even in dark situations. Use this setting when capturing an image in a location where flash photography is prohibited, or when shooting a night landscape scene (flash off).
- : The digital camera will detect the subject brightness and use the flash only when required. At this time the flash will operate in a manner that reduces the red reflection ("red-eye") in the subject's eyes (red-eye reduction).

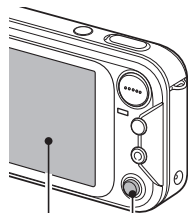

SET button

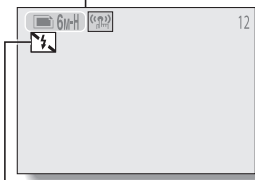

Flash mode icon

3 Toggle the SET button up to set the flash mode.

- Each time the SET button is toggled up, the flash mode changes.
- Display the icon for the desired flash mode.

4 Press the shutter button.

- The picture is snapped and the flash operates according to the selected mode.

HINT

In the automatic flash mode...

- In the automatic flash mode using the LCD monitor, when the shutter button is depressed halfway, a  icon appearing on the LCD monitor indicates that the flash will operate.

EXPOSURE CORRECTION

When capturing images, you can make the image lighter or darker.

- 1 Point the camera lens at the subject.**
 - If the Mode Select Screen or a menu screen (Shooting Setting Screen) is active, press the MENU button to exit it.
- 2 With the Shooting Setting Screen not shown, toggle the SET button to the right.**
 - The exposure correction bar appears.
- 3 Toggle the SET button to the left or right to adjust the exposure.**
 - The exposure setting numerical value is shown at the left end of the exposure bar. The exposure can be set to a value from -1.8EV to $+1.8\text{EV}$.
 - To cancel the exposure correction bar, press the MENU button.
 - The exposure correction setting can also be accessed from the Shooting Setting Screen (page 58).

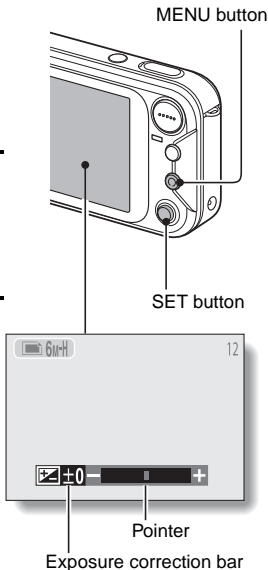

HINT

The exposure correction setting is canceled in the following cases:

- When the pointer is set to the center position.
- When the Option Screen is accessed.
- Press the playback button [▶].
- After the power is turned off.

EASY SETTINGS SCREEN

With the Easy Settings Screen, it's a cinch to get beautiful photos every time, simply by selecting the setting that matches your shooting conditions.

- 1 Press the ON/OFF button to turn the camera on, and press the MENU button.**

- The Mode Select Screen appears.

- 2 Toggle the SET button to the left or right to select the desired shooting mode.**

- 3 Toggle the SET button up.**

- The Easy Settings Screen appears.
- Toggle the SET button up or down to choose either the scene select menu or the filter menu.

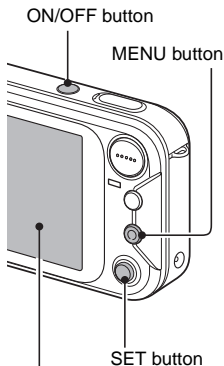

To exit the Easy Settings Screen

Press the MENU button to return to the Mode Select Screen. Press the MENU button again to return to the Shooting Screen.

OVERVIEW OF THE EASY SETTINGS SCREEN

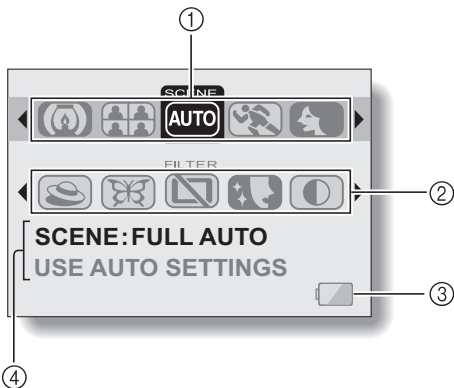

① **Scene select menu (page 48)**

- : Full auto photography
- : Sports photography
- : Portrait photography
- : Landscape photography
- : Night view photography
(Available only when shooting single shots)
- : Fireworks photography
(Available only when shooting single shots)
- : Lamp photography
(Available only when shooting single shots)
- : Best shot photography

② **Filter menu (page 52)**

- : No filter
- : Cosmetic filter selected
- : Monochrome filter selected
- : Sepia filter selected
- : Sharpness filter selected
- : Contrast filter selected
- : Color filter selected

③ **Remaining battery power (page 138)**









④ **HELP display (page 121)**

SCENE SELECT

You can select from various preset settings (aperture, shutter speed, etc.) for specific shooting conditions.

1 Display the Easy Settings Screen (page 46).

2 Select the scene select menu.

-  **AUTO**: The camera automatically makes the optimum settings suitable for the surrounding conditions (full auto).
-  Capture a split-second image of a fast-moving subject (sports mode).
-  Enhance the 3D feeling of the subject by blurring the background (portrait mode).
-  For beautiful shots of distant scenery (landscape mode).
-  Photograph the subject while keeping the background night scenery (night view mode).
-  For capturing fireworks at night (fireworks mode).
-  Photograph in low-light conditions (lamp mode).
-  When the shutter button is pressed, you can capture successive still images as the settings change (best shot mode).

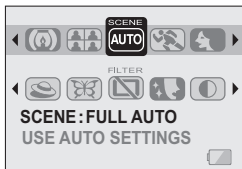

SCENE SELECT

3 Select the desired icon from the scene select menu, and press the SET button.

- This completes the scene select setting.

4 Take the picture.















For video clip recording, see page 38.

For still image shooting, see page 33.

- To return to normal photography, select **AUTO** from the scene select menu, and press the SET button.

Scene select and operation mode

The scene select functions that are available depend on the active operation mode (page 71).





	Operation mode			
	Single shots  Still images with voice memo 	Sequential shots 	Schedule shot  Composite photo 	ID photo 
Auto 	○	○	○	○
Sports 	○	○	○	—
Portrait 	○	○	○	○
Landscape 	○	○	○	—
Night view 	○	—	○	—
Fireworks 	○	—	○	—
Lamp 	○	—	○*	—
Best shot 	○**	—	—	—

○: Available —: Not available

*: Not available for composite photos.

** : Not available for still images with voice memo.

CAUTION

- When capturing images using the lamp , fireworks  or night view  setting, use a tripod or other method to stabilize the camera.
- A table showing the limitations for settings corresponding to scene select icons other than  is on page 163.

SCENE SELECT

How to use the best shot feature

1 Set the camera to the still image shooting mode, select the best shot icon (A) from the scene select menu, and press the SET button.

2 Press the shutter button.

- While the settings change, four still images are shot in sequence.
- If the resolution is set to [10M], the setting changes automatically to [6M-H] and the images are captured.
- After the images are captured, the four still images are displayed on the LCD monitor.

3 Toggle the SET button up, down, left and right to move the orange frame to the image you wish to save.

- For a full frame of the selected image, press the SET button.
- With the view active, you can toggle the SET button to the left or right to view the previous or next image.

<To save images>

- When the images showing on the LCD monitor, press the MENU button.

4 To zoom in and view the size view of the image, press the SET button. To save, select "YES", and press the SET button.







- The image currently displayed is zoomed in, and the other images are not zoomed in.

FILTERS

The filter feature changes image characteristics such as color tones, to apply unique effects to the photographed image.

1 Display the Easy Settings Screen (page 46).

2 Select the filter menu.

- : No filter is used (normal photography).
- : Skin tones are enhanced in close-up shots (cosmetic filter).
- : Snap black-and-white photos (monochrome filter).
- : Create a sepia-tone photo (sepia filter).
- : Accentuates the outlines in the image (sharpness filter).
- : Accentuates the light and dark areas in the image (contrast filter).
- : Accentuates the colors in the image (color filter).



3 Select the desired icon from the filter menu, and press the SET button.

- This completes the filter setting.
-

4 Take the picture.

For video clip recording, see page 38.

For still image shooting, see page 33.

- To return to normal photography, select  from the filter menu, and press the SET button.
-

HINT

- A table showing the limitations for settings corresponding to filter icons other than  is on page 163.

ACCESSING THE SHOOTING SETTING SCREEN

The Shooting Setting Screen is used to adjust the focus range and self-timer settings; to select the single-shot, sequential shots, schedule shot, composite photo, or ID photo operation mode; and to manage various settings such as turning the shutter button touch sensor ON/OFF. This mode is also used to create audio recordings.

- 1 Press the ON/OFF button to turn the camera on, and press the MENU button.**

- The Mode Select Screen appears.
-

- 2 Toggle the SET button to the left or right to select the desired shooting mode.**
-

- 3 Toggle the SET button down.**
 - The Shooting Setting Screen appears.

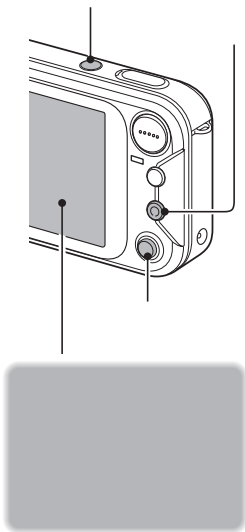

To cancel the Shooting Setting Screen

Press the MENU button once to return to the Mode Select Screen. Press the MENU button again to return to the Shooting Screen.

Switch

The Shooting

1 Display

2 Toggle the

- The Sho
- changes
- Each tim
- to the left

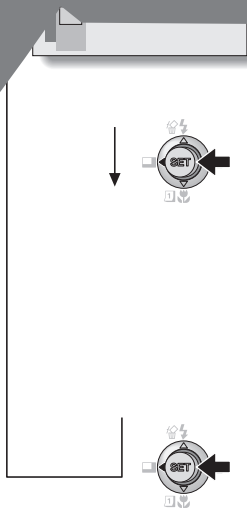

ACCESSING THE SHOOTING SETTING SCREEN

Overview of the Shooting Setting Screen (still images)

PAGE 1

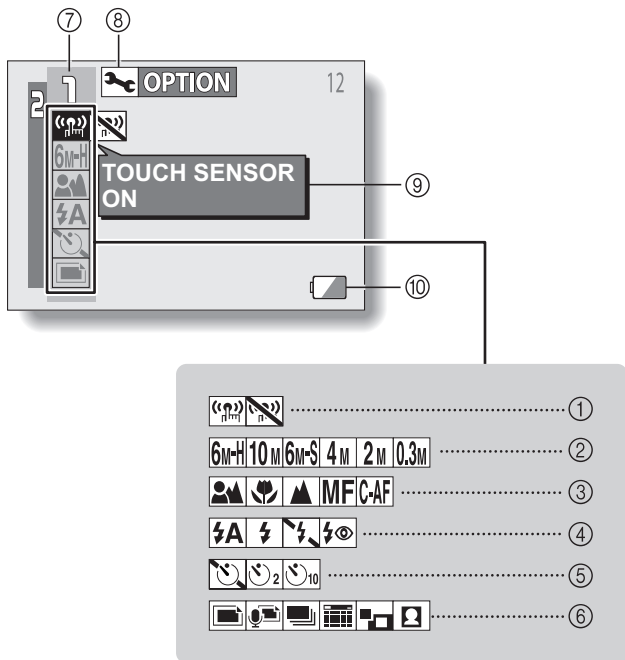

① **Touch sensor menu (page 63)**

: Set the shutter button touch sensor to ON.

: Set the shutter button touch sensor to OFF.

② **Resolution menu (page 64)**

: Shoot at 2,816 × 2,112 pixels, low compression

: Shoot image at 3,680 × 2,760 resolution

: Shoot at 2,816 × 2,112 pixels, standard compression

: Shoot image at 2,288 × 1,712 resolution

: Shoot image at 1,600 × 1,200 resolution

: Shoot image at 640 × 480 resolution

③ **Focus range menu (page 67)**

: Shoot using the autofocus.

: Close-up photography

: Distant focus

: Manual focus

: Continuous AF

④ **Flash menu (page 43)**

: Automatic flash mode

: Forced flash mode

: Flash off mode

: Red-eye reduction

⑤ **Self-timer menu (page 69)**

: Self-timer off

: Shooting begins 2 seconds after the shutter button is pressed.

: Shooting begins 10 seconds after the shutter button is pressed.

⑥ **Operation mode menu (page 71)**

: Shoot single images.

: Shoot single images with an accompanying audio track (voice memo).

: Shoot sequential images.

: Enter the captured image in the schedule.

: Create a composite photo.

: Create ID photos.

⑦ **PAGE display (page 54)**

⑧ **Option icon (page 114)**

- Displays the Option Screen.

⑨ **Help display (page 121)**

⑩ **Remaining battery power (page 138)**

- When you specify multiple functions that cannot be simultaneously enabled, the function which was last set becomes the active setting, and the other settings accordingly change automatically.

ACCESSING THE SHOOTING SETTING SCREEN

PAGE 2





① **Focus mode menu (page 76)**

: 9-point focus mode

: Spot focus mode

② **Light-measuring mode (EXP MEASURE) menu (page 77)**

: Multi-section light-measuring setting

: Center-weighted light-measuring setting

: Spot light-measuring setting

③ **ISO sensitivity menu (page 78)**

: Sets the ISO sensitivity automatically (corresponds to ISO50 to 200).

: Corresponds to ISO50

: Corresponds to ISO100

: Corresponds to ISO200

: Corresponds to ISO400

④ **White balance menu (page 79)**

: The camera will determine the setting automatically.

: For photography in fair weather (sunny) conditions

: In overcast conditions

: Under fluorescent lighting

: Under incandescent lighting

: For setting the most accurate white balance

⑤ **Exposure correction icon (page 45)**

- Change the brightness of the image.

⑥ **PAGE icon (page 54)**

⑦ **Option icon (page 114)**

- Displays the Option Screen.

⑧ **Help display (page 121)**

⑨ **Remaining battery power (page 138)**

- When you specify multiple functions that cannot be simultaneously enabled, the function which was last set becomes the active setting, and the other settings accordingly change automatically.

ACCESSING THE SHOOTING SETTING SCREEN

Overview of the Shooting Setting Screen (video clips)

PAGE 1

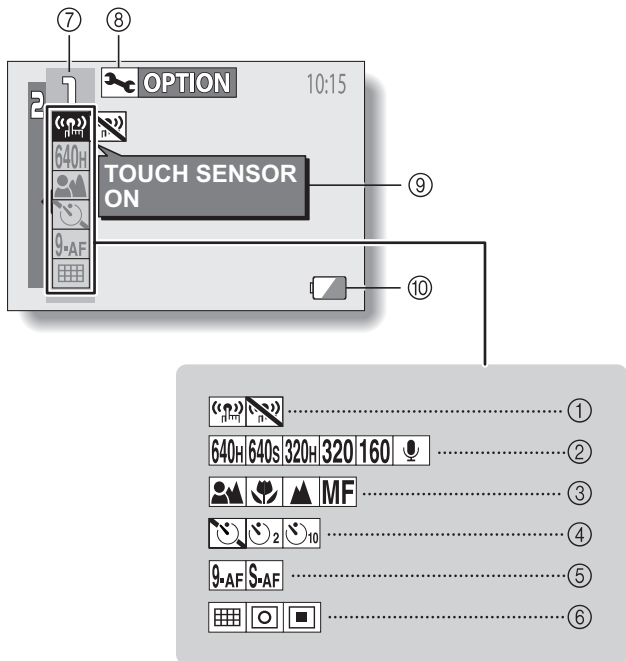



① **Touch sensor menu (page 63)**

: Set the shutter button touch sensor to ON.

: Set the shutter button touch sensor to OFF.

② **Video clip mode menu (page 64)**

: Shoot at 640 × 480 pixels (30 frames/second, low compression)

: Shoot at 640 × 480 pixels (30 frames/second, standard compression)

: Shoot at 320 × 240 pixels (30 frames/second, low compression)

: Shoot at 320 × 240 pixels (15 frames/second, standard compression)

: Shoot at 160 × 120 pixels (15 frames/second, standard compression)

: Make an audio recording (page 65)

③ **Focus range menu (page 67)**

: Shoot using the autofocus.

: Close-up photography

: Distant focus

: Manual focus

④ **Self-timer menu (page 69)**

: Self-timer off

: Shooting begins 2 seconds after the shutter button is pressed.

: Shooting begins 10 seconds after the shutter button is pressed.

⑤ **Focus mode menu (page 76)**

: 9-point focus mode

: Spot focus mode

⑥ **Light-measuring mode (EXP MEASURE) menu (page 77)**

: Multi-section light-measuring setting

: Center-weighted light-measuring setting

: Spot light-measuring setting

⑦ **PAGE display (page 54)**

⑧ **Option icon (page 114)**

- Displays the Option Screen.

⑨ **Help display (page 121)**

⑩ **Remaining battery power (page 138)**

- When you specify multiple functions that cannot be simultaneously enabled, the function which was last set becomes the active setting, and the other settings accordingly change automatically.

ACCESSING THE SHOOTING SETTING SCREEN

PAGE 2

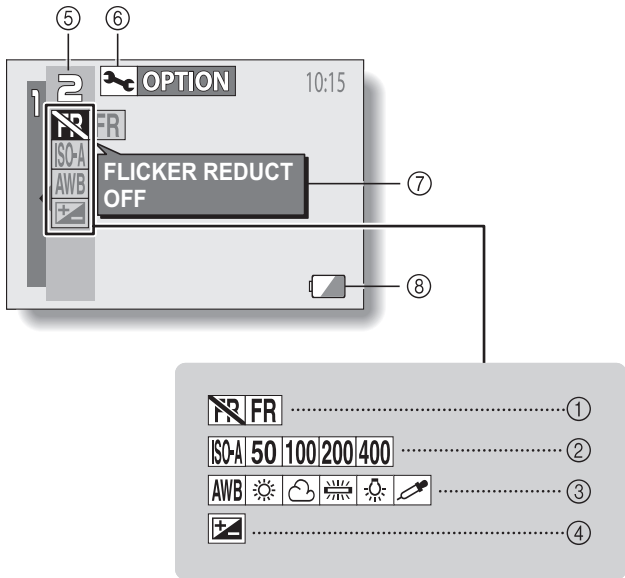

① **Flicker-reduction menu (page 81)**

: Set the flicker-reduction function to OFF.

: Set the flicker-reduction function to ON.

② **ISO sensitivity menu (page 78)**

: Sets the ISO sensitivity automatically (corresponds to ISO450 to 1800).

: Corresponds to ISO450

: Corresponds to ISO900

: Corresponds to ISO1800

: Corresponds to ISO3600

③ **White balance menu (page 79)**

: White balance is automatically adjusted depending on ambient lighting

: For photography in fair weather (sunny) conditions

: In overcast conditions

: Under fluorescent lighting

: Under incandescent lighting

: For setting the most accurate white balance

④ **Exposure correction icon (page 45)**

- Change the brightness of the image.

⑤ **PAGE display (page 54)**

⑥ **Option icon (page 114)**

- Displays the Option Screen.

⑦ **Help display (page 121)**

⑧ **Remaining battery power (page 138)**

- When you specify multiple functions that cannot be simultaneously enabled, the function which was last set becomes the active setting, and the other settings accordingly change automatically.

TOUCH SENSOR (TOUCH FOCUS) SETTING

The touch sensor function, by which the autofocus is activated by a finger-touch on the shutter button, can be set to ON or OFF. When the touch sensor function is set to OFF, the autofocus is activated when you press the shutter button halfway; then gently press the shutter button to snap the picture.

1 Display PAGE 1 of the Shooting Setting Screen (page 53).

2 Select the touch sensor menu.

- The sensor menu appears.

: The touch sensor function is set to ON.

: The touch sensor function is set to OFF.

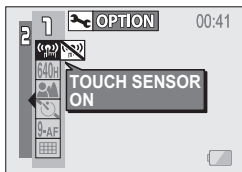

3 Select the desired icon, and press the SET button.

- The selected touch sensor function is set.

CAUTION

- When the camera is attached to a tripod, the touch sensor sensibility may be diminished. This happens because the touch sensor works by detecting changes in the capacitance when the camera is touched with bare hands. The touch sensor sensibility will also be diminished, for example, if you hold the camera with gloved hands.

RESOLUTION SETTING

By setting the image resolution (pixels) to a higher setting, image detail is enhanced for a smoother, finer picture. However, the file size also becomes large and uses more memory. Select the resolution setting that suits your purpose.

1 Display PAGE 1 of the Shooting Setting Screen (page 53).

2 In the still image shooting mode, select the resolution menu; in the video clip recording mode, select the video clip mode menu.

- The resolution menu or video clip mode menu appears.

<Still image shooting mode>

- 6M-H**: Shoot image at 2,816 × 2,112 resolution (low compression)
- 10M**: Shoot image at 3,680 × 2,760 resolution
- 6M-S**: Shoot image at 2,816 × 2,112 resolution (standard compression)
- 4M**: Shoot image at 2,288 × 1,712 resolution
- 2M**: Shoot image at 1,600 × 1,200 resolution
- 0.3M**: Shoot image at 640 × 480 resolution

<Video clip recording mode>

- 640H**: Shoot at 640 × 480 pixels (30 frames/second, low compression)
- 640S**: Shoot at 640 × 480 pixels (30 frames/second, standard compression)
- 320H**: Shoot at 320 × 240 pixels (30 frames/second, low compression)
- 320S**: Shoot at 320 × 240 pixels (15 frames/second, standard compression)
- 160**: Shoot at 160 × 120 pixels (15 frames/second, standard compression)
- 🎤**: Make an audio recording (page 65)

3 Select the desired icon, and press the SET button.

- The selected resolution setting and video clip mode setting are set.

MAKE AN AUDIO RECORDING

In the video clip recording mode, your camera can make audio recordings.

- 1** Display **PAGE 1** of the Shooting Setting Screen for the video clip recording mode (page 53).
-

- 2** Select the audio recording icon  from the video clip mode menu, and press the **SET** button.

- The recording mode is enabled.
- The menu display is canceled if the **MENU** button is pressed.

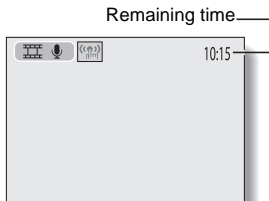

- 3** Press the shutter button.

- Audio recording begins. It is not necessary to continue pressing the shutter button while recording.
- Take care not to cover the microphone with your fingers.
- When the remaining recording time becomes short, the time remaining is indicated in red.
- The maximum time for recording a continuous audio memo is about 9 hours.

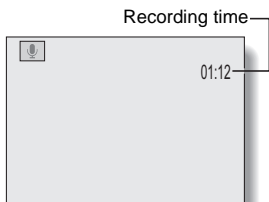

- 4** End the recording.

- Press the shutter button again to stop recording.
-

Playing back audio recordings

Listen to your audio recordings.

- 1 Display the desired audio data.**
 - A musical note graphic appears on the screen.

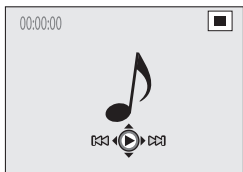

- 2 Play back the recording.**

Forward playback:

Press the SET button.

Pause:

While the audio memo is playing, toggle the SET button up.

Stop playback:

While the audio recording is playing, toggle the SET button down.

Fast forward:

During playback, toggle the SET button to the right.

- The recording is played back at double speed.
- When the SET button is pressed, the recording is played back at normal speed.

Begin reverse playback:

During playback, toggle the SET button to the left.



- The recording is played back in reverse at double speed.
- When the SET button is pressed, the audio is played at normal forward speed.

FOCUS RANGE

1 Display PAGE 1 of the Shooting Setting Screen (page 53).

2 Select the focus range menu.

- Display the focus menu.

- : The camera automatically focuses on the subject within a range of 20 cm (7.87 in.) to infinity (autofocus).
- : You can focus on a subject within a range of 1 cm (0.39 in.) (Wide end) or 50 cm (19.69 in.) (Tele end) to 60 cm (23.62 in.) (super macro).
- : You can focus on a subject in the distance.
- [MF]**: The focus can be manually set to any distance from 1 cm (0.39 in.) to 8 m (26.25 ft), as well as to infinity (manual focus).
- [C-AF]**: The camera continuously focuses on the subject (continuous AF: still image shooting mode only).

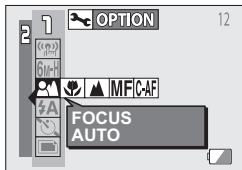

3 Select the desired icon, and press the SET button.

- This completes the focus range setting.

HINT

- When the focus range is set to super macro , the zoom is set to the wide end.
- You can also change the focus range setting from the Shooting Screen by toggling the SET button down.

How to use the manual focus

- 1** Display PAGE 1 of the Shooting Setting Screen (page 53).
- 2** Select the manual focus icon **MF** from the focus menu, and press the SET button.
- 3** Press the SET button.
 - The focus distance adjustment bar appears.
- 4** Toggle the SET button to the left or right to adjust the focus distance, and press the SET button.
 - The focus distance is set, and you are returned to the Shooting Screen.

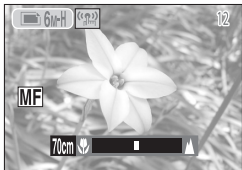

HINT

About the focus range

- The focus distance indication shows the distance between the lens surface and the subject.
- In some cases there may be a slight variance between the distance (numerical figure) you set in the manual focus mode and the actual distance. Use the LCD monitor to confirm the focus and compose the photo.

About zoom movement when using the manual focus



- If the focus distance is set to 30 cm (11.81 in.) or less, the zoom changes to the largest setting that is suitable for that focus distance.
- When the focus distance is set to 30 cm (11.81 in.) or less, the zoom will function only within the range at which the image is focused.

SELF-TIMER

1 Display PAGE 1 of the Shooting Setting Screen (page 53).

2 Select the self-timer menu.

- The self-timer icons are shown.

- : Turns off the self-timer function.
- : The image is captured about 2 seconds after the shutter button is pressed.
- : The image is captured about 10 seconds after the shutter button is pressed.

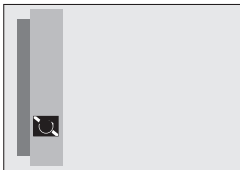

3 Select the desired icon from the self-timer menu, and press the SET button.

- This completes the self-timer setting.

HINT

To pause or cancel the self-timer function...

- If the shutter button is pressed again before the shutter is released, the self-timer countdown temporarily stops. Press the shutter button one more time to restart the self-timer.
- To cancel self-timer photography, set the self-timer setting to off .

When is selected...

- When the shutter button is pressed, the self-timer indicator flashes for approximately 10 seconds, after which shooting begins.
- About 3 seconds before shooting, the self-timer indicator flashes faster.

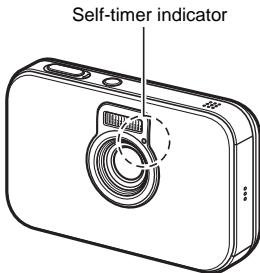







SHUTTER OPERATION SETTING

Select how the camera operates when the shutter button is pressed.

1 Set the camera to the still image shooting mode, and display PAGE 1 of the Shooting Setting Screen (page 53).

2 Select the operation mode menu.

- : When the shutter button is pressed, a single still image is captured (single shot).
- : A single still image is captured with an accompanying audio recording (still image with voice memo shot).
- : When the shutter button is pressed, several still images are captured in succession (sequential shots).
- : A single still image is captured and entered in the calendar (schedule shot).
- : Capture a background image and a foreground image, and combine them to create a single image (composite photo).
- : Take ID photos (ID photos).

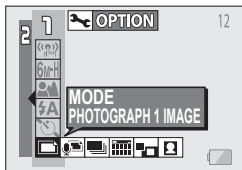

3 Select the desired icon, and press the SET button.

- The selected shutter operation is set.

Shooting sequential shots

When the shutter button is pressed, three still images are captured in succession.

- 1 Select the sequential shots icon  from the operation mode menu, and press the SET button.**

- If the resolution is set to **10M**, the setting changes automatically to **6M+H** and the images are captured.

- 2 Press the shutter button to start shooting.**

- Sequential shots shooting begins. Up to three still images can be captured, but if the shutter button is released during shooting, shooting stops immediately.

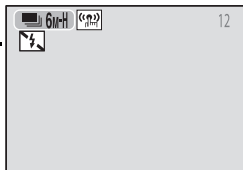

SHUTTER OPERATION SETTING

Making a schedule shot

You can enter a captured still image in the schedule.

1 Select the schedule photo icon  from the operation mode menu, and press the SET button.

2 Press the SET button again.
• The calendar appears on the LCD monitor.

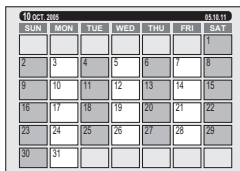

3 Toggle the SET button left, right, up and down to move the orange frame to the date you wish to save the image to.

4 Press the SET button.
• The Shooting Screen appears.

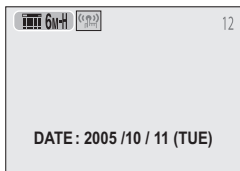

5 Compose the subject, and press the shutter button to snap the picture.
• The captured image is saved to the date you selected in step 3.

HINT

If the “SET DATE AND TIME” display appears...

- The date and time have not yet been set. Be sure to set the date and time before capturing images (page 23).

Composite

Shoot two images to create a composite still image.

1 Select the **Composite** operation mode menu, and press the **OK** button.

2 Press the **Left** button.
• The frame display appears.

3 Toggle the **Pattern** selection, select a **Pattern**, and press the **OK** button.
• The selected pattern is displayed.

4 Capture the image that will be superimposed in the background (frame).
• Point the lens at the subject, and snap the shutter.

5 Next, capture the image that will be superimposed in the frame.
• Take the photo of the image inside the frame.

em to create a composite still image.

operation mode menu, and press the **OK** button.

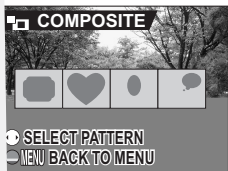

SHUTTER OPERATION SETTING

ID photos

You can create ID photos to use in circulars, ads, and other publications, as well as in identification documents.

1 Select the ID photo icon  from the operation mode menu, and press the SET button.

2 Press the MENU button twice.

- The ID photo outline appears on the LCD display.

3 Align the subject with the ID photo outline, and snap the picture.



- After the preview screen for the captured image appears, you are returned to the Shooting Setting Screen.
- Three images are shown in each of two sizes on the Playback Screen.



<Playback Screen>

CAUTION

Restrictions regarding sequential shots, composite photos, and ID photos

- The **[10M]** resolution setting is not available for sequential shots. In addition, the flash cannot be used.
- The **[10M]** resolution setting is not available for composite photos. In addition, the super macro  focus range is not available, and the self-timer cannot be used.
- The **[10M]** resolution setting is not available for ID photos. In addition, the super macro  and distant object  focus ranges are not available.

FOCUS AREA SETTING

You can choose from the following 2 types of autofocus (still image shooting only):

9-point range finder focus: The correct focus is determined from 9 different focus points within the shooting area visible on the LCD monitor. When the image is focused, a target mark  appears.

Spot focus: The camera focuses on the subject in the center of the LCD monitor.

1 Display the Shooting Setting Screen (page 53).

2 Select the focus mode menu.

- The focus mode menu appears.

: 9-point range finder focus is selected.

: Spot focus is selected.

- When the spot focus setting is selected, the focus mark + appears in the center of the LCD monitor.

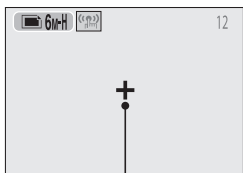

3 Select the desired icon, and press the SET button.

- The focus area is set.

LIGHT-MEASURING MODE SETTING

You can select from 3 types of light-measuring modes.

Multi-section light-measuring:

The exposure is adjusted after sampling from multiple areas of the entire shooting screen.

Center-weighted light-measuring:

The exposure is adjusted after light is measured from the entire image, but with emphasis on the center area.

Spot light-measuring:

You can compose the picture and capture the image after first measuring the light only at the center spot of the LCD monitor.

1 Display the Shooting Setting Screen (page 53).

2 Select the light-measuring mode (EXP MEASURE) menu.

- The light-measuring mode menu appears.

 : Multi-section light-measuring

 : Center light-measuring

 : Spot light-measuring

3 Select the desired icon, and press the SET button.

- This completes the light-measuring mode setting.
- When spot light-measuring is selected, the light-measuring spot mark  appears in the center of the LCD monitor.

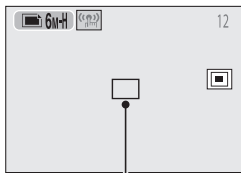

Spot mark

ISO SENSITIVITY

With the initial settings, the ISO sensitivity is automatically set according to the brightness of the subject. However, the ISO sensitivity can be set to a fixed setting.

1 Display PAGE 2 of the Shooting Setting Screen (page 53).

2 Select the ISO sensitivity menu.

- The ISO sensitivity menu appears.

ISO-A: Sets the ISO sensitivity automatically (equivalent to ISO50 to 200 [video clip recording mode: ISO450 to 1800]).

50: Sets the sensitivity to ISO50 equivalent (video clip recording mode: ISO450).

100: Sets the sensitivity to ISO100 equivalent (video clip recording mode: ISO900).

200: Sets the sensitivity to ISO200 equivalent (video clip recording mode: ISO1800).

400: Sets the sensitivity to ISO400 equivalent (video clip recording mode: ISO3600).

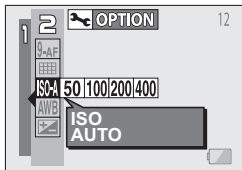

3 Select the desired icon, and press the SET button.

- This ISO sensitivity is set.

HINT

- By setting a higher ISO sensitivity, you can set higher shutter speeds and capture images in darker locations, but noise in the captured images may increase.

WHITE BALANCE





This camera automatically adjusts the white balance under most lighting conditions. However, if you want to specify the lighting conditions or change the overall tone of the image, the white balance can be manually set.

1 Display PAGE 2 of the Shooting Setting Screen (page 53).

2 Select the white balance menu.



- The white balance menu appears.

AWB: The camera will make the white balance adjustment automatically based on the natural and artificial light conditions. This is the setting used in the auto mode.

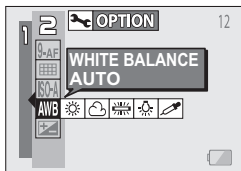





- : For shooting outside on a sunny day.
- : For shooting outside on a cloudy day.
- : For shooting inside under fluorescent lighting.
- : For shooting inside under incandescent lighting.
- : For more accurate adjustment or when the light source cannot be specified (one-push).



Setting procedure

- ① **Select the  icon and press the SET button.**
 - The  icon moves to the left end of the line.
- ② **Fill the entire screen with a plain white card (or piece of paper, etc.), and press the SET button.**

3 Select the desired icon, and press the SET button.

- This completes the white balance setting.
- Once the white balance setting is programmed for the  icon, it is retained even if another white balance setting (, , , , or ) is selected. If you changed to another setting, whenever you select the  icon and press the SET button, the previously programmed setting is recalled.

HINT

To cancel the white balance setting



- Perform step 1, select , and then press the SET button.

FLICKER-REDUCTION SETTING

The flicker-reduction setting reduces the flicker phenomenon that results when filming video clips under fluorescent lights and the like where the background lighting pulsates at the frequency of the power supply. The flicker-reduction setting is set for a frequency of 50 Hz.

- 1** Set the camera to the video clip recording mode, and display PAGE 2 of the Shooting Setting Screen (page 53).
-

- 2** Select the flicker-reduction menu.

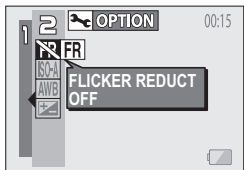

- The flicker-reduction menu appears.
- : Turns off the flicker-reduction setting.
- : Turns on the flicker-reduction setting.



- 3** Select the desired icon, and press the SET button.

- The flicker-reduction is set.
-

HINT

- Note that although the flicker-reduction setting decreases the image flicker that occurs under fluorescent lighting, the image quality may deteriorate slightly.
- If the flicker-reduction setting is used outdoors on a very bright day, a halation effect may occur.
- If the flicker-reduction is set to , then the ISO sensitivity setting becomes fixed at .

ADDING A VOICE MEMO

In the single-shot still image shooting mode, you can record approximately 10 seconds of sound (a voice memo) with the image. The voice memo is a mono recording.

1 Set the camera to the still image shooting mode (page 10), and select **1** of the Shooting Setting Screen (page 10).

2 Select the capture still image with voice memo icon  from the operation mode menu, and press the SET button.

3 Press the shutter button to capture the image, and then talk into the microphone.

- During recording, RECORDING appears in the upper right area of the LCD monitor.
- Take care not to cover the microphone with your fingers.
- A voice memo of up to about 10 seconds can be recorded.
- To end the recording before 10 seconds has elapsed, press the shutter button.

DISPLAYING THE PLAYBACK SETTING SCREENS

The Playback Setting Screens are used to adjust your camera's playback settings.

1 Press the playback button [▶].

- The display changes to the Playback Screen.

2 Press the MENU button.

- The Playback Setting Screen appears.

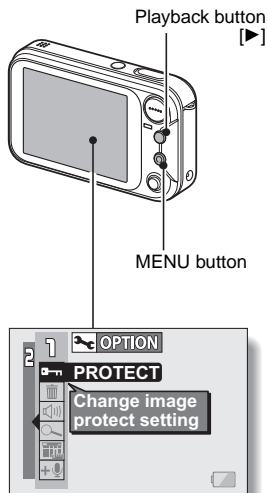

To cancel the Playback Setting Screen

When the MENU button is pressed, you are returned to the Playback Screen.

Switching the page

The Playback Setting Screen consists of two pages: **PAGE 1** and **PAGE 2**.

1 Display a Playback Setting Screen.

2 Toggle the SET button to the left.

- The Playback Setting Screen changes to the other PAGE.
- Each time the SET button is toggled to the left, the PAGE changes.

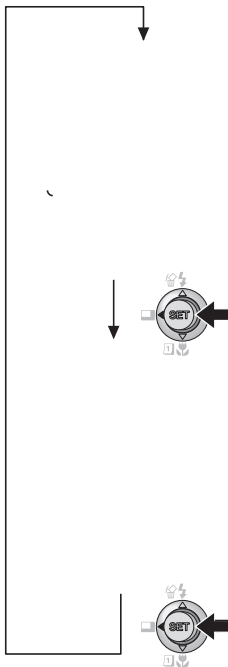

DISPLAYING THE PLAYBACK SETTING SCREENS

Overview of the Playback Setting Screens

PAGE 1

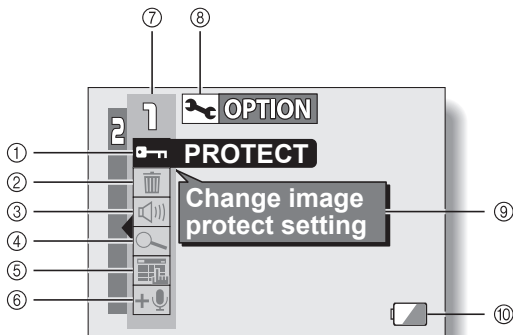

- ① **Protect (page 87)**
 - Protect data from accidental erasure (write protect).
- ② **Erase (page 89)**
 - Delete images from the card memory.
- ③ **Playback volume control (page 91)**
 - Adjust the playback volume for video clips and audio data.
- ④ **Zoom jump playback (page 92)**
 - Magnify the image for a better view of the details.
- ⑤ **Enter in schedule (page 94)**
- ⑥ **Add audio track (page 97)**
 - Add a voice memo to a captured still image.
- ⑦ **PAGE display (page 84)**
- ⑧ **Option icon (page 114)**
 - Display the Option Screen.
- ⑨ **Help display (page 121)**
- ⑩ **Remaining battery power (page 138)**

PAGE 2

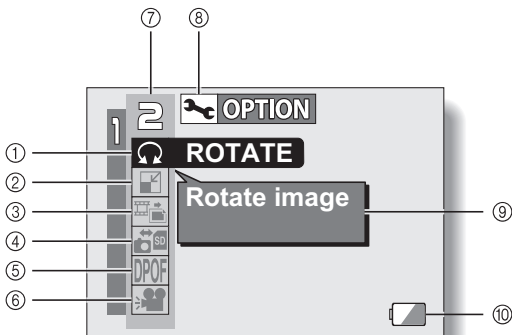

- ① **Rotate image (page 100)**
 - Rotate still images.
- ② **Resize (page 99)**
 - Reduce the resolution of a still image.
- ③ **Extract still image (page 101)**
 - Extract a still image from a video clip.
- ④ **Copy image (page 102)**
- ⑤ **Print settings (page 104)**
 - Specify the print settings.
- ⑥ **Slideshow (page 111)**
 - Play back the images in a slideshow format.
- ⑦ **PAGE display (page 84)**
- ⑧ **Option icon (page 114)**
 - Display the Option Screen.
- ⑨ **Help display (page 121)**
- ⑩ **Remaining battery power (page 138)**

IMAGE PROTECT

Prevent accidental erasure of image and audio data.

1 Display the data that you want to protect from accidental erasure, and display PAGE 1 of the Playback Setting Screen (page 83).

2 Select the protect icon , and press the SET button.

- “LOCK?” appears.
- If the protect mode has already been enabled for the data, then “UNLOCK?” appears.

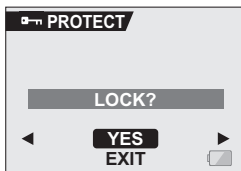

3 Toggle the SET button up or down to select “YES”, and press the SET button.

- The protect mode is set for the data.
- The protect mark  indicates that the data is locked.
- To return to the Playback Setting Screen, press the MENU button.

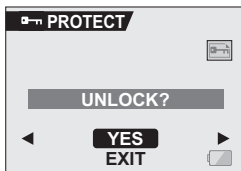

CAUTION

- Even if the protect mode is set for certain data files, they will be erased if the card is reformatted (page 133).

HINT**To select a different image in steps 2 and 3...**

- Toggle the SET button to the left or right.

To cancel the protect mode for an image...

- Display the desired data and repeat steps 1 to 3. The protect mark  will disappear and the protect mode is canceled.

ERASING DATA

You can erase data that is stored on the card if you no longer need it. You can erase the data one at a time, or all at once.

1 Display PAGE 1 of the Playback Setting Screen (page 83).

2 Select the erase icon , and press the SET button.

- The Erase Mode Screen appears.
ONE ERASE: Erases one data at a time.
ERASE ALL: Erases all the data. All images assigned to the schedule are also erased.
EXIT: Returns to the Playback Setting Screen.

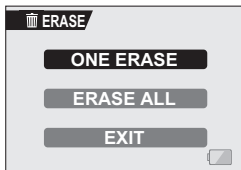

3 Toggle the SET button up or down the select the erase mode, and press the SET button.

- The Erase Confirmation Screen appears.
<**ONE ERASE**>
 - Toggle the SET button to the left or right to select the data you wish to erase.
- <**ERASE ALL**>
 - Toggle the SET button to the left or right confirm that all data is to be erased.

4 Toggle the SET button up to select “YES”, and press the SET button. <ONE ERASE>

- The currently displayed image is deleted.
- To erase other data, select the data, and press the SET button.

<ERASE ALL>

- The Erase Confirmation Screen again appears. To erase the data, select “YES”, and press the SET button. When data erase is completed, “NO IMAGE” is shown.

CAUTION

About protected images

- Data which is protected from accidental erase cannot be erased. To erase protected data, set the protect setting for the data to off (page 87), and then follow the data erase procedure.

The schedule shot is also erased.

- If captured still images were entered in the schedule, the images will also be deleted from the schedule when the image data is erased. Please take note of this especially when choosing the “ERASE ALL” mode.
- You can also access the One Erase Confirmation Screen from the Playback Screen by toggling the SET button up.

PLAYBACK VOLUME

Adjust the playback volume for video clips and audio data.

1 Display PAGE 1 of the Playback Setting Screen (page 83).

2 Select the playback volume icon , and press the SET button.

- The volume control bar appears.
-

3 Toggle the SET button left or right to adjust the volume, and press the SET button.

- The playback volume is set, and you are returned to the Playback Setting Screen.

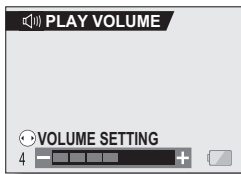

ZOOM JUMP PLAYBACK

You can magnify a portion of a still image to check the accuracy of the focus.

1 Display a still image in view using zoom jump.

2 Press the **[T]** button.

- The image is magnified.
- If the magnified view appears to be in focus, press the overall image magnification focus.

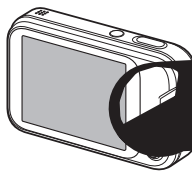

3 Toggle the **[T]** button up, down, left, or right to move to the part you want to magnify, and press **[T]** (the zoom switch).

The magnified area is further magnified.

To magnify further: Magnification increases with each press of **[T]** (the zoom switch).

To return to normal view: Press **[T]** on the zoom switch.

Back: Magnification

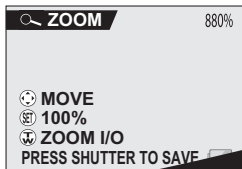

Zoom jump playback can also be accessed from the Playback Setting screen.

DISPLAYING THE SCHEDULE

Photos that were captured as schedule shots can be viewed in a calendar-format schedule.

Previously captured images can also be entered in the schedule, and images can be removed from the schedule as desired (page 94).

1 Make a schedule shot (page 73).

2 Display a still image (page 35), and toggle the SET button down.

- The calendar appears.
- You can press the MENU button to return to the Playback Screen.



3 Toggle the SET button up, down, left and right to select the desired date, and press the SET button.

- The image that was entered for the selected date is displayed full-screen.
- Toggle the SET button to the left or right to display the previous or next image that was entered in the schedule.
- Toggle the SET button down to display the schedule.
- When the MENU button is pressed, the Save To Calendar Screen (page 94) appears.

CAUTION

If the schedule does not appear...

- The calendar will not appear in step 1 if no image has been entered in the schedule. Follow the procedure to make a schedule shot (page 73), or enter an image in the schedule (page 94), and then display the calendar.

ENTER AN IMAGE IN THE SCHEDULE

You can enter a previously captured still image in the schedule, as well as remove images from the schedule.

Display the Save To Calendar Screen

- 1** Display the image you wish to enter in the schedule, and access **PAGE 1** of the Playback Setting Screen (page 83).

- 2** Select the save to calendar icon , and press the **SET** button.
 - The Save To Calendar Screen appears.



SPECIFY DATE:

Specify the date and enter the image in the schedule.

DELETE FROM CALENDAR:

Remove an image from the schedule (if one has already been entered).

EXIT: Return to the Playback Setting Screen.

ENTER AN IMAGE IN THE SCHEDULE

Entering an image in the schedule

1 Display the image you wish to enter, and display the Save To Calendar Screen (page 94).

2 Select "SPECIFY DATE", and press the SET button.

- The screen to specify the date appears.

3 Specify the date in which you wish to enter the image.
<To assign the image to the day indicated by "DATE">

- ① Select "SAVE TO CALENDAR".
- ② Press the SET button.

<To specify the date and save to the calendar>

- ① Select "DATE", and press the SET button.
 - The screen to set the date appears.
- ② Toggle the SET button up or down to set the year.
 - Toggle the SET button to the right, and set the month and day in the same manner.
- ③ Press the SET button.
- ④ Select "SAVE TO CALENDAR", and press the SET button.
 - The image is entered in the schedule.



Entry date



4 Select "EXIT" and press the SET button.

- The image is entered in the schedule.

Removing an image from the schedule

1 Display the schedule image you wish to remove, and display the Save To Calendar Screen (page 94).

2 Select “DELETE FROM CALENDAR”, and press the SET button.

- The Confirm Delete screen appears.

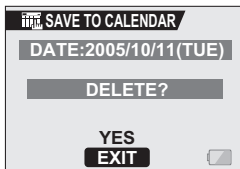

3 Select “YES”, and press the SET button.

4 Select “EXIT” and press the SET button.

- The image is removed from the schedule.

ADDING/DELETING A VOICE MEMO

You can add a voice memo to a still image previously recorded.
You can also erase the voice memo only from an image.

-
- 1** Display the still image to which you want to add a voice memo.
- If the image already has a voice memo recorded, the voice memo icon  appears.

-
- 2** Display PAGE 1 of the Playback Setting Screen (page 83).

-
- 3** Select the add audio icon , and press the SET button.

- The Add Audio Screen appears.

RECORD:

Record a new voice memo.

ERASE AUDIO:

Erase the voice memo from the image (if one is recorded).

EXIT: Return to the Playback Setting Screen.



4 Select the desired option, and press the SET button.

<If RECORD was selected>

- Voice memo recording starts when the shutter button is pressed and released. Talk into the microphone on the digital camera.
- A voice memo of up to about 10 seconds can be recorded.
- To end the recording before 10 seconds has elapsed, press the shutter button.
- While the voice memo is being recorded, the RECORDING screen is displayed.

<If ERASE AUDIO was selected>

- The Confirm Erase Screen appears.
- Select "YES", and press the SET button.



Recording time indication



HINT

- For still images, you can also add a voice memo immediately after capturing an image (page 82).
- Note that if you erase the image, the accompanying voice memo will also be erased.
- If a voice memo is added to an image that already has a voice memo, the new recording will replace the previous one.

CHANGING IMAGE SIZE (RESIZE)

The size of a still image that has already been captured at a resolution of **2M** or more can be changed to 1,600 × 1,200 pixels or 640 × 480 pixels. The resized image is saved as a separate image.

1 Display the still image whose size you want to change.

2 Display **PAGE 2** of the Playback Setting Screen (page 83).

3 Select the resize icon , and press the **SET** button.

- The Resize Screen appears.



4 Toggle the **SET** button up or down to select the new image size.

2M (1600 × 1200): The saved image will be 1,600 × 1,200 pixels.

0.3M (640 × 480): The saved image will be 640 × 480 pixels.

EXIT: Return to the Playback Setting Screen.

5 Press the **SET** button.

- Resizing begins.

HINT

Why can't the image be resized?

- Images smaller than 640 × 480 pixels cannot be resized to 0.3M (640 × 480 pixels). Likewise, images smaller than 1,600 × 1,200 pixels cannot be resized to 2M (1,600 × 1,200 pixels).

ROTATE IMAGE

Captured still images can be rotated to the correct orientation for viewing.

1 Display **PAGE 2** of the **Playback Setting Screen** (page 83).

2 Select the rotate icon , and press the **SET** button.

- The Rotate Image Screen appears.

RIGHT: Rotates image clockwise 90 degrees.

LEFT: Rotates image counterclockwise 90 degrees.

EXIT: Return to the Playback Setting Screen.

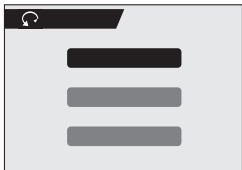

3 Select **“RIGHT”** or **“LEFT”**, and press the **SET** button.

- Each time the SET button is pressed, the image is rotated another 90 degrees.

HINT

- On the 9-image/36-image display playback, rotated images are shown in their original orientation.

EXTRACTING A STILL IMAGE FROM A VIDEO CLIP

You can select one image (scene) from a video clip, copy it, and save it as a still image (the original data remains unchanged).

1 Play back a video clip, and pause at the point you wish to copy and save.

2 Display PAGE 2 of the Playback Setting Screen (page 83).

3 Select the extract still icon , and press the SET button.

- The screen to extract an image appears.

YES: The image is copied and saved as a still image (the original data is left unchanged).

EXIT: You are returned to the Playback Setting Screen.



4 Select “YES” and press the SET button.

- The image is extracted.

HINT

To select a different image (frame) in step 3...

- Toggle the SET button to the left or right.

COPY DATA

Images recorded in the camera's internal memory can be copied to the card, and likewise from the card to the internal memory.

- 1** Insert the card in the camera (page 16).
 - 2** Display PAGE 2 of the Playback Setting Screen (page 83).
-

- 3** Select the copy image icon , and press the SET button.
 - The Copy Image Screen appears.
-

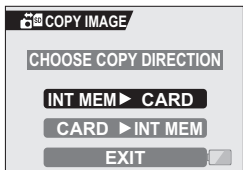

- 4** Toggle the SET button up or down to select the copy direction.

INT MEM ► CARD:

Copy image data from the internal memory to the card.

CARD ► INT MEM:

Copy image data from the card to the internal memory.

*** If no card is set in the camera, you cannot copy data.**

COPY DATA

5 Press the SET button.

- The screen to select the type of copy appears.
- The copy source is shown in the background on the screen.

COPY SINGLE:

Copy the data for one image.

COPY ALL:

Copy all the data from the copy source to the copy destination.

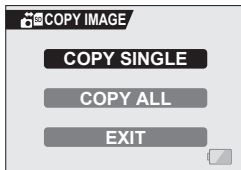

6 Select the desired type of copy.

<When selecting COPY SINGLE>

- ① Toggle the SET button to the left or right to display the image you wish to copy.
- ② Toggle the SET button up or down to select "COPY SINGLE".

<When selecting COPY ALL>

- ③ Toggle the SET button up or down to select "COPY ALL".

7 Press the SET button.

- The Copy Confirmation Screen appears.
- To continue the copy procedure, select "YES" and press the SET button.
- To discontinue the copy procedure and return to the screen in step 5, select "EXIT" and press the SET button, or press the MENU button.

PRINT SETTINGS

In addition to using your printer to print out still images captured with your camera, as with conventional film, you can have prints made at shops offering digital print services. Moreover, this camera is DPOF-compatible, so you can use the camera to specify the number of prints, whether or not the date is displayed on the print, and also to specify an index print.

Display the Print Settings Screen

1 Display **PAGE 2** of the Playback Setting Screen (page 83).

2 Select the print settings icon , and press the **SET** button.

- The Print Setting Screen appears.

ALL IMAGES:

The specified print settings apply to all the still images on the card.

EACH IMAGE:

The print settings are specified for each individual image.

INDEX:

All the still images are printed as miniature images (thumbnail images), several images on one print.

ALL CLEAR:

Clear all the print settings. This cannot be selected if no print settings have been made for the image.

EXIT:

Return to the Still Image Playback Setting Screen.

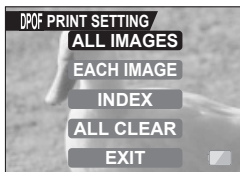

PRINT SETTINGS

HINT

Printing a single frame from a video clip

- To print with a printer or have the digital print service shop print out a still image from a video clip, you must first save it (save frame (page 101)) as a still image.

About the DPOF format

- DPOF (Digital Print Order Format) is a print order format. You can connect your camera to a DPOF-compatible printer to produce your prints. You can also set the print settings (page 147) for the desired images, and then have the reserved images printed automatically.

About the finished prints

- Images that have been rotated will be printed in their original orientation.
- The quality of the print output will differ depending on the print service and printer used.

Specifying date imprinting and number of prints

You can specify print settings for each individual image (**EACH IMAGE**), or apply the print settings to all the images on the card (**ALL IMAGES**).

1 Display the Print Setting Screen (page 104).

2 Select **ALL IMAGES** or **EACH IMAGE**.

ALL IMAGES:

The set print settings are applied to all the still images on the card.

EACH IMAGE:

The set print settings are applied only to the image currently displayed.



3 Press the **SET** button.

- The Date/Copies Print Screen appears.
- If "EACH IMAGE" was selected, toggle the SET button to the left or right to display the desired image to print.
- Under "SETTINGS" the settings that are currently active for the displayed image are shown. You can toggle the SET button to the left or right to confirm the print settings for each image.

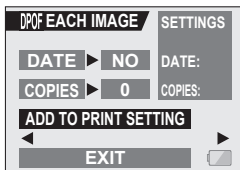

5 Select “ADD TO PRINT SETTING” and press the SET button.

- The Confirm Print Settings Screen appears.

If the print settings are correct:

Select “EXIT”, and press the SET button.

If the print settings were changed:

Select “MODIFY PRINT SETTING”, and press the SET button.

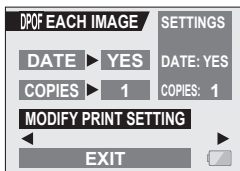

Index print

Printing out many small images on one sheet is called an “index print”. This is convenient for use as a list of the images you have captured.

1 Display the Print Setting Screen (page 104).

2 Select “INDEX”.



PRINT SETTINGS

3 Press the SET button.

- The Index Print Screen appears.

YES:

Specify an index print copy.

EXIT:

Discontinue the setting procedure, and return to the Print Setting Screen.



4 Select "YES", and press the SET button.

- This completes the setting for the index print. You are returned to the Print Setting Screen.

Changing the print settings

1 Follow steps 1 to 4 on pages 106 and 107.

2 Select "MODIFY PRINT SETTING", and press the SET button.

CI

Dele

1

2

SLIDESHOW PLAYBACK

1 Display PAGE 2 of the Playback Setting Screen (page 83).

2 Select the slideshow icon , and press the SET button.

- The Slideshow Screen appears.

TIME: Adjust the transition speed (the period that an image is displayed before it changes to the next image).

EFFECT: Select a transition effect as an image changes to the next image.

START: Begin slideshow playback.

EXIT: Return to the Playback Setting Screen.

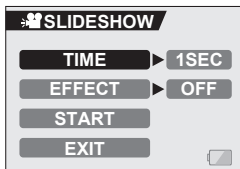

<Changing the transition speed or transition effect>

- ① Select "TIME" or "EFFECT", press the SET button.
- ② Toggle the SET button up or down to select the feature you wish to change.
- ③ Press the SET button.

3 Select “START”, and press the SET button.

- Slideshow playback starts.
- To stop slideshow playback, press the SET button or MENU button.

CAUTION

- Voice memos are not played back during slideshow playback.

DISPLAYING IMAGE PROPERTIES (INFORMATION SCREEN)

On the Information Screen you can check what the settings were when an image was captured.

1 Display the desired image.

2 Press and hold the MENU button for at least 2 seconds.

- The Information Screen appears.
- If the MENU button is pressed again, the Information Screen is canceled.

- ① Resolution setting
- ② Resolution
- ③ Scene select function setting
- ④ Filter function setting
- ⑤ Image number
- ⑥ Protect setting
- ⑦ File size
- ⑧ Aperture value
- ⑨ Shutter speed
- ⑩ Exposure correction setting
- ⑪ Remaining card memory
- ⑫ Date and time of image
- ⑬ Video clip mode settings
- ⑭ Resolution and frame rate
- ⑮ File format
- ⑯ Playback time

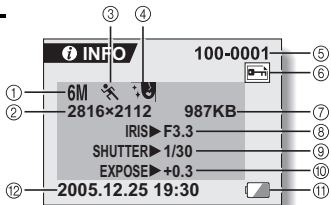

<Still image playback>

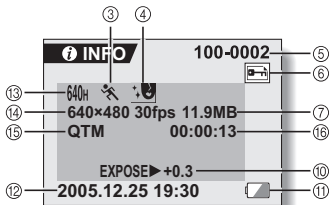

<Video clip playback>

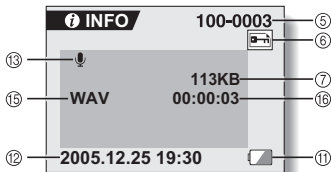

<Audio data playback>

DISPLAYING THE OPTION SCREEN

The Option Screen is used to adjust various camera settings.

1 Display the Shooting Setting Screen or Playback Setting screen.

- Shooting Setting Screen, see (page 53)
- Playback Setting Screen, see (page 83)

2 Toggle the SET button up or down to select the PAGE indication.

3 Toggle the SET button to the right.

- The Option Screen appears.
- If the SET button is toggled down, the Option Screen menu appears.

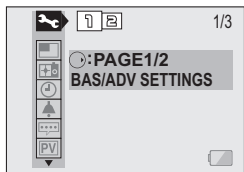
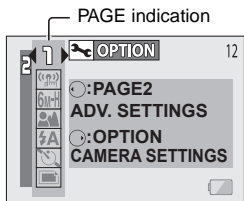

To exit the Option Screen

To return to the Shooting Screen or Playback Screen

→ Press the MENU button.

To return to the Shooting Setting Screen or the Playback Setting Screen

→ Highlight the PAGE indication, and toggle the SET button to the right.

DISPLAYING THE OPTION SCREEN

Overview of the Option Screen

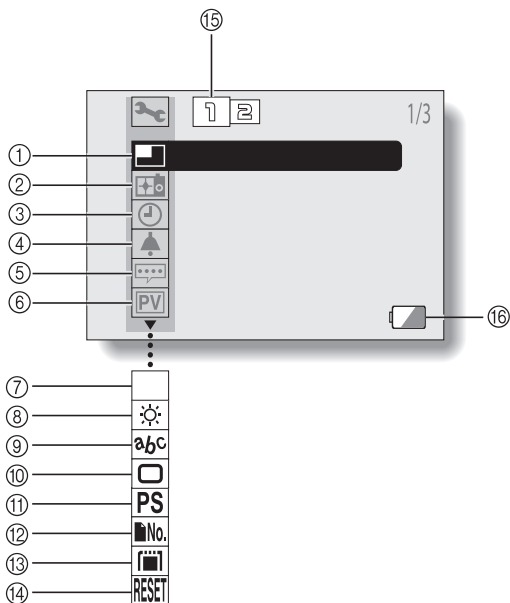

- ① **2WAY shooting guide (page 117)**
 - Enable or disable the 2WAY Shooting Guide.
- ② **Startup display (page 118)**
 - Select the display that appears when the camera is turned on.
- ③ **Date and time setting (page 23)**
 - Set the camera's internal clock.
- ④ **Operation sounds setting (page 119)**
 - Adjust the operation sounds produced when the camera's buttons are pressed and turn the audio guide on or off.
- ⑤ **Help display setting (page 121)**
 - Turn the help display on or off.
- ⑥ **Post-view (page 122)**
 - Specify how long a still image is displayed on the LCD monitor after it is captured.
- ⑦ **Zoom setting (page 123)**
 - Set the digital zoom and optical zoom to ON or OFF.
- ⑧ **Monitor brightness (page 125)**
 - Adjust the brightness of the LCD monitor.
- ⑨ **Screen language (page 126)**
 - Select the language in which the LCD monitor messages are displayed.
- ⑩ **TV system setting (page 127)**
 - Select the type of TV signal that is output from the camera's USB/AV terminal.
- ⑪ **Power save function (page 128)**
 - Specify the time elapsed before the power save mode is activated.
- ⑫ **File number reset (page 130)**
 - Set the file number reset function to ON or OFF.
- ⑬ **Card format (page 133)**
 - Reformat the camera's internal memory or the card installed in the camera.
- ⑭ **Reset camera settings (page 135)**
 - Reset the camera to the factory-preset settings.
- ⑮ **PAGE display (pages 54, 84 and 114)**
- ⑯ **Remaining battery power (page 138)**

- Icons ⑦ through ⑭ are displayed when you toggle the SET button up or down to scroll.

SET THE 2WAY SHOOTING GUIDE SETTING

Specify whether, during shooting, the 2WAY Shooting Guide is activated.

1 Display the Option Screen (page 114).

2 Select the 2WAY shooting guide icon , and press the SET button.

- The 2WAY Shooting Guide Screen appears.

ON: The 2WAY Shooting Guide is enabled.

OFF: The 2WAY Shooting Guide is disabled.

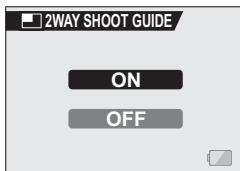

3 Select the desired setting, and press the SET button.

- The selected 2WAY Shooting Guide setting is set.
-

HINT

If the 2WAY Shooting Guide does not appear...

- The 2WAY Shooting Guide does not appear when you are making a schedule shot.

SELECT THE STARTUP DISPLAY

The startup display is the display that appears on the LCD monitor when the camera is turned on.

1 Display the Option Screen (page 114).

2 Select the startup display icon , and press the SET button.

- The Startup Display Setting Screen appears.

Xacti:

The Xacti display is shown.

SCHEDULE:

The image that was entered for today's date, or the first image for the next date to which an image was entered, is shown (page 94).

OFF:

No startup display.

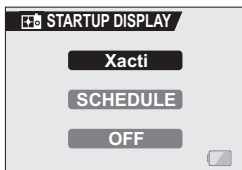

3 Select the desired setting, and press the SET button.

- The selected startup display is set.

OPERATION SOUNDS

This setting allows you to set whether or not a confirming audio signal sounds when the operation buttons (shutter button, SET button, MENU button, etc.) are pressed, and to adjust the audio signal volume.

1 Display the Option Screen (page 114).

2 Select the operation beep icon , and press the SET button.

- The Operation Beep Setting Screen appears.
- The current settings are shown on the screen.
- If "ALL OFF" is selected and the SET button pressed, all the operation sounds are muted.
- If "EXIT" is selected and the SET button pressed, you are returned to the Option Screen.

TURN ON/OFF:

Mute or enable the sound that is produced when the power is turned on or off.

SHUTTER:

Select the sound that is produced when the still image shooting button is pressed, or when a photo is taken using the self-timer.

KEY SW:

Select the sound that is produced when a camera button (SET button, MENU button, etc.) is pressed.

AUDIO GUIDE:

Mute or enable the camera's audio help guide.

CHANGE SETTINGS:

Change the settings of the operation sounds.

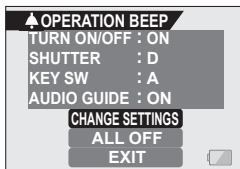

3 Select “CHANGE SETTINGS”, and press the SET button.

- The screen to change the settings appears.

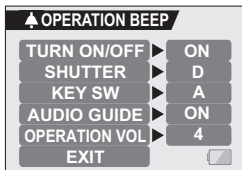

4 Toggle the SET button up or down to select the desired setting, and press the SET button.

- The screen to select operation sounds appears.

<If “TURN ON/OFF” or “AUDIO GUIDE” is selected>

- The respective screen to enable or disable the sound appears.
- Toggle the SET button up or down to select the desired setting, and press the SET button.

ON:

Activates the sound.

OFF:

Deactivates the sound.

<If “SHUTTER” or “KEY SW” is selected>

- The screen to select the operation sounds appears.
- Select from 8 different sounds (A to H).
- You can press the shutter button to preview the selected operation sound.
- If “OFF” is selected, no sound is produced.
- Toggle the SET button up or down to select the desired setting, and press the SET button.

<If OPERATION VOL was selected>

- The screen to select the volume for the operation sounds appears.
- You can select an operation sound volume from 1 (minimum) to 7 (maximum).
- Toggle the SET button up or down to select the volume, and press the SET button.

5 Select “EXIT”, and press the SET button.

- The operation sound settings are completed.

HELP DISPLAY

You can set whether or not the help messages are shown on the LCD monitor.

1 Display the Option Screen (page 114).

2 Select the help display icon and press the SET button.

- The Help Setting Screen appears.

ON:

The HELP messages are enabled.

OFF:

The HELP messages are disabled.



3 Select the desired setting, and press the SET button.

- This completes the help display setting.

POST-VIEW SETTING

Specify the duration that the captured image appears on the LCD monitor (post-view) after the shutter button is pressed.

1 Display the Option Screen (page 114).

2 Select the post-view icon , and press the SET button.

- The Post-view Screen appears.

1 SEC:

The post-view image is displayed for 1 second.

2 SEC :

The post-view image is displayed for 2 seconds.

OFF:

The post-view image is not displayed.

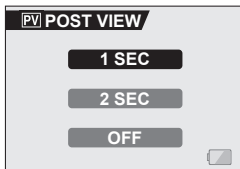

3 Select the desired setting, and press the SET button.

- This completes the post-view setting.

ZOOM SETTINGS

Set the optical zoom and digital zoom settings to ON or OFF. If you find the noise from the zoom movement during video clip recording too distracting, you may wish disable the optical zoom (OFF). Also, if the deterioration of image quality characteristic of the digital zoom function is not to your liking, you may choose to disable the digital zoom (OFF) and shoot using only the optical zoom.

1 Display the Option Screen (page 114).

2 Select the zoom setting icon , and press the SET button.

- The Zoom Setting Screen appears.

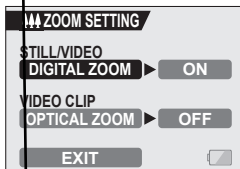

<STILL/VIDEO>

DIGITAL ZOOM

▶ON: Digital zoom is enabled.

▶OFF: Digital zoom is disabled.

<VIDEO CLIP>

OPTICAL ZOOM

▶ON: During video clip recording, the optical zoom is enabled.

▶OFF: During video clip recording, the optical zoom is disabled.

EXIT:

Return to the Option Screen.

3 Select the desired function, and



4 Toggle the SET button up or down to select a setting.

5 Press the SET button.

- The selected zoom setting is set.

HINT

- Even when the optical zoom setting is set to OFF, the zoom can be still operated whenever the camera is not recording. This means that you can use the zoom switch to compose the picture before actually beginning recording.
- The digital zoom does not function in the following situation:
When the resolution is set to 10M.

LCD MONITOR BRIGHTNESS

Adjust the brightness of the camera's LCD monitor display. Use this adjustment when the monitor image is difficult to view because of ambient lighting.

In addition, in very bright surroundings, such as outdoors on a sunny day, you can turn the backlight OFF to preserve battery power.

1 Display the Option Screen (page 114).

2 Select the LCD brightness icon , and press the SET button.

- The brightness control display appears.

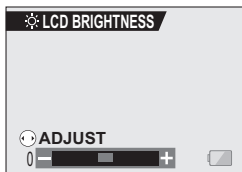

3 Toggle the SET button to the left or right to set the brightness, and press the SET button.

- The LCD monitor brightness is set.
-

HINT

- The display in step 2 can also be accessed from the Shooting Screen. Press and hold the MENU button for at least 1 second; the brightness control display will appear, and you can then adjust the monitor brightness.

SCREEN LANGUAGE

You can set the LCD monitor of your camera to display the messages in any one of several languages.

1 Display the Option Screen (page 114).

2 Select the language icon , and press the SET button.

- The Language Screen appears.

DEUTSCH:	German
ENGLISH:	English
ESPAÑOL:	Spanish
FRANCAIS:	French
ITALIANO:	Italian
NEDERLANDS:	Dutch
РУССКИЙ:	Russian
日本語:	Japanese
한국어:	Korean
中文(繁):	Chinese (traditional)
中文(简):	Chinese (simplified)

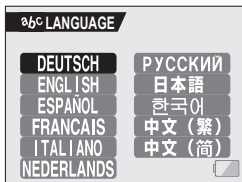

3 Select the desired language, and press the SET button.

- The selected display language is set.

TV SYSTEM SETTING

Specify the type of image signal that is output from your camera's USB/AV terminal.

1 Display the Option Screen (page 114).

2 Select the TV system icon , and press the SET button.

- The TV System Screen appears.

NTSC:

Outputs NTSC video signals.

PAL:

Outputs PAL video signals.

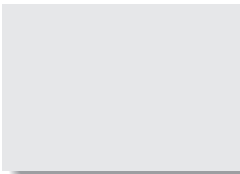

3 Select the desired setting, and press the SET button.

- The selected TV system is set.
-

HINT

If no image appears on the TV...

- If the TV system setting is not correct for the connected equipment, no image will appear on the TV.

POWER SAVE FUNCTION

Your camera has a "power save" function whereby the power automatically turns off after a specified period of inactivity. The power save function works to conserve the battery pack power when the camera is not being used, or to prevent the battery pack from dying if the camera has accidentally been left on. You can specify the elapsed time (standby time) before the power save function is activated.

1 Display the Option Screen (page 114).

2 Select the power save icon [PS], and press the SET button.

- The Power Save Setting Screen appears.

BATT/CAM:

Set the standby time for the shooting modes when the battery pack is used.

BATT/PB:

Set the standby time for the playback modes when the battery pack is used.

EXT.PWR/CAM.PB:

Set the standby time for the shooting and playback modes when using an AC power source.

EXIT:

Return to the Option Screen.

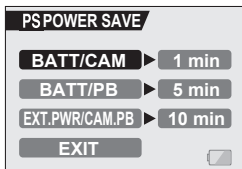

POWER SAVE FUNCTION

3 Select the desired option, and press the SET button.

- The Set Standby Time Screen appears.

4 Toggle the SET button up or down to set the standby time.

Up:

Increases the standby time.

Down:

Decreases the standby time.

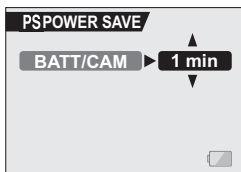

<Example: When "BATT/
CAM" is selected>

5 Press the SET button.

- The power save function is set.

FILE No. RESET FUNCTION

If a newly formatted (page 133) card is used, the file name (image number) of the captured image automatically begins from 0001. If the card is subsequently reformatted, or if a different reformatted card is used, the file names again begin from 0001. This is because the file number reset function is set to "ON", and consequently it results in more than one card containing images with the same numbers. By setting the file number reset function to "OFF", even if the card is reformatted or the card is replaced with another card, the consecutive numbering of file names continues from the last number recorded by the camera.

<File number reset function "ON">

	File name (image number)
Card A	0001, 0002..... 0012, 0013

⋮
Replace card

▼

Card B	0001, 0002..... 0012, 0013
--------	----------------------------

<File number reset function "OFF">

	File name (image number)
Card A	0001, 0002..... 0012, 0013

⋮
Replace card

▼

Card B	0014, 0015.....0025, 0026
--------	---------------------------

FILE No. RESET FUNCTION

- If Card B already has image data in it when it replaces Card A, file names are assigned as follows.

When the highest image number on Card B (before replacing) is lower than the highest image number on Card A: the file name of the next recorded image continues from last file name recorded on Card A.



When the highest image number on Card B (before replacing) is higher than the highest image number on Card A: the file name of the next recorded image continues from last file name recorded on Card B.



HINT

What about the internal memory?

- The file number reset function works the same for the internal memory.

1 Display the Option Screen (page 114).

2 Select the file number reset icon .

3 Press the SET button.

- The File Number Reset Screen appears.
ON:
The file number reset function is "ON".
OFF:
The file number reset function is "OFF".



4 Select "OFF", and press the SET button.

- The file number reset function was set to OFF.

HINT

- Until the file number reset function is turned "ON", consecutive file names are assigned. It is recommended that the file number reset function be returned to "ON" at the end of each photography session.

INITIALIZING THE CARD MEMORY AND INTERNAL MEMORY

The supplied card must be formatted with this camera. In addition, a card must be formatted with this camera:

- After purchasing, when used for the first time, or
 - If it was formatted using a personal computer or another digital camera.
- The card cannot be reformatted if the lock switch is set to the "LOCK" position. Proceed with the reformat procedure after setting the lock switch to the unlocked position.
-

1 To reformat a card, install it in the camera. To reformat the camera's internal memory, remove the card from the camera.

2 Display the Option Screen (page 114).

- 3** Select the format icon , and press the SET button.
- The screen to select the type of format appears.
 - In normal use, a full format is not necessary. However, in case a card error occurs even after normal formatting, executing a full format may resolve the problem.

FORMAT:

A normal formatting is executed.

FULL FORMAT:

The entire card is scanned and reformatted. It is not possible to select this when there is no card installed, or when the remaining battery charge is low.

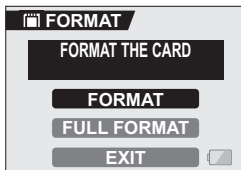

<With card installed>

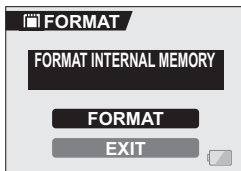

<No card installed>

4 Select the desired format option, and press the SET button.

- The Confirm Format Screen appears.

5 Select “YES”.

6 Press the SET button.

- Formatting begins.
- During formatting, “FORMATTING” and “DO NOT POWER OFF” are shown on the LCD monitor.

CAUTION

Caution during reformatting

- Please do not turn off the camera or insert/remove the card while the card is being formatted.

Reformatting erases the data

- When the card or internal memory is initialized, all the recorded data is erased. Protected data is also erased, so before reformatting a card, any data you want to keep should be copied to your personal computer’s hard disk or other storage medium.

Can data be restored after a card is formatted?

- It may be possible to restore data from a reformatted card by using application software designed to restore data. However, even such application software cannot restore data after a full format has been executed. It is recommended that a full format be executed before you dispose of a card or transfer it to someone else.

HINT

To cancel reformatting

- In step 5, select “NO”, and press the SET button.

RESETTING THE CAMERA SETTINGS

Reset the camera to the factory-preset settings.

1 Display the Option Screen (page 114).

2 Select the reset settings icon , and press the SET button.

- The Reset Settings Screen appears.

YES:

Reset to the factory-preset settings.

NO:

Do not change the settings, and return to the Option Screen.

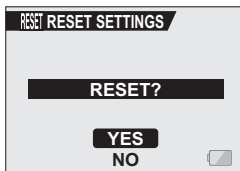

3 Select "YES", and press the SET button.

- The camera settings are reset to the factory-preset settings.
-

HINT

- Note that the following settings do not change with this procedure:
 - Date and time setting**
 - Language setting**
 - TV system setting**

CHECKING THE REMAINING INTERNAL MEMORY AND CARD MEMORY

You can check how many images can be captured and how much recording time is available on the card. For a table showing the maximum number of images and recording time for the internal memory and for a specific card, please see "Possible No. of Images/Possible Shooting Time/Possible Recording Time" on page 170.

Checking the remaining number of images and video recording time

1 Press the ON/OFF button to turn the camera on, and press the MENU button.

- Display the Shooting Screen.

<To check the remaining number of still images>

Select PHOTO, and press the MENU button.

<To check the remaining video clip recording time>

Select MOVIE, and press the MENU button.

- The remaining number of still images or video clip recording time is shown on the LCD monitor.
- The remaining number of images and video recording time will differ depending on the resolution setting.

Remaining number of images

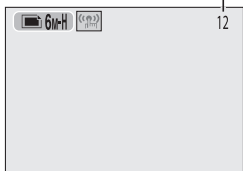

<Still Image Shooting Screen>

Remaining recording time

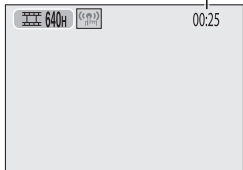

<Video Clip Recording Screen>

CHECKING THE REMAINING INTERNAL MEMORY AND CARD MEMORY

For audio data

- 1** Set the camera to the audio recording mode (page 65).
- The remaining audio recording time is shown.

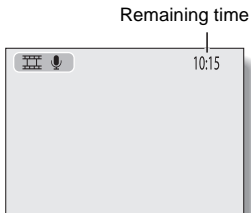

HINT

- When the remaining number of images or the remaining video recording time is "0", you cannot capture any more images. To capture more images, either install a new card, or save the images to a computer and then erase them (page 89) from the card.
- When the remaining number of images or the remaining video recording time is "0", it may be possible to capture a few more images by setting a lower resolution setting (page 64).

CHECKING THE REMAINING BATTERY PACK CHARGE



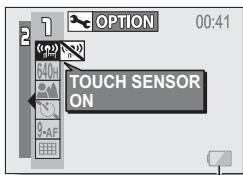

When using the battery pack, the remaining battery pack charge can be checked on the LCD monitor. Make sure to check this indicator before capturing an image. For an indication of the possible length of time for battery pack operation, see page 169.

1 Display a Shooting or Playback Setting Screen (pages 53 and 83).

- The battery pack remaining charge indicator appears in the lower right corner of the LCD monitor.
- Due to the battery pack characteristics, when the ambient temperature is low,  may appear early for an incorrect indication of the remaining charge. Also, depending on the conditions of use of the camera or the ambient conditions (temperature, etc.), the indicated remaining charge may change. Therefore, this indication can only be used as a general approximation of the remaining charge.



Battery pack remaining charge indicator

Battery pack remaining charge indicator	Battery remaining charge
	Approx. full.
	Power is low.
	It will soon be impossible to capture or play back images.
	If this icon flashes when the shutter button is pressed, images cannot be captured. Recharge the battery pack.

CHECKING THE REMAINING BATTERY PACK CHARGE

HINT

- If any data is present, you can also check the remaining battery pack charge on the Playback Setting Screen or Information Screen.
- Battery life may differ even among battery packs of the same type.
- Depending on the usage of the camera (such as the number of times the flash is used, the use of the LCD monitor, etc.) or the ambient temperature (temperatures below 10°C [50°F]) the number of images that can be saved on a fully charged battery pack will vary greatly.
- It is recommended that you prepare an extra battery pack(s) when taking pictures at a wedding or while traveling, for example, so you don't miss capturing images of important moments due to the battery pack power running out. The same is recommended for taking photos in cold environments. (In a ski area, for example, the battery pack can be kept warm in your pocket until ready to use.)

CONNECTING TO A TV

Connect the supplied AV interface cable from the USB/AV terminal on the digital camera to the AUDIO and VIDEO input terminals on the TV.

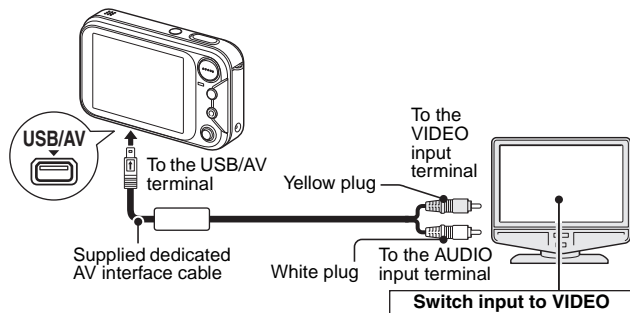

Playback

- After connecting the digital camera to the television, set the TV input switch to VIDEO input.
- When an AV interface cable is connected, no image appears on the camera's LCD monitor.
- The playback method is the same as when viewing images on the camera's LCD monitor.
- The same playback procedure as when playing back with the camera is used to play back voice memos and audio recordings as well.

Voice memo playback: see page 35

Audio playback: see page 66

CAUTION

Insert and pull out the cable carefully

- Do not use excessive force when connecting and disconnecting cables.

DIRECT PRINTING

Your camera supports the PictBridge function. By connecting the camera directly to a PictBridge-enabled printer, the camera's LCD monitor can be used to select images and initiate printing (PictBridge printing).

Print preparations

1 Insert the card containing the images you wish to print in the camera.

2 Turn the printer on, and use the supplied USB interface cable to connect the camera to the printer.

- Connect the camera's USB/AV terminal to the printer's USB connector.
- The USB Connection Screen appears on the camera's LCD monitor.

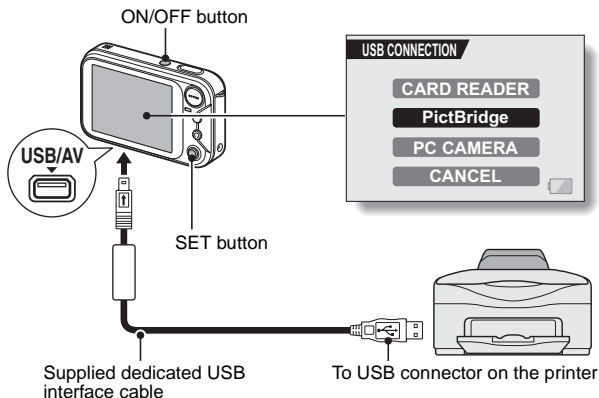

CAUTION

Insert and pull out the cable carefully

- Do not use excessive force when connecting and disconnecting cables.

-
- 3** Select “PictBridge”, and press the **SET** button.
- The Print Settings Screen appears.

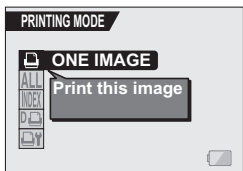

CAUTION

Caution when connecting a printer

- If the power to the printer is turned off while it is connected, the camera may not operate correctly. If the camera does not operate correctly, disconnect the USB interface cable, turn off the camera, and then reconnect the cable.
- During PictBridge printing, the camera's button operation response is slower.
- If the camera is powered by batteries for printing, make sure that the remaining battery charge is sufficient.

DIRECT PRINTING

To select one image and print it (one image)

Procedure to select one still image and print it.

1 Complete the printing setup (page 141).

2 Select the one image icon , and press the SET button.

- The screen to select images for printing appears.
-

3 Toggle the SET button to the left or right to display the image you wish to print.

- Specify the image to print.



4 Specify the number of prints.

- ① Select "COPIES", and press the SET button.
- ② Toggle the SET button up or down to specify the number of prints.
- ③ Press the SET button.
 - "PRINT" is selected.

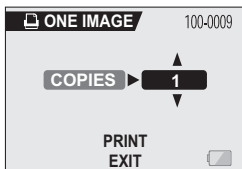

5 Press the SET button.

- Printing begins.

HINT

To cancel printing

- ① During printing, toggle the SET button down.
 - The Confirm Cancel Printing Screen appears.
- ② Select "YES", and press the SET button.
 - If "EXIT" is selected and the SET button is pressed, printing resumes.

DIRECT PRINTING

To print all the images (all images)

Print all of the images on the card.

1 Complete the printing setup (page 141).

2 Select the all images icon **ALL**, and press the **SET** button.

- The Print All Images Screen appears.
-

3 Select **"PRINT"**, and press the **SET** button.

- Printing begins.

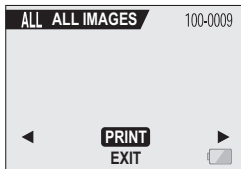

CAUTION

Printing is not possible if there are more than 999 still images in the card.

- Delete unwanted images before printing.

Thumbnail prints (index)

Make an index print of all the images on the card.

1 Complete the printing setup (page 141).

2 Select the index print icon , and press the SET button.

- The Index Print Screen appears.

3 Select “PRINT”, and press the SET button.

- Printing begins.

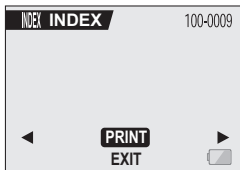

DIRECT PRINTING

To print the images that are set to print (print reserved images)

Procedure to print all the images that are set to print.

1

To change the printer settings and print images (change printer settings)

Images are printed according to settings specified by the camera, such as paper type, size, layout, printing quality, etc.

1 Complete the printing setup (page 141).

2 Select the printer settings icon , and press the SET button.

- The Printer Settings Screen appears.

MEDIA TYPE:

Specify the type of paper used for printing.

PAPER SIZE:

Specify the size of paper used for printing.

LAYOUT:

Specify how the images are to be arranged on the paper.

QUALITY:

Select the print quality for the images.

DATE STAMP:

Print the date the photo was taken.

EXIT:

Return to the PictBridge Screen.

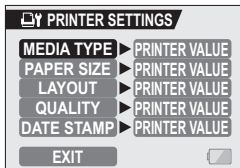

DIRECT PRINTING

3 Adjust the printer settings.

- ① **Toggle the SET button up or down to select a printer setting parameter, and press the SET button.**
 - The screen to set the selected parameter appears.
- ② **Toggle the SET button up or down to adjust the setting, and press the SET button.**
 - The selected parameter is set, and you are returned to the Printer Settings Screen.
 - Follow the same procedure to adjust the other parameters, as desired.
 - The contents of the settings that can be made for each parameter will differ depending on the printer.

<When "PRINTER VALUE" is selected>

- The images will be printed according to the settings specified on the printer side.

4 Select "EXIT", and press the SET button.

- You are returned to the Printing Mode Screen.

HINT

- The printer setting parameters will differ depending on the printer that is connected.
- To use printer functions which do not appear on your camera's Printer Settings Screen, select "PRINTER VALUE".
- If a function set by the camera is not available in the printer, the camera's printer settings will automatically change to "PRINTER VALUE".



COMMONLY ASKED QUESTIONS

If you have a question about the camera operation, you might find the answer in this compilation of commonly asked questions.

	Question	Answer	Action
Power	Why doesn't the power turn on?	Due to cold temperatures, the battery pack temporarily lost its power.	Place the camera in your pocket to warm it up before using it.
	Why is the battery pack consumed so quickly even after it was fully recharged?	The ambient temperature is very low.	Keep the battery pack in an environment of 10 to 40°C (50 to 104°F).
	Why doesn't recharging end?	The battery pack life has expired.	Replace with a new battery pack. If this is not effective, consult your dealer.
	Why does the  icon appear?	The remaining battery pack power is low.	Use the supplied AC adaptor, or replace the battery pack with a fully charged one.
Shooting	Why doesn't the touch sensor work?	You are wearing gloves.	Remove the glove from the hand pressing the shutter button.
	Why does the multi-indicator flash red?	Recorded data is being saved on the card or to the camera's internal memory.	Not a malfunction. Wait until the multi-indicator turns off.
	Why doesn't the flash operate?	The camera has determined that the image is bright enough and the flash is not necessary.	Not a malfunction. Capture the image; the camera will determine when the flash is necessary.

COMMONLY ASKED QUESTIONS

	Question	Answer	Action
Shooting	Are the settings retained even after the camera is turned off?	—	All settings except the self-timer and the exposure correction are retained even after the camera is turned off.
	Which resolution setting should I use?	—	Select the resolution setting according to the intended use: 10M 6M-H 6M-S 4M : Appropriate for printing letter-size or larger, and for printing a close-up of part of a photo (trimming). 2M : For printing standard photo (photo service) sizes. 0.3M : For photos displayed on a web page, or sent as e-mail attachments.
	What is the difference between the digital zoom and the optical zoom?	—	Because shooting with the optical zoom uses the optics of a physical lens, you can shoot without losing minute details in the image. The digital zoom, on the other hand, works by magnifying a portion of the image that hits the CCD sensor and may produce a coarser image.

	Question	Answer	Action
Shooting	How can I get the distant view into focus?	—	Set the scene select function to the landscape  mode when photographing. Or, set the focus range setting to manual focus [MF], and set the distance to ∞.
	The video clip I shot outdoors is completely white.	—	Set the flicker-reduction setting to off  .
LCD monitor	When used in cold weather, why does the image seem to leave traces as it moves?	Condition due to the liquid crystals.	Not a malfunction. Spots that appear in the LCD monitor only appear in the monitor and will not be recorded with the images.
	Why does the displayed image contain some red, blue and green dots, or why are black spots visible?		

COMMONLY ASKED QUESTIONS

	Question	Answer	Action
Viewing images	Why is the image too bright?	The subject was too bright.	When capturing an image, devise a way to compensate for a bright subject, for example, by changing the shooting angle.
	Why is the image out of focus?	The focus is not locked properly.	Hold the camera correctly, and when the image is locked in focus, gently press the shutter button all the way to capture the image.
	Why doesn't the zoom jump playback work?	Zoom jump playback does not work for an image that was created from a magnified portion of a zoom jump image, or for video clips.	Not a malfunction.
	Why is there no image (ⓧ is shown)?	This may happen when trying to play back images stored on a card from a different digital camera.	Play back images that were recorded on a card using this camera.
	Why do vertical stripes appear?	If a bright subject is shot in the video clip recording mode, vertical stripes may appear on the LCD monitor or in the image.	Not a malfunction.

	Question	Answer	Action
Viewing images	Why isn't the magnified image clear?	Due to the characteristics of the camera, magnified images appear less clear.	Not a malfunction.
	Why isn't the captured image clear?	The image was captured using the digital zoom.	Not a malfunction. Zoom in only within the optical zoom range when shooting.
	Can I play back image and sound data that I edited using my computer?	—	We cannot guarantee the accurate playback of data that has been edited using a computer.
	Why is there a motor-like sound during video clip playback?	The sound of the camera's mechanical action was recorded.	Not a malfunction.
Connecting to a TV	Why is there no sound?	The volume on the TV is set to the minimum.	Adjust the volume on the TV.
		The volume of the camera is set to 0.	Increase the playback volume of the camera.
	The edge of the image is cut off.	This is a characteristic of the TV.	Not a malfunction.
Printing	Why does a message appear during PictBridge printing?	There is a problem with the printer.	Please refer to the instruction manual for your printer.

COMMONLY ASKED QUESTIONS

	Question	Answer	Action
Misc.	Why is a noise heard from a nearby TV or radio during battery recharging?	Electromagnetic waves are emitted from the AC adaptor.	Move the AC adaptor further away from the TV or radio when recharging batteries.
	Why does the "CARD FULL" or "INTERNAL MEMORY FULL" message appear?	There is no more available memory on the card or in the camera's internal memory.	Erase unnecessary data, or use a card that has more memory available.
	Why does the "CARD IS PROTECTED" message appear?	The lock switch on the card is in the locked (protect) position.	Move the lock switch to the unlocked position.
	Why can't the camera be operated?	A temporary internal circuitry problem may be the cause.	Remove the AC adaptor and battery pack from the camera, wait a few minutes, then reinstall the battery pack and try again.

	Question	Answer	Action
Misc.	Can I use my camera abroad?	—	When the camera is connected to a TV, you can switch the camera's video output to NTSC or PAL. If you have questions about using the AC adaptor and power cord abroad, please consult with a dealer near you for advice.
	Why does the "SYSTEM ERROR" message appear?	A problem has occurred within the camera or card.	Check the following items: ① Remove the card and then install it again. ② Remove the battery pack and then install them again. ③ Install a different card. If "SYSTEM ERROR" still appears after performing the above steps, then take the camera to the dealer for service.

TROUBLESHOOTING

Before taking your camera to the repair shop, check the following table for a possible solution to the problem.

CAMERA

	Problem	Cause	Action	Reference page
Power	No power.	The battery pack is dead.	Recharge the battery pack.	18
		The battery pack has not been inserted correctly.	Reinsert the battery pack, making sure to orient it correctly.	
	The camera turns off by itself.	The power save function is operating.	Turn on the camera again.	22
Shooting	An image is not captured when the shutter button is pressed.	The power is not turned on.	If the power save function was activated, press one of the buttons to turn the camera on before shooting. If the camera was turned off, press the ON/OFF button to turn it on.	22



	Problem	Cause	Action	Reference page
Shooting	An image is not captured when the shutter button is pressed.	The maximum number of images that can be captured or the maximum video clip recording time has been reached.	Install a new card.	16
			Erase the images that are not necessary. Save the images to separate media, then erase all the images from the card.	89
	The flash does not operate.	The flash off mode is selected.	Set the flash to automatic flash mode or forced flash mode.	43
		The battery pack is dead.	Recharge the battery pack.	18
	The digital zoom does not work.	The still image mode is set to 10M . The digital zoom setting is set to "OFF".	Set the still image mode to 6M-H . Set the digital zoom setting to "ON".	64, 123
A warning tone (beep-beep-beep) sounds, and it is not possible to take a picture using the self-timer.	The battery pack is consumed.	Install a sufficiently recharged battery pack.	18	

TROUBLESHOOTING

	Problem	Cause	Action	Reference page
Shooting	When zooming in or out, the zoom movement stops momentarily.	The optical zoom has moved to the maximum magnification position.	Not a malfunction. Release the zoom switch, and press it again.	42
	There is noise in the captured image.	The ISO sensitivity setting is too high.	Set the ISO sensitivity to a lower setting.	78
LCD monitor	No playback image appears.	The playback mode is not active.	Press the playback button [▶].	35
Viewing images	The image is too dark.	The flash was blocked by a finger or other object.	Hold the camera correctly, and make sure the flash is not obstructed.	28
		The subject was too far away.	Capture the image in the range of operation of the flash.	168
		The subject was lit from behind.	Use the forced flash mode.	43
			Use the exposure correction function.	45
There is not enough light.	Adjust the ISO sensitivity setting.	78		

	Problem	Cause	Action	Reference page
Viewing images	The video clip picture is flickering.	The video clip was filmed under fluorescent lighting.	Set the flicker-reduction setting to on.	81
	The image is too bright.	The forced flash mode is selected.	Select a different flash mode.	43
		The subject was too bright.	Use the exposure correction function.	45
		The ISO sensitivity setting is incorrect.	Set the ISO sensitivity to ISO-A .	78
	The image is not in focus.	The subject is too close to the camera.	Select the correct focus setting for your needs.	33, 76
		The focus setting is not correct.		
		The camera moved when the shutter button was pressed.	Hold the camera correctly and press the shutter button correctly.	28, 33
		The focus is not locked properly.		
	The lens is dirty.	Clean the lens.	—	

TROUBLESHOOTING



















	Problem	Cause	Action	Reference page
Viewing images	The colors of the images captured indoors are not correct.	This is due to ambient lighting.	Capture the image using the forced flash mode.	43
		The white balance setting is incorrect.	Set the white balance setting correctly.	79
	A part of the image is missing.	The handstrap or a finger was blocking the lens or lens opening.	Hold the camera correctly, and make sure the lens is not obstructed.	28
	"NO IMAGE" is shown.	There is no recorded image or audio data in the installed card.	Play back after capturing images or making audio recordings.	33, 38
	During audio playback, there is no sound.	The volume setting on the camera is too low.	Select the volume icon  and adjust the volume.	91
Connecting to a TV	There are no colors in the image. The image is distorted.	The TV system setting is not correct.	Change the TV system setting to the correct setting.	127
	No image or sound.	The digital camera is not correctly connected to the TV.	Follow the instructions to make the connection correctly.	140
		The TV input is not set correctly.	Set the input on the TV to "VIDEO".	
	There is no sound.	The volume setting on the camera is too low.	Select the volume icon  and adjust the volume.	91

	Problem	Cause	Action	Reference page
Image editing	You cannot edit or rotate an image.	The protect mode is set.	Cancel the protect mode.	87
Misc.	The "PROTECTED" message appears and the data cannot be erased.	You have attempted to erase data that is protected from accidental erasure.	Set the protect setting for the data to OFF.	87
	The audio guide does not sound.	The audio guide setting is set to "OFF".	Set the audio guide setting to "ON".	119
	When a 1GB card is used, the recording capacity is less than that indicated in the section "Possible No. of Images/ Possible Shooting Time/ Possible Recording Time".	The recording capacity of the card is less than 1GB.	Depending on the card, the capacity may be less than 1GB. Please refer to the instructions that accompanied the card.	170















TROUBLESHOOTING

Notes regarding the Scene Select feature and filters









During still image shooting

	When using a filter, the  focus range setting is not available.
	The  and  focus range settings are not available.
	
	
	
	
	Focus range: Fixed at  . Flash: Fixed at  .
	The  and  focus range settings are not available. The resolution is fixed at 0.3M . The flash setting is fixed at  .
	The  and  focus range settings are not available. The flash operates only during the 4th shot. Not available for the 10M resolution setting.

During video clip recording

	When using a filter, the  focus range setting is not available.
	The  and  focus range settings are not available.
	
	
	
	
	The focus range is fixed at  .
	The  and  focus range settings are not available.

About the scene select function and focus range settings

- The scene select function changes to  when the focus range is set to .
- Even if you set the focus range to ,  or , it changes to  when the scene select function is set to  or .

SPECIFICATIONS

Digital Camera

Type	CCD digital camera (recording and playback)
Recording system	Digital recording
Image file format	Still images: JPEG format (DCF, DPOF, Exif 2.2 compliant) Note: Designed mainly by the Japan Electronics and Information Technology Industries Association (JEITA), DCF (Design rules for camera file system) is standard for digital still camera image files to provide interoperability between digital photography devices for the images stored on removable memory cards. However, it is not guaranteed that all devices will support the DCF standard. Video clips: QuickTime Movie (Photo-JPEG) Audio: WAVE (monaural)
Data storage media	Internal memory: 16MB External memory: SD Memory Card, Multi Media Card
Camera effective number of pixels	Approx. 6 million pixels
Image sensor	1/2.5-inch CCD Virtual number of pixels: Approx. 6.37 million pixels, interlace scan, primary color filter

Recording resolution	<p>10M: 3,680 × 2,760 pixels (single-shot still images only)</p> <p>6M-H: 2,816 × 2,112 pixels (single-shot still images and sequential shots only)</p> <p>6M-S: 2,816 × 2,112 pixels (single-shot still images and sequential shots only)</p> <p>4M: 2,288 × 1,712 pixels (single-shot still images and sequential shots only)</p> <p>2M: 1,600 × 1,200 pixels (single-shot still images and sequential shots only)</p> <p>0.3M: 640 × 480 pixels (single-shot still images and sequential shots only)</p> <p>640-H: 640 × 480 pixels, 30 frames/second, low compression (video clip recording only)</p> <p>640-S: 640 × 480 pixels, 30 frames/second, standard compression (video clip recording only)</p> <p>320-H: 320 × 240 pixels, 30 frames/second, low compression (video clip recording only)</p> <p>320: 320 × 240 pixels, 15 frames/second, standard compression (video clip recording only)</p> <p>160: 160 × 120 pixels, 15 frames/second, standard compression (video clip recording only)</p>	
White balance	Full-auto TTL, manual setting possible	
Lens	Curved optical 3.0x zoom lens	f=6.3 mm to 18.9 mm (35 mm film camera conversion f=38 mm to 114 mm) Autofocus, 9 groups, 11 elements
Aperture	Open F=3.3 (Wide) to 4.0 (Tele) Smallest F=6.6 (Wide) to 8.0 (Tele)	
Exposure control type	Programmable AE Exposure correction available from the Shooting Setting Screen (0±1.8EV in 0.3EV steps)	
Light-measuring modes	Multi-section measuring, center-weighted measuring, spot measuring	

SPECIFICATIONS

Range	20 cm (7.87 in.) (Wide)/50 cm (19.69 in.) (Tele) to infinity (normal photography), 1 cm (0.39 in.) (Wide)/50 cm (19.69 in.) (Tele) to 60 cm (23.62 in.) (super macro photography)
Digital zoom	For shooting: 1x to 4x (except resolution 10M) For playback: 1x to 57.5x (varies with resolution)
Shutter speed	Single-shot mode: 1/2 to 1/2,000 sec. (Maximum approx. 2 seconds when scene select function set to lamp (L) etc.) (During flash: 1/30 to 1/2,000 sec.) Sequential shots shooting mode: 1/2 to 1/2,000 sec. Video clip recording mode: 1/30 to 1/10,000 sec.
Sensitivity	Single-shot mode/sequential shots shooting mode: Auto (equivalent to ISO50 to 200)/equivalent to ISO50, ISO100, ISO200, and ISO400 (switchable from Shooting Setting Screen) (Maximum ISO sensitivity up to 1,800 variation: when scene select function set to lamp (L)) Video clip recording mode: Auto (equivalent to ISO450 to 1,800)/equivalent to ISO450, ISO900, ISO1,800, and ISO3,600 (switchable from Shooting Setting Screen)
LCD monitor	3.0-inch low-temperature poly-silicon TFT color LCD Approx. 230,000 pixels (Frame coverage: Approx. 100% when dedicated AV interface cable is not connected) 7-step brightness adjustment

Flash working range		GN = 5.6 Approx. 10 cm (3.94 in.) to 2.4 m (7.87 ft.) (Wide) Approx. 50 cm (1.64 ft.) to 2.0 m (6.56 ft.) (Tele)
Flash modes		Auto-flash, forced flash, flash off, red-eye reduction
Focus		TTL-type AF (9-point range finder/spot focus), manual focus (16 steps)
Self-timer		2-second delay, 10-second delay
Time/date		Recorded with image data
Ambient environment	Temperature	0 to 40°C (32 to 104°F) (operation), -20 to 60°C (-4 to 140°F) (storage)
	Humidity	30 to 90% (operating, no condensation) 10 to 90% (storage, no condensation)
Power supply	Battery pack (supplied)	Lithium-ion battery pack (DB-L20) × 1
	AC adaptor (supplied)	VAR-G8
Dimensions (not including protuberances, depth at narrowest dimension)		97.7(W) × 59.5(H) × 22.8(D) mm 3.85" (W) × 2.34" (H) × 0.90" (D)
Weight		Approx. 134 g (4.73 oz.) (without battery pack and card)

SPECIFICATIONS

Digital camera connectors

USB/AV (communication/sound and image output) terminal	Dedicated regrouped jack	
	Audio output	265 mVrms (−9 dBs), 6 kΩ or less, monaural
	Video output	1.0 Vp-p, 75 Ω unbalanced, sync negative, composite video, NTSC color TV system/PAL TV system (switchable from the Option mode Screen)
	USB	USB 2.0 High-speed PC camera: USB video class
DC IN (external DC power input) terminal	DC 5.0 V (for exclusive use with the supplied AC adaptor [VAR-G8])	

Battery life

Maximum recording time	170 images: CIPA standard (when a Matsushita 32MB SD Memory Card is used)
Maximum playback time	210 minutes: LCD monitor on, continuous playback

- Approximate time until battery pack runs out, based on test conditions at room temperature (25°C [77°F]).
- The operation time may vary depending on the conditions of the battery pack and the conditions of use. Especially when used at temperatures below 10°C (50°F), the battery pack operation time is drastically reduced.

Possible No. of Images/Possible Shooting Time/Possible Recording Time

The table shows the possible number of captured images and the possible recording time for the camera's internal memory (16MB) and for the commercially available 128MB and 1GB SD Memory Card.

Shooting/ recording mode	Resolution setting	Internal memory	SD Memory Card	
			128 MB	1 GB
Single-shot mode (no voice memo)/ Sequential shots mode	10M ^{*1}	4 images	37 images	290 images
	6M-H	5 images	42 images	330 images
	6M-S	7 images	64 images	495 images
	4M	11 images	96 images	746 images
	2M	23 images	191 images	1,470 images
	0.3M	119 images	979 images	7,550 images
Video clip mode	640H	10 sec.	1 min. 26 sec.	11 min. 7 sec.
	640S	14 sec.	1 min. 58 sec.	15 min. 12 sec.
	320H	23 sec.	3 min. 15 sec.	25 min. 11 sec.
	320	1 min. 26 sec.	11 min. 55 sec.	1 hr. 32 min.
	160	2 min. 32 sec.	20 min. 52 sec.	2 hr. 41 min.
Sound recording mode	—	33 min.	4 hr. 31min.	34 hr. 58 min.

- Even with cards of the same capacity, the amount of data that can actually be stored may differ depending on the card brand, etc.
- The continuous shooting time for each video clip will differ depending, for example, on the card capacity, environmental conditions (temperature and shooting conditions, etc.).

*1: Available only for single-shot still image shooting.

SPECIFICATIONS

Concerning the multi-indicator

The camera's multi-indicator will light, flash, or be off, depending on the different camera operations.

Multi-indicator status		Camera status
Off	—	Charging completed
Lit	—	Connected to a computer or printer; during charging
Flashing	Slow	Power save mode (sleep)
	Fast	Error or when error is displayed; warning
	Very fast	Accessing card or internal memory

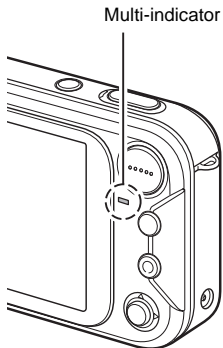

Supplied AC adaptor

Part number		VAR-G8
Power source		AC 100 to 240 V, 50 to 60 Hz
Rated output		DC 5.0V, 2.0 A
Ambient environment	Temperature	0 to 40°C (32 to 104°F) (operation), -20 to 60°C (-4 to 140°F) (storage)
	Humidity	10 to 90% (no condensation)
Dimensions		49.5 (W) × 25.5 (H) × 68.3 (D) mm 1.95" (W) × 1.00" (H) × 2.69" (D)
Weight (without power cord)		Approx. 169 g (5.96 oz.)
Power cord rated value	VPC-E6EX, GX	AC 250 V, 2.5 A
	VPC-E6	AC 125 V, 7 A

- When using the supplied AC adaptor abroad, the power cord may need to be replaced in accordance with local requirements. Please contact your local dealer for details.

Supplied Lithium-ion battery pack

Model number	DB-L20	
Voltage	3.7 V	
Capacity	720 mAh	
Ambient environment	Temperature	0 to 40°C (32 to 104°F) (during use, recharged) -10 to 30°C (14 to 86°F) (storage)
	Humidity	10 to 90% (no condensation)
Dimensions	39.4 (W) × 6.0 (H) × 35.5 (D) mm 1.55" (W) × 0.24" (H) × 1.34" (D)	
Weight	Approx. 19 g (0.67 oz.)	

Others

Apple, Macintosh and QuickTime are trademarks or registered trademarks of Apple Computer Inc.

Windows and Windows NT are registered trademarks of Microsoft Corporation.

All other company and product names are registered trademarks or trademarks of their respective owners.

CAUTION

- It is forbidden to copy this manual, whole or in part, without prior written permission.
- All images and illustrations given in this manual are for explanation purposes and may differ slightly from that of the actual product. Also, actual specifications are subject to change without prior notice and therefore may differ from the contents of this manual.
- Sanyo Electric shall not be held responsible for any problems resulting from the use of this camera.
- Sanyo Electric declines all responsibility for damages due to improper use of the camera, failure to adhere to the instructions given in this manual, or repairs or changes done by those other than a technician authorized by the manufacturer.
- Sanyo Electric shall not be held responsible for any damage caused by optional devices or consumable items used with the camera other than those supplied with the camera or those specified by Sanyo Electric.
- Sanyo Electric shall not be held responsible for any losses or loss of revenue resulting from the loss of data caused by the malfunction, or the repairing of a malfunction, of the camera.
- The images captured with this camera will differ in quality from pictures taken with a standard film camera.

HINTS FOR TAKING PICTURES

Taking great pictures in difficult surroundings is easier than you might think. By keeping a few points in mind and choosing the correct settings, you can create photos that you'll be proud to display and share.

If images are blurred even when the autofocus is used

Your camera employs an autofocus function. When you snap a picture using the autofocus, the camera automatically adjusts the settings so that the image will be in focus. If you are getting blurred images even when using the autofocus, one or more of the following might be the reason.

■ How the autofocus works

The autofocus is activated when the shutter button is lightly touched. Press the shutter button slightly, and the target mark will appear on the LCD monitor to indicate that the autofocus has been activated. Next, continue to gently press the shutter button all the way to snap the picture. This two-step method is the way to ensure that your photos are perfectly focussed.

■ Reasons for unfocussed images

- ① The shutter button was pressed before the image was focused.
- ② After the image was focussed, the subject moved.
 - Even if camera focusses the subject once, if the distance between the camera and the subject is changed, the subject may become out of focus.
- ③ The focus setting is not set for the correct distance.
 - If you shoot a close-up subject with the camera set to the normal focus mode, or if you shoot a subject at normal distance with the camera set to the super macro (close-up) mode, the image will not be in focus.

■ Preventing blurred images

- ① Confirm that the camera is set to the correct focus mode for your subject.
- ② Hold the camera correctly, and lightly touch the shutter button.
- ③ Wait for the target mark to appear in the LCD monitor, and holding the camera steady, gently continue to press the shutter button all the way down.

Following these steps for a gentle but firm pressing of the shutter button will ensure that you get beautifully focussed photos.

Photographing a moving subject

Situation: You would like to snap an action shot of a moving child or pet. The autofocus is activated, but because the subject is moving, the image may be blurred. In particular, when the distance between the camera and the subject is changing, it is difficult to lock the focus on the subject. Here are some hints for successfully capturing images of moving subjects.

■ Reasons for unfocussed images

When the shutter button is touched lightly, the camera's autofocus works by determining the distance between the camera and the subject. Once the subject is in focus, if it then moves before the picture is snapped, the image may be out of focus. This often happens when you once lock the focus on a subject and then wait for the right moment to snap the picture. And, conversely, a blurred image may result if you press the shutter button all the way in one step in an attempt to quickly capture an action scene, thus failing to activate the autofocus in time.

■ Preventing blurred images (How to use the manual focus [page 68])

In addition to the autofocus, a manual focus mode is also incorporated in your camera. In the autofocus mode, the distance between the camera and the subject is automatically determined when you press the shutter button halfway. In contrast to this, with the manual focus mode, you manually set the focus by specifying the correct distance between the camera and the subject before taking the picture.

■ How to photograph a moving subject

- ① Set the camera's focus mode to the manual focus. Set the focus distance to the correct distance between the camera and the subject.
- ② When the subject is at the set focus distance, gently press the shutter button all the way down.

<Advantage of using the manual focus>

- Images can be quickly captured without waiting for the autofocus to activate.
- Because you are presetting the focus distance, the focus can be more accurate.

<Using the manual focus effectively>

- When photographing a moving subject, press the shutter button just before the subject reaches the focus distance, and the shutter will be released when the subject is at the correct distance.
- Use manual focus to avoid incorrectly focussed images when there is an object between the camera and the subject you wish to focus on.

Shooting portraits (portrait mode)

Points:

- Choose a background that doesn't detract from your subject.
- Move in close to your subject.
- Pay attention to lighting and how it affects your subject.

NOTE

- If the background is distracting, it will not show your subject to his best advantage. Move in closer to your subject or zoom in so that the background does not compete with the subject.
- In portrait photography your subject is clearly the central figure, so try techniques that allow the subject to stand out.
- If light is coming from behind your subject (backlit), his face will appear dark. You can get a better picture by using the flash, for example, or changing the exposure setting.

Photographing moving subjects (sports mode)

Points:

- Match the camera's movement with that of the subject.
- Set the zoom to the Wide end (wide-angle).
- Don't be too hesitant to press the shutter button, or you'll miss the action.

NOTE

- Tips to not missing those great action shots: Make sure you're holding the camera correctly. Keep the subject in the lens at all times, moving the camera with him while waiting for the right shot. Move your whole body—not just your arms—with the camera while shooting.
- Blurred images are more likely when the zoom is set to the Tele end than the Wide end. Set the zoom as close as possible to the Wide end.
- Learn to press the shutter button quickly yet smoothly the instant your photo chance occurs.

Night photography (night view mode)

Points:

- Avoid camera shake.
- Increase the ISO sensitivity.

NOTE

- Camera shutter speed during night photography is considerably slower, so there is a much greater chance that your photographed images will be blurry. Use a tripod whenever possible, or if a tripod is not available, you can lean against a wall or pillar to help stabilize the camera.
- You can photograph your subject with the night scene in the background by using the flash. Be careful not to shoot too close to the subject, however, or your subject's face will appear too bright.
- After the flash operates, keep the camera and the subjects motionless for about 2 seconds.

Photographing scenery (landscape mode)

Points:

- Shoot using a high resolution.
- For zoom photography, use the optical zoom.
- Pay attention to picture composition.

NOTE

- When shooting with a wide-angle setting, or if you intend to enlarge the photo, the higher the resolution, the better.
- To zoom in on distant scenery, it's better to use the optical zoom. Using the digital zoom produces a coarser image. Hold the camera securely, keeping your elbows close to your body and making sure the camera is stable. Using a tripod or other means of stabilizing the camera will increase the likelihood of getting a clear photo.
- Don't forget to pay attention to picture composition; note perspective and be aware of how the placement of objects affects the scene.

SANYO

SANYO Electric Co., Ltd.

Free Manuals Download Website

<http://myh66.com>

<http://usermanuals.us>

<http://www.somanuals.com>

<http://www.4manuals.cc>

<http://www.manual-lib.com>

<http://www.404manual.com>

<http://www.luxmanual.com>

<http://aubethermostatmanual.com>

Golf course search by state

<http://golfingnear.com>

Email search by domain

<http://emailbydomain.com>

Auto manuals search

<http://auto.somanuals.com>

TV manuals search

<http://tv.somanuals.com>