

7 Mega Pixels

SANYO

Digital Camera

VPC-E760

User's Manual

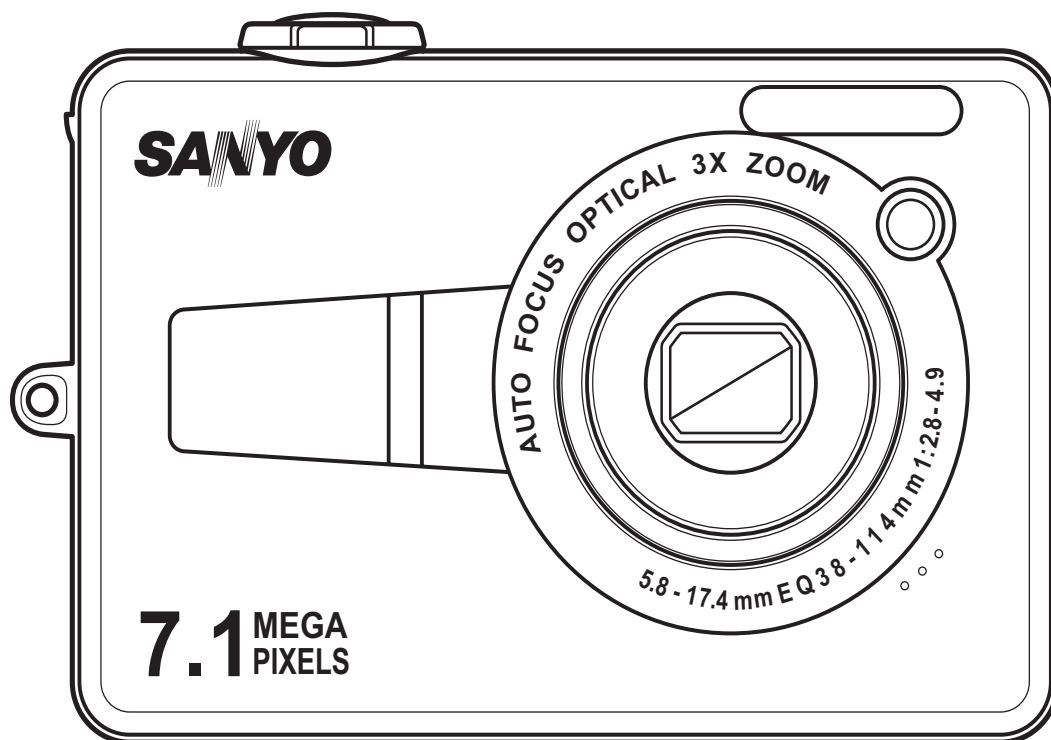

Table of Contents

Preface	i
About this Manual	i
Copyright	i
Federal Communications Commission (FCC) Compliance	i
Declaration of Conformity	i
Trademark Recognition	ii
Safety and Handling Precautions	ii
Camera Information	ii
Battery Information	ii
Introduction	1
System Requirements	1
Package Contents	1
Main Features	1
Camera Views	2
Front View	2
Back View	2
Top View	2
Bottom View	3
Left / Right View	3
The Mode Dial	3
Navigation Buttons	4
LED Indicators	6
LCD screen	7
Capture/Video Mode Display	7
Camera Setup	12
Attaching the Wrist Strap	12
Inserting the Battery	12
Inserting an SD/MMC Memory Card	13
Charging the Battery	13
Turning On	13
First Time Use	14
Getting Started	15
Taking your First Photo	15
Anti-Shake Function	15
Using Quick Review	15
Using Macro Mode	15
Setting the Flash Mode	16
Using the Zoom in/out Function	16
Using the Self-timer and Burst Photography	16
Setting the Scene Mode	17

Face Detection AF/AE Function	17
Recording your First Video	18
Recording Audio Files	18
Recording Voice Memos	18
Capture Settings	19
The Capture Menu	19
Image Resolution	19
Image Quality	20
Focus Zone	20
EV Compensation	20
M-Burst Interval	21
White Balance	21
ISO Speed	21
AE Metering	22
Color	22
Sharpness	22
Saturation	22
Contrast	23
Setup	23
Video Capture Menu	23
Video Resolution	23
White Balance	23
Color	23
Saturation	23
Contrast	23
Setup	24
Photo, Video & Audio Playback	25
Playback Mode Display	25
Viewing Photos/Videos on the LCD Screen	27
Viewing M-Burst Photos	27
Listening to Audio Files	28
Listening to Voice Memo	28
Viewing Photos/Videos on your TV	28
Zooming In During Playback	29
Deleting Photos/Videos/Audios	29
Using the Playback Menu	29
DPOF	30
Slideshow	31
Resize	31
Rotate	32
Protect	32
Red-Eye Compensation	33
Move	33
Transferring Photos/Videos to your PC	34

Camera Settings	35
The Setup Menu	35
File Number	35
Digital Zoom	35
Quick View	36
Continuous AF	36
Camera Sound	36
Auto LCD Off	36
Auto Power Off	37
Video Out	37
USB Mode	37
Date Stamp	38
Date and Time	38
Language	38
Image Storage	39
Format	39
Reset	39
Voice Memo	39
PictBridge Print (PTP)	40
Image Storage	40
This Image	41
Index Print	42
DPOF Image	42
All Images	43
Specifications	44
Troubleshooting	47

Preface

About this Manual

This manual is designed to assist you in using your new digital camera. All information presented is as accurate as possible but is subject to change without notice.

Copyright

This manual contains proprietary information protected by copyright. All rights are reserved. No part of this manual may be reproduced by any mechanical, electronic or other means, in any form, without prior written permission of the manufacturer.

© Copyright 2007

Federal Communications Commission (FCC) Compliance

This equipment has been tested and found to comply with the limits for a Class B digital device, pursuant to Part 15 of the FCC Rules. These limits are designed to provide reasonable protection against harmful interference in a residential installation. This equipment generates, uses, and can radiate radio frequency energy and, if not installed and used in accordance with the instructions, may cause harmful interference to radio communications. However, there is no guarantee that interference will not occur in a particular installation. If this equipment does cause harmful interference to radio or television reception, which can be determined by turning the equipment off and on, the user is encouraged to try to correct the interference by one or more of the following measures:

- Reorient or relocate the receiving antenna.
- Increase the distance between the equipment and the receiver.
- Connect the equipment to an outlet on a circuit different from that to which the receiver is connected.
- Consult the dealer or an experienced radio/TV technician for help.

Warning: A shielded-type power cord is required in order to meet FCC emission limits and to prevent interference to radio and television reception. Use only shielded cable to connect I/O devices to this equipment. Any changes or modifications not expressly approved by the manufacturer may void your warranty and service agreement.

Declaration of Conformity

This device complies with Part 15 of the FCC rules. Operation is subject to the following conditions:

- This device may not cause harmful interference.
- This device must accept any interference received, including interference that may cause undersired operation.

Trademark Recognition

Windows 98/2000/ME/XP are registered trademarks of Microsoft Corporation in the United States and/or other countries. Windows is an abbreviated term referring to the Microsoft Windows Operation System. Adobe is a trademark of Adobe Corporation. ArcSoft is the trademark of ArcSoft System, Inc. All other companies or product names are trademarks or registered trademarks of their respective companies.

Safety and Handling Precautions

Camera Information

- Do not take apart or attempt to service the camera yourself.
- Do not expose the camera to moisture, or extreme temperatures.
- Allow the camera to warm up when moving from cold to warm temperatures.
- Do not touch the camera lens.
- Do not expose the lens to direct sunlight for extended periods.
- Do not use abrasive chemicals, cleaning solvents or strong detergents to clean the product. Wipe the product with a slightly damp soft cloth.

Battery Information

- Turn off the camera before installing or removing the battery.
- Use only the type of battery and charger that came with your camera. Using other types of battery or charger may damage the equipment and invalidate the warranty.
- When using Li-ion battery in this product, ensure that they are inserted correctly. Inserting the battery upside down can cause damage to the product and possibly start a fire.
- Download all pictures and remove the battery from the camera if you are going to store the camera for long periods.

Safety Instructions

Read and understand all **Warnings** and **Cautions** before using this product.

WARNING

If foreign objects or water have entered the camera, turn the power OFF and remove the battery and the AC power adapter.

Continued use in this state might cause fire or electric shock. Consult the store of purchase.



If the camera has fallen or its case has been damaged, turn the power OFF and remove the battery and the AC power adapter.

Continued use in this state might cause fire or electric shock. Consult the store of purchase.



Do not disassemble, change or repair the camera.

This might cause fire or electric shock. For repair or internal inspection, ask the store of purchase.



Use the specified AC power adapter only with the indicated power supply voltage.

Use with any other power supply voltage might cause fire or electric shock.



Do not use the camera in areas near water.

This might cause fire or electric shock. Take special care during rain, snow, on the beach, or near the shore.



Do not place the camera on inclined or unstable surfaces.

This might cause the camera to fall or tilt over, causing injury.



Keep the battery out of the reach of children.

Swallowing battery might cause poisoning. If the battery is accidentally swallowed, immediately consult a physician.



Do not use the camera while you are walking, driving or riding a vehicle.

This might cause you to fall over or result in traffic accident.



CAUTION

Insert the battery paying careful attention to the polarity (+ or -) of the terminals.

Inserting the battery with its polarities inverted might cause fire and injury, or damage to the surrounding areas due to the battery rupturing or leaking.



Do not fire the flash close to anyone's eyes.

This might cause damage to the person's eyesight.



Do not subject the LCD monitor to impact.

This might damage the glass on the screen or cause the internal fluid to leak. If the internal fluid enters your eyes or comes into contact with your body or clothes, rinse with fresh water.

If the internal fluid has entered your eyes, consult a physician to receive treatment.



A camera is a precision instrument. Do not drop it, strike it or use excessive force when handling the camera.

This might cause damage to the camera.



Do not use the camera in humid, steamy, smoky, or dusty places.

This might cause fire or electric shock.



Do not remove the battery immediately after long period of continuous use.

The battery becomes hot during use. Touching a hot battery might cause burns.



Do not wrap the camera or place it in cloth or blankets.

This might cause heat to build up and deform the case, resulting in fire. Use the camera in a well-ventilated place.



Do not leave the camera in places where the temperature may rise significantly, such as inside a car.

This might adversely affect the case or the parts inside, resulting in fire.



Before you move the camera, disconnect cords and cables.

Failure to do this might damage cords and cables, resulting in fire and electric shock.



Warning:

TO PREVENT THE RISK OF FIRE OR ELECTRIC SHOCK, DO NOT EXPOSE THIS APPLIANCE TO RAIN OR MOISTURE

FOR AMERICAN USERS

The following advisory is included in accordance with the laws of the State of California (USA):

WARNING:

This product contains chemicals, including lead, known to the States of California to cause cancer, birth defects or other reproductive harm. ***Wash hands after handling.***

Safety Instructions

- This equipment has been tested and found to comply with the limits for a Class B digital device, pursuant to Part 15 of the FCC Rules. These limits are designated to provide reasonable protection against harmful interference in a residential installation. This equipment generates, uses and can radiate radio frequency energy and, if not installed and used in accordance with instructions, may cause harmful interference to radio communications. However, there is no guarantee that interference will not occur in a particular installation. If this equipment does cause harmful interference to radio or television reception, which can be determined by turning the equipment off and on, the user is encouraged to try to correct the interference by one or more of the following measures:
 - * Reorient or relocate the receiving antenna.
 - * Increase the separation between the equipment and receiver.
 - * Connect the equipment into an outlet on a circuit different from that to which the receiver is connected.
 - * Consult the dealer or an experienced radio/TV technician for help.
- Changes or modifications not expressly approved by the party responsible for compliance could void the user's authority to operate the equipment.

FOR CANADIAN USERS

This Class B digital apparatus complies with Canadian ICES-003

FOR EU USERS

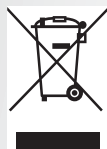

Note:

This symbol mark and recycle system apply to EU countries and do not apply to countries in other areas of the world.

Your SANYO product is designed and manufactured with high quality materials and components which can be recycled and reused.

This symbol means that electrical and electronic equipment, at their end-of-life, should be disposed of separately from your household waste.

Please dispose of the equipment at your local community waste collection/recycling centre.

In the European Union there are separate collection systems for used electrical and electronic products.

Please help up to conserve the environment we live in!

Symbols used in this manual



NOTE

Points giving some extended instructions or special points to pay attention to.

You may find the answers to questions or problems concerning camera operation in the sections "Troubleshooting".

vi Preface

FCC information



Tested To Comply With FCC Standards
FOR HOME OR OFFICE USE

Declaration of Conformity

Model number: VPC-E760

Trade Name: SANYO

Responsible party: SANYO FISHER COMPANY

Address: 21605 Plummer Street

Chatsworth, California 91311

Telephone No.: (818) 998-7322

This device complies with Part 15 of the FCC Rules. Operation is subject to the following two conditions:

- (1) this device may not cause harmful interference, and
- (2) this device must accept any interference received, including interference that may cause undesired operation.

Canadian ICES-003 information

This class B digital apparatus complies with Canadian ICES-003.

Safety Instructions

TRADEMARK INFORMATION

- Microsoft® and Windows® are U.S. registered trademarks of Microsoft Corporation.
- Pentium® is a registered trademark of Intel Corporation.
- Macintosh® is a trademark of Apple Computer, Inc.
- SD™ is a trademark.
- SDHC™ is a trademark. 
- Other names and products may be trademarks or registered trademarks of their respective owners.

READ THIS FIRST

Notice:

- Product design and specifications are subject to change without notice. This includes primary product specifications, software, software drivers, and user's manual. This User Manual is a general reference guide for the product.
- The product and accessories that come with your camera may be different from those described in this manual. This is due to the fact that different retailers often specify slightly different product inclusions and accessories to suit their market requirements, customer demographics, and geographical preferences. Products very often vary between retailers especially with accessories such as batteries, chargers, AC adapters, memory cards, cables, pouches, and language support. Occasionally a retailer will specify a unique product color, appearance, and internal memory capacity. Contact your dealer for precise product definition and included accessories.
- The illustrations in this manual are for the purpose of explanation and may differ from the actual design of your camera.
- The manufacturer assumes no liability for any errors or discrepancies in this user manual.

Introduction

Congratulations on the purchase of your new digital camera. This manual provides step-by-step instructions on how to use your camera, and is intended for your reference only.

System Requirements

In order to get the most out of your camera, your computer must meet the following system requirements:

- OS: Windows 98/98SE/2000/XP
- Memory: 128MB or above
- HDD space: 40 MB or above
- USB port

Package Contents

Check the contents of your camera package. It should contain:

- Digital camera
- USB/AV 3-in-1 cable
- Wrist strap
- One Li-ion battery
- Battery charger and power cord
- Camera pouch
- Quick start guide for all regions
- Bundled AP-CD (Application Software, Driver and User's Manual for all regions)

Main Features

- 7.1 mega pixels resolution
- 15x zoom (Up to 3x optical zoom and 5x digital zoom)
- 1/2.5 inch CCD image sensor
- 2.4 inch LTPS TFT LCD monitor
- 16 MB internal flash memory with optional external SD/MMC card
- Sleek and slim design
- Easy-to-use button interface
- PictBridge compatibility
- Slideshow feature to review your pictures and movies
- A/V output to view your pictures and movies on your TV
- USB port to transfer photos and movies to your PC

Camera Views

Front View

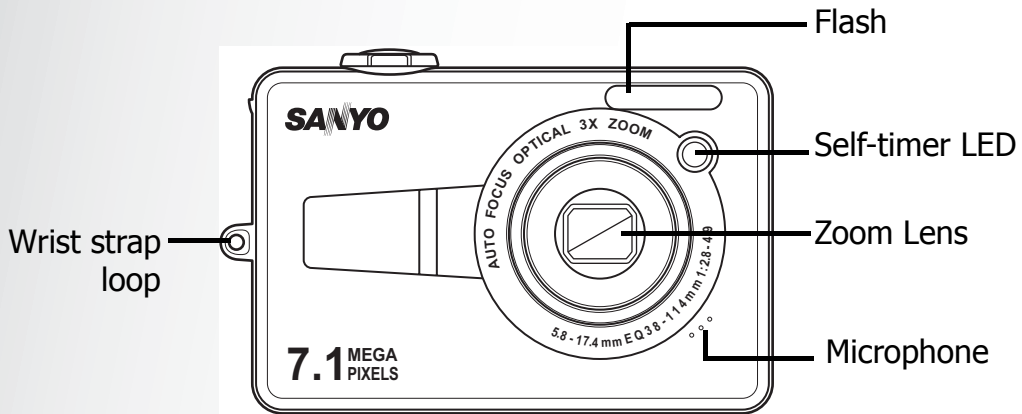

Back View

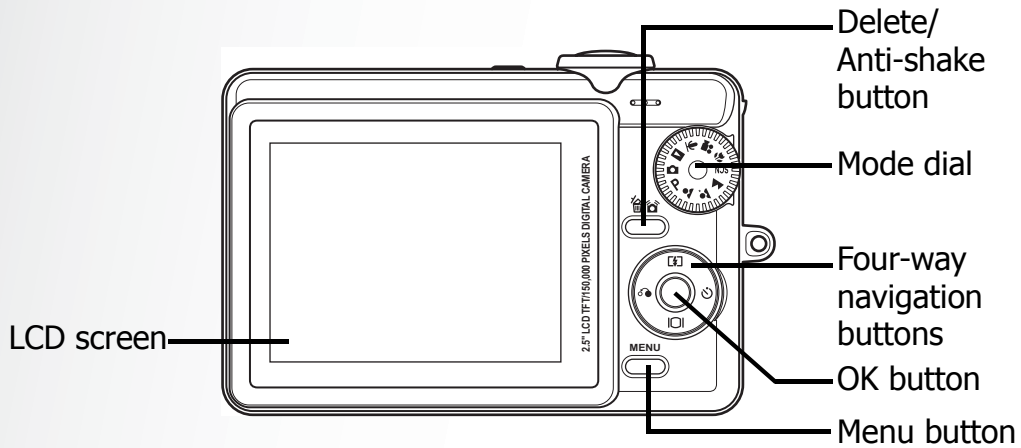

Top View

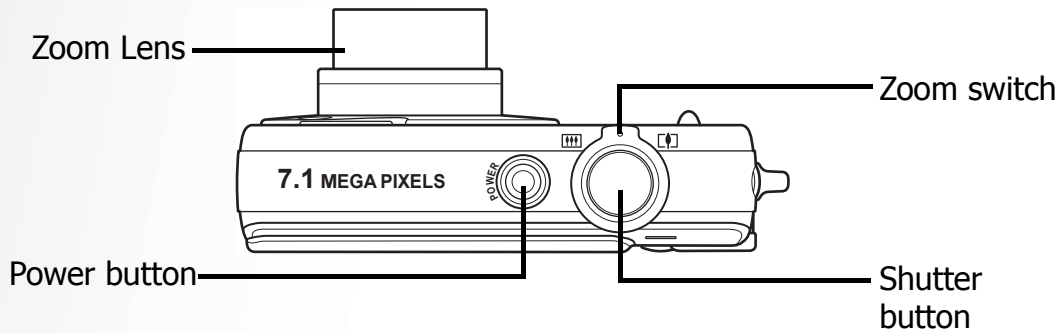

Camera Views

Bottom View

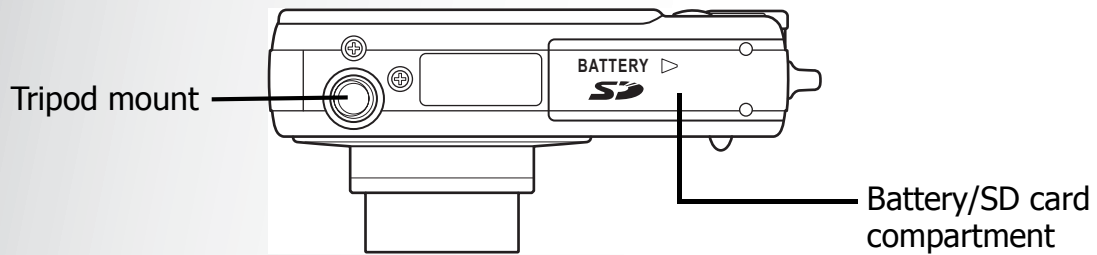

Left / Right View

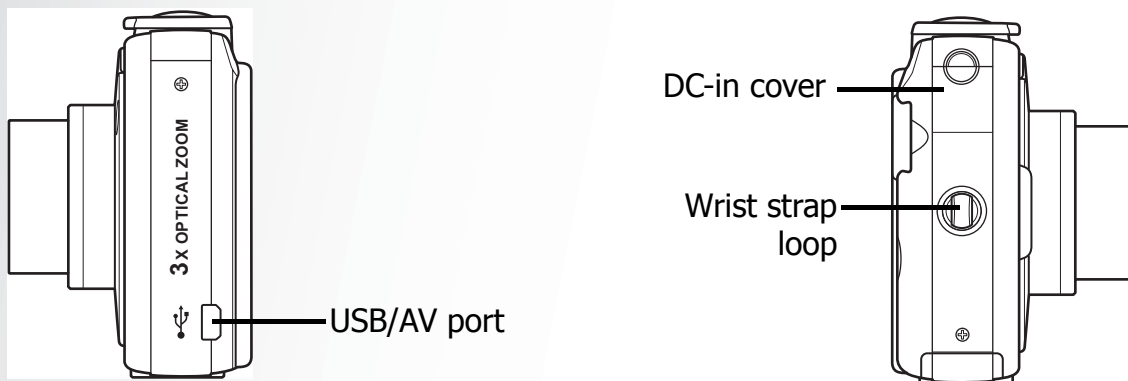



The Mode Dial

The camera is equipped with a convenient **Mode Dial** that allows you to switch between different modes with ease. The function of each mode is as follows:

Mode Type	Icon	Function
Auto		Switch to select Auto mode.
P-Mode (Program Mode)	P	Switch to select Program mode.
Portrait		Switch to select Portrait mode.
Night Portrait		Switch to select Night Portrait mode.
Landscape		Switch to select Landscape mode.
Scene	SCN	Switch to select Scene mode. Here you can set a pre-programmed Scene mode.
Video		Switch to select Video mode.

The Mode Dial

4 Introduction



Macro		Switch to enable Macro mode.
Audio		Switch to enable Audio Recording mode.
Playback		Switch to select Playback mode to review photos/videos/audio clips saved in the internal memory or on the memory card.

Navigation Buttons

The four-way navigation buttons and the **OK** button allow you to access the various options available from the On Screen Display (OSD) menu. You can configure a wide range of settings to ensure maximum results from your photos and videos. Further functions of these buttons are as follows:

Icon	Button	Function
OK	OK	<ol style="list-style-type: none">1. Confirms a selection when using the OSD menus.2. In Capture mode:<ul style="list-style-type: none">• Press to enable AF area selection when Selected Area is selected in Focus Zone submenu3. In Playback mode:<ul style="list-style-type: none">• Press to start and pause the audio/video playback• Press to stop the voice memo playback4. In USB mode:<ul style="list-style-type: none">• MSDC: N/A• PTP: Press to confirm the selection
	Up/Flash	<ol style="list-style-type: none">1. Moves up in the OSD menus.2. In Capture mode:<ul style="list-style-type: none">• Press to pan up in AF area selection• Scroll through the flash mode options (Auto, Off, Fill, and Anti Red-eye)3. In Playback mode:<ul style="list-style-type: none">• Press to pan up in magnify/crop mode• Press to move up in the thumbnail display4. In USB mode:<ul style="list-style-type: none">• MSDC: N/A• PTP: Press to scroll up through a menu

Navigation Buttons

Icon	Button	Function
	Right/Self-timer/ Burst mode	<ol style="list-style-type: none"> 1. Moves right in the OSD menus. 2. In Capture mode: <ul style="list-style-type: none"> • Press to pan right in AF area selection • Press to scroll through the Self-timer/Burst/ Multi-Burst mode 3. In Video mode: <ul style="list-style-type: none"> • Press to scroll through the Self-timer options 4. In Playback mode: <ul style="list-style-type: none"> • Press to pan right in magnify/crop mode • Press to move right in the thumbnail display • Press to navigate to next image in single up • Press to fast forward video/audio playback 5. In USB mode: <ul style="list-style-type: none"> • MSDC: N/A • PTP: Press to select the next image in This Image submenu
	Down/Screen	<ol style="list-style-type: none"> 1. Moves down in the OSD menus. 2. In Capture mode: <ul style="list-style-type: none"> • Press to pan down in AF area selection • Press to turn off extra icons on the LCD screen, press again to turn all icons back on the LCD screen 3. In Video mode: <ul style="list-style-type: none"> • Press to turn off extra icons on the LCD screen, press again to turn all icons back on the LCD screen 4. In Playback mode: <ul style="list-style-type: none"> • Press to pan down in magnify/crop mode • Press to move down in the thumbnail display • Press to show the file information 5. In USB mode: <ul style="list-style-type: none"> • MSDC: N/A • PTP: Press to scroll down through a menu

6 Introduction

Icon	Button	Function
	Left/ Quick Review	<ol style="list-style-type: none"> 1. Moves left in the OSD menus. 2. Goes up to the previous level in the OSD menus. 3. In Capture mode: <ul style="list-style-type: none"> • Press to pan left in AF area selection • Press to display the previously captured photo 4. In Video mode: <ul style="list-style-type: none"> • Press to display the first frame of the last video recorded 5. In Playback mode: <ul style="list-style-type: none"> • Press to pan left in magnify/crop mode • Press to move left in the thumbnail display • Press to navigate to previous image in single up • Press to fast rewind video/audio playback 6. In USB mode: <ul style="list-style-type: none"> • MSDC: N/A • PTP: Press to select the previous image in This Image submenu

LED Indicators

LED	LED Status	Camera Status
Power/Flash LED	Off	Power Off.
	Blue (steady)	Ready to take pictures.
	Blue (blinking)	Camera busy.
Self-timer LED/ Assist Lamp	Off	Self-timer off.
	Orange (blinking) (1Hz)	Self-timer count down, flashes during last 8 seconds.
	Orange (blinking) (4Hz)	Self-timer count down, flashes during last 2 seconds.

LED Indicators

LCD screen

The high resolution 2.4" TFT LCD screen shows all important information regarding camera settings as well as the visual image for your photo or video.

Use the **Mode Dial** to switch between screen modes. Press the **Screen**  button to switch between a **Full** display (all icons are displayed), or a **Simple** display (only mode icon and focus area are shown while other icons are hidden).

Capture/Video Mode Display



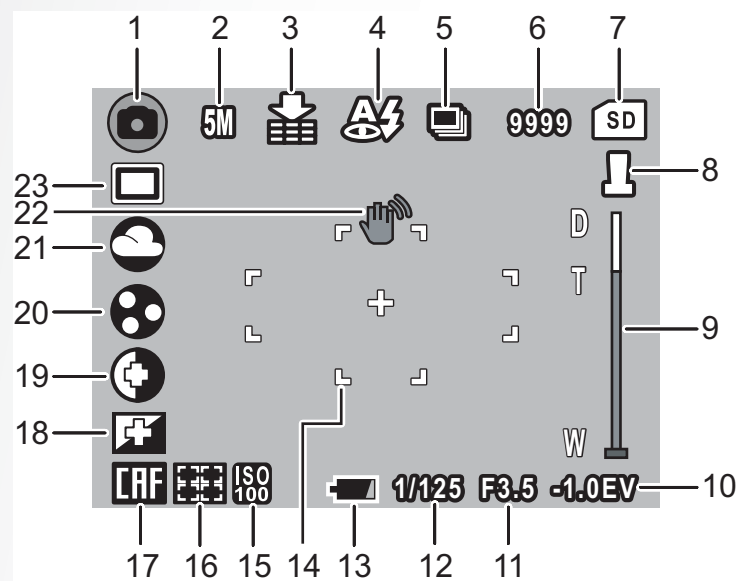



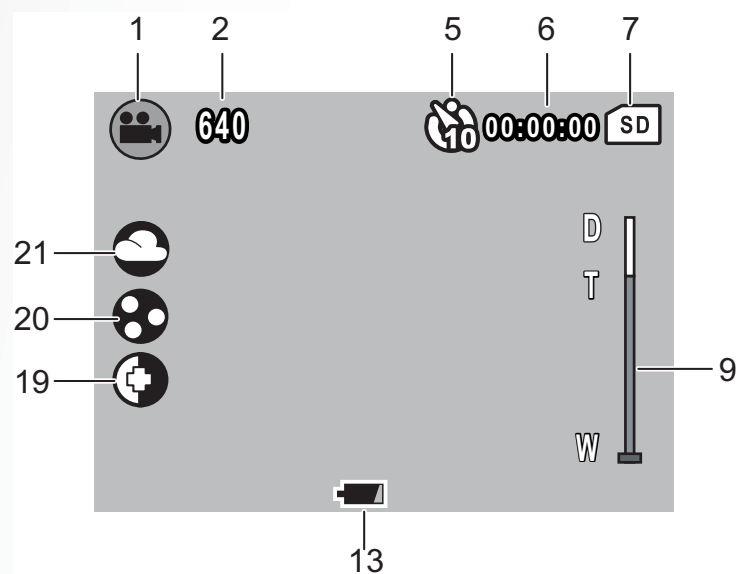











Capture Mode























Video Mode



8 Introduction



















No.	Name	Mode		Icon
1	Mode indicator	Auto		
		P-Mode		
		Portrait		
		Night Portrait		
		Landscape		
		Scene	Sport	
			Night Landscape	
			Museum	
			Snow	
			Sunset	
			Fireworks	
			Beach	
			Party	
			Copy	
		Backlight		
		Video		
		Macro		
		Audio		
		Playback		

LCD screen













2	Image Resolution	7M		
		7M 3:2		
		5M		
		3M		
		2M		
		VGA		
3	Image Quality	Best		
		Better		
		Good		
4	Flash	Auto Flash		
		Fill Flash		
		Flash Off		
		Anti Red-eye		
5	Self-timer/ Burst mode	M-Burst		
		Burst Mode		
		Self Timer	2 Seconds	
			10 Seconds	
6	Image Counter	Capture Mode	Quantity	9999
		Video Mode	Timer	00:00:00
7	Memory Interface	SD Card		
		Internal Memory		
8	Date Stamp	-		
9	Zoom Bar	-		

LCD screen

10 Introduction

10	EV Compensation	-		-1.0EV
11	Aperture Value	-		F3.5
12	Shutter Speed	-		1/125
13	Battery Indicator	Battery Low		
		Battery Insufficient		
14	AF Frame	-		-
15	ISO Speed	Auto		
		ISO 80		
		ISO 100		
		ISO 200		
		ISO 400		
		ISO 800		
		ISO 1000		
16	Focus Zone	Multi-Zone		
		Center		
		Selected Area		
17	Continues AF	-		
18	Sharpness	High		
		Normal		
		Low		
19	Contrast	High		
		Normal		
		Low		

LCD screen

20	Saturation	High	
		Normal	
		Low	
21	White Balance	Auto	
		Sunny	
		Tungsten	
		Fluorescent	
		Cloudy	
22	Camera Steady Warning	-	
23	AE Metering	Average	
		Matrix	
		Spot	

Camera Setup

Attaching the Wrist Strap

Follow these instructions to attach the wrist strap to your camera to facilitate easy carrying:

1. Insert the short loop of the strap in the strap eyelet.
2. String the larger loop of the strap through the short loop and pull tight to attach the strap to the camera.

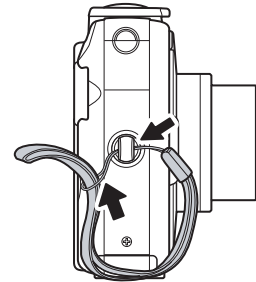

Inserting the Battery

Follow these instructions to insert the Li-ion battery into the battery compartment.

1. Open the battery compartment at the bottom of the camera.

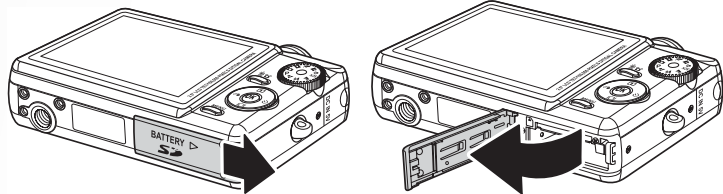

2. Insert the battery into the compartment observing the correct polarity.

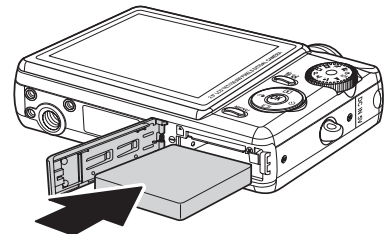

3. Close the battery compartment.

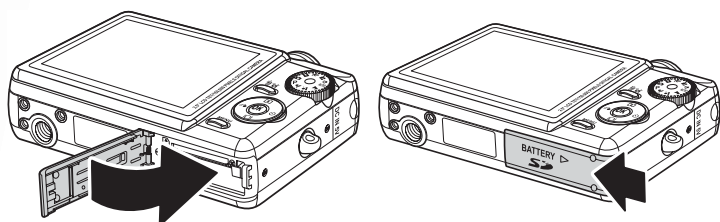

Note:

The Li-ion battery should be fully charged before using for the first time.

Inserting an SD/MMC Memory Card

The camera features 16 MB internal flash memory but you may also use an optional SD/MMC memory card for additional storage.

Follow these instructions to insert the SD/MMC card.

1. Open the battery compartment at the bottom of the camera.

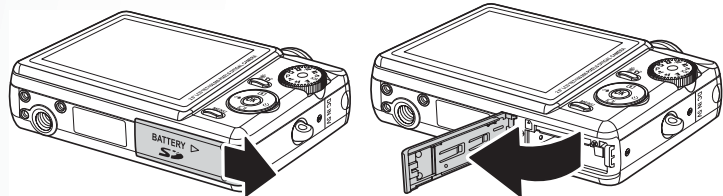

2. Insert the SD/MMC card into the memory card slot as shown.

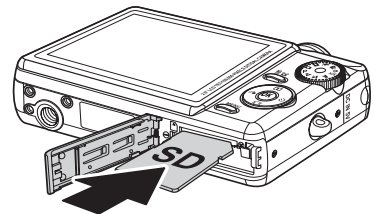

3. Close the battery compartment.

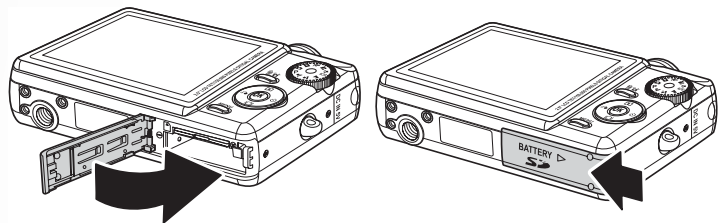

To remove the SD/MMC card, gently push the card until it pops out. Pull out the card carefully.

Charging the Battery

Insert the battery into the battery charger as shown. Connect the power supply to the charging unit and the mains supply.

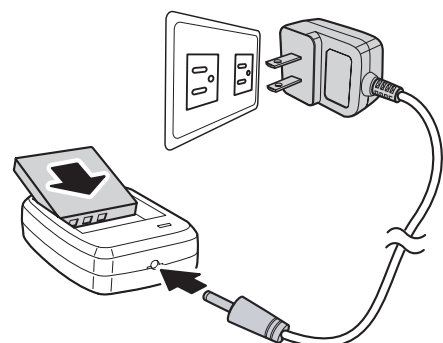

Turning On

Press and hold the **Power** button to turn on the camera. To turn off the camera, press the **Power** button again.

First Time Use

Press the **Power** button as described in "Turning On" on page 13, a welcome screen displays on the LCD screen.



If the camera is turned on for the first time, the **Language** menu pops up automatically after powering on the camera.

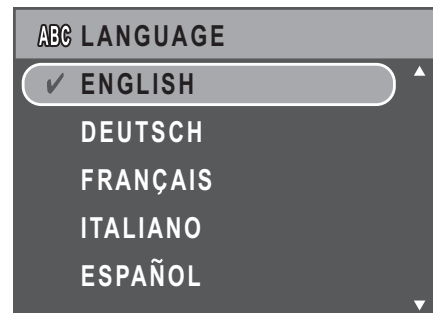

After the desired language is selected, the **Date and Time** menu pops up. Use the **Navigation Buttons** to toggle each field and adjust the value. Press the **OK** button to confirm.



Note:

If the Date and Time is reset (when running out the battery and not in use for a long period), the Date and Time setup screen displays automatically.

Getting Started

Now that you are familiar with the layout of your camera, you are ready to start taking photos and movies.

Taking your First Photo

Taking a photo with the camera is very simple.

1. Turn the camera on and turn the **Mode Dial** to **Auto**  mode.
2. Frame the shot on the LCD screen and press the **Shutter** button halfway. The camera automatically adjusts the focus and exposure. The focus bracket turns green when ready.
3. Press fully and hold the **Shutter** button to capture the image.

When a camera steady warning icon  appears, hold the camera as still as possible, as a longer exposure time (more than 1/30 second) is required.

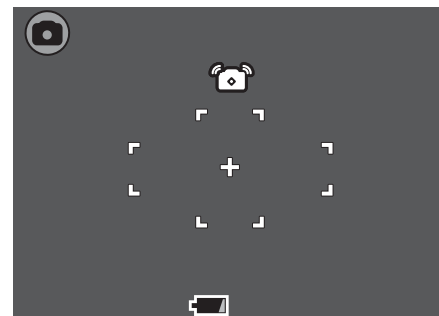

Anti-Shake Function

This function is only available in **Auto**  capture mode. Press the  button to enable the Anti-Shake function, and press again to disable it. An **Anti-Shake** icon  displays on the LCD screen when the function is activated.





Using Quick Review

To delete a photo when using Quick Review:

1. Press the **Left/Quick Review**  navigation button.
2. Press the  button, a confirmation screen is displayed. Select **This Image** to delete the photo or **Cancel** to keep it.
3. Press **OK** to confirm your selection.

You can also delete photos from the Playback menu. See "Deleting Photos/Videos/Audios" on page 29 for more detailed information.





Using Macro Mode

Macro mode is designed for close-up photography and can capture all detail even when your subject is very close to the camera. Turn the **Mode Dial** to **Macro**  mode. The Macro icon  displays on the LCD screen.

Setting the Flash Mode

You can choose from four flash modes to suit various lighting conditions.



Press the **Up/Flash**  navigation button to scroll through the four modes on the LCD screen. The flash setting remains the same for subsequent photos until you change it as described above.

-  **Auto flash:** The flash fires automatically when needed.
-  **Fill flash:** The flash always fires.
-  **Flash off:** The flash is turned off.
-  **Anti Red-eye:** The flash fires twice so as to reduce the red-eye effect.

Using the Zoom in/out Function

The camera comes equipped with 3x optical zoom and 5x digital zoom that allows you to zoom in on your subject.







To use the zoom:

1. Slide the **Zoom switch** to the right  to zoom in on your subject.
2. Slide the **Zoom switch** to the left  to zoom out from your subject.

Using the Self-timer and Burst Photography

The camera comes equipped with a self-timer which allows you to take photos after a pre-defined delay. The burst photography feature allows you to take multiple consecutive photos by pressing and holding the **Shutter** button. The multi-burst photography feature allows you to take multiple (16) consecutive VGA photos by pressing the **Shutter** button once.

To set the self-timer/burst mode:











1. Press the **Right/Self-timer**  navigation button to cycle through the self-timer ( or ) and burst photography options ( or ) on the LCD screen.
2. Once you have selected an option, frame and take your shot. In self-timer mode, the icon will flash until the time expires and the photo is taken.
3. After taking a photo, the Self-timer automatically exit. If you want to use these functions for the next photo, press the **Right/Self-timer**  navigation button again to activate the function.

Taking your First Photo

Setting the Scene Mode



The camera supports various preset modes for shooting in different environments and conditions. Each setting is configured automatically by the camera.

To select scene modes:

1. Turn the **Mode Dial** to **Scene SCN** mode to display the Scene menu options.
2. Use the **Up/Down** navigation buttons to scroll through the modes:
 - Sport 
 - Night Landscape 
 - Backlight 
 - Museum 
 - Snow 
 - Sunset 
 - Fireworks 
 - Party 
 - Beach 
 - Copy 
3. Press **OK** to confirm your selection.



Face Detection AF/AE Function

This function is only available in **Portrait**  and **Night Portrait** * capture modes. When the shutter button is pressed halfway, the face detection function is activated. When the subject's face is detected, the green focus frames appear on the LCD screen. Then the camera automatically adjusts the focus point and exposure to the optimized value.





However, when the camera fails to detect your subject's face, the camera will set the focus to **Multi-Zone** with a green or red focus frame.

Recording your First Video

You can also record video clips with the camera.



To record a video clip:

1. Turn the camera on and turn the **Mode Dial** to **Video**  mode.
2. Frame your subject using the LCD screen and press the **Shutter** button to start recording. The self-timer LED is steady on to indicate recording is in progress.
3. Press the **Shutter** button again to stop recording. If not, recording will continue until all free memory space is used.
4. In playback mode, press the **OK** button to playback the recording. Press the  /  button to delete the recording if needed.

Recording Audio Files

You can also record audio files with the camera.

To record an audio file:

1. Turn the **Mode Dial** to **Audio**  mode.
2. Press the **Shutter** button to start recording. A counting up timer will be displayed during audio recording.
3. Press the **Shutter** button again to stop recording. If not, recording will continue until all free memory space is used.
4. Start recording screen is displayed after recording is stopped.
5. In playback mode, press the **OK** button to playback the recording. Press the  /  button to delete the recording if needed.

Recording Voice Memos

You can add a **1-minute** voice memo to an image right after it's taken.

To record a voice memo:

1. Hold the **Shutter** button to start recording and release the **Shutter** button to stop recording.
2. While recording, the selected image is shown on the LCD screen.
3. The elapsed time screen shows the length of a voice memo.

Note:

A Voice Memo can also be added in Playback mode.

Capture Settings

This section describes the various settings you can modify to get better results when taking photos and video clips.

The Capture Menu

To access the Capture menu:

1. Turn the **Mode Dial** to select **Auto**  or **P-Mode** **P**.
2. Press the **MENU** button to display menu options.
3. Press **Up/Down** navigation buttons to highlight an option and press **OK** button to confirm.

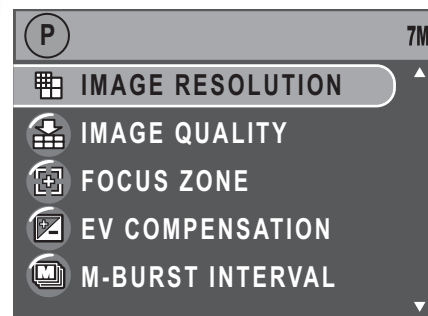
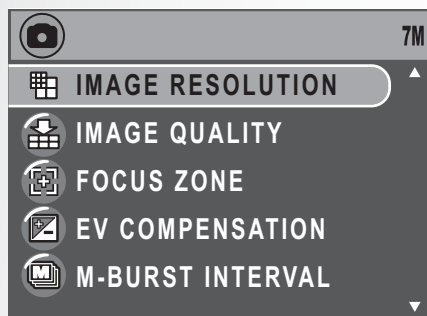

Refer to the following sections for more detailed information about each setting.

Image Resolution

The **Image Resolution** setting refers to the size of the image in pixels. Use the **Up/Down** navigation buttons to select from the options. Six settings for image resolution are available:

- 7M (3072 x 2304)
- 7M 3:2 (3072 x 2048)
- 5M (2576 x 1932)
- 3M (2048 x 1536)
- 2M (1600 x 1200)
- VGA (640 x 480)



20 Capture Settings

Image Quality

The **Image Quality** setting refers to the compression ratio of the JPG. The higher the image quality, the less the image compression ratio but more memory space is required. Use the **Up/Down** navigation buttons to select from the options. Three settings for image quality are available:

- Best (default)
- Better
- Good



Focus Zone

The **Focus Zone** setting allows you to select the number of zones the camera will focus on when taking a photo. Use the **Up/Down** navigation buttons to select from the options. Three settings for focus zone are available:

- Multi-Zone (default)
- Center
- Selected Area: The new setting is applied to the Live View image each time **Up/Down** navigation buttons are pressed. Press the **OK** button to return to the **Capture** menu and save the current setting, which will take effect until it is changed again.

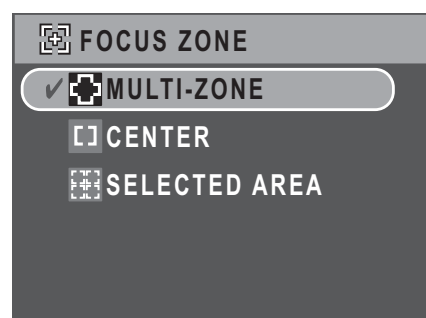

EV Compensation

The **EV Compensation** menu allows you to adjust the exposure or amount of light that enters the lens while capturing photos or videos. Use this feature to lighten or darken the image when the brightness between the subject and background is not balanced or when the subject occupies only a small part of the photograph. Use a positive (+) EV compensation for spotlighted subjects, especially against dark backgrounds or scenes with low reflectivity, such as green or dark foliage.

Use the **Up/Down** navigation buttons to modify the value. This setting can be modified from -2.0 to +2.0 in a 0.3 increment/decrement.

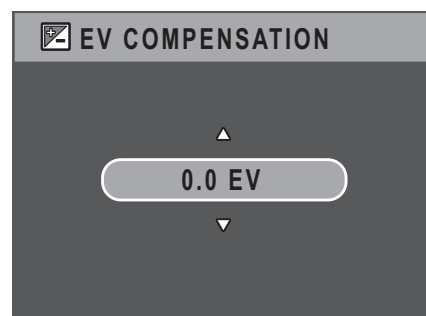

The Capture Menu

M-Burst Interval

The **M-Burst Interval** setting allows you to adjust the burst interval when the multi-burst function is enabled. Use the **Up/Down** navigation buttons to select from the options.

- 1/30 Sec (default)
- 1/15 Sec
- 1/7.5 Sec

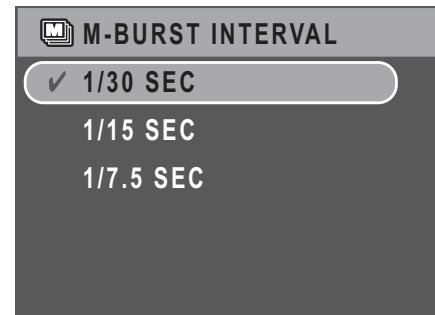

White Balance

The **White Balance** setting allows you to adjust the camera setting according to the ambient white light when shooting. White balance represents the degree of coolness of the light. If the light has a yellowish or reddish tinge, it is said to be warm; if it has a bluish tinge, it is said to be cool. You can select the setting and preview it on screen before confirming your choice. Use the **Up/Down** navigation buttons to select from the options. Five white balance settings are available:

- Auto (default)
- Sunny
- Tungsten
- Fluorescent
- Cloudy

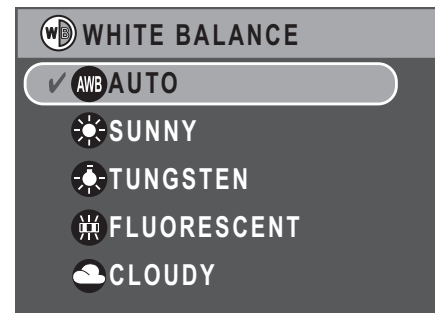

ISO Speed

The **ISO Speed** setting allows you to adjust the CCD light-sensitivity. Use the **Up/Down** navigation buttons to select from the options. Seven ISO settings are available:

- Auto (default)
- ISO 80
- ISO 100: For outdoor photography in bright sunlight.
- ISO 200: For outdoor or indoor photography in bright light.
- ISO 400: For indoor photography or low light environments.
- ISO 800: For moving object photography or low light environments without using flash.
- ISO 1000: For moving object photography or low light environments without using flash

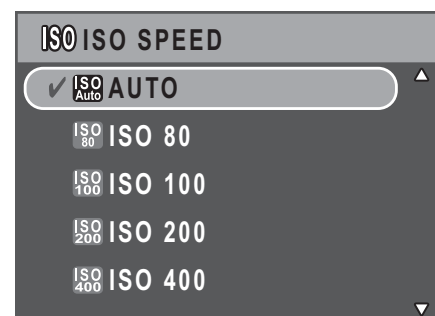

22 Capture Settings

AE Metering

AE Metering allows you to select the area of the subject or frame by which the camera measures light. Use the **Up/Down** navigation buttons to select from the options. Three AE metering settings are available:

- Matrix (default): Camera metering is set for evaluating 16 zones of objects with intelligent weighting in the frame.
- Spot: Camera metering is set for the brightness of a single object in the center of the frame.
- Average: Camera metering is set for the average brightness of objects in the frame.

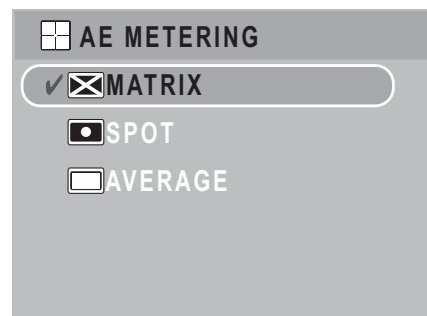

Color

The **Color** setting allows you to take photos and apply different colors or color tones for an artistic effect. Use the **Up/Down** navigation buttons to select from the options. Four color settings are available:

- Vivid
- Color (default)
- Black & White
- Sepia

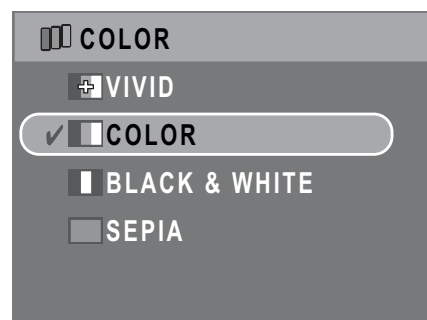

Sharpness

The **Sharpness** setting allows you to enhance the finer details of your photos. Use a higher setting for very sharp photos and a lower setting for a soft-toned photo. Use the **Up/Down** navigation buttons to select from the options. Three sharpness settings are available:

- High
- Normal (default)
- Low

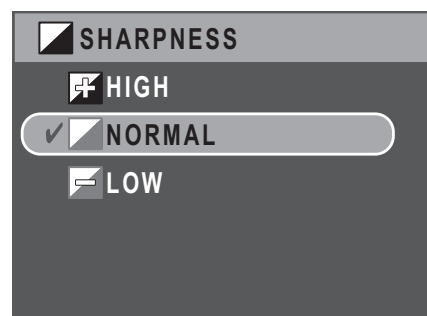

Saturation

The **Saturation** setting allows you to adjust the saturation of the colors in your photos. Use a high saturation setting for rich colors and a lower saturation setting for more natural tones. Use the **Up/Down** navigation buttons to select from the options. Three saturation settings are available:

- High
- Normal (default)
- Low

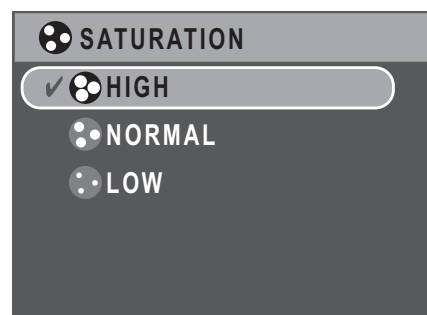

The Capture Menu

Contrast

The **Contrast** setting allows you to adjust the contrast of your photos. Use the **Up/Down** navigation buttons to select from the options. Three contrast settings are available:

- High
- Normal (default)
- Low

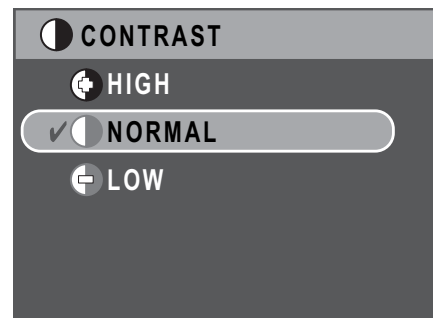

Setup

See "The Setup Menu" on page 35 for more details on the setup menu options.

Video Capture Menu

To access the video menu:

1. Turn the **Mode Dial** to **Video**  mode.
2. Press the **MENU** button to display the menu options.
3. Use the **Up/Down** navigation buttons to highlight an option and press the **OK** button to confirm. Refer to the following sections for more detailed information about each setting.

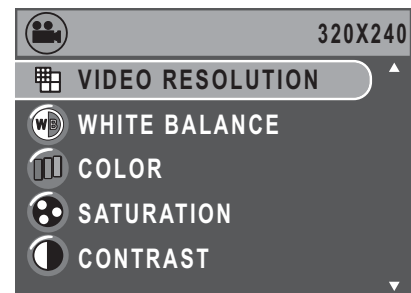

Video Resolution

The **Video Resolution** setting allows you to adjust the resolution at which your videos are recorded. Two video size settings are available:

- 640X480
- 320X240

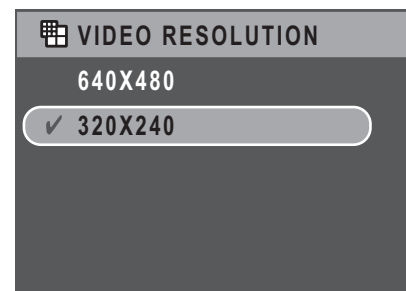

White Balance

See "White Balance" on page 21 for more details on the setup menu options.

Color

See "Color" on page 22 for more details on the setup menu options.

Saturation

See "Saturation" on page 22 for more details on the setup menu options.

Contrast

See "Contrast" on page 23 for more details on the setup menu options.

24 Capture Settings

Setup

See “The Setup Menu” on page 35 for more details on the setup menu options.

Video Capture Menu

Photo, Video & Audio Playback

Playback Mode Display



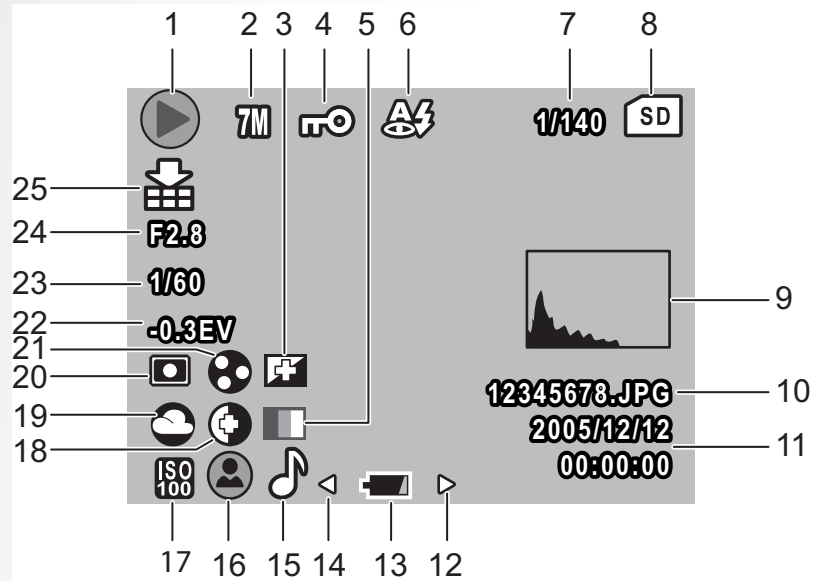



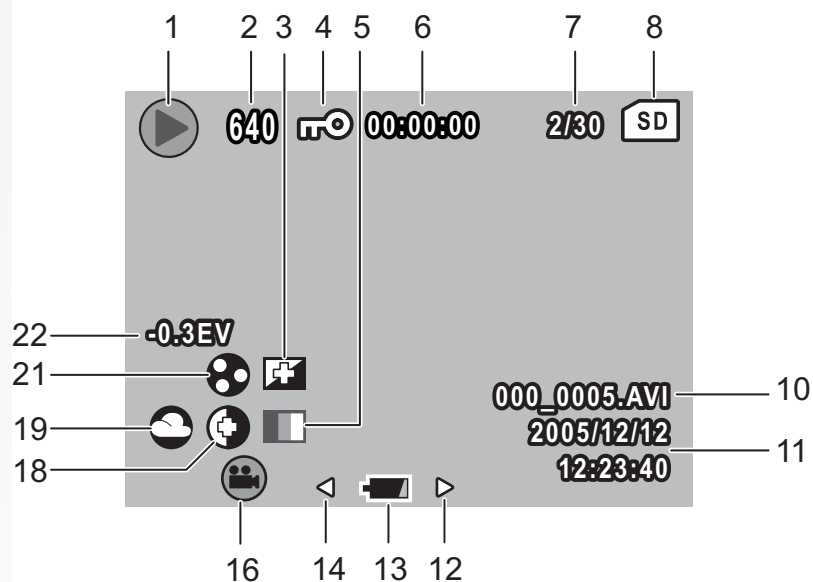



Photo Playback





Video Playback



26 Photo, Video & Audio Playback

No.	Name	Icon
1	Playback mode	
2	Image resolution	Photo mode: 7M 32 5M 3M 2M VGA Video mode: 640 (640x480), 320 (320x240)
3	Sharpness	
4	Protect	
5	Color mode	
6	Flash mode	Photo mode: AZ ⚡ ⚡⚡ ⚡⚡⚡ Video mode: 00:00:00 (Length of the video clip.)
7	Quantity	1/140, 2/30
8	SD card / Internal memory	
9	Histogram	
10	File Name	Photo mode: 12345678.JPG Video mode: 000_0005.AVI
11	Date and Time	2005/12/12 00:00:00
12	Next	Move to next item.
13	Battery status	
14	Previous	Move to previous item.
15	Voice memo	
16	Mode icons	Please see "Capture/Video Mode Display" on page 7 for detailed information.
17	ISO Speed	ISO Auto ISO 80 ISO 100 ISO 200 ISO 400 ISO 800 ISO 1000
18	Contrast	
19	White balance	

Playback Mode Display

20	AE Metering	
21	Saturation	
22	EV Compensation	-0.3EV
23	Shutter speed	1/60
24	Aperture value	F2.8
25	Image quality	

Viewing Photos/Videos on the LCD Screen

To view your photos and video files on the LCD screen:

1. Turn the **Mode Dial** to **Playback**  mode. The most recent photo or video clip is displayed.
2. Use the **Right/Left** navigation buttons to scroll through photos and video clips.
3. Press the **OK** button to begin playback of a video clip.
4. Press the **Left/Right** navigation buttons at any time during playback to skip to the previous/next photo or video.
5. Press the **OK** button and press the **Left/Right** navigation buttons to fast-rewind/fast-forward during video playback.
6. Press the **OK** button at any time during playback to pause the video.
7. After the video clip finishes playing, the LCD screen displays the first frame of the clip.

Viewing M-Burst Photos

To view your multi-burst photos on the LCD screen:

1. Turn the **Mode Dial** to **Playback**  mode. The most recent photo or video clip is displayed.
2. Use the **Right/Left** navigation buttons to scroll through photos.
3. When reviewing a multi-burst image, it will be displayed from the 1st frame to the 16th frame at 2 frames/per second like a slideshow.
4. To stop the M-Burst slideshow, press **Left/Right** navigation buttons and skip to the previous/next image.

Listening to Audio Files

To listen to audio files:

1. Turn the **Mode Dial** to **Playback**  mode. The most recent photo or video clip is displayed.
2. Use the **Left/Right** navigation buttons to scroll through the files.
3. Press the **OK** button to begin playback of an audio file.
4. Press the **Left/Right** navigation buttons at any time during playback to skip to the previous/next audio file.
5. Press the **OK** button and press the **Left/Right** navigation buttons to fast-rewind/fast-forward during audio playback.
6. Press the **OK** button at any time during playback to pause.

Listening to Voice Memo

A voice memo displays simultaneously when playback an image with voice memo.

To stop a voice memo while reviewing an image, press **OK** button.

To skip to previous/next image, press **Left/Right** navigation buttons.

Viewing Photos/Videos on your TV

To view images stored on the camera on your TV, you must connect via the A/V port on the side of the camera. To connect your camera to a TV:

1. Turn on the camera and make sure that the camera's video out format is set to the same as that of the TV. See "Video Out" on page 37 for more information.
2. Connect the USB/AV 3-in-1 cable to the USB port on the camera.
3. Connect the other end of the cable to the TV's AV input port.

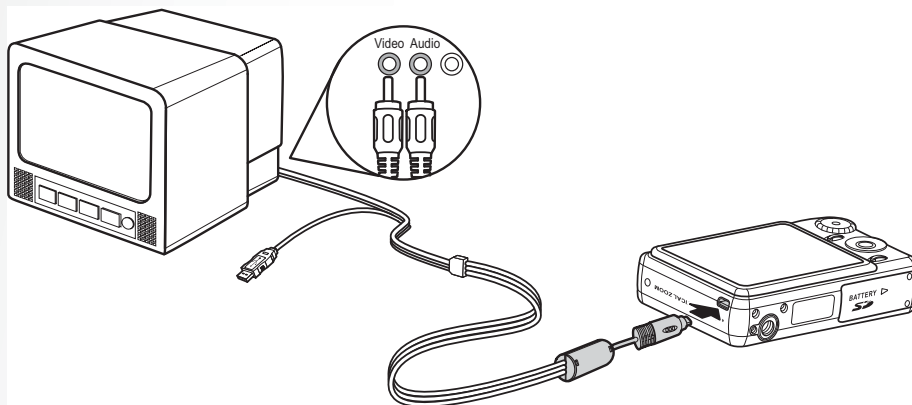



4. The LCD screen turns blank and all images and video clips are displayed on the TV screen. Follow the same steps described in "Viewing Photos/Videos on the LCD Screen" on page 27.

Zooming In During Playback

The camera's zoom feature can also be used during Playback. This allows you to view photos in greater detail.



To zoom in on saved photos:

1. Slide the **Zoom In**  and **Zoom Out**  switches to zoom in and out of the photo/video.
2. Use the navigation buttons to pan across the image.
3. When zoomed in on a photo, press the **OK** button to crop the image. When zoomed out to the maximum, the LCD screen will display all photos and videos as a series of thumbnails.

Deleting Photos/Videos/Audios

The **Delete** function allows you to remove unwanted files stored on internal memory or a memory card.

To delete a photo/video/audio:

1. Press the  /  button to display the **Delete** menu.
2. Press the **Up/Down** navigation buttons and the **OK** button to select from the three available options:
 - Cancel: Select to cancel the action and exit to the main menu.
 - This Image: Select to delete the current image.
 - All Images: Select to delete all images.



Using the Playback Menu

Access the Playback menu to view further information, configure printing settings, view a slideshow, or delete photos or movies.

To access the Playback menu:

1. Turn the **Mode Dial** to select **Playback**  Mode.
2. Press the **MENU** button to display the menu options.
3. Use the **Up/Down** navigation buttons to highlight an option and press the **OK** button to confirm.



DPOF

DPOF (Digital Print Order Format) allows you to specify the number of copies of a certain image that you want to print at a later date.

Use this function to tag pictures stored in your memory card with print information. You can tag all pictures to be printed or just the current picture. You can also select how many copies print and whether to include the date and time.

When all images to be printed are tagged, remove the memory card and take it to a photographic shop for printing, or use it with a DPOF compatible printer.

To set DPOF:

1. Press the **MENU** button to select **DPOF** from the menu.
2. Press the **Up/Down** navigation buttons and the **OK** button to select from the available options:
 - This Image: Select to print the current image.
 - All Images: Select to print all images.
 - Exit: Select to exit to the main menu.
3. Use the **Up/Down** navigation buttons to set the number of copies you wish to print.

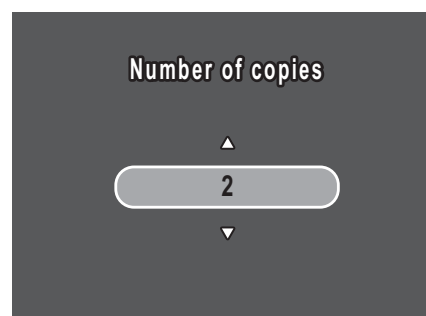

Slideshow

The **Slideshow** function allows you to view all stored photos in a continuous sequence.

To view a slideshow:

1. Press the **MENU** button to select **Slideshow** from the menu.
2. Press the **Up/Down** navigation buttons and the **OK** button to select from the available options:
 - Start: Select to start the slideshow.
 - Interval: Select to set the interval time between each photo during the slideshow. Use the **Up/Down** navigation buttons to set a value in seconds.
 - Loop: Select to enable/disable a continuous loop of the slideshow. Select **On** or **Off** (default) from the submenu.
 - Exit: Select to exit to the main menu.

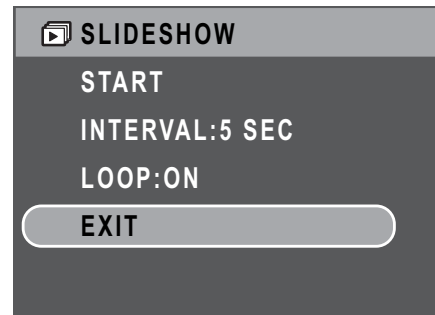

Resize

The **Resize** function allows you to change the image resolution.

To resize a photo:

1. Press the **MENU** button to select **Resize** from the menu.
2. Press the **Up/Down** navigation buttons and the **OK** button to select the resize ratio you require: 6M, 4M, 2M, 1M, and VGA.
3. Select **Exit** to return to the main menu.

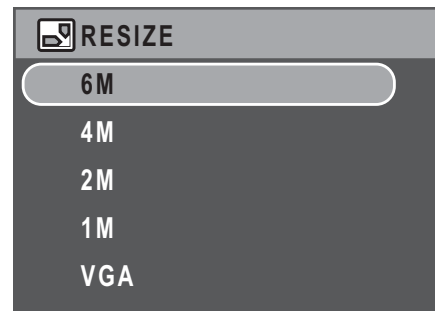

Note: It is only possible to scale-down image resolutions. If the current image resolution is VGA, this menu item is disabled in the Resize submenu. The ratio of the image (4:3 or 3:2) remains unchanged after resizing.

- This function only supports native pictures
- Cropped images cannot be resized
- If there is not sufficient storage space, images cannot be resized
- If the SD/MMC card is locked, images cannot be resized
- VGA images cannot be resized

32 Photo, Video & Audio Playback

Rotate

The **Rotate** function allows you to change the orientation of a saved photo.

To rotate an image:

1. Press the **MENU** button to select **Rotate** from the menu.
2. Press the **Left/Right** navigation buttons and the **OK** button to rotate the select image.
 - OK: Select to rotate the image.
 - Exit: Select to exit to the main menu.



Protect

You can lock a photo or video to protect it from being accidentally erased.

To lock a photo or video:

1. Press the **MENU** button to select **Protect** from the menu.
2. Press the **OK** button to confirm.
3. A key icon displays at the top of the screen to indicate the photo/video is now locked.



Using the Playback Menu

Red-Eye Compensation

The **Red-Eye Compensation** function allows you to perform red-eye reduction on a saved photo.

To remove red-eye from a photo:

1. Press the **MENU** button to select **Red-Eye Compensation** from the menu.
2. The camera starts processing. Press the **Up/Down** navigation buttons and the **OK** button to select from the three available options:
 - Overwrite: Select to overwrite the original image.
 - New file: Select to save the fixed image to a new file.
 - Cancel: Select to discard the changes to the image and return to the main menu.

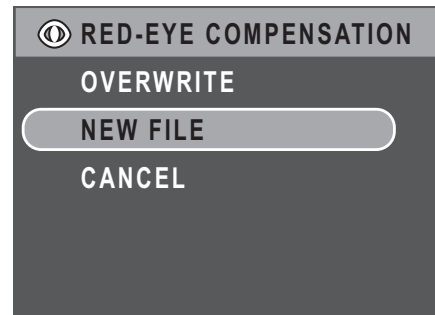

Note:

1. If the image is protected, the fixed image will be saved as a new file directly without asking.
2. If a failure occurs, the message "Cannot Processing Correctly" appears on the screen.

Move

The **Move** function allows you to move images stored in internal memory to a memory card.

To move an image:

1. Press the **MENU** button to select **Move** from the menu.
2. Press the **Up/Down** navigation buttons and the **OK** button to select from the three available options:
 - This Image: Select to move the current image to a memory card.
 - All Images: Select to move all images to a memory card.
 - Exit: Select to exit to the main menu.



Note: The Move function is only available when you choose internal memory as the storage media and an SD card has been inserted into the camera.

Transferring Photos/Videos to your PC

To transfer photos and videos to your PC:

Use the software CD to install the camera driver. Follow the on-screen instructions to complete the installation.

Connect the camera's USB port to a free USB port on your PC using the USB cable.

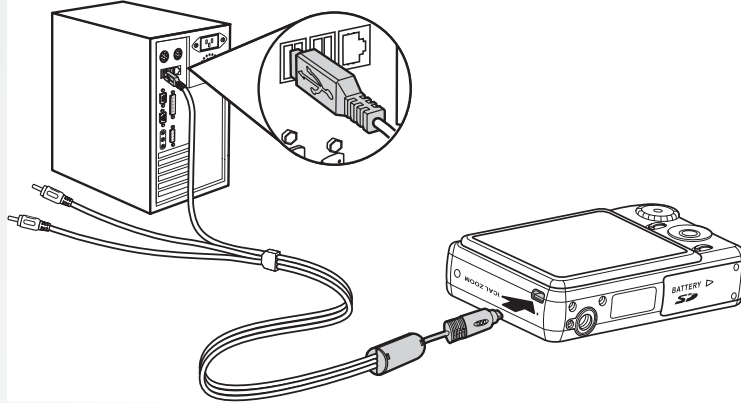

The camera's internal memory and/or SD/MMC card appear as removable drives in the file manager. Copy the files from the drives to the directory on your PC.

Use ArcSoft PhotoImpression and ArcSoft VideoImpression (provided on the software CD) to view or edit the photos and videos respectively.

Camera Settings

The Setup Menu

The setup menu, available in capture and playback modes, allows you to configure the camera's general settings and according to your preferences.

To access the setup menu:

1. Press the **MENU** button when in **Playback** or any of the capture modes.
2. Select **Setup** from the menu. The submenu appears.
3. Use the **Up/Down** navigation buttons to scroll through the options and press the **OK** button to enter further submenus and to confirm your selection. Refer to the following sections for more detailed information about each setting.

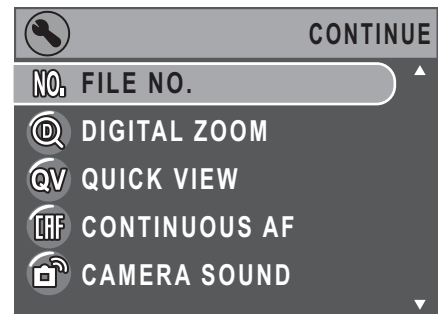

File Number

The **File No.** setting allows you to reset all file numbers assigned to each of the files on your camera. Select **Reset** to reset or **Continue** to set the file numbers in continuous order.

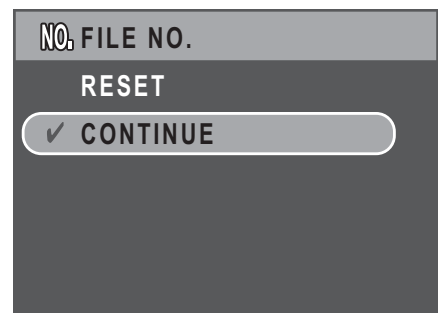

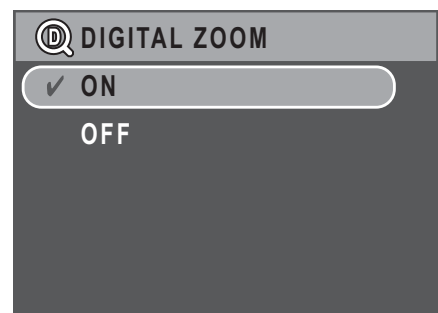

Digital Zoom

The **Digital Zoom** setting allows you to turn the digital zoom function on or off. Select **On** to enable the function or **Off** (default) to disable it.



36 Camera Settings

Quick View

The **Quick View** setting allows you to view the photo that you have just taken. Once you have taken your photo, it displays on the LCD screen. If you are not satisfied with the result, you can press the / button to delete the photo immediately. Select **On** (default) to enable the function or **Off** to disable it.

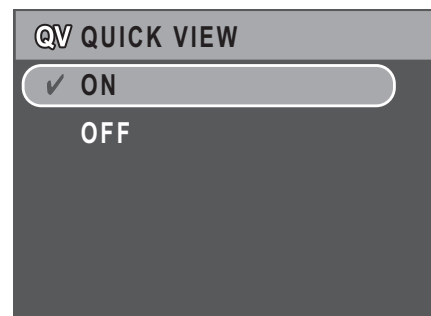

Note:

The Quick View function is not available in Burst and M-Burst modes.

Continuous AF

The **Continuous AF** setting allows you to turn the continuous auto focus function On or Off. Select **On** to enable the function or **Off** (default) to disable it.

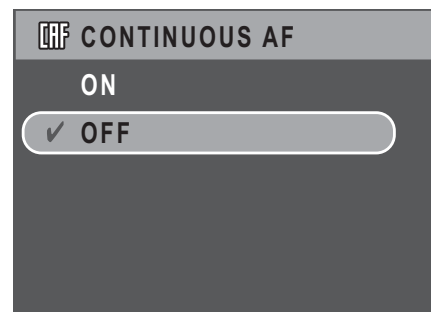

Camera Sound

The **Camera Sound** setting allows you to adjust the camera sound level. Three options are available:

- Off
- Low (default)
- High

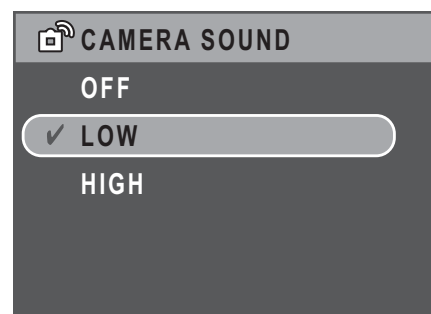

Auto LCD Off

The **Auto LCD Off** setting allows you to adjust the length of time that the LCD screen will remain lit before turning off to save battery power. Three options are available:

- Off (default)
- 30 sec
- 1 min

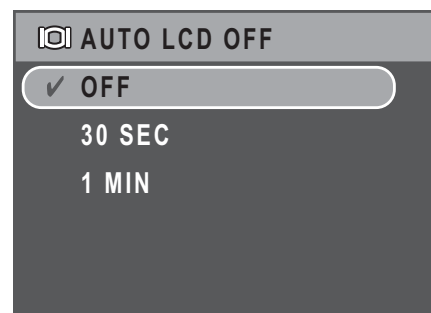

The Setup Menu

Auto Power Off

The **Auto Power Off** setting allows you to adjust the length of time after which the camera will power down when inactive. Use **Up/Down** navigation buttons to select from the menu options. Two options are available:

- 5 min (default)
- 2 min

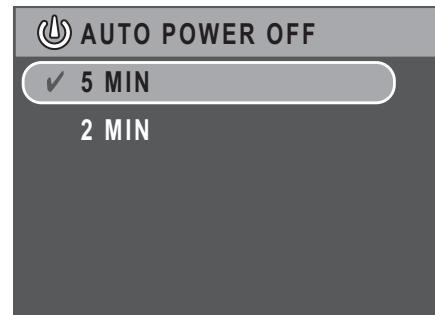

Video Out

The **Video Out** setting allows you to adjust the video output, depending on the type of your TV. Use **Up/Down** navigation buttons to select from the menu options. Two options are available:

- NTSC (default)
- PAL

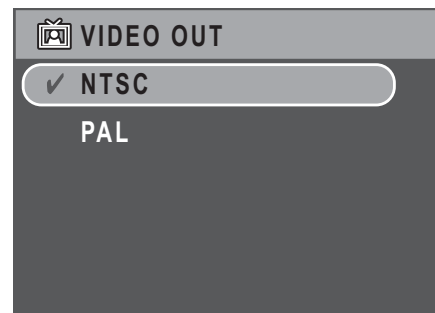

USB Mode

The **USB Mode** setting allows you to select the transfer method between your camera and your PC. Two options are available:

- PTP (PictBridge Print): When the camera is connected to a printer by a USB cable which supports Pictbridge, it can directly print images stored on the media. For details on PTP function, please See "PictBridge Print (PTP)" on page 40.
- MSDC (default): The camera is set up to act as a mass storage device, allowing for only transfer of files between your camera and PC.

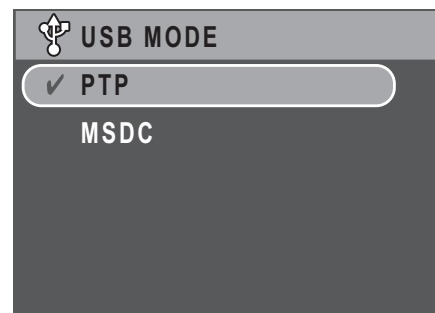

38 Camera Settings

Date Stamp

The **Date Stamp** setting allows you to adjust the format in which the date will appear on each photo or video. You can also deactivate this function if you wish. Setting a date stamp allows for easy sorting and the date will appear on the photo when printed. Use **Up/Down** navigation buttons to select from the menu options. Four options are available:

- Off (default)
- YYYY MM DD: year-month-date format
- MM DD YYYY: month-date-year format
- DD MM YYYY: date-month-year format

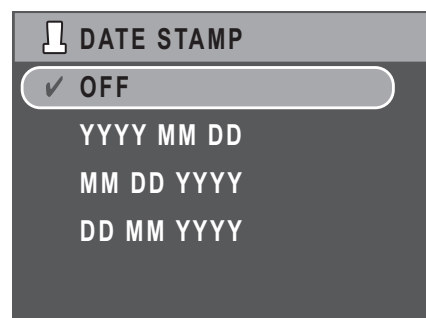

Date and Time

The **Date and Time** setting allows you to set or adjust the date and time on your camera. To set or adjust the date and time:

- Press the **Left/Right** navigation buttons to select the **Year** field.
- Press the **Up/Down** navigation buttons to adjust the **Year** value.
- In the same way, select the **Month**, **Date**, **Hour** and **Minute** fields and adjust them accordingly.



Language

The **Language** setting allows you to choose which language the OSD menu uses. Scroll down the list and select your language. Use **Up/Down** navigation buttons to select from the menu options.

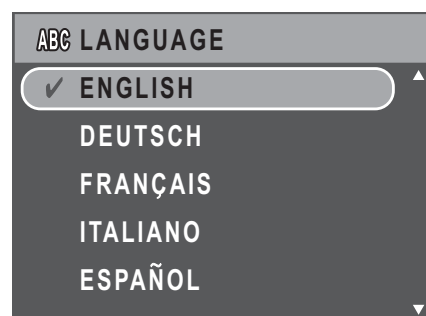
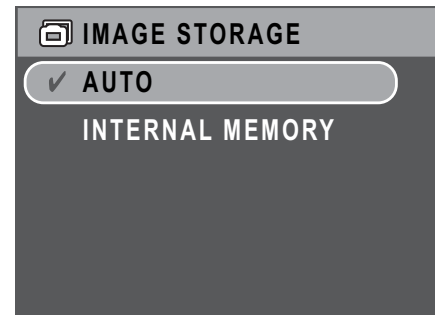

Image Storage

The **Image Storage** setting allows you to specify where photos and video clips will be stored. The camera features 16 MB internal memory but you can also insert an SD/MMC card (See “Inserting an SD/MMC Memory Card” on page 13 for more details). Two options are available:

- Auto (default): When selected, the camera chooses the storage medium automatically. If an SD/MMC card is inserted in the camera, all photos and videos are stored on the card. If an external card is not detected, all photos and videos are stored in the internal memory.
- Internal Memory: All photos and videos are stored in the internal memory.



Format

The **Format** setting allows you to erase all data in the internal memory or on the SD/MMC card. Use **Up/Down** navigation buttons to select from the menu options. Three options are available:

- Memory Card (default): All data on the SD/MMC will be formatted.
- Internal Memory: All data in the internal memory will be formatted.
- Exit: Cancel format action.

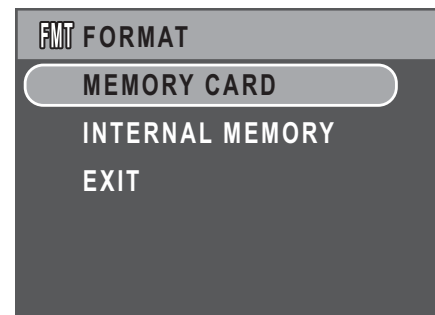

Reset

The **Reset** setting allows you to reset the camera to the original factory default settings. This means all modifications you have made to the camera settings will be cleared.

Once selected, the **Reset** screen displays a confirmation message. Select **Yes** to proceed with the reset or **Exit** (default) to cancel.

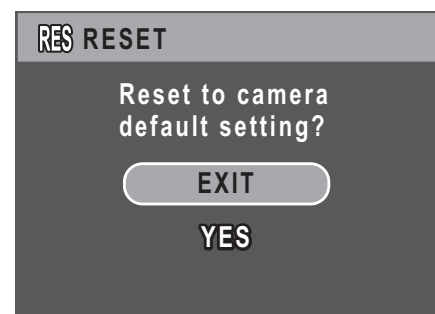

Voice Memo

The **Voice Memo** setting allows you to record a voice memo when a photo is taken. Select **On** to enable the Voice Memo function or **Off** (default) to disable it.

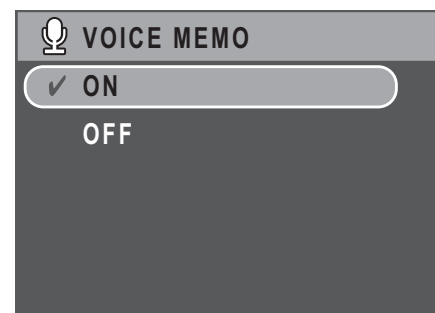

PictBridge Print (PTP)

The **PTP** function allows you to print images captured by the camera directly without connecting the camera to a PC.

If the camera is not connected to a PTP compliant printer, an error message displays on the LCD screen. To enable PTP function, see “USB Mode” on page 37 for detailed information. If the USB mode is not set at PTP, an error message displays on the LCD screen.

When a PTP compliant printer is connected to the camera, the **Printer Connecting** screen displays on the LCD screen. The Print menu pops up automatically.

Use the **Up/Down** navigation buttons to select an option and press the **OK** button to confirm.



Image Storage

See “Image Storage” on page 39 for detailed information.

This Image

Print the selected image with the current setting.

1. Use the **Up/Down** navigation buttons to select **This Image** from the options and press the **OK** button to confirm. Use the **Left/Right** navigation buttons to select previous/next file.
2. Press **Up/Down** navigation buttons to set the number of copies.
3. Press **Up/Down** navigation buttons again to select the paper size.
 - Default Size
 - 4" x 6"
 - Letter
 - A4
4. Press **Up/Down** navigation buttons to Continue or Cancel the action.

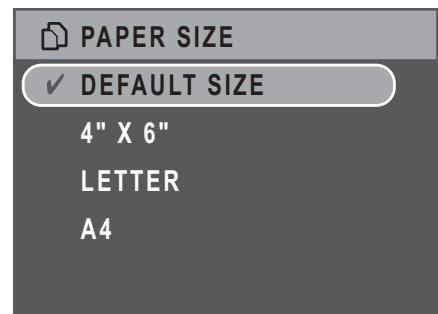
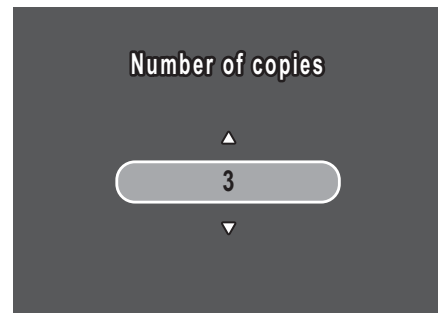

42 Camera Settings

Index Print

Use this function to print all images in index format.

1. Press **Up/Down** navigation buttons to select the Paper size.

- Default Size
- Letter
- A4

2. Press **Up/Down** navigation buttons to set the number of copies. After the number of copies is set, press **Up/Down** navigation buttons again to continue or cancel the action.

DPOF Image

See “DPOF” on page 30 for detailed information.

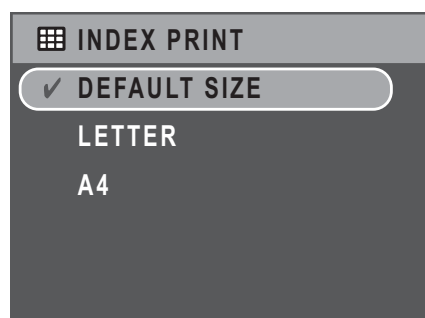

All Images

Print all images saved in memory.

1. Use **Up/Down** navigation buttons to select **All Images** from the options and press the **OK** button to confirm.
2. Press **Up/Down** navigation buttons to set the number of copies.
3. Press **Up/Down** navigation buttons to select the Paper size.
 - Default Size
 - 4" x 6"
 - Letter
 - A4
4. Press **Up/Down** navigation buttons to select Continue or Cancel this action.

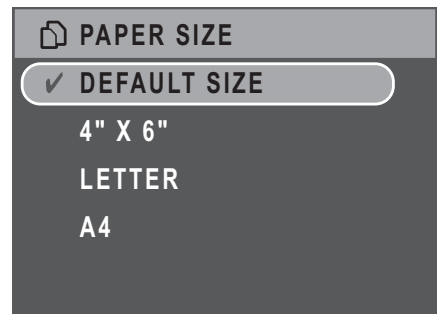
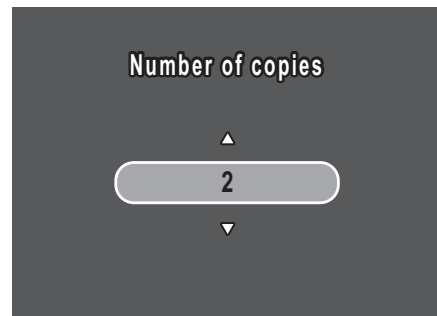

Specifications

General	Resolution / Image Type	7M Pixels / 1/2.5" CCD
	LCD	2.4"TFT, 110,000 Pixels
	Dimensions	92.9(W)x60.4(H)x22.2(D)mm
	Exterior Casing	Plastic Housing
Optics	Aperture	Wide: F2.8 Tele: F4.9
	Optical Zoom	Up to 3x
	Digital Zoom	Up to 5x
	Focal Length	Wide(W): 35mm, Tele(T): 106mm
	Focus Mode	Normal: 50cm to infinity Macro: 10cm ~ 50cm
	Shutter Speed	8 ~ 1/1500 Sec.
	Viewfinder	None
	Field of View	99% by LCD
	Camera Features	Auto Power Off / Time Out
ISO Equivalent		Auto, ISO80/100/200/400/800/ 1000
Internal Memory		16MB internal, SD/MMC removable card slot
Flash Modes		Auto, Fill, Anti Red-eye, Off
Shooting Mode		Movie, Auto, P-Mode, Portrait, Night Portrait, Landscape, Macro, Preset Scenes
Tripod Mount		1/4" Standard
Preset Scene		Sport, Sunset, Museum, Night Landscape, Snow, Fireworks, Copy, Backlight, Beach, Party

Resolution Image	Image File Formats	Still Image: JPEG (Exif2.2)
	Image Quality Mode	Still Image: 3072x2304, 3072x2048(3:2), 2576x1932, 2048x1536, 1600x1200, 640x480 Movie Mode: 640x480@30fps, 320x240@30fps
	Quality Levels	Best, Better, Good
Capture Features	DPOF	Version 1.1
	Erase Protection	Yes
	Exposure Compensation	Selectable +/-2.0EV with 0.3 EV steps
	Sharpness	High, Normal, Low
	Color	B&W, Sepia, Vivid, Color
	Metering	Average, Matrix, Spot
	Focus	Multi-Zone Single-Zone: Center, Selected area
	Flash Range	2.5m@wide
	Lens Thread	None
	Anti-Shake	Yes, High ISO
	Aperture Priority	No
	Shutter Priority	No
	Drive Mode	Single Mode, Burst Mode, Multi- Burst (VGA@16 shots)
	Quick Delete	Yes
	Quick View	Yes
	Quick Review	Yes
	Self Timer	2 or 10 seconds
Playback Magnify	Up to 6X (10 steps)	
White Balance	Auto, Sunny, Tungsten, Fluorescent, Cloudy	

46 Specifications

Audio/Video	Audio/Video Out	PAL, NTSC
	Stream to SD/MMC	Yes
	Speaker	Yes, Mono
	Movie File Format	AVI
	Movie Length	Unlimited as long as space is available on the SD/MMC card
	Microphone	Yes, Mono
	Audio Recording	Yes, Wave format
Power	Battery	NP40
	Battery Charger	Included
	Battery Life (Alkaline)	CIPA 140 images
Capability	Camera Interface	USB 2.0 full speed
	Host Platform	Windows 98/98SE/2000/XP
Standards	Operating Temperature	0°C ~ 40°C
	Language	English, German, French, Italian, Spanish, Russian, Portuguese, Simplified Chinese, Traditional Chinese, Arabic, Turkish, Korea, Thai

Troubleshooting

Problem	Action
Camera does not turn on	<ul style="list-style-type: none"> • The batteries may be exhausted. Charge or replace the batteries. • The batteries are installed incorrectly. Re-insert the batteries observing the correct polarity.
Camera turns off automatically	Press any button to turn on the camera.
LCD turns off automatically	Press any button to turn on the LCD.
Empty battery icon is displayed on the LCD after which camera turns off	Batteries are exhausted. Replace the batteries.
LCD screen displays 'Card Requires Formatting'	Memory card format not recognized. Re-format the memory card.
LCD screen displays 'Card is Full'	Memory card is full. Replace the memory card with a new one or delete unnecessary images from the existing card.
LCD screen displays 'Card is locked'	The card is protected by a protect switch mechanism. Move the switch to the unlock position.
Insufficient memory space to complete request	Insufficient space in memory to rotate an image. Delete unnecessary images.
No image displays on the TV screen	Incorrect TV-out type was selected. Set correct TV-out type to match your TV system.
Insufficient space on the card	Delete unnecessary images.

SANYO Electio Co., Ltd.
Made in China

Free Manuals Download Website

<http://myh66.com>

<http://usermanuals.us>

<http://www.somanuals.com>

<http://www.4manuals.cc>

<http://www.manual-lib.com>

<http://www.404manual.com>

<http://www.luxmanual.com>

<http://aubethermostatmanual.com>

Golf course search by state

<http://golfingnear.com>

Email search by domain

<http://emailbydomain.com>

Auto manuals search

<http://auto.somanuals.com>

TV manuals search

<http://tv.somanuals.com>