

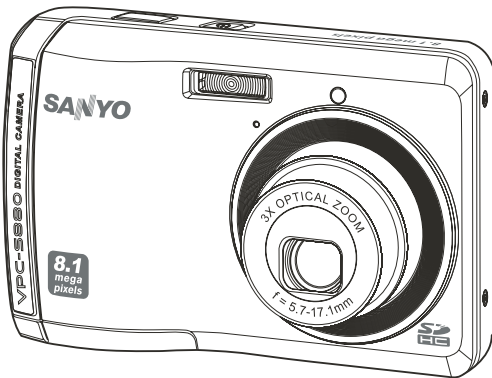

INSTRUCTION MANUAL

VPC-S880

Digital Camera



Please read these instructions carefully before using the camera.
Keep this manual in a safe place for later reference.

FCC STATEMENT

This device complies with Part 15 of the FCC Rules. Operation is subject to the following two conditions:

- (1) This device may not cause harmful interference, and
- (2) This device must accept any interference received, including interference that may cause undesired operation.

Note:

This equipment has been tested and found to comply with the limits for Class B digital devices, pursuant to Part 15 of the FCC rules. These limits are designed to provide reasonable protection against harmful interference in a residential installation. This equipment generates uses and can radiate radio frequency energy and, if not installed and used in accordance with the instructions, may cause harmful interference to radio communications. However, there is no guarantee that interference will not occur in a particular installation. If this equipment does cause harmful interference to radio or television reception, which can be determined by turning the equipment off and on, the user is encouraged to try to correct the interference by one or more of the following measures:

- Reorient or relocate the receiving antenna.
- Increase the separation between the equipment and receiver.
- Connect the equipment into an outlet on a circuit different from that to which the receiver is connected.
- Consult the dealer or an experienced radio/TV technician for help.

Use of shielded cable is required to comply with Class B limits in Subpart B of Part 15 of the FCC rules.

Do not make any changes or modifications to the equipment unless otherwise specified in the manual. If such changes or modifications should be made, you could be required to stop operation of the equipment.

Notice

If static electricity or electromagnetism causes data transfer to discontinue midway (fail), restart the application or disconnect and connect the communication cable (USB, etc.) again.

READ THIS FIRST

Trademark Information

- Microsoft® and Windows® are U.S. registered trademarks of Microsoft Corporation.
- Pentium® is a registered trademark of Intel Corporation.
- Macintosh is a trademark of Apple Inc.
- SD™ is a trademark.
- SDHC™ is a trademark.



- Other names and products may be trademarks or registered trademarks of their respective owners.

Product Information

- Product design and specifications are subject to change without notice. This includes primary product specifications, software, software drivers, and user's manual. This User Manual is a general reference guide for the product.
- The product and accessories that come with your camera may be different from those described in this manual. This is due to the fact that different retailers often specify slightly different product inclusions and accessories to suit their market requirements, customer demographics, and geographical preferences. Products very often vary between retailers especially with accessories such as batteries, chargers, AC adapters, memory cards, cables, pouches, and language support. Occasionally a retailer will specify a unique product color, appearance, and internal memory capacity. Contact your dealer for precise product definition and included accessories.
- The illustrations in this manual are for the purpose of explanation and may differ from the actual design of your camera.
- The manufacturer assumes no liability for any errors or discrepancies in this user manual.

SAFETY INSTRUCTIONS

Read and understand all **Warnings** and **Cautions** before using this product.

Warnings

If foreign objects or water have entered the camera, turn the power off and remove the batteries.

Continued use might cause fire or electric shock. Consult the store of purchase.



If the camera has fallen or its case has been damaged, turn the power off and remove the batteries.

Continued use might cause fire or electric shock. Consult the store of purchase.



Do not disassemble, change or repair the camera.

This might cause fire or electric shock. For repair or internal inspection, ask the store of purchase.



Do not use the camera in areas near water.

This might cause fire or electric shock. Take special care during rain, snow, on the beach, or near the shore.



Do not place the camera on inclined or unstable surfaces.

This might cause the camera to fall or tilt over, causing damage.



Keep the batteries out of the reach of children.

Swallowing the batteries might cause poisoning. If the batteries are accidentally swallowed, immediately consult a physician.



Do not use the camera while you are walking, driving or riding a motorcycle.

This might cause you to fall over or result in traffic accident.



Cautions

Insert the battery paying careful attention to the polarity (+ or -) of the terminals.

Inserting the battery with its polarities inverted might cause fire and injury, or damage to the surrounding areas due to the battery rupturing or leaking.



Do not fire the flash close to anyone's eyes.

This might cause damage to the person's eyesight.



Do not subject the LCD monitor to impact.

This might damage the glass on the screen or cause the internal fluid to leak. If the internal fluid enters your eyes or comes into contact with your body or clothes, rinse with fresh water. If the internal fluid has entered your eyes, consult a physician to receive treatment.



A camera is a precision instrument. Do not drop it, strike it or use excessive force when handling the camera.

This might cause damage to the camera.



Do not use the camera in humid, steamy, smoky, or dusty places.

This might cause fire or electric shock.



Do not remove the battery immediately after long period of continuous use.

The battery becomes hot during use. Touching a hot battery might cause burns.



Do not wrap the camera or place it in cloth or blankets.

This might cause heat to build up and deform the case, resulting in fire. Use the camera in a well-ventilated place.



Do not leave the camera in places where the temperature may rise significantly, such as inside a car.

This might adversely affect the case or the parts inside, resulting in fire.



Before you move the camera, disconnect cords and cables.

Failure to do this might damage cords and cables, resulting in fire and electric shock.



Warning:

TO PREVENT THE RISK OF FIRE OR ELECTRIC SHOCK, DO NOT EXPOSE THIS APPLIANCE TO RAIN OR MOISTURE

FOR AMERICAN USERS

The following advisory is included in accordance with the laws of the State of California (USA):

WARNING:

This product contains chemicals, including lead, known to the States of California to cause cancer, birth defects or other reproductive harm. ***Wash hands after handling.***

- This equipment has been tested and found to comply with the limits for a Class B digital device, pursuant to Part 15 of the FCC Rules. These limits are designated to provide reasonable protection against harmful interference in a residential installation. This equipment generates, uses and can radiate radio frequency energy and, if not installed and used in accordance with instructions, may cause harmful interference to radio communications. However, there is no guarantee that interference will not occur in a particular installation. If this equipment does cause harmful interference to radio or television reception, which can be determined by turning the equipment off and on, the user is encouraged to try to correct the interference by one or more of the following measures:
 - * Reorient or relocate the receiving antenna.
 - * Increase the separation between the equipment and receiver.
 - * Connect the equipment into an outlet on a circuit different from that to which the receiver is connected.
 - * Consult the dealer or an experienced radio/TV technician for help.
- Changes or modifications not expressly approved by the party responsible for compliance could void the user's authority to operate the equipment.

FOR CANADIAN USERS

- This Class B digital apparatus complies with Canadian ICES-003

FOR EU USERS



Note:

- This symbol mark and recycle system apply to EU countries and do not apply to countries in other areas of the world.

Your SANYO product is designed and manufactured with high quality materials and components which can be recycled and reused.

This symbol means that electrical and electronic equipment, at their end-of-life, should be disposed of separately from your household waste.

Please dispose of the equipment at your local community waste collection/recycling centre.

In the European Union there are separate collection systems for used electrical and electronic products.

Please help up to conserve the environment we live in!

Manufacturer and Address

SANYO Electric Co., Ltd.

5-5, Keihan-hondori, 2-chome,

Moriguchi City, Osaka, Japan

Authorized Representative and Address

SANYO FISHER Sales (Europe) GmbH

Stahlgruberring 4, D-81829 Munich, Germany

Symbols used in this manual



- Points giving some extended instructions or special points to pay attention to.

You may find the answers to questions or problems concerning camera operation in the sections "Troubleshooting".

FCC information



Tested To Comply
With FCC Standards

FOR HOME OR OFFICE USE

Declaration of Conformity

Model number: VPC-S880

Trade Name: SANYO

Responsible party: SANYO FISHER COMPANY

Address: 21605 Plummer Street
Chatsworth, California 91311

Telephone No.: (818) 998-7322

This device complies with Part 15 of the FCC Rules. Operation is subject to the following two conditions:

- (1) this device may not cause harmful interference, and
- (2) this device must accept any interference received, including interference that may cause undesired operation.

Canadian ICES-003 information

This class B digital apparatus complies with Canadian ICES-003.

Notes on Battery Usage

When you use the batteries, carefully read and strictly observe the **Safety Instructions** and the notes described below:

- Use only the specified batteries.
- Avoid extremely cold environments as low temperatures can shorten the battery life and reduce camera performance. Therefore Ni-MH rechargeable batteries are highly recommended.
- When you are using a new rechargeable batteries or rechargeable batteries that have not been used for an extended period of time (the batteries that passed the expiry date are exception), it may affect the number of images that can be captured. Therefore, to maximize their performance and lifetime, we recommend that you fully charge the batteries and discharge them for at least one complete cycle before use.
- The batteries may feel warm after a long period of continuous use of the camera or the flash. This is normal and not a malfunction.
- The camera may feel warm after a long period of continuous use. This is normal and not a malfunction.
- If the batteries are not to be used for a long period of time, remove them from the camera to prevent leakage or corrosion and store them after no battery power is left. Stored for a long time in a fully charged condition, their performance may be impaired.
- Always keep the battery terminals clean.
- There is a risk of explosion if the batteries are replaced by an incorrect type.
- Dispose of used batteries according to the recycle instructions.
- Charge the rechargeable batteries fully before using for the first time.
- Never use batteries of different types (together) or mix old and new batteries.
- Never use manganese batteries.
- To prevent short-circuiting or fire, keep the batteries away from other metal objects when carrying or storing.

CONTENTS

10 INTRODUCTION

- 10 Overview
- 10 Package Contents

11 GETTING TO KNOW YOUR CAMERA

- 11 Front View
- 12 Rear View
- 13 LCD Monitor Display

15 GETTING START

- 15 Preparation
- 16 Initial Settings

18 CAPTURE MODE

- 18 Capturing Images
- 19 Recording Shots using Face Detection Technology
- 20 Setting the Scene Mode
- 22 Panorama Mode

23 VIDEO MODE

- 23 Recording Video Clips
- 23 Playing Back Video Clips

24 PLAYBACK MODE

- 24 Playing Back Still Images
- 25 Thumbnail Display
- 25 Removing Red-eye
- 26 Protecting Images
- 27 Erasing Images

28 MENU OPTIONS

- 28 Capture Menu
- 30 Video Menu
- 31 Playback Menu
- 32 Setup Menu

34 TRANSFERRING FILES TO YOUR COMPUTER

- 34 Downloading Your Files

35 EDITING SOFTWARE INSTALLATION

36 SPECIFICATIONS

37 APPENDIX

- 37 Possible Number of Shots
- 38 Troubleshooting
- 39 Connecting to a PictBridge Compatible Printer

INTRODUCTION

Overview

Congratulations on your purchase of the new digital camera.

Capturing high-quality digital images is fast and easy with this state-of-the-art smart camera. Equipped with an 8.1-megapixel sensor, this camera is capable of capturing images with a resolution of up to 3264 x 2448 pixels.

Package Contents

Carefully unpack your camera and ensure that you have the following items:

Common Product Components:

- Digital camera
- Software CD-ROM
- USB cable
- Camera strap
- Camera pouch
- 2 x AA size batteries
- Instruction manual

Optional Accessory:

- SD/SDHC memory card



- Accessories and components may vary by retailer.

GETTING TO KNOW YOUR CAMERA

Front View

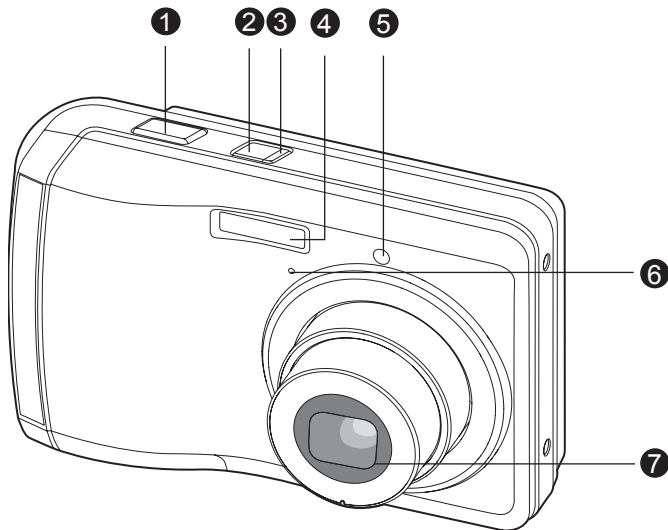

1. Shutter button

2. Power button

3. Status LED

4. Flash

5. Self-timer LED

6. Microphone

7. Lens

Rear View

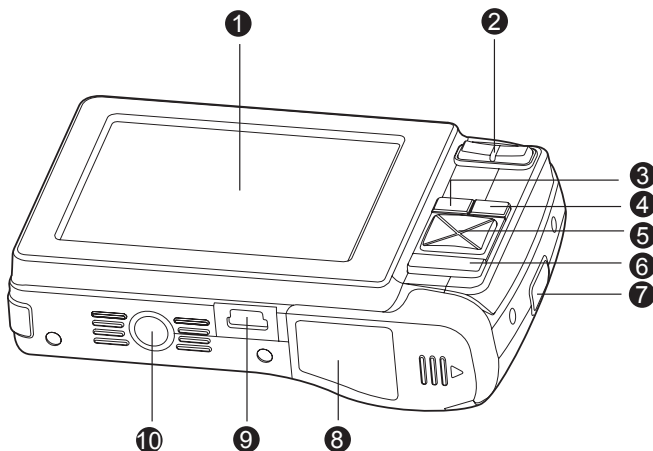

1. LCD monitor

2. Zoom in button
 Zoom out button

3. **MENU** Menu button

4. **MODE** Mode button
 Capture mode
 Video mode
 Playback mode

5. 4-way control button
▲ Up button
 Focus button
▶ Right button
⚡ Flash button
▼ Down button
 Self-timer/Delete button
◀ Left button
 Backlight/Exposure compensation button

6. **SET/DISPLAY** Set / Display / Scene mode button

7. Strap holder

8. Battery / Memory card cover

9. USB connector

10. Tripod socket

LCD Monitor Display

Capture Mode

1. Scene mode
2. Flash mode
 - [] Auto Flash
 - [] Red-eye Reduction
 - [] Forced Flash
 - [] Flash Off
3. Zoom status
4. Battery condition
 - [] Full battery power
 - [] Medium battery power
 - [] Low battery power
 - [] No battery power
5. Storage media
 - [] Internal memory (no card)
 - [] SD/SDHC memory card
6. Capture Mode
 - [] Single
 - [] Cont.
 - [] AEB
7. Image size resolution
 - [**8M**] 8M (3264 x 2448 pixels)
 - [**6M**] 6M (2816 x 2112 pixels)
 - [**4M**] 4M (2272 x 1704 pixels)
 - [**2M**] 2M (1600 x 1200 pixels)
 - [**0.3M**] 0.3M (640 x 480 pixels)
8. Image quality
 - [] Fine
 - [] Normal
 - [] Economy
9. Available number of shots
10. Main focus area
11. Date
12. Self-timer icon
 - [] 2 sec.
 - [] 10 sec.
 - [] 10+2 sec.
13. ISO
14. [] Backlight correction
 [] Exposure compensation
15. Slow shutter warning
 * Poor lighting conditions.
 Images will be vulnerable to vibration.
16. Metering
 - [] Average
 - [] Spot
17. W.Balance
 - [**Blank**] Auto
 - [] Incand.
 - [] F1
 - [] F2
 - [] Daylight
 - [] Cloudy
 - [] Manual
18. Focus setting
 - [**Blank**] Auto focus
 - [] Face detection
 - [] Macro
 - [] Infinity

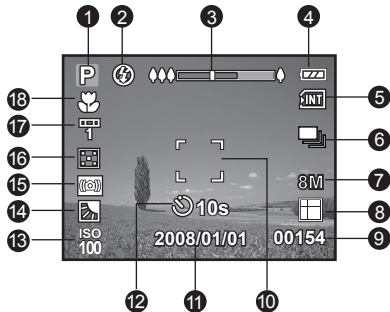

Video mode []

1. Mode icon
2. Zoom status
3. Battery condition
4. Storage media
5. Video resolution
6. Available recording time/Elapsed time
7. Main focus area
8. Date
9. Self-timer icon
10. Focus setting

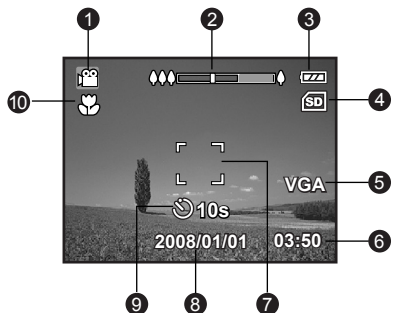

Playback mode [] - Still image playback

1. Mode icon
2. File number
3. Folder number
4. Protect icon



Playback mode [] - Video playback

1. Total recorded time
2. Video status bar
3. Elapsed time
4. File number
5. Folder number
6. Protect icon
7. Mode icon
8. Play mode

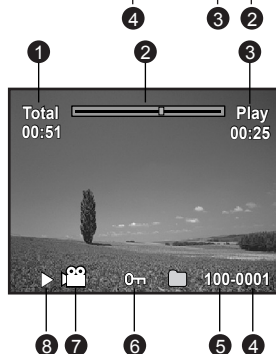

GETTING START

Preparation

1. Attach the camera strap.

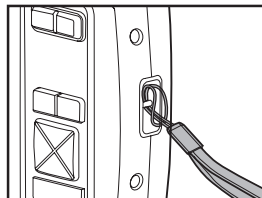

2. Open the battery/memory card cover.
3. Load the supplied batteries with correct orientation as shown.

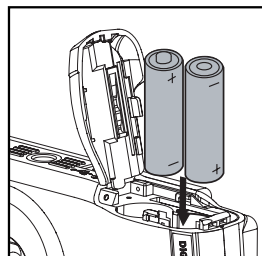

4. Insert an SD/SDHC memory card (Optional).
 - The camera has 16MB internal memory (12MB available for image storage), but you can load an SD/SDHC memory card to expand the camera's memory capacity.
 - Be sure to format the memory card with this camera before its initial usage.
5. Close the battery/memory card cover and make sure it is locked securely.

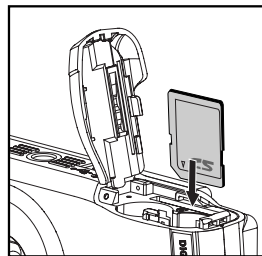

- To prevent valuable data from being accidentally erased from an SD/SDHC memory card, you can slide the write protect tab (on the side of the SD/SDHC memory card) to "LOCK".
- To save, edit, or erase data on an SD/SDHC memory card, you must unlock the card.
- To prevent damaging of an SD/SDHC memory card, be sure to turn off the power when inserting or removing the SD/SDHC memory card. If inserting or removing the SD/SDHC memory card with the power on, the camera will automatically turn off.
- Be careful not to drop the batteries when opening or closing the battery cover.

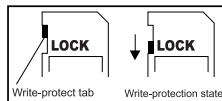

Initial Settings

Setting the Date and Time

The date/time needs to be set if and when:

- Camera is turned on for the first time.
- Camera is turned on after leaving the camera without the battery for an extended period of time.

Follow these steps to set the correct date and time:

1. Press the Power button to turn the power on.
2. Press the **MODE** button to set the camera mode to [📷] / [📷].
 - In the [📷] Capture mode, the LCD monitor display is followed by the scene mode setting.
3. Press the **MENU** button
4. Select [Setup] with the ▶ button.
5. Select [Date/Time] with the ▲ / ▼ buttons, and press the **SET/DISPLAY** button.
6. Select the date type with the ▲ / ▼ buttons, and press the **SET/DISPLAY** button.
 - Select the item's field with the ◀ / ▶ buttons and adjust the value for the date and time with the ▲ / ▼ buttons.
 - The time is displayed in 24-hour format.
 - After confirming all settings are correct, press the **SET/DISPLAY** button.
7. To exit from the [Setup] menu, press the **MENU** button.



Choosing the Language

Specify in which language menus and messages are to be displayed on the LCD monitor.

1. Set the camera mode to [📷] / [📹].
 - You may set the language from the playback mode.
2. Press the **MENU** button.
3. Select [Setup] menu with the **▶** button.
4. Select [Language] with the **▲** / **▼** buttons, and press the **SET/DISPLAY** button.
 - The Language setting screen will be displayed.
5. Select the displayed language with the **▲** / **▼** buttons, and press the **SET/DISPLAY** button.
 - The setting will be stored.



Formatting the Memory Card or Internal Memory

This utility formats the internal memory (or memory card) and erases all stored images and data.

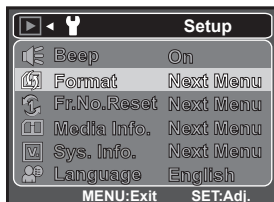

1. Set the camera mode to [📷].
2. Press the **MENU** button
3. Select [Setup] menu with the **▶** button.
4. Select [Format] with the **▲** / **▼** buttons, and press the **SET/DISPLAY** button.
5. Select [Execute] with the **▲** / **▼** buttons, and press the **SET/DISPLAY** button.
 - To cancel formatting, select [Cancel] and press the **SET/DISPLAY** button.



CAPTURE MODE

Capturing Images

Your camera is equipped with a 2.8" full color TFT LCD monitor to help you compose images, playback recorded images/video clips or adjust menu settings.

1. Press the Power button to turn the power on.
 - The status LED lights green and the camera is initiated.
2. Set the camera mode to [].
3. Compose your image in the LCD monitor.
 - Pressing the  button zooms in on the subject, and enlarges the subject on the LCD monitor.
 - Pressing the  button provides a wider angle image.
4. Press the shutter button.
 - Pressing the shutter button down halfway automatically focuses and adjusts the exposure, and pressing the shutter button down fully captures the images.
 - The focus area frame turns blue when the camera is in focus and the exposure is calculated.
 - When the focus or exposure is not suitable, the frame of the focus area turns yellow.

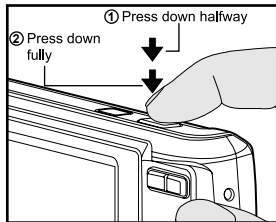

Recording Shots using Face Detection Technology

Face Detection Technology can identify and focus on the human faces in the image. This advanced function simultaneously detects up to 5 human faces regardless of their position in the scene.

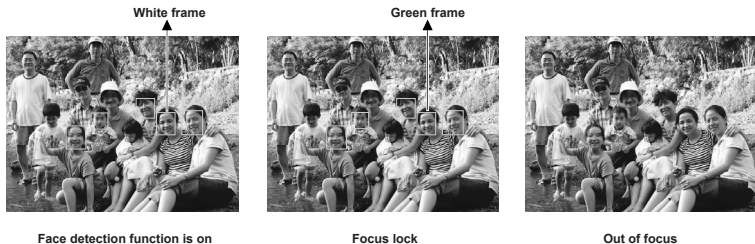

1. Set the camera mode to [].
2. Toggle the button until [] icon appears on the LCD monitor.
 - The white frame is identified as the “top priority” face (main focus frame), and gray ones around the other faces.
3. Press the shutter button halfway down to lock the focus.
 - The main focus frame simultaneously turns green.
 - If the “top priority” face is out of focus, the main focus frame turns red.
4. Press the shutter button down fully to capture your image.



- Subjects that are not suitable with this function:
 - a. A person wearing glasses, sunglasses, or face covered with hat or hair.
 - b. A person turning sideways.

Setting the Scene Mode





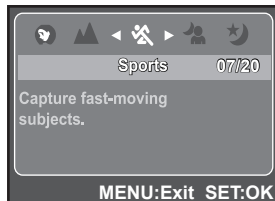
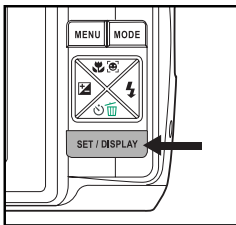



By simply selecting one of the following 20 modes, you can capture the image with the most appropriate settings.











1. Set the camera mode to [].
2. Press the **SET/DISPLAY** button.



3. Select the desired scene mode with the ◀ / ▶ buttons, and press the **SET/DISPLAY** button.
4. Compose the image and press the shutter button.

The table below will help you choose the appropriate scene mode:

Scene mode	Description
 Program AE	This mode allows you to manually set parameters other than the shutter speed and the aperture value.
 Panorama	Select this mode when you want to capture a series of shots then stitch them together with software to make a single photo.
 Anti-Shake	This mode minimizes the influences of hand shaking when you want to capture an image.
 Portrait Man	Select this mode when you want to capture an image that makes a man stand out against a blurred background.
 Portrait Lady	Select this mode when you want to capture an image that makes a lady stand out against a blurred background.
 Landscape	Select this mode when you want to capture an image with infinity focus, hard sharpness and high saturation.
 Sports	Select this mode when you want to capture fast-moving subjects.
 Night Portrait	Select this mode when you want to capture people with an evening or night scene background.
 Night Scene	Select this mode when you want to capture dark scenes such as night views.

Scene mode	Description
 Candlelight	Select this mode when you want to capture photos of candlelit scene, without spoiling the ambience.
 Fireworks	Select this mode when you want to capture fireworks clearly with optimal exposure. The shutter speed becomes slower, so using a tripod is recommended.
 Text	Select this mode when you want to capture an image that contains black and white subjects like printed documents.
 Sunset	Select this mode when you want to capture a sunset. This mode helps keep the deep hues in the scene.
 Sunrise	Select this mode when you want to capture a sunrise. This mode helps keep the deep hues in the scene.
 Splash Water	Select this mode when you want to capture photos of splashing water.
 Flow Water	Select this mode when you want to capture the soft flowing water.
 Snow	Select this mode when you want to capture clear snow scenes without darkened subjects and bluish tint.
 Beach	Select this mode when you want to capture bright beach scenes and sunlit water surfaces.
 Pets	Select this mode when you want to capture your pets. Shoot from their eye level.
 User Setting	This mode allows you to manually set your favorite parameters and these settings will be memorized.

Panorama Mode

This mode is designed to make it easier to take a series of shots then stitch them together with software to make a single photo. You can capture a photographic subject that won't fit into a single frame, such as a landscape, and stitch it together later with a program such as Cool 360 or Photoshop application.

1. Set the camera mode to [].
2. Press the **SET/DISPLAY** button.
3. Select [Panorama] with the ◀ / ▶ buttons, and press the **SET/DISPLAY** button.
4. Shoot the first image.
 - The next image appears beside the previous image.
5. Orient the camera so that the second frame overlaps a small portion of the photographic subject of the first image and press the shutter button to capture the next image.
6. Follow the same steps to capture subsequent images in the sequence.
7. Finish the sequence by pressing the **SET/DISPLAY** button after the last image has been recorded.

VIDEO MODE

Recording Video Clips

This mode allows you to record video clips at a resolution of 320 x 240 / 640 x 480 pixels. Voice can also be recorded.

1. Set the camera mode to [📹].
2. Compose the image.
3. Press the shutter button.
 - The recording of the video clip will start.
 - Pressing the shutter button one more time will end the recording of the video clip.
 - The recording time depends on the storage size and the subject of the image to be recorded.
 - The zoom function cannot be used during video recording.

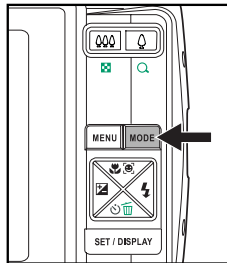

- When recording a video clip, the flash cannot be used.
- If the write speed of your SD/SDHC memory card is not fast enough for recording video clips in the currently selected size, and then the video recording will stop. In this case, select a video size lower than the current one.

Playing Back Video Clips

You can play back recorded video clips on the camera.

1. Set the camera mode to [📺].
 - The last image appears on the screen.
2. Select the desired video clip with the ◀ / ▶ buttons.
3. Press the **SET/DISPLAY** button.
 - A press of the ▶ / ◀ buttons during playback allows fast forward play/fast reverse play.
 - To stop video playback, press the ▼ button. This stops playback and returns to the start of the video clip.
 - To pause video playback, press the **SET/DISPLAY** button. This pauses video playback. To cancel pause, press the **SET/DISPLAY** button again.



- Video clips cannot be displayed rotated or enlarged.
- This camera does not have a built-in speaker so that you can not play back sound with the camera. To play the video clip back on your computer, you may use either Windows Media Player or Apple "QuickTime Player".
- QuickTime basic player is available free of charge, compatible with Mac and Windows-computers and can be downloaded from the Apple web site at www.apple.com. For help using QuickTime Player usage, please refer to the QuickTime on-line help for more information.

PLAYBACK MODE

Playing Back Still Images

You can play back the still images on the LCD monitor.

1. Set the camera mode to [📷].
 - The last image appears on the screen.
2. The images can be displayed in reverse or forward sequence with the ◀ / ▶ buttons.
 - To view the previous image, press the ◀ button.
 - To view the next image, press the ▶ button.
 - Pressing the 🔍 button enlarges the image.
 - To return to normal magnification, press the 🔍🗑️ button.

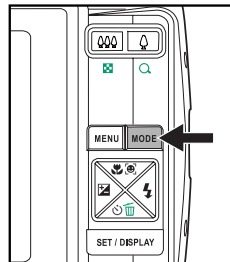

- An [📷] icon is displayed with the video data.

Thumbnail Display

This function allows you to view 9 thumbnail images on the LCD monitor at the same time, which can let you quickly search for the image that you want.

1. Set the camera mode to [□].
 - The last image appears on the screen.
2. Press the **9** button.
 - The images are displayed in the thumbnail display.
 - Images that have been selected with the ◀ / ▶ / ▲ / ▼ buttons will be indicated by a yellow frame.
 - When there are ten or more images, scroll the screen with the ▲ / ▼ buttons.
3. Press the ◀ / ▶ / ▲ / ▼ buttons to select the image to be displayed at regular size.
4. Press the **SET/DISPLAY** button.
 - The selected image is displayed at its regular size.

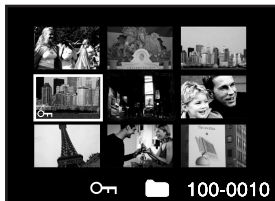

- In the 9-thumbnail mode, an [↔], [⊞] icon may be displayed in a thumbnail.

Removing Red-eye

You can use this function to remove the red-eye effect after an image is taken.

1. Set the camera mode to [□].
2. Select the image that you want to edit with the ◀ / ▶ buttons.
3. Press the **MENU** button.
4. Select [Fix Red Eyes], and press the **SET/DISPLAY** button.
5. Select [Execute] with the ▲ / ▼ buttons, and press the **SET/DISPLAY** button.
6. View the changes on the corrected image.
7. To save your corrected image, select [Confirm] with the ▲ / ▼ buttons, and press the **SET/DISPLAY** button.
 - When this process ends, this replaces the original image with the corrected image.

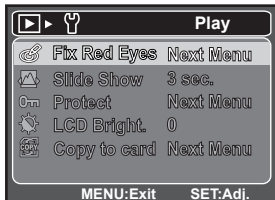

Protecting Images

Set the data to read-only to prevent images from being erased by mistake.

1. Set the camera mode to [□].
2. Select the image that you want to protect with the ◀ / ▶ buttons.
3. Press the **MENU** button.
4. Select [Protect] with the ▲ / ▼ buttons, and press the **SET/DISPLAY** button.
5. Select [Single] or [All] with the ▲ / ▼ buttons, and press the **SET/DISPLAY** button.
6. Select [Set] with the ▲ / ▼ buttons, and press the **SET/DISPLAY** button.
 - Protection is applied to the image and the camera returns to the previous menu mode.
 - The protect icon [⊞] is displayed with protected images.
When [All] has been selected, [⊞] is displayed with all the images.

Canceling the Protection

To cancel protection for only one image, display the image on which you want to remove the image protection.

1. Select [Protect] with the ▲ / ▼ buttons from the playback menu, and press the **SET/DISPLAY** button.
2. Select [Single] or [All] with the ▲ / ▼ buttons, and press the **SET/DISPLAY** button.
3. Select [Cancel Protect] with the ▲ / ▼ buttons, and press the **SET/DISPLAY** button.
 - The removal of image protection is executed and the camera returns to the previous menu mode.

Protecting multiple images simultaneously

1. Select [Protect] with the ▲ / ▼ buttons from the playback menu, and press the **SET/DISPLAY** button.
2. Select [Select] with the ▲ / ▼ buttons, and press the **SET/DISPLAY** button.
 - The images are displayed in the thumbnail display.
3. Select the images you want to protect with the ◀ / ▶ / ▲ / ▼ buttons, and press the ▼ button.
 - The protect icon [⊞] is displayed with protected images. Selecting a protected image and pressing the ▼ button again will cancel the protection. This procedure is repeated to select multiple images.
4. Press the **SET/DISPLAY** button.
 - Protection and cancellation of the protection are executed and the camera returns to playback mode.

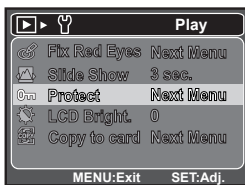

- Formatting an SD/SDHC memory card or internal memory overrides protection, and erases all images regardless of their protected status.

Erasing Images

Erasing single image / Erasing all images

1. Set the camera mode to [D].
 - The last image will be displayed on the screen.
2. Select the image you want to erase with the ◀ / ▶ buttons.
3. Press the button.
 - The deletion menu will be displayed.
4. Select [Single] or [All] with the ▲ / ▼ buttons, and press the **SET/DISPLAY** button.
 - [Single]: Erases the selected image or the last image.
 - [All]: Erases all of the images except for the protected images.
5. Select [Execute] with the ▲ / ▼ buttons, and press the **SET/DISPLAY** button.
 - To not erase, select [Cancel], and press the **SET/DISPLAY** button.

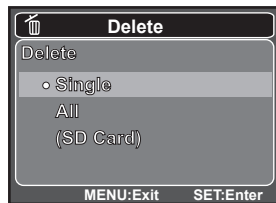
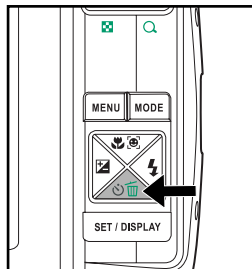

- Deleting an image will not affect sequential image numbering. For example, if you delete image number 240, the next captured image will be numbered 241 even though 240 no longer exists. In other words, an image-number is retired when an image is deleted and will not be reused or reassigned to another subsequently captured image.

MENU OPTIONS

Capture Menu

This menu is for the basic settings to be used when capturing still images.

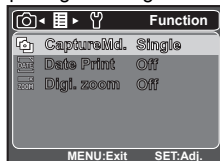
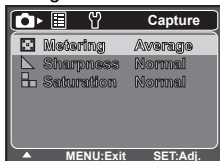
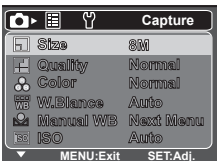

1. Set the camera mode to [].
2. Press the **MENU** button, and select the [Capture] / [Function] menu with the ◀ / ▶ button.
3. Select the desired option item with the ▲ / ▼ buttons, and press the **SET/DISPLAY** button to enter its respective menu.
4. Select the desired setting with the ▲ / ▼ buttons, and press the **SET/DISPLAY** button.
5. To exit from the menu, press the **MENU** button.

Size

This sets the size of the image that will be captured.

- * **[8M]** 8M (3264 x 2448 pixels)
- * **[6M]** 6M (2816 x 2112 pixels)
- * **[4M]** 4M (2272 x 1704 pixels)
- * **[2M]** 2M (1600 x 1200 pixels)
- * **[0.3M]** 0.3M (640 x 480 pixels)

Quality

This sets the quality (compression) at which the image is captured.

- * [] Fine
- * [] Normal
- * [] Economy

Color

This sets the color of the image that will be captured.





- * Normal / Vivid / Sepia / B&W

W. Balance

This sets the white balance for a variety of lighting conditions and permits images to be captured that approach the conditions that are seen by the human eye.

- * [Blank] Auto
- * [] Incand.

EN-28

- * [] F11
- * [] F12
- * [] Daylight
- * [] Cloudy
- * [] Manual

Manual WB

This manually sets the white balance and stores it. Use of this is convenient when the white balance does not offer a good match. Before selecting [Execute] and before taking your image, place a white paper in the scene and set the white balance manually.

* Cancel / Execute



ISO

This sets the sensitivity for capturing images. When the sensitivity is raised (and the ISO figure is increased), photography will become possible even in dark locations, but the more pixelated (grainier) the image will appear.

* Auto / 64 / 100 / 200 / 400 / 800

Metering

This sets the metering method for calculating the exposure.

- * [] Average: The entire area of the screen is measured, and the exposure is calculated.
- * [] Spot: A very small portion of the center of the screen is measured, and the exposure is calculated.

Sharpness

This sets the sharpness of the image that will be captured.

* Hard / Normal / Soft



Saturation

This sets the saturation of the image that will be captured.

* High / Normal / Low

CaptureMd.

This sets the recording method at the time of capturing images.

- * [Blank] Single: Captures one image at a time.
- * [] Cont.: Permits continuous capture of up to 3 images.
- * [] AEB: Permits 3 consecutive images in the order of standard exposure, underexposure and overexposure compensation.

Date Print

The date of recording can be printed directly on the still images. This function must be activated before the image is captured.

* On / Off

Digi. Zoom

This sets whether or not to use digital zoom at the time of photography.

* On / Off

Video Menu

This menu is for the basic settings to be used when recording video clips.



1. Set the camera mode to [].
2. Press the **MENU** button.
3. Select the desired option item with the **▲** / **▼** buttons, and press the **SET/DISPLAY** button to enter its respective menu.
4. Select the desired setting with the **▲** / **▼** buttons, and press the **SET/DISPLAY** button.
5. To exit from the menu, press the **MENU** button.

Size

This sets the size of the video clip that will be captured.

* [VGA] 640 x 480

* [QVGA] 320 x 240

Color

This sets the color of the video clip that will be captured.

* Normal / Vivid / Sepia / B&W

Playback Menu

In the [▶] mode, choose which settings are to be used for playback.

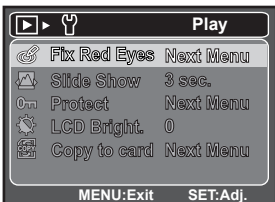

1. Set the camera mode to [▶].
2. Press the **MENU** button.
3. Select the desired option item with the ▲ / ▼ buttons, and press the **SET/DISPLAY** button to enter its respective menu.
4. Select the desired setting with the ▲ / ▼ buttons, and press the **SET/DISPLAY** button.
5. To exit from the menu, press the **MENU** button.

Fix Red Eyes

Refer to section in this manual titled "Removing Red-eye" for further details.

Slide Show

You can play back recorded images in order automatically with a selected interval.

* 3 sec. / 5 sec. / 10 sec.

Protect

Refer to section in this manual titled "Protecting Images" for further details.

LCD Bright.

Select a brightness level for the LCD monitor.

The LCD becomes brighter with the ▲ button and darker with the ▼ button. The adjustment range is from -5 to 5.

Copy to Card

Allows you to copy your files from the camera's internal memory to an SD/SDHC memory card. Of course, you can only do this if you have a memory card installed and some files in internal memory.

* Cancel / Execute

Setup Menu

Set your camera's operating environment.

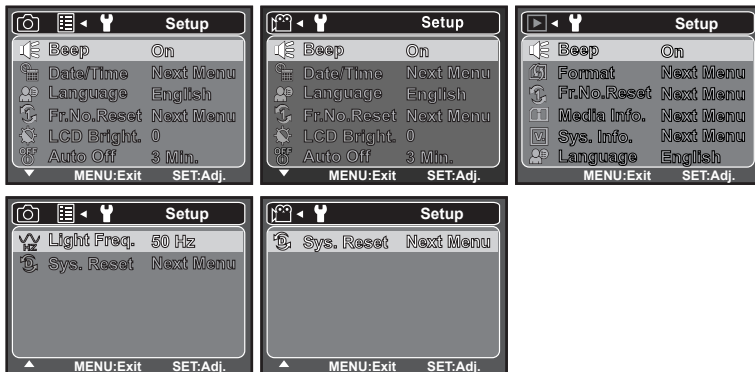

1. Set the camera mode to [] / [] / [].
2. Press the **MENU** button.
3. Select the [Setup] menu with the **▶** button.
4. Select the desired option item with the **▲** / **▼** buttons, and press the **SET/DISPLAY** button to enter its respective menu.
5. Select the desired setting with the **▲** / **▼** buttons, and press the **SET/DISPLAY** button.
6. To exit from the menu, press the **MENU** button.

Beep

This sets whether or not to mute the camera sound each time you press the camera's buttons.

* On / Off

Date/Time

Refer to section in this manual titled "Setting the Date and Time" for further details.

Language

Refer to section in this manual titled "Choosing the Language" for further details.

Fr. No. Reset

This creates a new folder. The captured images are recorded to the newly created folder from number 0001.

* Cancel / Execute

LCD Bright.

Refer to section in this manual titled "LCD Bright." in Playback Menu for further details.

Auto Off

If no operation is performed for a specific period of time, the power to the camera is automatically turned off. This feature is useful for reducing battery usage.

* 1 Min. / 2 Min. / 3 Min. / Off

Light Freq.

This camera supports different lighting frequencies: 50 Hz and 60 Hz. When photographing under fluorescent lighting, select the correct frequency setting depending in your local area's voltage. This function is only effective if you set the White Balance to Fluorescent setting.

* 50 Hz / 60 Hz

Sys. Reset

This returns all basic settings to the camera's default settings. The time setting will not be reset.

* Cancel / Execute

Format

Refer to section in this manual titled "Formatting the Memory Card or Internal Memory" for further details.

Media Info.

This displays the free capacity of the internal memory or the memory card.

Sys. Info.

This displays the firmware version of the camera.

TRANSFERRING FILES TO YOUR COMPUTER

System Requirement

Windows	Macintosh
<ul style="list-style-type: none">■ Pentium 166 MHz or higher■ Windows 2000/XP/Vista■ 128MB RAM■ 128MB hard disk space■ CD-ROM drive■ Available USB port	<ul style="list-style-type: none">■ PowerPC G3/G4/G5■ OS 9.0 or later■ 128MB RAM■ 128MB hard disk space■ CD-ROM drive■ Available USB port

Downloading Your Files

1. Connect one end of the USB cable to an available USB port on your computer.
2. Connect the other end of the USB cable to the USB terminal on the camera.
3. Turn on your camera.
4. Select [PC] using the ▲ / ▼ buttons, and press the **SET/DISPLAY** button.
5. From the Windows desktop, double click on "My Computer".
6. Look for a new "removable disk" icon.
 - This "removable disk" is actually the memory (or memory card) in your camera. Typically, the camera will be assigned drive letter "e" or higher.
7. Double click on the removable disk and locate the DCIM folder.
8. Double click on the DCIM folder to open it to find more folders.
 - Your recorded images and video clips will be inside these folders.
9. Copy & Paste or Drag-N-Drop image and video files to a folder on your computer.

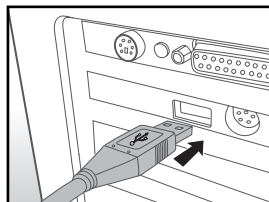

Mac users: Double-click the "untitled" or "unlabeled" disk drive icon on your desktop. iPhoto may automatically launch.

EDITING SOFTWARE INSTALLATION

There are 2 types of software that are included on the CD-ROM:

MediaOne Gallery SE - makes it the easiest way to manage and share your digital life with family & friends. The intuitive thumbnail library automatically organizes, updates and sorts files for the most natural way to browse your multimedia collection.

COOL 360 SE - combines ease-of-use, power and flexibility to allow even novice digital imaging enthusiasts to move beyond traditional photos into immersive imaging. Its intuitive interface and easy-to-use wizard deliver great-looking panoramas while advanced warping, blending and alignment tools ensure excellent results.

To install software:

1. Insert the CD-ROM that came with the camera into your CD-ROM drive.
The welcome screen appears.
2. Click the respective software name.
Follow the on-screen instructions to complete the installation.



-
- For more information about the operation of the software, refer to its respective help documentation.
 - For Windows 2000/XP/Vista users, please make sure to install and use the software in "Administrator" mode.
 - The software is not supported on the Mac.
 - COOL 360 SE is not supported by Windows Vista.

SPECIFICATIONS

Item	Description
Image sensor	1/2.5" CCD sensor (8.1 megapixels)
Image resolution	<Still image> 3264 x 2448, 2816x2112, 2272x1704, 1600 x 1200, 640 x 480 <Video clip> 640 x 480 (24 fps), 320 x 240 (30 fps)
LCD monitor	2.8" full color TFT LCD (230K pixels)
Recording media	16MB internal memory (12MB available for image storage) Supports SD/SDHC memory card (up to 4GB) (optional)
File format	JPEG, DCF, EXIF 2.2, AVI
Lens	3x optical zoom lens Aperture range: 2.9 (W) - 5.2 (T) Focal length: 5.7mm - 17.1mm (equivalent to 34mm - 102mm on a 35mm camera)
Focus Range	Auto Focus 0.4m to infinity Macro Wide: 0.10m to infinity Tele: 0.35m to infinity
Shutter speed	1/2 - 1/2000 sec.
Sensitivity	<Still image> Auto (ISO 64-200) Manual (ISO 64/100/200/400/800) * Sensitivity is measured in compliance with the ISO standard (ISO12232:2006).
Digital zoom	4x (Capture mode) 1-4x in 0.5x increment (Playback mode)
Flash effective range	0.5m - 2.4m (Wide) 0.5m - 2.1m (Tele)
Terminal	USB 2.0
Power supply	2 x AA size batteries
Operating environment	Temperature: 0°C - 40°C(32°F to 104°F) Humidity: 10% - 85%(Non-condensing)
Dimensions	Approx. 97.1 x 62.2 x 20.9 mm (without protruding parts)
Weight	Approx. 132g (without batteries and memory card)

* Design and specifications are subject to change without notice.

APPENDIX

Possible Number of Shots

Possible number of shots (still image)

The table shows the approximate shots that you can capture at each setting based on the capacity of the internal memory and the SD/SDHC memory card.

Size	Quality	Internal Memory	SD/SDHC memory card capacity						
			64MB	128MB	256MB	512MB	1GB	2GB	4GB SDHC
8M 3264 x 2448	Fine	3	17	35	72	146	293	587	1176
	Normal	4	23	48	98	197	395	791	1585
	Economy	5	28	58	118	238	475	957	1916
6M 2816 x 2112	Fine	4	23	48	98	197	396	793	1588
	Normal	6	32	65	132	265	532	1066	2134
	Economy	7	35	72	146	293	588	1177	2357
4M 2272 x 1704	Fine	9	42	86	174	350	702	1405	2814
	Normal	9	46	94	189	380	762	1527	3057
	Economy	11	54	111	224	450	902	1805	3614
2M 1600 x 1200	Fine	17	82	167	336	675	1353	2709	5422
	Normal	21	100	204	410	824	1650	3304	6612
	Economy	24	112	228	459	921	1845	3694	7394
0.3M 640 x 480	Fine	53	243	491	987	1980	3965	7938	15887
	Normal	61	282	571	1148	2304	4615	9237	18486
	Economy	75	345	698	1404	2816	5640	11289	22595

Possible recording time / sec (video clip)

Size	Internal Memory	SD/SDHC memory card capacity						
		64MB	128MB	256MB	512MB	1GB	2GB	4GB SDHC
VGA 640 x 480	00:06	00:31	01:02	02:06	04:13	08:28	16:57	33:55
QVGA 320 x 240	00:21	01:38	03:09	06:40	13:24	26:50	53:43	47:31

Troubleshooting

Refer to the symptoms and solutions listed below before sending the camera for repairs. If the problem persists, contact your local reseller or service center.

Symptom	Cause	Solutions / Corrective Actions
The power does not come on.	The batteries are not loaded.	Load the batteries correctly.
	The batteries are exhausted.	Replace with a new set of batteries.
The batteries or camera feels warm.	Long period of continuous use of the camera or the flash.	
Even if I press the shutter button, the camera does not shoot.	The shutter button is not pressed all the way down.	Press the shutter button all the way down.
	The internal memory or memory card does not have any free capacity.	Insert a new memory card, or delete unwanted files.
	The flash is charging.	Wait until the status LED stops blinking.
	The memory card is write-protected.	Remove the write-protection.
Although it is set to auto focus, it does not focus.	The lens is dirty.	Wipe clean with a soft, dry cloth or lens paper.
	The distance to the subject is smaller than the effective range.	Get your subject within the effective focus range.
Files cannot be deleted.	The file is protected.	Cancel protection.
	The memory card is write-protected.	Remove the write-protection.
Cannot download images.	The free space on the hard disk in your computer may be insufficient.	Check whether the hard disk has a space for running Windows, and if the drive for loading image files has a capacity at least that of the memory card inserted in the camera.
	No power supply.	Replace with a new set of batteries.

Connecting to a PictBridge Compatible Printer

Read this section if the model you purchased is included with the PictBridge functions.

If a printer that supports PictBridge is available, images can be printed by connecting the digital still camera directly to the PictBridge-compatible printer without using a computer.

Connecting the camera to the printer

1. Connect one end of the USB cable to your camera.
2. Connect the other end of the USB cable to the USB port on the printer.
3. Turn on your camera.
4. Select [Printer] with the ▲ / ▼ buttons, and press the **SET/DISPLAY** button.



Printing images

When the camera is properly connected to a PictBridge compliant printer and set to [Printer], the PictBridge menu is displayed on the monitor.

1. Select the item you want to configure with the ▲ / ▼ buttons, and press the **SET/DISPLAY** button.
 - [Images]: Select whether you want to print specific image or all images. You may also select printing number for specific image.
 - [Date Print]: According to the printer type, select whether you want to print the image with date imprint or not.
 - [Paper Size]: Select the desired paper size according to the printer type. You can select [Default], [L Format], [2L Format], [Postcard], [Card], [10 x 15cm], [4 x 6] or [A4].
 - [Layout]: Select the desired printing layout according to the printer type. You can select [Default], [1 Up], [2 Up], [3 Up], [4 Up], [Index] or [No Border].
 - [Print]: After all settings are configured, select this item to start printing.
2. If you select [Images] in the previous step, the figure shown on the right hand side will appear. Select [Single], [All] with the ▲ / ▼ buttons, and press the **SET/DISPLAY** button.
 - [Single]: Select to print one specific image.
 - [All]: Select to print all images.
 - [Exit]: Exit from Images option.

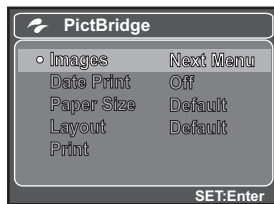

- If you select [Single] in the previous step, the figure shown on the right hand side will appear.
 - Select the image that you want to print with the ◀ / ▶ buttons.
 - Select the [Print Num] (up to 99) with the ▲ / ▼ buttons.
 - After selecting the desired image and printing number, press the **SET/DISPLAY** button to confirm.

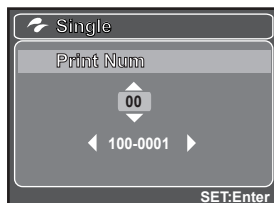

- Select [Print] with the ▲ / ▼ buttons, and press the **SET/DISPLAY** button to start printing.

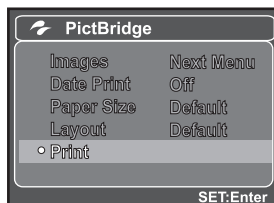

- The printing starts and the figure shown on the right hand side appears.
 - [COMPLETE] will be displayed temporarily, reminding you that the printing procedure is finished.
 - If a print error is detected, [PRINT ERROR] will be displayed.

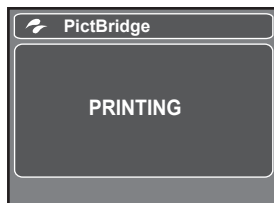

- The image printing may be failed if the power to the camera is cut off.



SANYO Electric Co., Ltd.
Printed in China

Free Manuals Download Website

<http://myh66.com>

<http://usermanuals.us>

<http://www.somanuals.com>

<http://www.4manuals.cc>

<http://www.manual-lib.com>

<http://www.404manual.com>

<http://www.luxmanual.com>

<http://aubethermostatmanual.com>

Golf course search by state

<http://golfingnear.com>

Email search by domain

<http://emailbydomain.com>

Auto manuals search

<http://auto.somanuals.com>

TV manuals search

<http://tv.somanuals.com>