



INSTRUCTION MANUAL

**26" and 32"* LCD High-definition Colour TV with
ATSC Digital Tuner**

**AVL-261/263/
321/323**



* Diagonal measure

**For best TV picture quality and channel selection connect to a digital
cable or satellite receiver**

Help Line: 1-800-263-224
Monday to Friday 9am-5pm (Eastern)

www.sanyo.ca

Thank you for choosing SANYO. This product incorporates latest-generation features including an ATSC digital tuner. Please read all instructions carefully to obtain maximum benefit of your product. Questions? Our toll-free number is 1-800-263-2244, 9am-5pm, Monday to Friday (Eastern time).

Table of Contents

Important Information	1
Important Safety Precautions	2
Setup	5
Identification of Controls	7
Connections	10
Basic Operations	14
Memorizing the Channels.....	15
Channel Selection	17
Screen Set-up for inputs other than Component.....	18
Screen Setup for Component Mode	19
Setting Sound	20
Time Set and Sleep Timer	21
Viewing Closed Captions	22
Setting Parental Control.....	23
Troubleshooting	28
Care and Maintenance.....	29
Specifications.....	30
Programming the Universal Remote Control	31

Important Information

WARNING: TO REDUCE THE RISK OF FIRE OR ELECTRIC SHOCK, DO NOT EXPOSE THIS APPARATUS TO RAIN OR MOISTURE.

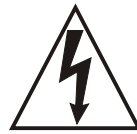
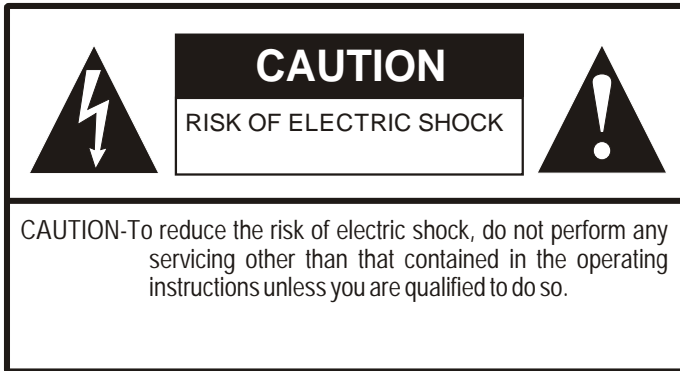

The lightning flash with arrowhead symbol, within an equilateral triangle is intended to alert the user to the presence of uninsulated dangerous voltage within the product's enclosure that may be of sufficient magnitude to constitute a risk of electric shock to persons.



The exclamation point within an equilateral triangle is intended to alert the user to the presence of important operating and maintenance (servicing) instructions in the literature accompanying the appliance.

This product utilizes tin-lead solder, and fluorescent lamp containing a small amount of mercury. Disposal of these materials may be regulated due to environmental considerations. For disposal or recycling information, please contact your local authorities or the Electronic Industries Alliance: www.eia.org

FCC STATEMENT

FCC Notice

LCD TV: A CLASS B digital device

This equipment has been tested and found to comply with the limits for a Class B digital device, pursuant to part 15 of the FCC Rules. These limits are designed to provide reasonable protection against harmful interference when the equipment is operated in a commercial environment.

This equipment generates, uses, and can radiate radio frequency energy and, if not installed and used in accordance with the instruction manual, may cause harmful interference to radio communications. Operation of this equipment in a residential area is likely to cause harmful interference in which case the user will be required to correct the interference at his own expense.

FCC CAUTION:

Pursuant to 47CFR, Part 15.21 of the FCC rules, any changes or modifications to this monitor not expressly approved by the manufacturer could cause harmful interference and would void the user's authority to operate this device.

WARNING: This is a CLASS B product. In a domestic environment this product may cause radio interference in which case the user may be required to take adequate measures to counter interference.

Important Safety Precautions

Electrical energy can perform many useful functions, but it can also cause personal injuries and property damage if improperly handled. This product has been engineered and manufactured with the highest priority on safety. But **IMPROPER USE CAN RESULT IN POTENTIAL ELECTRICAL SHOCK OR FIRE HAZARD**. In order to prevent potential danger, please observe the following instructions when installing, operating and cleaning the product. To ensure your safety and prolong the service life of your LCD TV product, please read the following precautions carefully before using the product.

1. Read these instructions---All operating instructions must be read and understood before the product is operated.
2. Keep these instructions---These safety and operating instructions must be kept in a safe place for future reference.
3. Heed all warnings---All warnings on the product and in the instructions must be observed closely.
4. Follow all instructions---All operating instructions must be followed.

5. Do not use this apparatus near water---for example, near a bathtub, washbowl, kitchen sink, or laundry tub, in a wet basement, or near a swimming pool, and the like. Do not use immediately after moving from a low temperature to high temperature environment, as this causes condensation, which may result in fire, electric shock, or other hazards.



6. Clean only with dry cloth---Unplug this product from the wall outlet before cleaning. Do not use liquid cleaners or aerosol cleaners. Use a damp cloth for cleaning.

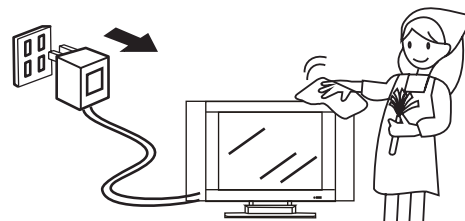

7. Ventilation---Do not block any ventilation openings. Install in accordance with the manufacturer instructions. The vents and other openings in the cabinet are designed for ventilation. Do not cover or block these vents and openings since insufficient ventilation can cause overheating and/or shorten the life of the product. Do not place the product on a bed, sofa, rug or other similar surface, since they can block ventilation openings. This product is not designed for built-in installation; do not place the product in an enclosed place such as a bookcase or rack, unless proper ventilation is provided or the manufacturer's instructions are followed.

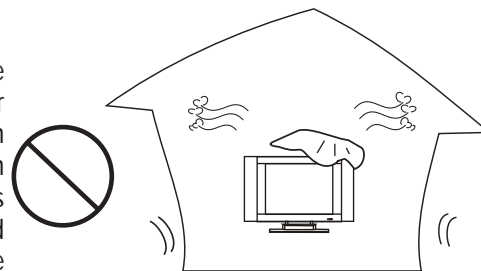

8. Heat sources---Do not install near any heat sources such as radiators, heat registers, stoves, or other apparatus (including amplifiers) that produce heat.

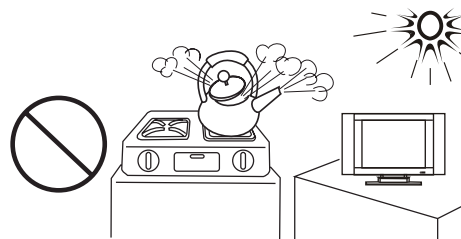

9. Grounding or Polarization---Do not defeat the safety purpose of the polarized or grounding-type plug. A polarized plug has two blades with one wider than the other. A grounding type plug has two blades and a third grounding prong. The wide blade or the third prong are provided for your safety. If the provided plug does not fit into your outlet, consult an electrician for replacement of the obsolete outlet.

10. Power cord protection---Protect the power cord from being walked on or pinched particularly at plugs, convenience receptacles, and the point where they exit from the apparatus.

11. Attachments---Only use attachments/accessories specified by the manufacturer. Do not use attachments not recommended by the manufacturer. Use of improper attachments can result in accidents.

Important Safety Precautions (continued)

12. Stand---Use only with the cart, stand, tripod, bracket, or table specified by the manufacturer, or sold with the apparatus. Do not place the product on an unstable trolley, stand, tripod or table. Placing the product on an unstable base can cause the product to fall, resulting in serious personal injuries as well as damage to the product. When mounting the product on a wall, be sure to follow the manufacturer's instructions. Use only the mounting hardware recommended by the manufacturer.



13. Move carefully---When a cart is used, use caution when moving the cart/apparatus combination to avoid injury from tip-over. Sudden stops, excessive force and uneven floor surfaces can cause the product to fall from the trolley. Never attempt to move the TV unless the AC power cord has been disconnected.



14. Lightning---Unplug this apparatus during lightning storms or when unused for long periods of time.

For added protection for this television equipment during a lightning storm, or when it is left unattended and unused for long periods of time, unplug it from the wall outlet and disconnect the antenna. This will prevent damage to the equipment due to lightning and power-line surges.

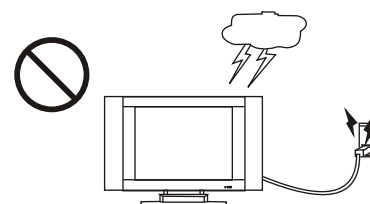

15. Servicing---Refer all servicing to qualified service personnel. Servicing is required when the apparatus has been damaged in any way, such as power-supply cord or plug is damaged, liquid has been spilled or objects have fallen into the apparatus, the apparatus has been exposed to rain or moisture, does not operate normally, or has been dropped.

16. Replacement parts---In case the product needs replacement parts, make sure that the service person uses replacement parts specified by the manufacturer, or those with the same characteristics and performance as the original parts. Use of unauthorized parts can result in fire, electric shock and/or other danger.

17. Overloading---Do not overload wall outlets, extension cords, or convenience receptacles on other equipment as this can result in a risk of fire or electric shock.

18. Entering of objects and liquids---Never insert an object into the product through vents or openings. High voltage flows in the product, and inserting an object can cause electric shock and/or short internal parts. For the same reason, do not spill water or liquid on the product.

19. Damage requiring service---If any of the following conditions occurs, unplug the power cord from the AC outlet, and request a qualified service person to perform repairs.

- When the power cord or plug is damaged.
- When a liquid is spilled on the product or when objects have fallen into the product.
- When the product has been exposed to rain or water.
- When the product does not operate properly as described in the operating instructions.

Do not touch the controls other than those described in the operating instructions. Improper adjustment of controls not described in the instructions can cause damage, which often requires extensive adjustment work by a qualified technician.

- If the product has been dropped or the cabinet has been damaged in any way.
- When the product displays an abnormal condition or exhibits a distinct change in performance. Any noticeable abnormality in the product indicates that the product needs servicing.

20. Safety checks---Upon completion of service or repair work, request the service technician to perform safety checks to ensure that the product is in proper operating condition.

21. Wall or ceiling mounting---When mounting the product on a wall or ceiling, be sure to install the product according to the method recommended by the manufacturer. This is a safety feature.

Important Safety Precautions (continued)

22. Power source---This product is intended to be supplied by a listed power supply indicated on the marking label. If you are not sure of the type of power supply to your home, consult your product dealer or local power company. For added protection for this product during a lightning storm, or when it is left unattended and unused for long periods of time, unplug it from the wall outlet and disconnect the cable system. This will prevent damage to the product due to lightning and power line surges. When the unit has to be used with another power supply voltage, the power cable must be changed. Consult your product dealer. The socket outlet should be installed near the equipment and easily accessible. Use only the power cord designated by our dealer to ensure safety and EMC. When connecting other products such as VCRs and personal computers, you should turn off the power of the unit for protection against electric shock.

23. Panel protection---The LCD panel used in this product is made of glass. Therefore, it can break when the product is dropped or impacted upon by other objects. Be careful not to be injured by broken glass pieces in case the LCD panel breaks.

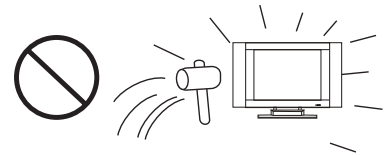

24. Pixel defect---The LCD panel is a very high technology product, giving you finely detailed pictures. Occasionally, a few non-active pixels may appear on the screen as a fixed point of blue, green or red. Please note that this does not affect the performance of your product.

Setup

Using the Remote Control

- Use the remote control by pointing it towards the remote sensor window of the set. Objects between the remote control and sensor window may prevent proper operation.

Note: This illustration is for reference only. The remote sensor may be in different locations on different models.

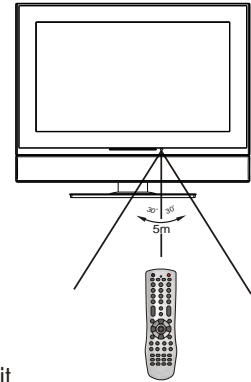

Cautions regarding use of remote control

- Do not expose the remote control to shock. In addition, do not expose the remote control to liquids, and do not place in an area with high humidity.
- Do not install or place the remote control under direct sunlight. The heat may cause deformation of the unit.
- The remote control may not work properly if the remote sensor window of the main unit is under direct sunlight or strong lighting. In such a case, change the angle of the lighting or LCD TV set, or operate the remote control closer to the remote sensor window.

Batteries for the Remote Control

1 Open the battery cover.

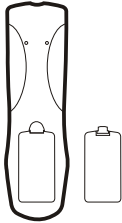

2 Insert two size-AA batteries.

- (Place the batteries with their terminals corresponding to the (+) and (-) indications in the battery compartment.)

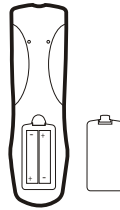

3 Replace the cover.

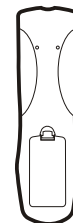

Precaution on battery use

Improper use of batteries can result in a leakage of chemicals and/or explosion. Be sure to follow the instructions below.

- Place batteries with their terminals corresponding to the (+) and (-) indications.
- Different types of batteries have different characteristics. Do not mix batteries of different types.
- Do not mix old and new batteries. Mixing old and new batteries can shorten the life of new batteries and/or cause old batteries to leak chemicals.
- Remove batteries as soon as they are non-operable. Chemicals that leak from batteries can cause a rash. If chemical leakage is found, wipe with a cloth.
- If the remote control is not used for an extended period of time, remove the batteries from the remote control.

Speaker connection

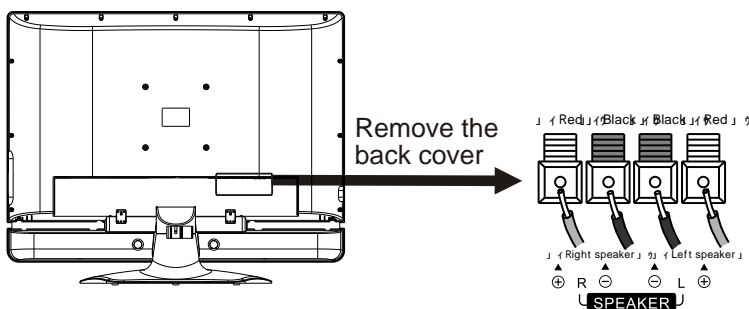

Connect the speaker audio cable to the external speaker output jack on the unit matching the "+" and "-" ends of the cable with color.

Note:

1. Disconnect all power sources before connecting the speakers.
2. The illustration may be different depending on model.

Antenna Connection

CABLE TV (CATV) CONNECTION

A 75-ohm coaxial cable connector is built into the set for easy hookup. When connecting the 75-ohm coaxial cable to the set, screw the 75-ohm cable to the ANT. Terminal.

Some cable TV companies offer "premium pay channels". Since the signals of these premium pay channels are scrambled, a cable TV converter/descrambler is generally provided to the subscriber by the cable TV company.

This converter/descrambler is necessary for normal viewing of the scrambled channels. For more specific instructions on installing cable TV, consult your cable TV company. One possible method of utilizing the converter/descrambler provided by your cable TV company is explained below. Please note: An RF switch provided with two inputs (A and B) is required (not supplied).

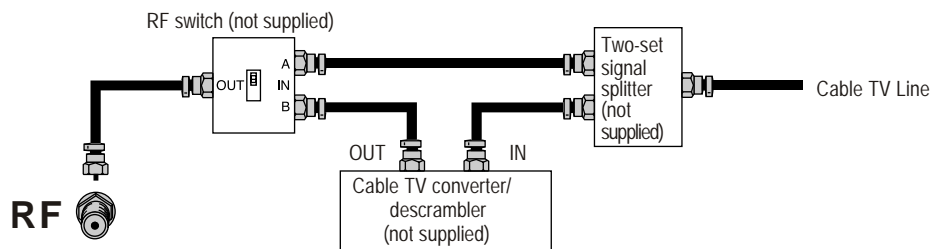

"A" position on the RF switch (not supplied) : You can view all unscrambled channels by using the TV's channel keys.

"B" position on the RF switch (not supplied) : You can view the scrambled channels via the converter/descrambler by using the converter's channel keys.

Note:

Consult your Dealer or Service Center for the type of splitter, RF switch or combiner that might be required.

ANTENNAS

The antenna requirements for good color television reception are more important than those for black & white television reception. For this reason, a good quality outdoor antenna is strongly recommended.

The following is a brief explanation of the type of connections that are provided with the various antenna systems.

1. A 75-ohm system is generally a round cable with F-type connector that can easily be attached to a terminal without tools (not supplied).
2. A 300-ohm system is a flat "twin-lead" cable that can be attached to a 75-ohm terminal through a 300-75-ohm adapter (not supplied).

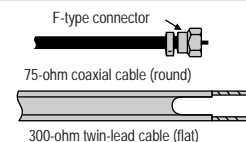

OUTDOOR ANTENNA CONNECTION

Use one of the following two diagrams if you connect an outdoor antenna.

A: Using a VHF/UHF combination outdoor antenna.

B: Using separate VHF and/or UHF outdoor antennas.

Connect the outdoor antenna cable lead-in to the ANT. terminal on the rear of the TV set.

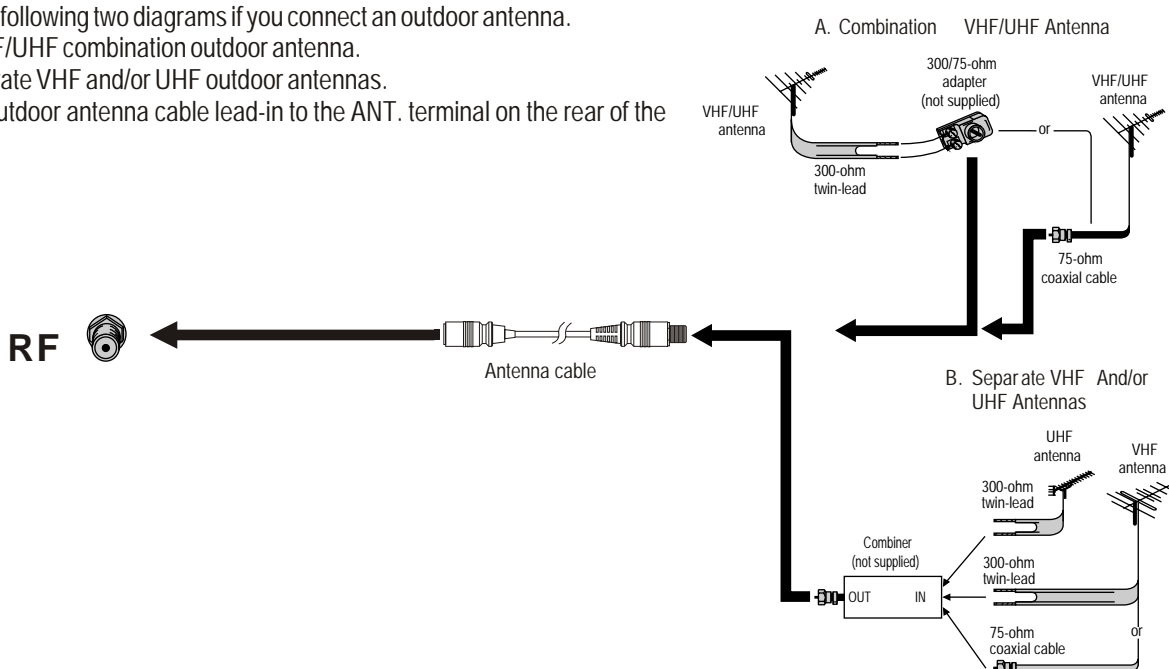

Setup (continued)

Remove the Stand

Cautions:

1. Carefully handle the unit during setup and consult authorized service personnel to ensure successful installation.
2. Before performing work spread cushioning over the base area to lay the Display on. This will prevent it from being damaged.

- Do not remove the stand from the Display unless using an optional bracket to mount it.
- The appearance of the unit may differ from the actual one.
- To attach the stand, perform the steps in reverse order.

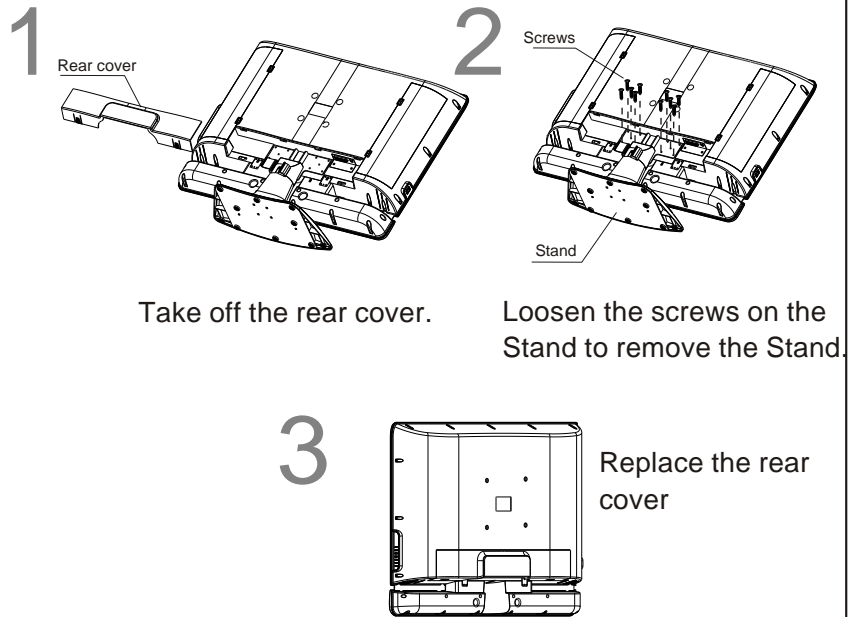

Identification of Controls

Main unit (front view)

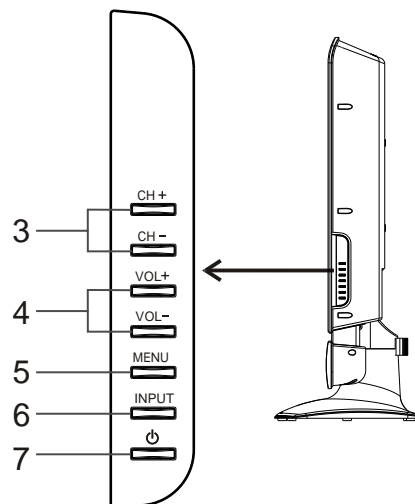
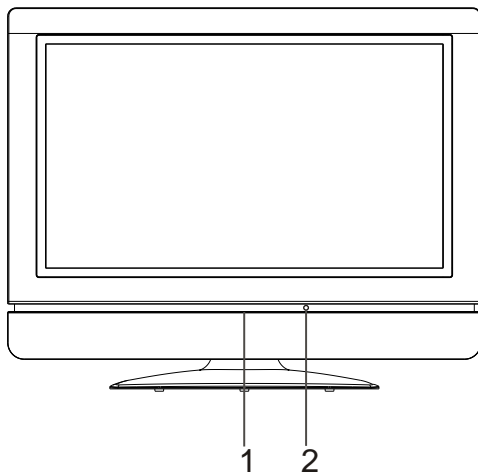

1. Power indicator
 2. Remote sensor
 3. CH+/-
Channel Down or up.
In OSD Menu, press these buttons to choose the OSD items.
 4. VOL+/-
Press the VOL+ or VOL- button to directly increase or decrease the sound volume level.
In OSD Menu, press these buttons to adjust the value or setting of each item
 5. MENU
Press this button to access the MENU main page.
 6. INPUT
To access signal input select menu.
 7. POWER
- Press this button to turn the unit ON from STANDBY mode. Press it again to turn the set back to STANDBY.

Note:

POWER , INPUT, MENU, VOL+/- and CH+/- on the main unit have the same functions as the corresponding buttons on the remote control.

This operation manual provides a description based on operating functions with the remote control.

Main unit (rear view)

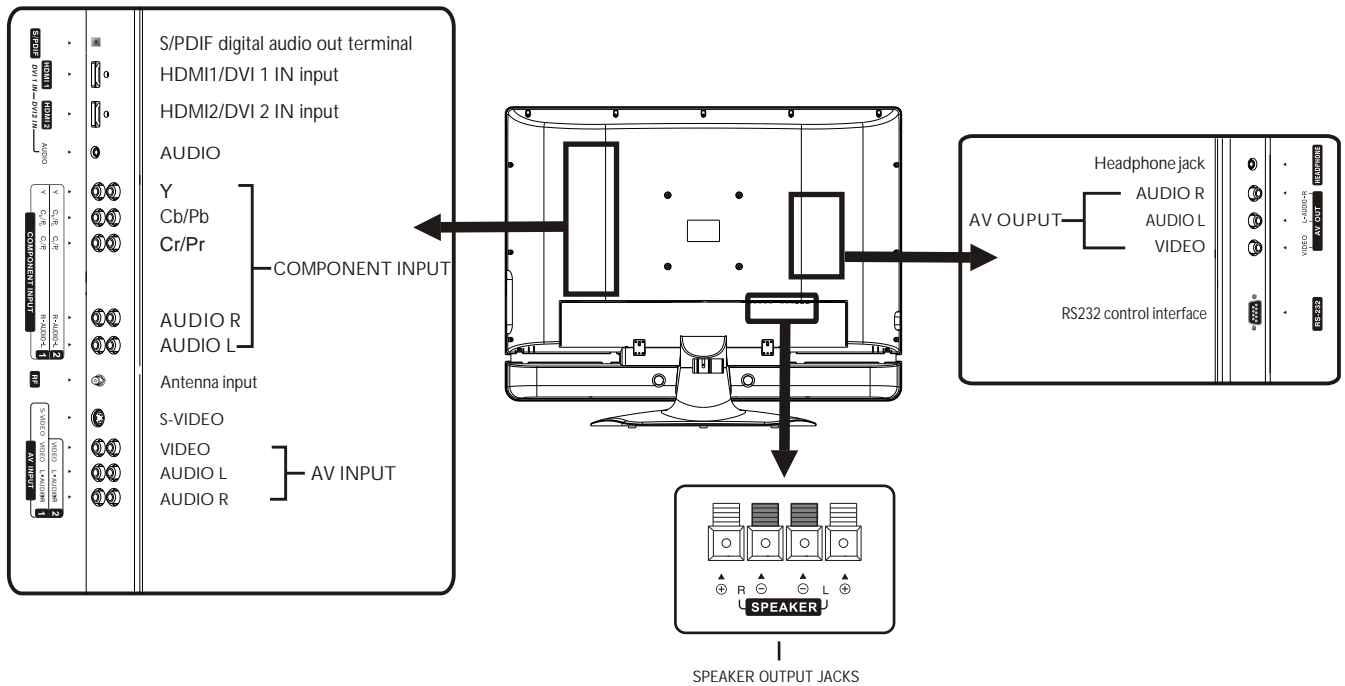

1. S/PDIF digital audio out terminal (optical)

2. HDMI1/DVI 1 IN input

To connect to equipment with HDMI/DVI interface, for example, digital cable/satellite receiver or DVD player.

3. HDMI2/DVI 2 IN input/Audio in

To connect equipment with HDMI/DVI interface, for example, digital cable/satellite receiver or DVD player.

Connect the audio jack for DVI.

4. Component inputs

Connect to the audio and component output jacks of a DVD player or digital cable/satellite receiver.

5. Antenna input

Allow you to connect cable or outdoor antenna.

6. S-Video input/AV inputs

Receive a S-Video signal from external source such as camcorder or DVD player.

7. AV inputs 1 & 2

Receive video/audio signals from external source such as VCR, camcorder or DVD player.

8. Headphone jack

9. AV outputs

Connect to the VCR input jacks to record programs.

10. RS232 control interface

For service only. The user cannot operate the unit through the RS232 terminals.

Note: Before you connect external devices with the unit, please remove the terminal cover.

Identification of Controls (continued)

Remote Control

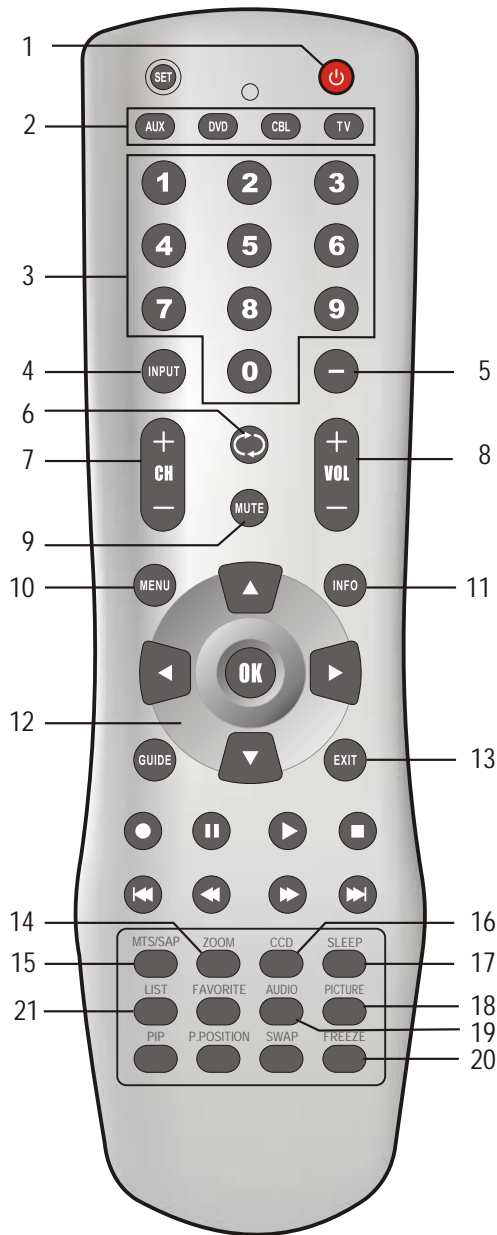

1. POWER
 - Turn the unit on or off
2. To select additional products to be controlled with remote control
 - Note: This remote control is an universal remote control. If your remote control does not work correctly when you operate the unit, please try to press TV button.
3. Direct channel selector/number buttons
 - Use these number buttons to select channel or input password.
4. INPUT
 - To quickly select input source
5. Dash(-)
 - used to enter a program number for multiple program channels such as 2-1,2-2, etc.
6. RETURN
 - To quickly return to the previous channel
7. CH+/-
 - To select channels upward or downward
8. VOL+/-
 - Used to adjust volume.
9. MUTE
 - Sound mute
10. MENU
 - To access the Menu main page
11. INFO
 - To display channel status or signal information
12. Menu navigation button:
 - : To move upward or downward in menu operation;
 - : To move left or right in menu operation;
 - To adjust selected menu item in menu operation;
- OK button: To confirm or toggle between the settings of the selected menu item.
13. EXIT
 - Used to exit the menu
14. ZOOM
 - To select screen aspect ratio
15. MTS/SAP
 - To select STEREO, SAP or MONO
16. CCD
 - To select closed caption mode
17. SLEEP
 - To set Sleep timer
18. PICTURE
 - To select the picture mode
19. AUDIO
 - To select the sound mode
20. FREEZE
 - To freeze current picture
21. LIST
 - To quickly access the Channel List menu

Press once to access the **Composite 1** ;

Press once to access the **HDMI1** mode;

Note: The above button functional list is

Note: The above buttons without descriptions are not active.

Connections

Cautions before connecting

- Carefully check the terminals for position and type before making any connections.
- The illustration of the external equipment may be different depending on your model.
- Loose connectors can result in image or color problems. Make sure that all connectors are securely inserted into their terminals. Refer to the user manual of the external device as well.
- When connecting an external device, turn the power off on the panel to avoid any issues.

Connect an Audio Processor or Hi-Fi (Digital Audio)



For a full Home Theater sound experience, you must connect your Hi-Fi or Audio processor to the S/PDIF (Optical) terminal on the TV rear.

Connect a VCR

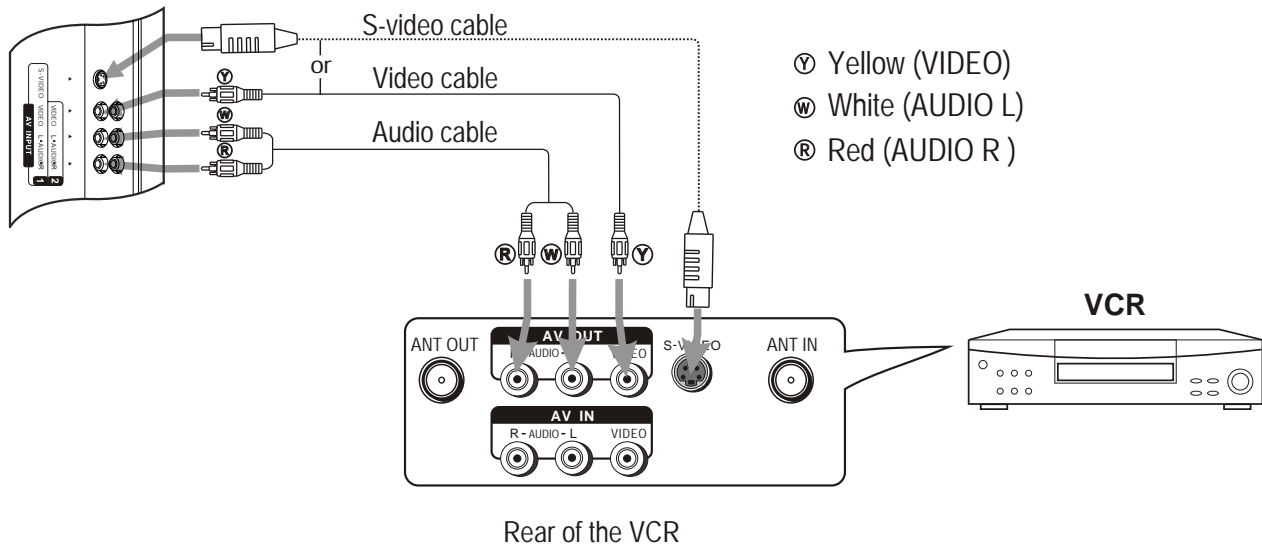

How to connect:

Connect the Audio/Video cables between the Audio (L/R)/Video jacks on the unit and VCR.

Note: For better video, you can use the S-video terminal if your source supports it.

To play VCR

1. Turn on your LCD TV, press INPUT button on the remote control to select Composite1 (or S-Video if using S-VIDEO terminal).
2. Turn on your VCR, insert a videotape and press the Play button.

Connections (continued)

Connect a Camcorder

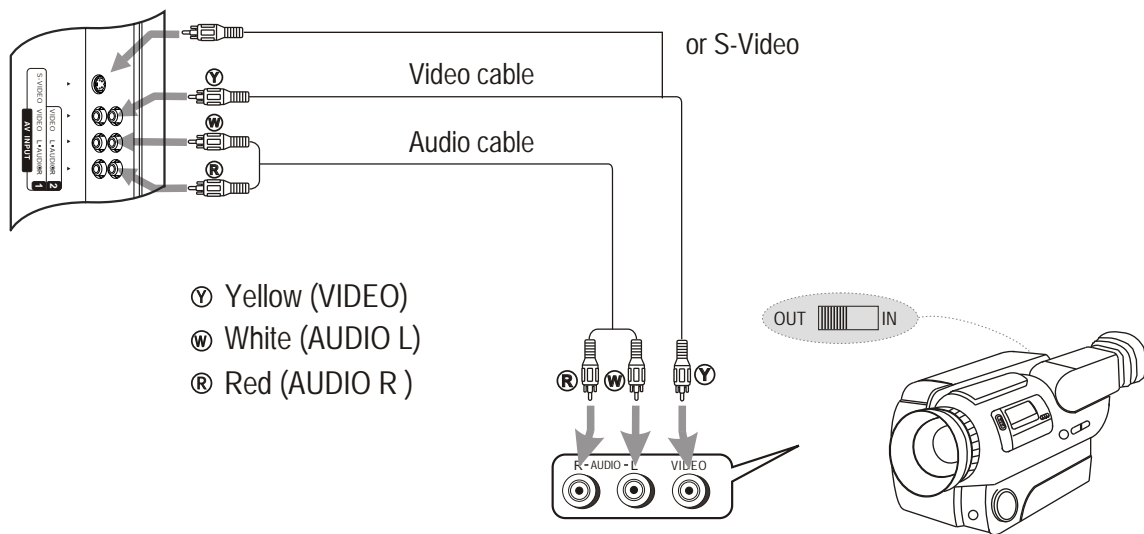

How to connect:

Connect the Audio/Video cables between the Audio (L/R)/Video jacks on the unit and camcorder.

To playback Camcorder

1. Turn on your LCD TV , press INPUT button on the remote control to select Composite 2.
2. Turn on your camcorder and set it to output mode. (For details, refer to your camcorder user manual.)
3. Insert the tape into the camcorder and press Play button.

Note:

The operations of the camcorder may be different and is dependant on your model. Please read the user manual of your camcorder to confirm operation.

Connect a DVD player or Digital Cable/Satellite receiver with HDMI Connection

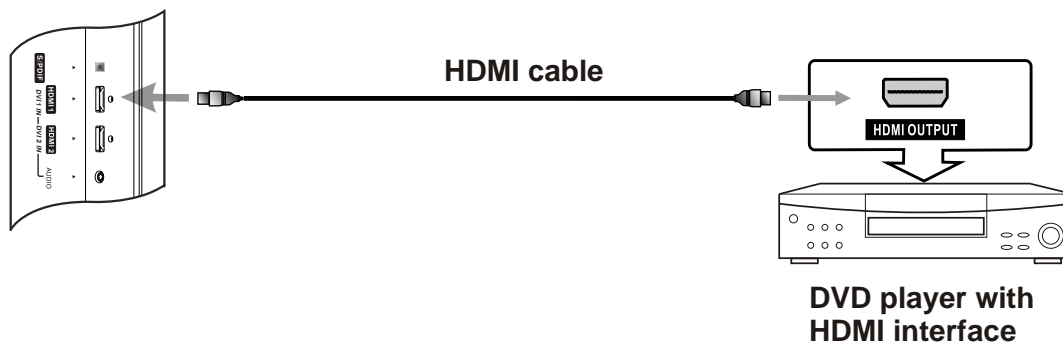

How to connect a DVD Player using HDMI Connection:

Connect the HDMI cable between the HDMI interface on the unit and HDMI output on the DVD player and/or receiver.

To play DVD

1. Turn on your LCD TV , press INPUT button on the remote control to select HDMI1 or HDMI2 .
2. Turn on your DVD player and/or digital receiver, insert a DVD disc and press the Play button.

Note:

The HDMI sources are compatible with DVI displays through the use of a passive cable converter. So if the external device has DVI output only, use a DVI to HDMI adapter cable to connect to the HDMI terminal. Connect the audio cable to the AUDIO IN mini-jack nearby.

Connect a Digital Cable/Satellite receiver or standard DVD player

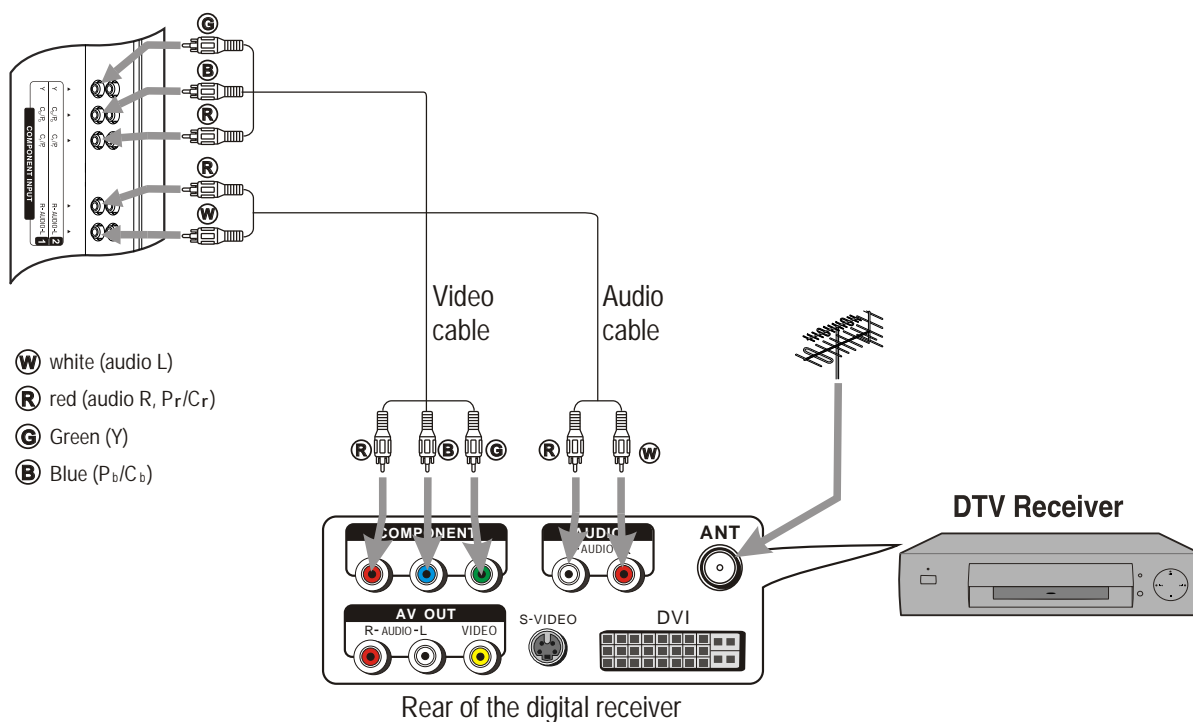

How to connect:

Connect the cable or antenna to the antenna input jack on the digital receiver.

Connect the Video cable between the Y, Pb, Pr input jacks on the unit and Y, Pb, Pr output jacks on the receiver and/or DVD player.

Connect the Audio cable between the AUDIO input jack on the unit and AUDIO output jacks on the receiver and/or DVD player.

To Watch

1. Turn on your LCD TV, press INPUT button on the remote control to select Component 1 or 2.
2. Turn on your DTV receiver and/or DVD player.

Connect a VCR (for recording) or external amplifier

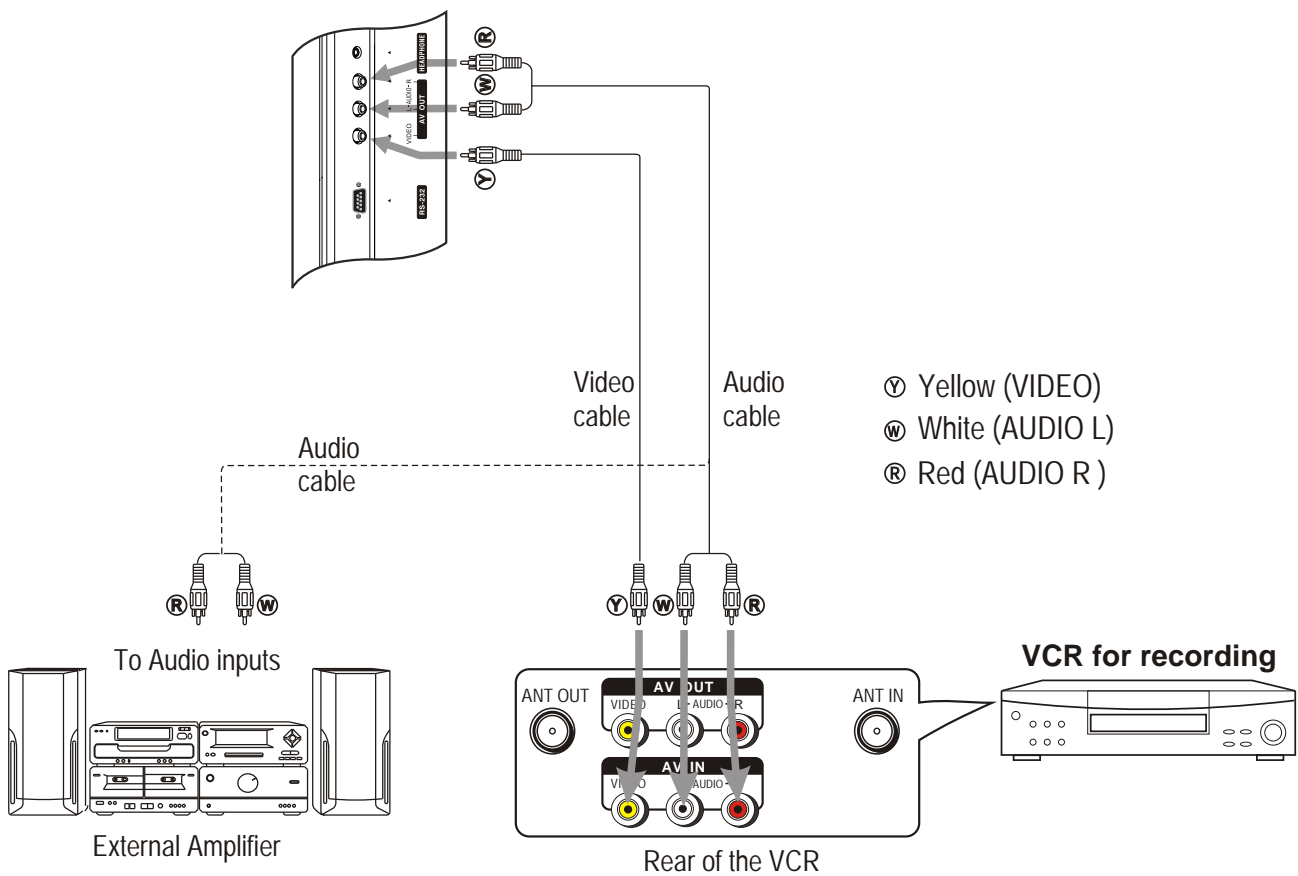

How to connect:

Connect the Audio/Video cables between the Audio (L/R)/Video jacks on the unit and VCR.

- Or -

Connect the Audio cables between the Audio (L/R) jacks on the unit and external amplifier.

To record program

1. Turn on your LCD TV, select a program you wish to record.
2. Turn on your VCR, insert a videotape for recording.
3. Press the Record button to begin recording.

To enjoy high-quality sound through an external amplifier

Note:

The operations of the amplifier may be different depending on model. Please read the user manual of your amplifier to confirm proper operation.

The AV output terminals output audio/video signal inputted from Antenna input or AV inputs.

Basic Operations

Turning the Unit On and Off

Turning On

Insert the power cord into the wall outlet.

Press the **Power**  button on the remote control, the unit will be turned on and you will be ready to use its features.

Turning Off









With the power on, press the **Power**  button on the remote control to turn off.

Note: You can also use the **Power**  button on the control panel on the main unit.

Viewing the Menu and Displays

This unit has a simple, easy-to-use menu system that appears on the screen. This system makes it convenient and fast to use features on the unit. The unit also lets you display the status of many of your TV features.

Menu navigation







- 1 With the power on, press the **MENU** button to display the main menu.
- 2 Press  or  button to select menu page.
- 3 Press **OK** or  button to enter the menu page.
- 4 Within the menu, use , ,  or  to navigate or adjust.
Press **OK** or  button to confirm, enter sub-menu or toggle the settings of the selected menu item.
- 5 Press **MENU** button to return to the previous level menu.
Press **EXIT** button to exit the main menu and return to your program.

Note: to clearly introduce the menu operations, this operation manual provides a description based on operation with the remote control.

Displaying Status Information

Press the **INFO** button on the remote control, the unit will display current status information such as channel number or signal source, etc.

On-screen Menus Language Selection

- 1 Press **MENU**.
- 2 Press  or  to select **Feature** menu, press **OK** or  to access the submenu.
- 3 Press  or  to select **Menu Language** item, press **OK** or  to select your desired language.
- 4 Press **EXIT** button to return to TV viewing.

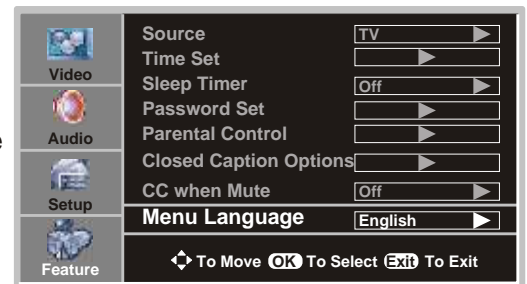

Selecting Input Source Signal

- 1 Navigate to the **Feature** menu and highlight **Source**.
- 2 Press **OK** or  to select your desired input source.

Note: You may directly press **INPUT** button on the remote control to select input source.

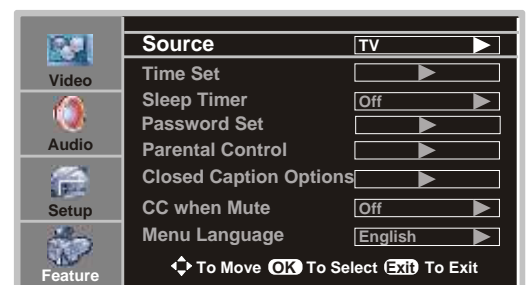

TV -----Select TV signal.

Composite1-----Select signal from AV INPUT1 terminals.

Composite2-----Select signal from AV INPUT2 terminals.

Component1-----Select signal from COMPONENT INPUT1 terminals.

Component2-----Select signal from COMPONENT INPUT2 terminals.

HDMI1-----Select signal from HDMI1 input interface.

HDMI2-----Select signal from HDMI2 input interface.

S-Video-----Select signal from S-VIDEO input terminal.

Memorizing the Channels

This unit can automatically find all channels available through antenna or cable inputs, and store them in memory.

Selecting the Tuning Band

Before your TV can memorize the available channels, you must specify the type of signal source that is connected to the unit. (i.e., an antenna or cable system)

- 1 Press **MENU** to display the menu main page.
- 2 Press **▲** or **▼** repeatedly to select **Setup** menu.
- 3 Press **OK** or **▶** to access the submenu.
- 4 Press **▲** or **▼** to select **Tuning Band** item.
- 5 Press **OK** or **▶** to select the Tuning Band.



Air, Cable, Cable HRC, Cable IRC and **Cable Auto** can be selected.

- ◆ If using antenna, select **Air**;
- ◆ If using cable, select one of **Cable/Cable HRC/Cable IRC/Cable Auto** according to your local area's cable system. **Normally please select Cable Auto.** (For further band information, contact your cable service provider.)

Auto Channel Search

- 1 Navigate to the **Setup** sub-menu and highlight **Auto Ch Search**.
- 2 Press **OK** or **▶** to begin the auto channel search. The unit will automatically search for all available TV/DTV (if using antenna), CATV/CADTV (if using cable) program.
Note: if you want to stop the auto-search, press EXIT button. Digital (CADTV) cable systems may cause several unviewable channels to be memorized.



Add On Channel Search

After initial auto channel search, you can make use of Add On Channel Search option to search for new programs and add them to

- 1 Navigate to the **Setup** sub-menu and highlight **Add On Ch**
- 2 Press **OK** or **▶** to begin the add on channel search. The unit will automatically search for new programs and add them to the program list.

Note: If you want to stop the search, press **EXIT** button.

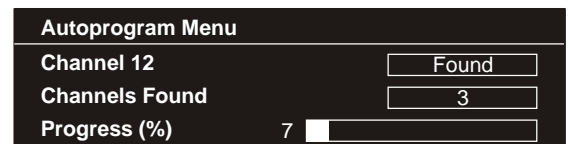

Manual Channel Set

After setting channels into memory, you can add or delete channels from the default channel list as follows:

- 1 Navigate to the **Setup** sub-menu and highlight **Manual Ch Set**.
- 2 Press **OK** or **▶** to open **Manual Channel Set Menu** sub-menu.
- 3 Use **▲** or **▼** button to select a channel, then press the **OK** button to add or delete the channel.
- 4 Press **EXIT** button to exit.

Now when you use **CH+/-** buttons to cycle among the channels, the deleted channels can not be selected.

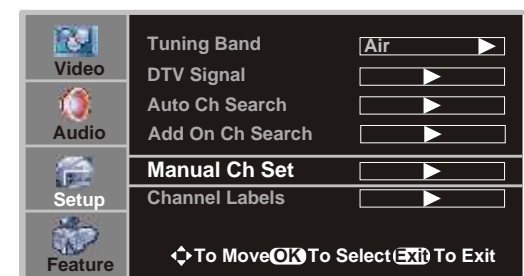

Memorizing the Channels (continued)

DTV Signal Strength

You can make use of DTV signal strength monitor to check how strong your DTV signal is and whether you need to adjust your antenna or digital cable input. The higher the signal strength, the less likely you are to experience picture degradation.

- 1 Navigate to the **Setup** sub-menu and highlight **DTV Signal**.
- 2 Press **OK** or **▶** to view the on-screen signal strength monitor to see the quality of the signal being received.



Channel Label Setup

If required, you can give a name to the programs.

Note: if a channel label is provided on the signal from the broadcasting station, the TV displays a short name for a DTV channel even if you didn't setup a label for the channel.

- 1 Navigate to the **Setup** sub-menu and highlight **Channel Labels**.
- 2 Press **OK** or **▶** to open **Channel Labels Menu**.
- 3 Within the menu, use **◀ / ▶** to move the highlight or cursor. Use **▲ / ▼** to select channel number, or select character. You may use **OK** button to return to the previous level menu.
- 4 To quit, press **EXIT** button.

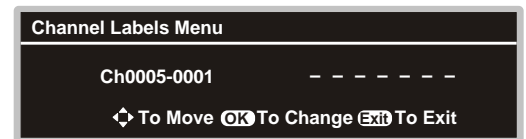

Channel Selection

Information about USA and Canadian channel numbering in the digital era

= An ATSC channel has two part channel number:

- Major channel number
- Minor channel number

For example: Channel: 5-1
Major channel number ↑ Minor channel number

- In most situations the major channel number is same for both analog and digital channels (It is equal to the NTSC channel number for existing broadcasters.)
- A minor channel number of zero is used for a broadcaster's analog channel.

Channel Numbering Example

- Original NTSC Channels for Des Moines (via antenna):
 - 5, 8, 11, 13, 17
 - Possible NTSC + ATSC Channels for Des Moines (via antenna):
 - 5-0, 8-0, 11-0, 13-0, 17-0 (channel numbers for existing analog channels)
 - 5-1, 5-2, 8-1, 8-2, 8-3, 8-4, 13-1 (channel numbers for digital channels)
- In Canada, ATSC digital reception areas via antenna are limited. However digital coverage via cable or satellite is widespread (digital cable or satellite receiver required).

Channel Selection

Using the Channel up/down buttons (CH+ or CH-)

Press the **CH+** or **CH-** to cycle among available channels found.

Using the direct select buttons (0-9 and dash buttons)

Press the **number buttons (0-9)** and the **dash button (-)** to go directly to a channel.

For example, if you want to select channel 8-3, just key in '8', '-', '3' on the remote control.

Note:

- *When you use the number buttons, you can directly select any channel within the channel range.*
- *In some situations virtual channel numbers have no correspondence to physical frequencies.*
- *To select an analog channel, you may directly input its major channel number. It is unnecessary to input the minor channel number of zero.*

Using the ↻ button

Press this button to switch between the current channel and the last viewed channel.

Screen Setup for HDMI, S-Video, regular audio/video inputs and analog TV

Customizing the Picture

- 1 Press **MENU** to display the menu main page.
- 2 Press **▲** or **▼** repeatedly to select **Video** menu.
- 3 Press **OK** or **▶** to access the submenu.
- 4 Within the menu, use **▲**, **▼**, **◀** or **▶** to navigate or adjust. Press **OK** or **▶** button to confirm, enter sub-menu or toggle the settings of the selected menu item.
- 5 Press **EXIT** button to exit.

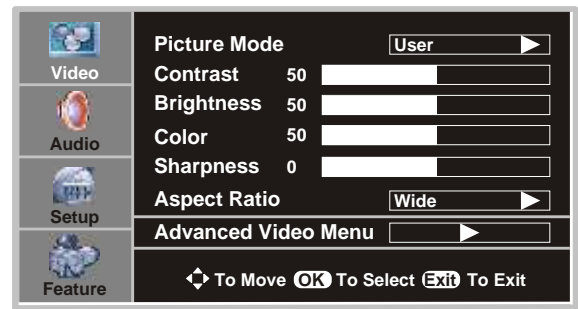

Notes:

The OSD illustration shown above is Video menu in RF(TV) mode. The menu items may be different when the unit works in different mode.

Option	Function	Choice/remarks
Picture Mode	Selects a desired picture mode.	User/Nature/Soft/Bright Note: you may directly press PICTURE button on the remote control to select.
Contrast	Adjusts image contrast.	▶ : stronger ◀ : weaker
Brightness	Adjusts screen brightness for easier viewing of dark picture such as night scenes and black hair.	▶ : lighter ◀ : darker
Color	Adjusts color saturation.	▶ : stronger ◀ : weaker
Sharpness	Adjusts image sharpness and displays a sharp image.	▶ : sharper ◀ : softer
Aspect Ratio	Selects screen aspect ratio.	Wide/Cinema/Normal/Zoom Note: you may directly press ZOOM button on the remote control to select. "Wide" & "Cinema" stretch the image in the width to fill the screen of a 4:3 program. "Wide" is uniform across the screen. "Cinema" minimizes the effect in the centre, increases at the edges. "Zoom" increases the size without stretching but some top and bottom content on 4:3 program is lost.
Advanced Video Menu	Noise Reduction	Spatial/Speckle/Temporal Reduces noise (snow) in the picture. On/Off
	Tint	Adjusts tint for image. ▶ : greenish ◀ : purplish
	Color Temperature	Selects one of three automatic color adjustments. Sets to warm to enhance hotter colors such as red, or set to cool to see less intense colors with more blue. Cool/Warm/Normal
	3D Y/C	Selects 3D comb filter on/off, normally please select On. On/Off

To still the picture

Press the **FREEZE** button to hold on the image on the screen (the video sources are still operating). Press the button again to reactivate the image.

Note:

For the sake of protecting the screen, please do NOT still a picture for a long time.

Screen Setup for Component 1 & 2 inputs

Customizing the picture

- 1 Navigate to the **Video** sub-menu.
- 2 Within the menu, use **▲**, **▼**, **◀** or **▶** to navigate or adjust.
Press **OK** or **▶** button to confirm, enter sub-menu or toggle the settings of the selected menu item.
- 3 Press **EXIT** button to exit

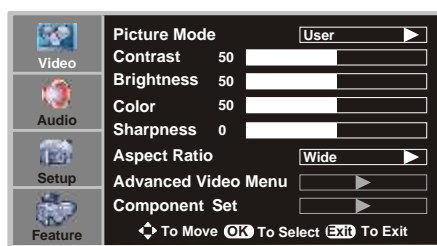

Option		Function	Choice/remarks
Picture Mode		Selects a desired picture mode.	User/Nature/Soft/Bright Note: you may directly press PICTURE button on the remote control to select.
Contrast		Adjusts image contrast.	▶ : stronger ◀ : weaker
Brightness		Adjusts screen brightness for easier viewing of dark picture such as night scenes and black hair.	▶ : lighter ◀ : darker
Color		Adjusts colour saturation.	▶ : stronger ◀ : weaker
Sharpness		Adjusts image sharpness and displays a sharp image.	▶ : sharper ◀ : softer
Aspect Ratio		Selects screen aspect ratio.	Wide/Cinema/Normal/Zoom Note: you may directly press ZOOM button on the remote control to select. See page 18.
Advanced Video Menu	Noise Reduction--Spatial Noise Reduction--Speckle Noise Reduction--Temporal	Spatial/Speckle/Temporal Reduces noise (snow) in the picture.	On/Off
	Tint	Adjusts tint for image.	▶ : greenish ◀ : purplish
	Color Temperature	Selects one of three automatic color adjustments. Sets to warm to enhance hotter colors such as red, or set to cool to see less intense colors with more blue.	Cool/Warm/Normal
	3D Y/C	Selects 3D comb filter on/off, normally please select On.	On/Off
Component Set	H-Pos	Adjusts the horizontal position of the image.	▶ : rightward ◀ : leftward
	V-Pos	Adjusts the vertical position of the image.	▶ : upward ◀ : downward
	Clock	Adjusts the sample frequency for improved clarity under certain conditions.	
	Phase	Improves the focussing of stable image.	
	Setting	Selects and activates Preset to reset the adjusted values to original factory values.	
	Auto Adjust	Automatically adjusts the settings based on the signal input.	

Setting Sound

Adjusting the Volume

Using the volume buttons (VOL+ and VOL-)

Press the **VOL +** or **VOL-** to increase or decrease the volume.

Using the Mute

At any time, you can temporarily cut off the sound using the **MUTE** button.

- 1 Press the **MUTE** button and the sound cuts off.
- 2 To turn mute off, press the **MUTE** button again.

Customizing the sound

- 1 Press **MENU** to display the menu main page.
- 2 Press **▲** or **▼** repeatedly to select **Audio** menu.
- 3 Press **OK** or **▶** to access the submenu.
- 4 Within the menu, use **▲**, **▼**, **◀** or **▶** to navigate or adjust. Press **OK** or **▶** button to confirm, enter sub-menu or toggle the settings of the selected menu item.
- 5 Press **EXIT** button to exit.

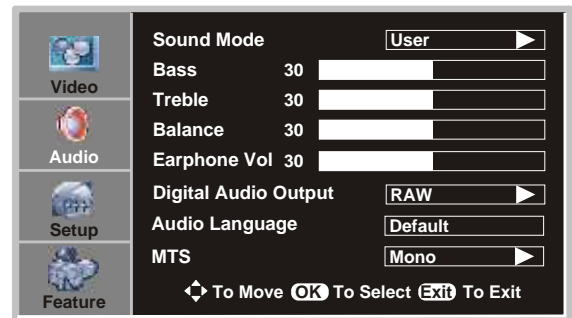

(The above menu is shown as an example. It is in TV mode and the signal is analog)

Option	Function	Choice/Range/Remarks
Sound Mode	Selects sound mode.	User/News/Music/Movie Note: you may directly press AUDIO button on the remote control to select.
Bass	Adjusts Bass (low sounds)	▶ : stronger ◀ : weaker
Treble	Adjusts Treble (high sounds).	▶ : stronger ◀ : weaker
Balance	Adjusts volume balance (left and right volumes).	▶ :Higher volume from right speaker. ◀ :Higher volume from left speaker.
Earphone Vol	Adjusts earphone volume.	▶ : stronger ◀ : weaker
Digital Audio Output	Selects audio output mode from SPDIF. RAW: AC-3 in AC-3 out PCM: AC-3 in PCM out PCM in PCM out PCM in PCM out	RAW/PCM
MTS (In analog signal only)	Selects MTS (multi-channel TV sound) mode: Mono, Stereo and SAP (Second Audio Program).	The choice may be different in different situation Note: you may directly press MTS/SAP button on the remote control to select.
Audio Language (In digital signal only)	Other languages may be available if a digital signal is provided by the broadcasting station.	The choice may be different in different situation

- Notes:** 1. The menu items may be different when the unit works in different mode.
2. Menu items that are not selectable are grayed out.

Time Set and Sleep Timer

Auto Clock Setup

- The time is set automatically from a digital channel signal.
- The digital channel signal includes information for the current time provided by the broadcasting station.
- Set the clock manually, if the current time is set incorrectly by the auto clock function.

- 1 Press **MENU** to display the menu main page.
- 2 Press **▲** or **▼** repeatedly to select **Feature** menu, press **OK** or **▶** to access the submenu.
- 3 Highlight **Time Set** menu item, press **OK** or **▶** to access the **Time Set Menu**.
- 4 Highlight **Time Set Mode** and then use **OK** or **▶** to select **Auto**.
- 5 Highlight **Time Zone** and then use **OK** or **▶** to select your viewing area time zone: **Pacific, Alaska, Hawaii, Eastern, Central, Mountain**.
- 6 Press **EXIT** button to return to TV viewing or press **MENU** button to return to the previous menu.

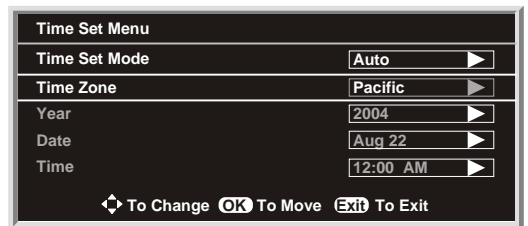
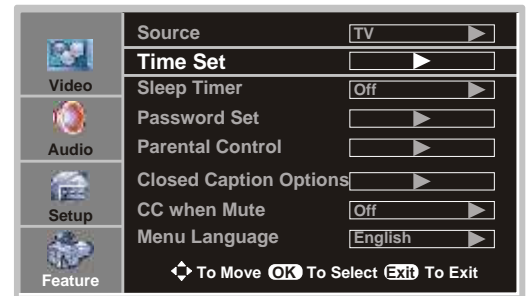

Manual Clock Setup

- If current time setting is wrong, reset the clock manually.

- 1 Navigate to the **Feature** sub-menu, highlight **Time Set Mode** and then use **OK** or **▶** to select **Manual**.
- 2 Press **▲** or **▼** to select either the Year, Date, or Time option. Once selected, use **OK** or **◀ / ▶** to set the year, date, and time options.
- 3 Press **EXIT** button to return to TV viewing or press **MENU** button to return to the previous menu.

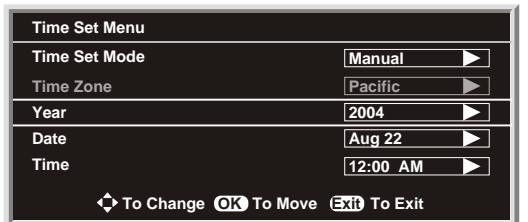

Note: if you power off the TV set, the clock setting will be cleared.

Sleep timer

Sleep timer lets you select the amount of time before your TV turns itself off automatically.

Navigate to the **Feature** sub-menu, highlight **Sleep Timer** and then use **OK** or **▶** to select the amount of time. To turn off sleep timer, select **Off**.

Note: you may directly press **SLEEP** button on the remote control to set sleep timer.

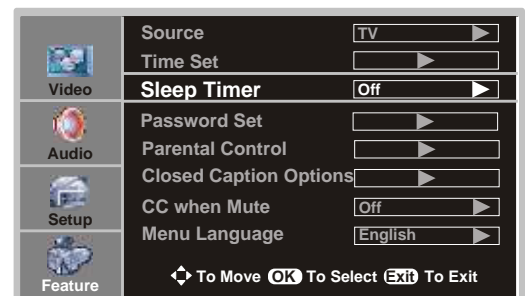

Viewing Closed Captions

The unit decodes and displays the closed captions that are broadcast with certain TV shows. These captions are usually subtitles for the hearing impaired or foreign language translations. All VCRs record the closed caption signal from television programs, so home-recorded video tapes also provide closed captions. Most prerecorded commercial video tapes provide closed captions as well. Check for the closed caption symbol in your television schedule and on the tape's packaging: .

Note:

The Caption feature does not work with Component, VGA, HDMI.

Not all the programs and videos will offer closed captioning. Please look for the  symbol to ensure that captions will be shown.

Analog Broadcasting System Captions

- Select a caption mode for displaying captioning information if provided on a program.
- Analog caption displays information on the screen usually the program's dialog.

Press **CCD** button on the remote control to select caption mode: CC1, CC2, CC3, CC4, TEXT1, TEXT2, TEXT3 or TEXT4.

To turn off closed captioning, press **CCD** repeatedly to select **Off**.

The Closed Caption broadcasts can be viewed in two modes: CAPTION and TEXT. For each mode, four channels are available.

The [CAPTION] mode shows subtitles of dialogues and commentaries of TV dramas and news programs while allowing a clear view of the picture.

The [TEXT] mode displays various information over the picture (such as TV program schedule, weather forecast, etc.) that is independent of the TV programs.

Digital Broadcasting System Captions

- You can customize the digital closed captions that appear on your screen.

- 1 Navigate to the **Feature** sub-menu, highlight **Closed Caption Options** and then use **OK** or **▶** to open the **Digital Closed Caption** sub-menu.
- 2 Highlight **Style** and then use **OK** or **▶** to select **Custom**.
- 3 Press **▲** or **▼** to select your desired item, and then use **OK** or **▶** to customize the Size, Font, etc. to your preference. A preview sample is provided at the bottom of the menu screen for you to see the effect.
 - .. **Size**: Set the size the words will appear in.
 - .. **Font**: Select a typeface for the words.
 - .. **Text Color**: Choose a color for the text.
 - .. **Text Opacity**: Specify the opacity for the text color.
 - .. **Background Color**: Select a background color.
 - .. **Background Opacity**: Select the opacity for the background color.
 - .. **Edge Effect**: Select an edge effect.
 - .. **Edge Color**: Select a color for the edges.

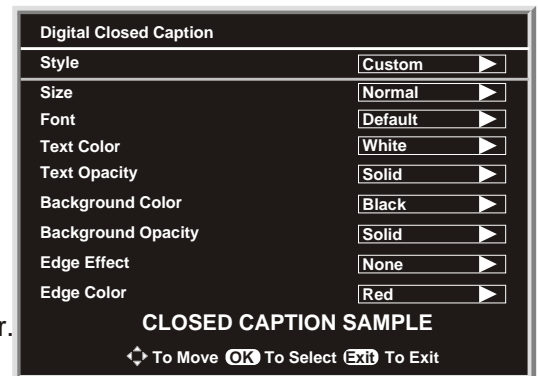
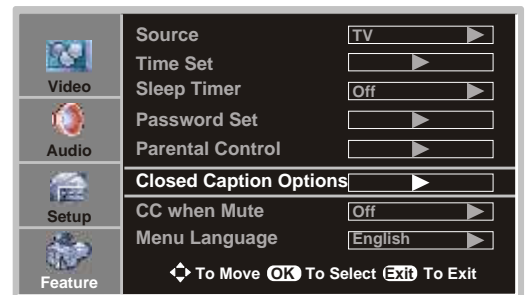

Setting CC When Mute

- 1 Navigate to the **Feature** sub-menu, highlight **CC when Mute**.
- 2 Press **OK** or **▶** to select **On** or **Off**.
When **On** is selected, the unit will automatically display closed caption when you mute the sound.

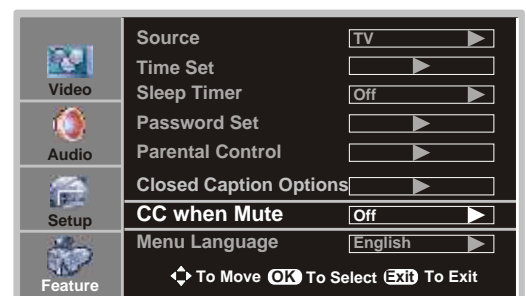

Setting Parental Control

Parental Control

This function allows TV programs to be restricted and TV usage to be controlled based on FCC data. It prevents children from watching violent or sexual scenes that may be harmful.

Restriction of TV programs includes two ratings that contain information about the program: the MPAA rating and the TV Parental Guidelines. The MPAA rating is restricted by age. TV Parental Guidelines are restricted by age and content.

Since a TV program may use either the MPAA rating or the TV Guidelines, both should be adjusted for complete control.

[1] Movie Rating (MPAA)

Rating		
age based	G	GENERAL AUDIENCES. All ages admitted.
	PG	PARENTAL GUIDANCE SUGGESTED. Some material may not be suitable for children.
	PG-13	PARENTAL STRONGLY CAUTIONED. Some material may be inappropriate for children under 13.
	R	RESTRICTED. Under 17 requires accompanying parent or adult guardian.
	NC-17	NO ONE 17 AND UNDER ADMITTED.
	X	X Rating is an older rating that is unified with NC-17 but may be encoded in the data of older movies.
	NONE	NOT RATED.

Note:

The Movie rating is only age-based.

Example 1:

“PG-13” in the age-based rating is blocked, this will automatically block the higher ratings “R”, “NC-17”, “X” also.

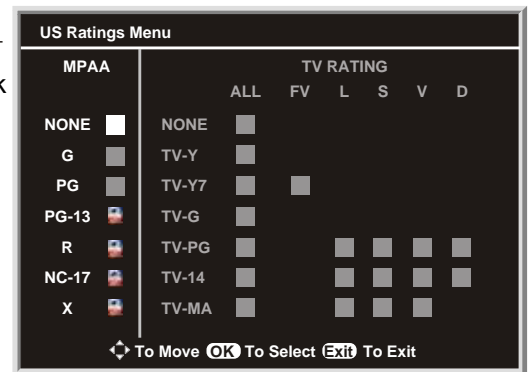

Example 2:

“R” in the age-based rating is blocked, this will automatically block the higher rating “NC-17”, “X” also.

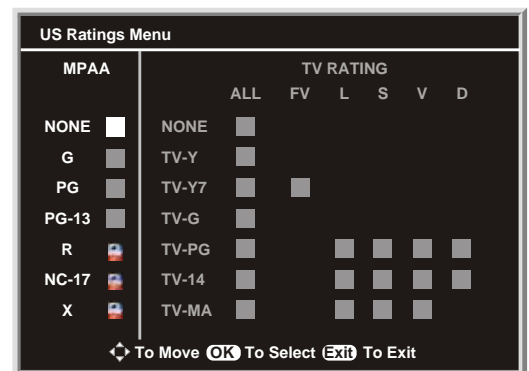

Setting Parental Control(continued)

[2] TV Rating

Rating		← content based →				
		D	V	S	L	FV
age based	TV-Y (All children)	×	×	×	×	×
	TV-Y7 (Direct to Older Children)	×	×	×	×	●
	TV-G (General Audience)	×	×	×	×	
	TV-PG (Parental Guidance Suggested)	●	●	●	●	
	TV-14 (Parents Strongly Cautioned)	●	●	●	●	
	TV-MA (Mature Audience Only)		●	●	●	

- × ——— Content Rating can be set but this Rating is not
 ● ——— Content Rating can be set.
- D: Sexually Suggestive Dialog
 V: Violence
 S: Sexual Situation
 L: Adult Language
 FV: Fantasy Violence

Note:

Age-based ratings can be modified by the content-based ratings but only in the combinations indicated by an ● in the table above.

Choosing lower age-based rating blocks the higher age-based ratings regardless of content ratings settings.

Example 1:

When TV-Y in the age-based rating is set to BLOCK, this will automatically block the higher rating: TV-Y7.

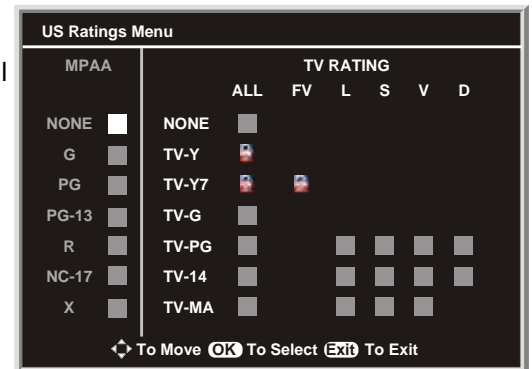

Example 2:

When TV-G in the age-based rating is set to BLOCK, this will automatically block the higher ratings: TV-PG, TV-14, TV-MA.

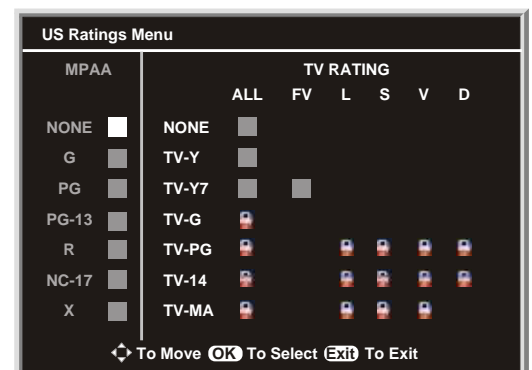

Setting Parental Control(continued)

Password Setup

To use the Parental Control function, you first need to set your password.

- 1 Navigate to the **Feature** sub-menu, highlight **Parental Control** and then use **OK** or **▶** to access **Parental Control Menu**.
- 2 Highlight **Password Change** and then use **OK** or **▶** to access.
- 3 Input old password (4-digit, the preset password is 0000), then input a new password and then confirm again. Now your new password has been created successfully. **Be sure to write down your password and retain it for future use.**

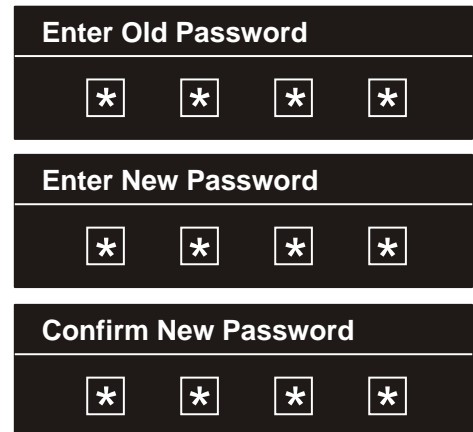
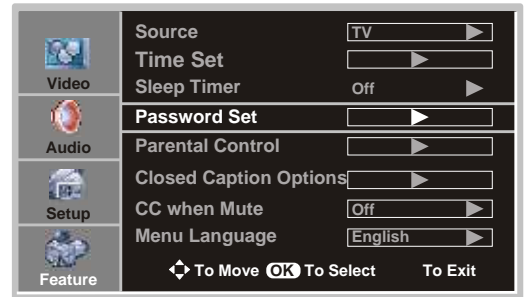

MPAA Rating Setup

- 1 Navigate to the **Feature** sub-menu, highlight **Parental Control** and then use **OK** or **▶** to access **Parental Control Menu**.
- 2 Highlight **Parental Control Set** and then use **OK** or **▶** to access.
- 3 Input your password correctly to access **Parental Control Set Menu**.
- 4 Within the menu, use **▲**, **▼**, **◀** or **▶** to navigate, use **OK** to block or unblock the rating.

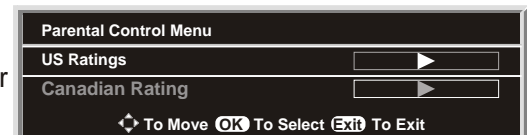
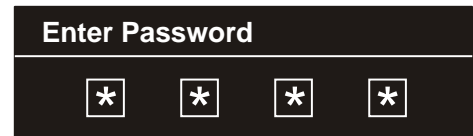

When "PG-13" in the age-based rating is blocked, this will automatically block the higher ratings "R", "NC-17", "X" also.

TV Rating Setup

- 1 Navigate to the **Feature** sub-menu, highlight **Parental Control** and then use **OK** or **▶** to access **Parental Control Menu**.
- 2 Highlight **Parental Control Set** and then use **OK** or **▶** to access.
- 3 Input your password correctly to access **Parental Control Set Menu**.
- 4 Within the menu, use **▲**, **▼**, **◀** or **▶** to navigate, use **OK** to block or unblock the rating.

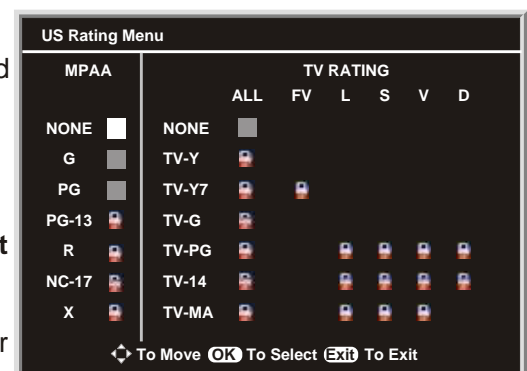

When TV-Y in the age-based rating is set to BLOCK, this will automatically block the higher rating: TV-Y7.

When TV-G in the age-based rating is set to BLOCK, this will automatically block the higher ratings: TV-PG,TV-14,TV-MA.

Setting Parental Control (continued)

Canadian English Rating Setup

1 Input password to navigate to **Parental Control Menu**, press **▲** or **▼** to highlight the **Canadian Rating**, and press **OK** to access Canadian Rating Menu.

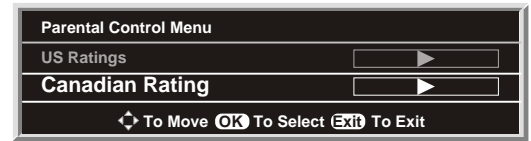

2 Within the menu, use **▲**, **▼**, **◀** or **▶** to navigate, and use **OK** to block or unblock the rating.

When PG in the age-based rating is set to BLOCK, this will automatically block the higher rating: 14+, 18+.

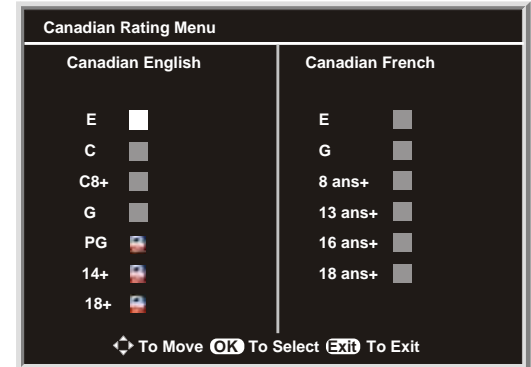

CANADIAN ENGLISH RATING CHART

E	Exempt - Exempt programming includes: news, sports, documentaries and other information programming, talk shows, music videos, and variety programming.
C	Programming intended for children under age 8. No offensive language, nudity or sexual content.
C8+	Programming generally considered acceptable for children 8 years and over. No profanity, nudity or sexual content.
G	General programming, suitable for all audiences.
PG	Parental Guidance suggested. Some material may not be suitable for children.
14+	Programming contains themes or content which may not be suitable for viewers under the age of 14. Parents are strongly cautioned to exercise discretion in permitting viewing by pre-teens and early teens.
18+	Intended for viewers 18 years and older and might contain depictions of violence.

Setting Parental Control(continued)

Canadian French Rating Steup

- 1 Input password to nevigate to **Parental Control Menu**, press **▲** or **▼** to highlight the **Canadian Rating**, and press **OK** to access Canadian Rating Menu.
- 2 Within the menu, use **▲**, **▼**, **◀** or **▶** to navigate, and use **OK** to block or unblock the rating.

When 13 ans+ in the age-based rating is set to BLOCK, this will automatically block the higher rating: 16 ans+, 18 ans+.

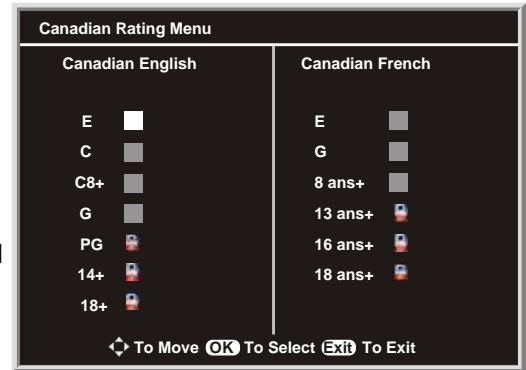

CANADIAN FRENCH RATING CHART

E	Exempt - Exempt programming.
G	General - Programming intended for audience of all ages. Contains no violence, or the violence content is minimal or is depicted appropriately.
8 ANS+	8+ General - Not recommended for young children. Programming intended for a broad audience but contains light or occasional violence. Adult supervision recommended.
13 ANS+	Programming may not be suitable for children under the age of 13 - Contains either a few violent scenes or one or more sufficiently violent scenes to affect them. Adult supervision strongly suggested.
16 ANS+	Programming may not be suitable for children under the age of 16 - Contains frequent scenes of violence or intense violence.
18 ANS+	Only for adult viewing. Could contain frequent violent scenes and extreme violence.

Advanced Rating Steup

If the broadcasting program uses RRTS (Rating Region Table-Region 5) criteria rating in accordance with the FCC Rules, its rating can be downloaded to this TV and can be used for parental controls.

- 1 Input password to nevigate to **Parental Control Menu**, press **▲** or **▼** to highlight the **Advanced Rating**, and then use **OK** or **▶** to select **On**. Now **Advanced Parental Lock** menu item appears.
- 2 Highlight **Advanced Parental Lock**, use **OK** or **▶** to access.
- 3 Press **▲** or **▼** to select the desired item, and press **OK** or **▶** to access next-level menu.
- 4 Within the menu, use **▲**, **▼**, **◀** or **▶** to navigate and select, and use **OK** to block or unblock the rating.

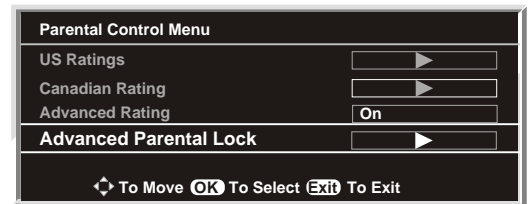

Notes:

The OSD illustration shown above is with digital signal.

The menu items may be different when the unit works in different mode.

Troubleshooting

Before calling for repair service, check the following items for possible remedies to an encountered symptom.

Symptoms	Check item
No power	<ul style="list-style-type: none"> • Check that the AC power cord is plugged into the mains socket. • Unplug the power cord, wait for 60 seconds. Then re-insert plug into the mains socket and turn on the unit again.
No picture	<ul style="list-style-type: none"> • Check video connections at the rear of the unit to see if it is properly connected to the unit. • Adjust the contrast and brightness settings. • Select a correct input. • Is a non-compatible signal being input?
Good picture but no sound	<ul style="list-style-type: none"> • Increase the VOLUME. • Check that the unit is not muted.
Good sound but poor color	<ul style="list-style-type: none"> • Adjust the contrast, color and brightness settings.
Poor picture	<ul style="list-style-type: none"> • Sometimes, poor picture quality occurs when an activated S-VHS camera or camcorder is connected while another activated peripheral is connected. In this case, switch off one of the peripherals. • Check whether the room is too bright.
Horizontal dotted line	<ul style="list-style-type: none"> • This may be caused by electrical interference (e.g. hairdryer, nearby neon lights, etc.). • Turn off the equipment.
Remote operation fails.	<ul style="list-style-type: none"> • This remote control is a universal remote control. If the remote control does not work correctly when operating the monitor, try pressing the TV button. • Check whether the batteries are working. Replace if necessary. • Clean the remote control sensor lens on the unit. • Do not use the remote control under strong or fluorescent lighting. • The batteries should be inserted with polarity (+, -) aligned.
Snowy picture and noise	<ul style="list-style-type: none"> • Check the A/V connections.
No stable or not synchronized VGA picture	<ul style="list-style-type: none"> • Check if you have selected the correct VGA mode in your PC.
No output from one of the speakers	<ul style="list-style-type: none"> • Adjust Balance in the SOUND menu.
Control buttons do not work.	<ul style="list-style-type: none"> • Unplug the power cord, wait for a few seconds. Then re-plug the power cord and turn on the unit again.

+ Do not use in hot and cold rooms (locations)

- When the unit is used in rooms (locations) with low temperature, the picture may leave trails or appear slightly delayed. This is not a malfunction, and the unit will recover when the temperature returns to normal.
- Do not leave the unit in a hot or cold location. Also, do not leave the unit in a location exposed to direct sunlight or near a heater, as this may cause the cabinet to deform and the LCD panel to malfunction.

(Storage temperature: 0°C to +50°C Working temperature: 5°C to +40°C)

Note:

If your problem is not solved, turn your unit off and then on again.

Never attempt to repair a LCD TV yourself.

Care and Maintenance

LCD Display panel information

Note:

The marking or retained image on the LCD panel resulting from fixed image use is not an operating defect and as such is not covered by Warranty. This product is not designed to display fixed image patterns for extended periods of time.

Important Information Regarding Use of Video Games, Computers, Captions or Other Fixed Image Displays.

The extended use of fixed image program material can cause a permanent "shadow image" on the LCD panel.

This background image is viewable on normal programs in the form of a stationary fixed image. This type of irreversible LCD panel deterioration can be limited by observing the following steps:

- A. Reduce the brightness/contrast setting to a minimum viewing level.
- B. Do not display the fixed image for extended periods of time.
- C. Turn the power off when not in actual use.

Cleaning and Maintenance

To clean this unit, wipe with a soft, dry cloth.

If the surfaces are extremely dirty, use a soft cloth dipped in a soap and water solution or a weak detergent solution.

- Use eyeglass cleaner to remove stubborn dirt from the LCD.
- Never use alcohol, paint thinner or benzine to clean this unit.
- Before using a chemically treated cloth, read the instructions that came with the cloth carefully.

CAUTION :

If water or similar substances get inside the monitor via the liquid crystal panel surface, a malfunction may result.

Specifications

Screen:	26"	32"		
Power supply:	AC 100-240V 50/60Hz	AC100-240v 50/60Hz		
Power consumption:	140W	170W		
Standby:	<1W	<1W		
Resolution:	1366 x 768	1366 x 768		
Unit Dimensions (WxHxD, inches):	28.1 X 23.9 X 9.3	33 x 27.3 x 10.25		
Weight (lbs):	41.8	50.6		
Channel coverage:				
VHF	UHF	CATV	CADTV	DTV
2-13	14-69	1-125	1-135	2-69
TV system:	NTSC-M, ATSC			
Accessories:	Operating manual x 1			
	Remote control x 1			



- 1. Design and specifications are subject to change without notice.**
- 2. Weight and dimensions shown are approximate.**
- 3. Specifications and external appearance may be changed for the sake of improvement.**

Programming your Remote Control

Introduction

Your remote lets you control four devices with one easy-to-use, compact unit. After installing batteries, you can program the remote to control your VCR or DVD, Cable or Satellite Receivers, Amplifier or Tuner, and Auxiliary devices. To do so, follow the instructions in "Programming a Device". For best results, please read and follow all the remaining instructions. Keep this guide for future reference.

Note: The universal remote control unit can't be programmed to control a TV with other brand. It has been preset to control this TV set, and this preset is unchangeable.

A Quick Look at Programming a Device

To control VCR or DVD, Cable or Satellite Receivers, Amplifier or Tuner, and Auxiliary devices, follow these steps. Before proceeding, find the codes for the devices you want to program in "Manufacturer's Codes" in next following pages and write them down or highlight them.

NOTE: To program a DVD Player, portable DVD player, or mobile DVD player, use the **DVD** key.

1. Turn on the device (for example, DVD player) and, if needed, load media (for example, a DVD).
2. Press a device key (**VCR/DVD**, **CBL/ SAT**, or **AUX**).
3. Press and hold **SET** until the red LED blinks twice; then release.
4. Enter the first five-digit code for your device. The LED blinks once as each digit is entered. If the code is correct, the LED blinks twice.
 - **NOTE:** If the LED does not blink twice, repeat steps 2 to 4 and try entering the code again.
5. Aim the remote at the device and press **Power**. The device should turn off. If it does not, repeat steps 3 to 5, trying each code for your brand until you find one that works. If you cannot find a code that works, see "Searching for Your Code".
6. Repeat steps 1 to 5 for the other devices you want to control. For future reference, write down each working device code below:
 - AUX** Code:
 - CBL** Code:
 - CD** Code:
 - DVD** Code:
 - SAT** Code:
 - TNR** Code:
 - VCR** Code:
7. Press set to save and exit

Searching for your Code

If your device does not respond to the remote after trying all codes listed for your brand, or if your brand is not listed, try searching for your code:

1. Press a device key once.
2. Press and hold **SET** until the red LED blinks twice; then release.
3. Enter **9-9-1**, then the device group number (0= Cable, 2= VCR, 3= Audio). The LED blinks twice.
4. Aim the remote at the device and press **Power**. The remote sends IR codes from its library to the selected device, starting with the most popular code first. If the device responds, go to step 7.
5. If the device does not respond, press **CH+**. The remote will try the next code. Continue until the device responds.
 - **NOTE:** Press **CH-** to try the previous code.
6. To search for other device codes, repeat steps 1 to 5.
7. Press **SET** to save and exit.

Checking the Codes

If you have set up the remote using the procedure in "Searching for Your Code", you may need to find out which four-digit code is operating your equipment.

For example, to find out which code is assigned to your DVD:

1. Press **DVD** once.
2. Press and hold **SET** until the red LED blinks twice; then release.
3. Enter **9-9-0**. The LED blinks twice.
4. To view the code for the first digit, press **1**. Count the LED blinks (for example, three blinks = 3), and write down the number in the appropriate code listing in step 6 under "Programming a Device".
 - **NOTE:** If a code digit is **0**, the LED does not blink.
5. Repeat step 4 for the four remaining digits, using **2** for the second digit, **3** for the third digit, **4** for the fourth digit, and **5** for the fifth digit.
6. To check for other device codes, repeat steps 1 to 5, substituting the device key for **DVD**.

Changing Volume Lock

The remote comes preset to allow independent volume control of each selected device (Global Volume Unlock). However, you may change the Volume Lock setting to Global Volume Lock so that one device's volume will control volume in all other modes. After that, you can perform Individual Volume Unlock on a selected device to set its volume control for independent operation or Global Volume Unlock to remove all volume locking.

Locking Volume Control to One Mode (Global Volume Lock)

1. Press and hold **SET** until the red LED blinks twice; then release.
2. Enter **9-9-3** and then press the mode key for the device you want to control volume (for example, **DVD**). The LED blinks twice. Now when you press **VOL+**, **VOL-**, or **Mute**, the selected device (for example, **DVD**) will control the volume regardless of the current mode.

Unlocking All Volume Control (Restoring Global Unlock)

1. Press and hold **SET** until the red LED blinks twice; then release.
2. Enter **9-9-3** and then press **VOL+**. The LED blinks four times.

Volume is now independently controlled for all programmed devices.

Unlocking a Single Device's Volume Control

1. Press a device key (**VCR/DVD**, **CBL/ SAT**, or **AUX**).
2. Press and hold **SET** until the red LED blinks twice; then release.
3. Enter **9-9-3** and then press **VOL-**. The LED blinks four times.

Volume is now independently controlled for the selected devices.

Troubleshooting

PROBLEM: LED does not blink when you press a key.

SOLUTION: Replace with new batteries.

PROBLEM: LED blinks when you press a key, but device does not respond.

SOLUTION: Make sure the remote is aimed at your device and is not more than 15 feet away.

PROBLEM: LED blinks one long blink.

SOLUTION: An entry error has occurred (for example, wrong key). Try entry sequence again.

PROBLEM: Remote does not control devices or commands are not working properly.

SOLUTION: Try all listed codes for the device. Make sure the device operates with an infrared remote control.

PROBLEM: No volume on a device.

SOLUTION: See "Changing Volume Lock".

MANUFACTURER'S CODES

Set Codes for Audio Amplifiers

Bose	30674
GE	30078
JVC	30331
Marantz	30321
Nakamichi	30321
NEC	30264
Optimus	30395
Realistic	30395
Sansui	30321
Shure	30264
Sony	30689
Soundesign	30078
Victor	30331
Wards	30078
Yamaha	30354, 30133

Set Codes for Audio Amp/Tuners

ADC	30531
Aiwa	31405, 31243, 30121
Anam	31609, 31074
Audiotronic	31189
Bose	31229
Capetronic	30531
Carver	31189
Coby	31263
Denon	31360, 31142, 30904
Fonmix	31360
Glory Horse	31263
Harman/Kardon	30110
Hitachi	31273
Inkel	30027
Integra	30135
JBL	30110
JVC	30074, 31263
Kenwood	31313, 31570, 30027
KLH	31428
Magnavox	31189, 31269, 30531
Marantz	31189, 31269, 30039
MCS	30039
Onkyo	30842, 30135
Optimus	31023, 30670, 30531, 31074
Panasonic	31518, 30039
Philips	31189, 31269
Pioneer	31023, 30150, 30014, 30630, 30531
Proscan	31254
Qisheng	31609
Quasar	30039
RadioShack	31263
RCA	31023, 31609, 31254, 30531, 31074
Sharper Image	31263
Silsonic	30176
Sony	31258, 31759
Soundesign	30670
Stereophonics	31023
Sunfire	31313
Teac	31074, 31267
Technics	31308, 31518, 30039
Thorens	31189
Victor	30074
Wards	30014
Yamaha	30176, 31276, 31176

Set Codes for Cable Converters

ABC	00003, 00008, 00014
Americast	00899
Bell & Howell	00014
Bell South	00899
Clearmaster	00883
ClearMax	00883
Coolmax	00883
Daeryung	01877, 00877, 00477, 00008
Digi	00637
Director	00476
Dumont	00637
Gehua	00476
General Instrument	00476, 00810, 00276, 00003, 00014
GoldStar	00144
Hamlin	00009, 00273
Hitachi	00014
Jerrold	00476, 00810, 00276, 00003, 00012, 00014
KNC	00008
LG	00144
Memorex	00000
Motorola	00476, 00810, 00276, 01254, 01376
MultiVision	00012
Pace	01877, 00237
Panasonic	00000, 00008, 00107
Panther	00637
Paragon	00000
Philips	00317, 01305
Pioneer	01877, 00877, 00144, 00533
Pulsar	00000
Quasar	00000
RadioShack	00883
Regal	00279, 00273
Runco	00000
Samsung	00000, 00144
Scientific Atlanta	01877, 00877, 00477, 00008
Sony	01006
Starcom	00003, 00014
Supercable	00276
Supermax	00883
Tocom	00012
Torx	00003
Toshiba	00000
Trans PX	00276
Tristar	00883
TS	00003
V2	00883
Viewmaster	00883
Vision	00883
Vortex View	00883
Zenith	00000, 00525, 00899

Set Codes for CD Players

Aiwa	30157
Burmester	30420
California Audio Labs	30029
Carver	30157, 30179
Denon	30873
DKK	30000
DMX Electronics	30157
Dynamic Bass	30179
Fisher	30179
Garrard	30420
Genexxa	30032
Harman/Kardon	30157, 30173

Hitachi	30032
Integra	30101
JVC	30072
Kenwood	30826, 30626, 30028, 30037, 30036, 30190
Krell	30157
Linn	30157
Magnavox	30157
Marantz	30626, 30029, 30157
MCS	30029
Miro	30000
Mission	30157
MTC	30420
NSM	30157
Onkyo	30868, 30101
Optimus	31063, 30000, 30032, 30037, 30420, 30179, 31075, 30145
Panasonic	30029
Parasound	30420
Philips	30626, 30157
Pioneer	31063, 31062, 30032
Polk Audio	30157
Proton	30157
QED	30157
Quad	30157
Quasar	30029
RadioShack	31075
RCA	31062, 30032, 30420, 30179, 30053
Realistic	30420, 30179
Rotel	30157, 30420
SAE	30157
Sansui	30157
Sanyo	30179
SAST	30157
Sharp	30861, 30037
Silsonic	30888, 30036
Sonic Frontiers	30157
Sony	30490, 30000, 30100
Soundesign	30145
TAG McLaren	30157
Tascam	30420
Teac	30420
Technics	30029
Victor	30072
Wards	30157, 30053
Yamaha	30888, 30036
Zonda	30157

Set Codes for DVD Players

Aiwa	20641, 21912
Akai	20770
Allegro	20869
Apex Digital	20672, 20717, 20797, 21061, 20796, 21056, 21937, 20794, 21020, 21915
Blaupunkt	20717
Blue Parade	20571
Broksonic	20695
Changhong	20627, 21061
CineVision	20869
Coby	21086
Curtis Mathes	21087
CyberHome	21024, 21023, 21129, 20816, 21117
Daewoo	20833, 21172, 20869
Denon	20490
DVD2000	20521
Emerson	20591, 20675

Enterprise	20591
Fisher	21919
Funai	20675
Gateway	21158, 21073
GE	20522, 20717
Go Video	20744, 20833, 21099, 20783, 21075, 20869, 21730
Greenhill	20717
Harman/Kardon	20582, 20702
Hitachi	20573, 20664, 21919
Hiteker	20672
Initial	20717
Integra	20627, 21924
JBL	20702
JVC	20558, 20623, 20867
Kenwood	20490, 20534
KLH	20717, 21020, 21149
Koss	20651, 21980
Lasonic	20798
LG	20591, 20869, 20801
Liquid Video	21980
Lite-On	21158, 21058
Loewe	20511
Magnavox	20503, 20539, 21976, 21914, 20675
Marantz	20539
Memorex	20695
Microsoft	20522
Mintek	20717
Mitsubishi	21521, 20521
Nesa	20717
Norcent	21003
Onkyo	20503, 20627, 21924, 20792
Oritron	20651, 21980
Panasonic	20490, 21762, 21990
Philips	20503, 20539, 20646, 21914
Pioneer	20525, 20571
Polaroid	21086, 21061
Polk Audio	20539
Portland	20770
Proscan	20522
Qwestar	20651
RCA	20522, 20571, 20717, 20822
Rio	20869
Rotel	20623
Sampo	20752, 20698
Samsung	20490, 20573, 21932, 21075, 20820
Sansui	20695
Sanyo	20695
Sharp	20630, 20752
Sharper Image	21117
Sherwood	20770
Shinco	20717
Shinsonic	20533
Sonic Blue	20869, 21099
Sony	20533, 20864, 21033, 21904, 21903
SVA	20717
Sylvania	20675
Symphonic	20675
Teac	20717, 21984, 20809
Technics	20490
Theta Digital	20571
Toshiba	20503, 20695
Urban Concepts	20503
Xbox	20522
Yamaha	20490, 20539, 20545
Zenith	20503, 20591, 20869

Set Codes for Satellite Receivers

AlphaStar	00772
Chaparral	00216
Crossdigital	01109
DirectTV	00392, 00566, 00639, 01142, 00247, 00749, 01749, 00724, 00819, 01856, 01076, 01109, 00099, 01392, 01640, 01442, 01414, 01108
Dish Network System	01005, 00775, 01505
Dishpro	01005, 00775, 01505
Echostar	01005, 00775, 01505
Expressvu	00775
GE	00566
General Instrument	00869
GOI	00775
Goodmans	01246
Hisense	01535
Hitachi	00819, 00222, 01250
HTS	00775
Hughes Network Systems	01142, 00749, 01749, 01442
I-Lo	01535
JVC	00775
LG	01414, 01226
Magnavox	00724, 00722
Memorex	00724
Mitsubishi	00749
Motorola	00869
NEC	01270
Next Level	00869
Panasonic	00247, 00701
Paysat	00724
Philips	01142, 00749, 01749, 00724, 01076, 00722, 00099, 01442
Proscan	00392, 00566
Proton	01535
RadioShack	00869
RCA	00392, 00566, 00855, 00143, 01392
Samsung	01276, 01109, 01108
Sanyo	01219
SKY	00856
Sony	00639, 01640
Star Choice	00869
Tivo	01142, 01442
Toshiba	00749, 01749, 00790, 01285
UltimateTV	01640, 01392
Uniden	00724, 00722
US Digital	01535
USDTV	01535
Voom	00869
Zenith	00856, 01856

Set Codes for VCRs

ABS	21972
Admiral	20048, 20209
Aiko	20278
Aiwa	20037, 20479
Alienware	21972
America Action	20278
American High	20035
Amoisonic	20479
Anam	20162, 20037, 20240, 20278
Anam National	20162
Asha	20240
Audiovox	20037, 20278
Beaumarck	20240
Bell & Howell	20104
Broksonic	20184, 20121, 20209, 20002, 20479
Calix	20037
Canon	20035
Carver	20081
CCE	20072, 20278
Changhong	20048, 20081
Citizen	20037, 20278
Colt	20072
Craig	20037, 20047, 20240, 20072
Curtis Mathes	20060, 20035, 20162
Cybernex	20240
CyberPower	21972
Daewoo	20045, 20104, 20278
Dell	21972
Denon	20042
DirectTV	20739
Durabrand	20039, 20038
Electrohome	20037
Electroponic	20037
Emerex	20032
Emerson	20035, 20037, 20184, 20240, 20045, 20121, 20043, 20209, 20002, 20278, 20479
Fisher	20047, 20104
Fuji	20035, 20033
Fujitsu	20045
Gateway	21972
GE	20060, 20035, 20240
General	20045
Go Video	20432
GoldStar	20037, 20209, 20038, 20225
Haojie	20240
Harman/Kardon	20081, 20038
Harwood	20072
Hewlett Packard	21972
HI-Q	20047
Hitachi	20037, 20042, 20055
Howard Computers	21972
HP	21972
Hughes Network Systems	20042, 20739
iBUYPOWER	21972
JVC	20045, 20067
KEC	20037, 20278
Kenwood	20067, 20038
KLH	20072
Kodak	20035, 20037
Kolin	20043
LG	20037, 20045, 20042, 20209, 20038
Logik	20072
LXI	20037
Magnavox	20035, 20039, 20081
Magnin	20240
Marantz	20035, 20081
Marta	20037

Matsushita	20035, 20162
Media Center PC	21972
MEI	20035
Memorex	20035, 20162, 20037, 20048, 20039, 20047, 20240, 20104, 20209, 20479
MGA	20240, 20043
MGN Technology	20240
Microsoft	21972
Mind	21972
Minolta	20042
Mitsubishi	20067, 20043
Motorola	20035, 20048
MTC	20240
Multitech	20072
NEC	20035, 20037, 20048, 20104, 20067, 20038
Newave	20037
Nikko	20037
Noblex	20240
Northgate	21972
Olympus	20035
Optimus	21062, 20162, 20037, 20048, 20104, 20432
Orion	20184, 20209, 20002, 20479
Panasonic	21062, 20035, 20162, 20616, 20225
Penney	20035, 20037, 20240, 20042, 20038
Pentax	20042
Philco	20035, 20479
Philips	20035, 20081, 20739, 20618
Pilot	20037
Pioneer	20042, 20067
Polk Audio	20081
Profitronic	20240
Proscan	20060
Protec	20072
Pulsar	20039
Qisheng	20060
Quasar	20035, 20162
Radix	20037
Randex	20037
RCA	20060, 20035, 20240, 20042, 20880
Realistic	20035, 20037, 20048, 20047, 20104
ReplayTV	20616
Runco	20039
Sampo	20037, 20048
Samsung	20240, 20045, 20432
Sanky	20048, 20039
Sansui	20067, 20209, 20479
Sanyo	20047, 20240, 20104
Scott	20184, 20045, 20121, 20043
Sears	20035, 20037, 20047, 20042, 20104
Sharp	20048, 20209
Shintom	20072
Shogun	20240
Singer	20072
Sonic Blue	20616
Sony	20035, 20032, 20033, 20636, 21972
STS	20042
Sylvania	20035, 20081, 20043
Systemax	21972
Tagar Systems	21972
Tashiko	20037
Tatung	20045, 20067
Technics	20035, 20162
Teco	20035, 20037, 20048, 20038
Teknika	20035, 20037
Tivo	20636, 20618, 21503, 20739
TMK	20240
Toshiba	20045, 20042, 20067, 20043, 21503, 21008, 21972

Totevision	20037, 20240
Touch	21972
Unitech	20240
Vector	20045
Vector Research	20038
Victor	20067
Video Concepts	20045
Videomagic	20037
Videosonic	20240
Viewsonic	21972
Wards	20060, 20035, 20048, 20047, 20081, 20240, 20042, 20072
White Westinghouse	20209, 20072
XR-1000	20035, 20072
Yamaha	20038
Zenith	20039, 20033, 20209, 20479
ZT Group	21972

CARE

- Keep the remote dry. If it gets wet, wipe it dry immediately.
- Use and store the unit only in normal temperature environments.
- Handle the remote gently and carefully. Don't drop it.
- Wipe the remote with a damp cloth to keep it looking like new.

SANYO COMFORT WARRANTY

WARRANTY APPLICATION

New, unused Sanyo Color Television products purchased in Canada through a Sanyo authorized dealer are warranted against manufacturing defects in materials and workmanship for ONE YEAR for parts and labor, from the date of purchase by the original retail purchaser for non-commercial use. This warranty only applies in favor of the original retail purchaser of the warranted product.

SANYO CANADA INC.'S RESPONSIBILITY

During the warranty period, SANYO Canada Inc. will repair, or at our option, replace a Color Television product which shows evidence of a manufacturing defect in materials or workmanship.

Replacement PARTS are warranted for the remaining portion of the warranty period.

WHAT IS NOT COVERED

- (a) Color Television products purchased outside Canada.
- (b) Color Television products purchased in a used condition.
- (c) Problems due to product set-up and installation.
- (d) Adjustments that are outlined in the Operating Manual.
- (e) Accessory items including antenna, batteries and connecting cables.
- (f) Damage in or due to transportation.
- (g) Damage due to improper maintenance, accident, abuse, misuse or negligence.
- (h) Damage caused by lightning and power surges.

ORIGINAL RETAIL PURCHASER'S RESPONSIBILITY

You, the original retail purchaser, must present your original, dated bill-of-sale together with this warranty to SANYO Canada Inc. or to an authorized Sanyo Service Depot* when you make a claim under this warranty.

You, the original retail purchaser, are responsible for any costs of TRANSPORTING the product to and from SANYO Canada Inc. or an authorized Sanyo Service Depot. You also are responsible for the cost of any MAINTENANCE necessary in respect of the product.

*In-home service is only available to the units whose screen size is 40 inches or over, and limited to the locations within a 30-km radius of any authorized Sanyo Service Depot, throughout Canada.

WARRANTY BECOMES VOID This warranty becomes void if the product's serial numbers are altered or removed or if any repair to the product is made other than by SANYO Canada Inc. or by an authorized Sanyo Service Depot.

LIMITATIONS

- (a) SANYO Canada Inc. reserves the right to change or improve the design of the model of the product warranted hereunder without incurring any obligation to make any modifications to or to install any improvement in or on the product.
- (b) In no event shall SANYO Canada Inc. or any of its Authorized Dealers be liable for special or consequential damage arising from the use of this product.

STATUTORY WARRANTIES

The above provisions do not preclude the operation of any applicable provincial statute which in certain circumstances may not allow some of the limitations and exclusions described in this Warranty. Where any terms of this Warranty are prohibited by such a statute, they shall be deemed null and void but the remainder of this warranty shall remain in effect.

HOW TO OBTAIN WARRANTY SERVICE

Please contact the Sanyo Authorized Dealer from whom the product was purchased or contact us directly at:

SANYO Canada Inc.
300 Applewood Cres.
Concord Ont. L4K 5C7
(905) 760-9944



**PRINTED ON
RECYCLED PAPER**

604.L26FB263-00

Free Manuals Download Website

<http://myh66.com>

<http://usermanuals.us>

<http://www.somanuals.com>

<http://www.4manuals.cc>

<http://www.manual-lib.com>

<http://www.404manual.com>

<http://www.luxmanual.com>

<http://aubethermostatmanual.com>

Golf course search by state

<http://golfingnear.com>

Email search by domain

<http://emailbydomain.com>

Auto manuals search

<http://auto.somanuals.com>

TV manuals search

<http://tv.somanuals.com>