



INSTRUCTION MANUAL

FLAT-PANEL TV

AVP4232

42''* 720p PLASMA

AVL472

47''* 1080p
(Full HD) LCD

AVP504

50''* 1080p
(Full HD) PLASMA



* Diagonal measure

Caution! Avoid image burn-in problems. Please consult page 31.

Help Line: 1-800-263-2244
Monday to Friday 9am-5pm (Eastern)

www.sanyo.ca



Thank you for choosing SANYO. This product incorporates latest-generation features including an ATSC digital tuner. Please read all instructions carefully to obtain maximum benefit of your product. Questions? Our toll-free number is 1-800-263-2244, 9am-5pm, Monday to Friday (Eastern time).

Table of Contents

Important Information	1
Important Safety Precautions.....	2
Important Notice	5
Preparations	6
Identification of Controls	9
Connections	13
Basic Operations.....	17
Memorizing the Channels	19
Channel Selection.....	21
Picture Adjustment	22
Sound Adjustment	23
System Setup	24
Setting up Closed Captioning	25
Clock and Timer Setup	26
Setting Parental Lock.....	27
Image Adjustments for VGA (PC) Mode.....	29
Troubleshooting.....	30
Specifications.....	32
Warranty.....	33

Important Information

WARNING: TO REDUCE THE RISK OF FIRE OR ELECTRIC SHOCK, DO NOT EXPOSE THIS APPARATUS TO RAIN OR MOISTURE.

	CAUTION RISK OF ELECTRIC SHOCK DO NOT OPEN	
CAUTION- To reduce the risk of electric shock, do not perform any servicing other than that contained in the operating instructions unless you are qualified to do so.		

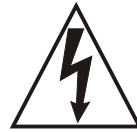

The lightning flash with arrowhead symbol, within an equilateral triangle is intended to alert the user to the presence of uninsulated dangerous voltage within the product's enclosure that may be of sufficient magnitude to constitute a risk of electric shock to persons.



The exclamation point within an equilateral triangle is intended to alert the user to the presence of important operating and maintenance (servicing) instructions in the literature accompanying the appliance.

This product utilizes tin-lead solder, and fluorescent lamp containing a small amount of mercury. Disposal of these materials may be regulated due to environmental considerations. For disposal or recycling information, please contact your local authorities or the Electronic Industries Alliance: www.eia.org

Important Safety Precautions

Electrical energy can perform many useful functions, but it can also cause personal injuries and property damage if improperly handled. This product has been engineered and manufactured with the highest priority on safety. But **IMPROPER USE CAN RESULT IN POTENTIAL ELECTRICAL SHOCK OR FIRE HAZARD**. In order to prevent potential danger, please observe the following instructions when installing, operating and cleaning the product. To ensure your safety and prolong the service life of your TV product, please read the following precautions carefully before using the product.

1. Read these instructions---All operating instructions must be read and understood before the product is operated.

2. Keep these instructions---These safety and operating instructions must be kept in a safe place for future reference.

3. Heed all warnings---All warnings on the product and in the instructions must be observed closely.

4. Follow all instructions---All operating instructions must be followed.

5. Do not use this apparatus near water---for example, near a bathtub, washbowl, kitchen sink, or laundry tub, in a wet basement, or near a swimming pool, and the like.

Do not use immediately after moving from a low temperature to high temperature environment, as this causes condensation, which may result in fire, electric shock, or other hazards.



6. Clean only with dry cloth---Unplug this product from the wall outlet before cleaning. Do not use liquid cleaners or aerosol cleaners. Use a damp cloth for cleaning.



7. Ventilation---Do not block any ventilation openings. Install in accordance with the manufacturer instructions. The vents and other openings in the cabinet are designed for ventilation. Do not cover or block these vents and openings since insufficient ventilation can cause overheating and/or shorten the life of the product. Do not place the product on a bed, sofa, rug or other similar surface, since they can block ventilation openings. This product is not designed for built-in installation; do not place the product in an enclosed place such as a bookcase or rack, unless proper ventilation is provided or the manufacturer's instructions are followed.

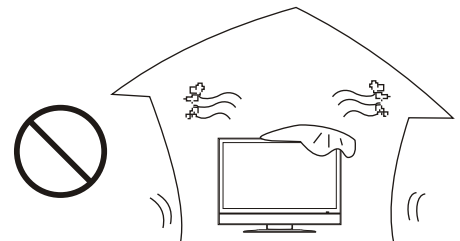

8. Heat sources---Do not install near any heat sources such as radiators, heat registers, stoves, or other apparatus (including amplifiers) that produce heat.

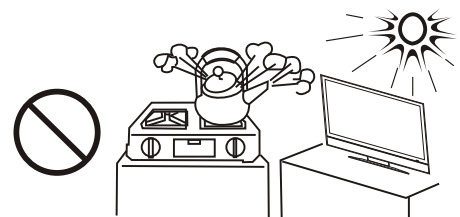

9. Grounding or Polarization---Do not defeat the safety purpose of the polarized or grounding-type plug. A polarized plug has two blades with one wider than the other. A grounding type plug has two blades and a third grounding prong. The wide blade or the third prong are provided for your safety. If the provided plug does not fit into your outlet, consult an electrician for replacement of the obsolete outlet.

10. Power cord protection---Protect the power cord from being walked on or pinched particularly at plugs, convenience receptacles, and the point where they exit from the apparatus.

NOTE: where the mains plug or an appliance coupler is used as the disconnect device, the disconnect device shall remain readily operable.

11. Attachments---Only use attachments/accessories specified by the manufacturer. Do not use attachments not recommended by the manufacturer. Use of improper attachments can result in accidents.

Important Safety Precautions (Continued)

12. Stand---Use only with the cart, stand, tripod, bracket, or table specified by the manufacturer, or sold with the apparatus. Do not place the product on an unstable trolley, stand, tripod or table. Placing the product on an unstable base can cause the product to fall, resulting in serious personal injuries as well as damage to the product. When mounting the product on a wall, be sure to follow the manufacturer's instructions. Use only the mounting hardware recommended by the manufacturer.



13. Move carefully---When a cart is used, use caution when moving the cart/apparatus combination to avoid injury from tip-over. Sudden stops, excessive force and uneven floor surfaces can cause the product to fall from the trolley. Never attempt to move the TV unless the AC power cord has been disconnected.



14. Lightning---Unplug this apparatus during lightning storms or when unused for long periods of time.

For added protection for this television equipment during a lightning storm, or when it is left unattended and unused for long periods of time, unplug it from the wall outlet and disconnect the antenna. This will prevent damage to the equipment due to lightning and power-line surges.

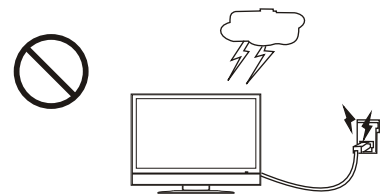

15. Servicing---Refer all servicing to qualified service personnel. Servicing is required when the apparatus has been damaged in any way, such as power-supply cord or plug is damaged, liquid has been spilled or objects have fallen into the apparatus, the apparatus has been exposed to rain or moisture, does not operate normally, or has been dropped.

16. Replacement parts---In case the product needs replacement parts, make sure that the service person uses replacement parts specified by the manufacturer, or those with the same characteristics and performance as the original parts. Use of unauthorized parts can result in fire, electric shock and/or other danger.

17. Overloading---Do not overload wall outlets, extension cords, or convenience receptacles on other equipment as this can result in a risk of fire or electric shock.

18. Entering of objects and liquids---Never insert an object into the product through vents or openings. High voltage flows in the product, and inserting an object can cause electric shock and/or short internal parts. For the same reason, do not spill water or liquid on the product.

19. Damage requiring service---If any of the following conditions occurs, unplug the power cord from the AC outlet, and request a qualified service person to perform repairs.

- When the power cord or plug is damaged.
- When a liquid is spilled on the product or when objects have fallen into the product.
- When the product has been exposed to rain or water.
- When the product does not operate properly as described in the operating instructions.

Do not touch the controls other than those described in the operating instructions. Improper adjustment of controls not described in the instructions can cause damage, which often requires extensive adjustment work by a qualified technician.

- If the product has been dropped or the cabinet has been damaged in any way.
- When the product displays an abnormal condition or exhibits a distinct change in performance. Any noticeable abnormality in the product indicates that the product needs servicing.

20. Safety checks---Upon completion of service or repair work, request the service technician to perform safety checks to ensure that the product is in proper operating condition.

21. Wall or ceiling mounting---When mounting the product on a wall or ceiling, be sure to install the product according to the method recommended by the manufacturer. This is a safety feature.

Important Safety Precautions (Continued)

22. Power source---This product is intended to be supplied by a listed power supply indicated on the marking label. If you are not sure of the type of power supply to your home, consult your product dealer or local power company. For added protection for this product during a lightning storm, or when it is left unattended and unused for long periods of time, unplug it from the wall outlet and disconnect the cable system. This will prevent damage to the product due to lightning and power line surges. When the unit has to be used with another power supply voltage, the power cable must be changed. Consult your product dealer. The socket outlet should be installed near the equipment and easily accessible. Use only the power cord designated by our dealer to ensure safety. When connecting other products such as VCRs and personal computers, you should turn off the power of the unit for protection against electric shock.

23. Panel protection---The display panel used in this product is made of glass. Therefore, it can break when the product is dropped or impacted upon by other objects. Be careful not to be injured by broken glass pieces in case the display panel breaks.

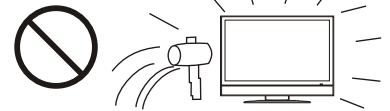

24. Pixel defect---The display panel is a very high technology product, giving you finely detailed pictures. Occasionally, a few non-active pixels may appear on the screen as a fixed point of blue, green or red. Please note that this does not affect the performance of your product.

WARNING: For continued safety, apparatus with class I construction shall be connected to an AC outlet with a protective ground connection.

Important Notice

About Temperature

Do not use in hot and cold rooms (locations)

- When the unit is used in rooms (locations) with low temperature, the picture may leave trails or appear slightly delayed. This is not a malfunction, and the unit will recover when the temperature returns to normal.
- Do not leave the unit in a hot or cold location. Also, do not leave the unit in a location exposed to direct sunlight or near a heater, as this may cause the cabinet to deform and the screen to malfunction.
- Storage temperature: 0°C to +50°C
- Working temperature: 5°C to +40°C

Cleaning and Maintenance (for PLASMA TV)

The front of the display panel has been specially treated. Wipe the panel surface gently using only a cleaning cloth or a soft, lint-free cloth.

- If the surface is particularly dirty, soak a soft, lint-free cloth in a weak detergent solution and then wring the cloth to remove excess liquid. Use this cloth to wipe the surface of the display panel, then wipe it evenly with a dry cloth, of the same type, until the surface is dry.
- Do not scratch or hit the surface of the panel with fingernails or other hard objects. Furthermore, avoid contact with volatile substances such as insect sprays, solvents and thinner, otherwise the quality of the surface may be adversely affected.

If the cabinet becomes dirty, wipe it with a soft, dry cloth.

- If the cabinet is particularly dirty, soak the cloth in a weak detergent solution and then wring the cloth dry. Use this cloth to wipe the cabinet, and then wipe it dry with a dry cloth.
- Do not allow any detergent to come into direct contact with the surface of the Plasma Display.
- If water droplets get inside the unit, operating problems may result.
- Avoid contact with volatile substances such as insect sprays, solvents and thinner, otherwise the quality of the cabinet surface may be adversely affected or the coating may peel off. Furthermore, do not leave it for long periods in contact with articles made from rubber or PVC.

Cleaning and Maintenance (for LCD TV)

To clean this unit, wipe with a soft, dry cloth.

If the surfaces are extremely dirty, use a soft cloth dipped in a soap and water solution or a weak detergent solution.

- Use eyeglass cleaner to remove stubborn dirt from the screen.
- Never use alcohol, paint thinner or benzine to clean this unit.
- Before using a chemically treated cloth, read the instructions that came with the cloth carefully.

Preparations

Removing the Stand (if wall mounting)

Cautions:

1. Carefully handle the unit during setup and consult authorized service personnel to ensure successful installation.
2. Before performing work spread cushioning over the base area to lay the Display on. This will prevent it from being damaged.
3. Disconnect the AC power cord firstly.

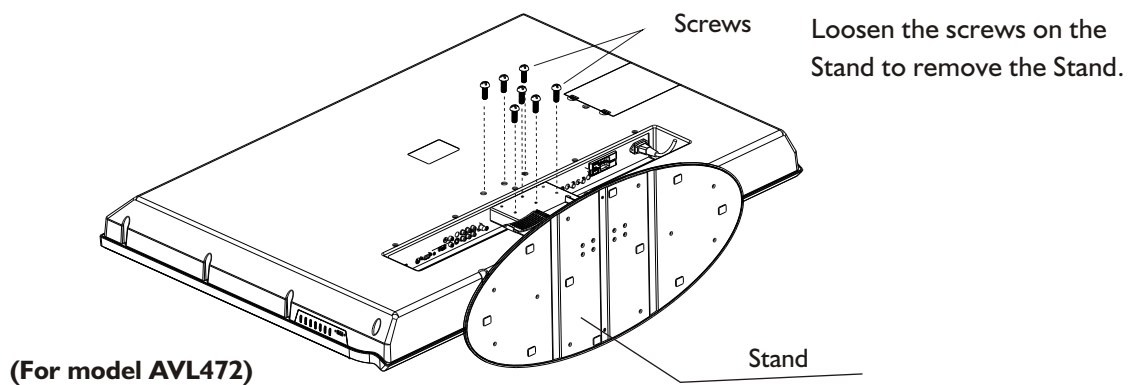
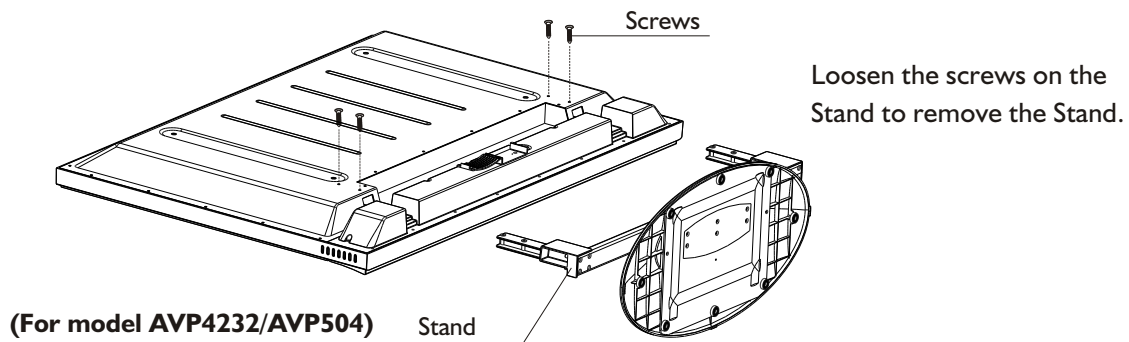

Note

- Do not remove the stand from the Display unless using an optional bracket to mount it.
- The appearance of the unit may differ from the actual one.
- To attach the stand, perform the steps in reverse order.

Preparations

Using the Remote Control

- Use the remote control by pointing it towards the remote sensor window of the set. Objects between the remote control and sensor window may prevent proper operation.

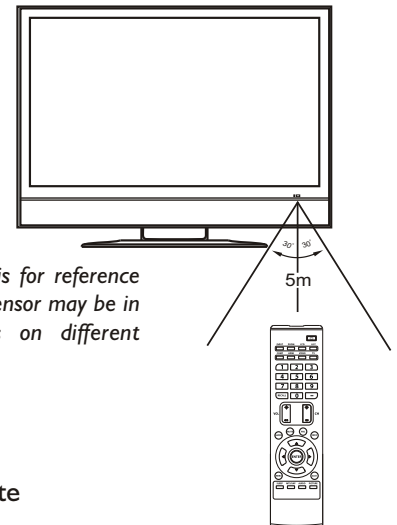

Cautions regarding use of remote control

- Do not expose the remote control to shock. In addition, do not expose the remote control to liquids, and do not place in an area with high humidity.
- Do not install or place the remote control under direct sunlight. The heat may cause deformation of the unit.
- The remote control may not work properly if the remote sensor window of the main unit is under direct sunlight or strong lighting. In such a case, change the angle of the lighting or the TV set, or operate the remote control closer to the remote sensor window.

Installing the Batteries

If the remote control fails to operate the TV functions, replace the batteries in the remote control.

- 1 Open the battery cover.
- 2 Insert two size-AAA batteries.
 - (Place the batteries with their terminals corresponding to the (+) and (-) indications in the battery compartment.)
- 3 Replace the cover and slide in reverse until the lock snaps.

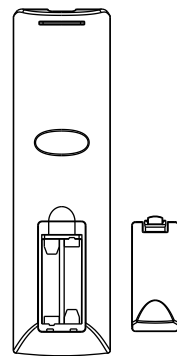

Precaution on battery use

Improper use of batteries can result in a leakage of chemicals and/or explosion. Be sure to follow the instructions below.

- Place batteries with their terminals corresponding to the (+) and (-) indications.
- Different types of batteries have different characteristics. Do not mix batteries of different types.
- Do not mix old and new batteries. Mixing old and new batteries can shorten the life of new batteries and/or cause old batteries to leak chemicals.
- Remove batteries as soon as they are non-operable. Chemicals that leak from batteries can cause a rash. If chemical leakage is found, wipe with a cloth.
- If the remote control is not used for an extended period of time, remove the batteries.
- The batteries shall not be exposed to excessive heat such as sunshine, fire or the like.

Preparations (Continued)

Antenna Connection

INSTALL the unit in a room where direct light will not fall upon the screen. Total darkness or a reflection on the picture screen may cause eyestrain. Soft and indirect lighting is recommended for comfortable viewing.

Optimum reception of colour requires a good signal and will generally mean that a connection for cable system, satellite service or an outdoor antenna must be used. The exact type and position of the antenna will depend upon your particular area.

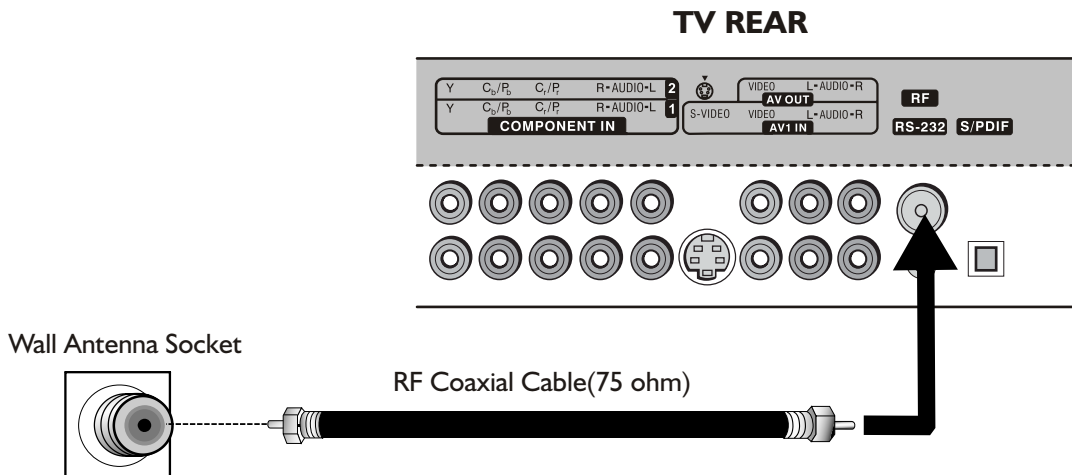

Note

- It is recommended that the 75-ohm coaxial cable be used to eliminate interference and noise which may occur due to radio wave conditions.
- 75-ohm cable should not be bundled with the power cord and the like.
- If an antenna is not installed properly, contact your dealer for assistance.

Power Connection

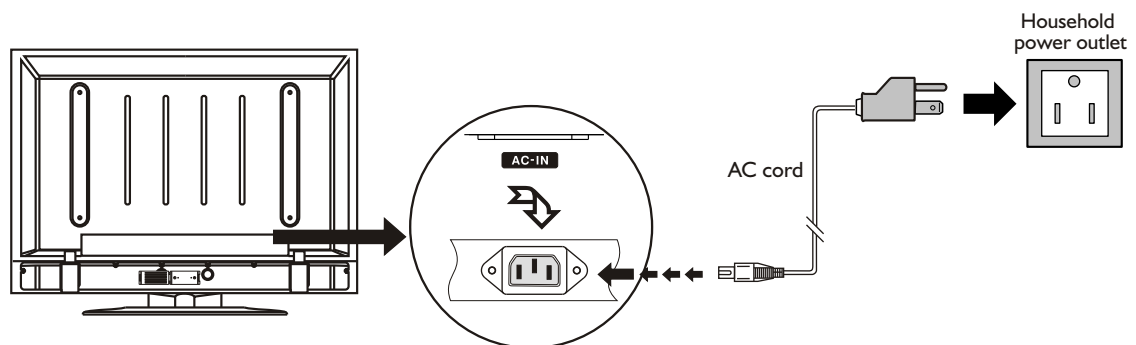

1. Connecting the female plug to the AC socket on the unit.
2. Connecting the male plug to the wall outlet as illustrated.

Note

- This illustration is for reference only. The AC plug may be different on different models.
- This product should be operated only from the type of power source indicated on the marking label.
- Always unplug the AC cord from power outlet when not using for a long period of time.

Identification of Controls

Main Unit (front view/side view)

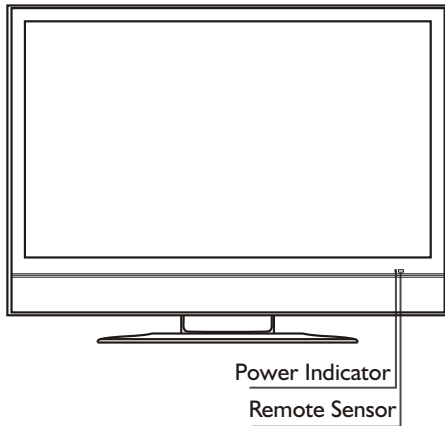

Model AVP4232/AVP504

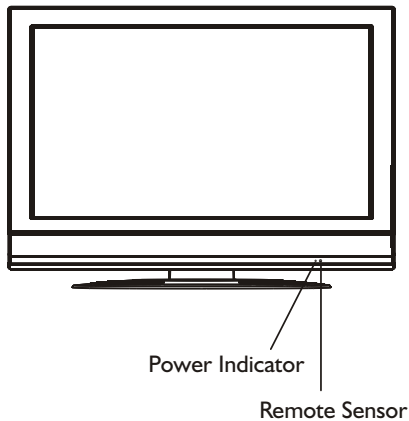
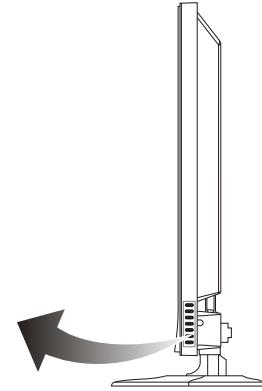
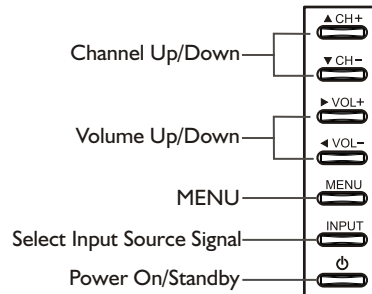

Model AVL472

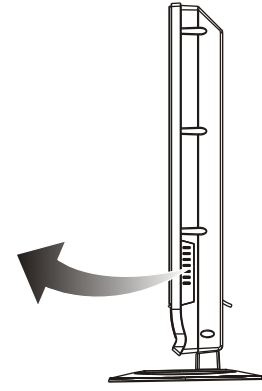
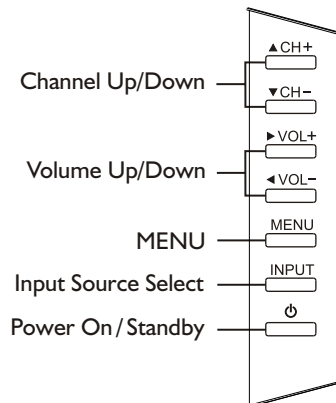

1. POWER ⏻

Press this button to turn the unit ON from STANDBY mode. Press it again to turn the set back to STANDBY.

2. INPUT

To access INPUT SOURCE menu

3. MENU

Press this button to access the menu main page

4. VOL +/- (▶ / ◀)

Press the **VOL+** or **VOL-** button to directly increase or decrease the sound volume level;

In menu operations, these buttons serve as right/left buttons.

5. CH +/- (▲ / ▼)

Press these two buttons to directly change the TV channel;

In menu operations, these buttons serve as up/down buttons.

Note

Functions of **CH +/-** (▲ / ▼), **VOL +/-** (▶ / ◀), **MENU**, **INPUT** and **POWER** ⏻ are also provided to the remote control. This operation manual provides a description based on operating functions with the remote control.

Identification of Controls (Continued)

Main Unit (rear panel)

Model AVP4232/AVP504

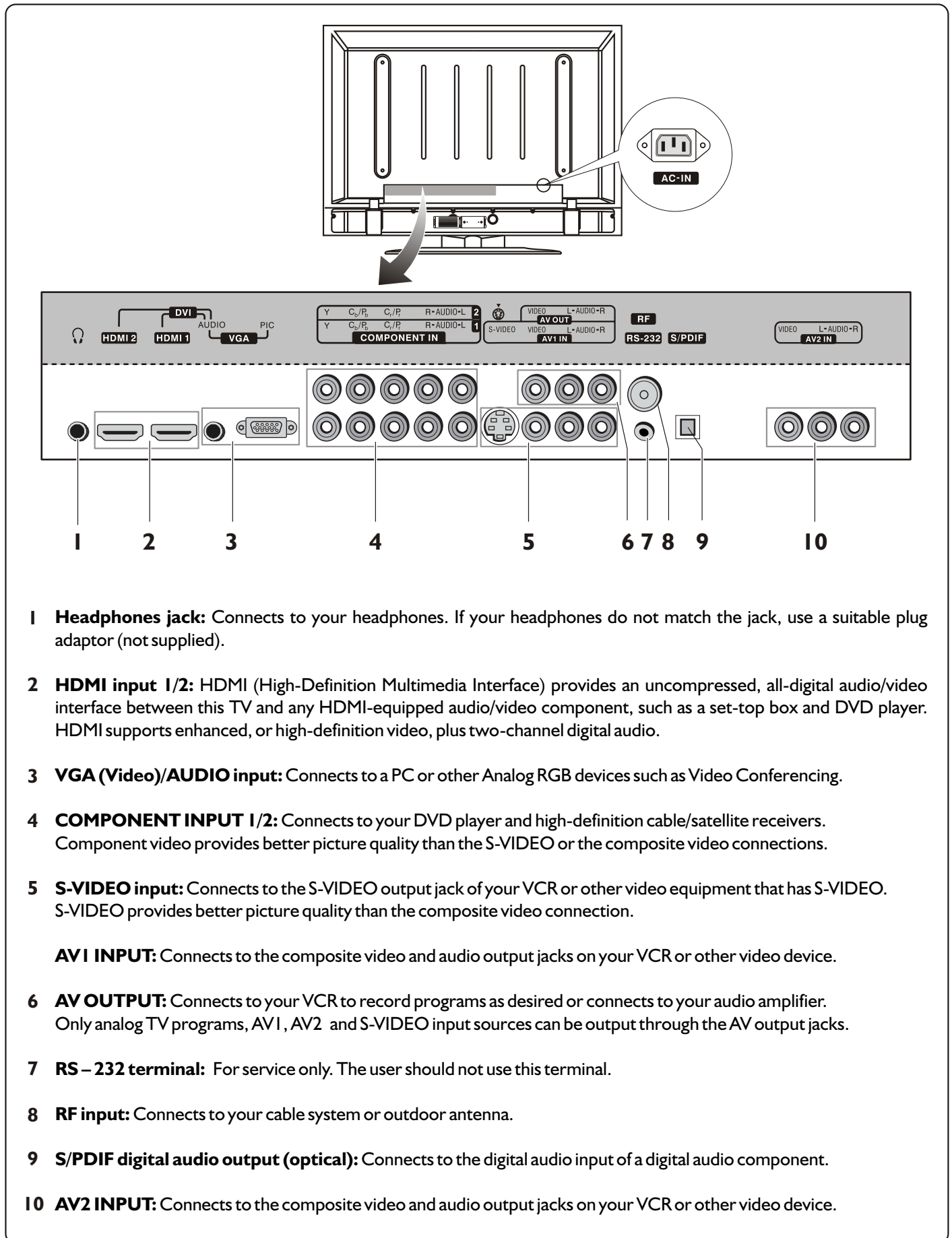

- 1 Headphones jack:** Connects to your headphones. If your headphones do not match the jack, use a suitable plug adaptor (not supplied).
- 2 HDMI input 1/2:** HDMI (High-Definition Multimedia Interface) provides an uncompressed, all-digital audio/video interface between this TV and any HDMI-equipped audio/video component, such as a set-top box and DVD player. HDMI supports enhanced, or high-definition video, plus two-channel digital audio.
- 3 VGA (Video)/AUDIO input:** Connects to a PC or other Analog RGB devices such as Video Conferencing.
- 4 COMPONENT INPUT 1/2:** Connects to your DVD player and high-definition cable/satellite receivers. Component video provides better picture quality than the S-VIDEO or the composite video connections.
- 5 S-VIDEO input:** Connects to the S-VIDEO output jack of your VCR or other video equipment that has S-VIDEO. S-VIDEO provides better picture quality than the composite video connection.
AVI INPUT: Connects to the composite video and audio output jacks on your VCR or other video device.
- 6 AV OUTPUT:** Connects to your VCR to record programs as desired or connects to your audio amplifier. Only analog TV programs, AV1, AV2 and S-VIDEO input sources can be output through the AV output jacks.
- 7 RS-232 terminal:** For service only. The user should not use this terminal.
- 8 RF input:** Connects to your cable system or outdoor antenna.
- 9 S/PDIF digital audio output (optical):** Connects to the digital audio input of a digital audio component.
- 10 AV2 INPUT:** Connects to the composite video and audio output jacks on your VCR or other video device.

Identification of Controls (Continued)

Main Unit (rear panel)

Model AVL472

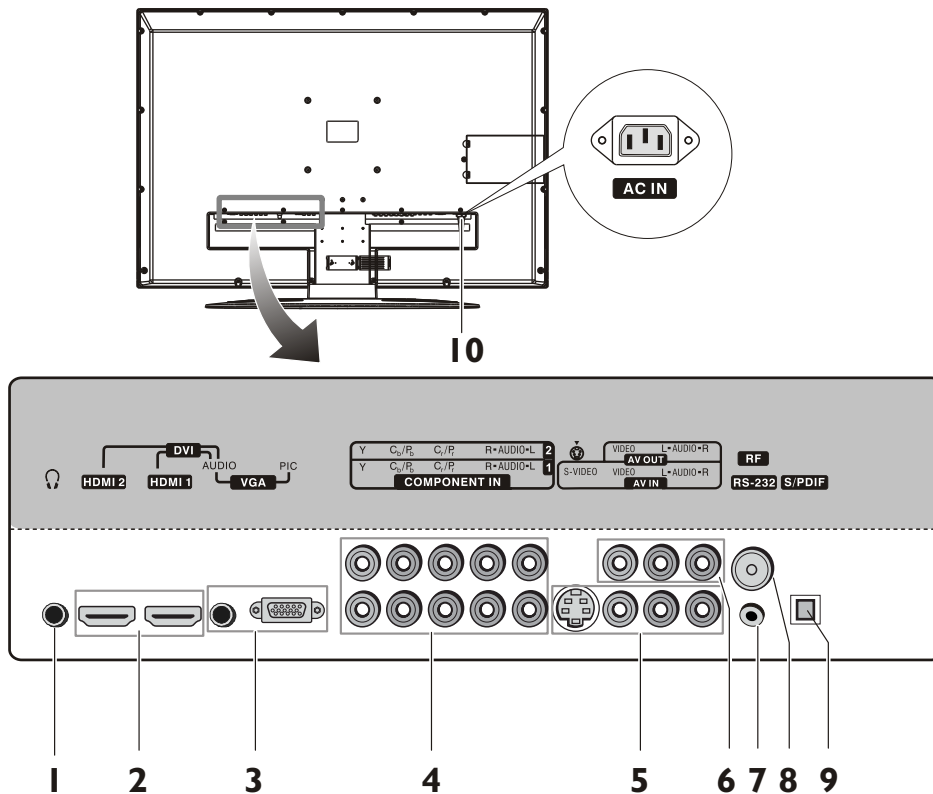

- 1 Headphones jack:** Connects to your headphones. If your headphones do not match the jack, use a suitable plug adaptor (not supplied).
- 2 HDMI input 1/2:** HDMI (High-Definition Multimedia Interface) provides an uncompressed, all-digital audio/video interface between this TV and any HDMI-equipped audio/video component, such as a set-top box and DVD player. HDMI supports enhanced, or high-definition video, plus two-channel digital audio.
- 3 VGA (Video)/AUDIO input:** Connects to a PC or other Analog RGB devices such as Video Conferencing.
- 4 COMPONENT INPUT 1/2:** Connects to your DVD player and high-definition cable/satellite receivers.. Component video provides better picture quality than the S-VIDEO or the composite video connections.
- 5 S-VIDEO input:** Connects to the S-VIDEO output jack of your VCR or other video equipment that has S-VIDEO. S-VIDEO provides better picture quality than the composite video connection.
AV INPUT: Connects to the composite video and audio output jacks on your VCR or other video device.
- 6 AV OUTPUT:** Connects to your VCR to record programs as desired or connects to your audio amplifier. Only analog TV programs, AV and S-VIDEO input sources can be output through the AV output jacks.
- 7 RS – 232 terminal:** For service only. The user should not use this terminal.
- 8 RF input:** Connects to your cable system or outdoor antenna.
- 9 S/PDIF digital audio output (optical):** Connects to the digital audio input of a digital audio component.
- 10 AC IN:** Connect the AC power cord to this jack.

Identification of Controls (Continued)

Remote Control Unit

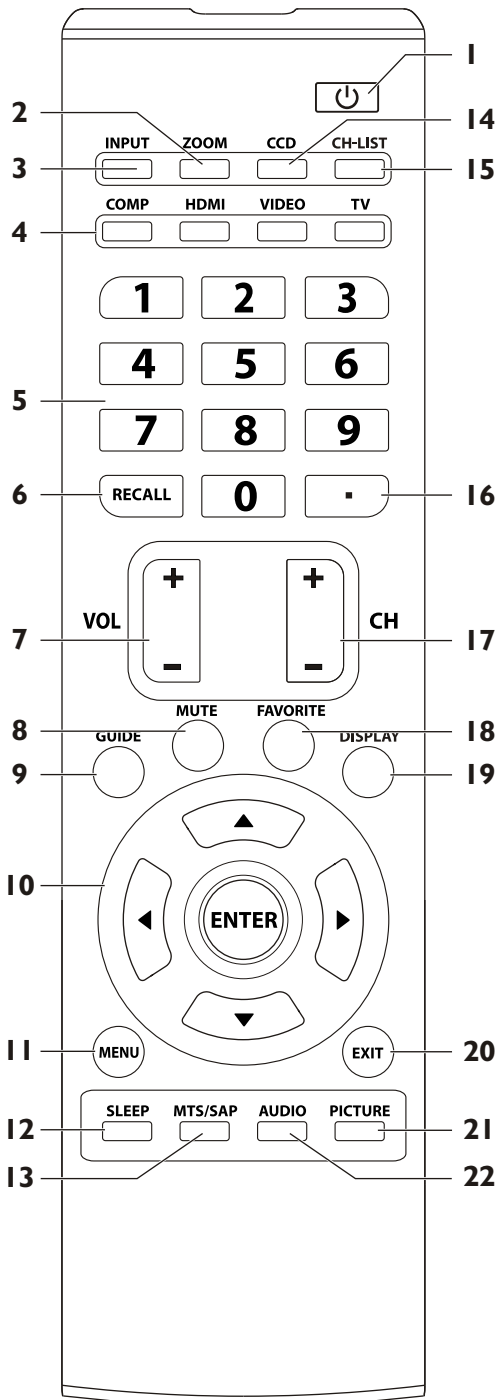

- 1 POWER** : Switches the TV power on or Standby.
- 2 ZOOM**: Selects the screen size.
- 3 INPUT**: Displays input source menu.
- 4 COMP/HDMI/VIDEO/TV**: Direct input source select
COMP: Press once to access Component 1 mode, press twice to access Component 2 mode.
HDMI: Press once to access HDMI 1 mode, press twice to access HDMI 2 mode.
VIDEO: Press once to access AV1 mode, press twice to access AV2 mode, press a third time to access S-Video mode.
TV: Directly access TV mode.
- 5 0 – 9 number buttons**: Press to enter channel numbers or input password.
- 6 RECALL**: Recalls the last viewed channel.
- 7 VOL +/-**: Increases or decreases the volume.
- 8 MUTE**: Mutes the sound.
- 9 GUIDE**: Press to display the program guide information (if available) when watching a DTV program. You may be able to view program broadcasting time and program name from the guide.
- 10** / / / : Menu navigation buttons.
 / : Press to move up or down in the menu.
 / : Press to move left or right in the menu or to adjust a menu setting.
ENTER: Press to confirm a selection and/or enter into a sub-menu.
- 11 MENU**: Displays the main menu screen.
- 12 SLEEP**: Sets the sleep timer.
- 13 MTS/SAP**: To select STEREO, SAP or MONO sound in analog TV mode. To select audio track in DTV mode.
- 14 CCD**: Press to turn closed captioning on or off.
- 15 CH-LIST**: Displays a channel list.
- 16 Dot (.) button**: Press to enter a program number for multiple program channels such as 2-1, or 2-2.
- 17 CH +/-**: Changes channel up and down.
- 18 FAVORITE**: Displays the favorite program list.
- 19 DISPLAY**: Press to display the information banner.
- 20 EXIT**: Press to exit the menu.
- 21 PICTURE**: Selects picture mode.
- 22 AUDIO**: Selects sound mode.

Connections

Cautions Before Connecting

- Carefully check the terminals for position and type before making any connections.
- The illustration of the external equipment may be different depending on your model.
- Loose connectors can result in image or color problems. Make sure that all connectors are securely inserted into their terminals.
- Refer to the operating manual of the external device as well.
- When connecting an external device, turn the power off to avoid any issues.

Connecting a VCR

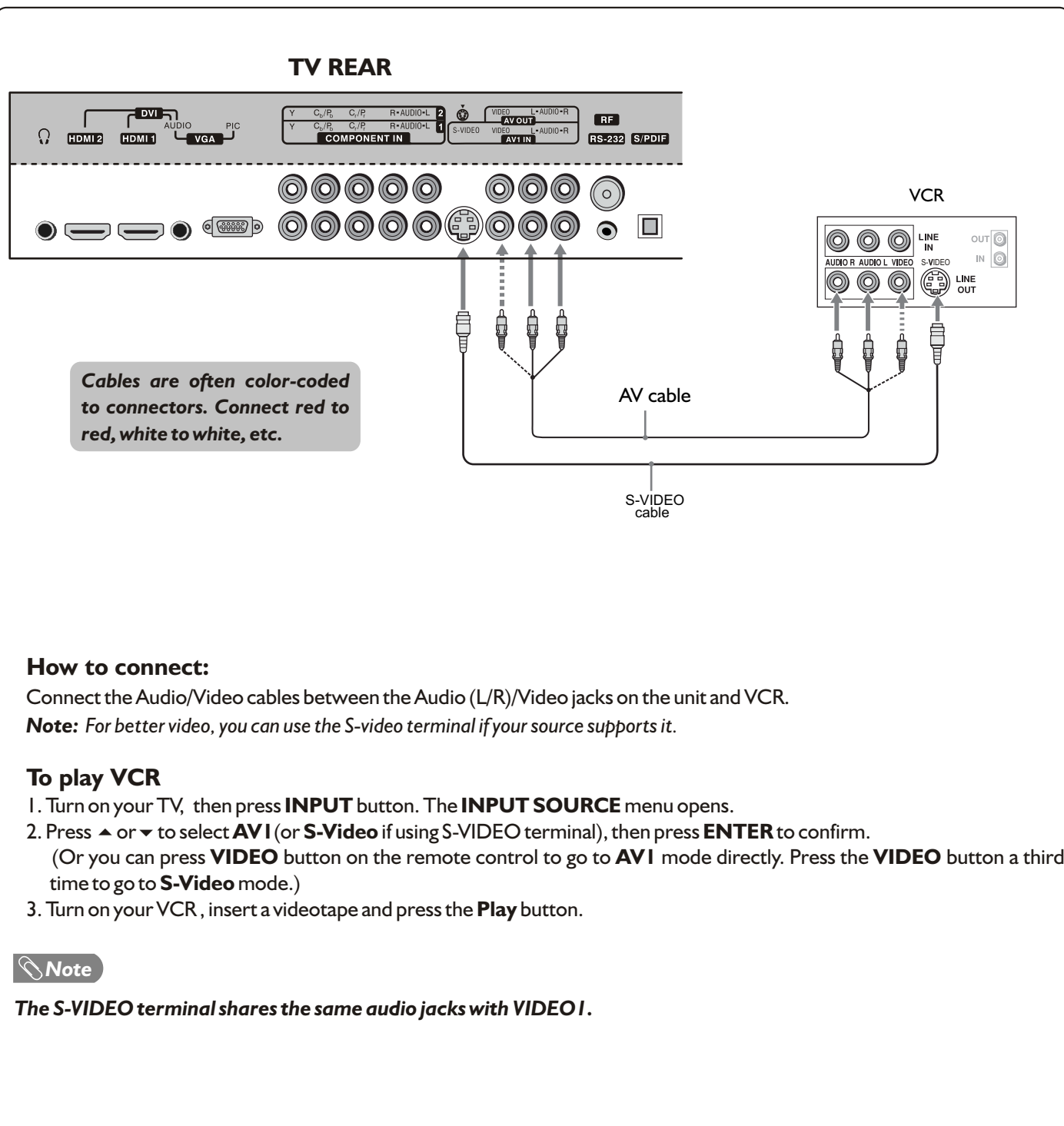

Connections (Continued)

Connecting a Camcorder

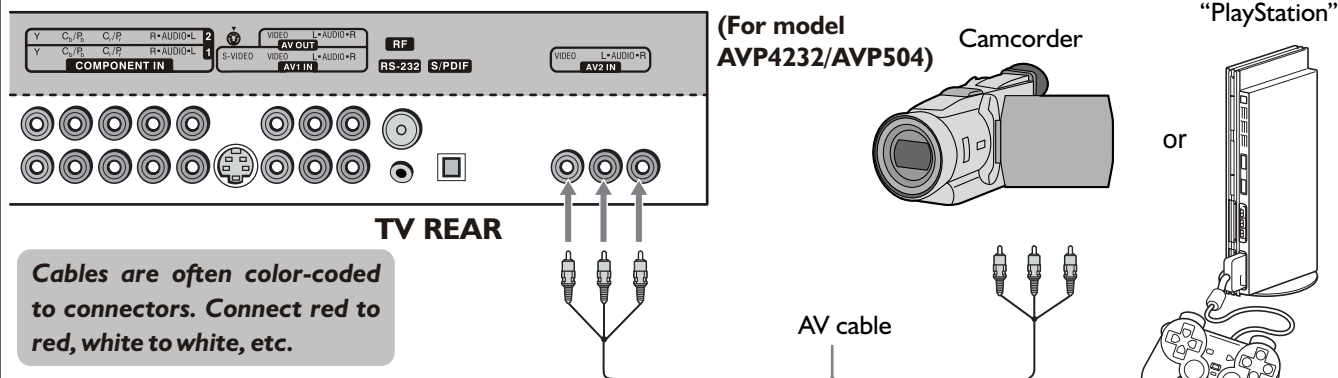

How to connect:

Connect the Audio/Video cables between the Audio (L/R)/Video jacks on the unit and camcorder.

To playback Camcorder

1. Turn on your TV, then press **INPUT** button. The **INPUT SOURCE** menu opens.
2. Press **▲** or **▼** to select **AV2**, then press **ENTER** to confirm.
(Or you can press **VIDEO** button twice to go to **AV2** mode directly.) **If no AV2 on your model, buy a low-cost easily available AV switching box.**
3. Turn on your camcorder and set it to output mode. (For details, refer to your camcorder user manual.)
4. Insert the tape into the camcorder and press **Play** button.

Note

The operations of the camcorder may be different and is dependant on your model. Please read the user manual of your camcorder to confirm operation.

Connecting an HDMI device

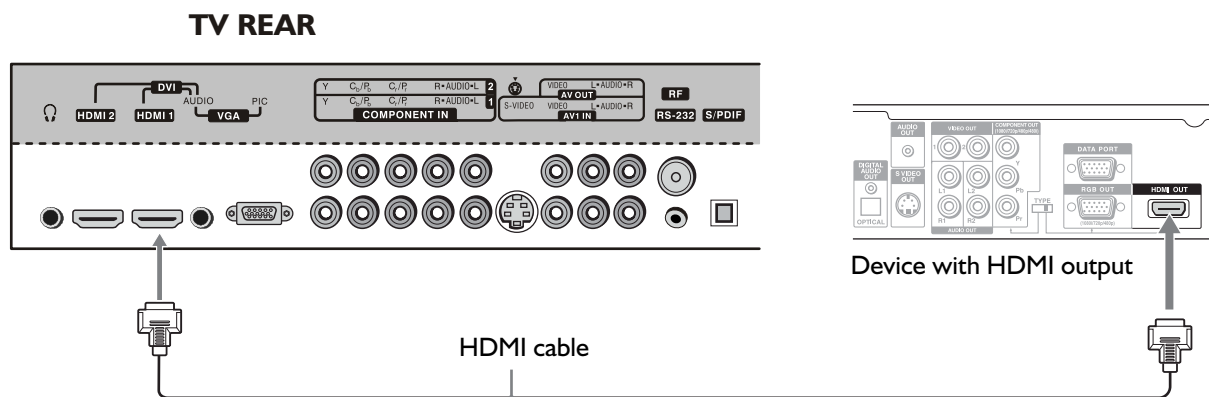

How to connect a device using HDMI Connection:

Connect the HDMI cable between the HDMI interface on the unit and HDMI output on the device.

To play from the device using HDMI:

1. Turn on your TV, then press **INPUT** button. The **INPUT SOURCE** menu opens.
2. Press **▲** or **▼** to select **HDMI 1** (or **HDMI 2** if HDMI 2 interface is used), then press **ENTER** to confirm.
(Or you just press **HDMI** button on the remote control to go to **HDMI 1** mode directly. Press the **HDMI** button once again to go to **HDMI 2** mode.)
3. Turn on your device and set it to the correct mode. See the device's user guide for more information.

Note

● If the external device has DVI output only, use a DVI to HDMI adapter cable to connect to the HDMI terminal. Connect the audio cable to the VGA AUDIO IN jack on the TV rear.

Connections (Continued)

Connecting Component Video

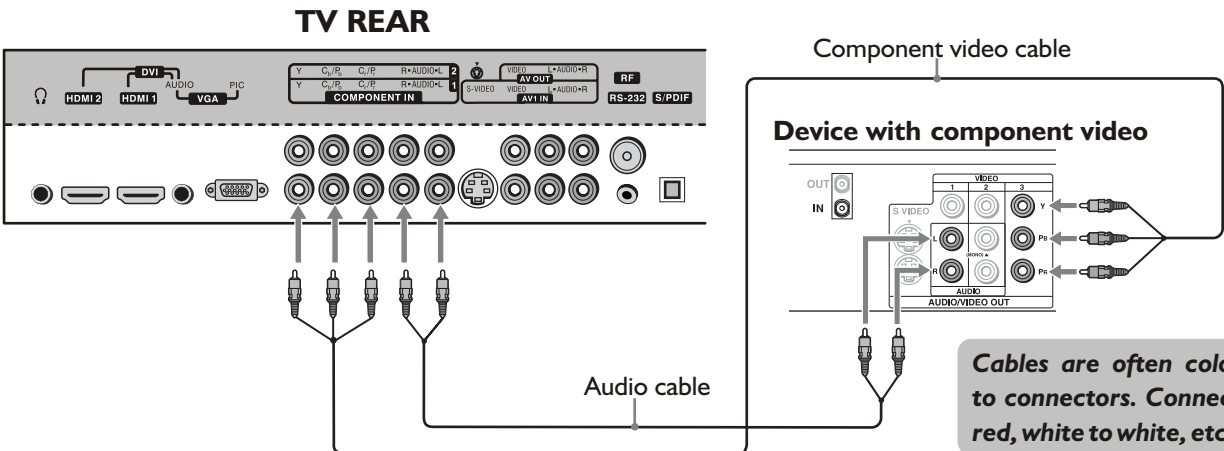

TV REAR

Component video cable

Device with component video

Audio cable

Cables are often color-coded to connectors. Connect red to red, white to white, etc.

To connect a device using component video:

Connect the Component Video cable between the Y, Cb/Pb, Cr/Pr input jacks on the unit and Y, Cb/Pb, Cr/Pr output jacks on the device.

Connect the Audio cable between the AUDIO input jacks on the unit and AUDIO output jacks on the device.

To play component video from an external device:

1. Turn on your TV, then press **INPUT** button. The **INPUT SOURCE** menu opens.
2. Press **▲** or **▼** to select **Component 1** (or **Component 2**), then press **ENTER** to confirm.
(Or you can press **COMP** button on the remote control to go to **Component 1** mode directly. Press the **COMP** button once again to go to **Component 2** mode.)
3. Turn on your external device and set it to the correct mode. See the device's user guide for more information.

Connecting a Computer

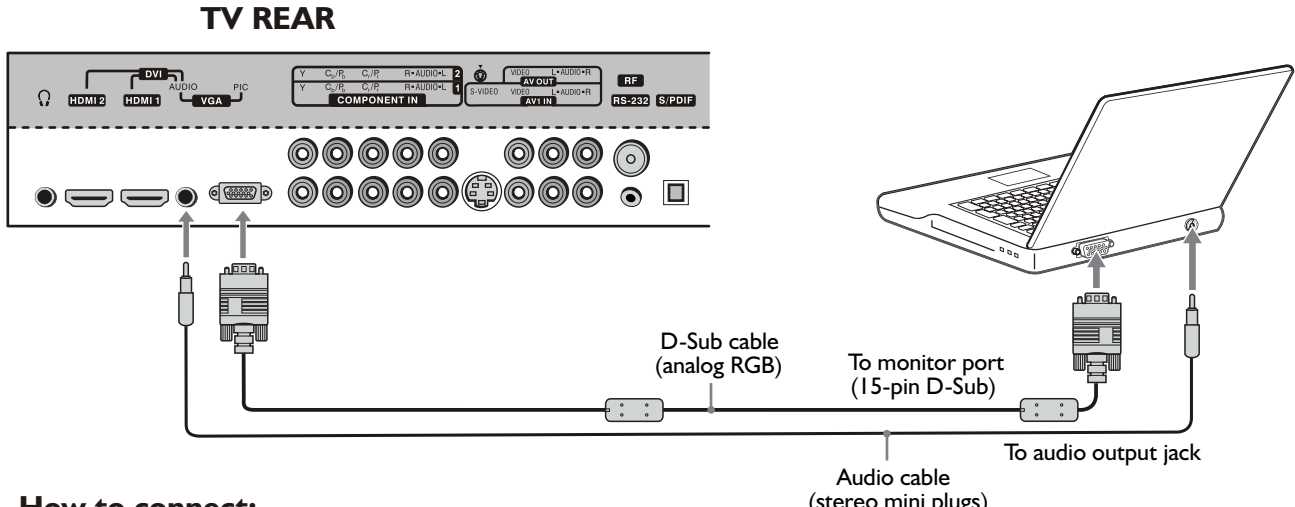

TV REAR

D-Sub cable (analog RGB)

To monitor port (15-pin D-Sub)

To audio output jack

Audio cable (stereo mini plugs)

How to connect:

Connect a VGA cable between the VGA jack on the computer and the VGA input jack on the unit.

Connect an Audio cable between the AUDIO output on the computer and AUDIO input jack on the unit.

To play video from a computer

1. Turn on your TV, then press **INPUT** button. The **INPUT SOURCE** menu opens.
2. Press **▲** or **▼** to select **VGA**, then press **ENTER** to confirm.
(Or you may just press **VGA** button on the remote control to go to **VGA** mode directly.)
3. Turn on your computer, and adjust the display settings to maximum 1280 x 768, 60 Hz refresh rate.

Connections (Continued)

Connecting a VCR (for Recording)

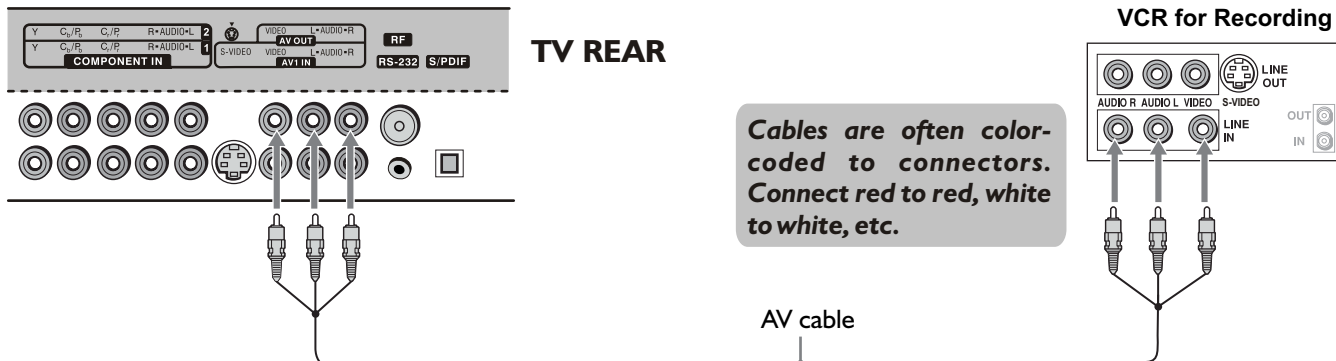

How to connect:

Connect the Audio/Video cables between the Audio (L/R)/Video jacks on the unit and VCR.

To record program

1. Turn on your TV, select a program you wish to record.
2. Turn on your VCR, insert a videotape for recording.
3. Press the Record button to begin recording.

Note

- Only analog TV programs, AVI, AV2, and S-VIDEO input sources can be output through the AV output jacks.

Connecting Digital Optical Audio

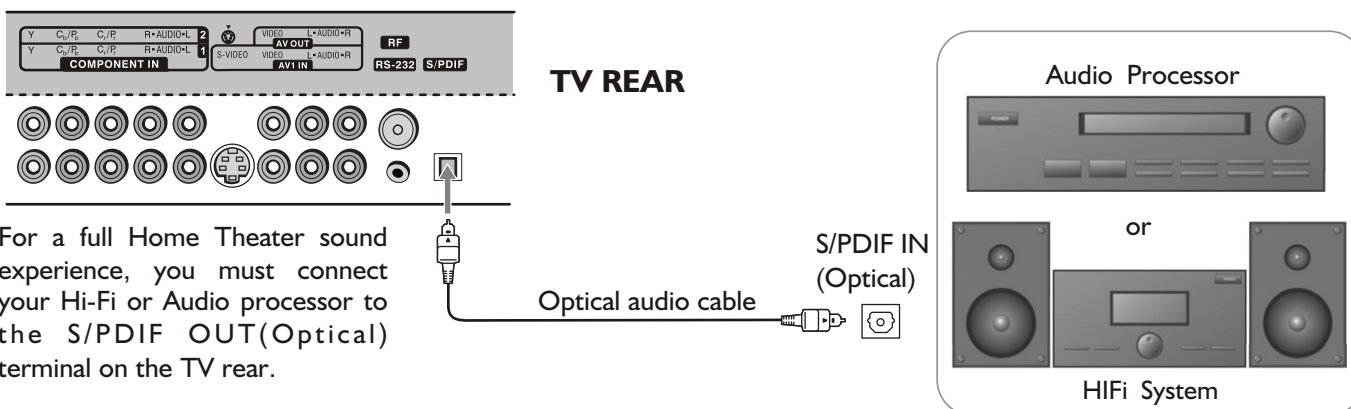

Note

The S/PDIF OUT jack is available only when a digital TV channel is received.

Connecting Headphones

Insert the plug of the headphone into the TV's Headphone jack.

When using headphones, adjust the headphone volume so as to avoid excessive levels, as hearing damage may result.

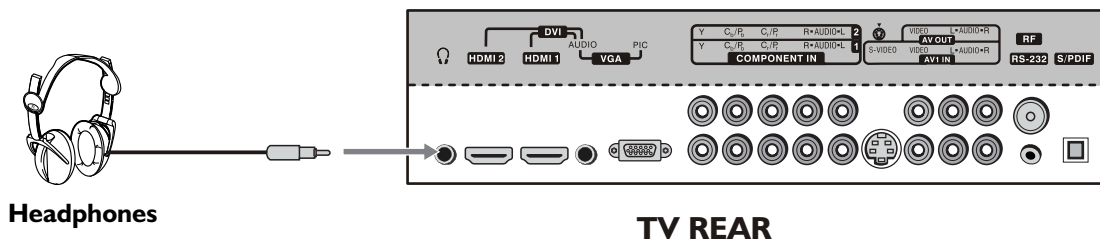

Basic Operations

Turning the Power On/Off

■ Turning On

Insert the power cord into the wall outlet.

Press the **Power** button on the unit or on the remote control, the unit will be turned on and you will be ready to use its features.

■ Turning Off

With the power on, press the **Power** button on the unit or on the remote control to turn off the unit, and put the unit in standby mode. To cut off the power completely, please disconnect the AC power cord.

Note • If there is no signal input for a certain time, the TV will automatically go to standby mode.

Selecting the Input Signal Source

- 1 Press **INPUT** button.
- 2 Press **▼** or **▲** to select the input source. Options include:
 - **TV** — Watch the TV signal.
 - **AV1** — Watch the signal from the AV1 input terminals.
 - **AV2** — Watch the signal from the AV2 input terminals.
 - **S-Video** — Watch the signal from the S-VIDEO input terminal.
 - **Component1** — Watch the signal from the COMPONENT 1 input terminals.
 - **Component2** — Watch the signal from the COMPONENT 2 input terminals.
 - **HDMI1** — Watch the signal from the HDMI 1 input jack.
 - **HDMI2** — Watch the signal from the HDMI 2 input jack.
 - **VGA** — Watch the signal from the VGA jack.
- 3 Press **ENTER** button to confirm the selection.

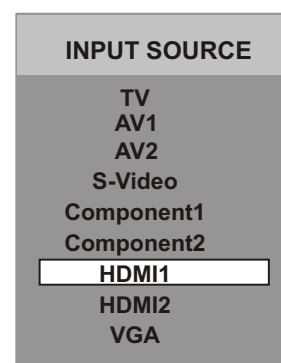

Note

1. **AV2 input is not available on the TV Model AVL472.**
2. On the remote control **four direct input source select buttons (COMP/HDMI/VIDEO/TV)** are provided.
 - **COMP** button: Press once to access Component 1 mode, press twice to access Component 2 mode.
 - **HDMI** button: Press once to access HDMI 1 mode, press twice to access HDMI 2 mode.
 - **VIDEO** button: Press once to access AV1 mode, press twice to access AV2 mode, press a third time to access S-Video mode.
 - **TV** button: Directly access TV mode.

On-Screen Menu Language Selection

- 1 Press **MENU**.
- 2 Press **◀** or **▶** to select **Setup** menu, press **▼** to access the menu.
- 3 Press **▲** or **▼** to select **Menu Language** item, press **◀** or **▶** to select your desired language.
- 4 Press **EXIT** to exit the menu screen.

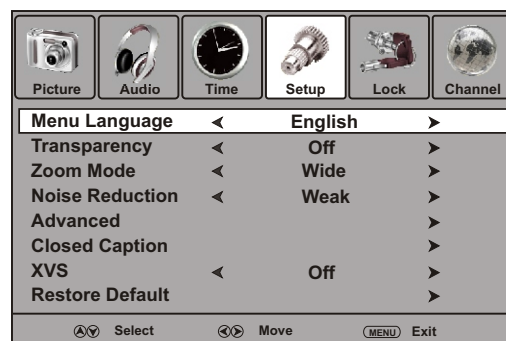

Displaying the Information Banner/Program guide

Press the **DISPLAY** button to display the information banner. The information banner displays status information such as channel number or signal source. If receiving a digital signal via antenna, more information, such as the channel number, channel name, and signal resolution, etc. can be displayed.

Also if receiving a digital signal via antenna, press **GUIDE** button to display the program guide information. You may be able to view program broadcasting time and program name from the guide.

Basic Operations (Continued)

Main Menu Overview (DTV mode, i.e. digital signal reception via antenna)

List of main menus to help you with operations

PICTURE menu

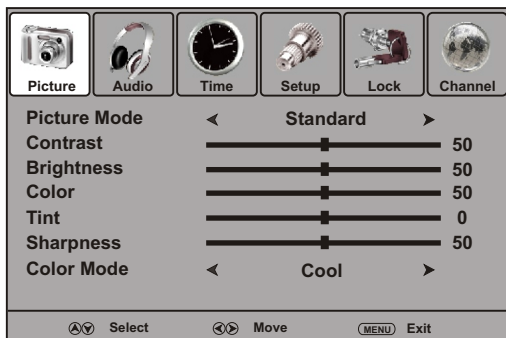

AUDIO menu

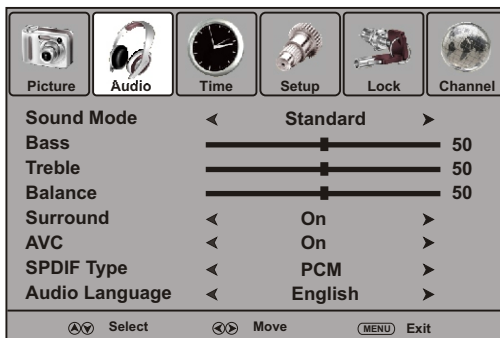

TIME menu

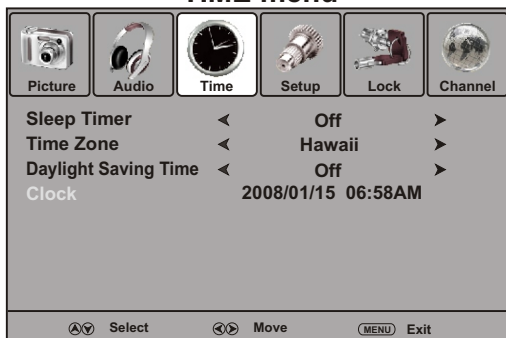

SETUP menu



LOCK menu



CHANNEL menu



Note

- Menu items that are not selectable are grayed out.
- To access the **Lock** menu, you should input the correct password firstly.
- The illustrations and on-screen displays in this manual are for explanation purposes (some are enlarged, others cropped) and may vary slightly from the actual ones.
- The above main menus are illustrated under DTV mode (i.e. digital signal reception via antenna). The menus and menu options may vary in different input modes.

To navigate through the main menu

- 1 With the power on, press **MENU** and the main menu screen will display.
- 2 Press the ◀ or ▶ to select menu. Press ▼ to access the menu.
- 3 Within the menu, press ▲, ▼, ◀, ▶ to navigate through the options or adjust an option. Press ▶ or **ENTER** button to enter a sub-menu.
- 4 Press **MENU** to return to the previous menu. To exit the menu system, press **EXIT** button directly. Or you may wait for some seconds and the on-screen menu will disappear from the screen automatically.

Note

- To clearly introduce the menu operations, this operation manual provides a description based on operation with the remote control.

Memorizing the Channels (if not connecting to a digital cable or satellite receiver)

When you turn on the TV for the first time, you should perform an auto channel search to set up stations on your TV if not intending to use a cable or satellite receiver.

Note: Be sure to select the **TV** input source before operation.

Setting the AIR/CABLE Option

Before your TV can memorize the available channels, you must specify the type of signal source that is connected to the unit. (i.e., an antenna or cable system)

- 1 Press **MENU** and the main menu screen displays.
- 2 Press **◀** or **▶** to select **Channel** menu, press **▼** to access.
- 3 Highlight **Air/Cable** item, and then press **◀** or **▶** to select **Air** or **Cable**.
Select **Cable** if using Cable TV, select **Air** if using VHF/UHF antenna.

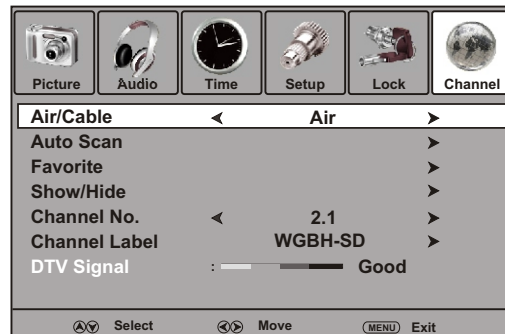

Auto Channel Search

You should perform an auto channel search to search for all channels available and stores them in memory.

If you set Antenna to Air, then do the following steps to search channels:

- 1 In **Channel** menu, press **▼** to select **Auto Scan** item, then press **▶** or **ENTER** to access.
- 2 Now **Start to Scan** item is highlighted, press **▶** or **ENTER** button to begin the auto channel search.
The TV begins memorizing all TV/DTV channels available in your area.

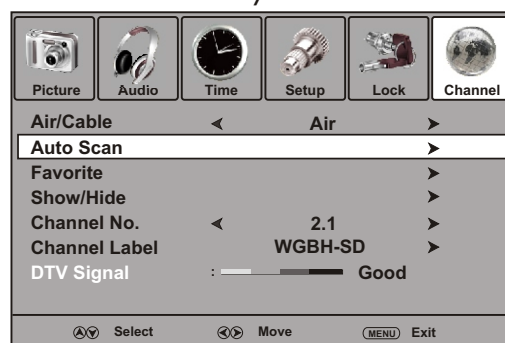

If you set Antenna to Cable, then do the following steps to search channels:

- 1 In **Channel** menu, press **▼** to select **Auto Scan** item, then press **▶** or **ENTER** to access.
- 2 Highlight **Cable System** item, press **◀** or **▶** button to select one of **STD**, **IRC** or **HRC** according to your local area's cable system. If unsure, then please select **AUTO** and the TV will auto detect the proper cable system.
- 3 Use **▼** or **▲** to highlight **Start to Scan** item, press **▶** or **ENTER** button to begin the auto channel search.
The TV begins memorizing all CATV/CADTV channels available in your area.

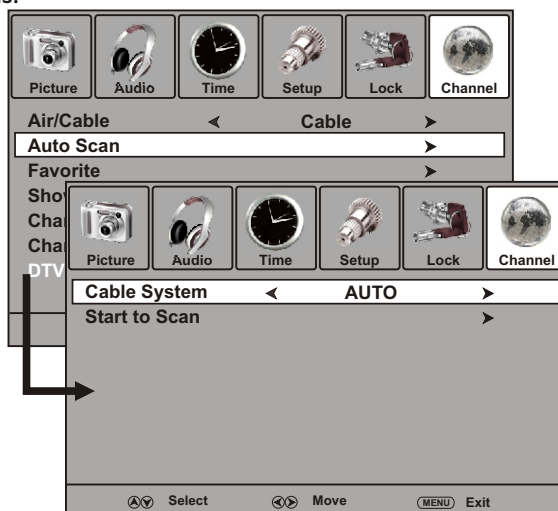

Note

- If you want to stop the auto scan, press **MENU** button.

Monitoring DTV Signal Strength

You can make use of DTV signal strength bar to check how strong your DTV signal is and whether you need to adjust your antenna or digital cable input. The higher the signal strength, the less likely you are to experience picture degradation.

Navigate to the **Channel** menu, at the bottom of the menu screen the **DTV Signal** bar is displayed indicating the level and quality of signal that is received by the unit for the current DTV channel.



Memorizing the Channels

To Skip Unwanted Channels

After memorizing the channels, you can skip unwanted channels so that only the channels you want to watch are selected with Channel up/down buttons.

- 1 Navigate to the **Channel** menu, press \blacktriangledown or \blacktriangle to select **Show/Hide** item, press \blacktriangleright or **ENTER** button to open the program list.
- 2 Use \blacktriangledown or \blacktriangle to select program, use **ENTER** button to set **Show** (a tick symbol will appear) or **Hide** (the tick symbol will disappear) to the selected program. If the program list has more than one page, you can press \blacktriangleleft or \blacktriangleright to scroll the page.
- 3 To exit, press **EXIT** button.
After exiting the menu, the hidden channels will then be skipped when you select programs with the Channel up/down buttons.

Note

You can select the hidden channels by pressing the direct channel select buttons.

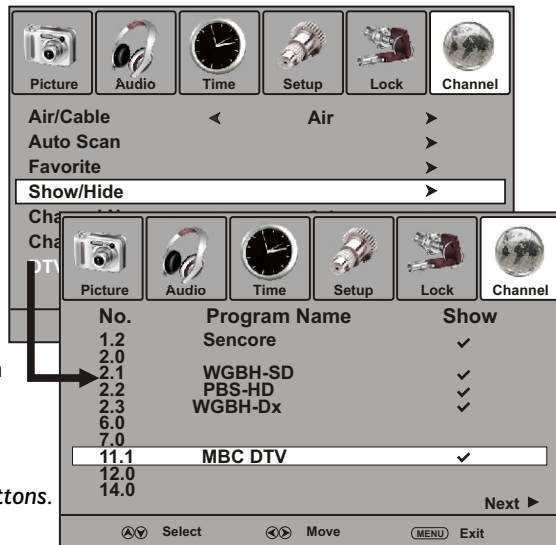

Setting Favorite Channels

You can set up favorite channels list so that you can quickly browse through your favorite channels by using Favorite button.

- 1 Navigate to the **Channel** menu, press \blacktriangledown or \blacktriangle to select **Favorite** item, press \blacktriangleright or **ENTER** button to open the program list.
- 2 Use \blacktriangledown or \blacktriangle to select your favorite program, use **ENTER** button to mark the selected program as favorite (a tick symbol appears). To cancel the favorite mark, just press **ENTER** again and the tick symbol disappears. If the program list has more than one page, you can press \blacktriangleleft or \blacktriangleright to scroll the page.
Repeat the above steps to set more favorite programs.
- 3 To exit, press **EXIT** button.
Now you can press **FAVORITE** button to open the favorite program list, press \blacktriangledown or \blacktriangle to browse through the favorite programs and press **ENTER** to access the channel.

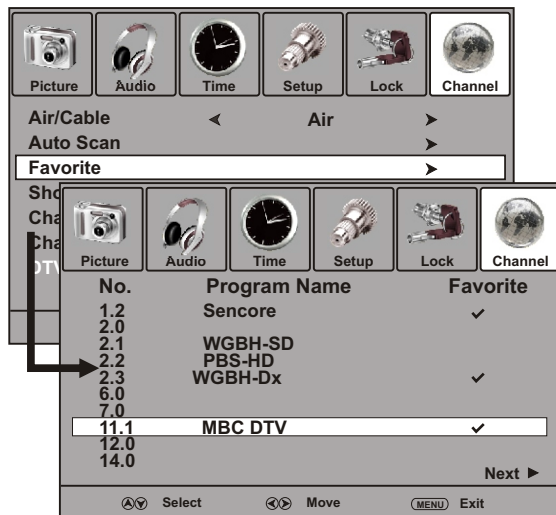

Channel Label Setup

If required, you can give a name to the programs.

- 1 Use channel buttons to select a channel you want to give a name.
- 2 Navigate to the **Channel** menu, press \blacktriangledown or \blacktriangle to select **Channel Label** item, press \blacktriangleright or **ENTER** button to open the channel label editing screen.
- 3 Use \blacktriangledown or \blacktriangle to select character, use \blacktriangleleft or \blacktriangleright button to move the cursor.
- 4 Press **ENTER** button to confirm or press **MENU** button to return to the **Channel** menu and this channel has been assigned with this name.

Repeat the above steps to set up more channel labels.

Note

- If a channel label is provided on the signal from the broadcasting station, the TV displays a short name for a DTV channel - even if you didn't setup a label for the channel.

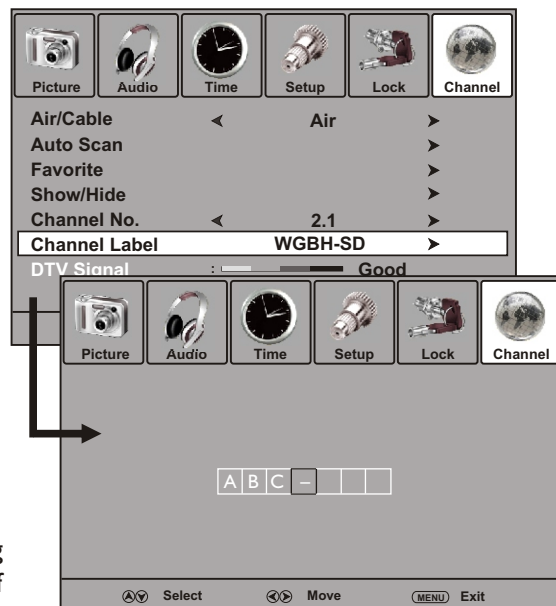

Channel selection

Information about USA and Canadian channel numbering

- ATSC PSIP channel has two part channel number:

- Major channel number
- Minor channel number

For example:

Channel: 5.1

Major channel number

Minor channel number

- In most situations the major channel number is same for both analog and digital channels (It is equal to the NTSC channel number for existing broadcasters.)
- Usually a minor channel number of zero is used for a broadcaster's analog channel.

Channel Numbering Example

- Original NTSC Channels for Des Moines:
 - 5, 8, 11, 13, 17
- Possible NTSC + ATSC Channels for Des Moines:
 - 5-0, 8-0, 11-0, 13-0, 17-0 (channel numbers for existing analog channels)
 - 5-1, 5-2, 8-1, 8-2, 8-3, 8-4, 13-1 (channel numbers for digital channels)

Channel Selection

You can select your desired TV program by one of the following methods.

■ Method 1 — Using the Channel up/down buttons (CH+ or CH-)

Press the **CH+** or **CH-** to cycle among available channels found (while the hidden channels can not be selected).

■ Method 2 — Using the direct select buttons (0-9 and Dot buttons)

Press the **number buttons (0-9)** and the **Dot (.)** button, then wait for the television to change channels or press **ENTER** to go immediately to that channel.

For example, if you want to select channel 8.3, just key in '8', '.', '3' on the remote control. (Be sure the period of two-press should be within 3 seconds)

Note

- When you use the number buttons, you can directly select any channel within the channel range.
- In some situations virtual channel numbers have no correspondence to physical frequencies.
- To select an analog channel, you may directly input its major channel number. It is unnecessary to input the minor channel number of zero.

■ Method 3 — Using the RECALL button

Press this button to switch between the current channel and the last viewed channel.

■ Method 4 — Using the Channel List or Favorite List

After auto-search, a default channel list has been created. You may press **CH.LIST** button to call up the channel list, then make use of **▼** or **▲** to select the channel, then wait for some seconds or press **ENTER** to go directly to that program. If the channel list has more than one page, you can press **◀** or **▶** to scroll the page.

If you have created your favorite program list, you may press **FAVORITE** button to call up the favorite list, then make use of **▼** or **▲** to select the channel, then wait for some seconds or press **ENTER** to go directly to that program. If the program list has more than one page, you can press **◀** or **▶** to scroll the page.

NO.	NAME
1.2	Sencore
2.0	
2.1	WGBH-SD
2.2	PBS-HD
2.3	WGBH-Dx
6.0	
7.0	
11.1	MBC DTV
12.0	
14.0	
Next ▶	

(The above OSD is only for illustration purpose. The actual screen may vary.)

Picture Adjustment

Adjusting the Picture

- 1 Press **MENU** and the main menu screen displays.
- 2 Press ◀ or ▶ to select **Picture** menu, press ▼ to access the menu.
- 3 Within the menu, press ▲, ▼, ◀, ▶ to navigate through the options or adjust an option.
- 4 Press **MENU** to return to previous menu. Press **EXIT** to exit the menu screen directly.

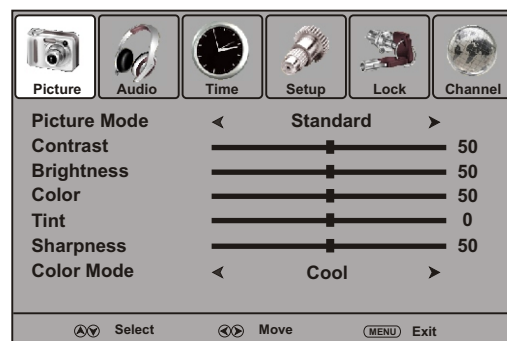

Option	Description
Picture Mode	Selects a desired picture mode. You can select from Standard, Dynamic, Soft and Personal . Standard: Select for a standard picture. Dynamic: Select for a bright and vivid picture. Soft: Select for a finely detailed picture. Personal: The picture quality you set.
<i>Note: To quickly change the picture mode, press the PICTURE button on the remote control repeatedly.</i>	
Contrast	Adjusts image contrast.
Brightness	Adjusts screen brightness for easier viewing of dark picture such as night scenes and black hair.
Color	Adjusts color saturation.
Tint	Adjusts tint for image.
Sharpness	Adjusts image sharpness.
Color Mode (color Temperature)	Selects one of three automatic color adjustments. Sets to Warm to enhance hotter colors such as red, or set to Cool to see less intense colors with more blue. You can select from Warm, Cool and Normal .

Sound Adjustment

Adjusting the Volume

■ Using the volume buttons (VOL+ and VOL –)

Press the **VOL +** or **VOL-** to increase or decrease the volume.

■ Using the Mute

Press the **MUTE** button to temporarily turn off all sound. To restore the sound, press the **MUTE** button again.

Adjusting the Sound

- 1 Press **MENU** and the main menu screen displays.
- 2 Press **◀** or **▶** to select **Audio** menu, press **▼** to access the menu.
- 3 Within the menu, press **▲** or **▼** to navigate through the options, press **◀** or **▶** to adjust an option.
- 4 Press **MENU** to return to previous menu. Press **EXIT** to exit the menu screen directly.

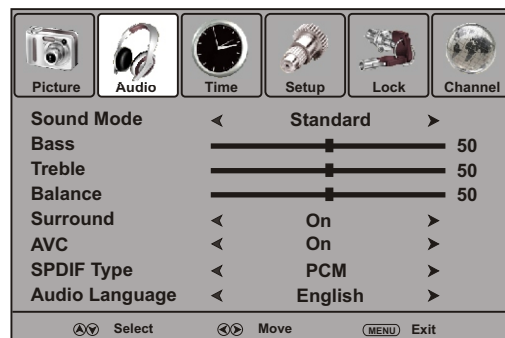

Option	Description
Sound Mode	Selects a desired sound mode. You can select from Standard, Music, Movie and Personal . Standard: Select for normal programs. Music: Select for a music program. Movie: Select for a movie program. Personal: The sound quality you set.
Note: To quickly change the sound mode, press the AUDIO button repeatedly.	
Bass	Adjusts Bass (low sounds) to personal taste. We recommend 2/3 to right for a fuller sound.
Treble	Adjusts Treble (high sounds) to personal taste. We recommend 2/3 to right for a fuller sound.
Balance	Adjusts volume balance (left and right volumes).
Surround	Select On to turn on the surround sound effect. Select for personal taste. Select Off to turn off surround sound.
AVC (auto volume control)	Select On to equalize overall volume levels across all channels. Select Off to turn off the auto volume control.
SPDIF Type (Only for digital programs)	Use this item to select audio output mode from SPDIF. Select RAW to output audio signal as its original format. Select PCM to output audio signal by PCM form (if available).
Audio Language (Only for digital programs)	Selects an alternate language if the program has more than one language.

Stereo/SAP Broadcasts Setup (Only for analog reception)

- This TV can receive MTS stereo programs and any SAP (Secondary Audio Program) that accompanies the stereo program; if the station transmits an additional sound signal as well as the original one.
- Stereo or SAP can be selected only when the TV station transmits these signals.
- Mono sound is automatically received if the broadcast is only in Mono.
- Select Mono if you are having difficulty receiving a stereo signal.

Press **MTS/SAP** button to select a stereo mode. You can select from **[MONO]**, **[STEREO]** and **[SAP]**.

MONO: Select for mono reception. Use to reduce noise during weak stereo broadcasts.

STEREO: Select for stereo reception when viewing a program broadcast in stereo.

SAP: Select to automatically switch the TV to second audio programs when this signal is received.

Note

- In DTV mode, you can press **MTS/SAP** button to select audio track (if available).

System Setup

System Setup

You may change system settings such as OSD language, menu transparency, picture aspect ratio, etc. by making use of Setup menu.

- 1 Press **MENU** and the main menu screen displays.
- 2 Press **◀** or **▶** to select **Setup** menu, press **▼** to access the menu.
- 3 Within the menu, press **▲**, **▼**, **◀**, **▶** to navigate through the options or adjust an option. Press **▶** or **ENTER** button to access a sub-menu.
- 4 Press **MENU** to return to previous menu. Press **EXIT** to exit the menu screen directly.

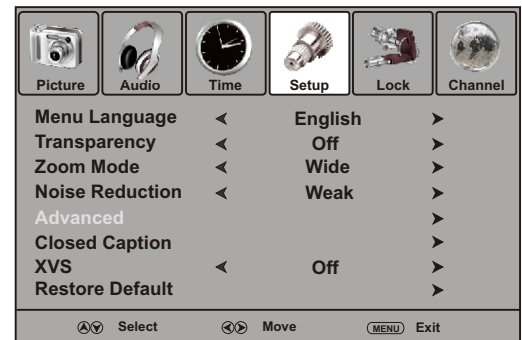

Option	Description
Menu Language	Selects on-screen menus language.
Transparency	Turns on/off on-screen menu's background transparency.
Zoom Mode	You can select the picture aspect ratio (display proportions) according to your video signal type or personal preference. You can select from Normal , Wide , Zoom and Cinema . Normal: Selects the correct aspect ratio to match the source's image.(4:3 to 4:3, 16:9 to 16:9) Wide: Displays a full-screen picture to fill in the 4:3 "black bars". Stretches all of the content equally. Cinema: Stretches the picture at the edges while maintaining a good aspect ratio at the center of the screen. Zoom: Enlarges the picture without stretching. The top and bottom portion of the picture may be cropped.
Noise Reduction	Select from Weak/Middle/Strong to reduce noise in the picture, commonly called snow. Select Off to turn off this function.
Closed Caption	You can make use of Closed Caption sub-menu to turn on/off Closed Caption, to set Closed Caption type, etc. See < Setting up Closed Captioning > section on the following page for more instructions.
XVS	Select On to optimize the picture display. Picture will become more vivid. Select Off to turn off the feature.
Restore Default	Running this function to reset all settings to its original factory condition by following the on-screen instructions. Please note: Running the [Restore Default] function will clear all of your customized settings including the programs you have setup. After a reset, an auto channel search will need to be completed to view TV channels. So make sure you do want to reset all settings to its original factory condition before you perform this operation.

Note: You can press the **ZOOM** button repeatedly to select a desired aspect ratio. If using an HD cable or satellite receiver, make sure the **ZOOM** settings on the TV and receiver remote controls do not conflict with each other.

Setting up Closed Captioning

You can make use of Closed Caption sub-menu to turn on/off Closed Caption, to set Closed Caption type, to customize digital closed captions, etc.

Note

- The caption feature does not work with Component, VGA, or HDMI. For DVD, use DVD player remote control.
- Not all the TV programs and videos will offer closed captioning.

Closed Captioning Setup

- 1 Navigate to **Setup** menu, highlight **Closed Caption** item, press **▶** or **ENTER** button to enter its sub-menu.
- 2 Within the menu, press **▲**, **▼**, **◀**, **▶** to navigate through the options or adjust an option. Press **▶** or **ENTER** button to enter next level sub-menu.
- 3 Press **MENU** to return to previous menu. Press **EXIT** to exit the menu screen directly.

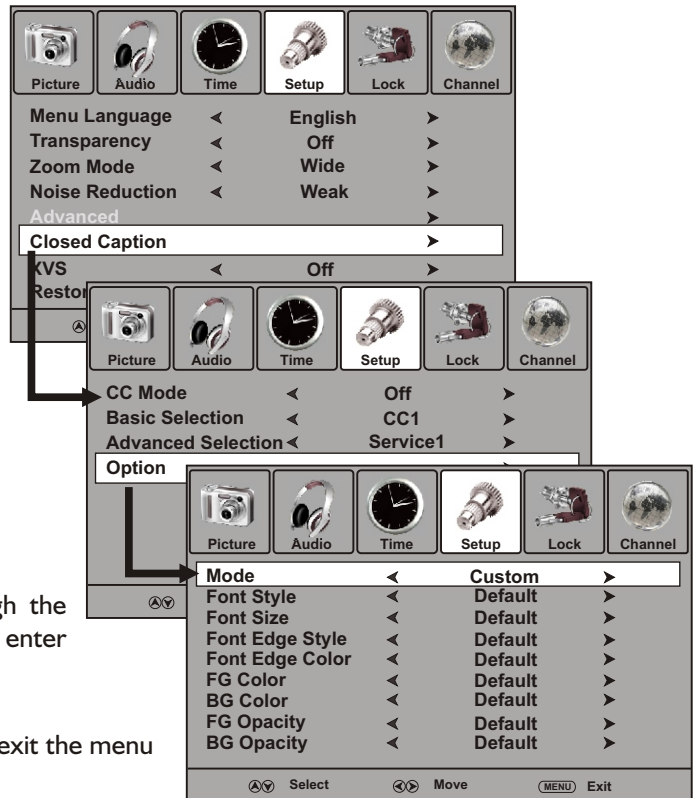

Option

Description

CC Mode

Allows you to select **CAPTION On**, **CC on Mute** or **Off**.

On: Turns on the Closed Captions.

CC on Mute: Turns on the Closed Captions when the TV is muted.

Off: Turns off the Closed Captions.

Note: You can press the **CCD** button to quickly turn on or turn off the Closed Captions.

Basic Selection

Allows you to select closed caption options.

CC1, CC2, CC3, CC4 Displays a printed version of the dialog or sound effects of a program. (Should be set to CC1 for most programs.)

Text1/Text2 /Text3/Text4 Displays network/station information presented using either half or the whole screen (if available).

Advanced Selection

Allows you to select advanced digital closed caption options.

(Only for digital programs) Select from the available options.

Option

(Only for digital programs)

You can customize the digital closed captions that appear on your screen by doing the following steps: Highlight **Option** item, use **ENTER** button to access its sub-menu. Set **Mode** to **Custom** and now you can customize the Size, Style, etc. to your preference.

To restore to default settings, just set **Mode** to **Default**.

Font Style: Select a style for the words.

Font Size: Set the size the words will appear in.

Font Edge Style: Select an edge style.

Font Edge Color: Select a color for the edges.

FG Color: Select a color for the text.

BG Color: Select a background color.

FG Opacity: Select the opacity for the text.

BG Opacity: Select the opacity for the background color.

Clock and Timer Setup

Auto Clock Setup

- The time is set automatically from a digital channel signal.
- The digital channel signal includes information for the current time provided by the broadcasting station. It may not be receivable via component, HDMI, S-VIDEO or AV input.

- 1 Press **MENU** and the main menu screen displays.
- 2 Press ◀ or ▶ to select **Time** menu, press ▼ to access the menu.
- 3 Highlight **Time Zone** and then use ◀ or ▶ to select your viewing area time zone: **Pacific, Alaska, Hawaii, Eastern, Central, Mountain**.
- 4 If your viewing area observes Daylight Saving Time, set **Daylight Saving Time** to **On** in the menu, otherwise set it to **Off**.

At the last line of the menu screen the clock value is displayed indicating the current time.



Sleep Timer

Sleep timer lets you select the amount of time before your TV turns itself off automatically. This setting is cleared when the TV is turned off.

- 1 Press **MENU** and the main menu screen displays.
- 2 Press ◀ or ▶ to select **Time** menu, press ▼ to access the menu.
- 3 Highlight **Sleep Timer** and then use ◀ or ▶ to select the amount of time. To turn off sleep timer, select **Off**.

Note

- You may directly press **SLEEP** button on the remote control to set sleep timer.

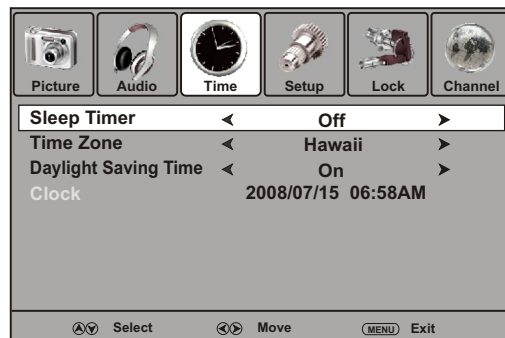

Setting Parental Lock

Parental Lock enables parents to prevent their children from watching inappropriate material on TV. Parental Lock reads the ratings for programming (except for news, sports, unedited movies on premium cable and Emergency System signals), then denies access to programming if the program's rating meets the limitations you select. In this case, the program will be blocked.

To use the Parental Lock function, you first need to set your password.

To set a password

- 1 Press **MENU** and the main menu screen displays.
- 2 Press **◀** or **▶** to select **Lock** menu, press **▼** to access the menu.
- 3 Now a password is required to input.
Press **0–9 number** buttons to input the password (4-digit, the default password is 0000 and you should change it). Now **Lock** menu opens.
- 4 Select **Change Password** item, press **▶** or **ENTER** to access.
- 5 Enter the new password using 0–9 buttons.
- 6 Enter the same password again to confirm.
Now the screen will go back to **Lock** menu, the new password has been created successfully.

Note

- To avoid forgetting the password, write it down and keep it in the safe place.
- If you do forget the password, you may use master password (1397) to access the **Lock** menu and set a new password. Do not let children know it.

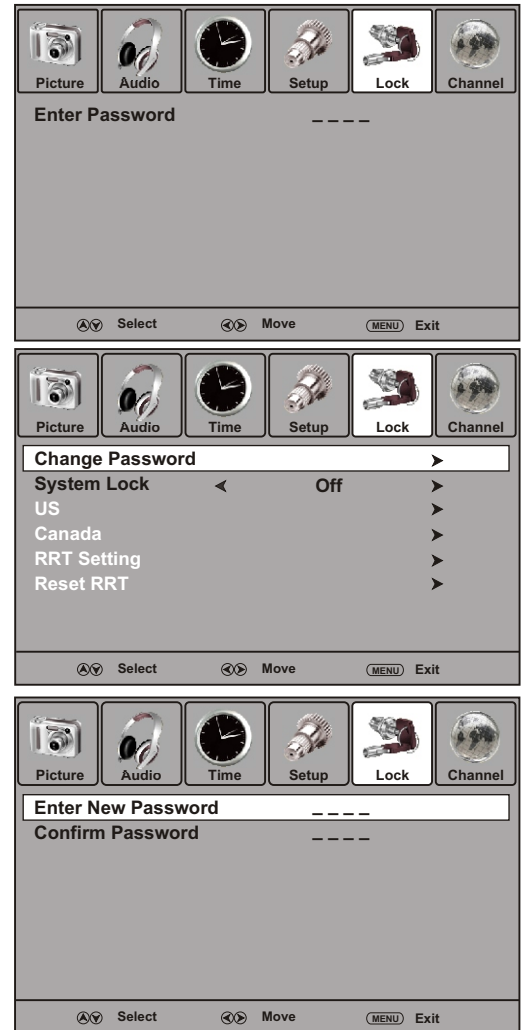

To Enable Parental Lock

- 1 Use password to access **Lock** menu.
- 2 Press **▲** or **▼** to select **System Lock** item, then press **◀** or **▶** to turn the **System Lock ON** or **OFF**.
To set up blocking scheme and to enable the blocking scheme you set up, you should set to ON.
To disable the blocking scheme you set up, please set it to OFF.
- 3 Press **MENU** to return to previous menu. Press **EXIT** to exit the menu screen.

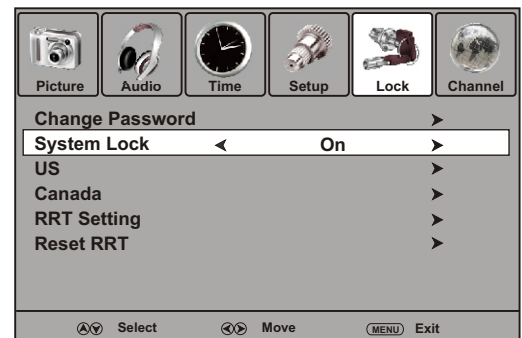

Setting Parental Lock (Continued)

You can make use of Lock menu to setup ratings including TV rating, Movie rating, English rating and French rating, etc..

Rating Setup

- Use password to access **Lock** menu and set **System Lock** to **On**. Now the rating options can be setup.
- Press **▲** or **▼** to select your desired rating category (US, Canada, or RRT Setting), then press **▶** or **ENTER** to access.
- Press **▲** or **▼** to select, then press **◀** or **▶** to adjust.
To set up TV RATING, select **US** in the **Lock** menu and access by pressing **ENTER** button, highlight **TV** item and then press **▶** or **ENTER** to access the sub-menu.

In the TV RATING sub-menu, use **▲**, **▼**, **◀**, **▶** to navigate and select, use **ENTER** button to either block the rating (a lock symbol will appear) or unblock (the lock symbol will disappear).

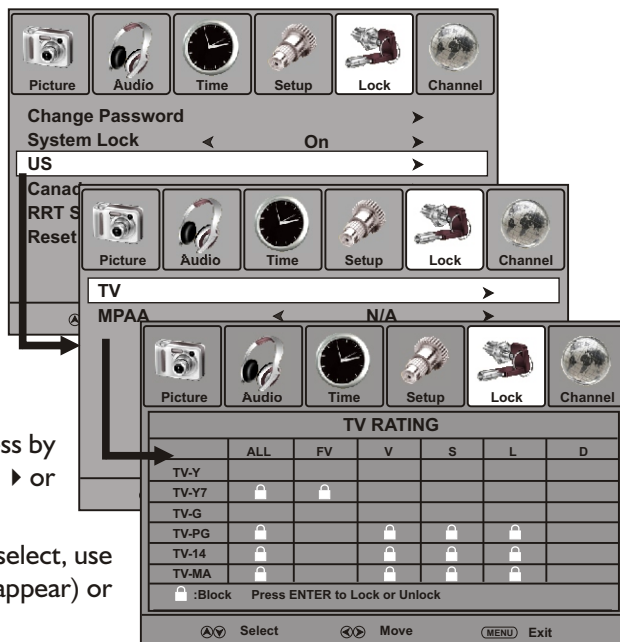

Rating

Rating Option Descriptions

TV rating:

Prevents children from watching certain TV programs, according to the ratings limit set. TV Parental Guidelines may have one or more letters added to the basic rating to let parents know when a show contains higher levels of violence, sex, adult language or suggestive dialogue.

Movie rating:

Blocks movies according to the movie ratings limits specified, so children can not view certain movies. You can set the ratings limit by blocking out all the movies with the ratings above a specified level. Keep in mind that the movie ratings limit only applies to movies shown on TV, not TV programs, such as soap operas.

Canadian English rating

This rating allows you to block various types of movies and television programs based on the rating systems used in Canada.

Canadian French rating

Lets you block or unblock Canadian French programs according to various ratings categories.

RRT Setting

If the broadcasting program uses RRT5 (Rating Region Table – Region 5) criteria rating in accordance with the FCC rules, its rating can be downloaded to this TV and can be used for parental locks.

Reset RRT

Running [Reset RRT] to clear the downloaded RRT rating. (If this rating is still broadcast by TV station, the TV will download it again.)

Age-Based Options

Y	All children.
Y7	Directed to children age 7 and older.
G	General audience.
PG	Parental guidance suggested.
14	Parents strongly cautioned.
MA	Mature audience only.

Content-Based Options

FV	Fantasy violence.
V	Violence.
S	Sexual situations.
L	Strong language.
D	Suggestive dialog.

G	All children and general audiences.
PG	Parental guidance suggested.
PG-13	Parental guidance for children under 13.
R	Restricted viewing, parental guidance is suggested for children under 17.
NC-17	No one 17 and under admitted.
X	Adult only.
N/A	Not rated.

E	Exempt – Exempt programming.
C	All children.
C8+	Children 8 years and older.
G	General programming.
PG	Parental guidance.
14+	Viewers 14 and older.
18+	Adult programming.

E	Exempt – Exempt programming.
G	General programming.
8ans+	Not recommended for ages under 8.
13ans+	Not recommended for ages under 13.
16ans+	Not recommended for ages under 16.
18ans+	Adult programming.

The actual menu options of this rating vary, depending on the broadcaster.

Image Adjustments for VGA(PC) Mode

Before adjusting the image, make sure that you select the correct source (VGA).

To Adjust the PC Image

- 1 In VGA mode, press **MENU** and the main menu screen displays.
- 2 Press **◀** or **▶** to select **Picture** menu, press **▼** to access the menu.
- 3 Press **▲**, **▼**, **◀**, **▶** to navigate through the options or adjust an option.
- 4 Press **MENU** to return to previous menu. Press **EXIT** to exit the menu screen directly.

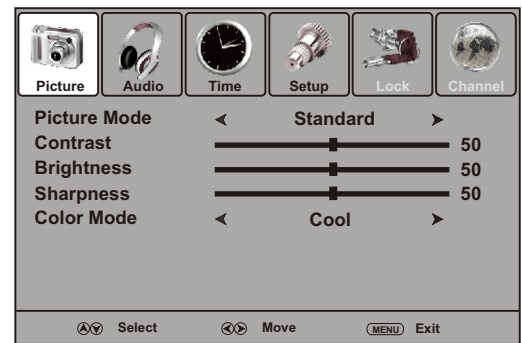

Option	Description
Picture Mode	Selects a desired picture mode. You can select from Standard, Dynamic, Soft and Personal . Standard: Select for a standard picture. Dynamic: Select for a bright and vivid picture. Soft: Select for a finely detailed picture. Personal: The picture quality you set.
Contrast	Adjusts image contrast.
Brightness	Adjusts screen brightness for easier viewing of dark picture such as night scenes and black hair.
Sharpness	Adjusts image sharpness.
Color Mode (color Temperature)	Selects one of three automatic color adjustments. Sets to Warm to enhance hotter colors such as red, or set to Cool to see less intense colors with more blue. You can select from Warm, Cool and Normal .

Note: To quickly change the picture mode, press the **PICTURE** button on the remote control repeatedly.

To Setup PC Advanced Setting

- 1 In VGA mode, press **MENU** and the main menu screen displays.
- 2 Press **◀** or **▶** to select **Setup** menu, press **▼** to access the menu.
- 3 Press **▲** or **▼** to select **Advanced** item, then press **▶** or **ENTER** to access.
- 4 Press **▲**, **▼**, **◀**, **▶** to navigate through the options or adjust an option. To confirm, press **ENTER**.
- 5 Press **MENU** to return to previous menu. Press **EXIT** to exit the menu screen directly.

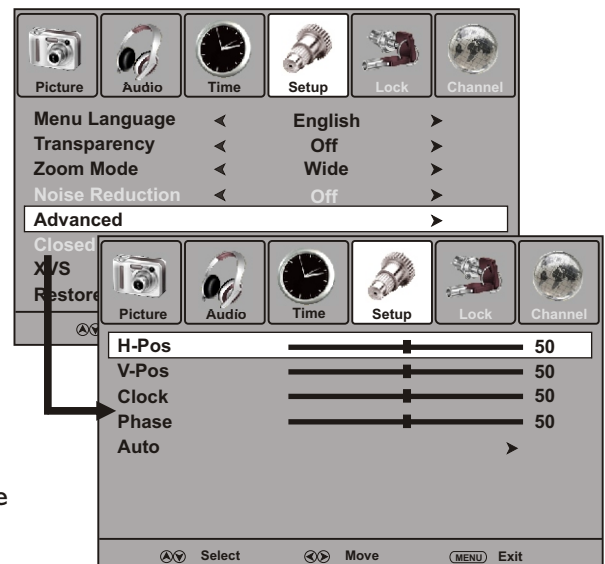

Note: Set the computer's refresh rate to maximum 75Hz.

Option	Description
H-Position (H-Pos)	Moves the image on the screen left or right.
V-Position (V-Pos)	Moves the image on the screen up or down.
Clock	Adjusts the sample frequency.
Phase	Improves the focusing/sharpness of a stable image.
Auto adjust (Auto)	Selects and activates to start auto adjustment. The set automatically adjusts the image settings, such as position and phase.

Troubleshooting

If, after reading these operating instructions, you have additional questions related to the use of your television, please call our toll-free help line at 1-800-263-2244.

Before calling service, please check the symptoms and follow suggested solutions.

Remote Control

<i>Problem</i>	<i>Possible Solutions</i>
Remote control does not operate	<ul style="list-style-type: none">● The batteries could be weak. Replace the batteries.● Check the orientation of the batteries.● Make sure the power cord is plugged in.

Video and Audio

<i>Problem</i>	<i>Possible Solutions</i>
No picture (screen not lit), No sound	<ul style="list-style-type: none">● Make sure the power cord is plugged in.● Press POWER on the TV or on the remote control.● Try another channel; it could be station trouble.
Dark, poor or no picture (Screen lit), good sound	<ul style="list-style-type: none">● Adjust the brightness in the video setting.● Check the antenna/cable connections.● If on computer (VGA) mode, check that the computer's refresh rate on its display or monitor menu is maximum 60Hz and 1280 x 768 resolution.
No color/dark picture/color is not correct	<ul style="list-style-type: none">● Adjust the color saturation in the video setting.
Only snow and noise appear on the screen	<ul style="list-style-type: none">● Check the antenna/cable connections.● Try another channel; it could be station trouble.
Dotted lines or stripes	<ul style="list-style-type: none">● Adjust the antenna.● Move the TV away from noise sources such as cars, neon signs, or hair dryers.
Double images	<ul style="list-style-type: none">● Using a highly directional outdoor antenna or a cable may solve the problem.
Good picture, no sound	<ul style="list-style-type: none">● The sound may be muted. Press MUTE again to cancel.● Make sure the stereo mode is set to stereo or mono.
Audio noise	<ul style="list-style-type: none">● Communication problems may occur if infrared communication equipment (e.g., infrared cordless headphones) is used near the TV. Move the infrared communication equipment away from the TV until the noise is eliminated.

Troubleshooting (Continued)

General

Problem	Possible Solutions
One or some channels can't be displayed	<ul style="list-style-type: none">• These channels may be blocked. Please unblock them (see <Setting Parental Control> section).• These channels may have been set to Skip, see top of page 20 or select them with 0-9 number buttons.
Lost password	<ul style="list-style-type: none">• You may use the super password (1397) to access the Lock menu and set a new password. Please remember your new password and keep it carefully.
Some items can't be accessed	<ul style="list-style-type: none">• If a setting option appears in gray, this indicates that the settings option is unavailable in current input mode.
TV cabinet creaks	<ul style="list-style-type: none">• When the TV is in use, there is a natural rise in temperature, causing the cabinet to expand or contract and may be accompanied by a slight creaking noise. This is not a malfunction.
Control buttons do not operate	<ul style="list-style-type: none">• Disconnect the power cord and wait for a few seconds. Then re-plug the power cord and turn on the unit again.

Display panel

Problem	Possible Solutions
A pixel of the screen does not light up.	The display panel is manufactured using an extremely high level of precision technology, however, sometimes 1 or 2 pixels of the screen may be missing picture elements or have luminous spots. This is not a malfunction.
After-images appear	Do not allow a still picture to be displayed for an extended period, as this can cause a permanent after-image to remain more so on a Display Panel. Examples of still pictures include logos, video games, computer images, teletext and images displayed in 4:3 mode. Note: The permanent after-image on the Display resulting from fixed image use is not an operating defect. This product is not designed to display fixed images for extended periods of time.
Snapping sounds may be heard from the display unit.	This sound is produced when the cabinet expands or contracts due to variations in temperature and is not a malfunction.

Note

Some occasional operating "glitches" can be solved by unplugging and replugging the AC power cord.

Cautions:

Never attempt to repair a defective TV yourself.

Specifications

Panel Type:		Plasma 42" (AVP4232), Plasma 50" (AVP504), LCD 47"(AVL472)
Maximum resolution:		1024 x 768 (42"), 1920 x 1080 (47"/50")
TV system:		NTSC-M, ATSC
Receiving Channel:		VHF 2-13, UHF 14-69, CATV I-125, CADTV I-135, DTV 2-69
Audio multiplex:		BTSC System
Audio output:		10W x 2
Power Requirement:		AC 120 V, 60 Hz
Power Consumption:		390 W(42"), 300 W(47"), 550W(50")
Dimensions (W x H x D):		1050 x 809 x 320 mm(41.3 x 31.9 x 12.6 in inches)(42") 1184 x 864 x 350 mm(46.6 x 34 x 13.8 in inches)(47") 1224 x 922 x 320 mm(48.2 x 36.3 x 12.6 in inches)(50")
Weight:		36 kg/79 lb(42"), 39 kg/86 lb (47"), 54 kg/119 lb(50")
Terminals:		
IN	Composite Video/Audio(L/R):	2 (42"/50"), 1 (47")
	S-Video:	1
	Component Video/Audio(L/R):	2
	HDMI interface:	2
	VGA/Audio:	1
	Antenna:	1
OUT	Composite Video/Audio(L/R):	1
	Headphone jack:	1
	S/PDIF (optical):	1
CONTROL	RS-232:	1

Note

1. Design and specifications are subject to change without notice.
2. Weight and dimensions shown are approximate.
3. Specifications and external appearance may be changed for the sake of improvement.

SANYO COMFORT WARRANTY

WARRANTY APPLICATION

New, unused Sanyo Color Television products purchased in Canada through a Sanyo authorized dealer are warranted against manufacturing defects in materials and workmanship for ONE YEAR for parts and labor, from the date of purchase by the original retail purchaser for non-commercial use. This warranty only applies in favor of the original retail purchaser of the warranted product.

SANYO CANADA INC.'S RESPONSIBILITY

During the warranty period, SANYO Canada Inc. will repair, or at our option, replace a Color Television product which shows evidence of a manufacturing defect in materials or workmanship.

Replacement PARTS are warranted for the remaining portion of the warranty period.

WHAT IS NOT COVERED

- (a) Color Television products purchased outside Canada.
- (b) Color Television products purchased in a used condition.
- (c) Problems due to product set-up and installation.
- (d) Adjustments that are outlined in the Operating Manual.
- (e) Accessory items including antenna, batteries and connecting cables.
- (f) Damage in or due to transportation.
- (g) Damage due to improper maintenance, accident, abuse, misuse or negligence.
- (h) Damage caused by lightning and power surges.

ORIGINAL RETAIL PURCHASER'S RESPONSIBILITY

You, the original retail purchaser, must present your original, dated bill-of-sale together with this warranty to SANYO Canada Inc. or to an authorized Sanyo Service Depot* when you make a claim under this warranty.

You, the original retail purchaser, are responsible for any costs of TRANSPORTING the product to and from SANYO Canada Inc. or an authorized Sanyo Service Depot. You also are responsible for the cost of any MAINTENANCE necessary in respect of the product.

*In-home service is only available to the units whose screen size is 40 inches or over, and limited to the locations within a 30-km radius of any authorized Sanyo Service Depot, throughout Canada.

WARRANTY BECOMES VOID This warranty becomes void if the product's serial numbers are altered or removed or if any repair to the product is made other than by SANYO Canada Inc. or by an authorized Sanyo Service Depot.

LIMITATIONS

- (a) SANYO Canada Inc. reserves the right to change or improve the design of the model of the product warranted hereunder without incurring any obligation to make any modifications to or to install any improvement in or on the product.
- (b) In no event shall SANYO Canada Inc. or any of its Authorized Dealers be liable for special or consequential damage arising from the use of this product.

STATUTORY WARRANTIES

The above provisions do not preclude the operation of any applicable provincial statute which in certain circumstances may not allow some of the limitations and exclusions described in this Warranty. Where any terms of this Warranty are prohibited by such a statute, they shall be deemed null and void but the remainder of this warranty shall remain in effect.

HOW TO OBTAIN WARRANTY SERVICE

Please contact the Sanyo Authorized Dealer from whom the product was purchased or contact us directly at:

SANYO Canada Inc.
300 Applewood Cres.
Concord Ont. L4K 5C7
(905) 760-9944
1-800-263-2244

Free Manuals Download Website

<http://myh66.com>

<http://usermanuals.us>

<http://www.somanuals.com>

<http://www.4manuals.cc>

<http://www.manual-lib.com>

<http://www.404manual.com>

<http://www.luxmanual.com>

<http://aubethermostatmanual.com>

Golf course search by state

<http://golfingnear.com>

Email search by domain

<http://emailbydomain.com>

Auto manuals search

<http://auto.somanuals.com>

TV manuals search

<http://tv.somanuals.com>