

CONNECTING A VCR OR DVD TO THE DTV

VIDEO1 (ANALOG) JACKS

- 1 Connect a Composite cable to the VIDEO1 Yellow, White, and Red AV jacks.
- 2 **OPTIONAL**
Connect DVD to the TV S-Video In Jack, if available on your external equipment.
Note: S-Video jack connection overrides Video jack connection (VIDEO1).
- 3 Press **INPUT** to select *Video1* to view the VCR or DVD program.

IMPORTANT FACTS:

Don't be fooled by the phrase "Available in High-Definition." Composite jacks offer only 480i (SDTV) resolution.

To view available High-Definition (HD) programs, you must connect your HD equipment to the Component jacks.

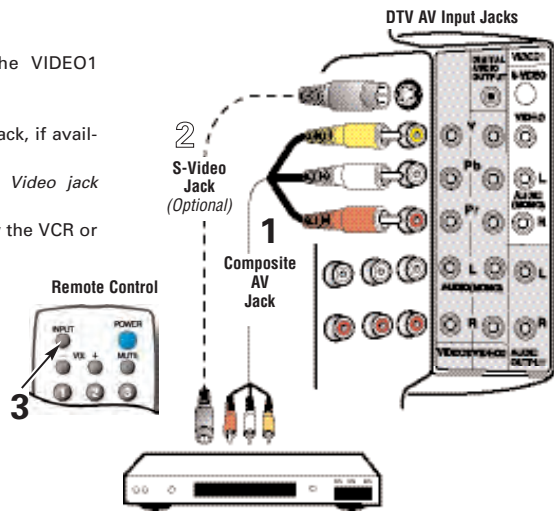

CONNECTING A MULTICHANNEL RECEIVER TO THE DTV

DIGITAL AUDIO OUT JACK

- 1 Connect a Multichannel Receiver to the TV Digital Audio Output as shown.

Note: Dolby® Digital 5.1 audio is available at the Digital Audio Output only when received as part of a Digital Antenna signal.

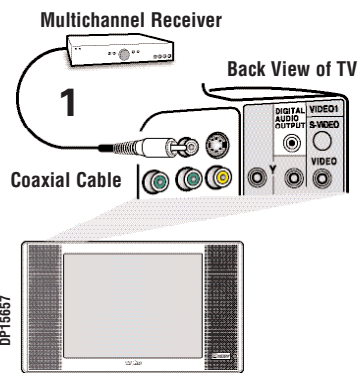

CONNECTING A STEREO AMPLIFIER TO THE DTV

AUDIO OUT (ANALOG) JACKS

- 1 Connect a Stereo Amplifier to the TV Audio Out jacks as shown.

Note: Do not connect external speakers directly to the DTV.

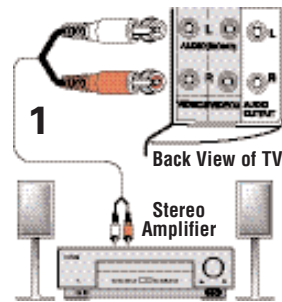

**If you experience problems, please call
1-800-877-5032,
We Can Help!**

REMOTE CONTROL OPERATION

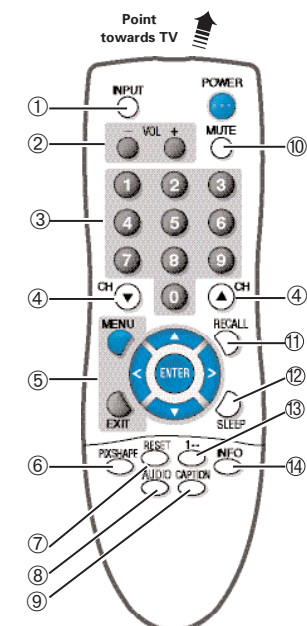

- 1 **Input Key**—Press to select the program source to watch: TV, Video 1, Video 2, or Video 3.
- 2 **Volume Keys**—Press VOL + to adjust.
- 3 **Number Keys**—Press two keys to select a channel. *Example:* Press 0 then 6 to select channel 6. (See #13.)
- 4 **Channel Scanning (CH ▲▼) Keys**—Press to scan through the channels in memory.
- 5 **Menu Navigational Keys:**
Menu—Press to display on-screen menu.
Cursor ▲ (up) ▼ (down) keys—Press these keys to move the cursor up and down within the menu.
Cursor < (left) > (right) keys—Press these keys to move the cursor left and right within the menu.

- 6 **Enter Key**—Press to select an option from the menu system, when required.
- 7 **Exit Key**—Press to exit from the menu system.
- 8 **PIX Shape Key**—Use to change the video display format. Available options depend on signal received and the broadcast's aspect ratio. *Note: Cannot display picture on a full screen. Check Aspect Ratio of broadcast. Then press PIX Shape key to change setting.*
- 9 **Reset Key**—Press this key twice to restore factory settings. The TV will automatically start Channel Search and clear all customized settings. *Note: Channel scan memory database list of digital and analog channels will be replaced.* If desired, personal settings can be made again using the menu options.
- 10 **Audio Key**—Press to select the desired audio mode (if available).
- 11 **Caption Key**—Captioning is text information transmitted along with the picture and sound so it can be displayed on the TV screen. Press **CAPTION** to select mode options: Digital CC1 ~ CC6, or Analog CC1 ~ CC4, OFF, or QuikCap. (QuikCap switches captions on and off with the Mute function.) Digital Captions can be changed using the menu settings.
- 12 **Mute Key**—Press once to mute the sound.
- 13 **Recall Key**—Press to switch between the last two channels selected.
- 14 **Sleep Key**—Press this key then the "0" key to set the Sleep Off Timer. Time can be set in 30-minute increments up to 3 hours. *Note: The Sleep Timer cancels when the TV is turned off or if a power failure occurs.*
- 15 **1-- Key**—For Analog Cable channels above 100, press this key, then press the other two numbers.
- 16 **Info Key**—Press to display the Digital and Analog Full Banner information. The banner contains the following: program title, station ID, program rating, signal strength, channel number, tuner ID, and audio information.

ENGLISH

LCD Owner's Manual

Part No.: 1JC6P1P0291 --

Please call us at
1.800.877.5032 if you need
assistance with your new HDTV.
We can Help!

Visit us at www.sanyoctx.com
for more information about these models.

SANYO

Model Nos.
DP15657
DP19657

FIRST-THINGS-FIRST (REQUIRED INITIAL SETUP)

- 1 Install batteries in remote control (2AA, not included)

PRECAUTIONS

To ensure safe operation, please observe the following precautions:

- Replace both batteries at the same time. Do not use a new battery with a used battery.
- Risk of explosion, if battery is replaced by an incorrect type.
- Do not expose the Remote Control Unit to moisture or heat.

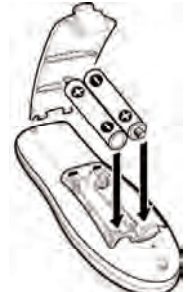

- 2 Connect Signal to the TV's Integrated Analog / Digital 75 ohm Antenna Input terminal

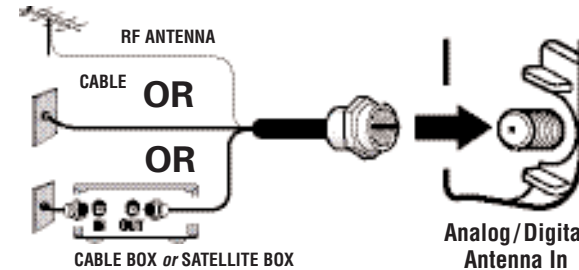

The Tuner in this DTV can receive:

1. Digital and/or Analog Off-Air Signals from an RF antenna.
- OR
2. Analog or ClearQAM cable channels.

Note: You must search for ClearQAM channels using the "Digital Cable Search" menu option.

- OR
3. The output from a VCR or cable box.

Digital signals from a Set-Top Box (STB) should be received through the Component In jacks.

This DTV can receive ANY unscrambled RF signal being broadcast.

Initial on-screen ALL Channel Search

First
Please connect all signals and antennas to jacks and terminals on the back of the TV.
Then press the Channel UP key.
Press EXIT key to cancel setup

ALL Channel Search [Analog & Digital]

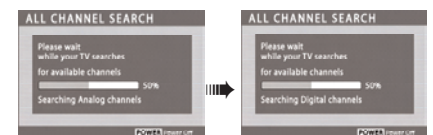

- 3 Plug in AC power cord (120V AC, 60 Hz.)

- 4 Press the **POWER** key.
(Follow on-screen instructions)

- 5 Perform "All Channel Search." The All Channel Search will search for off-air digital and analog channels, and analog cable channels. The DTV will receive cable or off-air channels, but not at the same time. *If after two searches the DTV still fails to detect any channels, the DTV will tune to Video1.*

Note: If EXIT is pressed, the DTV will skip Channel Search and tune to Video1 without storing any channels in the Channel Map database.

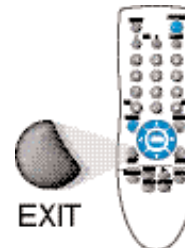

Trademarks Information:

Manufactured under license from Dolby Laboratories.
"Dolby" is a trademark of Dolby Laboratories.

CONNECTING A DVD OR GAME TO THE DTV

VIDEO 2 / 3 (COMPONENT VIDEO IN JACKS)

- 1 Connect a Component cable to the VIDEO2 / 3 Green, Blue, and Red video jacks.
- 2 Connect an Audio Cable to the VIDEO2 / 3 White and Red audio jacks.
- 3 Press **INPUT** to select *Video2* or *Video3* to view the program.

Note: VIDEO2 and VIDEO3 jacks have identical functions. Compatible video devices can be connected to either or both jacks.

OPERATING TIP:

You DO NOT need to tune the TV to Channel 3 or 4 to view DVD program.



DVD Player or similar digital device, such as a Satellite Receiver

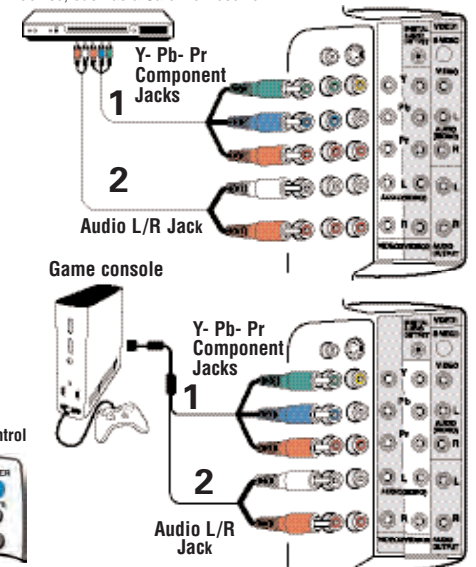

ON-SCREEN MENU OPERATION

MENU NAVIGATIONAL MAP

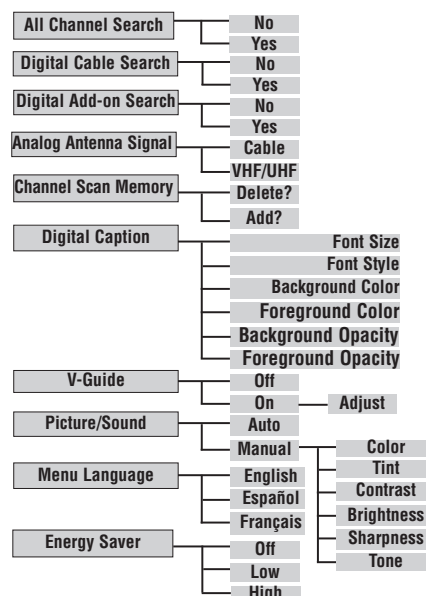

HOW TO OPERATE THE MENU

NOTES:

- Some Menu options are specific to Digital and Analog signals. To access these options, you must first tune the DTV to a digital or analog channel.

- "Not available" will be displayed on the screen if an unavailable menu option is selected.

- Press the MENU key to display the Main menu.
- Use the CURSOR ▲▼ keys to highlight menu item.
- Use the CURSOR < > keys to select or adjust menu item.
- Press ENTER to activate setting, if needed.

- When you have finished making adjustments, press the EXIT key to return to normal TV viewing.

Note: For menu items that have sub menus, follow on-screen instructions to select and make adjustments.

ALL Channel Search



DTV Cable or Add-On Search

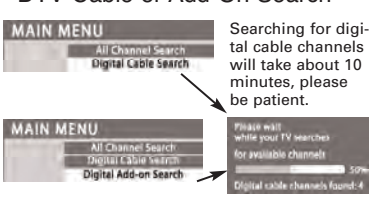

Picture/Sound Manual Adjustment

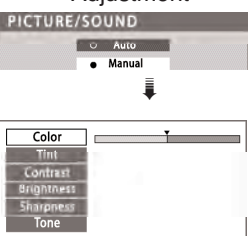

IMPORTANT FACTS:

- During All Channel Search, current Digital and Analog channel databases are deleted and new ones created.
- Optional—To receive Digital Cable unscrambled (ClearQAM) channels, if available, you must perform a Digital Cable Search. However, not all cable companies provide ClearQAM digital channels.
- To add new digital channels to the existing antenna channel database, use Digital Add-on Search. The channels received are based on the transmitting towers.

For more info go to www.antennaweb.org and type in your zip code to obtain specific tower and antenna information.

Channel Scan Memory

The Channel Scan Memory is a list of active channels that you can customize by deleting and/or adding channels. **HINT:** Use the CURSOR > key to select the channel number area.

IMPORTANT FACTS:

- When a digital channel is deleted, all of that channel's sub-channels are deleted as well.
- Only previous deleted digital channels can be added back to the Channel Scan Memory.
- If one digital sub-channel is added back to the Channel Scan Memory list, all of that channel's sub-channels will be added back.

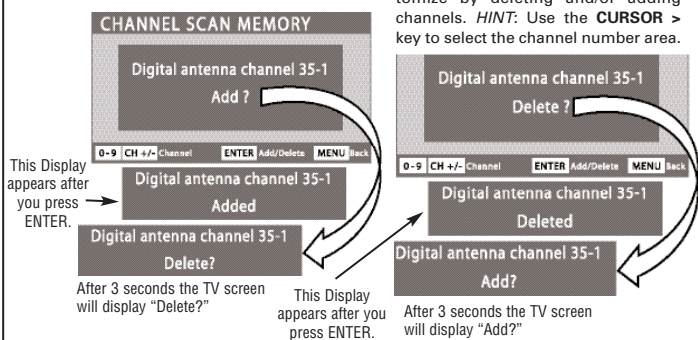

V-Guide (Parental Control)

Note: This feature is designed to comply with the United States of America's FCC V-Chip regulations. Therefore, it may not function with broadcasts that originate in other countries.

Use this feature to supervise the television viewing of young children. This TV can be set to automatically block programs with content you deem as inappropriate for your children to view.

OPERATING TIP:

You can block portions of a TV rating by choosing one or more of the Content ratings (D, L, S, and V). By blocking just the L and S content ratings of TV-14, for example, TV-14 rated programs with a D and/or V content rating could still be viewed.

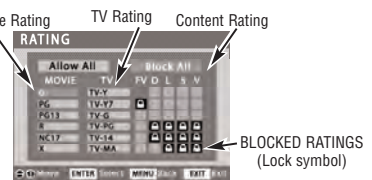
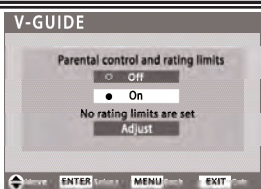

Energy (power) Saver

This power saving feature reduces the backlight brightness level. The power saving function options:

- OFF – the feature is off and the power consumption is normal

- LOW – power saving level is low and the backlight brightness level is lower than normal
- HIGH – power saving level is high and the backlight brightness is set to the lowest level

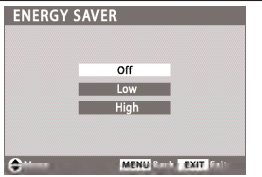

PROTECTING THE LCD SCREEN

The screen is likely to be damaged if it is not maintained properly. Do not use hard objects such as hard cloth or paper. Do not use excessive pressure when cleaning the LCD screen; excessive pressure can cause permanent discoloration or dark spots. NEVER spray liquids on the screen.

LCD PANEL LAMPS CONTAIN MERCURY. DISPOSE OF PROPERLY.

ONE-YEAR LIMITED PARTS AND LABOR WARRANTY

THIS LIMITED PARTS AND LABOR WARRANTY IS VALID ONLY ON SANYO TELEVISIONS PURCHASED AND USED IN THE UNITED STATES OF AMERICA, CANADA, AND PUERTO RICO, EXCLUDING ALL OTHER U.S. TERRITORIES AND PROTECTORATES. THIS LIMITED WARRANTY APPLIES ONLY TO THE ORIGINAL RETAIL PURCHASER, AND DOES NOT APPLY TO PRODUCTS USED FOR INDUSTRIAL OR COMMERCIAL PURPOSES.

WARRANTY APPLICATION

FOR ONE YEAR from the date of original retail purchase Sanyo Manufacturing Corporation (SMC) warrants this TV to be free from manufacturing defects in materials and workmanship under normal use and conditions for parts and labor.

For the **FIRST 90 DAYS** from the date of original retail purchase, Sanyo Manufacturing Corporation will replace any defective TV via exchange at the retailer. To ensure proper warranty application, keep the original-dated-sales receipt for evidence of purchase. Return the defective TV to the retailer along with the receipt and the included accessories, such as the remote control. The defective TV will be exchanged for the same model, or a replacement model of equal value, if necessary. Replacement model will be contingent on availability and at the sole discretion of Sanyo Manufacturing Corporation.

THE FOREGOING WARRANTY IS EXCLUSIVE AND IN LIEU OF ALL OTHER WARRANTIES OF MERCHANTABILITY OR FITNESS FOR A PARTICULAR PURPOSE.

OBLIGATIONS

For one year from the date of purchase, Sanyo Manufacturing Corporation warrants this product to be free from defects in material and workmanship under normal use and conditions. During the first 90 days under this warranty for any manufacturing defect or malfunction Sanyo Manufacturing Corporation will provide a new TV via exchange at the retailer.

HOW TO MAKE A CLAIM UNDER THIS WARRANTY

Please call 1-800-877-5032. Please be prepared to give us the television's model number and serial number when you call. The model number and serial number are printed on a label attached to the back of the unit.

For customer assistance, call toll free 1-800-877-5032.

Weekdays 7:30 AM – 7:00 PM Central Time
Saturday 7:30 AM – 4:00 PM Central Time

This warranty expresses specific contractual rights; retail purchasers may have additional statutory rights which vary from state to state.

(EFFECTIVE: March 1, 2007)

For your protection in the event of theft or loss of this product, please fill in the information requested below and KEEP IN A SAFE PLACE FOR YOUR OWN PERSONAL RECORDS.

Model No. _____ Date of Purchase _____ Where Purchased _____
Serial No. _____ Purchase Price _____

(Located on back of unit)



Sanyo Manufacturing Corporation • 3333 Sanyo Road, Forrest City, AR 72335



This symbol on the nameplate means the product is Listed by Underwriters' Laboratories Inc. It is designed and manufactured to meet rigid U.L. safety standards against risk of fire, casualty, and electrical hazards.



"As an ENERGY STAR® Partner, Sanyo Manufacturing Corporation has determined that this product meets the ENERGY STAR® guidelines for energy efficiency."

CAUTION RISK OF ELECTRIC SHOCK DO NOT OPEN	THIS SYMBOL INDICATES THAT DANGEROUS VOLTAGE CONSTITUTING A RISK OF ELECTRIC SHOCK IS PRESENT WITHIN THIS UNIT.
CAUTION: TO REDUCE THE RISK OF ELECTRIC SHOCK, DO NOT REMOVE COVER (OR BACK). NO USER-SERVICEABLE PARTS INSIDE. REFER SERVICING TO QUALIFIED SERVICE PERSONNEL.	THIS SYMBOL INDICATES THAT THERE ARE IMPORTANT OPERATING AND MAINTENANCE INSTRUCTIONS IN THE LITERATURE ACCOMPANYING THIS UNIT.

WARNING: TO REDUCE THE RISK OF FIRE OR ELECTRIC SHOCK, DO NOT EXPOSE THIS APPLIANCE TO RAIN OR MOISTURE.

IMPORTANT SAFETY INSTRUCTIONS

Important Safety Instructions for LCD DTV

- Read these instructions.
- Keep these instructions.
- Heed all warnings.
- Follow all instructions.
- Do not use this apparatus near water.
- Clean only with dry cloth.
- Do not block any ventilation openings. Install in accordance with the manufacturer's instructions.
- Do not install near any heat sources such as radiators, heat registers, stoves, or other apparatus (including amplifiers) that produce heat.
- Do not defeat the safety purpose of the polarized or grounding-type plug. A polarized plug has two blades with one wider than the other. A grounding-type plug has two blades and a third grounding prong. The wide blade or the third prong are provided for your safety. If the provided plug does not fit fully into your outlet, consult an electrician for replacement of the obsolete outlet.
- Protect the power cord from being walked on or pinched particularly at plugs, convenience receptacles, and the point where they exit from the apparatus.
- Only use attachments/accessories specified by the manufacturer.
- Use only with the cart, stand, tripod, bracket, or table specified by the manufacturer, or sold with the apparatus. When a cart is used, use caution when moving the cart/apparatus combination to avoid injury from tip-over.
- Unplug this apparatus during lightning storms or when unused for long periods of time.
- Refer all servicing to qualified service personnel. Servicing is required when the apparatus has been damaged in any way, such as power-supply cord or plug is damaged, liquid has been spilled or objects have fallen into the apparatus, the apparatus has been exposed to rain or moisture, does not operate normally, or has been dropped.

- If an outside antenna is connected to the television equipment, be sure the antenna system is grounded so as to provide some protection against voltage surges and built up static charges. In the U.S. Selection 810-21 of the National Electrical Code provides information with respect to proper grounding of the mast and supporting structure, grounding of the lead-in wire to an antenna discharge unit, size of grounding conductors, location of antenna discharge unit, connection to grounding electrodes, and requirements for the grounding electrodes.
- An outside antenna system should not be located in the vicinity of overhead power lines or other electrical light or power circuits, or where it can fall into such power lines or circuits. When installing an outside antenna system, extreme care should be taken to keep from touching such power lines or circuits as contact with them might be fatal.

EXAMPLE OF ANTENNA GROUNDING TO NATIONAL ELECTRICAL ANS/IFPA

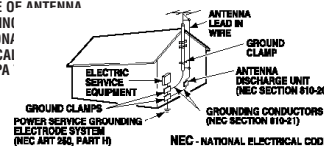

*Note to CATV system installer: This reminder is provided to call the CATV system installer's attention to Article 820-40 of the NEC that provides guidelines for proper grounding and, in particular, specifies that the cable ground shall be connected to the grounding system of the building, as close to the point of cable entry as practical."

- Wall or Ceiling Mounting—The product should be mounted to a wall or ceiling only as recommended by the manufacturer.
- "Apparatus shall not be exposed to dripping or splashing and no objects filled with liquids, such as vases, shall be placed on the apparatus."
- When the MAINS plug is used as the disconnect device, the disconnect device shall remain readily operable.

VIEWING ANGLES (BRIGHTNESS)

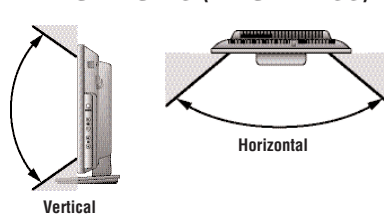

NOTES: The picture may appear too dark when viewed outside the normal viewing angles. Use the Tilt feature to adjust the vertical angle for optimum viewing.

WALL MOUNTING: VESA standard interface 100 x 100.) Note: Wall Mounting kit is not supplied. LCD Mounting screws measurements: M4 Diameter, Length—10mm (maximum).

USING THE DETACHABLE TV TILT STAND

To change the viewing angle of your TV, position your hand on the top and hold the stand firmly, then tilt the LCD screen forward or backward. **CAUTION:** Do not position hand under the screen while tilting the TV forward.

DETACHING THE TV TILT STAND

Tools Needed: Phillips screwdriver

Important Note: Place DTV face down on a padded or cushioned surface to protect the screen and finish.

- Remove two (2) screws from the metal bracket. **CAUTION:** Hold the stand firmly as you remove the last screw.

- Carefully remove the DTV stand.



Free Manuals Download Website

<http://myh66.com>

<http://usermanuals.us>

<http://www.somanuals.com>

<http://www.4manuals.cc>

<http://www.manual-lib.com>

<http://www.404manual.com>

<http://www.luxmanual.com>

<http://aubethermostatmanual.com>

Golf course search by state

<http://golfingnear.com>

Email search by domain

<http://emailbydomain.com>

Auto manuals search

<http://auto.somanuals.com>

TV manuals search

<http://tv.somanuals.com>