

V.I.P.® Plus -150°C Cryogenic Freezers

MDF-C2156VANC



Ideally suited for ultra low and cryogenic storage in laboratories, long-term preservation and storage of blood, specimens and components, and testing of various types. The V.I.P.® Plus™ technology maximizes storage capacity over conventionally insulated models.



Model: MDF-C2156VANC, 8.2 cu.ft. (231L)

-150°C Cryogenic Temperature Freezer

Cryopreservation allows for storage of biological materials at ultra low temperatures, while minimizing the level of freezing damage to cells. An important factor to consider when preserving cells or tissue at cryogenic temperatures is to prevent amorphous ice crystals from recrystallizing within and outside the cells. These ice crystals increase the degree of freezing damage to cells.

-130°C is the recrystallization point of pure water in the ultra-low temperature zone. This is the temperature at which amorphous ice crystals recrystallize. For a mixed solution containing Me2SO and other cryoprotectants, recent research confirms that recrystallization occurs around -115°C. Thus samples maintained in an ultra-low temperature freezer at -150°C, far lower than the recrystallization point, can be semi permanently preserved. Such preservation maintains vitrification without further crystallization within and outside cells. Other recent findings show that preserving cattle sperm at -135°C is insufficient, and also that superconductivity experiments require temperatures of at least -148°C. These cases show the increased necessity of -150°C freezing in a diverse array of cryogenic applications.

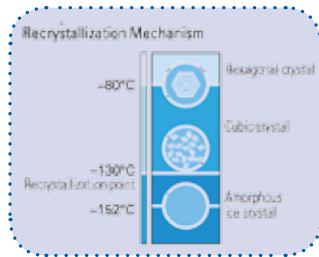

VIP® Plus™ Design

• SANYO V.I.P.® PLUS™ Cryogenic Series -150°C ultra-low temperature freezers use patented revolutionary vacuum insulation cabinet construction that reduces the wall thickness from 175mm to 135mm (6.9" to 5.3") and achieves up to 25% more storage capacity than a conventionally insulated freezer

without increasing the footprint.

• This design prevents the insulation layers from distortion and cracking that might occur due to temperature differences inside and out, and creates the most efficient insulation material available today.

• Moisture condensation at the top edges of the cabinet due to differences in temperature inside and out causes frost and icing problems, which may reduce heat insulation efficiency and obstruct door movements. These obstructions are prevented by the "hot line" which prevents frost and condensation from forming on the gasket and mullion

• The newly developed refrigeration system and the freezer structure offer a quiet experimental environment.

• Achieves 50% higher energy conservation than conventionally insulated model.

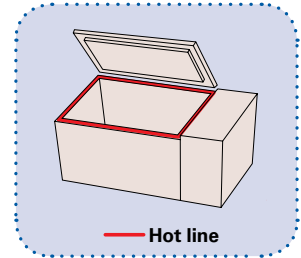

Specially Designed Compressor for Cryogenic Temperatures

The refrigeration system is at the heart of producing cryogenic temperature freezing. In the process of developing various technical solutions in order to achieve and maintain cryogenic temperatures, SANYO designed the compressor specifically for this use. SANYO is a leading manufacturer of cryogenic temperature freezers.



Liquid Nitrogen Vapor Storage

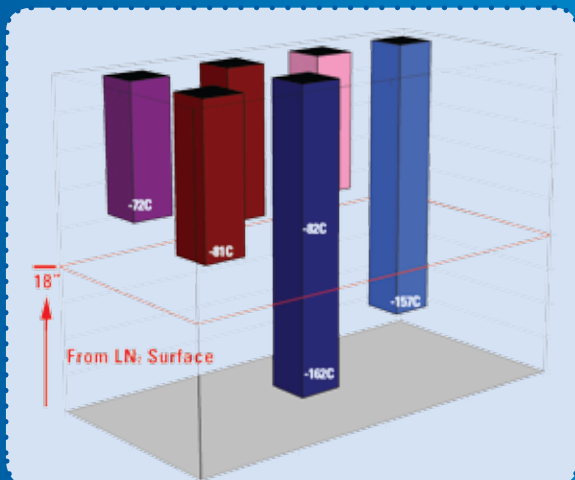

Mechanically Refrigerated Cryogenic Freezer

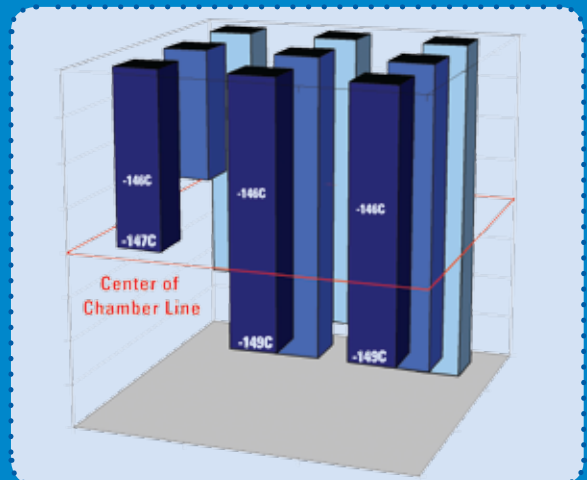

Comparison of temperature distribution in a liquid nitrogen freezer (vapor phase) and SANYO's MDF-C2156VANC mechanically refrigerated cryogenic freezer. Graph shows temperatures at different locations within the chamber. This data demonstrates that 100% of the MDF-C2156VANC storage space maintains uniform storage temperatures safely below -130°C, while temperature in liquid nitrogen varies significantly.

Microprocessor Temperature Control With Digital Design

Precise setting and temperature control. The temperature inside the freezer can be set and monitored easily by means of precise microprocessor temperature control with an LCD graphic display. The controller utilizes a platinum sensor which is extremely precise and durable.

Built-In Temperature & Power Failure Alarms (Lamp/Buzzer)

- Status Alert monitors ambient and system conditions continuously and notifies of any abnormalities before a problem happens.
- In case of power failure or an irregular rise in temperature, a rechargeable, Cadnica battery operated indicator lamp and alarm will be activated.

Built-in LN₂ Backup

- The MDF-C2156VANC is equipped with LN₂ backup system as standard to prepare for any contingency. Built-in LN₂ back-up system and is self activated when a power outage occurs. This feature helps ensure that the contents will be protected in the event of any power failure or mechanical trouble.

Innovative Control & Monitoring

- Graphic LCD panel with pop-up menu function on control panel provides more visual display and allows intuitive operation.
- Data logging function records of internal temperature for one month or one week period. The controller also records the history of lid opening/closing (more than 2 minutes)

Easy to Operate

Overall operability and dependability are greatly enhanced by improved design details. Highly durable hinges are used to support the freezer door so both opening and closing are facilitated. Door handles are equipped with a latch-locking system.

Low-profile Design for Easier Loading and Unloading

The chest-type design provides a stable inside temperature and a low profile greatly facilitates loading and unloading.

Mechanical Freezer Preservation

Mechanical freezer preservation provides users with numerous advantages: provides uniform cryogenic storage temperatures, no worries about sample contamination, no liquid supply problems, no danger of sudden liquid eruptions, and low operational costs. This freezer provides easier and more stable long-term storage below the recrystallization point than ever before.

An Ideal Freezing Environment with V.I.P.[®] Plus™ Design

In Ultra-Low temperature freezers, effective insulation is extremely critical since the temperature difference between the outside and the inner compartment can be as high as 115°C. V.I.P.[®] Plus™ offers superior performance in insulating properties providing unsurpassed uniformity in the chamber- top to bottom, side to side, front to back.

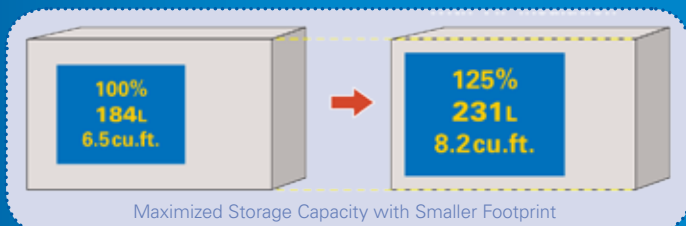

Ideal Alternative to LN₂ Storage

LN₂ Storage

Until recently, liquid preservation containers were mainly used when preserving valuable samples over long periods of time. This method however, involved troublesome liquid control and the dangers of a liquid supply. In addition, mycoplasma etc., could cause cell and tissue contamination in liquid phase preservation. As a solution to this problem, demand for vapor phase preservation has increased. In preservation with liquid nitrogen vapor, temperatures drop to approximately -150°C, the same as a mechanical cryogenic freezer's inner cabinet temperature of -150°C. However, the temperature in a LN₂ system varies by the location of the sample within the chamber.

The MDF-C2156VANC has a graphic LCD panel with a pop-up menu function on the control panel providing a more visual display and allows intuitive operation.

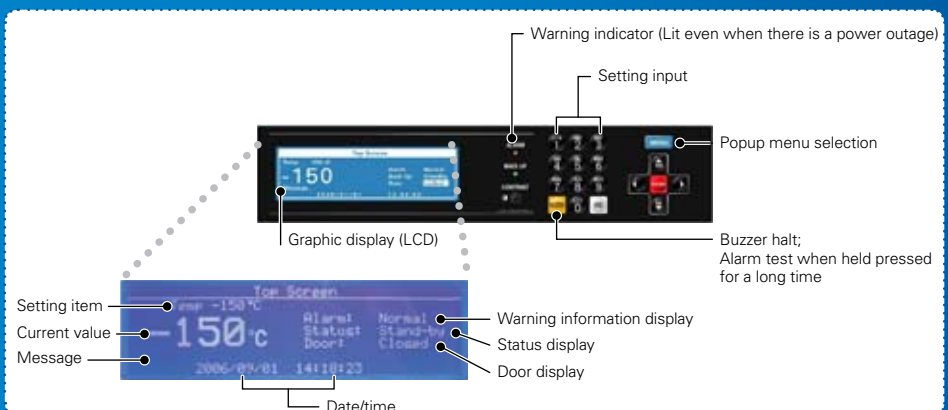

Specifications



Model	MDF-C2156VANC
Temp. Range	-125°C to -150°C (1°C increments)
Max. cooling performance	-150°C (Ambient Temp. 30°C)
Exterior dimensions (W x D x H)	68.1" x 30.1" x 39.8" (1730 x 765 x 1010mm)
Interior dimensions (W x D x H)	29.9" x 19.5" x 24.2" (760 x 490 x 615mm)
Net weight	Approx. 699lbs (318kg)
Effective capacity	8.2 cu.ft. (231L)
Access port	40mm diameter, 1 location
Compressor	Hermetic type, 1.5HP (high stage side) 1.5HP (low stage side)
Refrigerants	CFC Free
Alarm	High/Low temperature, Power failure, filter check, Self diagnosis, Lid check
Remote alarm contact	Allowable contact capacity DC 30V, 2A
Power requirements	208V-230V, 1 phase, 60Hz NEMA 6-15R (15 Amp) Receptacle

*Appearance and specifications are subject to change without notice

Dimensions [mm (inch)]

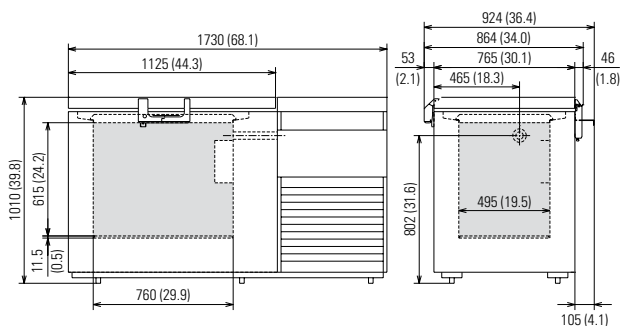

Cryogenic Preservation Applications

- Cancer Research: Tumor Cells
- Blood Banking: HLA, Red Cells
- Bone Marrow Preservation: Skin, Bone, Heart Valves, Corneas, Musculoskeletal Tissues
- Microbiology: Viruses, Bacteria, Cell Culture
- Genetic Engineering - Cultures
- HLA: (Lymphocytes) Organ Transplant
- IVF: (Embryo, Sperm) Human Infertility
- Sperm & Fertilized Ovum (Bull, Goat, Horse, Pig, Chicken) Preservation
- Plant Cell Preservation
- Monoclonal Antibody Preservation
- Pharmaceutical: Cultures
- Repositories: Cell Cultures

Performance Data

Pull-down characteristics

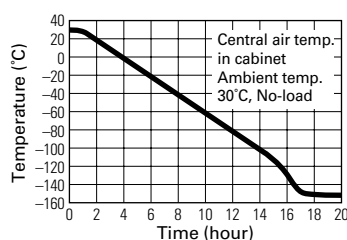

Pull-up characteristics during power failure

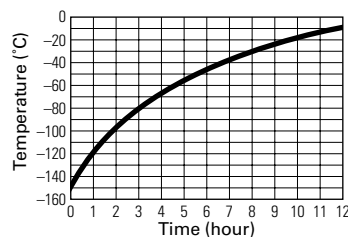

LN₂ back up system operation characteristics

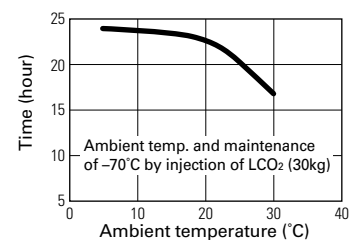

Options



Circular recorder
MTR-C954

Inventory rack:
SCR-102-N
SCR-073-N

SANYO Electric Co.,Ltd., Biomedical Division, Gumma is certified for Quality management system:ISO9001/ Medical devices Quality management system:ISO13485/ Environmental management system:ISO14001



SANYO is committed to developing green technologies that provide energy efficiency resulting in lower operational costs with less impact on the environment.

Product conforms to RoHS (European Restriction of Hazardous Substance directive).

Download from www.Somanuals.com. All Manuals Search And Download.



SANYO Commercial Solutions
A Division of SANYO North America Corporation
1300 Michael Drive, Wood Dale, IL 60191 USA
Toll Free USA 800-858-8442 • Fax 630-238-0074
www.sanyobiomedical.com

SANYO Canada, Inc.
1-300 Applewood Crescent, Concord, Ontario L4K 5C7
905-760-4025 • Fax 905-760-9945

Free Manuals Download Website

<http://myh66.com>

<http://usermanuals.us>

<http://www.somanuals.com>

<http://www.4manuals.cc>

<http://www.manual-lib.com>

<http://www.404manual.com>

<http://www.luxmanual.com>

<http://aubethermostatmanual.com>

Golf course search by state

<http://golfingnear.com>

Email search by domain

<http://emailbydomain.com>

Auto manuals search

<http://auto.somanuals.com>

TV manuals search

<http://tv.somanuals.com>