

Service Manual

FILE No.

Ultra-Low Temperature Freezer **MDF-C8V**

SANYO Electric Co., Ltd.
Biomedical Business Unit



! RoHS

This product does not contain any hazardous substances prohibited by the RoHS Directive.
(You will find 'RSF' mark near the rating plate on the RoHS compliant product.)

! WARNING

- * You are requested to use RoHS compliant parts for maintenance or repair.
- * You are requested to use lead-free solder.

Effective models

This service manual is effective following models.

Model name	Product code	Voltage and Frequency	
MDF-C8V	823 187 51	115V	60Hz
	823 187 52	220/230/240V	50Hz

Contents

	Page
Features	1
Specifications	2
- Structural specifications	
- Control specifications	
- Performance specifications	
Dimensions	5
Refrigeration circuit diagram	6
Refrigeration circuit welding points	7
Cooling unit parts	8
Components on PCB	9
Electrical parts	10
Specifications of sensor	11
Wiring diagram	12
Circuit diagram	13
Connections on PCB	14
Control specifications	15
Parts layout	23
Test data	26
- Pull-down	
- Pull-up	
- Unit pressure	
- Power consumption and current input	
Collection and charge of refrigerant	30
Instruction manual	32

Operational specification of condensing fan motor

- When ambient temperature is lower than 20°C, condensing fan motor activates with 30 min. of delay at least after the unit starts running.
- When ambient temperature is lower than 20°C, condensing fan motor does not always activate.

Procedures for trial operation

1. Turn all the switches (Power SW and Battery SW) off beforehand.
2. Connect the plug to outlet then turn Power SW on.
3. Turn Battery SW on.

(Note) If you turn Battery SW on prior to Power SW,
buzzer would be emitted until the unit reaches to SV.

Features

- Space saving freezer for personal use
 - 'Glass wool' core is newly adopted for insulation
 - Width 550mm for minimal installation

- Suitable internal dimensions for inventory racks
 - 6 pcs of inventory rack (IR-207C) *
 - * 5pcs of inventory rack when Back-up kit (CVK-UB4) installed

- Ensure preservation
 - Selectable high temperature alarm
 - Setting temperature can be kept by remote alarm terminal and non-volatile memory

- Easy maintenance
 - 'Filter-less' cooling circuit made clean up unnecessary

- Environmental friendly
 - HFC mixed refrigerant (R245fa, R600, R23 and R14)
 - HC foaming insulation

- Optional component
 - Automatic temperature recorder: MTR-G85/MTR-85H
 - Recorder mounting kit: MDF-S3085 for MTR-85H
 - Recorder sensor cover: MTR-C8
 - Back-up system: CVK-UB4
 - Back-up mounting plate: MDF-UBK
 - Inventory rack: IR-207C, IR-305C

Specifications

■ Structural specifications

Item	Specifications
External dimensions	W 550 × D 685 × H 945 (mm)
Internal dimensions	W 405 × D 490 × H 425 (mm)
Effective capacity	84 L
Exterior	Painted steel
Interior	Painted steel
Door	Painted steel
Insulation	Cabinet; Rigid polyurethane foamed-in place and VIP(vacuum insulation panel) Door; Rigid polyurethane foamed-in place
Door lock	1pc (also used as a latch)
Caster	4pc, (2 leveling foot)
Access port	φ 17mm, back side, bottom
Compressor	Hermetic rotary type, 400W
Evaporator	Tube on sheet type (also used as a inner cabinet)
Condenser	Finless tube type
Refrigerant	HFC mixed refrigerant (R245fa/R600/R23/R14)
Refrigerant oil	Ze-NIUS32SA
Power supply	Local voltage
Weight	64 kg
Accessory	1 set of key, 1 scraper
Optional component	Automatic temperature recorder (MTR-85H, MTR-G85) Mounting kit for MTR-85H (MDF-S3085) Recorder sensor cover (MTR-C8) Back-up system (CVK-UB4) Back-up mounting plate (MDF-UBK) Inventory rack (IR-207C, IR-305C)

■Control specifications

Item		Specifications
Cooling performance		-80°C (1/2H temp, AT 30°C, no load)
Temperature control range		-60°C~-80°C(AT5~30°C, no load)
Temperature controller		Microprocessor controlled system: Key-pad input Temperature set range: -55°C~-85°C (1°C increment) Set value kept in non-volatile memory
Temperature sensor		Pt.1000Ω
Temperature display		LED digital display (1°C increment)
Alarm	Temperature	Selectable +5°C~+20°C for high temp. alarm (Initial; +10°C) ALARM lamp blinks and intermittent buzzer beeps with 15min.of delay Remote alarm contact: Normal Open, rating 30VDC, 2A Temperature alarm turns on during power failure (not linked with buzzer)
	Filter	None
	Power failure	ALARM lamp blinks with intermittent buzzer beeps, remote alarm outputs.
	Remote alarm	3P remote alarm terminal: Maximum 30VDC, 2A NC-COM、 NO-COM Outputs during temperature alarm and power failure alarm.
	Battery	BATTERY lamp is lit. Accumulating period: 2.8 years
Control panel		Lamp: ALARM, BATTERY BUZZER: Buzzer key ALARM TEST: Alarm test key SET: To switch SV and PV >: To shift the digit Λ: To change the digit
Key lock function		With > key is pressed for 5 seconds; L0: Unlocked L1: Locked
Self diagnosis function		When any failure occurs on the temperature sensor, <ul style="list-style-type: none"> • Error code and internal temp.(PV) are alternately displayed. • Remote alarm contact is ON and the buzzer beeps.
Power switch		None
Compressor protection		Overload relay, Comp. sensor

■Performance specifications

Cooling performance	-80°C (ambient temperature; 30°C,no load)					
Temperature control range	-60°C to -80°C(ambient temperature; 30°C,no load)					
Rated voltage	AC110V	AC115V	AC220V	AC230V	AC240V	AC220V
Rated frequency	60Hz	60Hz	50Hz	50Hz	50Hz	60Hz
Rated power consumption	295W	300W	310W	325W	350W	310W
Noise level	49 dB [A] (background noise; 20 dB)					
Maximum pressure	3.7 MPa					

Note) Specifications will be subject to change without notice.

Dimensions

<MDF-C8V>

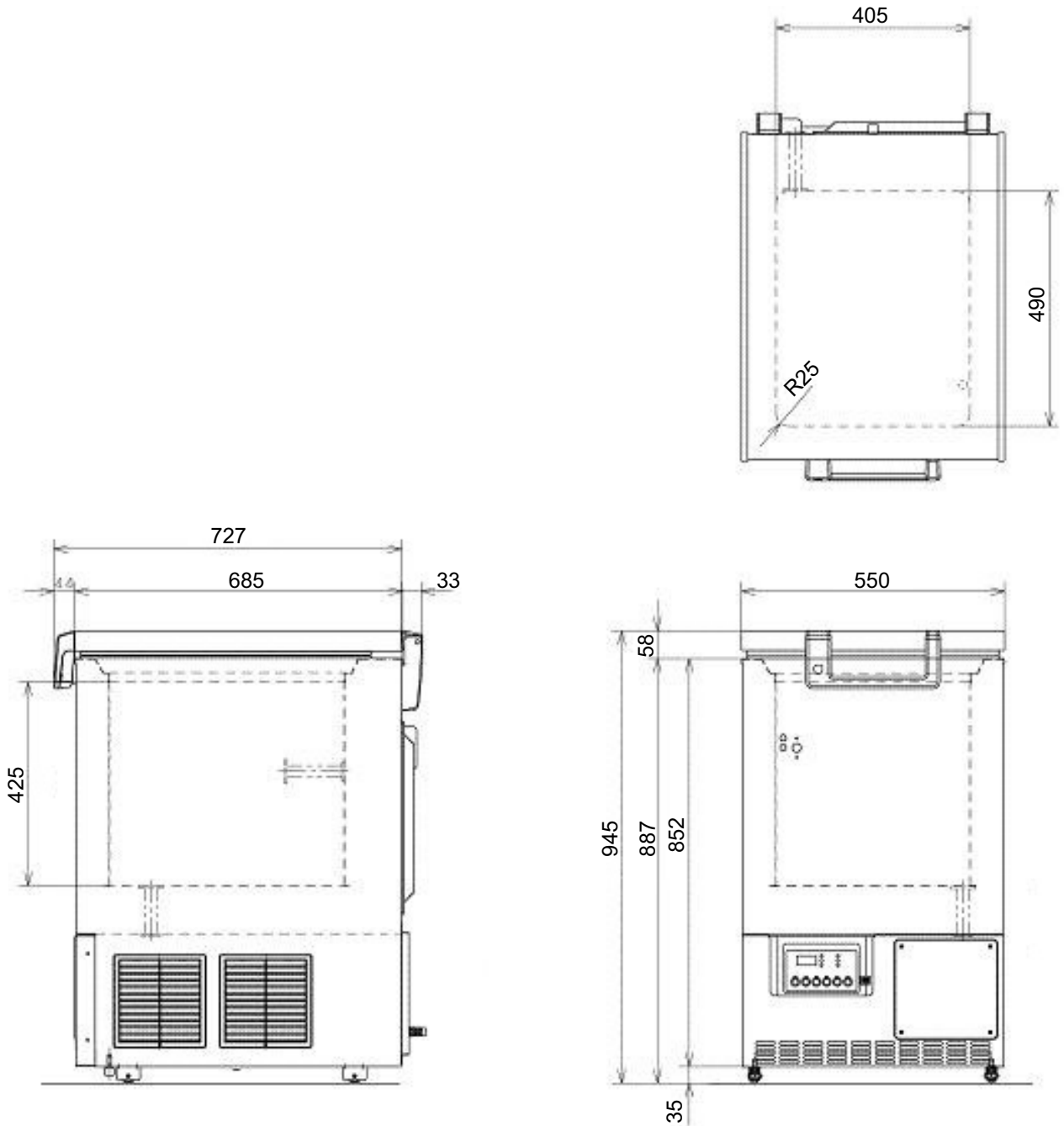

Refrigeration circuit diagram

REFRIGIATION CIRCUIT
PRINCIPLE DIAGRAM

(MDF-C8V)

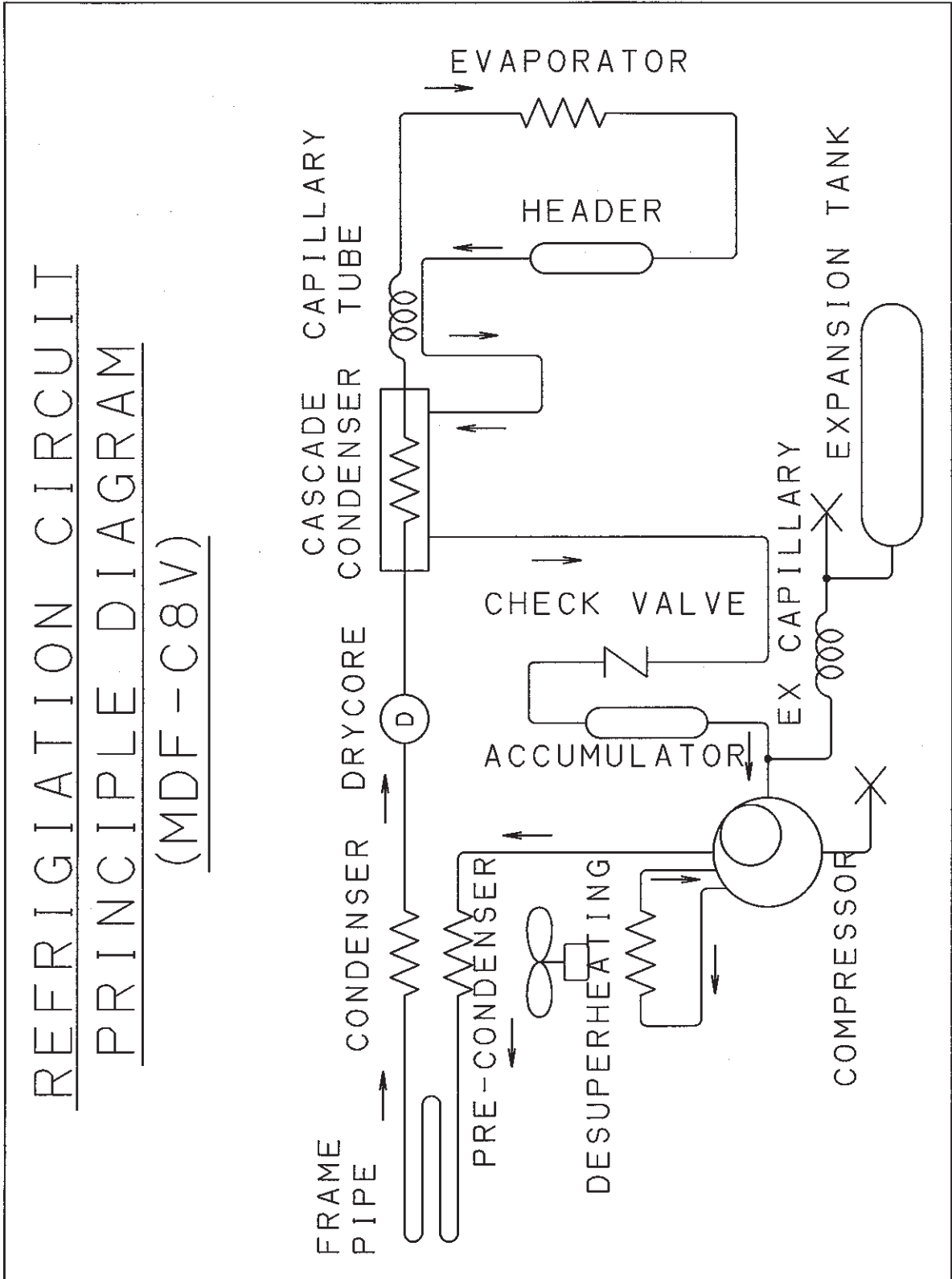

Refrigeration circuit welding points

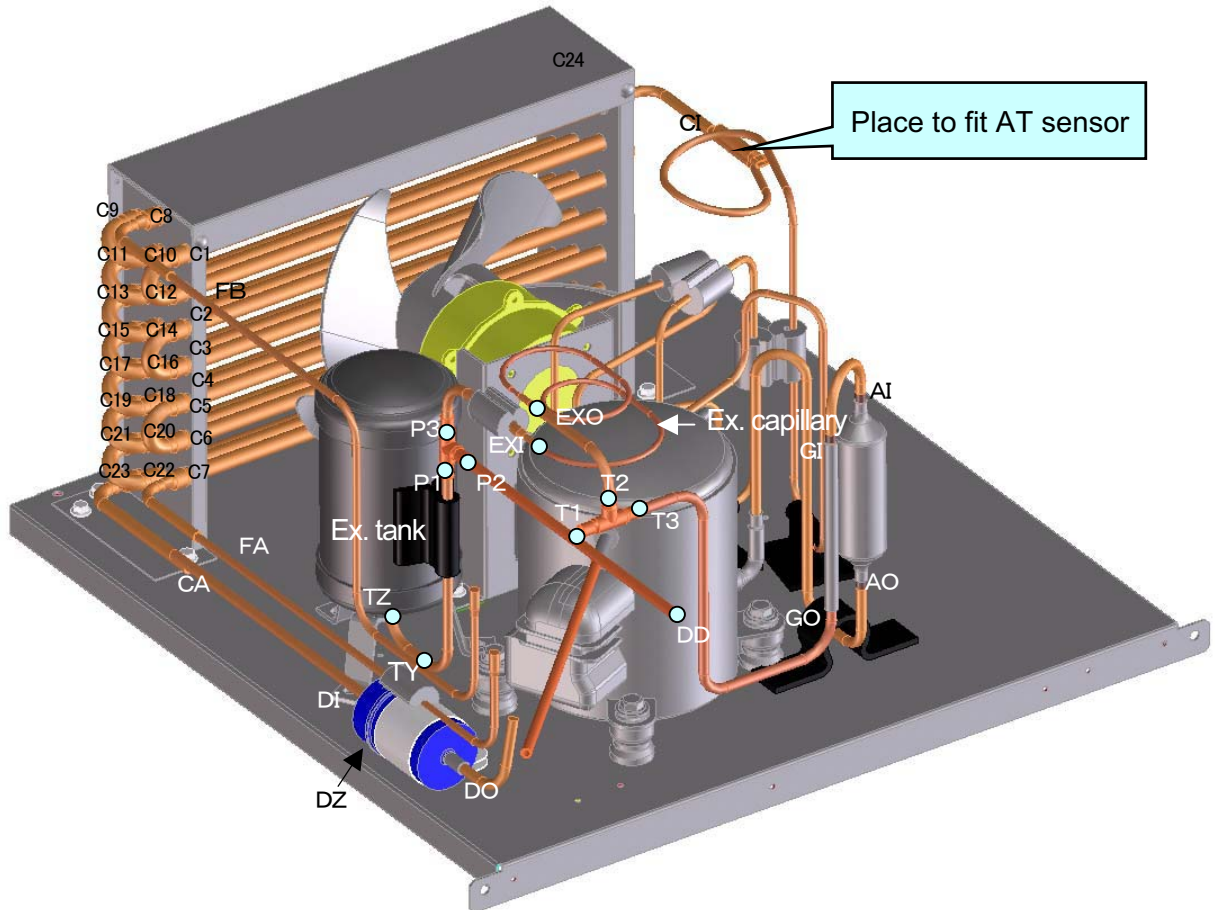

Components on PCB

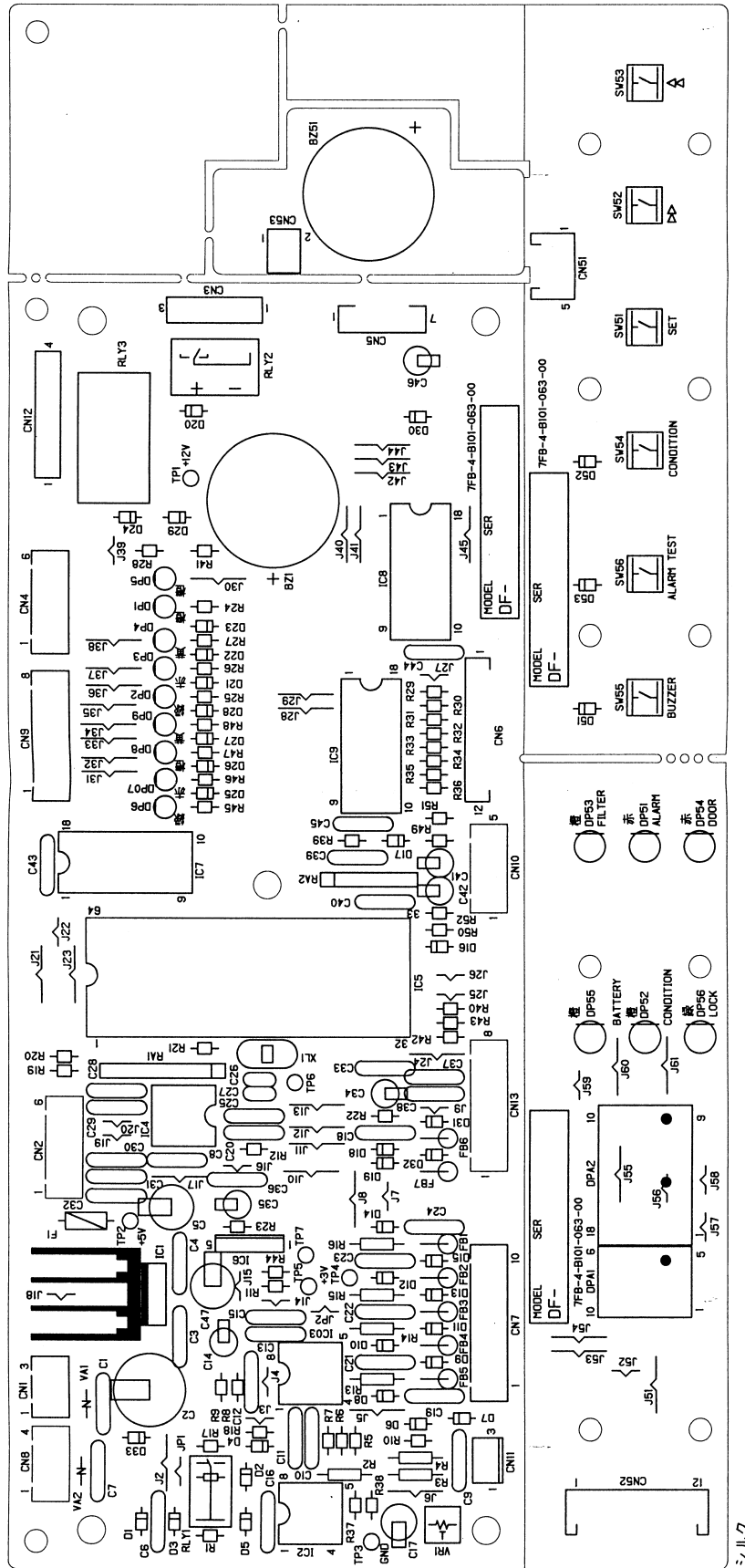

シムク

Electrical Parts

MDF-C8V		AC115V, 60Hz	AC220/230/240V, 50Hz
Compressor	Type	C-2SN400L2W	C-2SN400L5W
	Compressor code	807 780 22	807 780 25
	Rated voltage (50/60Hz)	ϕ 1, 110~115V, 60Hz	ϕ 1, 220~240V, 50/60Hz
	Winding resistance C-S(Aux)	5.432 Ω	18.79 Ω
	C-R(Main)	1.824 Ω	6.251 Ω
Starting relay	Type	AMVL-180A	AMVL-300A
	Pick up voltage	108~128VAC	215~247VAC
	Drop out voltage	30~75VAC	69~132VAC
	Parts code	626 100 1527	626 100 1503
	Overload relay	Type	P22MUF
Action to the temp. (No current)		ON:69+/-10 OFF:130+/-8	ON:69+/-10 OFF:150+/-8
Action to the current (AT25°C)		22.5A	11.5A
Operation time		6~15 sec.	6~15 sec.
Non-Action to the temp. (80°C)			
Non-Action		5.15A	3.3A
Action		6.9A	4.2A
Parts code		626 100 6751	624 227 3554
Starting capacitor	Rating	100 μ F, 160VAC	30 μ F, 300V
	Parts code	626 120 2320	626 120 2085
Running capacitor	Rating	20 μ F, 220VAC	4 μ F, 400V
	Parts code	626 120 1477	626 120 1538
Condensing fan motor	Type	SE4-D041N1P	SE4-D041N5P
	Rating	115V, 4P	230V, 4P
	Parts code	624 225 1712	624 227 3554
Temp. control relay	Type	G4F-11123T	G4F-11123T
	Contact capacity	20A, 12VDC	20A, 12VDC
	Parts code	624 173 2397	624 173 2397
Fan relay	Type	G2R-1A-T	G2R-1A-T
	Contact capacity	12V, 10A, 250V	12V, 10A, 250V
	Coil	12VDC	12VDC
	Parts code	624 188 9299	624 188 9299
Switching power supply	Type	ZWS10-12/J	ZWS10-12/J
	Rated output	12VDC, 0.85A	12VDC, 0.85A
	Parts code	624 209 9277	624 209 9277
Breaker switch	Type	BAM215131	BAM215131
	Rating	250V, 15A	250V, 15A
	Parts code	624 215 4235	624 215 4235
Temperature sensor	Type	THC-663 (PT sensor)	THC-663 (PT sensor)
	Rating	1000 Ω	1000 Ω
	Parts code	624 225 3495	624 225 3495
Compressor sensor	Type	502AT-1	502AT-1
	Rating	5k Ω , 25°C	5k Ω , 25°C
	Parts code	624 030 1129	624 030 1129
Battery switch	Type	SLE6A2-5	SLE6A2-5
	Rating	4A, 250VAC	4A, 250VAC
	Parts code	624 213 1472	624 213 1472
Battery	Type	5HR-AAC	5HR-AAC
	Rating	6V, 1100mAH	6V, 1100mAH
	Parts code	624 209 9284	624 209 9284

<Compressor terminals layout>

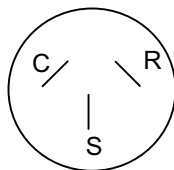

Specification of sensor

Following shows the relation between temperatures of temp. sensor (Pt1000Ω) and resistance value.

Temperature (°C)	Resistance (Ω)	Temperature (°C)	Resistance (Ω)
-170	326.92	-30	885.13
-160	368.57	-20	923.55
-150	409.87	-10	961.84
-140	450.83	0	1000.0
-130	491.47	10	1038.0
-120	531.83	20	1076.0
-110	571.92	30	1113.8
-100	611.76	40	1151.4
-90	651.38	50	1189.0
-80	690.78	60	1226.4
-70	729.99	70	1263.8
-60	769.02	80	1301.0
-50	807.87	90	1338.0
-40	846.58	100	1375.0

Wiring diagram

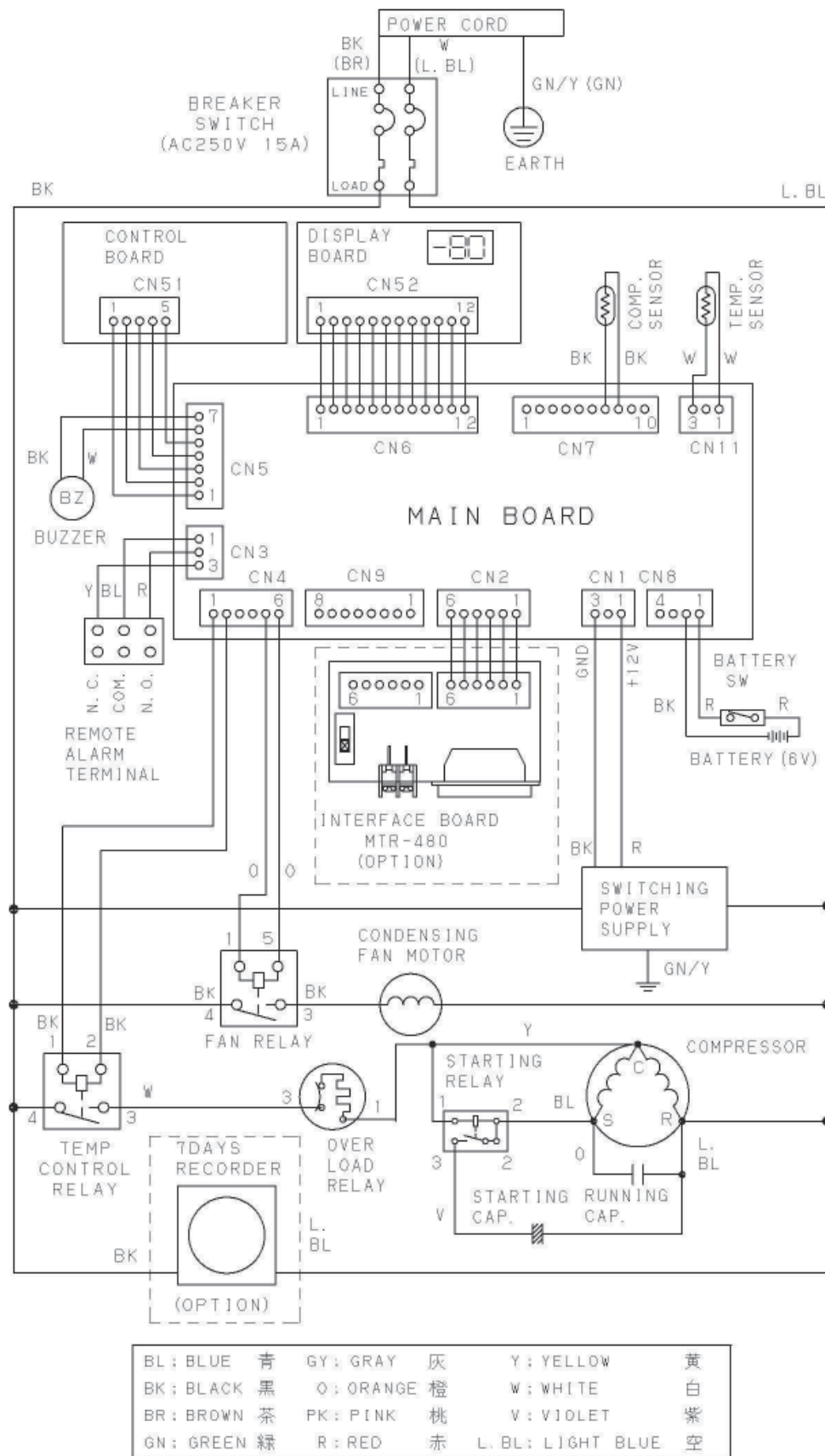

WIRING DIAGRAM

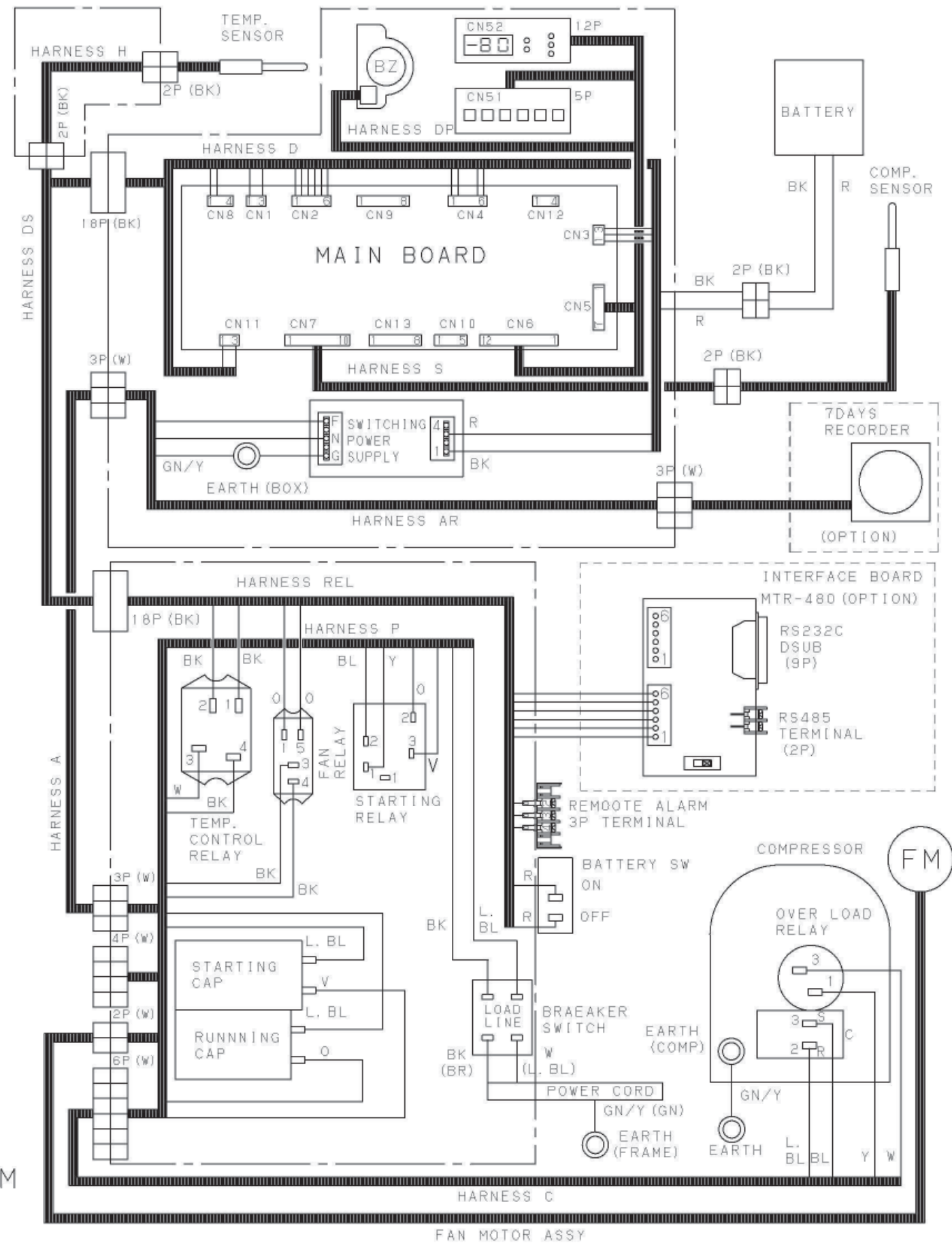

Circuit diagram

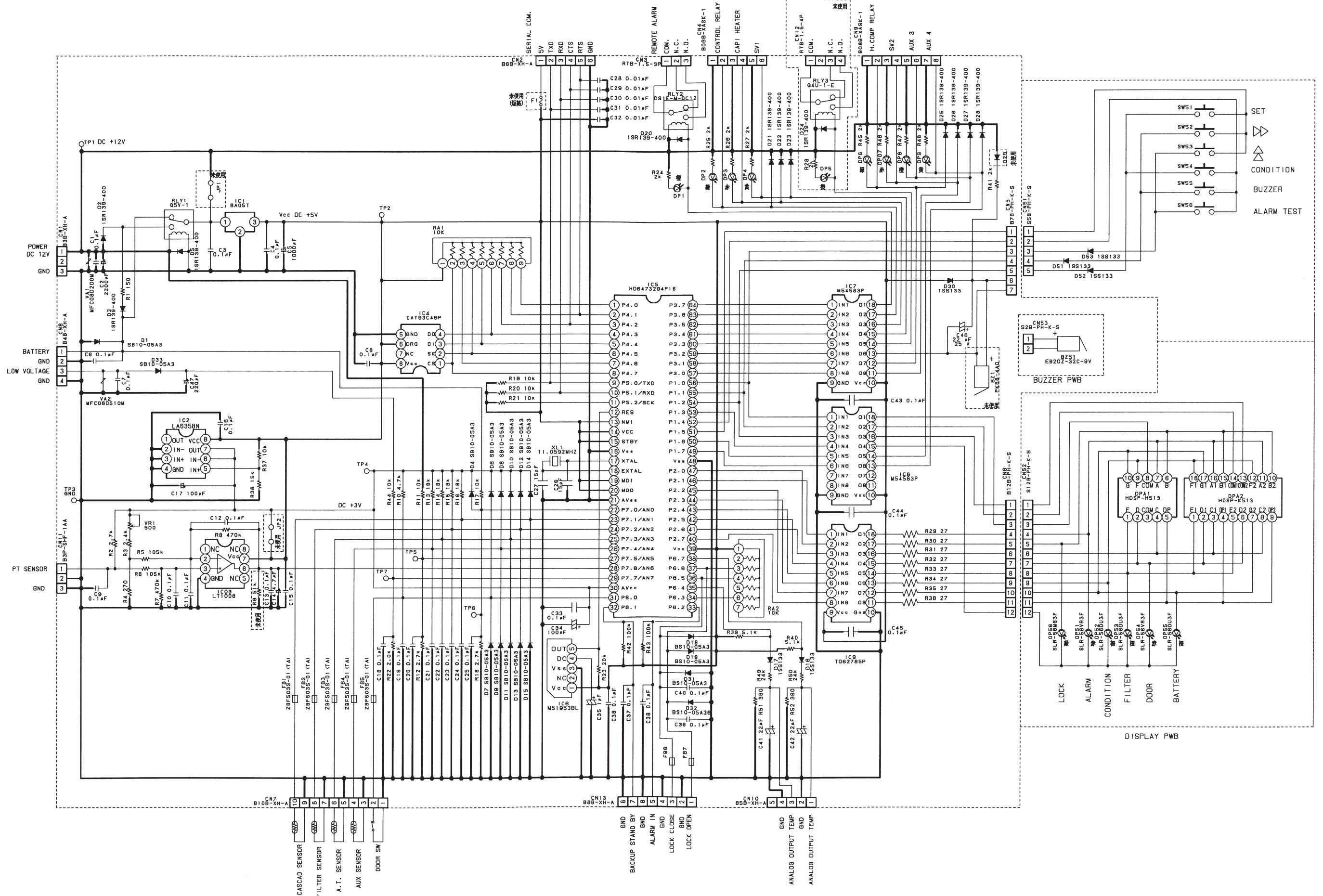



Connection on PCB

Following is the explanation of connections on Main PCB.



Connector	Connects to	Usage	Voltage
CN1	Switching power supply	To supply the power to PCB	#1:12V
CN2	MTR-480 (Option)	To connect with interface	
CN3	Remote alarm terminal #1: COM. #2: N.O. #3: N.C.	Output for remote alarm contact	
CN4	#1-#2: Temp. control relay #5-#6: Fan relay	To control chamber temperature To conduct current to cap. tube heater	#1-#2:12V #5-#6:12V
CN5	#1, #7: Buzzer #2-#6: Control PCB (CN51)	To control with each switches	
CN6	Display PCB (CN52)	To connect with each LED	
CN7	#7-#8: Comp. sensor	To control condensing fan motor by the temperature in comp. sensor	
CN8	#1-#2: Battery	To supply the power to Main PCB during power failure	#2:6V
CN9	Unused		
CN11	#1-#3: Temp. sensor	To detect chamber temperature	

Control specification

1. Key and Switch

- BUZZER** : In alarm condition, buzzer stops sounding with this key pressed. Remote alarm output and alarm message would not be off. During the power failure (battery back-up), press the key to show the present temperature of PT sensor.
- ALARM TEST** : With this key pressed to activate alarm test mode to be forcibly step into alarm condition (ALARM lamp blinks, intermittent buzzer beeps, digital LED goes off and remote alarm inputs). After approx. 90seconds then, normal condition retrieves with Auto Return activates. With the battery switch turns off, "E09" blinks on the display.
- SET** : Press this key once to activate set mode (2nd digit in LED blinks), press the key again to store the value to be changed. With Key Lock setting mode ("L 0" or "L 1" is displayed), press the key to store the value to be changed.
-  During setting mode, the blinking digit shifts among the 1st digit or the 2nd digit or 3rd digit.
-  During setting mode, count the blinking digit up. In PV display, press the key over 5 seconds to enter the function mode. ("F00" is displayed)

2. Temperature control

- Setting range** : -55°C~-85°C
- Display range** : -180°C~+50°C
- Setting procedure** : Press SET key and set the required value with  key and  key. Press SET key to store the set value.
- Out of setting range** : If you try to set the value which is out of temperature setting range, it is unacceptable with buzzer beeps for 1second.



3. Temperature alarm



- Setting range** : High temperature alarm ... +5°C~+20°C (Initial setting: 10°C)
Low temperature alarm -5°C~-20°C (initial setting: -10°C)
- Setting procedure** : Keep pressing  key over 5 seconds to enter function mode (F00). Input "F01" for high temperature alarm or "F02" for low temperature alarm. Press SET key to set the value to be changed with the 1st digit blinks. Press SET key again to store the value in the non-volatile memory.
- Out of setting range** : If you try to set the value which is out of alarm setting range, it is unacceptable with buzzer beeps for 1 second.

4. Key Lock mode and Function mode

A) Key Lock mode

Setting range : 0, 1

Setting procedure: In PV display, keep pressing  key over 5 seconds to enter into Key Lock mode. ("L_0" or "L_1" is displayed. initial: L_0) with "0" or "1" blinks. Change the value with  key and press SET key to store the value in the non-volatile memory.

- B) Function mode
 Setting range : 00~33
 Display range : 00~39
 00, 04, 08, 13, 15, 16, 18, 19, 20, 26, 27, 31 and 33 are unavailable.
 Setting procedure : In PV display, keep pressing  key over 5 seconds to enter function mode (F00 is displayed). Change the blinking 1st digit to desired function code with  key and  key. Press SET key to be function code available.
 If you press SET key after input digits among 00, 04, 08, 13, 15, 16, 18, 19, 20, 31 and 33, the display automatically reverts to PV.
 Out of setting range : If you try to input F34~F39, it is unacceptable to change with automatically revert to PV display.

5. Warning function



- High temp. alarm : When PV is higher than $SV+SV_H$ (high temp. alarm SV) +1, ALARM lamp and LED display blinks, intermittent buzzer beeps with approx. 15 minutes of delay, and remote alarm output turns on.
 When PV is lower than $SV+SV_H$, ALARM lamp and LED display go off, buzzer stops beeping, and remote alarm output turns off.
 If you press BUZZER key, the buzzer stops beeping instead remote alarm output does not turn off.
 Low temp. alarm : When PV is lower than $SV-SV_L$ (low temp. alarm SV) -1, ALARM lamp and LED display blinks, intermittent buzzer beeps with approx. 15 minutes of delay, and remote alarm output turns on.
 When PV is lower than $SV-SV_L$, ALARM lamp and LED display go off, buzzer stops beeping, and remote alarm output turns off.
 If you press BUZZER key, the buzzer stops beeping instead remote alarm output does not turn off.



6. Other function









- Auto Return : If there is not any key operation for 90 seconds in each setting mode, Key Lock mode and Function mode, the display automatically reverts to PV. **Note) Auto Return is not worked in F09 and F10.**
 Sensor temperature : F12: Temperature in temp. sensor is displayed
 (Ex. -80.2°C → displayed as '80.2')
 F14: Temperature of comp. sensor is displayed.
 (Ex. 67°C → displayed as '067')
 Battery accumulating time : F03: Battery accumulating time is displayed.
 (Ex. 2years and 6months consumed → displayed as '02.5')
 The display shows '02.8' to inform the battery exhaustion.
 Then replace with new battery.
 <Reset of accumulating time>
 Step into F06. Input '409' and press SET key to turn the display to '00.0' with BATTERY lamp goes off.
 ROM version : F30: ROM version is displayed (Ex. Ver. 1.00 → displayed as "1.00")
 Condensing fan motor accumulating time : F32: Notice for condensing fan motor accumulating time
 000: Not notify 001: Notify
 When you set in '001' and fan motor accumulating time is reached to 5.6 years, 'FAn' and PV are alternately displayed.
 <Reset of accumulating time>
 Step into F06. Input '410' and press SET key to clear non-volatile memory in '00.0'. The display reverts to PV only.









7. Function mode





F00	Automatically revert to PV display
F01	SV _H (high temp. alarm SV) setting
F02	SV _L (low temp. alarm SV) setting
F03	Battery accumulating time display
F04	Automatically revert to PV display
F05	Compressor delay time setting
F06	Service code input (code: 384)
F07 *	Temperature Zero Adjustment
F08 *	Automatically revert to PV display
F09 *	Factory test mode Unavailable
F10 *	Factory test mode Unavailable
F11 *	Factory test mode Unavailable
F12 *	Display of temperature of temp. sensor
F13 *	Automatically revert to PV display
F14 *	Display of temperature of Comp. sensor
F15 *	Automatically revert to PV display
F16 *	Automatically revert to PV display
F17 *	Model code setting (Initialization of non-volatile ROM and memory)
F18 *	Automatically revert to PV display
F19 *	Automatically revert to PV display
F20 *	Automatically revert to PV display
F21	Communication ID set
F22	Communication mode set
F23 *	Automatically revert to PV display
F24	Remote alarm terminal output
F25	Ring-back time set
F26 *	"000" is displayed...Unavailable
F27 *	"000" is displayed...Unavailable
F28 *	Display of delay time of permission for measuring running rate (2 hrs timer)
F29 *	Display of delay time of permission for measuring running rate (8 hrs timer)
F30 *	ROM version is displayed
F31 *	Automatically revert to PV display
F32 *	Notice for condensing fan motor accumulating time
F33 *	Automatically revert to PV display
F34~F39	Unused

Setting procedure: In PV display, keep pressing  key over 5seconds to display "F00".
 Input the desired function code with  key and  key.
 Press SET key to be function mode available.
 * ... You should input service code (384) in F06 beforehand.
To cancel service code, input "000" in F06 or turn the power off.

F00:	<Purpose>	Simply passing through if entered by mistake.
	<Operation>	Press SET key in "F00" displayed to revert to PV display.
F01:	<Purpose>	SV _H (high temp. alarm SV) setting
	<Operation>	Input F01 and press SET key to display "010" (initial value). Set the value in the range "005"~"020" with  key. Press SET key to store the value and revert to PV display.
F02:	<Purpose>	SV _L (low temp. alarm SV) setting
	<Operation>	Input F02 and press SET key to display "-10" (initial value). Set the value in the range "-05"~"-20" with  key. Press SET key to store the value and revert to PV display.
F03:	<Purpose>	Battery accumulating time is displayed
	<Operation>	Input F03 and press SET key to display alternately F03 with "00.0" (in case battery used for a month or less). Press SET key to revert to PV display.

- F04: <Purpose> Simply passing through if entered by mistake.
 <Operation> Press SET key in "F04" displayed to revert to PV display.
- F05: <Purpose> Compressor is turned on with forcibly delayed (by minute increment) when the power retrieves from the power failure.
 <Operation> Input "F05" and press SET key to display "002" (initial).
 Change the value in the range "002"~"015" with  key and  key.
 Press SET key to store the value and revert to PV display.
- F06: <Purpose> Dividing F-code for customer used from service
 <Operation> Input F06 and press SET key to display "000" (initial value).
 Set to "384" with  key and  key. Press SET key to store the value and revert to PV display.
 <Cancel> Input F06 and press SET key to display "384".
 Change to "000" with  key and  key. Press SET key to store the value and revert to PV display.
 Turn the power off then on to revert to "000". (not stored in non-volatile memory)
 Note) "384" is stored in non-volatile memory during battery back-up. (battery SW is ON)
- F07: <Purpose> To match temperature of temp. sensor with temperature of center at the chamber.
 <Operation> ~~Input service code in F06 prior to use this mode.~~
 Input F07 and press SET key to display "00.0" (initial value).
 Change to the desired value with  key and  key in the range of "-4.9"~"04.9".
 Press SET key to store the value and revert to PV display.
- F08: <Purpose> Simply passing through if entered by mistake.
 <Operation> Press SET key in "F08" displayed to revert to PV display.
 Buzzer tone is emitted if service code is not input in F06.
- F12: <Purpose> To display the temperature of temp. sensor
 <Operation> ~~Input service code in F06 prior to use this mode.~~
 Input F12 and press SET key to display alternately F12 and "XX.X" (present internal temperature). Press SET key to revert to PV display. 3 digits indication. Minus "-" is not indicated.
 Ex) "-85.5°C" → indicated as "85.5"
 "-79.5°C" → indicated as "-80"
- F13: <Purpose> Simply passing through if entered by mistake.
 <Operation> Press SET key in "F13" displayed to revert to PV display.
 Buzzer tone is emitted if service code is not input in F06.
- F14: <Purpose> To display the temperature of Comp. sensor
 <Operation> ~~Input service code in F06 prior to use this mode.~~
 Input F14 and press SET key to display alternately F14 and "XX.X" (present temperature of Comp. sensor). Press SET key to revert to PV display.
- F15: <Purpose> Simply passing through if entered by mistake.
 <Operation> Press SET key in "F15" displayed to revert to PV display.
 Buzzer tone is emitted if service code is not input in F06.

- F16: <Purpose> Simply passing through if entered by mistake.
 <Operation> Press SET key in "F16" displayed to revert to PV display.
 Buzzer tone is emitted if service code is not input in F06.
- F17: <Purpose> Non-volatile memory initialization, model code change
 <Operation> Service code should be input in F06 prior to use this mode.
 Input F17 and press SET key to display "001". Change the value
 with  key and  key. Press SET key to store and revert to PV
 display.
 Model code '003': MDF-C8V
- F18: <Purpose> Simply passing through if entered by mistake.
 <Operation> Press SET key in "F18" displayed to revert to PV display.
 Buzzer tone is emitted if service code is not input in F06.
- F19: <Purpose> Simply passing through if entered by mistake.
 <Operation> Press SET key in "F19" displayed to revert to PV display.
 Buzzer tone is emitted if service code is not input in F06.
- F20: <Purpose> Simply passing through if entered by mistake.
 <Operation> Press SET key in "F20" displayed to revert to PV display.
 Buzzer tone is emitted if service code is not input in F06.
- F21: <Purpose> Serial communication ID setting
 <Operation> Input F21 and press SET key to display "000" (initial).
 Change the value in the range "001"~"255" with  key and  key.
- F22: <Purpose> Serial communication mode setting
 <Operation> input F22 and press SET key to display "000" (initial value)
 Change the value with  key and  key.
 Press SET key to store the value and revert to PV display.
 Control mode (the 3rd digit)
 0: Local (initial)
 1: Remote
 Baud rate (the 2nd digit)
 0: 2400bps (initial)
 1: 4800bps
 2: 9600bps
 Note) You cannot be changed SV if control mode is set in "Remote".
- F23: <Purpose> Simply passing through if entered by mistake.
 <Operation> Press SET key in "F23" displayed to revert to PV display.
 Buzzer tone is emitted if service code is not input in F06.
- F24: <Purpose> To control remote alarm output
 <Operation> Input F24 and Press SET key to display "000" (initial).
 Change to the desired value with  key and  key.
 Press SET key to store the value and revert to PV display.
 000: Remote alarm is ON even if the buzzer stops beeping with BZ
 key pressed.
 001: Remote alarm is OFF when the buzzer stops beeping with BZ
 key pressed.

- F25: <Purpose> Alarm auto recovery time setting
 <Operation> Input F25 and press SET key to display "030" (initial).
 Change to the desired value with  key and  key.
 Press SET key to store the value and revert to PV display.
 000: Auto recovery OFF 040: Recovers after 40min. passed
 010: Recovers after 10min. passed 050: Recovers after 50min. passed
 020: Recovers after 20min. passed 060: Recovers after 60min. passed
 030: Recovers after 30min. passed
 (initial)
- F28: <Purpose> To display delay time of permission of measuring running rate
 (2hrs timer; 000~120 min)
 <Operation> Service code should be input in F06 prior to use this mode.
 Input F28 and press SET key to display F28 and 'xxx' (present count
 value) alternately. Press SET key to revert to PV.
- F29: <Purpose> To display delay time of permission of measuring running rate
 (8hrs timer; 000~480 min)
 <Operation> Service code should be input in F06 prior to use this mode.
 Input F29 and press SET key to display F29 and 'xxx' (present count
 value) alternately. Press SET key to revert to PV.
- F30: <Purpose> ROM version is displayed
 <Operation> Service code should be input in F06 prior to use this mode.
 Input F30 and press SET key to display alternately F30 with "X.XX"
 (present ROM version).
 Press SET key to revert to PV display.
- F31: <Purpose> Simply passing through if entered by mistake.
 <Operation> Press SET key in "F31" displayed to revert to PV display.
 Buzzer tone is emitted if service code is not input in F06.
- F32: <Purpose> To notify accumulation time of condensing fan motor
 <Operation> Service code should be input in F06 prior to use this mode.
 Input F32 and press SET key to display '000' (Initial setting).
 000: Not notify
 001: Notify
 Set your desired setting with  key and  key pressed.
 Press SET key to store the value and revert to PV display.
- F33: <Purpose> Simply passing through if entered by mistake.
 <Operation> Press SET key in "F33" displayed to revert to PV display.
 Buzzer tone is emitted if service code is not input in F06.
- F34~F39 Unused
 <Operation> Input F34~F39 and press SET key.

8. Differential (The point of compressor ON and OFF)

COMP ON: SV +0.4°C
 COMP OFF: SV -0.4°C

9. Offset value

PV+1.0°C is the offset value to adjust the difference between temperature of temp. sensor and the center of chamber.

10. Remote alarm terminal

In normal condition:	Remote alarm contact: N.O. N.C.
↓	↓
In alarm condition & power failure :	Remote alarm contact: N.C. N.O.

11. Sensor failure

(1) Temp. sensor

Open circuit: E01 and 50°C are displayed alternately, the buzzer beeps intermittently and remote alarm contact outputs.

The compressor would be allowed to turn on.

Press BUZZER key to stop the buzzer beeping.

Short circuit: E02 and -170°C>PV>-180°C are displayed alternately, the buzzer beeps intermittently and remote alarm contact outputs.

The compressor would be allowed to turn on.

Press BUZZER key to stop the buzzer beeping.

(2) Comp. sensor

Open circuited: E05 and PV are displayed alternately, the buzzer beeps intermittently and remote alarm contact outputs.

Press BUZZER key to stop the buzzer beeping.

Short circuited: E06 and PV are displayed alternately, the buzzer beeps intermittently and remote alarm contact outputs.

Press BUZZER key to stop the buzzer beeping.

(3) Compressor

abnormal temp.

E10 is displayed and compressor turns off when temperature in Comp. sensor is higher than 100°C. When temperature in Comp. sensor is lower than 65°C, compressor turns on.

(4) Error code priority

No.1: Temp. sensor failure (E01 or E02)

No.2: Comp. sensor failure (E05 or E06)

No.3: Compressor abnormal temperature (E10)

(5) Temperature to judge sensor failure

PT sensor: 49.9°C or higher (E01 displayed) ... Judge as 'Open circuited'
-170°C or lower (E02 displayed) ... Judge as 'Short circuited'

Comp. sensor: -60°C or lower (E05 displayed) ... Judge as 'Open circuited'
130°C or higher (E06 displayed) ... Judge as 'Short circuited'

12. When the power is supplied (without battery)

Compressor: In PV is higher than SV, compressor turns on with 2minutes (initial value) of delay after the power was supplied.

Condensing fan motor: With temperature in Comp. sensor is lower than 20°C, Fan motor would not activate even if the power is supplied. Fan motor starts rotating once the temperature in Comp. sensor is reached equal or higher than 80°C.

Setting data: The setting data initialized in F17 is retrieved in non-volatile memory.

13. Fan motor operation and compressor protection

Fan motor operation : 1. When the temperature in Comp. sensor is lower than 20°C;
Fan motor turns off with the power supplied → Turns on when the temperature in Comp. sensor is higher than 80°C → Turns off when the temperature in Comp. sensor is lower than 20°C → Turns on when the temperature in Comp. sensor is higher than 80°C
2. When the temperature in Comp. sensor is lower than 20°C;
Fan motor turns on with the power supplied → Turns off when the temperature in Comp. sensor is lower than 20°C → Turns on when the temperature in Comp. sensor is higher than 80°C

Compressor protection: Compressor stops operation when the temperature in Comp. sensor reaches 100°C. (Compressor protection)
(during Fan Lock) Starts operation again when the temperature in Comp. sensor is lower than 65°C.

15. Other specifications

(1) Lamp specifications:

<Control PCB>

DP1: Orange lamp
Goes off: High/low temp. alarm, sensor failure, power failure
Lit : Not in alert condition

DP2: Green lamp
Goes off: Compressor does not activate. (normal condition)
Lit : Compressor activates.

DP4: Yellow lamp
Goes off: Fan motor does not activate. (normal condition)
Lit : Fan motor activates.

<Display PCB>

DP51: Red lamp
Goes off: Not in alarm condition (normal condition)
Blinks : High/low temp. alarm (without delay), or sensor failure, or power failure

DP53: Orange lamp
Goes off: Battery accumulation time is less than 2.8yrs.
Lit : Battery accumulation time is over than 2.8yrs (Expired).
Blinks : In F11 performed

(3) Buzzer specifications:

High/low temp. alarm:	Intermittent tone emitted with delay
Sensor failure:	Intermittent tone emitted when any error code among E01, E02, E05 and E06 is displayed
Power failure:	Intermittent tone emitted
Key operation:	A click emitted if available
Invalid input:	Alarming tone emitted for 1 second

Parts layout

<Temp. sensor PT-1000>

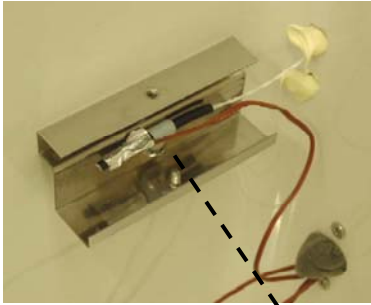

<Fan> Comp.sensor

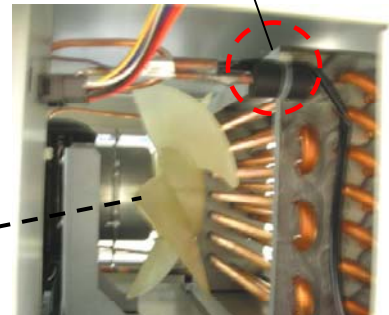

<Control panel>



<Battery>



Battery cover

<Back side of Control panel>

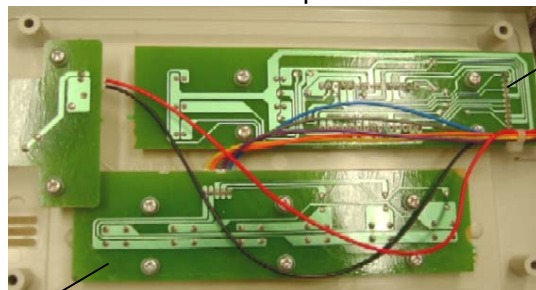

Display PCB

Control PCB

<How to access the Main PCB>

1. Catch the pick by screwdriver to pull the panel out.

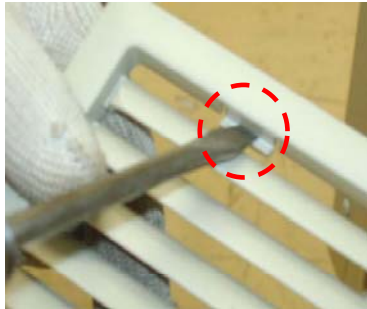

2. Loosen tie band to set cables free. Pull Electric BOX out carefully.

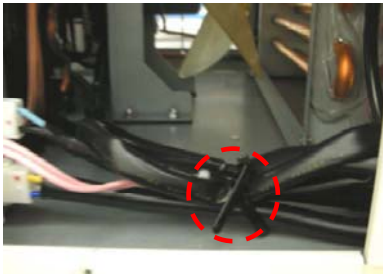

<Main PCB layout>



ROM

Switching power supply

<Lower back side>

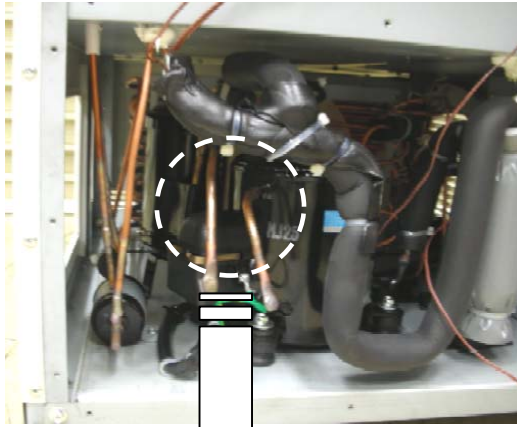

<Remote alarm>



Battery switch

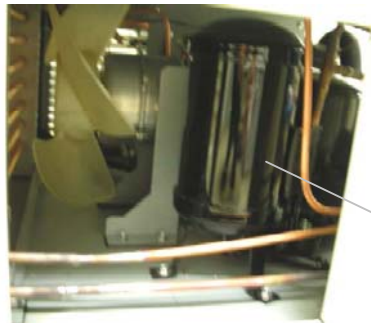

Ex.tank

Temp.control relay

Fan relay

Starting relay

Starting capacitor

Running capacitor

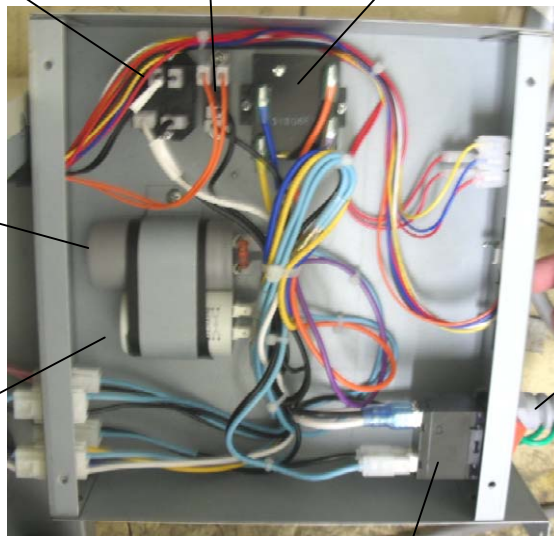

Power cord

Breaker switch

Test Data

Note: All data is the reference only.

Temperature characteristics (pull-down)
115V 60Hz AT30°C No load

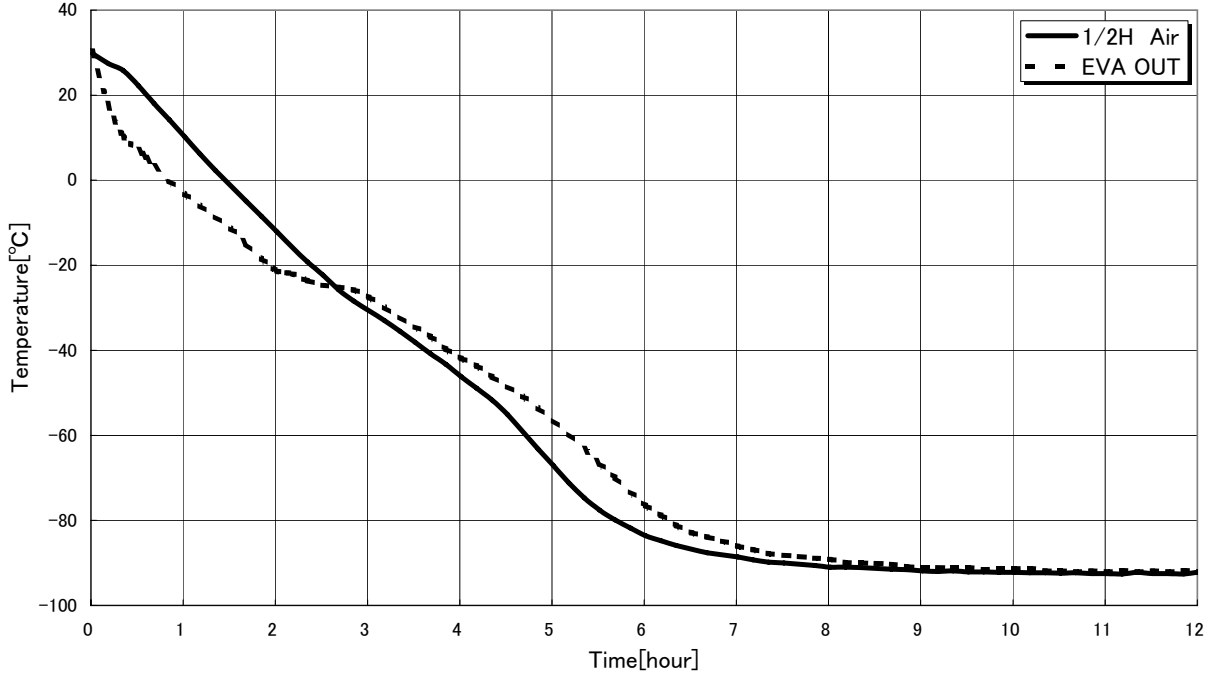

Temperature characteristics (pull-down)
230V 50Hz AT30°C No load

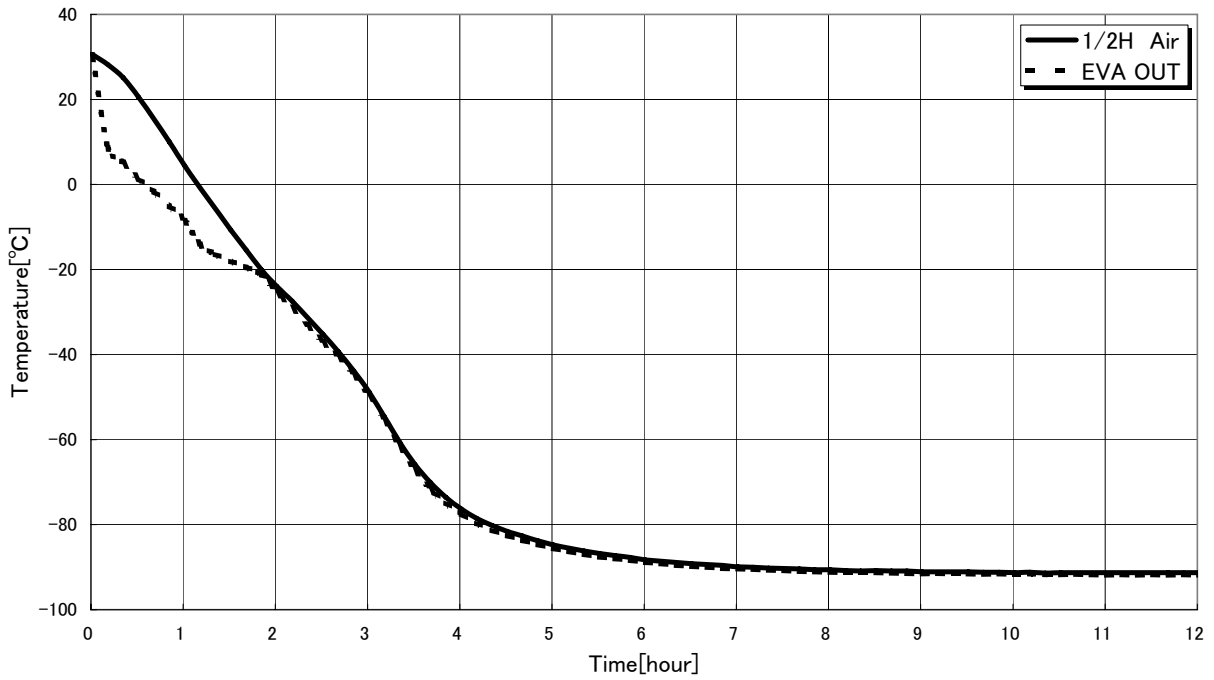

Temperature characteristics (pull-up) AT30°C No load

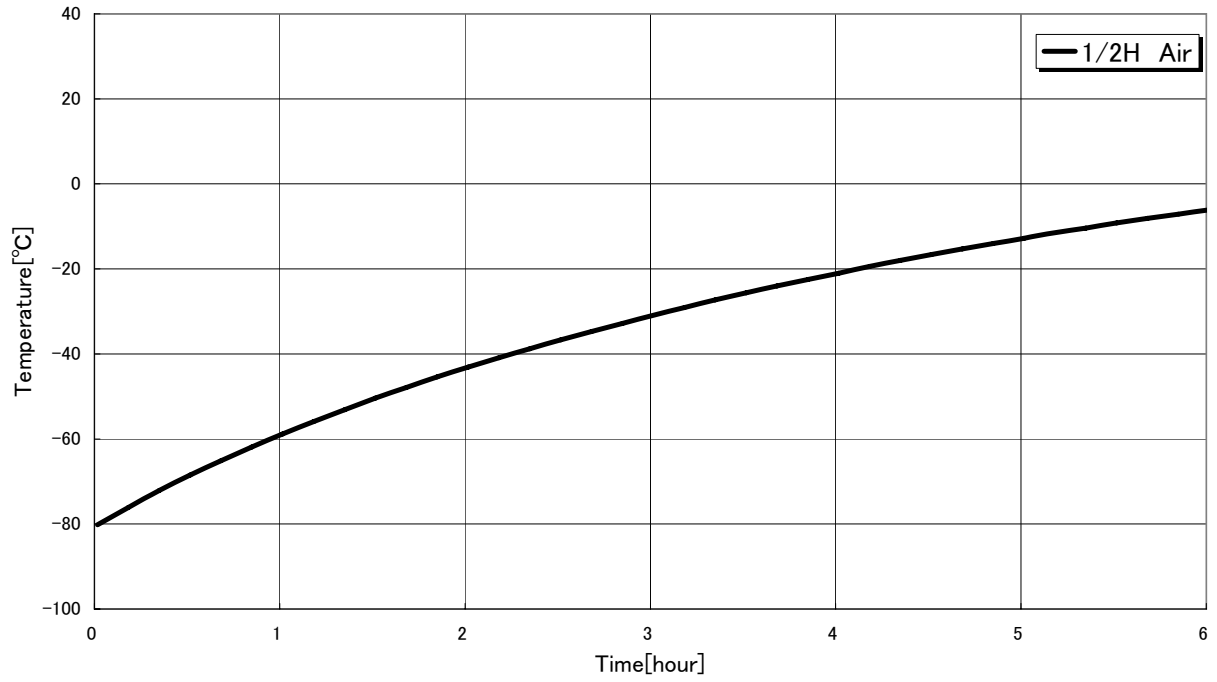

Unit Pressure (pull-down)
115V 60Hz AT35°C No load

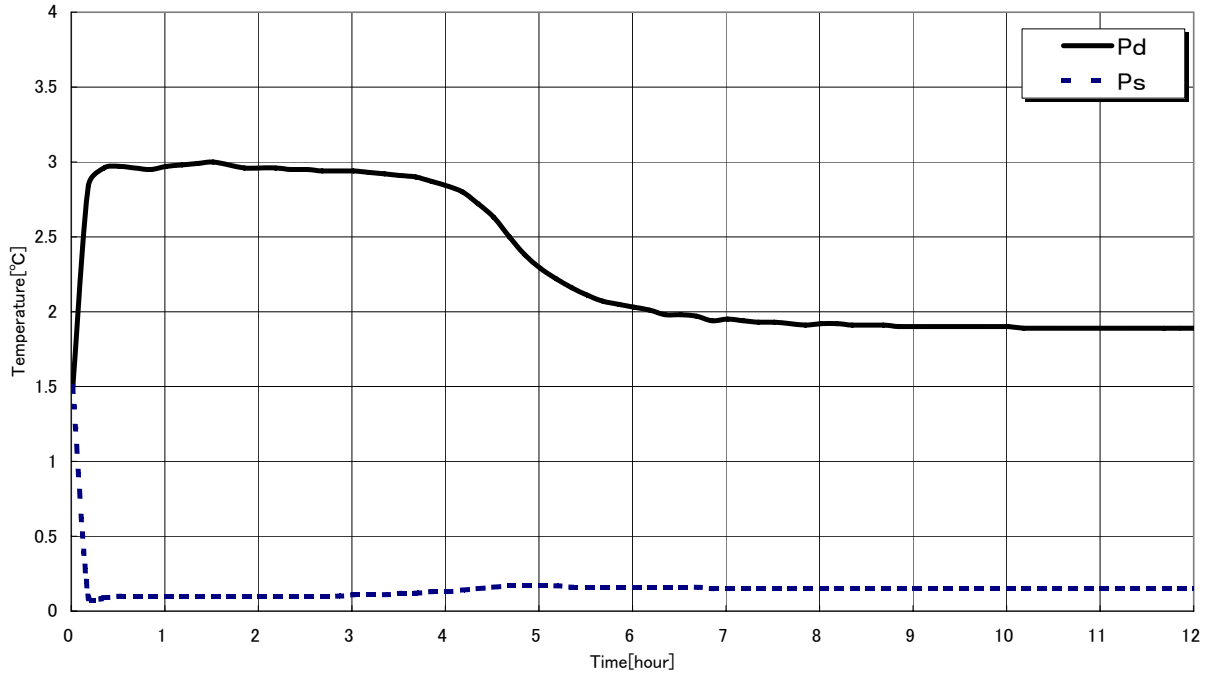

Unit Pressure (pull-down)
230V 50Hz AT35°C No load

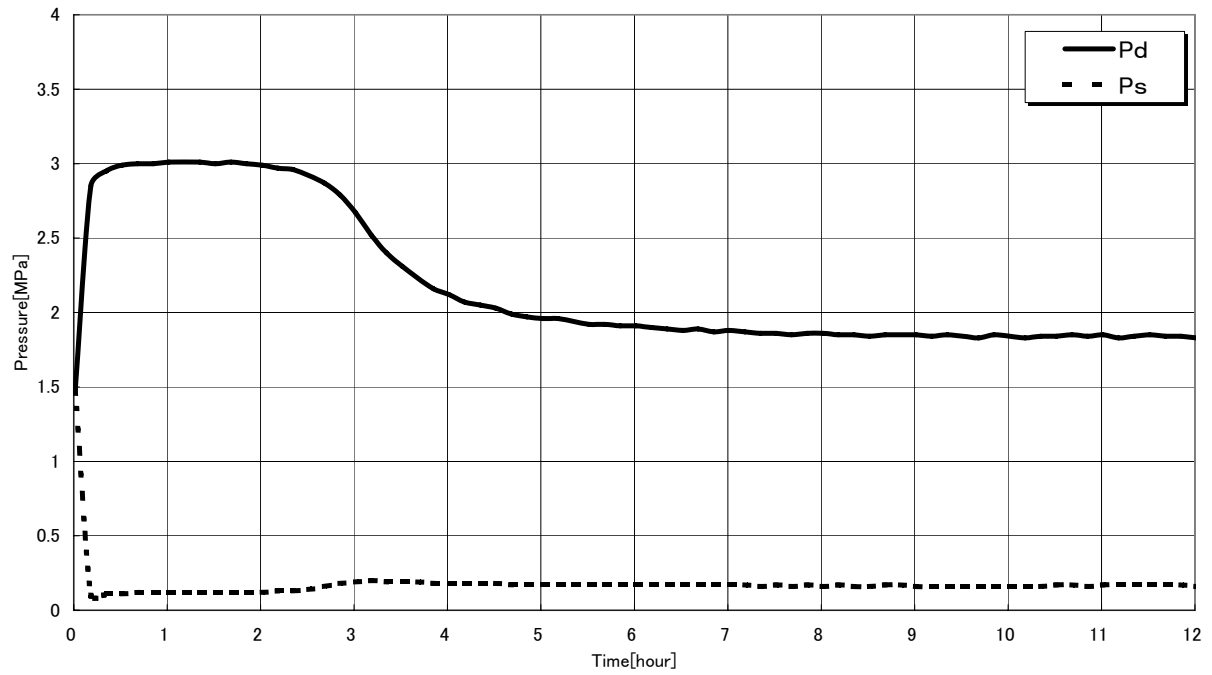

Power Consumption (pull-down)
115V 60Hz AT35°C No load

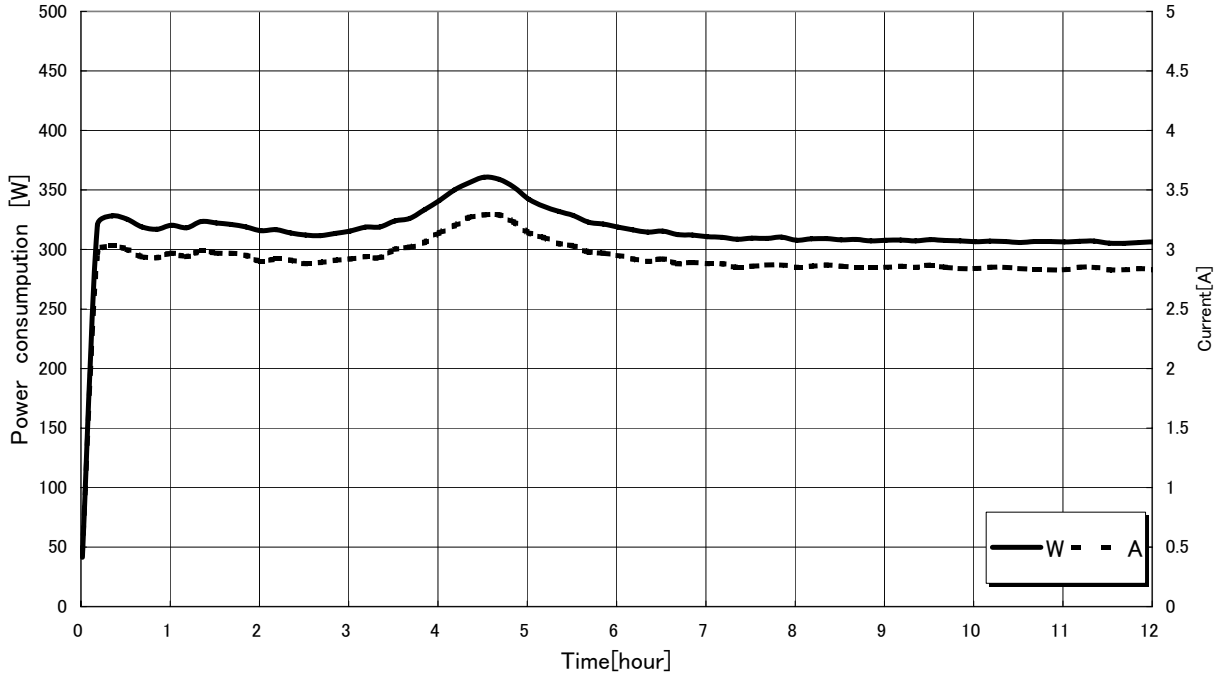

Power Consumption (pull-down)
230V 50Hz AT35°C No load

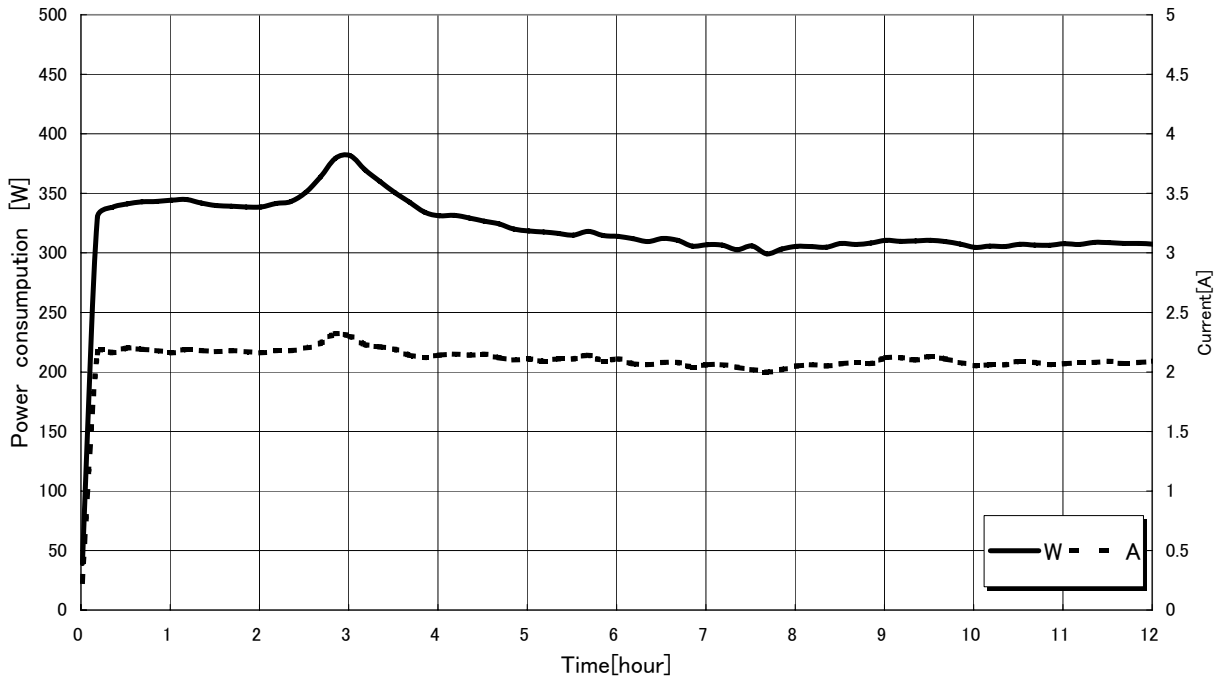

Collection and charge of refrigerant

1. Preparation

- * Refrigerant [MU-N48]
- * Connector for charging pipe (if necessary)



2. Procedures

- 1) Pull vacuum in refrigeration circuit
Pull vacuum by pump for approx. 5 minutes.

<NOTE>

It is important to pull vacuum in the circuit to avoid possibility causing fire by residual refrigerant (R-600).

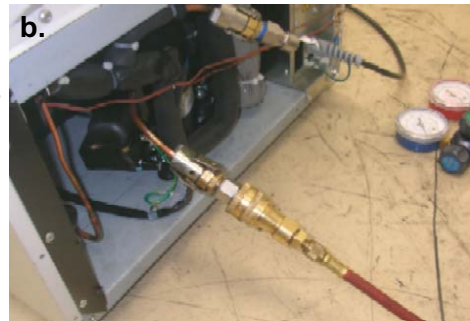

- 2) Connect charging pipe.
Measure weight of tank before charge. (See picture c.)
Connect tank with both vacuum pump and gauge manifold. (See picture d.)
It should be taken 3 hours at least to pull vacuum with 2 tanks.

Pump capacity: 300L/min.



- 3) Charge of refrigerant
 Stop vacuum pump operation.
 Open the valve of tank to charge refrigerant
 with approx. 0.2~0.5 Mpa/G.



- 4) Pipe pinching in High pressure side
 Charge refrigerant until pressure is
 reached to 1.6MPa/G.
 Close the valve of tank.
 Hold charging pipe by pliers to pinch it off
 by pinch pliers. (See picture f.)



Pinch pliers

- 5) Charge refrigerant in Low pressure side
 Open the valve again to charge refrigerant
 in Low pressure side.
 Charge until you can ensure pressure should
 be 0.1 Mpa/G with unit running.
 Turn the tank upside down to charge
 refrigerant without remains. (See picture-g.)



- 6) Pinching pipe
 Measure the weight of tank after charged.
 Form the pipe which was pinched off.

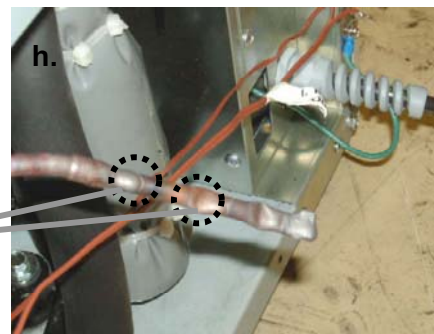

Apply welding to the points of
 pipe which were pinched to prevent
 being broken.

Instruction manual

- This section is extracted and printed from Instruction Manual.
- If you find out “Refer to page ●●” in them, this page means not page in service manual but page in the lower corner of each page in the extract from Instruction manual.
This page number is not corresponded with serial number in Service manual.

INSTRUCTION MANUAL

MDF-C8V

Ultra-Low Temperature Freezer



CONTENTS

INTRODUCTION	P. 2
PRECAUTIONS FOR SAFE OPERATION	P. 3
ENVIRONMENTAL CONDITIONS	P. 7
FREEZER COMPONENTS	P. 8
Control panel	P. 10
INSTALLATION SITE	P. 11
INSTALLATION	P. 12
START-UP OF UNIT	P. 13
CHAMBER TEMPERATURE SETTING	P. 14
KEY LOCK FUNCTION	P. 14
ALARM TEMPERATURE SETTING	P. 15
SETTING OF ALARM RESUME TIME	P. 17
CHANGE OF COMPRESSOR DELAY TIME	P. 18
REMOTE ALARM TERMINAL	P. 19
ALARMS & SAFETY FUNCTIONS	P. 20
ROUTINE MAINTENANCE	
Cleaning of cabinet	P. 21
Defrosting	P. 21
Battery	P. 22
REPLACEMENT OF BATTERY	P. 23
TROUBLESHOOTING	P. 24
DISPOSAL OF UNIT	P. 25
Recycle of battery	P. 25
TEMPERATURE RECORDER (OPTION)	P. 30
Installation of MTR-85H	P. 31
Installation of MTR-G85	P. 33
BACK-UP SYSTEM (OPTION)	P. 35
SPECIFICATIONS	P. 37
PERFORMANCE	P. 38
SAFETY CHECK SHEET	P. 39

INTRODUCTION

- Read this manual carefully before using the appliance and follow the instructions for safety operation.
- Sanyo never guarantee any safety if the appliance is used for any objects other than intended use or used by any procedures other than those mentioned in this manual.
- Keep this manual in an adequate place to refer to it as necessary.
- The contents of the manual will be subjected to change without notice due to the improvement of performance or functions.
- Contact Sanyo sales representative or agent if any page of the manual is lost or page order is incorrect.
- Contact Sanyo sales representative or agent if any point in this manual is unclear or if there are any inaccuracies.
- No part of this manual may be reproduced in any form without the expressed written permission of Sanyo.

PRECAUTIONS FOR SAFE OPERATION

It is imperative that the user complies with this manual as it contains important safety advice.

Items and procedures are described so that you can use this unit correctly and safely. If the precautions advised are followed, this will prevent possible injury to the user and any other person.

Precautions are illustrated in the following way:



WARNING

Failure to observe WARNING signs could result in a hazard to personnel possibly resulting in serious injury or death.

CAUTION

Failure to observe CAUTION signs could result in injury to personnel and damage to the unit and associated property.

Symbol shows;

-  this symbol means caution.
-  this symbol means an action is prohibited.
-  this symbol means an instruction must be followed.

Be sure to keep this manual in a place accessible to users of this unit.

< Label on the unit >



This mark is labeled on the cover in which the electrical components of high voltage are enclosed to prevent the electric shock.





The cover should be removed by a qualified engineer or a service personnel only.

WARNING

As with any equipment that uses CO₂ gas, there is a likelihood of oxygen depletion in the vicinity of the equipment. It is important that you assess the work site to ensure there is suitable and sufficient ventilation. If restricted ventilation is suspected, then other methods of ensuring a safe environment must be considered. These may include atmosphere monitoring and warning devices.













PRECAUTIONS FOR SAFE OPERATION

WARNING

-  **Do not use the unit outdoors.** Current leakage or electric shock may result if the unit is exposed to rain water.
-  **Only qualified engineers or service personnel should install the unit.** The installation by unqualified personnel may cause electric shock or fire.
-  **Install the unit on a sturdy floor and take an adequate precaution to prevent the unit from turning over.** If the floor is not strong enough or the installation site is not adequate, this may result in injury from the unit falling or tipping over.
-  **Never install the unit in a humid place or a place where it is likely to be splashed by water.** Deterioration of the insulation may result which could cause current leakage or electric shock.
-  **Never install the unit in a flammable or volatile location.** This may cause explosion or fire.
-  **Never install the unit where acid or corrosive gases are present** as current leakage or electric shock may result due to corrosion.
-  **Always ground (earth) the unit to prevent electric shock.** If the power supply outlet is not grounded, it will be necessary to install a ground by qualified engineers.
-  **Never ground the unit through a gas pipe, water main, telephone line or lightning rod.** Such grounding may cause electric shock in the case of an incomplete circuit.
-  **Connect the unit to a power source as indicated on the rating label attached to the unit.** Use of any other voltage or frequency other than that on the rating label may cause fire or electric shock.
-  **Never store volatile or flammable substances** in this unit if the container cannot be sealed. These may cause explosion or fire.
-  **Do not insert metal objects such as a pin or a wire into any vent, gap or any outlet on the unit.** This may cause electric shock or injury by accidental contact with moving parts.
-  **Use this unit in safe area when treating the poison, harmful or radiate articles.** Improper use may cause bad effect on your health or environment.
-  **Turn off the power switch (if provided) and disconnect the power supply to the unit prior to any repair or maintenance** of the unit in order to prevent electric shock or injury.
-  **Do not touch any electrical parts (such as power supply plug) or operate switches with a wet hand.** This may cause electric shock.







PRECAUTIONS FOR SAFE OPERATION

WARNING

-  **Ensure you do not inhale or consume medication or aerosols** from around the unit at the time of maintenance. These may be harmful to your health.
-  **Never splash water directly onto the unit** as this may cause electric shock or short circuit.
-  **Never put containers with liquid on the unit** as this may cause electric shock or short circuit when the liquid is spilled.
-  **Never bind, process, or step on the power supply cord, or never damage or break the power supply plug.** A broken supply cord or plug may cause fire or electric shock.
-  **Do not use the supply cord if its plug is loose.** Such supply cord may cause fire or electric shock.
-  **Never disassemble, repair, or modify the unit yourself.** Any such work carried out by an unauthorized person may result in fire, or electric shock or injury due to a malfunction.
-  **Disconnect the power supply plug if there is something wrong with the unit.** Continued abnormal operation may cause electric shock or fire.
-  **When removing the plug from the power supply outlet, grip the power supply plug, not the cord.** Pulling the cord may result in electric shock or fire by short circuit.
-  **Disconnect the power supply plug** before moving the unit. Take care not to damage the power cord. A damaged cord may cause electric shock or fire.
-  **Disconnect the power plug when the unit is not used for long periods.** Keeping the connection may cause electric shock, current leakage, or fire due to the deterioration of insulation.
-  If the unit is to be stored unused in an unsupervised area for an extended period, **ensure that children do not have access and that doors cannot be closed completely.**
-  **The disposal of the unit should be accomplished by appropriate personnel.** Remove doors to prevent accidents such as suffocation.
-  **Do not put the packing plastic bag within reach of children** as suffocation may result.

PRECAUTIONS FOR SAFE OPERATION

CAUTION

-  **Use a dedicated power source** (a dedicated circuit with a breaker) as indicated on the rating label attached to the unit. A branched circuit may cause fire resulting from abnormal heating.
-  **Connect the power supply plug to the power source firmly after removing the dust on the plug.** A dusty plug or improper insertion may cause a heat or ignition.
-  **Never store corrosive substances such as acid or alkali** in this unit if the container cannot be sealed. These may cause corrosion of inner components or electric parts.
-  **Check the setting when starting up of operation after power failure or turning off of power switch.** The stored items may be damaged due to the change of setting.
-  **Be careful not to tip over the unit** during movement to prevent damage or injury.
-  **Prepare a safety check sheet** when you request any repair or maintenance for the safety of service personnel.

ENVIRONMENTAL CONDITIONS

This equipment is designed to be safe at least under the following conditions (based on the IEC 1010-1):

- Indoor use;
- Altitude up to 2000 m;
- Ambient temperature 5°C to 40°C
- Maximum relative humidity 80% for temperature up to 31°C decreasing linearly to 50% relative humidity at 40°C;
- Mains supply voltage fluctuations not to exceed $\pm 10\%$ of the nominal voltage;
- Other supply voltage fluctuations as stated by the manufacturer;
- Transient overvoltages according to Installation Categories (Overvoltage Categories) II; For mains supply the minimum and normal category is II;
- Pollution degree 2 in accordance with IEC 664.

FREEZER COMPONENTS

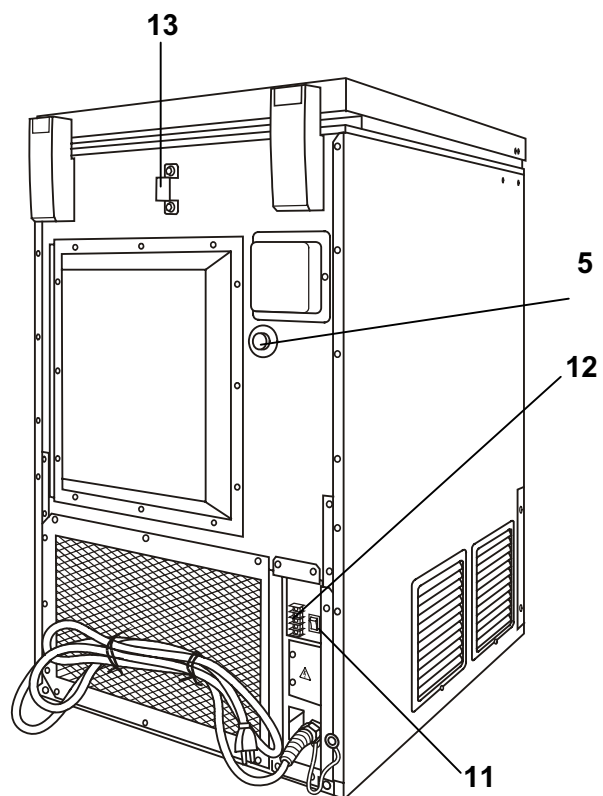
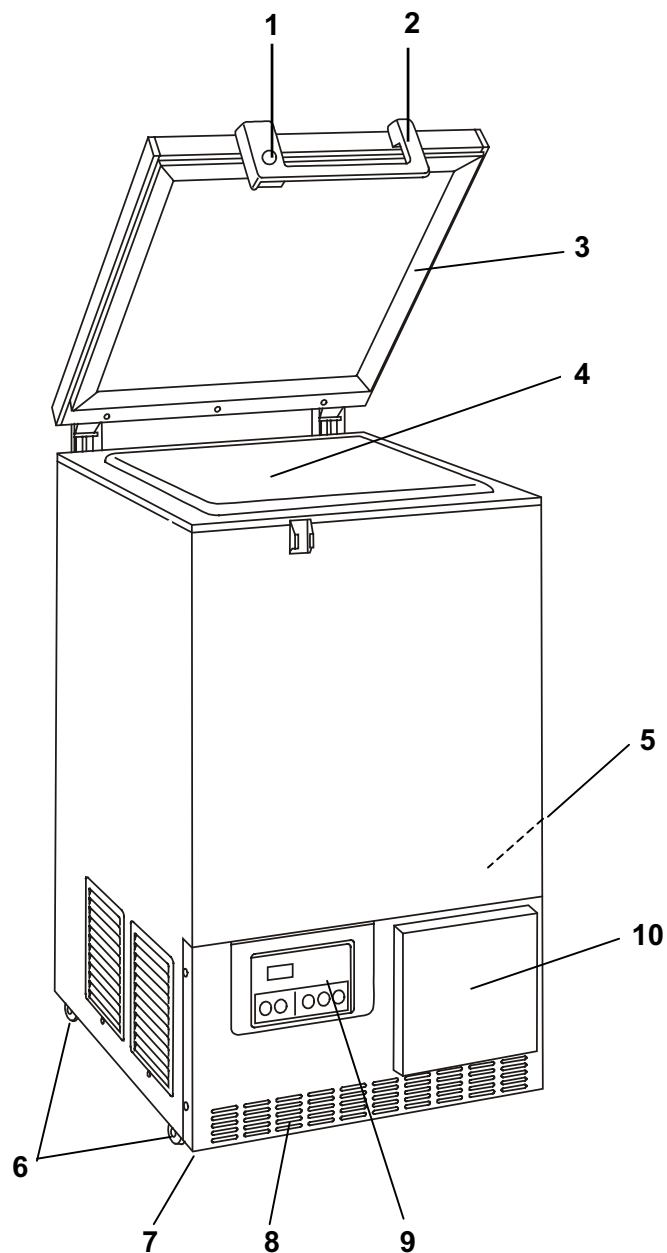

FREEZER COMPONENTS

- 1. Lock:** By turning to 180 degree to clockwise with a key, the door can be locked.
- 2. Door:** Top hinged type. To open the door, grip the handle.
- 3. Magnetic door gasket:** Seals the door and prevents leakage of cold air.
- 4. Inner lid:** Serves as a means of reducing cold air leakage when the door is open. Remove the frost regularly.
- 5. Access port:** Located on the back side and bottom. These are used for leading the measuring cable from the freezing chamber to the outside. The bottom port is also used for passing the temperature sensor.
- 6. Caster:** 4 casters are provided for easy movement.
- 7. Leveling foot:** Serves to adjust the height and to settle the frame evenly.
- 8. Intake air vent:** Be careful not to block this.
- 9. Control panel:** The temperature setting keys etc. are located. See page 10 for details.
- 10. Space for temperature recorder:** An automatic temperature recorder (optional part) can be attached here. See page 30 "Temperature recorder (option)".
- 11. Battery switch (back side):** Switch for battery used for power failure alarm. Always keep ON. Turn the switch OFF when the unit is in no use for a long period (more than 1 month).
- 12. Remote alarm terminal (back side):** Used to notify an alarm condition of the unit to remote location. See page 19 for details.
- 13. Fixture (back side):** A fixture is attached to the rear of the frame. Fix the frame to the wall with this fixture and rope or chain.

FREEZER COMPONENTS

Control panel

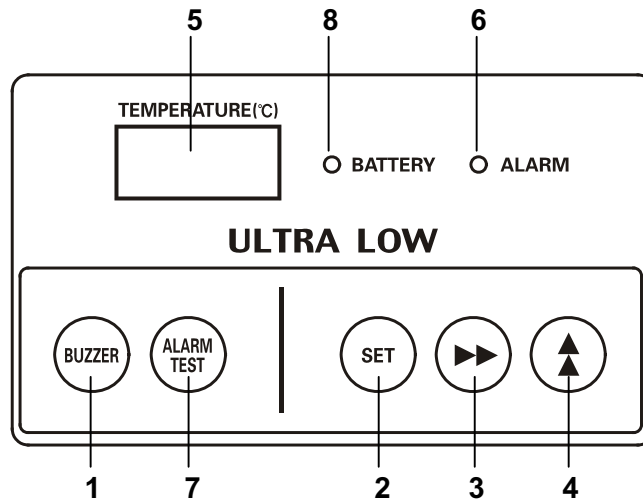

1. Alarm buzzer stop key (BUZZER): To silence the audible alarm, press this key. The alarm during the alarm test cannot be silenced by pressing this key. See page 17 “Setting of alarm resume time” for the details.

2. Set key (SET): Temperature setting mode is led by pressing this key and the changeable digit is flashed. By pressing this key again, the setting is memorized. The set mode returns to the temperature display mode automatically when 90 seconds has passed without any key operation. Refer to page 14 “Chamber temperature setting” for the details.

3. Digit shift key (▶▶): Pressing this key in the setting mode causes the changeable digit to shift. Key lock is available by pressing this key for more than 5 seconds in the temperature display mode. Refer to page 14 for the key lock.

4. Numerical value shift key (▲): Pressing this key in the setting mode causes the numerical value to shift. ON-OFF of key lock can be selected by pressing this key in the key lock mode. Pressing this key for more than 5 seconds in the temperature display mode causes the alarm temperature setting mode or alarm resume time setting mode. See page 15 “Alarm temperature setting” or page 17 “Setting of alarm resume time”.

5. Digital temperature indicator (TEMPERATURE): This indicator shows the present chamber temperature or set temperature.

6. Alarm lamp (ALARM): This lamp is flashed during alarm condition.

7. Alarm test key (ALARM TEST): To check the alarm system during freezer operation. Pressing this key with the battery switch ON gets the alarm lamp to flash, the remote alarm to operate, and the buzzer to sound.

8. Battery check lamp (BATTERY): This lamp lights to recommend the battery replacement. For the replacement, consult Sanyo sales representative or agent.

INSTALLATION SITE

To operate this unit properly and to obtain maximum performance, install the unit in a location with the following conditions:

■ **A location not subjected to direct sunlight**

Do not install the unit under direct sunlight. Installation in a location subjected to direct sunlight cannot obtain the intended performance.

■ **A location with adequate ventilation**

Leave at least 10 cm around the unit for ventilation. Poor ventilation will result in a reduction of the performance and consequently the failure.

■ **A location away from heat generating sources**

Avoid installing the unit near heat-emitting appliances such as a heater or a boiler etc. Heat can decrease the intended performance of the unit.

■ **A location with little temperature change**

Install the unit under stable ambient temperature. The allowable ambient temperature is between 5 and 30°C.

■ **A location with a sturdy and level floor**

Always install the unit on a sturdy and level floor. The uneven floor or tilted installation may cause failure or injury. Install the unit in stable condition to avoid the vibration or noise. Unstable condition may cause vibration or noise.

 **WARNING**

Install the unit on a sturdy floor. If the floor is not strong enough or the installation site is not adequate, this may result in injury from the unit falling or tipping over.

Select a level and sturdy floor for installation. This precaution will prevent the unit from tipping. Improper installation may result in water spillage or injury from the unit tipping over.

■ **A location not prone to high humidity**

Install the unit in the ambient of 80% R.H. or less humidity. Installation under high humidity may cause current leakage or electric shock.

 **WARNING**

Do not use the unit outdoors. Current leakage or electric shock may result if the unit is exposed to rain water.

Never install the unit in a humid place or a place where it is likely to be splashed by water. Deterioration of the insulation may result which could cause current leakage or electric shock.

■ **A location without flammable or corrosive gas**

Never install the unit in a flammable or volatile location. This may cause explosion or fire or may result in the current leakage or electric shock by the corrosion of the electrical components.

■ **A location without the possibility of anything fall**

Avoid installing the unit in the location where anything can fall down onto the unit. This may cause the breakdown or failure of the unit.

INSTALLATION

1. Removing the packaging materials and tapes

Remove all transportation packaging materials and tapes. Open the doors and ventilate the unit. If the outside panels are dirty, clean them with a diluted neutral dishwashing detergent. (Undiluted detergent can damage the plastic components. For the dilution, refer to the instruction of the detergent.) After the cleaning with the diluted detergent, always wipe it off with a wet cloth. Then wipe off the panels with a dry cloth.

2. Adjusting the leveling foot

Extend the leveling feet by rotating them counterclockwise to contact them to the floor. Ensure the unit is level and the casters are not in contact with the floor.

3. Fixing the unit

A fixture is attached to the rear of the frame. Fix the frame to the wall with this fixture and rope or chain.

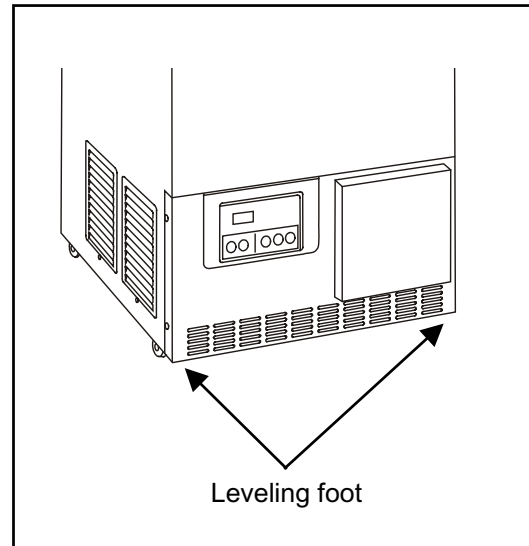

4. Ground (earth)

The ground (earth) is for preventing the electric shock in the case of the electrical insulation is somehow degraded. Always ground the unit at the time of installation.

⚠️ WARNING

Use a power supply outlet with ground (earth) to prevent electric shock. If the power supply outlet is not grounded, it is necessary to install a ground by qualified engineers.

Never ground the unit through a gas pipe, water main, telephone line or lightning rod. Such grounding may cause electric shock in the case of an incomplete circuit.

START-UP OF UNIT

Follow the procedures for the initial and consequent operations of the unit.

1. Connect the power cord to the dedicated outlet having appropriate rating with the chamber empty.
2. Turn off the power switch of the back-up system (optional component) if it is installed.
3. Check that the battery switch is ON.
4. Set the chamber temperature to the desired temperature.
5. Allow the chamber temperature to fall to the desired temperature. Check the chamber temperature on the temperature indicator.
6. Turn on the power switch of the back-up system (optional component) if it is installed.
7. Press the alarm test key (ALARM TEST) and check that the alarm lamp blinks and alarm buzzer activates.
8. After confirming the above, you can put articles into the freezer chamber in a small batch to prevent the temperature rise.

Operation after power failure

The settings (chamber temperature, alarm temperature) are memorized by nonvolatile memory during the power failure. Accordingly, the freezer resumes the operation with setting before power failure.



The condensing fan does not operate for more than 30 minutes after start-up.





The condensing fan may not operate during normal operation when the ambient temperature is lower than 20°C. This does not mean malfunction.

CHAMBER TEMPERATURE SETTING

Table 1 shows the basic procedure for setting the chamber temperature. Perform key operations in the sequence indicated in the table. The example in the table is based on the assumption that the desired temperature is -75°C.

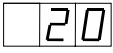
Note: The chamber temperature is set to -80°C at the factory.

Table 1 Basic operation sequence (Example: Chamber temperature -75°C)

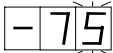
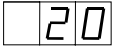
	Description of operation	Key operated	Indication after operation
1	Connect the power cord to the dedicated outlet.	----	The current chamber temperature is displayed. 
2	Press SET key.	SET	The second digit is flashed. 
3	Set to -75 with the numerical value shift key and digit shift key.		When pressed, the figure of settable digit changes.
			When pressed, the settable digit is shifted. 
4	Press SET key.	SET	Set temperature is memorized and the current chamber temperature is displayed. 

Note:







- The temperature set mode returns to the temperature display mode automatically when 90 seconds has passed without any key operation.
- Although the value of the chamber temperature setting can range from -55°C to -85°C, the guaranteed temperature range with no load is between -60°C and -80°C when the ambient temperature is 30°C.

KEY LOCK FUNCTION

This unit is provided with the key lock function. When the key lock is ON, change of temperature setting through the key pad is not available. The key lock is set to OFF at the factory.

Display	Mode	Function
L 0	Key lock is OFF	Enable to change of temperature setting
L 1	Key lock is ON	Disable to change of temperature setting

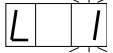
Table 2. Procedure for key lock setting (change from key lock OFF to key lock ON)

	Description of operation	Key operated	Indication after operation
1		----	The current chamber temperature is displayed. 
2	Press digit shift key for 5 seconds.		The first digit is flashed. 
3	Press numerical value shift key and scroll the figure to 1.		When pressed, the figure of settable digit changes. 
4	Press SET key.	SET	The key lock is set to ON. The current chamber temperature is displayed. 

ALARM TEMPERATURE SETTING

This unit is provided with the high and low temperature alarm and the temperature at which the alarm is activated is changeable.

The following procedure shows the setting of alarm temperature according to the condition below:

High temperature alarm: activates at the temperature 5°C higher than the chamber set temperature

Low temperature alarm: activates at the temperature 5°C lower than the chamber set temperature

Note:

The alarm temperature is set at the factory 10°C higher and lower than the chamber set temperature.









The available range of high/low temperature alarm is between 5°C and 20°C higher/lower than the chamber set temperature.

Table 3 Procedure for setting high temperature alarm

	Description of operation	Key operated	Indication after operation
1	-----	----	The current chamber temperature is displayed.
2	Press numerical value shift key for 5 seconds.		The first digit is flashed.
3	Press numerical value shift key and scroll the figure to 1.		When pressed, the figure of settable digit increases.
4	Press set key.	SET	The right digit is flashed.
5	Set the temperature to 005 with the digit shift key and numerical value shift key.		Pressing the key shifts the digit which can be set.
			When pressed, the figure of settable digit increases.
6	Press set key.	SET	Alarm temperature is memorized and the current chamber temperature is displayed.

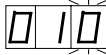
ALARM TEMPERATURE SETTING

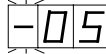
Table 4 Procedure for setting low temperature alarm

	Description of operation	Key operated	Indication after operation
1	-----	----	The current chamber temperature is displayed. 
2	Press numerical value shift key for 5 seconds.		The right digit is flashed. 
3	Press numerical value shift key and scroll the figure to 2.		When pressed, the figure of settable digit increases. 
4	Press set key.	SET	The right digit is flashed. 
5	Set the temperature to -05 with the digit key and numerical value shift key.		Pressing the key shifts the digit which can be set.
			When pressed, the figure of settable digit increases. 
6	Press set key.	SET	Alarm temperature is memorized and the current chamber temperature is displayed. 

SETTING OF ALARM RESUME TIME

The alarm buzzer is silenced by pressing alarm buzzer stop key (BUZZER) key on the control panel during alarm condition (The remote alarm is not silenced). The buzzer will be activated again after certain suspension if the alarm condition is continued. The suspension time can be set by following the procedure shown in the Table 5 below.

The example in the table is based on the assumption that the desired duration is 20 minutes.

Note: The duration is set in 30 minutes at the factory.

Table 5 Setting procedure for alarm resuming time (change from 30 minutes to 20 minutes)

	Description of operation	Key operated	Indication after operation
1	-----	----	The current chamber temperature is displayed.
2	Press numerical value shift key for 5 seconds.		The first digit is flashed.
3	Set the figure to F25 with the digit shift key and numerical value shift key.		Pressing the key shifts the digit which can be set.
			When pressed, the figure of settable digit increases.
4	Press set key.	SET	The current setting is displayed. The middle digit is flashed.
5	Set the figure to 020 with the numerical value shift key.		When pressed, the figure of settable digit increases.
6	Press set key.	SET	Alarm resume time is memorized and the current chamber temperature is displayed.

- The settable alarm resume time is 10, 20, 30, 40, 50, or 60 minutes (The setting is 010, 020, 030, 040, 050, or 060). The buzzer would not reset if the reset time is set in 000.
- It is recommended to set the alarm resume time when the freezer is not under alarm condition. The new setting is effective on the next alarm condition.
- The setting cannot be changed during power failure.
- The remote alarm during power failure or buzzer and remote alarm during alarm test cannot be silenced.
- The setting mode returns to the temperature display mode automatically when 90 seconds has passed without any key operation. In this case, any setting before pressing the set key (SET) is not memorized.

CHANGE OF COMPRESSOR DELAY TIME

The delay time of the compressor can be changed to reduce the load on the power line and to facilitate the start-up (reset) of the freezer after power failure.

The example in the table is based on the assumption that the delay time is changed to 4 minutes. The delay time is set in 2 minutes at the factory.

Note:

■ The setting range for delay time is between 2 and 15 minutes. The cool down of chamber temperature may be slow when the setting of delay time is over 5 minutes, depending on the installation environment. There is no need of changing the delay time when the capacity of power source is adequate.

Table 6. Changing procedure for delay time (change from 2 minutes to 4 minutes)

	Description of operation	Key operated	Indication after operation
1		----	The current chamber temperature is displayed.
2	Press numerical value shift key for 5 seconds.		The first digit is flashed.
3	Set the figure to F05 with the numerical value shift key.		When pressed, the figure of settable digit changes.
4	Press set key.	SET	The current delay time is displayed. The first digit is flashed.
5	Set the figure to 004 with the numerical value shift key.		When pressed, the figure of the first digit changes.
6	Press set key.	SET	The delay time is memorized and the current chamber temperature is displayed.

■ The compressor starts to run with the delay time when the power cord is connected to the outlet or after power failure.

REMOTE ALARM TERMINAL

WARNING

Always disconnect the power supply cord before connecting an alarm device to the remote alarm terminal.

The terminal of the remote alarm is installed at the back of the unit. The alarm is generated from this terminal. The contact capacity is DC 30 V, 2 A.

Contact output:

	Between COM and N.O.	Between COM and N.C.
At normal condition	"Open"	"Close"
At abnormal condition	"Close"	"Open"

Note:

The alarm device is activated when the power cord is disconnected because such condition is determined as power failure.

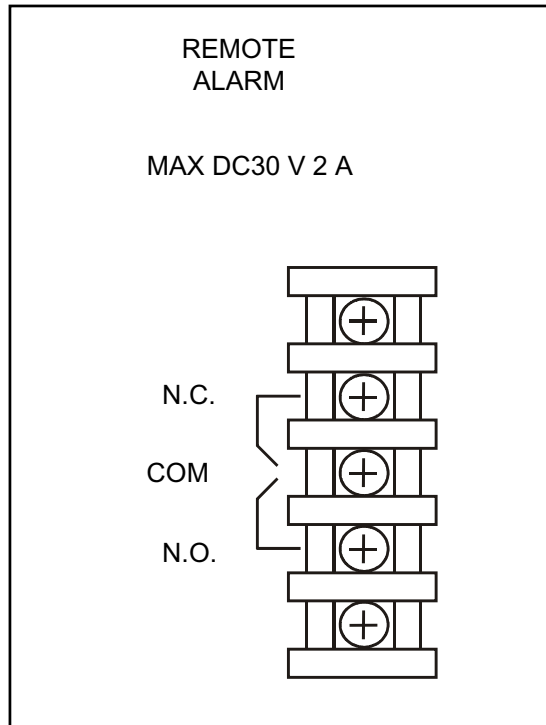

ALARMS & SAFETY FUNCTIONS

This unit has the alarms and safety functions shown in Table 7, and also self diagnostic functions.

Table 7 Alarms and safety functions

Alarm & Safety	Situation	Indication	Buzzer	Safety operation
High temperature alarm	If the chamber temperature is higher than the temperature at which the high temperature alarm is activated.	Alarm lamp is flashed. Temperature indicator is flashed.	Intermittent tone with 15 minutes delay.	Remote alarm with 15 minutes delay.
Low temperature alarm	If the chamber temperature is lower than the temperature at which the low temperature alarm is activated.	Alarm lamp is flashed. Temperature indicator is flashed.	Intermittent tone with 15 minutes delay.	Remote alarm with 15 minutes delay.
Power failure alarm	In the case of power failure. When the power cord is disconnected.	Alarm lamp is flashed.	Intermittent tone	Remote alarm.
Battery check	When approx. 2.8 years has passed with the power cord connected to the outlet.	Battery check lamp lights.	-----	-----
Sensor abnormality	If the thermal sensor is disconnected..	Alarm lamp is flashed. E01 and chamber temp. are displayed alternately.	Intermittent tone	Remote alarm.
	If the thermal sensor is short-circuited	Alarm lamp is flashed. E02 and chamber temp. are displayed alternately.		
	If the thermal sensor of the compressor is disconnected.	Alarm lamp is flashed. E05 and chamber temp. are displayed alternately.	Intermittent tone	Remote alarm.
	If the thermal sensor of the compressor is short-circuited	Alarm lamp is flashed. E06 and chamber temp. are displayed alternately.		
Battery switch check	When battery switch is OFF at the time of alarm test.	Alarm lamp is flashed. E09 is flashed.	-----	-----
Condenser temp. abnormality	In the event of failure of fan motor for cooling the compressor.	Alarm lamp is flashed. E10 and chamber temp. are displayed alternately.	Intermittent tone	Remote alarm. Compressor of high stage side stops.

Note:

- After power failure, the operation is resumed with the condition before power failure.
- The chamber temperature is displayed for 5 seconds if the alarm buzzer stop key (BUZZER) is depressed during the power failure alarm. After that, the alarm buzzer stops. The alarm lamp (ALARM) keeps blinking.
- In the case of sensor abnormality (E01 or E02 is displayed), the freezer continues to run.

ROUTINE MAINTENANCE

WARNING

Always disconnect the power supply to the unit prior to any repair or maintenance of the unit in order to prevent electric shock or injury.

Ensure you do not inhale or consume medication or aerosols from around the unit at the time of maintenance. These may be harmful to your health.

Cleaning of cabinet

- Clean the unit once a month. Regular cleaning keeps the unit looking new.
- Use a dry cloth to wipe off small amounts of dirt on the outside and inside of the unit and all accessories. If the outside panels are dirty, clean them with a diluted neutral dishwashing detergent. (Undiluted detergent can damage the plastic components. For the dilution, refer to the instruction of the detergent.) After the cleaning with the diluted detergent, always wipe it off with a wet cloth. Then wipe off the cabinet or accessories with a dry cloth.
- Never pour water onto or into the unit. Doing so can damage the electric insulation and cause failure.
- The compressor and other mechanical parts are completely sealed. This unit requires absolutely no lubrication.
- Remove the frost on the inner lid once a month.
- Press the back-up test switch once a month to check the back-up system operation when the back-up system is installed.

Defrosting

The frost is built on the inside wall of the chamber and inner lid. The excessive frost possibly makes some gap between the cabinet and door gasket, which may cause poor cooling. Remove the frost with a scraper enclosed with the unit. Following shows the procedure for removing the heavy frost.

Note: For removing the frost, do not use a tool with sharp edge such as a knife or a screw driver.

1. Move all the contents in the chamber to another low temperature freezer or a tank refrigerated with liquid N₂ or CO₂ gas (or dry ice).
2. Turn off the remote alarm switch and back-up switch (when installed).
3. Disconnect the power cord from the dedicated outlet.
4. Open the freezer door and remove the inner lid. Keep the freezer as it is until the frost is removed completely.
5. Wipe out the water that has left in the chamber.
6. Start-up the freezer by following the procedure on page 13 "Start-up the unit".
7. Once the chamber temperature has dropped to the desired temperature, place the original contents back in the freezer chamber.

ROUTINE MAINTENANCE

Battery

The battery for power failure alarm is an article for consumption. The battery life is approximately 3 years. The buzzer can not be activated at the power failure and the stored items may be influenced if the battery is left as it is for more than 3 years. It is recommended that the battery is replaced ahead of time.

For the replacement of the battery, contact Sanyo sales representative or agent.

REPLACEMENT OF BATTERY

Location of a nickel-metal-hydride battery

This unit is provided a nickel-metal-hydride battery for the power failure warning device. The battery is located at the back of the control panel. (Fig. 1)



The high voltage components are enclosed in the electrical box. The cover should be removed by a qualified engineer or a service personnel only to prevent the electric shock..

Removal of nickel-metal-hydride battery

1. Turn off the power switch and disconnect the power supply plug.
2. As shown in the Fig. 2, remove 1 screws fixing the side cover with a screw driver and remove the side cover.
3. Disconnect the battery connector. (Fig. 3)
4. Remove 4 screws fixing the battery cover. (Fig. 4)
5. Take out the battery.
6. Follow the procedure for recycling or proper disposal.

Handling of battery

Cover the battery terminal with an insulating tape to avoid the short circuit. Then follow the procedure for recycling or proper disposal.

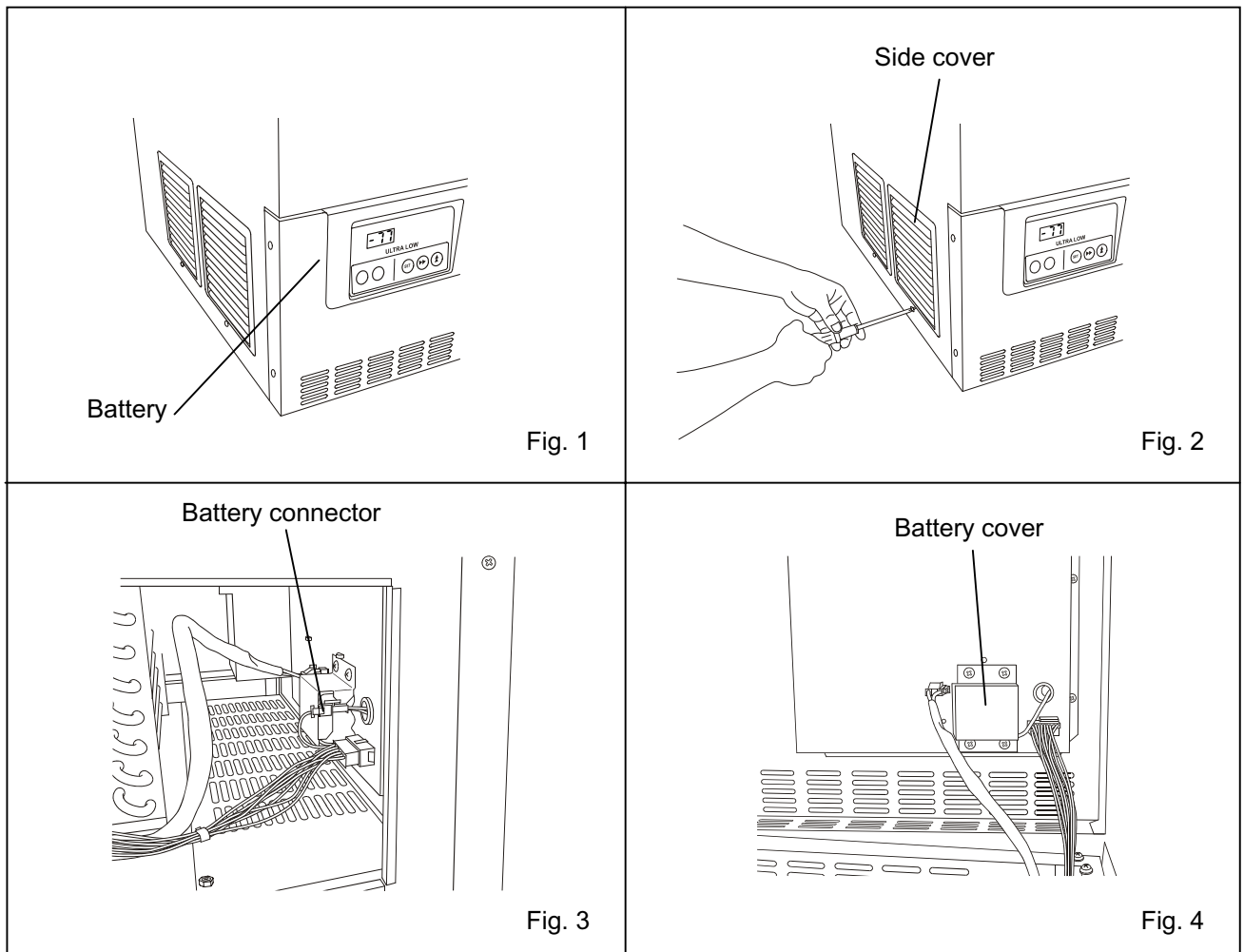

TROUBLESHOOTING

If the unit malfunctions, check out the following before calling for service.

Malfunction	Check/Remedy
The freezer does not run	<ul style="list-style-type: none"> ■ The power cord is not connected to the proper outlet. ■ The power source does not have enough capacity. ■ The power failure is occurred. ■ The circuit breaker of power source is active. ■ The fuse is blown. <p>Note: Move the freezer contents to another freezer if the chamber temperature raise due to the freezer failure.</p>
The alarm device is active	<p><at the start-up></p> <ul style="list-style-type: none"> ■ The chamber temperature deviates from the set temperature. <p><during use></p> <ul style="list-style-type: none"> ■ The set temperature was changed. ■ The door was kept opened for long period. ■ The high temperature load was stored in the chamber. <p>In above cases, the alarm is stopped automatically after certain time.</p>
The cooling is poor	<ul style="list-style-type: none"> ■ You put too many articles of high temperature in the chamber. ■ Too much frost is in the chamber. ■ The door is opened/closed frequently. ■ The set temperature is not appropriate. ■ The freezer is in the direct sunlight. ■ The freezer is not installed properly.
There is condensation outside the freezer	<ul style="list-style-type: none"> ■ The condensation can be found outside the freezer depending on the installation site, or under muggy environment. The condensation is caused by the humidity not by freezer failure. <p>Wipe off the condensation with a dry cloth.</p>
Noise	<ul style="list-style-type: none"> ■ The freezer is not installed on the sturdy floor. ■ The freezer is not leveled with the leveling feet. ■ There is anything touching the frame. ■ The freezer is in the status immediately after start up. <p>The unit sometimes causes a noise when the chamber temperature is high due to the large load. The noise gets less and less accompanying with the cooling of the chamber.</p>

Note:

If the malfunction is not eliminated after checking the above items, or the malfunction is not shown in the above table, contact Sanyo sales representative or agent.

CAUTION

The noise of refrigerant flow may be heard due to the characteristic of refrigerating circuit. Especially for several hours after start-up, the noise of motor compressor or refrigerant flow can be larger. But such noise does not mean malfunction nor failure.

DISPOSAL OF UNIT

WARNING

If the unit is to be stored unused in an unsupervised area for an extended period **ensure that children do not have access and doors cannot be closed completely.**

The disposal of the unit should be accomplished by appropriate personnel. Always remove doors to prevent accidents such as suffocation.

Recycle of battery



The unit contains a rechargeable battery. The battery is recyclable. At the end of its useful life, check with your local solid waste officials for an option or proper disposal.



* Label indication is obliged to comply with Taiwanese battery regulation.

DISPOSAL OF UNIT

Note:

This symbol mark and recycle system are applied only to EU countries and not applied to the countries in the other area of the world.

Waste Electrical and Electronic Equipment (WEEE) Directive-2002/96/EC

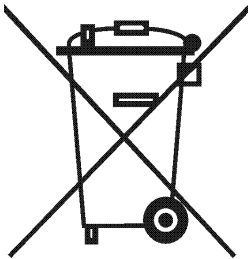

(English)

Your SANYO product is designed and manufactured with high quality materials and components which can be recycled and reused.

This symbol means that electrical and electronic equipment, at their end-of-life, should be disposed of separately from your household waste.

Please dispose of this equipment at your local community waste collection/recycling centre.

In the European Union there are separate collection systems for used electrical and electronic products.

Please help us to conserve the environment we live in!

(German)

Ihr SANYO Produkt wurde entworfen und hergestellt mit qualitativ hochwertigen Materialien und Komponenten, die recycelt und wiederverwendet werden können.

Dieses Symbol bedeutet, daß elektrische und elektronische Geräte am Ende ihrer Nutzungsdauer von Hausmüll getrennt entsorgt werden sollen.

Bitte entsorgen Sie dieses Gerät bei Ihrer örtlichen kommunalen Sammelstelle oder im Recycling Centre.

In der Europäischen Union gibt es unterschiedliche Sammelsysteme für Elektrik- und Elektronikgeräte.

Helfen Sie uns bitte, die Umwelt zu erhalten, in der wir leben!

DISPOSAL OF UNIT

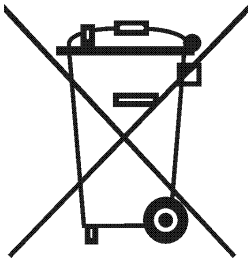

(French)

Votre produit Sanyo est conçu et fabriqué avec des matériaux et des composants de qualité supérieure qui peuvent être recyclés et réutilisés.

Ce symbole signifie que les équipements électriques et électroniques en fin de vie doivent être éliminés séparément des ordures ménagères.

Nous vous prions donc de confier cet équipement à votre centre local de collecte/recyclage.

Dans l'Union Européenne, il existe des systèmes sélectifs de collecte pour les produits électriques et électroniques usagés.

Aidez-nous à conserver l'environnement dans lequel nous vivons !

Les machines ou appareils électriques et électroniques contiennent fréquemment des matières qui, si elles sont traitées ou éliminées de manière inappropriée, peuvent s'avérer potentiellement dangereuses pour la santé humaine et pour l'environnement.

Cependant, ces matières sont nécessaires au bon fonctionnement de votre appareil ou de votre machine. Pour cette raison, il vous est demandé de ne pas vous débarrasser de votre appareil ou machine usagé avec vos ordures ménagères.

(Spanish)

Los productos SANYO están diseñados y fabricados con materiales y componentes de alta calidad, que pueden ser reciclados y reutilizados.

Este símbolo significa que el equipo eléctrico y electrónico, al final de su ciclo de vida, no se debe desechar con el resto de residuos domésticos.

Por favor, deposite su viejo "televisor" en el punto de recogida de residuos o contacte con su administración local.

En la Unión Europea existen sistemas de recogida específicos para residuos de aparatos eléctricos y electrónicos.

Por favor, ayúdenos a conservar el medio ambiente!

DISPOSAL OF UNIT

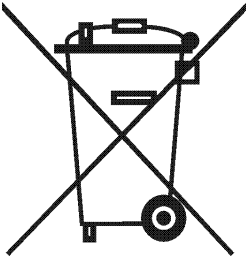

(Portuguese)

O seu produto SANYO foi concebido e produzido com materiais e componentes de alta qualidade que podem ser reciclados e reutilizados.

Este símbolo significa que o equipamento eléctrico e electrónico no final da sua vida útil deverá ser descartado separadamente do seu lixo doméstico.

Por favor, entregue este equipamento no seu ponto local de recolha/reciclagem.

Na União Europeia existem sistemas de recolha separados para produtos eléctricos e electrónicos usados.

Por favor, ajude-nos a conservar o ambiente em que vivemos!

(Italian)

Il vostro prodotto SANYO è stato costruito da materiali e componenti di alta qualità, che sono riutilizzabili o riciclabili.

Prodotti elettrici ed elettronici portando questo simbolo alla fine dell'uso devono essere smaltiti separatamente dai rifiuti casalinghi.

Vi preghiamo di smaltire questo apparecchio al deposito comunale.

Nell'Unione Europea esistono sistemi di raccolta differenziata per prodotti elettrici ed elettronici.

Aiutateci a conservare l'ambiente in cui viviamo!

DISPOSAL OF UNIT

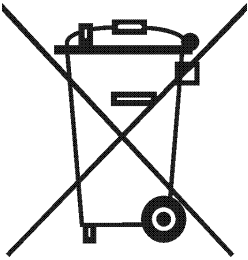

(Dutch)

Sanyo producten zijn ontwikkeld en gefabriceerd uit eerste kwaliteit materialen, de onderdelen kunnen worden gerecycled en weer worden gebruikt.

Het symbool betekent dat de elektrische en elektronische onderdelen wanneer deze vernietigd gaan worden, dit separaat gebeurt van het normale huisafval.

Zorg ervoor dat het verwijderen van de apparatuur bij de lokaal erkende instanties gaat gebeuren. In de Europese Unie wordt de gebruikte elektrische en elektronische apparatuur bij de daarvoor wettelijke instanties aangeboden.

Alstublieft help allen mee om het milieu te beschermen.

(Swedish)

Din SANYO produkt är designad och tillverkad av material och komponenter med hög kvalitet som kan återvinnas och återanvändas.

Denna symbol betyder att elektriska och elektroniska produkter, efter slutanvändande, skall sorteras och lämnas separat från Ditt hushållsavfall.

Vänligen, lämna denna produkt hos Din lokala mottagningstation för avfall/återvinningsstation.

Inom den Europeiska Unionen finns det separata återvinningssystem för begagnade elektriska och elektroniska produkter.

Vänligen, hjälp oss att bevara miljön vi lever i!

TEMPERATURE RECORDER (OPTION)

WARNING

Always disconnect the power supply to the unit prior to attachment of a temperature recorder in order to prevent electric shock or injury.

An automatic temperature recorder is available for the freezer as the optional component. The type of the recorder is MTR-85H or MTR-G85. For the attachment, optional component is necessary as follows.

Temperature recorder	Mounting kit	Recorder sensor cover
MTR-85H	MDF-S3085	MTR-C8
MTR-G85	-----	MTR-C8

For the installation of the temperature recorder, contact Sanyo sales representative or agency.

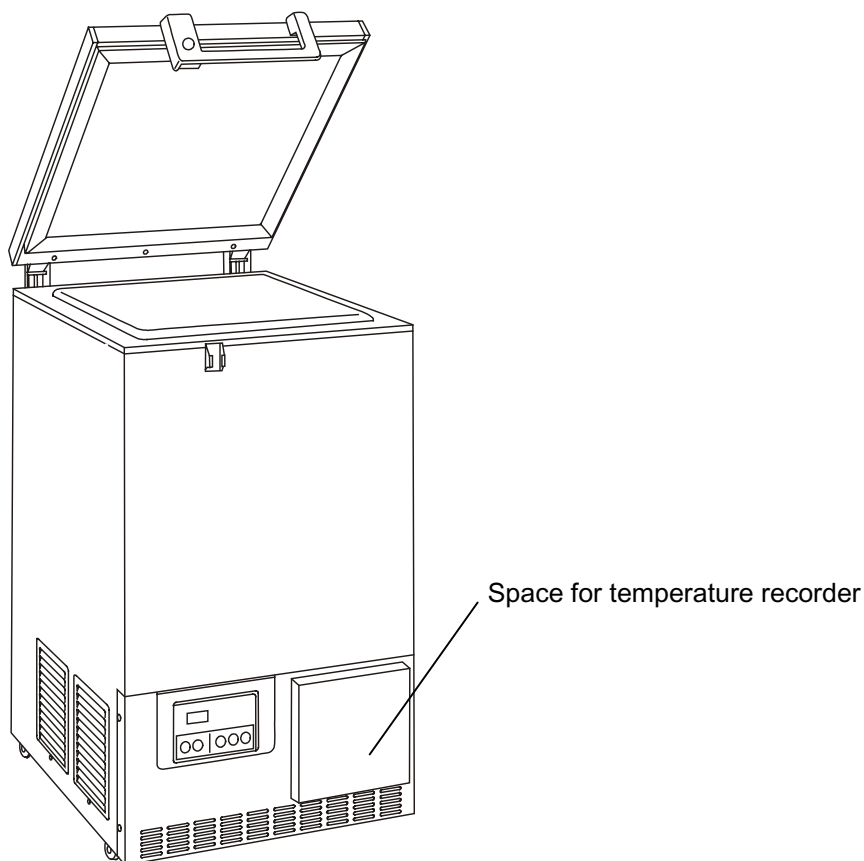

TEMPERATURE RECORDER (OPTION)

Installation of MTR-85H

1. Remove 4 screws (A, B, C, D) on the side of the front panel to take off the front panel. Then remove 4 screws on the cover for the recorder mounting space and take off the cover (Fig. 1). After removing the cover, replace 4 screws.

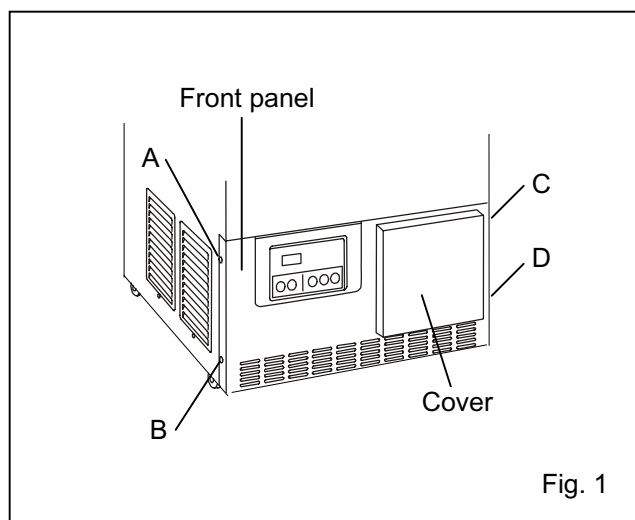

2. As shown in Fig. 2, install the recorder to the front panel by using the fixture enclosed with the recorder and the mounting plate (MDF-S3085).

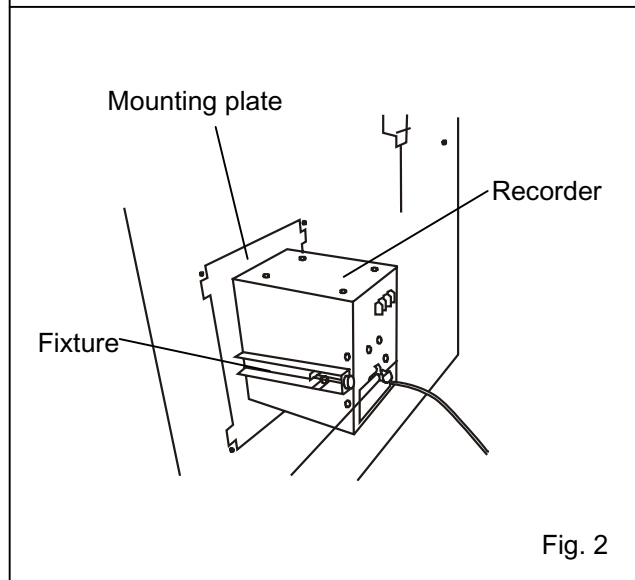

3. Lead the recorder sensor to the chamber through the access port at the bottom of the chamber.

Note:

The port is covered with a thermal insulation and rubber cap. Remove those covers before passing the recorder sensor.

4. Fix the recorder sensor to the inside of the sensor cover (MTR-C8) by using the enclosed clips and screws and seal the access port on the chamber side with a silicon. (Fig. 3)

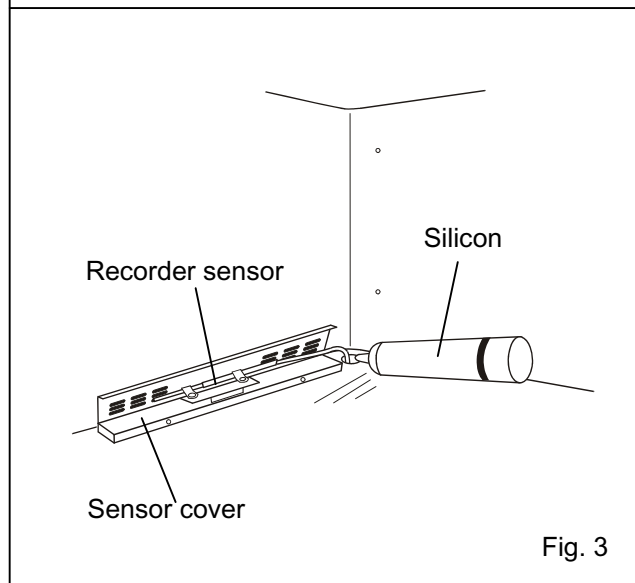

TEMPERATURE RECORDER (OPTION)

6. Attach the sensor cover to the right side of the chamber with 2 screws on the chamber wall (Fig. 4)

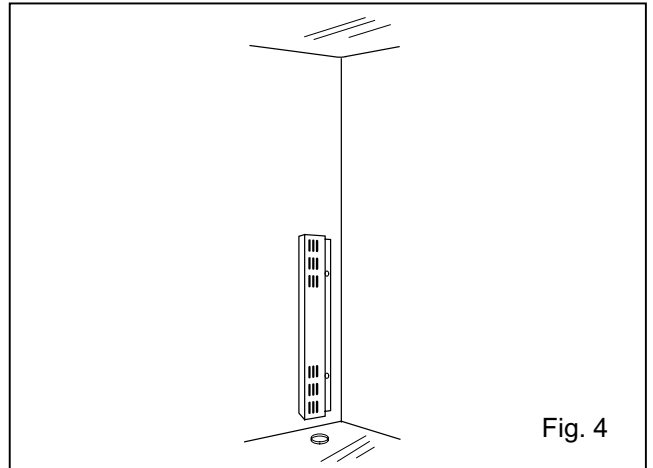

Fig. 4

7. Seal the access port on the outside with putty as shown in Fig. 5.

8. Replace the front panel and fix it with 4 screws.

9. Operate the freezer until the chamber temperature gets to the set temperature. Check the recorded temperature and chamber temperature displayed on the control panel. Adjust the zero adjustment volume on the temperature recorder so that the recorded temperature can corresponds with the displayed temperature if they are not compliance each other. Refer to the instruction manual enclosed with the recorder.

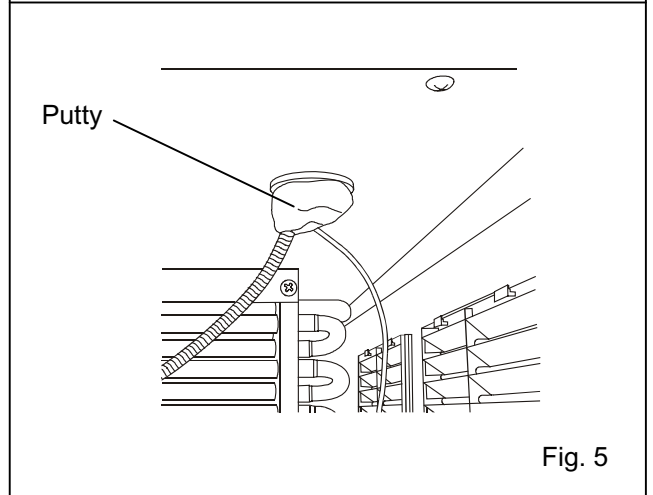

Fig. 5

TEMPERATURE RECORDER (OPTION)

Installation of MTR-G85

1. Remove 4 screws (A, B, C, D) on the side of the front panel to take off the front panel. Then remove 4 screws on the cover for the recorder mounting space and take off the cover (Fig. 1).

2. Fix the temperature recorder to the front panel with fixture and screws enclosed with the recorder.

Note :

Before fixing the temperature recorder, connect the recorder connector with the connector on the right back side of the control panel (Fig. 2)

3. Lead the recorder sensor to the chamber through the access port at the bottom of the chamber.

Note:

The port is covered with a thermal insulation and rubber cap. Remove those covers before passing the recorder sensor.

4. Fix the recorder sensor to the inside of the sensor cover (MTR-C8) by using the enclosed clips and screws and seal the access port on the chamber side with a silicon. (Fig. 3)

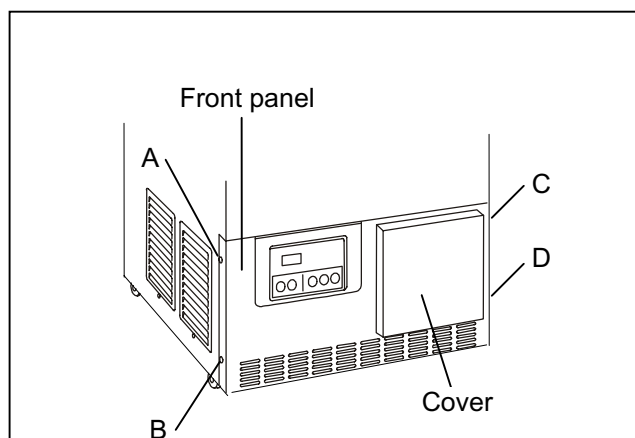

Fig. 1

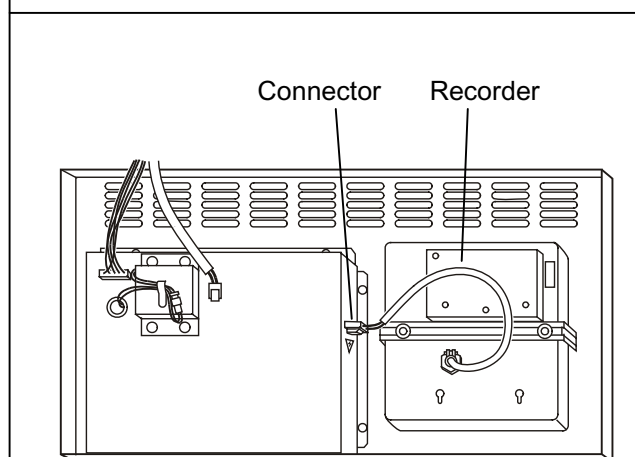

Fig. 2

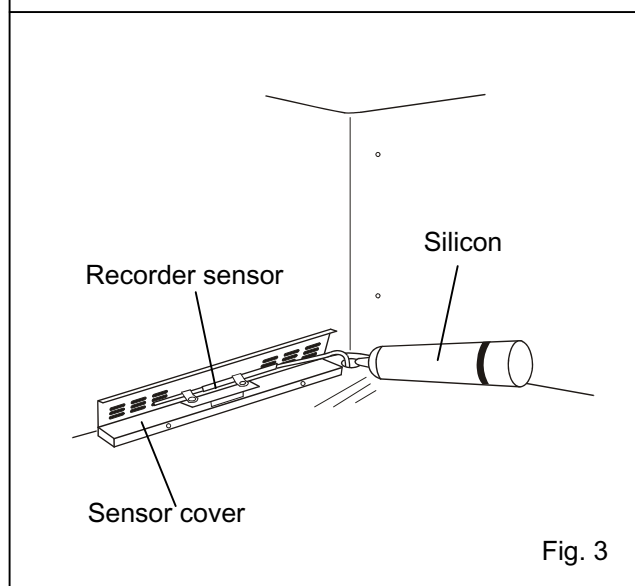

Fig. 3

TEMPERATURE RECORDER (OPTION)

6. Attach the sensor cover to the right side of the chamber with 2 screws on the chamber wall (Fig. 4)

7. Seal the access port on the outside with putty as shown in Fig. 5.

9. Replace the front panel and fix it with 4 screws.

10. Operate the freezer until the chamber temperature gets to the set temperature. Check the recorded temperature and chamber temperature displayed on the control panel. Adjust the zero adjustment volume on the temperature recorder so that the recorded temperature can corresponds with the displayed temperature if they are not compliance each other. Refer to the instruction manual enclosed with the recorder.

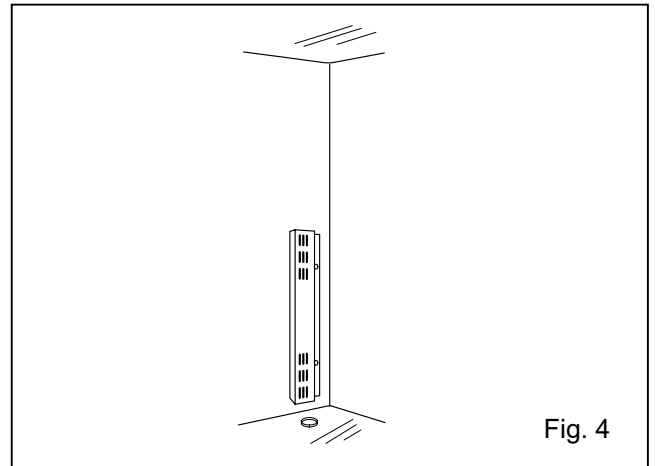

Fig. 4

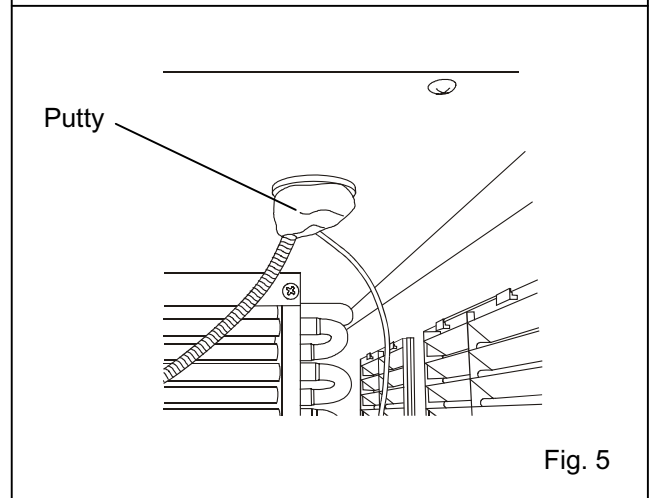
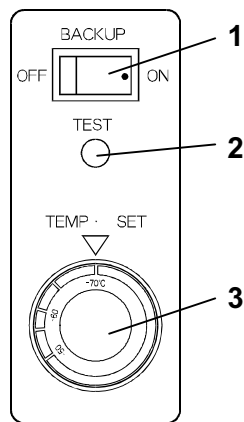

Fig. 5

BACK-UP SYSTEM (OPTION)

This freezer can be provided with a back-up system (CVK-UB4) which is available as an optional component. For the installation, refer to the instruction manual enclosed with the system.



CVK-UB4 control panel

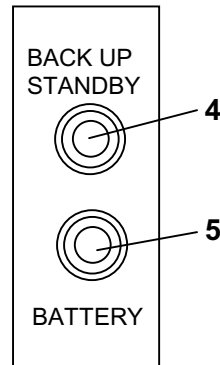

CVK-UB4 switch box

1. Power switch (BACKUP)

When turning on the system, the back-up standby lamp (green) is brightened. This means that the system is ready. To stop the operation of the system, turn off this switch.

2. Test switch (TEST)

This switch is for checking the operation of back-up system. Pressing this switch is resulted in the release of liquid carbon dioxide gas without system operation.

3. Temperature setting knob (TEMP. SET)

With this knob, set the temperature at which the system is operated. The effective set temperature range is between -50°C and -70°C .

4. Back-up standby lamp (BACK UP STANDBY)

A lamp that is activated in conjunction with the ON/OFF of the power switch of the back-up system.

5. Battery lamp (BATTERY)

This lamp is brightened in orange when the battery capacity is less.

WARNING

As with any equipment that uses CO_2 gas, there is a likelihood of oxygen depletion in the vicinity of the equipment. It is important that you assess the work site to endure there is suitable and sufficient ventilation. If restricted ventilation is suspected, then other methods of ensuring a safe environment must be considered. These may include atmosphere monitoring and warning devices.

BACK-UP SYSTEM (OPTION)

With the back-up system (CVK-UB4), the freezer prevents the chamber temperature from going up by injecting the liquid CO₂ gas when the power supply is disconnected (power failure, disconnection of power cord, breaker OFF) or in the case of failure of freezer itself. The liquid CO₂ gas is injected with the activation of solenoid valve energized by battery when the chamber temperature reaches the alarm temperature.

Following shows the procedure for setting the back-up system.

1. Setting of liquid CO₂ gas cylinder

By using the joint and pipe enclosed with the back-up system, connect the liquid CO₂ gas cylinder to the joint of the back-up system. For this setting, consult with a qualified gas supplier or Sanyo sales agency.

2. After setting the liquid CO₂ gas cylinder, operate the freezer until the chamber temperature reaches the required level.

3. Set the temperature of back-up operation at the temperature higher than -70°C. The back-up system is operated continuously if the temperature of back-up operation is set at the temperature lower than -70°C. This means the liquid CO₂ gas is consumed very quickly.

4. Switch on the back-up system.

5. Make sure that liquid CO₂ gas spouts into the freezer chamber by pressing the back-up test switch.

Note:

- The liquid CO₂ gas cylinder loses its cooling capacity at speed when the ambient temperature is over 31°C. Install the liquid CO₂ gas cylinder in the cool environment. And the duration of back-up time per one liquid CO₂ gas cylinder varies depending on the ambient temperature. Refer to "Installation of back-up system" enclosed with the back-up system for the available back-up time.
- The liquid CO₂ gas cylinder should be a siphon type.
- Use the pipe enclosed with the back-up system for the setting. (The extension of the pipe is not permitted because of cooling capacity.)

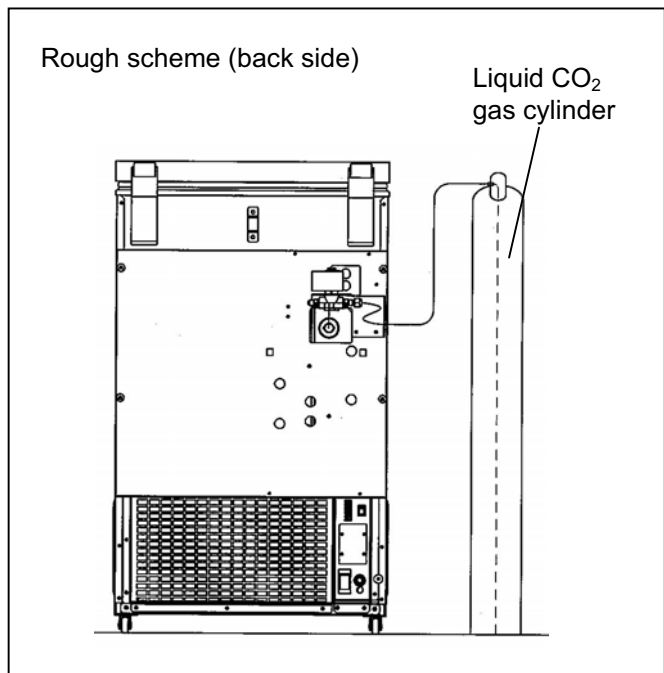

SPECIFICATIONS

Name	Ultra-Low Temperature Freezer
Model	MDF-C8V
External dimensions	W550 x D685 (+83)* x H945 (mm)
Internal dimensions	W405 x D490 x H425 (mm)
Effective capacity	84 L
Exterior	Painted steel
Interior	Painted steel
Door	Painted steel
Access port	Diameter 17 mm, back side, bottom
Insulation	Cabinet; Rigid polyurethane foamed-in place and VIP(vacuum insulation panel) Door; Rigid polyurethane foamed-in place
Compressor	Hermetic rotary type, 400 W
Evaporator	Tube on sheet type (also used as a inner cabinet)
Condenser	Finless tube type
Refrigerant	HFC mixed refrigerant
Temperature controller	Microcomputer control system
Temperature display	Digital display (setting range; between -55°C and -85°C)
Temperature sensor	Platinum resistance (Pt 1000 Ω)
Temperature alarm	High temp. alarm, Low temp. alarm, Remote alarm, Battery check
Remote alarm contact	Allowable contact capacity: DC 30 V, 2 A
Battery	Nickel-metal-hydride battery, DC 6 V, 1100 mAh, Automatic charge
Weight	64 kg
Accessories	1 set of key, 1 scraper
Optional component	Automatic temperature recorder (MTR-85H, MTR-G85) Mounting kit for automatic temperature recorder MTR-85H (MDF-S3085) Recorder sensor cover (MTR-C8) Back-up system (CVK-UB4), Back-up mounting plate (MDF-UBK) Inventory rack (IR-207C, IR-305C)

Note :

Design or specifications will be subject to change without notice.

* The value in the parenthesis means the dimension of projected area.

The battery for power failure alarm is an article for consumption. It is recommended that the battery will be replaced about every 3 years.

PERFORMANCE

Cooling performance	-80°C (ambient temperature; 30°C, no load)					
Temperature control range	-60°C to -80°C (ambient temperature; 30°C, no load)					
Rated voltage	AC 110 V	AC 115 V	AC 220 V	AC 230V	AC 240V	AC 220V
Rated frequency	60 Hz	60 Hz	50 Hz	50 Hz	50 Hz	60 Hz
Rated power consumption	295 W	300 W	310 W	325 W	350 W	310 W
Noise level	49 dB [A] (background noise; 20 dB)					
Maximum pressure	3.7 MPa					

Note : The unit with CE mark complies with EC directives 89/336/EEC, 93/68/EEC and 73/23/EEC.

CAUTION

Please fill in this form before servicing.
Hand over this form to the service engineer to keep for his and your safety.

Safety check sheet

1. Freezer contents : Yes No
Risk of infection: Yes No
Risk of toxicity: Yes No
Risk from radioactive sources: Yes No

(List all potentially hazardous materials that have been stored in this unit.)

Notes :

2. Contamination of the unit:

- Unit interior: Yes No
No contamination: Yes No
Decontaminated: Yes No
Contaminated: Yes No
Others:

3. Instructions for safe repair/maintenance of the unit

- a) The unit is safe to work on Yes No
b) There is some danger (see below) Yes No

Procedure to be adhered to in order to reduce safety risk indicated in b) below.

Date :

Signature :

Address, Division :

Telephone :

Product name: Ultra-low temperature freezer	Model: MDF-C8V	Serial number:	Date of installation:
---	-------------------	----------------	-----------------------

Please decontaminate the unit yourself before calling the service engineer.

INSTRUCTION MANUAL

CVK-UB4 CVK-UB4(I)

Back-up System for Ultra-Low Temperature Freezer



CONTENTS

INTRODUCTION	P. 2
PRECAUTIONS FOR SAFE OPERATION	P. 3
COMPONENTS LIST	P. 5
INSTALLATION	
Assembling of the solenoid valve	P. 8
Installation of the door switch	P. 9
installation of the back-up kit	P.10
Wiring	P.12
CONTROL PANEL	P.13
TRIAL OPERATION	P.14
Calibration	P.14
SPECIFICATIONS	P.15
PERFORMANCE	P.15

INTRODUCTION

- Read this manual carefully before using the appliance and follow the instructions for safety operation.
- Sanyo never guarantee any safety if the appliance is used for any objects other than intended use or used by any procedures other than those mentioned in this manual.
- Keep this manual in an adequate place to refer to it as necessary.
- The contents of the manual will be subjected to change without notice due to the improvement of performance or functions.
- Contact Sanyo sales representative or agent if any page of the manual is lost or page order is incorrect.
- Contact Sanyo sales representative or agent if any point in this manual is unclear or if there are any inaccuracies.
- No part of this manual may be reproduced in any form without the expressed written permission of Sanyo.
- The mounting plate (MDF-UBK) of the option goods is necessary for the installation of the back-up system.

PRECAUTIONS FOR SAFE OPERATION

It is imperative that the user complies with this manual as it contains important safety advice.

Items and procedures are described so that you can use this unit correctly and safely. If the precautions advised are followed, this will prevent possible injury to the user and any other person.

Precautions are illustrated in the following way:



WARNING

Failure to observe WARNING signs could result in a hazard to personnel possibly resulting in serious injury or death.

CAUTION

Failure to observe CAUTION signs could result in injury to personnel and damage to the unit and associated property.

Symbol shows;

-  this symbol means caution.
-  this symbol means an action is prohibited.
-  this symbol means an instruction must be followed.

Be sure to keep this manual in a place accessible to users of this unit.

< Label on the unit >



This mark is labeled on the cover in which the electrical components of high voltage are enclosed to prevent the electric shock.





The cover should be removed by a qualified engineer or a service personnel only.

WARNING





As with any equipment that uses CO₂ gas, there is a likelihood of oxygen depletion in the vicinity of the equipment. It is important that you assess the work site to ensure there is suitable and sufficient ventilation. If restricted ventilation is suspected, then other methods of ensuring a safe environment must be considered. These may include atmosphere monitoring and warning devices.

PRECAUTIONS FOR SAFE OPERATION

WARNING

-  **Only qualified engineers or service personnel should install this system.** The installation by unqualified personnel may cause electric shock or fire.
-  **Turn off the all switches and disconnect the power supply to the ultra low temperature freezer prior to the attachment of the back-up system** in order to prevent electric shock or injury.
-  **Never disassemble, repair, or modify the unit yourself.** Any such work carried out by an unauthorized person may result in fire or injury due to a malfunction.
-  **There is a terminal (AC 100V) of the high voltage in the back-up system. Attach the back-up unit cover before starting the trial operation.** The operation without the cover may cause electric shock.
-  **CO₂ gas is released when the back-up system is operated. Use this kit in well-ventilated environment** as high CO₂ density level may cause a deficiency of oxygen.







CAUTION

-  **This manual includes the attachment procedure for CVK-UB4 and CVK-UB4(I) only.** For its operation and the operation of a ultra-low temperature freezer, see an instruction manual provided with the freezer.
-  **Put on the dry gloves to protect the hands at the time of attachment.** No gloves may cause cut of the finger by the edge or corner.
-  **Connect a pipe from a liquid CO₂ gas cylinder to this unit correctly.** Incorrect connection may cause gas leakage.
-  **Check the gas piping before trial operation to avoid gas leakage.**
-  **Stop the operation immediately and review the attachment procedure carefully** if there is something wrong with the back-up system during the trial operation.

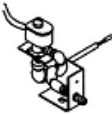
COMPONENTS LIST



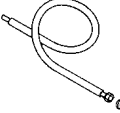
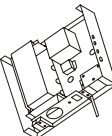
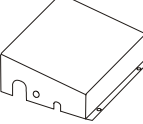
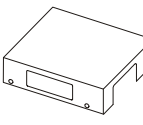

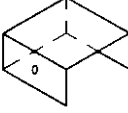



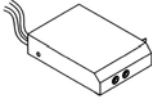

Confirm that the accessories of the table 1 are gathered. Report it to the dealer or the sales if there is a problem in packing of the product.

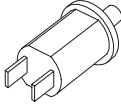
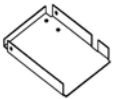
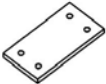
Table 1

No.	PARTS NAME	Q' TY	APPEARANCE	THE EXPLANATION OF THE USE
1	PLATE MTG A	1		The plate fixes a solenoid valve cover.
2	LCO ₂ SOLENOID VALVE ASS'Y	1		It is the solenoid valve of LCO ₂ . (This is assembled by the setup.)
2-1	LCO ₂ SOLENOID VALVE	1		It is a part of the LCO ₂ solenoid valve assy.
2-2	VALVE OUTLET PIPE	1		It is a part of the LCO ₂ solenoid valve assy.
2-3	SK BAND	2		A CO ₂ valve is put in the chamber, and it is the part which fixes insulation.
3	LCO ₂ JOINT PIPE AND JOINT PACKING	1		The pipe which connects a LCO ₂ gas cylinder and the LCO ₂ solenoid valve.
4	BACK-UP SYSTEM	1		LCO ₂ is injected when a freezer has temperature rise.
5	SOLENOID VALVE COVER	1		This cover is a protection of the LCO ₂ solenoid valve.
6	BACK-UP SYSTEM COVER	1		This cover is a protection of the back-up system.
7	VALVE PLATE MTG	1		This plate fixes a valve cover.
8	VALVE COVER	1		This cover protects a valve outlet pipe in the chamber.

COMPONENTS LIST

The continuation of the table 1

No.	PARTS NAME	Q' TY	APPEARANCE	THE EXPLANATION OF THE USE
9	LABEL	1		It is put near the connection place.
10	DOOR SWITCH ASS'Y	1		This assy connected a door switch and two indicator lamps (green and orange).
10-1	INDICATOR LAMP (GREEN)	-		It is the lamp turned on with a power switch of the back-up system. (It is attached.)
10-2	INDICATOR LAMP (ORANGE)	-		It is the lamp turned on when the battery of the backup system declines. (It is attached.)
10-3	DOOR SWITCH	-		When the door of the freezer opens and closes, it is the switch which does on-off. (It is attached.)
10-4	WIRING ASS'Y DS	1	Refer to the Fig. of Page12.	These wires are the indicator lamp and the door switch. (It is attached.)
11	DOOR SWITCH MTG PLATE	1		It is a plate which fixes a door switch ass'y.
12	SHIM (for DOOR SWITCH MTG PLATE)	1		It is a plate to lay under the door switch mounting plate.
13	STRIKE PLATE	1		It is fixed on the door of the freezer, and it is the part that on-off does a door switch by the open/close of the door..
14	WIRE COVER	2		This cover fixes the wiring ass'y DS of the door switch ass'y.
15	SCREW A M4x10 (C TIGHT)	11		For nylon clip 6N(1)、For Nylon clip 7N (2)、For back-up system(2)、For solenoid valve(4)、For mounting plate(2)
16	SCREW B M4x10 (STAINLESS)(COLORED HEAD)	7		For solenoid cover(4)、For door switch ass'y (3)
17	SCREW C M4x10 (STAINLESS)	2		For valve cover
18	SCREW D M5x10 (STAINLESS)	2		For strike plate
19	SCREW E M5x16 (PAN HEAD)	2		For door switch mounting plate

COMPONENTS LIST

The continuation of the table 1

No.	PARTS NAME	Q' TY	APPEARANCE	THE EXPLANATION OF THE USE
20	WIRING ASS'Y BP	1		It is harness to install on the electric box of the freezer (option).
21	NYLON CLIP 6N	1		Wiring ass'y DS is fixed.
22	NYLON CLIP 7N	2		Wiring ass'y BP is fixed.

INSTALLATION

Assembling of the solenoid valve

1. The joint nut on the outlet side of the CO₂ solenoid valve is removed. The valve outlet pipe with the pipe insulation is inserted into the joint nut, and fastened in the joint. (Fig. 1) Fasten a joint part securely so that CO₂ gas can not leak out. (Fig. 2).
2. Insulation is fixed with a SK band. (Two places) (Fig. 3).

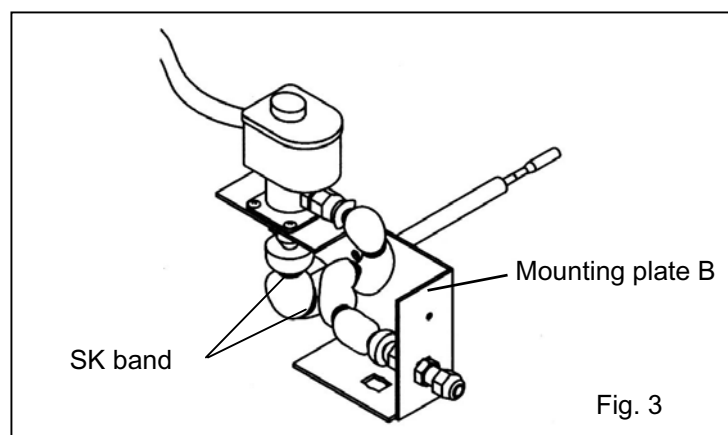
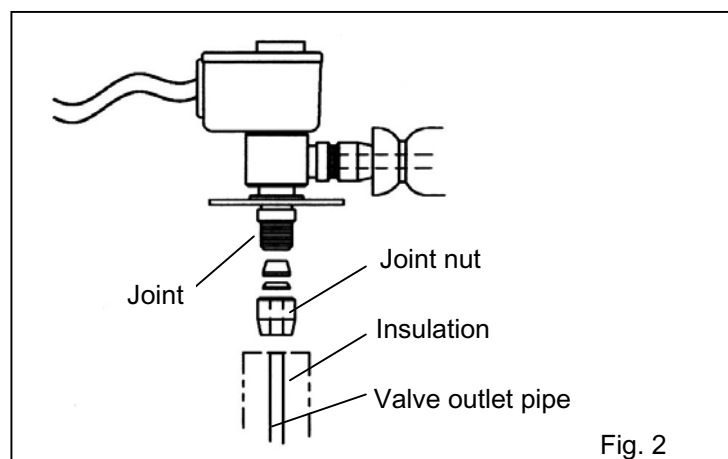
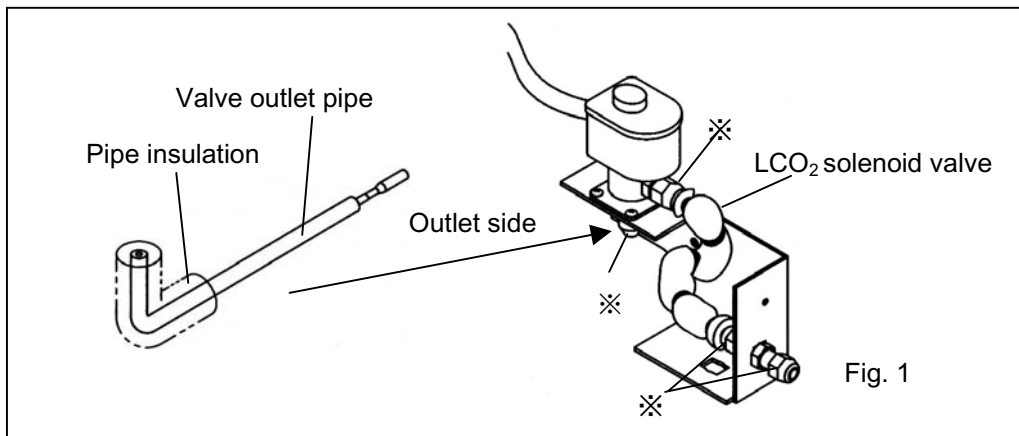

⚠ CAUTION

Check the gas piping before trial operation to avoid gas leakage. The nut marked with * in Fig. 1 is not fixed surely. Tighten it completely by assembling, and enforce a leak test.

INSTALLATION

Installation of the door switch

1. Spacer and a door switch mounting plate are fixed on the hole of the left side (upside) of the freezer with two screws E (M5 x 16 pan head). (Fig. 1)

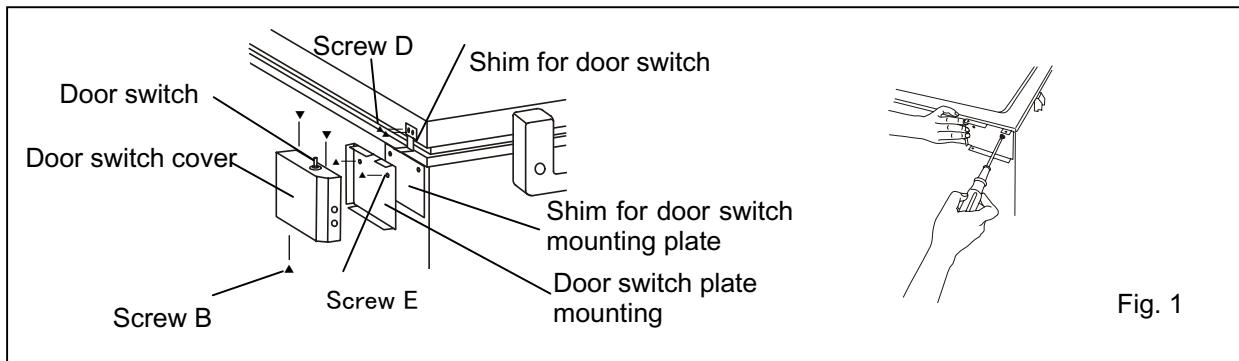

2. It confirms that an indicator lamp, the door switch and those wirings are being done, and the door switch ass'y is fixed on the door switch mounting plate with three screws B (M4 x 10 stainless steel (coating head)).(Fig. 2)

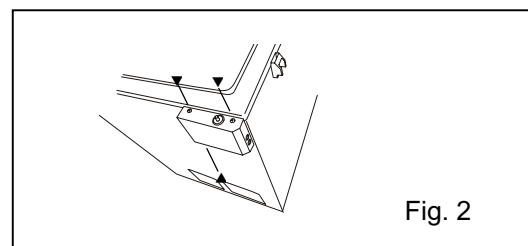

3. Strike plate is installed with two screws D (M5 x 10 stainless steel). (Fig. 3)

At this time, adjust it to the position where door switch is pushed under the condition that door closes.

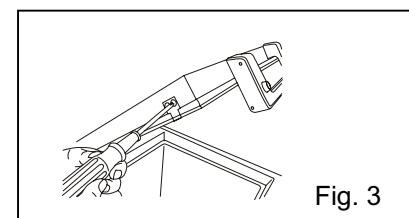

4. Wire cover is put on the rear side of freezer and the protection, and the wiring ass'y DS which it out of the door switch ass'y is pasted on the left side of freezer. (Fig. 4)

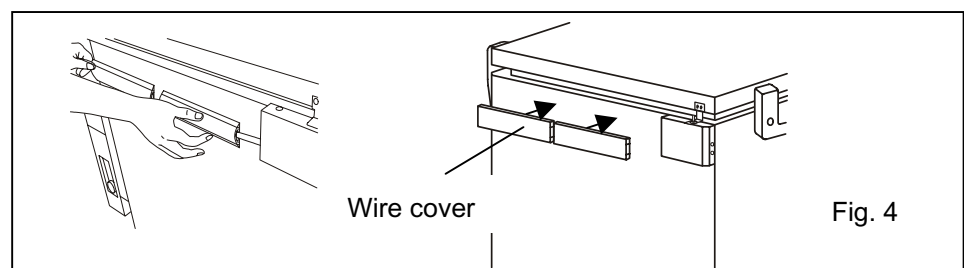

5. The connector of the harness is connected to the connector on the top of the back-up system kit. (See Page 12)

INSTALLATION

Installation of the back-up kit

1. The slit (bottom right rear side) which freezer is being fitted up with, a rear cover, a sensor cover, the rubber cap of the access port and insulation inside the access port are taken out.

2. Wiring ass'y BP is passed through the nylon clip 7N, and fixed on the back of MDF-UBK (option) with two screws A (M4 x 10 C It is tight.). At this time, a wiring ass'y BP point is shown from the lower corner access port of MDF-UBK 150 mm. (Fig. 1) (It is wired for the harness in the next step 3)

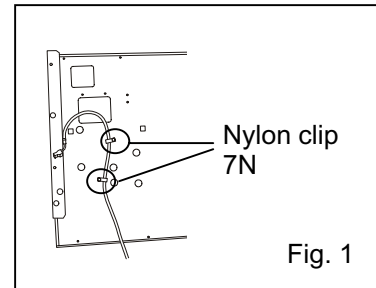

3. The cover which sticks to the connector (4P) in the rear of electrical box is removed and connected to the connector that it has wiring ass'y BP prepared on the product side, It is fixed with lead wire band on the side of the (Fig. 2) electrical box. The rear cover of freezer is fixed after the management of the wiring ass'y BP is finished. (Fig. 3)

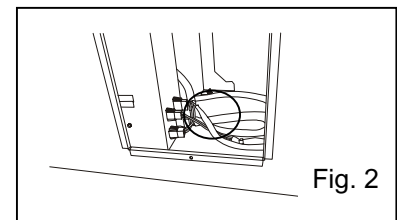

4. At this time, four screws in the rear of the freezer are loosened. (with the second from the top, the 4th (left and right)) And MDF-UBK is fixed with a screw. (Fig. 4)

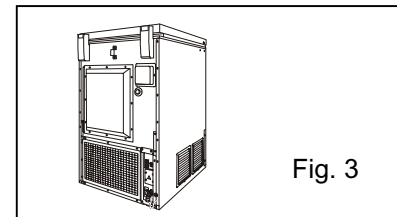

5. An back-up system and an back-up system cover are removed, and hook of the top (Fig. 5) on the back of the back-up system is installed on MDF-UBK, and a bottom part is fixed with two screws A (M4 x 10 C It is tight.). Then, it gains a removed back-up system cover in the back-up system in the former street. (Fig. 6)

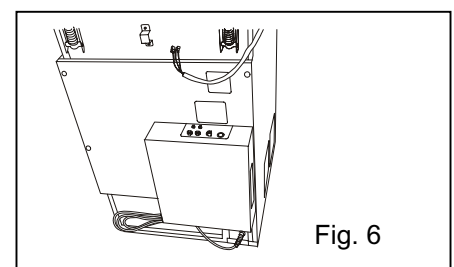
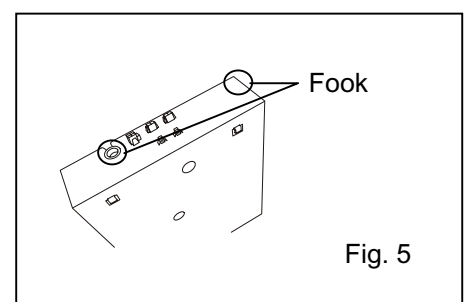
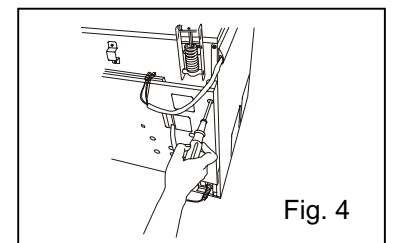

INSTALLATION

6. The sensor cover inside freezer chamber is removed, and the thermostat sensor part of the back-up system is inserted into the hole under freezer temperature style sensor. The hole of the neighborhood of the thermostat sensor part which inserted (A hole does not open an access port. Therefore, make a hole in the plus driver.) into freezer inside and the rear side is stopped with silicon. Then, a thermostat sensor is fixed on the sensor mounting plate by using the clip prepared in the sensor mounting plate in advance. After that, gain a sensor cover inside in the former street. (Fig. 7)

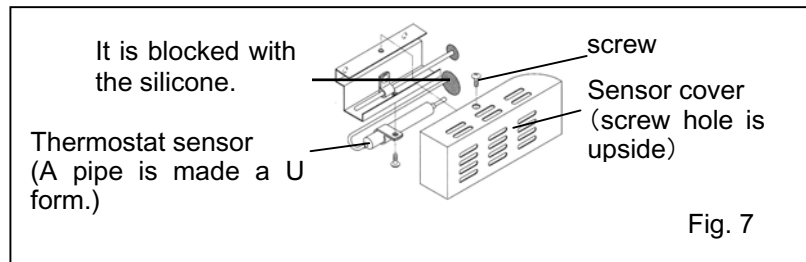

7. There is a access port which inserts the CO₂ valve outlet pipe of the CO₂ solenoid into the lower corner hole of MDF-UBK. The CO₂ valve outlet pipe is inserted in that, and a LCO₂ solenoid valve is fixed on MDF-UBK with one screw A (M4 x 10 C It is tight.). (Fig. 8) The mounting plate A is fixed with two screws A (M4 x 10 C is tight.). The surroundings of the CO₂ valve outlet pipe which inserted into freezer are blocked with silicon. (Fig. 9) The valve cover mounting plate is fixed by using the screw which sticks in the freezer in advance. It gains a valve cover after a CO₂ valve outlet pipe is bent in the bottom. (Fig. 10)

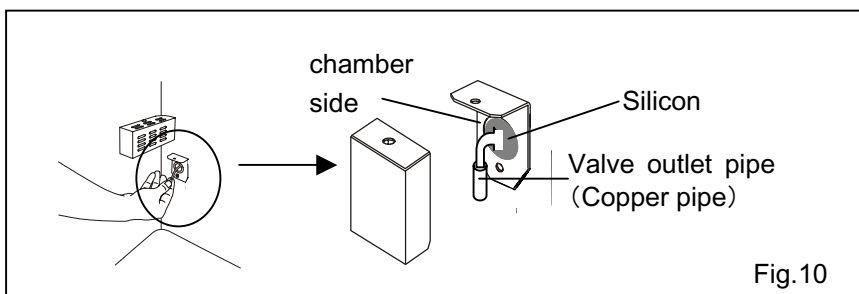
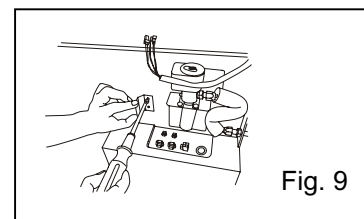
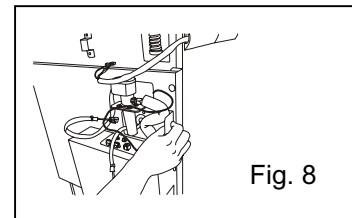

8. The wiring ass'y DS which it goes to out of the door switch ass'y is passed through the nylon clip 6N, and MDF-UBK is stopped with one screw A (M4 x 10 C It is tight.). (Fig. 11)

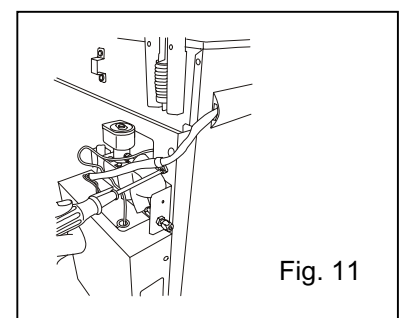

9. When all harness management is finished, a solenoid valve cover is fixed with four screws B (M4 x 10 stainless steel (coating head)) four places. (Fig. 12) (see page 12.)

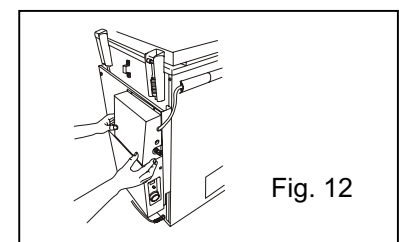

INSTALLATION

Wiring

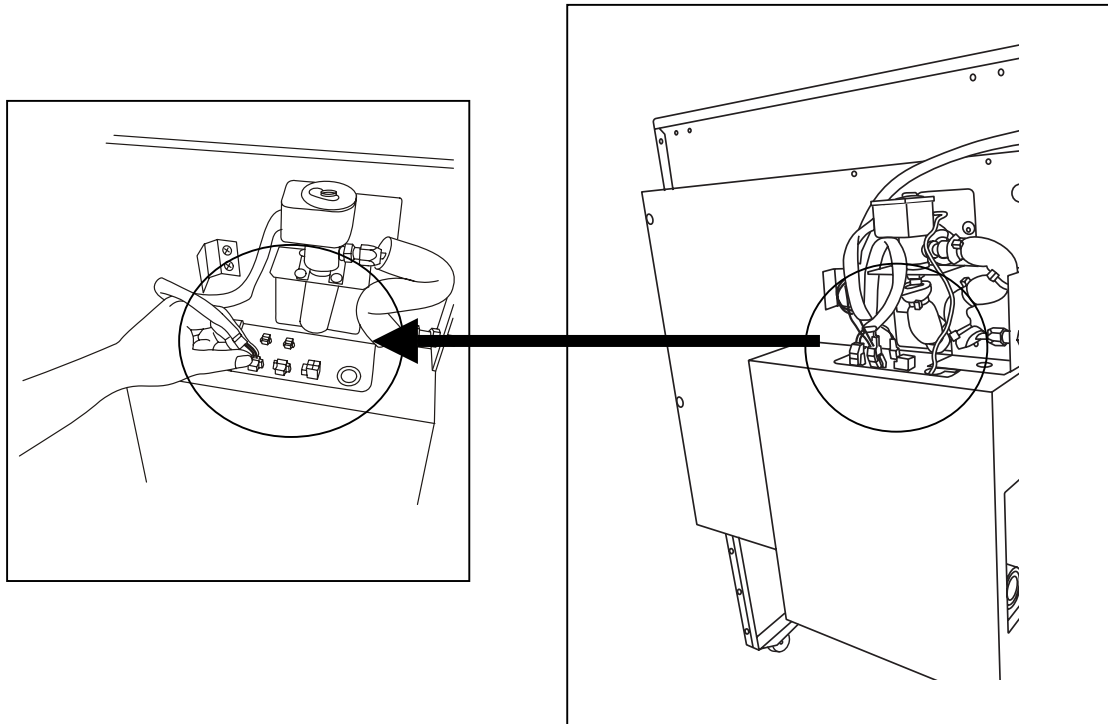

1. Harness (a white connector) from the solenoid valve is connected to the connector of the upper same color of the back-up system.
2. It passes through the wiring ass'y DS (one white connector and two red connectors) from the door switch ass'y from the outside of the solenoid, and each upper of the back-up system ass'y is connected with the connector of the same color.
3. Wiring ass'y BP (white connector) from the freezer itself is connected with the connector of the upper same color of the back-up system ass'y.

⚠ WARNING

There is a terminal (AC 100V) of the high voltage in the back-up system. Attach the back-up unit cover before starting the trial operation. The operation without the cover may cause electric shock. Connect the connection of the connector until you have clicking sound.

CONTROL PANEL

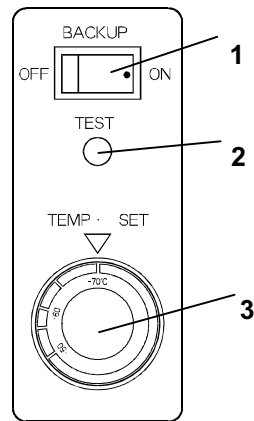

Control panel for CVK-UB4

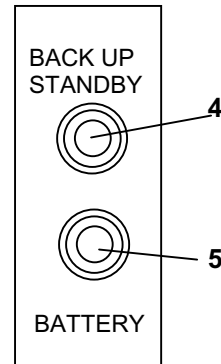

Door switch ass'y for CVK-UB4

1. Power switch of back-up system (BACKUP)

When turning on the system, the back-up stand-by on the door switch ass'y is brightened. This means that the system is ready. When this switch is turned off, the operation of the back-up system stops, and a back-up stand-by lamp turns off the lights.

2. Test switch (TEST)

This button switch is for checking the operation of back-up system. Pressing this switch is resulted in the release of LCO₂ gas into the freezer chamber with regardless the condition. A battery lamp is turned on when battery capacity decreases at this time. Push a back-up test switch for the life test of the battery sometimes.

3. Temperature setting knob (TEMP. SET)

With this knob, set the temperature at which the system is operated. The effective set temperature range is between -50°C and -70°C.

4. Back-up stand-by lamp (BACKUP STANDBY)

It is the lamp turned on by ON/OFF of the back-up power switch. (GREEN color)

5. Battery lamp (BATTERY)

A power failure and a back-up test switch are pushed, and CO₂ gas appears, and it is turned on when battery capacity decreases.(ORANGE color).

CAUTION

Batteries are expendable supplies. Exchange it for about every three years. And, entrust a dealer or sales with the exchange of the battery, and cooperate with recycling of the battery after the use.

When a battery declines by the power failure, a back-up unit stops working, and an exchange is recommended because a contents thing can not be protected any more.

TRIAL OPERATION

Following is the procedures for the trial operation of the back-up system. Read an instruction manual enclosed with a ultra-low temperature freezer carefully before the trial operation.

1. Check that the gas cylinder connect pipe is connected properly between the LCO₂ solenoid valve and the gas cylinder. The connection should be done by qualified engineers or service personnel only.
2. Set the ultra-low temperature freezer at desired temperature and run the freezer until it reaches the set temperature.
Note: CO₂ gas will be released automatically without pressing the test switch when turn on the back-up system if the set temperature of the freezer is higher than that of the back-up temperature.
3. Set the temperature setting knob to the temperature 10°C or more higher than the set temperature of the freezer.
4. Turn on the back-up system with the freezer door closed. Check that the indicator on the door switch ass'y is on.
5. Press the test switch to check that the CO₂ gas is released into the freezer chamber.

Stop the operation immediately and contact your dealer or sales representative if there is something wrong with the back-up system during the trial operation and it is still existing after careful check of the procedure.

WARNING

Check the gas piping before trial operation to avoid gas leakage.

Attach the back-up unit cover before starting the trial operation. The operation without the cover may cause electric shock.

CAUTION

Stop the operation immediately and review the attachment procedure carefully if there is something wrong with the back-up system during the trial operation.

Calibration

In the case that there is a difference between the chamber temperature and displayed temperature, Adjust the displayed temperature by the method of the service technical manual.

SPECIFICATIONS

Name	Back-up System for Ultra-Low Temperature Freezer	
Model	CVK-UB4	CVK-UB4(I)
Outer dimensions	W286 x D87 x H520 mm	
Applicable model	MDF-C8V	
Applied gas	Liquid CO ₂ gas	
Temperature control	Gas type thermostat	
Door switch	Door operation-related ON/OFF	
Indicator	Back-up switch-related ON/OFF	
Accessories	Mounting kit (except for gas cylinder) Tank connecting tube: mm size	Mounting kit (except for gas cylinder) Tank connecting tube: inch size
Power source	AC 115 V / AC 230 V (supplied from a freezer)	
Battery	DC 24 V, 4 Ah, Automatic recharge	
Weight	11 kg	
Optional component	Mounting plate (MDF-UBK)	

Note : Design or specifications will be subject to change without notice.

The battery for power failure alarm is an article for consumption.

It is recommended that the battery will be replaced about every 3 years. Contact Sanyo sales representation or agent at the time of replacement of the battery for recycling.

PERFORMANCE

Temperature range	-50 to -70°C
Duration	Approx. 13 hours (liquid CO ₂ gas cylinder of 30 kg) (ambient temp.; 30°C, set temp.; -70°C, no load.)
Maximum power consumption	6 W
Usable environment	Temperature; -5 to +30°C, Humidity; Less than 80% RH

Note:

The back-up system is operated with an installed battery in the event of power failure.

About two-day operation of a freezer is necessary to full charge the battery.

SANYO

JK1659-150B

Free Manuals Download Website

<http://myh66.com>

<http://usermanuals.us>

<http://www.somanuals.com>

<http://www.4manuals.cc>

<http://www.manual-lib.com>

<http://www.404manual.com>

<http://www.luxmanual.com>

<http://aubethermostatmanual.com>

Golf course search by state

<http://golfingnear.com>

Email search by domain

<http://emailbydomain.com>

Auto manuals search

<http://auto.somanuals.com>

TV manuals search

<http://tv.somanuals.com>