

INSTRUCTION MANUAL

Recordable DVD Home Theatre System

DVR-HT120

DVD recorder: **DVR-S120**

Powered subwoofer: **ASX-HT120W**

Front speakers: **SX-HT120F**

Centre speaker: **SX-HT120C**

Rear speakers: **SX-HT120R**

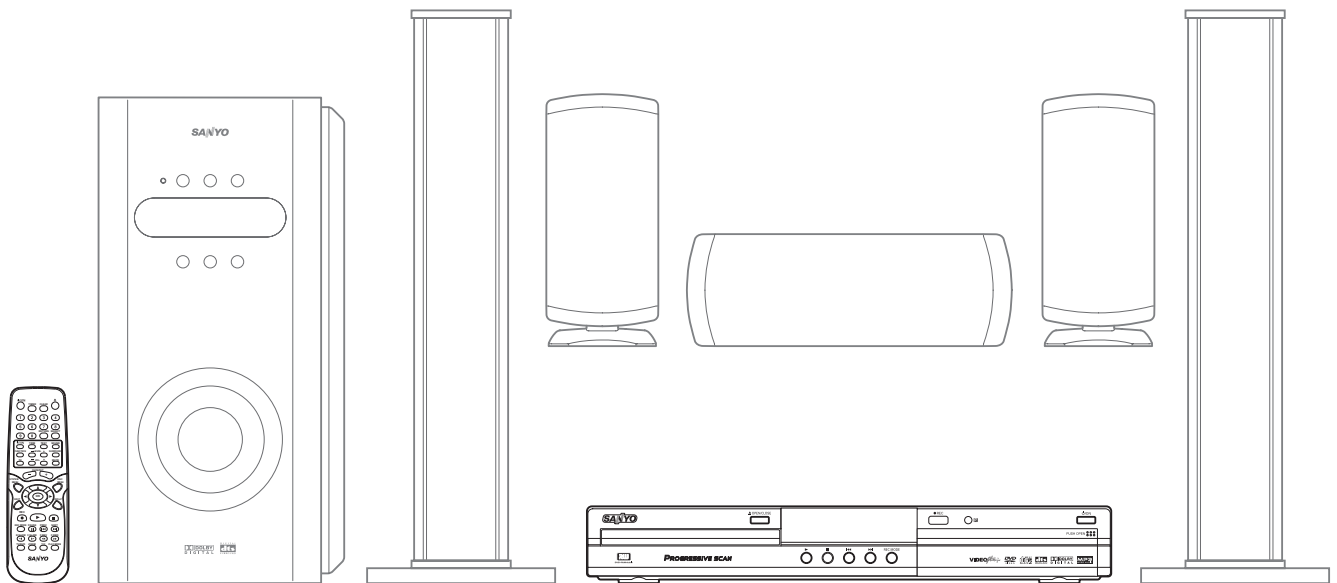

Problems with set up?

Call 0870 240 7475

Calls cost a maximum of 8p per minute during peak periods, based on BT rates of April 2004.

Please read this manual carefully before connecting your DVD Recorder and operating it for the first time. Keep the manual in a safe place for future reference.

PRECAUTIONS

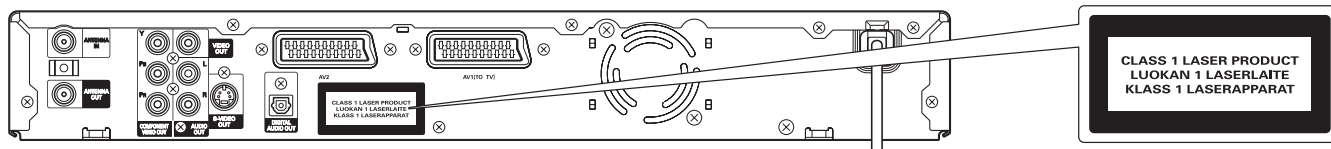

THIS PRODUCT CONTAINS A LOW POWER LASER DEVICE. TO ENSURE CONTINUED SAFETY DO NOT REMOVE ANY COVERS OR ATTEMPT TO GAIN ACCESS TO THE INSIDE OF THE PRODUCT. REFER ALL SERVICING TO QUALIFIED PERSONNEL.

- The apparatus shall not be exposed to dripping or splashing.
- No objects filled with liquids, such as vases, shall be placed on the apparatus.
- Do not use where there are extremes of temperature (below 5°C or exceeding 35°C) or where direct sunlight may strike it.
- Because of the DVD recorder's extremely low noise and wide dynamic range, there might be a tendency to set the volume on the amplifier unnecessarily high. Doing so may produce an excessively large output from the amplifier which could damage your speakers.
- Sudden changes in the ambient temperature may cause condensation to form on the optical lens inside the unit. If this happens, take out the disc, leave the unit for about 2 hours, and then proceed to operate.
- When carrying the unit, be sure to remove a disc which may be inside and turn the power off. Wait at least 10 seconds, then unplug the mains lead from the AC outlet. Carrying the unit with a disc inside may damage the disc and/or the unit.
- Do not install this equipment in a confined space, such as a book case or built-in cabinet.
- The unit must be operated in a horizontal position only.
The unit must be placed in a well ventilated area.
Do not place any object on the top of the unit.
Do not block ventilation holes.
The cabinet of the unit warms up when it is used for a long time, but it is not a malfunction.



Your SANYO product is designed and manufactured with high quality materials and components which can be recycled and reused. This symbol means that electrical and electronic equipment, at their end-of-life, should be disposed of separately from your household waste.

Please dispose of this equipment at your local community waste collection/recycling centre.

In the European Union there are separate collection systems for used electrical and electronic products.

Please help us to conserve the environment we live in!

This product incorporates copyright protection technology that is protected by method claims of certain U.S. patents and other intellectual property rights owned by Macrovision Corporation and other rights owners. Use of this copyright protection technology must be authorized by Macrovision Corporation, and is intended for home and other limited viewing uses only unless otherwise authorized by Macrovision Corporation. Reverse engineering or disassembly is prohibited.

Recording copyright material without permission of the copyright owners is usually an infringement. If you wish to re-record copyright material, permission from the copyright owner is necessary. SANYO does not approve of, and cannot be held responsible for, any unlawful use of this machine.

IMPORTANT

If the plug supplied with this equipment is not suitable for the socket outlets in your home it should be cut off and replaced with the correct type.

Disposal of Plug

If the non rewirable plug is to be cut off, the removed plug should be disposed of carefully as there is a shock hazard should the plug be inserted into a live socket.

Replacing Fuse

The detachable fuse cover must be replaced after changing the fuse. Only a 3A fuse should be used and should comply with BS1362 and should carry the ASTA mark .

The wires in the mains lead are coloured in accordance with the following code;

Blue	Neutral
Brown	Live

The wires in the mains lead must be connected to the terminals in the plug as follows;

Wire colour	Plug terminal marking
Blue	N or Black or Blue
Brown	L or Red or Brown

Do not connect either wire to the earth terminal.

If the mains plug contains a fuse this should be 3A, if a plug without a fuse is used the distribution board fuse should not be greater than 5A.

Disconnect the mains plug from the supply socket when not in use. Do not remove the back cover with mains connected.

The unit is not disconnected from the mains unless it is unplugged from the AC outlet.

Either the main unit or remote control can be operated. However, for convenience, this instruction manual explains operation using the remote control.

NOTE:

- This handling description is printed prior to product development.
- When a part of the product specification must be changed to improve operability or other functions, priority is given to the product specification itself.
- In such instances, the instruction manual may not entirely match all the functions of the actual product.
- Therefore, the actual product and packaging, as well as the name and illustration, may differ from the manual.

This set complies with the EMC Directive 89/336 and with the LVD Directive 72/23.

CONTENTS

PRECAUTIONS	1	DISC PLAYBACK	23
IMPORTANT	1	Basic Operations	23
ACCESSORIES	2	LISTENING TO MUSIC	24
PART NAMES & FUNCTIONS	3	Playable Discs	24
Front Panel	3	Basic Playback Operations	24
Rear Panel	4	Repeat Playback, Random Playback, Intro Playback	25
Remote Control	5	Playing Back a Specific Track	25
Operation Status Display	6	Playing Back from a Specific Point by Time Search	25
Front panel display	6	Playing Back MP3 Discs	25
Status display on TV screen.....	7	VIEWING JPEG CD PHOTOS & IMAGES	26
Disc Information	7	Playable Discs	26
Recordable Discs	7	Displaying the Thumbnail Screen.....	26
Playable Discs	8	Searching for Photos in the Thumbnail Screen.....	26
Notes on handling discs	8	Displaying Photos in the Slide Show.....	27
Cleaning discs for high quality recording	8	EDITING & DISC MANAGEMENT	28
About Titles, Chapters and Tracks	8	Editing Chapters	28
INSTALLATION, CONNECTION & SETTING THE CHANNEL	9	Insert Chapter	28
Connecting to a TV and Various AV Equipment	9	Hide Chapter	28
Connecting to a TV.....	9	Unhide Chapter	28
Connecting a satellite receiver	11	Delete Chapters(Delete Chapter, Delete All).....	28
Connecting audio equipment	11	Editing Titles	29
Connecting to a video deck and other recording equipment.....	12	Editing Recording Titles (name)	29
Connecting the Main Lead	14	Playback Title	29
Initial Settings	14	Erasing a recording/title	29
Auto-setting the channel	15	Disc settings	29
Setting the Clock	15	Changing the Disc Name	29
Manually Setting the Reception Channel	15	Erasing DVD+RW Discs.....	29
Displaying the channel setup screen	15	Finalising DVD+R Discs	30
Manually setting the channel.....	15	Make DVD Compatible.....	30
Arranging and Deleting Channels	16	DVD RECORDER SETTINGS	31
RECORDING	17	TV Screen Settings	31
Recording Programmes during Reception	17	Audio Output Settings	32
Timer Recording	18	Operation and State Display Settings	32
Timer recording by "Video Plus+ code"	18	Setting the Language	33
Timer recording without using "Video Plus+ code"	20	Recording Settings	34
Checking, Changing and Deleting Reservations.....	21	Parental Level Control	34
Problem solving for programmed recordings	21	Setting parental level control.....	34
Recording Video from Other AV Equipment	22	To play back a DVD video set with parental level controls.	35
Inserting New Recordings on a DVD+RW	22	TROUBLESHOOTING	36
SAT Record		MAINTENANCE	38
(Automatic recording from Satellite Receiver)	22	Cleaning the cabinet	38
		SPECIFICATIONS	38

ACCESSORIES

Remote control x 1
R6 (HP 7) battery x 2
Video lead x 1

75-ohm coaxial aerial lead x 1
DVD+RW blank disc x 1

PART NAMES & FUNCTIONS

Front Panel

You can operate the DVD recorder using the remote control or the buttons on the front panel of the DVD recorder.

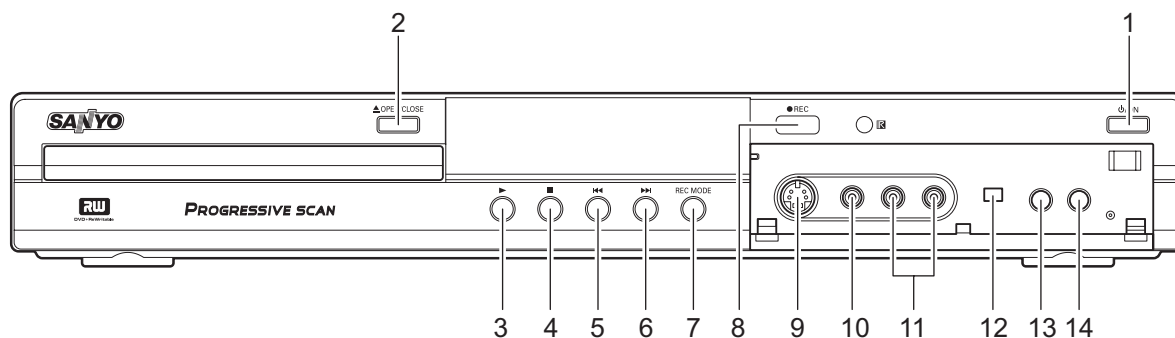

1	ON	To switch on or standby.	p.14
2	OPEN/CLOSE	Open/close disc tray.	p.17, 23
3		Playback button: To play back a disc.	p.23
4		Stop button: Interrupt playback/recording.	p.17, 23
5		Previous: Select previous chapter or track.	p.23
6		Next: Select next chapter or track.	p.23
7	REC MODE	Record type (quality): To select different qualities of recording (HQ, SP, LP, EP or EP+).	p.17
8	REC	Record: Record from the preselected input.	p.17
9	S-VIDEO	AV3-S IN: Connection of SVHS/Hi8 camcorders or SVHS/Hi8 video recorders.	p.13
10	VIDEO	AV3 IN: Connection of camcorders or video recorders.	p.13
11	L-AUDIO-R	AV3/AV3-S IN: Connection of camcorders or video recorders. This is common audio for both S-Video and Video.	p.13
12	DV IN	Digital video input: To connect a digital camcorder or other suitable device.	p.13
13	CHANNEL -	To select the previous programme number.	p.17
14	CHANNEL +	To select the next programme number.	p.17

Rear Panel

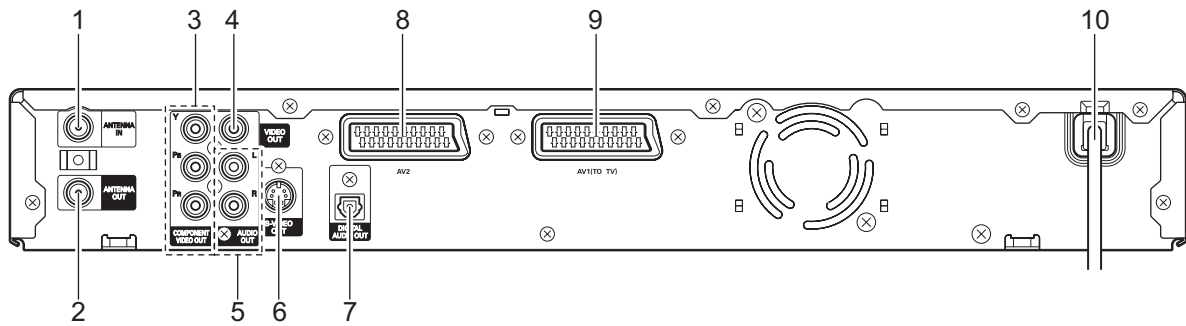

1	ANTENNA IN	Aerial input: Socket into which aerial input is connected.	p.9
2	ANTENNA OUT	Aerial output: Socket from where aerial output is connected to TV set.	p.9
3	COMPONENT VIDEO OUT	Video output: Socket from where YUV (Component Video) output is connected to YUV Video compatible input devices (Progressive scan TV, etc).	p.10
4	VIDEO OUT	Video output: Socket from where Video (Composite Video) output is connected to Video compatible input devices.	p.10
5	AUDIO OUT	Analogue audio output: Socket from where audio output is connected to audio input devices.	p.10, 12
6	S-VIDEO OUT	Video output: Socket from where S-Video output is connected to S-Video compatible input devices.	p.13
7	DIGITAL AUDIO OUT	Digital audio output: Socket into which digital audio input devices can be connected (amplifier/receiver).	p.11
8	AV 2	SCART socket 2: Connect to external equipment.	p.11
9	AV 1(TO TV)	SCART socket 1: Connect to the TV set.	p.9
10	Mains lead	Plug into the power source.	p.14

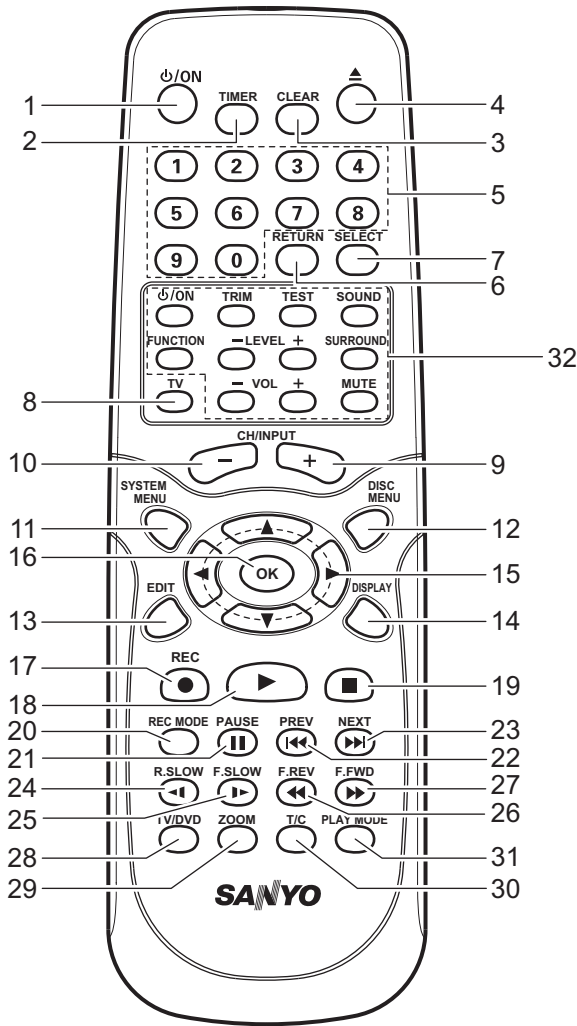

1	⏻/ON	To switch set on or standby, interrupt menu function, interrupt a programmed recording (TIMER).	p.14 p.17
2	TIMER	To program a recording with the Video Plus+ system / without the Video Plus+ system or to alter/clear programmed recordings.	p.18
3	CLEAR	To delete last entry or clear programmed recording (TIMER).	p.21
4	⏮	Open/Close the disc tray.	p.17 p.23
5	0..9	Number buttons: 0 to 9.	p.18
6	RETURN	Return to previous menu on a VCD.	-
7	SELECT	When entering text, press this button to select between uppercase and lowercase characters.	p.30
8	TV	Selects the tuner image built into the DVD recorder.	p.17
9	CH/INPUT +	To select the next programme number.	p.17
10	CH/INPUT -	To select the previous programme number.	p.17
11	SYSTEM MENU	Call up/cancel the System Menu.	p.31

12	DISC MENU	To show the DVD menu or the disc menu.	p.29
13	EDIT	Displays the edit menu for DVD+RW discs, for inserting, deleting and hiding chapters	p.28
14	DISPLAY	To display the status display and the channel / clock display	p.7
15	⏪ ⏩ ⏴ ⏵	Cursor keys: Left, right, up, down navigation keys.	p.15 p.16
16	OK	Applies the details you have selected or entered.	p.14
17	REC ●	Record from the preselected input.	p.17
18	▶	To play back a disc.	p.23
19	■	Stop playback / recording, except with programmed recordings (TIMER).	p.17 p.23
20	REC MODE	To select different qualities of recording (HQ, SP, LP, EP or EP+). Lower the quality of recording higher than the time of recording.	p.17
21	PAUSE 	Pause: If this button is pressed during playback, the playback pauses. You will see a still picture. If this button is pressed during recording, the recording pauses. Each press of this button during a playback pause feeds the video one frame at a time to display still images.	p.23
22	PREV ⏪	With single press of the button during playback, DVD recorder will go back the previous chapter or previous track.	p.23
23	NEXT ⏩	With a single press of the button during playback, the DVD recorder will start playing the next chapter or next track.	p.23
24	R.SLOW ◀	Playback the disc backwards at a slower speed. Each press of the button changes the speed.	p.23
25	F.SLOW ▶	Playback the disc forwards at a slower speed. Each press of the button changes the speed.	p.23
26	F.REV ◀◀	The disc is fast-reversed. Each press of the button changes the speed.	p.23
27	F.FWD ▶▶	The disc is fast-forwarded. Each press of the button changes the speed.	p.23
28	TV/DVD	Press this button to select between DVD recorder images and TV set images.	p.18
29	ZOOM	Enlarge the video image.	p.23
30	T/C	This button evokes the T/C Tools menu, which provides titles, chapters, zoom, angle, slow, search, audio, step, sound and subtitles options.	p.24
31	PLAY MODE	Selects the Play Mode.	p.23
32	Amplifier (Powered subwoofer) controls	Controls amplifier.	*1

*1 Refer to the supplied Subwoofer and speakers instruction manual.

Inserting batteries

Install two "R6 (HP 7)" batteries.

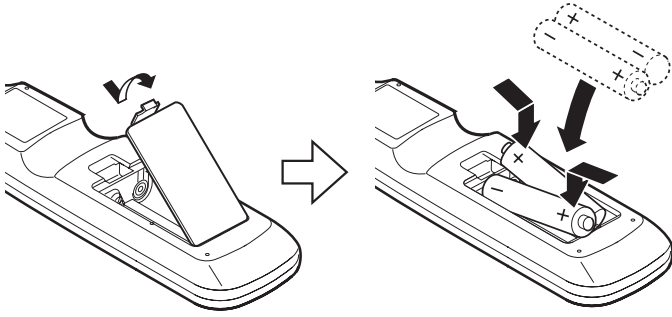

NOTE:

- Remove the batteries if the remote control is not to be used for a month or more. Batteries left in the unit may leak and cause damage.

Remote control range

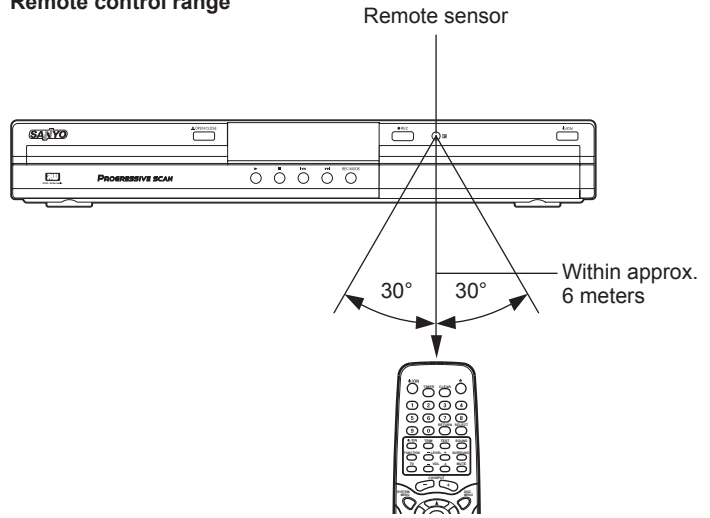

Operation Status Display

Front panel display

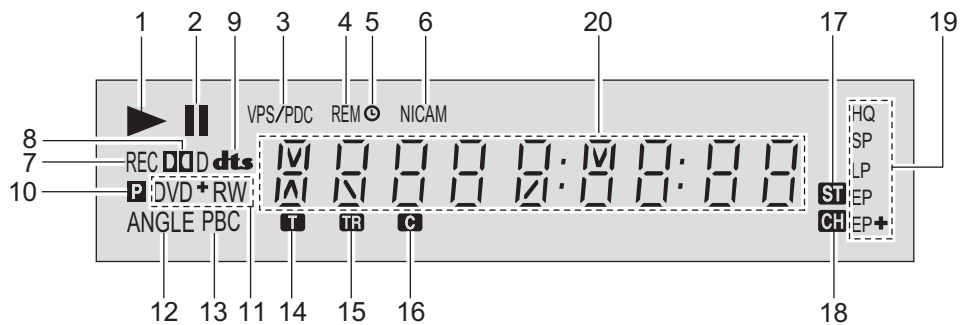

These symbols can light up on your DVD recorder display:

1		Playback in progress.
2		Playback/record interrupted (Pause).
3	VPS/PDC	Video Programming System / Programme Delivery Control: A VPS or PDC code will be transmitted for the selected TV program.
4	REM	Displays the Title/Track time remaining
5		A recording (timer) has been programmed.
6	NICAM	The DVD recorder has detected a Nicam audio signal.
7	REC	Recording in progress.
8		Lights when playing a disc recorded with Dolby Digital Audio.
9	dts	Lights when playing a disc recorded with DTS.
10	P	Lights when progressive video is being output.
11	DVD+RW	Displays the type of DVD disc in the recorder: DVD /DVD+R / DVD+RW.
12	ANGLE	Displays the angle information of the DVD video disc.
13	PBC	Play Back Control.
14	T	Displays the current title number (DVD).
15	TR	Displays the track selected/played (CD).
16	C	Displays the chapter selected/played (DVD).
17	ST	During playback a HiFi/2 channel tone was detected or a HiFi/2 channel tone was received.
18	CH	Channel/programme number.
19	HQ, SP, LP, EP, EP+	Displays the recording quality selected during recording. Recording qualities HQ, SP, LP, EP or EP+ are shown on the recorder display.
20		Multi-function display.

Status display on TV screen

The DVD status is also displayed on the TV screen. The status is displayed in the Status Display and Channel/Clock Display.

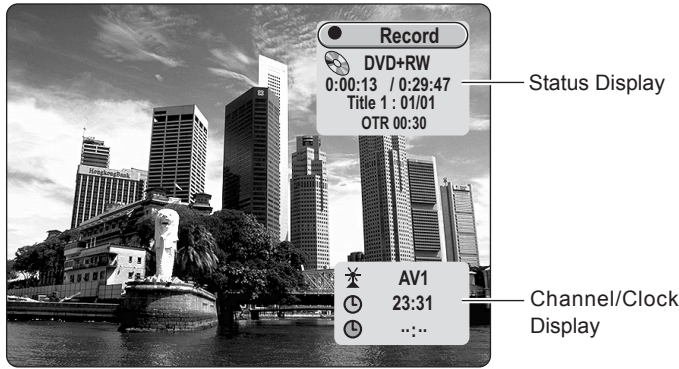

Status Display

When you set "Feature" - "Status Display" at "System Menu" to ON, the Status Display is displayed for several seconds when the DVD is operated.

To display the Status Display all the time, press **DISPLAY**.

Pressing **DISPLAY** while the Status Display is displayed hides the Status Display.

The following information is displayed in the Status Display:

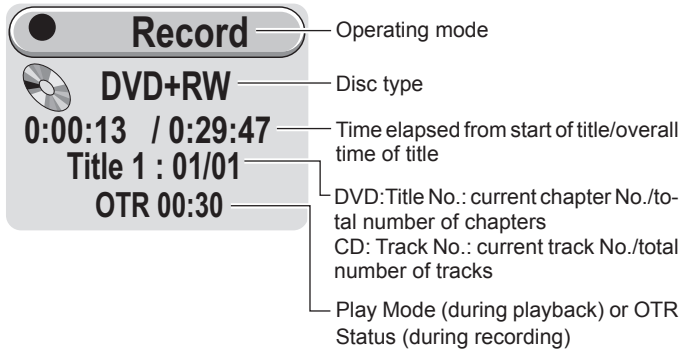

NOTE:

- If an attempt is made to perform an operation that is not supported in the DVD state at this time, "⊘" is displayed to the right of the Status Display.

Channel/Clock Display

The Channel/Clock Display is displayed at the bottom right of the TV screen. Pressing **DISPLAY** on the remote control switches between display/hidden of the Channel/Clock Display.

The following information is displayed in the Channel/Clock Display:

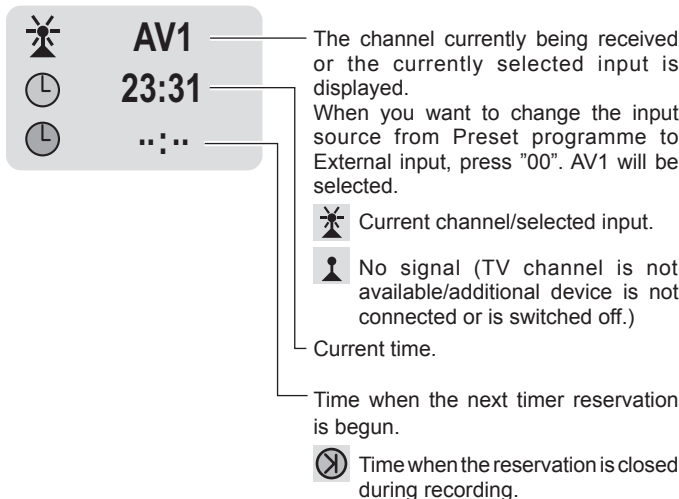

Disc Information

Recordable Discs

Disc Type	Logo Mark
DVD+RW	
DVD+R	

NOTE:

- Even if the type of the discs is DVD+R/RW, the following discs cannot be recorded.
Double Layer discs, High Speed discs of 4X speed or faster.
- Only the above types of discs can be recorded on this unit. DVD-RAM, DVD-RW, DVD-R, CD-R, CD-RW, etc. cannot be recorded.
- Fingerprints and small scratches on a disc can affect recording and/or playback performance. Please take proper care of your discs.
- In some cases, you may not be able to add new recordings to DVD+RWs that contain recordings made on other DVD Recorders or PCs.

Unrecordable pictures

- Pictures with copy protection cannot be recorded on this unit.
- When the unit receives a copy guard signal while recording, the unit cannot record correctly.
- Only Audio input cannot be recorded without entering a Video signal.
- Video games cannot be recorded.

Important Note:

- SANYO takes no responsibility for recording failure due to power cuts, defective discs, or damage to the unit, etc.

Playable Discs

Disc Type	Logo Mark
DVD video	
DVD+RW	
DVD+R	
Audio CD	

NOTE:

- Only the above types of discs can be played on this unit. DVD-Audio, DVD-ROM, DVD-RAM, DVD-RW (VR mode), CD-ROM, CVD, SACD, etc. cannot be played.
- Region number (Regional restriction code) is built-in to the unit and DVD discs. There is a region number on the rear of the unit. DVD video discs having a region code "2" or "ALL" can be played on this DVD recorder.
- The WMA files cannot be played back.
- For MP3, CD, see Page 25.
- For Picture/JPEG CD, see Page 26.
- There are the marks on some DVD disc packages.

Example:
 or Region number

Multiple languages Multi-aspect

Multi-language subtitles Multi-angle

Closed caption

- Some DVD+R/DVD+RWs cannot be played back depending on the recording conditions.
- This unit can play back the DVD-R that has recorded movie data as well. However, some DVD-Rs cannot be played back depending on the recording conditions.
- The DVD-RW (Video mode) can be played back. However, some DVD-RWs cannot be played back depending on the recording conditions. The DVD-RW (VR mode) cannot be played back.
- This unit is to be used exclusively with the PAL (or NTSC) colour system discs. SECAM system discs cannot be used with this unit.

Notes on handling discs

- Do not expose the disc to direct sunlight, high humidity or high temperatures for extended periods of time.
- Discs should be returned to their cases after use.
- Do not apply paper or write anything on the disc surface.
- Handle the disc by its edge. Do not touch the playing surface (glossy side).

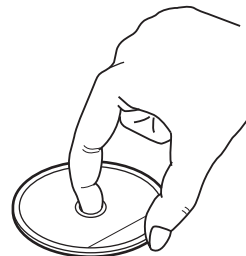

- Fingerprints and dust should be carefully wiped off the playing surface of the disc with a soft cloth. Wipe in a straight motion from the centre to the outside of the disc.
- Never use chemicals such as record cleaning sprays, antistatic sprays or fluids, benzene or thinner to clean discs.

Cleaning discs for high quality recording

Fingerprints and dust should be carefully wiped from the signal surface of the disc (glossy side) with a soft cloth. Wipe in a straight motion from the centre to the outside of the disc.



About Titles, Chapters and Tracks

Title

The longest section of a movie or music feature on DVD. Each title is assigned a title number, enabling you to locate the title you want.

Chapter

Sections of a picture or a music piece on a DVD that are smaller than titles. A title is composed of several chapters. Each chapter is assigned a chapter number enabling you to locate the chapter you want.

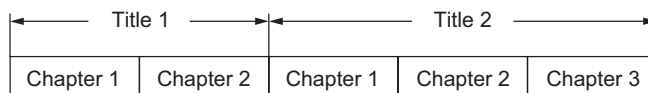

Audio CD discs are divided into tracks. Normally, one song is the equivalent of one track.



This product incorporates copyright protection technology that is protected by method claims of certain U.S. patents and other intellectual property rights owned by Macrovision Corporation and other rights owners. Use of this copyright protection technology must be authorized by Macrovision Corporation, and is intended for home and other limited viewing uses only unless otherwise authorized by Macrovision Corporation. Reverse engineering or disassembly is prohibited.

INSTALLATION, CONNECTION & SETTING THE CHANNEL

NOTE:

- Do not connect the mains lead to an AC outlet until all connections have been made.
- Please refer to the instruction manuals for the equipments that you are connecting (TV, VCR, Subwoofer and speakers, etc.).
- When you connect the unit to your TV and other equipment, be sure to turn off the power and disconnect all of the equipments from the AC outlet until all the connections have been made.

Follow the procedure below to prepare to use the DVD recorder.

- Connect to a TV and various AV equipment. (See pages 9 to 13.)
- ↓
- Start initial setting by connecting the Mains Lead. (See page 14.)
- ↓
- Set the language and initial settings. (See page 14.)
- ↓
- Automatically set the channel. (See page 15.)
- ↓
- Set the clock. (See page 15.)
- ↓
- Manually set the channel. (See pages 15 to 16.)

Connecting to a TV and Various AV Equipment

Connecting to a TV

Aerial and TV connections

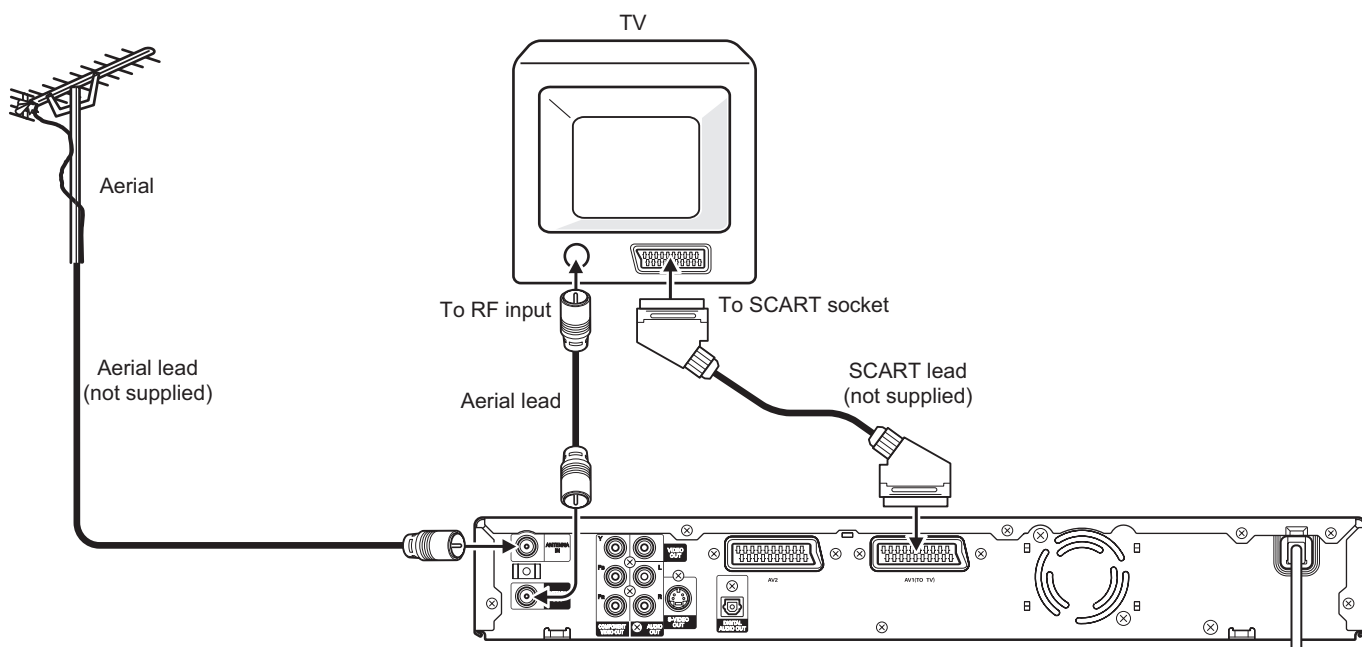

NOTE:

- When the DVD recorder is connected by the SCART socket connector cable, the VIDEO OUT or S-VIDEO OUT socket connection is not necessary.
- Do not connect the aerial and VCR as shown below.



When connecting to a TV without a SCART terminal

Connection without using the SCART socket cable

Connecting to a TV with the audio and video leads.

If your TV has a video input socket, connect the unit as shown.

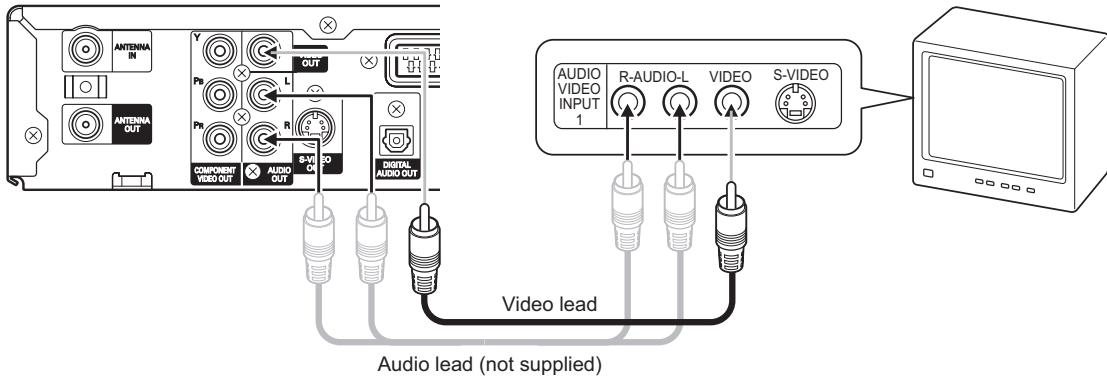

Connecting to a TV with an S-video and audio leads

If your TV has an S-video input socket, connect the unit as shown. You can enjoy clearer picture play. (The VIDEO OUT socket connection is not TV.)

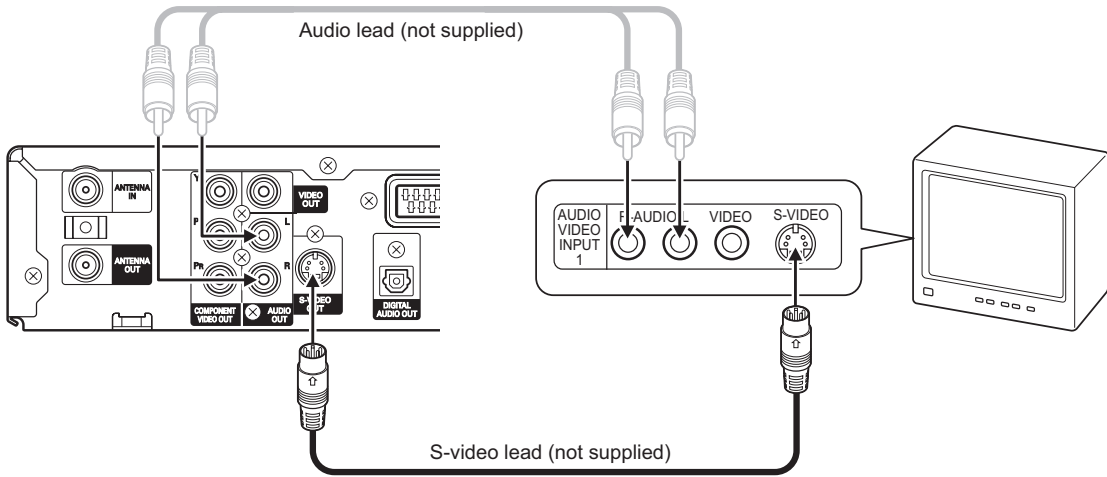

When connecting to a TV with a component video input terminal

If your TV has Component Video inputs, you can enjoy superior picture quality.

Use component cables (not supplied) to connect the COMPONENT output on the unit to the COMPONENT input on the television.

In this configuration, the Red and White audio connections are required.

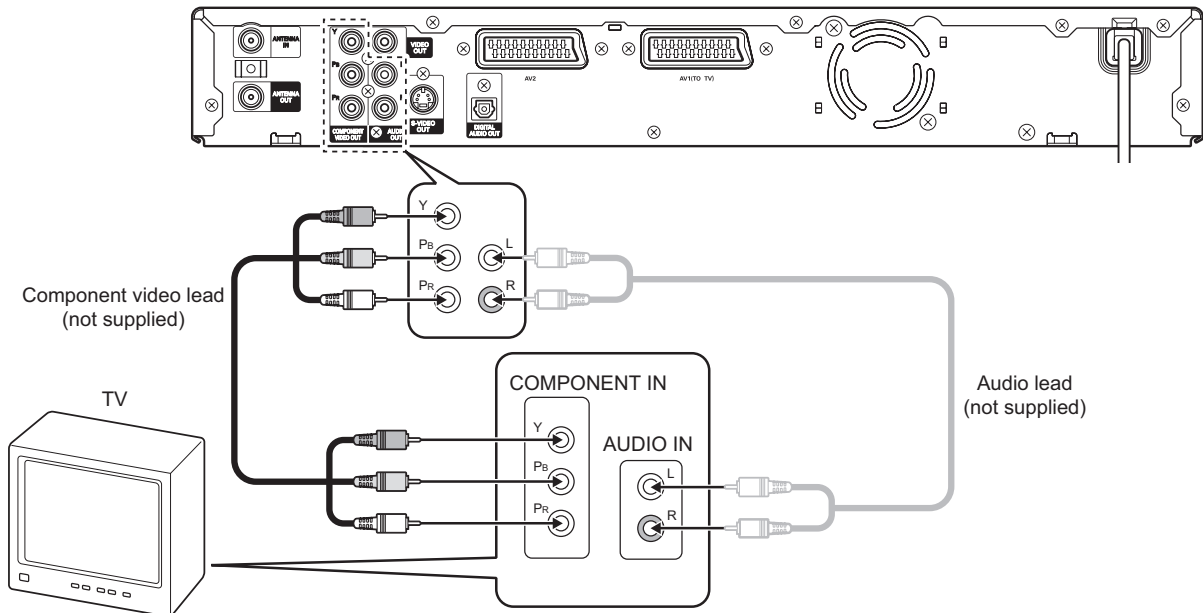

NOTE:

- The DVD recorder DVR-S120 can be used connected to a progressive video-compatible TV or display. In this case, change the YUV Output item from "Interlace" to "Progressive" referring to "TV Screen Settings" at "DVD Recorder Settings". (See page 31.)
- Change Video Output in setting items related to Video in the System Menu to "S-video + YUV" or "Video + YUV". (See page 31.)
- When using component connections, please remove all other video output connections.

Connecting a satellite receiver

For Digital Cable and Satellite TV users please connect your decoder's output to this unit's input.

Use a SCART cable (not supplied) to connect the AV2 (Scart socket) on this unit to the SCART OUT socket on the satellite receiver.

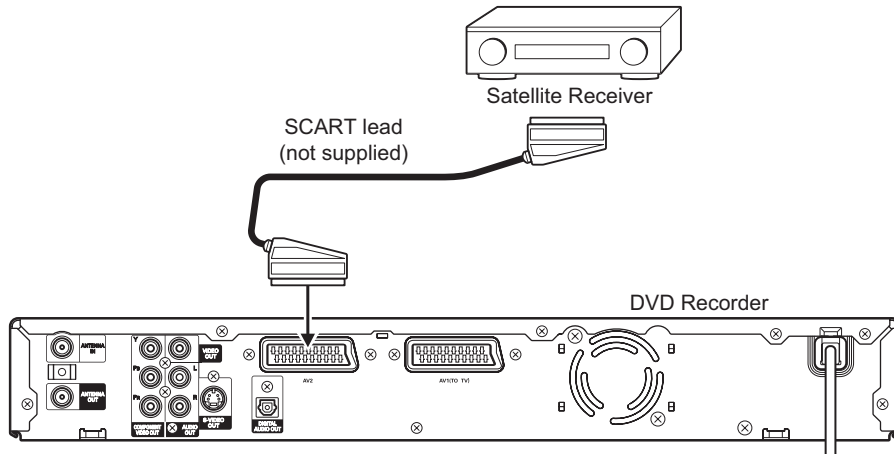

NOTE:

- While viewing the images from the Satellite Receiver on the TV screen, TV images will disappear when DVR-S120 turns on.

Connecting audio equipment

As an alternative to using the TV's speakers, the sound can also be played back through a digital or analog amplifier.

Connecting to a digital audio device

Connect an amplifier with Dolby Digital and DTS decoders to enjoy surround sound.

Use a fiber-optic cable (not supplied) to connect the DIGITAL OUT OPTICAL (digital optical output) on the unit to the digital optical input on a stereo amplifier or a receiver. Before connecting, remove the protective cap on the optical lead plug.

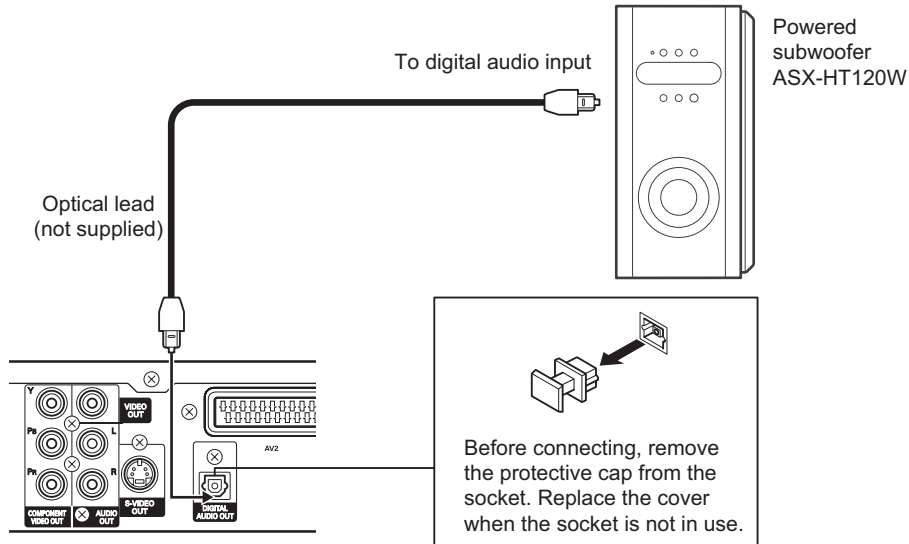

Manufactured under license from Dolby Laboratories.

"Dolby" and the double-D symbol are trademarks of Dolby Laboratories.

"DTS" and "DTS Digital Out" are trademarks of Digital Theater Systems, Inc.

Connecting to a tape deck

Use an audio cord to connect the **AUDIO OUT** on the unit to the audio input on a tape deck.

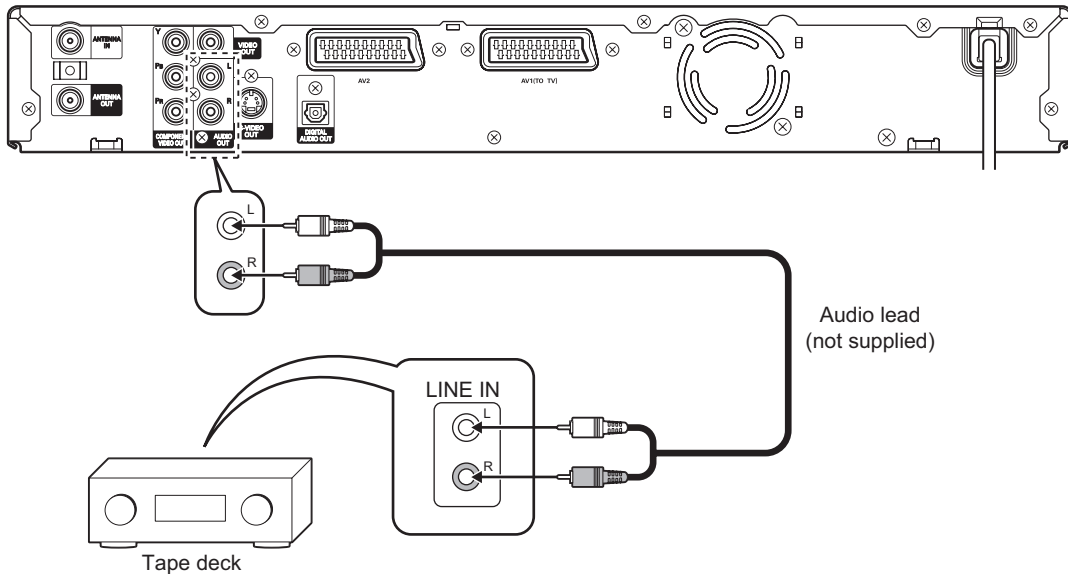

Connecting to a video deck and other recording equipment

Video images from other video equipment can be recorded on the DVD recorder, and video images on the DVD recorder can be recorded on other video equipment.

Connection for recording video images on the DVD recorder to other video equipment

You can use this unit as a source player or as a recording deck.

Connect a VCR or similar recording equipment to the AV2 (SCART), S-VIDEO OUT, or VIDEO OUT sockets.

NOTE:

- When using the AV2(SCART) as a connector, you can only record the contents on a disc when playing back on a DVD recorder, to other recording equipment.

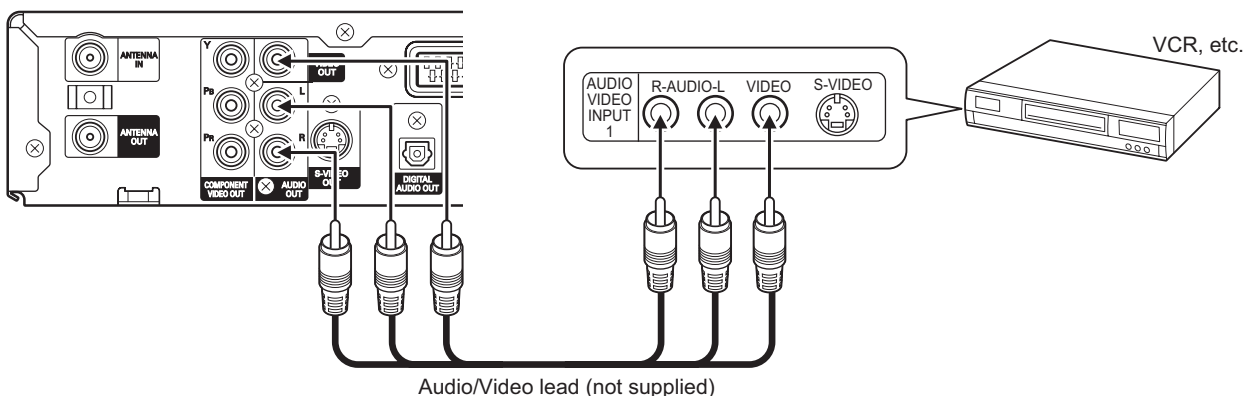
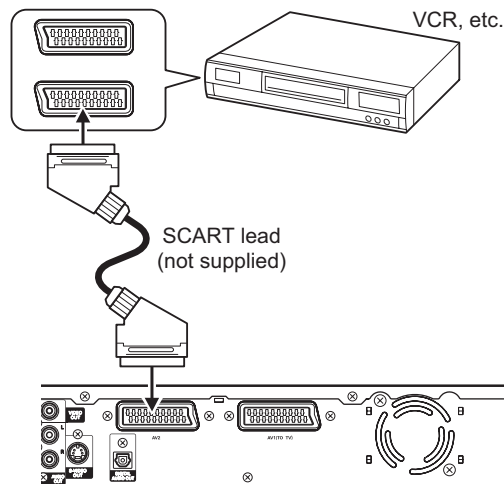

When connecting a VCR, etc. having an S-video terminal, connect by an S-video lead.

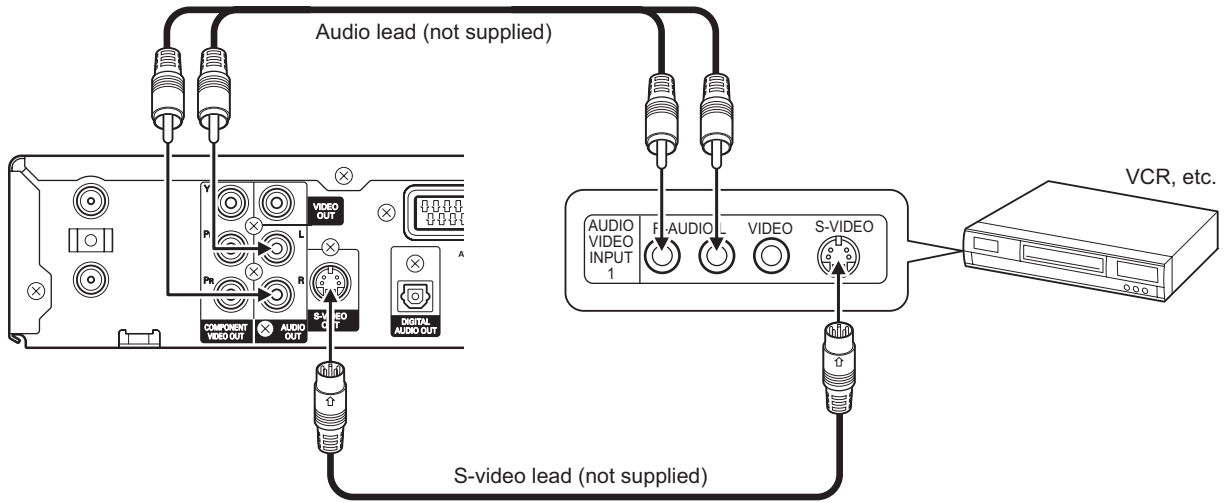

Connection for recording video images from other video equipment on the DVD recorder

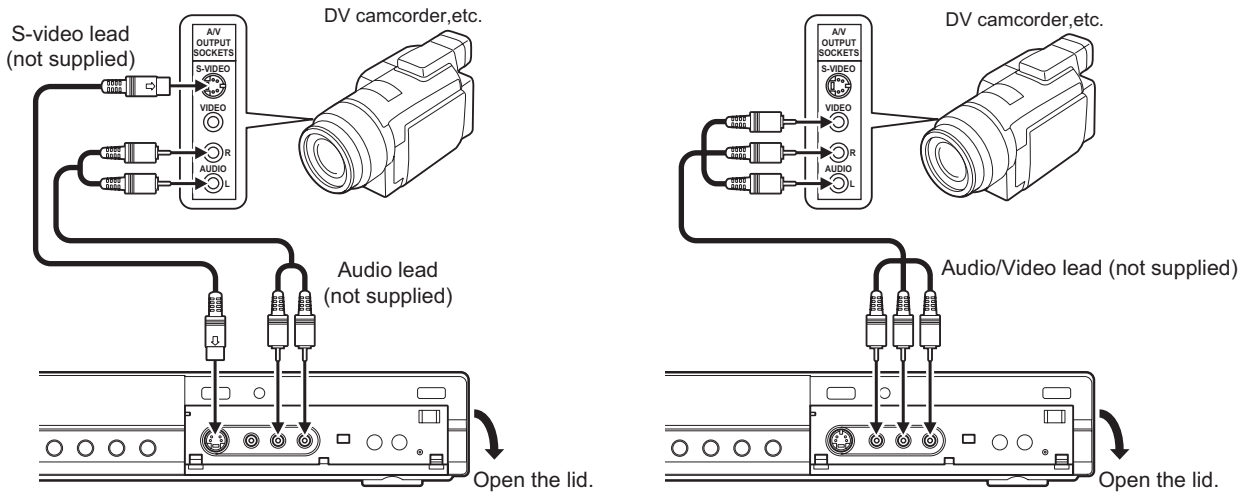

Connecting to a DV camcorder

You can use this unit to record from a DV camcorder when connected with a 4-pin DV lead (not supplied). Connect a DV camcorder or similar recording equipment to this unit as shown.

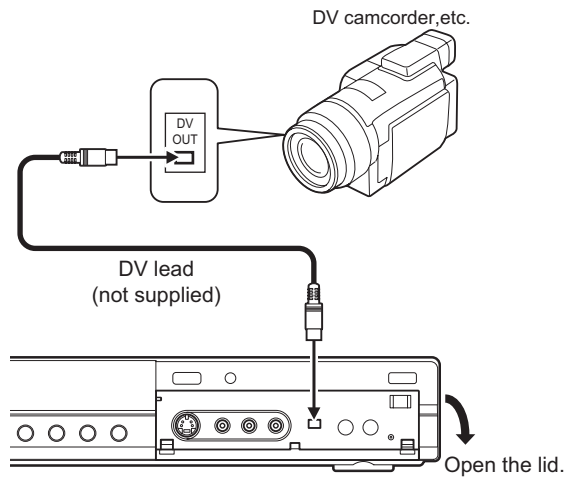

NOTE:

- When a disc tray is opened, DV-IN can not be selected.



Connecting the Main Lead

After all connections have been made, connect the mains lead to an AC outlet.

When the power supply is connected for the first time, the initial setup screen will automatically be displayed.



Follow the on-screen instructions to make the initial settings.

NOTE:







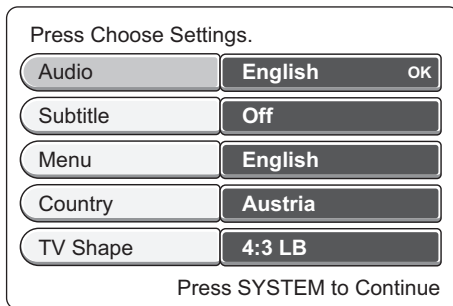

- If the initial setup screen is not displayed, turn the power OFF, and connect the main lead to an AC outlet with the power button /ON held down. Hold down the power button /ON until the setup screen is displayed.
- At the time, turn the power off the other equipment connected to AV2. (When the equipment connected to AV2 is on, the above operation may not work.)





Initial Settings

First, set the language and make the settings on the TV currently connected.

1. Select the item to be changed using  or , and change the settings.

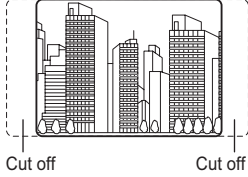

Setting Item	Explanation
Audio	Set the DVD audio language. When you press the OK button, the selection items are displayed. Select the desired item using  or  , and press the OK button.
Subtitle	Set the DVD subtitle language. If subtitle language is not available, the DVD recorder picks the first available language. When you press the OK button, the selection items are displayed. Select the desired item using  or  , and press the OK button.
Menu	Set the menu display language. When you press the OK button, the selection items are displayed. Select the desired item using  or  , and press the OK button.
Country	Choose the country that uses this DVD recorder. When you press the OK button, the selection items are displayed. Select the desired item using  or  , and press the OK button.

Setting Item	Explanation
TV Shape	<p>Set the aspect ratio (shape) of your TV's screen. When you press the OK button, the selection items are displayed. Select the desired item using , and press the OK button.</p> <p>4:3 LB: Select this when a standard size TV is connected. When a wide-screen image (16:9) is played at this setting, black bands (letterboxes) appear at the top and bottom of the screen.</p>  <p>4:3 PS: Select this when a standard size TV is connected. When a wide-screen image (16:9) is played at this setting, the left and right edges of the image are not displayed.</p>  <p>16:9: Select this when a wide-screen TV is connected. Also set the TV to wide screen.</p> 

2. When you have finished the settings, press **SYSTEM MENU** to advance to automatic setting of the reception channel.

Auto-setting the channel

- The following screen is displayed. Check the antenna connection and press the **OK** button.

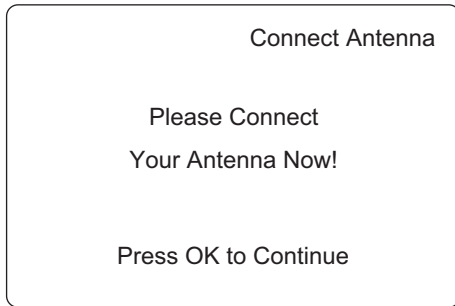

- The automatic TV channel search starts and a progress bar is shown. This allows the DVD recorder to save all available TV channels. This procedure may take several minutes.

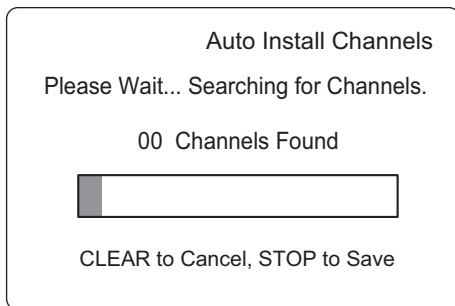

NOTE:

- To cancel automatic setting of the channel, press **■**. Advance to step 3.
- When the bar is displayed to the right side, press **SYSTEM MENU** to advance to the clock setup.

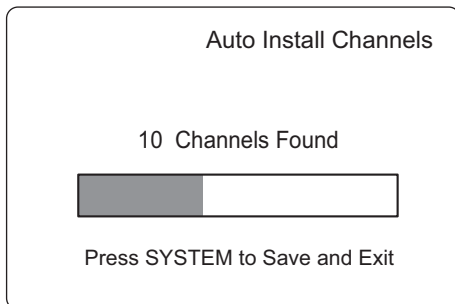

Setting the Clock

- Press **◀** or **▶** to move to the item (Day, Month, Year, Time) to enter, and press the **▲** or **▼**, or 0 to 9 number buttons to set the time.

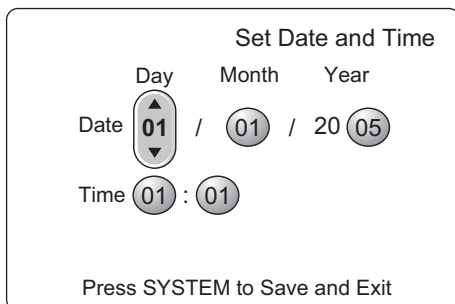

- To end setting, press **SYSTEM MENU**.
Make sure that the time is displayed correctly on the front panel.

NOTE:

- After Clock is set, the power will be turned off(standby) automatically.

Manually Setting the Reception Channel

In some cases, not all of the available TV channels may have been found and stored during initial installation. In this case, you will need to search for and store the missing or coded TV channels manually.

Displaying the channel setup screen

- Turn the TV on and select input from the DVD recorder. (For details on operation methods, refer to your TV's manual.)
- Press **SYSTEM MENU** to display the System Menu.
- Select "Setup" using **▲** or **▼**, and press **▶** once. The setting items at "Setup Options" on the right of the screen can now be selected using **▲** or **▼**.

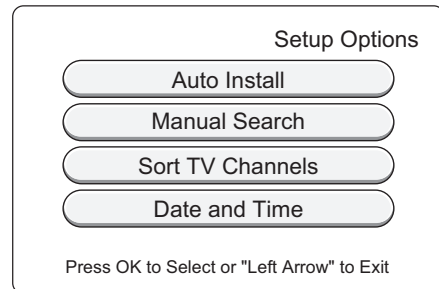

In this screen, set the reception channel by the following procedure.

- | | |
|------------------|--|
| Manual Search | Manual Channel Search, here you can choose and install channels of interest. |
| ↓ | |
| Sort TV Channels | Sorting the TV Channels. |

Manually setting the channel

Perform the following operation in the Setup Option screen.

- Select "Manual Search" using **▲** or **▼** and press the **OK** button.

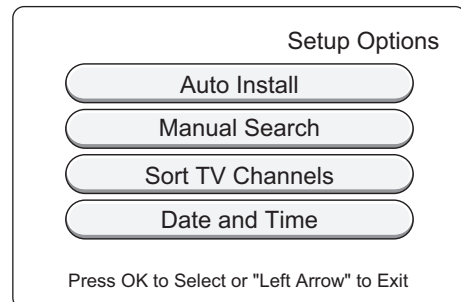

- Specify whether to set the channel by frequency or channel No.

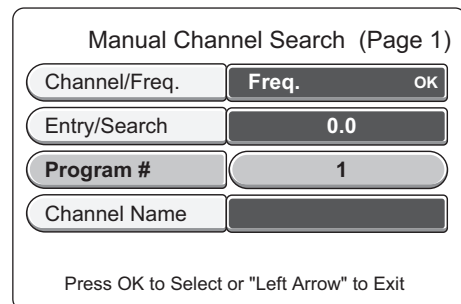

NOTE:

- "**Freq.**": Select this to set the channel by frequency.
- "**Program**": Select this to set the channel by channel No.
- "**S-Channel**": Select this to set the channel by special channel when you are using your TV with cable TV, for example.

- The search for channels that can be received begins from the smallest frequency or channel No. of the channel displayed at "Entry/Search" and increases upwards to larger values.
When the desired channel is found, changing of the number value comes to a stop. Press ▼ to advance to the "Programme #" item.
- At the "Programme #" item, specify which channel on the TV the reception channel specified in step 3 is to be viewed.
Using ◀ or ▶ in "Programme #", select the programme number you want to use for the TV channel, e.g. "01".

NOTE:

- Programmes cannot be reserved correctly if you do not make the correct settings.
- Enter the name of the channel to display on the TV screen. Select the "Channel Name" item using ▲ or ▼, and press the **OK** button.
Decide on the position to enter the text using ◀ or ▶, and enter text using ▲ or ▼.
When you have entered the name, press the **OK** button.
 - When you press **NEXT ▶▶** with the "Channel Name" item selected, the following screen is displayed. Select the item to be changed using ▲ or ▼, and change the settings.

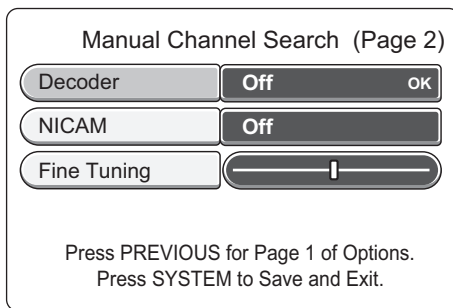

Decoder	Sets whether or not to use a decoder to receive this channel. When you press the OK button, the selection item is displayed. Select the desired item using ▲ or ▼, and press the OK button.
NICAM	Sets whether or not to select NICAM. When you press the OK button, the selection item is displayed. Select the desired item using ▲ or ▼, and press the OK button.
Fine Tuning	After pressing the OK button, fine-tune the reception state using ◀ or ▶ while viewing the TV screen. When you have finished adjusting, press the OK button.

NOTE:

- When you press **PREV ◀◀**, the screen returns to "Manual Channel Search (Page 1)". In this screen, you can change the details you are currently setting.
- Press **SYSTEM MENU** to save the settings, and return to the Setup Options screen.
 - Repeat steps 1 to 7 of this procedure for all of the channels you want to set.

Arranging and Deleting Channels

After you have performed the automatic channel search, you may not agree with the sequence in which the individual TV channels have been allocated to the programme positions (programme numbers). You can use this function to rearrange the TV channels already stored or to delete TV channels you do not want or those with poor reception.

NOTE:

- The teletext clock resets automatically.
If you store a TV channel which transmits TXT/PDC on programme number "P01", the date and time will automatically be transmitted and constantly updated. As a result, the changes from summer time to winter time and back again will be made automatically.

Perform the following operation in the Setup Option screen.

- Select "Sort TV Channels" using ▲ or ▼ and press the **OK** button.

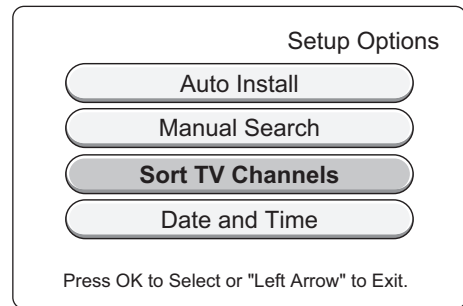

- The following screen will be displayed. In this screen, arrange or delete channels.

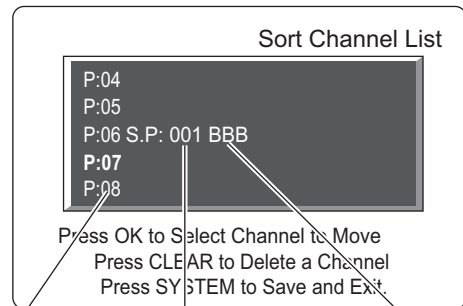

Program# Reception channel Channel name

Rearranging the order of channels

First of all, select the channel you want to re-arrange using ▲ or ▼, and press the **OK** button.

Next, move to the position where you want to move the channel to using ▲ or ▼, and press the **OK** button. This re-arranges the order of the channel.

Deleting TV channels

You can delete channels you do not want to receive. Select the desired channel using ▲ or ▼, and press **CLEAR**.

- Repeat step 2 for all of the channels you want to change.
- When you have finished changing the settings, press **SYSTEM MENU** to save the settings.

RECORDING

Recording Programmes during Reception

1. Turn the TV on and select input from the DVD recorder. (For details on operation methods, refer to your TV's manual.)
2. Press **ON** button. (It takes time to enter the condition the power supplied.)
3. Press **▲OPEN/CLOSE** to open the disc tray, and place the disc with the label facing up on the disc tray.

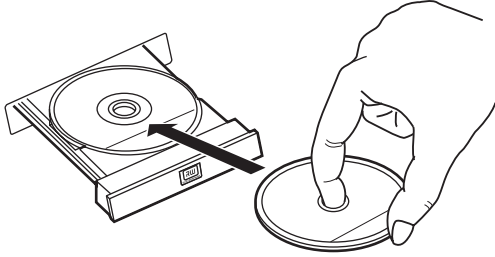

3. Press **▲OPEN/CLOSE**.

The disc tray closes, and "READING" is displayed on the front panel to indicate that the disc is being checked. If a disc ready for recording has been loaded, the display on the front panel or on the TV screen changes as follows.

"NO DATA" on front panel	This is displayed for a brief flash when an empty new disc is loaded.
Index screen is displayed on TV and final line becomes "Empty Title"	You have loaded an already recorded DVD+RW disc, or an already recorded DVD+R disc that has not been finalised.

NOTE:

- When the menu contained on the disc is displayed or playback starts, this means that the disc is not recordable. Reload with a recordable disc.
 - When "No More Titles Available" is displayed, this means that titles (including empty titles) exceeding 48 have been saved to disc. Either delete titles, or replace the disc.
5. When the disc menu is displayed, move to "Empty Title" by **▲** or **▼**, and make sure that there is enough free space on the disc.

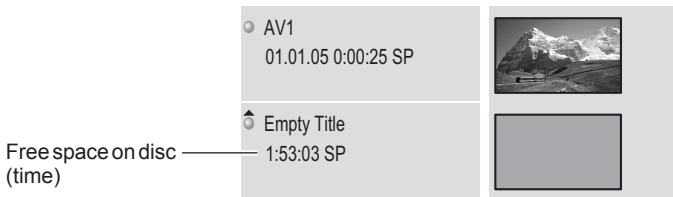

NOTE:

- When a blank disc is inserted, the Disc Menu is not displayed on the TV screen. The TV screen returns to the screen of the broadcasting station that was being received or the currently selected external input. Proceed to the next step 6 as it is.
- With DVD+RW discs, you can also overwrite titles that have already been recorded to disc. For details on overwrite recording, see "Inserting New Recording on a DVD+RW" on page 22.

6. Repeatedly press **REC MODE** to specify the recording mode (picture quality).

HQ	High Quality	About 60 minutes can be recorded to disc (4.7GB).
SP	Standard Play	About 120 minutes can be recorded to disc (4.7GB).
LP	Long Play (S-VHS quality)	About 180 minutes can be recorded to disc (4.7GB).
EP	Extended Play (better than VHS quality)	About 240 minutes can be recorded to disc (4.7GB).
EP+	Extended Play (VHS picture quality)	About 360 minutes can be recorded to disc (4.7GB).

7. Press **TV** to switch to the DVD recorder tuner.
8. Press **CH/INPUT +** or **-** to select the channel to record.
9. Press **REC** to start recording. During recording, the following information is displayed on the front panel.

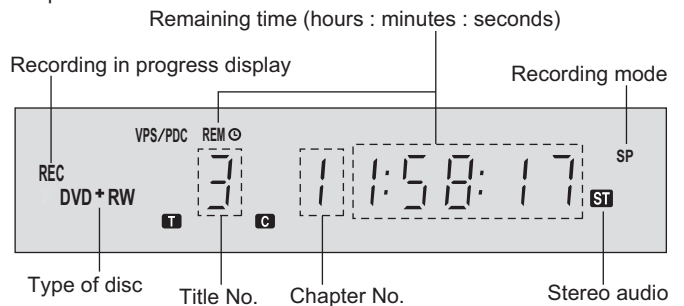

Cancelling (pausing)/resuming recording

When you press **PAUSE** during recording, recording is paused, and "Pause Rec" is displayed on screen.

Use this feature, for example, to prevent commercials from being recorded.

To resume recording, press **REC**.

Marking screens during recording

During recording it is possible to mark scenes that you want to see or hide later. During recording press **EDIT** at the relevant location. The screen displays "Inserting Chapter Marker". The "CHAPTER" number is increased by one in the Status Display. Press **DISPLAY** to display the Status Display on the screen.

Ending recording

Press **■** to end recording.

When a recording is made to disc, the following additional information is also stored at the beginning of the recording:

- Name of the recording. If the TV station does not transmit a name, only the channel number and time will be stored as the name
- Length of the recording
- Record type (Quality)
- Date of the recording
- Index picture of the recording

When recording is ended, this information is displayed in the index screen.

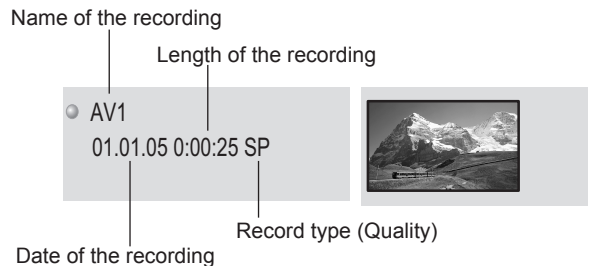

To One Touch Recording (OTR)

The power can be automatically turned off after recording for the specified time without setting timer recording. DVD recorder will automatically switch off after ending recording.

When you press **REC** during recording, you can increase the recording time 30 minutes at a time. The DVD recorder will automatically switch off after recording ends.

NOTE:

- OTR does not work when there is not 30 minute's worth of recordable space.
- To cancel the recording time that you have set repeatedly press **REC** until the time at the bottommost line of the Status Display is no longer displayed.
- When the disc runs out of free space during recording, the setting for automatically turning the switch off after recording ends becomes invalid, and the power cannot be turned off.
- To cancel the recording time that you have set Press **CLEAR** while the recording time is displayed.

To watch the TV during recording

To watch TV on the TV tuner while the programme is being recorded, press the **TV/DVD** button to switch to the TV tuner so that you can watch the TV programme.

NOTE:

- The TV switch can be turned off if you are not going to watch TV during recording.

Timer Recording

This feature allows you to automatically record at a specified date and time. Up to eight reservations can be made on the DVD recorder.

There are two timer recording modes, timer recording by "Video Plus+ code" and timer recording by entering a programme No. and recording date and time.

VIDEO Plus+ and PlusCode are registered trademarks of Gemstar Development Corporation. The VIDEO Plus+ system is manufactured under license from Gemstar Development Corporation.

NOTE:

- Set the DVD recorder's clock in advance.

Timer recording by "Video Plus+ code"

Most TV programmes can be recorded easily in the recording screen by the nine-digit Video Plus code assigned to that program. As the information to be set for timer recording is contained in the Video Plus+ code, there is no need to enter a date, programme No., and start and end times.

1. Turn the TV on and select input from the DVD recorder. (For details on operation methods, refer to your TV's manual.)
2. Press **TIMER** to display the TIMER screen.
3. Select "Video Plus+" using **▲** or **▼**, and press the **OK** button.

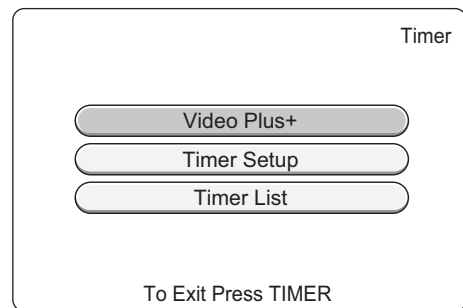

4. Input the recording timer information.

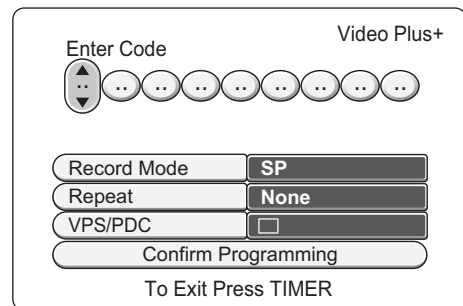

Code	Enter the Plus Code with ▲ or ▼ or with the number buttons 0 to 9. This number can be found next to the start time of the TV programme in your TV listings magazine. e.g.: 5-312-4 or 5 312 4.
Record mode	Select the recording mode (picture quality). When you press the OK button, the menu is displayed. Select the desired recording mode using ▲ or ▼ .
Repeat	When you press the OK button, the menu is displayed. Choose "None" using ▲ or ▼ . "Mo-Fr" : Repeated daily recordings from Monday to Friday. "Weekly" : Repeated weekly recordings (every week on the same day). NOTE: <ul style="list-style-type: none"> - When the timer preset with Video+ code, "Mo-Fr" and "Weekly" timer programme can not be selected.
VPS/PDC	Select this setting when using VPS/PDC. Each press of the OK button selects or deselects this setting.

NOTE:

- What is "VPS/PDC?"
"VPS" (Video Programming System) and "PDC" (Programme Delivery Control) are mechanisms for controlling start of recording and the continuation time according to signals that arrive from the TV station. These control mechanisms allows reserved programmes to be recorded on time even if programmes start earlier or later than the reserved scheduled times.
The times listed in TV guides are either VPS or PDC times.
To start recording at times different from "VPS/PDC", turn "VPS/PDC" off.
 - VPS/PDC features are enabled for individual programmes to be recorded. To continuously record two or more programmes by "VPS/PDC" on a certain channel, reserve each recording individually.
5. Move to the "Confirm Programming" item using ▲ or ▼, and press the **OK** button.

6. The "Timer Setup" screen is displayed. Move to the "Confirm programming" item using ◀ or ▶, and press the **OK** button.

7. The "Timer List" screen is displayed. Check the reserved details.

Date	Ch.	Start / End	Mode	VPS/PDC
07/04	AV2	21:00/23:00	SP	<input checked="" type="checkbox"/>
../.:..:..:..	..	<input type="checkbox"/>
../.:..:..:..	..	<input type="checkbox"/>
../.:..:..:..	..	<input type="checkbox"/>

Insert Recordable Disc and Press /ON to Start Recording

NOTE:

- To change the reserved details, select the line to change using ▲ or ▼, and press the **OK** button. (When making the 5th reservation onwards, the second page of the reserved details list is displayed by repeatedly pressing ▼.) The display returns to the "Timer Setup" screen. Here, set the reserved details again.
- Select a line that has not been entered, and press the **OK** button. The display returns to the "Timer Setup" screen. Here, you can reserve a different programme.
- Reservations can also be deleted. For details on operation methods, see page 21.

8. Press **TIMER** to return to the "Timer" screen, and press **TIMER** again to end timer recording. The timer programme recording time is displayed on the Channel/Clock Display.

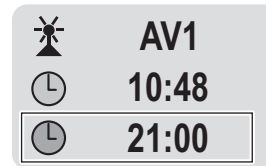

9. Load a DVD+R/RW (unprotected) ready for recording.

NOTE:

- Load a disc with enough free space for recording the programme.
10. Press /ON to turn the DVD recorder off.
Recording is automatically started when the timer reaches the recording time.

NOTE:

- lights on the front panel to indicate that the DVD recorder is set for timer recording.

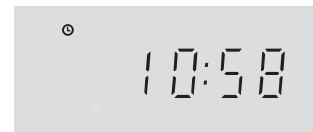

- When there is not enough free space for recording the entire programme on the disc, the programme will be recorded to free space, and recording will end halfway through the programme.

Timer recording without using "Video Plus+ code"

1. Turn the TV on and select input from the DVD recorder. (For details on operation methods, refer to your TV's manual.)
2. Press **TIMER** to display the **TIMER** screen.

NOTE:

- When the clock has not been set, the "Set Date and Time" screen will be displayed. Move the entry item using **▲** or **▼**, set the clock using **▲** or **▼**, or the 0 to 9 number buttons, and press **SYSTEM MENU**. (For details on operation methods, see page 15.)

3. Select "Timer Setup" using **▲** or **▼**, and press the **OK** button.

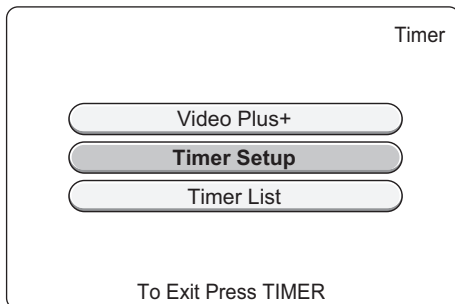

4. Move to the item to enter using **◀** or **▶**, and enter the information for recording.

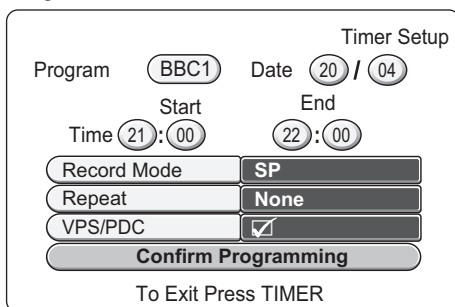

Program	Select the channel or input using ▲ or ▼ .
Date	Enter information with ▲ or ▼ or with the number buttons 0 to 9.
Start Time	Enter information with ▲ or ▼ or with the number buttons 0 to 9.
End Time	Enter information with ▲ or ▼ or with the number buttons 0 to 9.
Record Mode	Select the Record Mode. For details on the type of Record Mode, see page 17.
Repeat	Select either of the following to repeatedly record the same programme. When you press the OK button, the menu is displayed. Select the desired setting using ▲ or ▼ . "Mo-Fr" : Repeated daily recordings from Monday to Friday. "Weekly" : Repeated weekly recordings (every week on the same day).
VPS/PDC	Select this setting when using VPS/PDC. Each press of OK selects or deselects this setting.

NOTE:

- For details on the "VPS" (Video Programming System) and "PDC" (Programme Delivery Control)," see page 19.

5. Move to the "Confirm Programming" item using **▲** or **▼**, and press the **OK** button.

The "Timer List" screen is displayed. Check the reserved details.

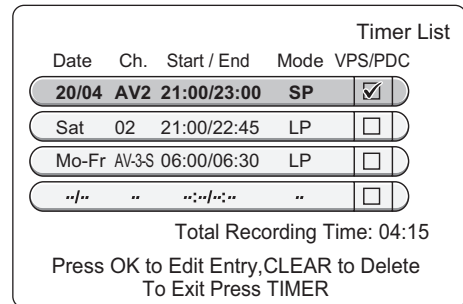

NOTE:

- To change the reserved details, select the line to change using **▲** or **▼**, and press the **OK** button. (When making the 5th reservation onwards, the second page of the reserved details list is displayed by repeatedly pressing **▼**.) The display returns to the "Timer setup" screen. Here, set the reserved details again.
- Select a line that has not been entered, and press the **OK** button. The display returns to the "Timer setup" screen. Here, you can reserve a different programme.
- Reservations can also be deleted. For details on operation methods, see page 21.)

6. Press **TIMER** to return to the "Timer" screen, and press **TIMER** again to end timer recording.

NOTE:

- **Ⓞ** lights on the front panel to indicate that the DVD recorder is set for timer recording.

7. Load a DVD+R/RW (unprotected) ready for recording.

NOTE:

- Load a disc with enough free space for recording the programme.

8. Press **⏻/ON** to turn the DVD recorder off. Recording is automatically started when the timer reaches the recording time.

NOTE:

- When there is not enough free space for recording the entire programme on the disc, the programme will be recorded to free space, and recording will end halfway through the programme.

Checking, Changing and Deleting Reservations

1. Turn the TV on and select input from the DVD recorder. (For details on operation methods, refer to your TV's manual.)
2. Press **TIMER** to display the TIMER screen.
3. Select "Timer List" using **▲** or **▼**, and press the **OK** button.

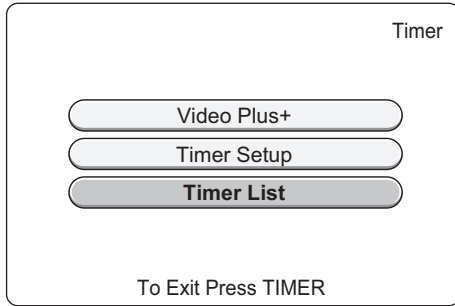

4. The "Timer List" screen is displayed. Check the reservation details. If necessary, change, delete, or make new reservations.

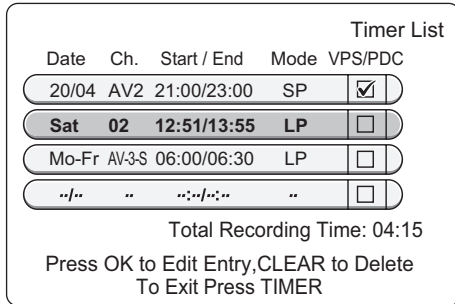

To change a reservation

Select the line to change using **▲** or **▼**, and press the **OK** button. The "Timer Setup" screen is displayed. Set the reservation details again. (For details on operation methods, see page 20.)

To delete a reservation

Select the line to delete using **▲** or **▼**, and press the **CLEAR** button. The "Timer Delete" screen is displayed. Select "OK to Delete Timer" and press the **OK** button.

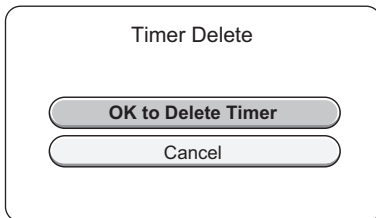

To make a new reservation

Select a free line, and press the **OK** button. The display returns to the "Timer Setup" screen. In this screen, you can reserve a different programme.

1. Press **TIMER** to return to the "Timer" screen, and press **TIMER** again. This ends checking of reservations.

Problem solving for programmed recordings

The following problems/error messages appears on the screen while operating the DVD recorder. Possible solutions are provided in this section:

Error Message	Solution
Insert Recordable Disc and Press ⏻/ON to Start Recording	A write-protected disc has been inserted. Cancel the protection (See "To cancel disc protection" page 30) or insert a different disc.
Invalid Setup, please correct	The data for the recording could not be transferred. Please check the date, start time and end time of the programmed recording.
Timer Overlaps Existing Timer	The information for two programmed recordings overlap. If you ignore this error message the TV programme with the earlier start time will be recorded first. You will miss the start of the second programme. Change the information for one of the recordings or delete one of the recordings.

Warning	Solution
Timer Recording! Press ⏻/ON to Start Recording.	The DVD recorder was switched on several minutes before the start of a programmed recording. Switch off the DVD recorder with ⏻/ON . A programmed recording (timer) will only function if the DVD recorder is switched off (button ⏻/ON).

Recording Video from Other AV Equipment

Video output from video cameras and other AV equipment can be recorded on the DVD recorder.

NOTE:

- Prepare other AV equipment in advance, and prepare the equipment for playback. ("Connecting to a video deck and other recording equipment" page 12)
 - Only Audio input cannot be recorded without entering a Video signal.
 - Almost all videos and DVD software on sale have copy-protection. You cannot record them using this unit.
 - Video games cannot be recorded.
1. Turn the TV on and select input from the DVD recorder. (For details on operation methods, refer to your TV's manual.)
 2. Press **▲OPEN/CLOSE** to open the disc tray, and place the disc with the label facing up on the disc tray. Press **▲OPEN/CLOSE** to close the disc tray.
 3. When the disc menu is displayed for DVD+RW discs, either move to "Empty Title" using **▲** or **▼**, or specify a position when overwriting an already recorded program.

NOTE:

- For details on how to specify the overwrite recording position, "Inserting New Recording on a DVD+RW" (See page 22).
4. Press **REC MODE** to specify the recording mode (picture quality).
 5. Press **CH/INPUT +** or **-** to select the input from the AV equipment to record.

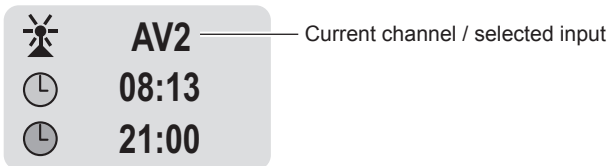

6. Start playback on the other equipment.
7. Press the TV buttons to display the video from the other equipment on the TV screen.
8. Press **REC●** to start recording.

Inserting New Recordings on a DVD+RW

With DVD+RW discs, you can specify a video title already recorded to disc and overwrite that title. Note, however, that if you overwrite with content that is longer than the previously recorded content, other following content will also be overwritten.

1. Select the title on the disc menu.
2. Press the **OK** button to play the title.
3. Find where you want to insert the new recording.
4. Press **■** at the position where the new recording to go.
5. Press **REC MODE** to select the record mode. Start recording as usual by pressing **REC●** on the remote control.
6. The "Title Overwrite" screen is displayed. Select "OK to Overwrite Title" and press the **OK** button.

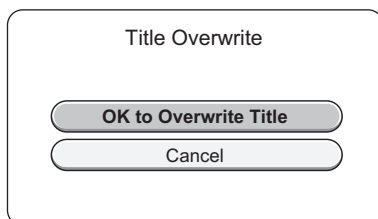

The new recording will be inserted.

7. Stop recording with **■**.

SAT Record (Automatic recording from Satellite Receiver)

In the case of equipment (e.g. satellite receiver) connected to the AV2 Scart terminal on the rear panel on which timer recording is possible, video can be recorded synchronized with the start of the broadcast without having to reserve recording on the DVD recorder.

NOTE:

- To use this feature, the "SAT Record" setting item for recording in System Menu must be set in advance.
- Press **SYSTEM MENU** to display the System Menu. Make sure that the "Recording" item is set to "AV2" using **▲** or **▼**.

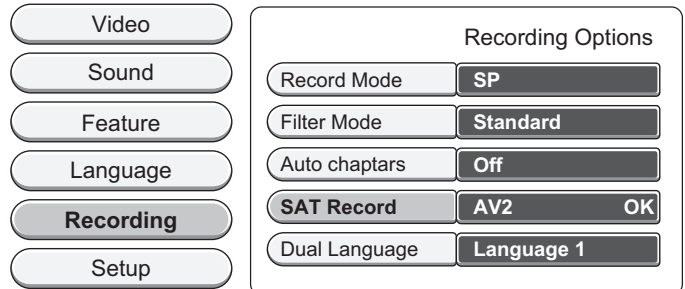

If this item is not set, see "Recording Settings" on page 34.

Reserve recording on the AV equipment connected to the AV2 Scart terminal, and set the satellite tuner ready for recording.

DISC PLAYBACK

Basic Operations

1. Turn the TV on and select input from the DVD recorder. (For details on operation methods, refer to your TV's manual.)
2. Press **⏻/ON** button. (It takes time to enter the condition the power supplied.)
3. Press **▲OPEN/CLOSE** to open the disc tray.
4. Place the disc with the label facing up on the disc tray.

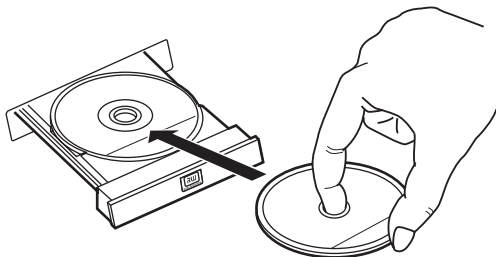

5. Press **▲OPEN/CLOSE** or **▶**.
The disc tray closes. The disc is then read, and playback automatically starts.
 - While the disc is being read, "READING" is displayed on the front panel.
 - During playback, the elapsed time is displayed on the front panel.

When playback does not automatically start

Press **▶** to start playback.

When the menu is displayed

Select the desired programme to play back by **◀, ▶, ▲, ▼**, and press the **OK** button.

Stopping playback

Press **■** to stop playback.

When you press **▶**, the disc is played from the position when playback was stopped.

NOTE:

- When the **■** button is pressed and held down, "Progressive" as the TV screen setting will be changed to "Interlace" without System Menu operation. See "TV Screen Settings" on page 31.

Temporarily stopping playback (pause)

Press **⏸** to pause playback.

To resume playback, press **▶**.

Skipping chapters/returning to the start of chapters

With DVD titles, the content of a single title is divided into several blocks called "chapters."

When you press **NEXT ▶▶** during playback or a pause, playback of the next chapter is started.

When you press **PREV ◀◀** during playback or a pause, the disc returns to the start of the present chapter, and playback is started.



Fast-forward/fast-reverse

When you press **F.FWD ▶▶**, the disc is fast-forwarded. Each press of **F.FWD ▶▶** changes the fast-forward speed.

When you press **F.REV ◀◀**, the disc is fast-reversed. Each press of **F.REV ◀◀** changes the fast-reverse speed.

To return to normal playback, press **▶**.

Playing back in slow motion

When you press **F.SLOW ▶▶**, the disc is slow-forwarded. Each press of **F.SLOW ▶▶** changes the slow-forward speed.

When you press **R.SLOW ◀◀**, the disc is slow-reversed. Each press of **R.SLOW ◀◀** changes the slow-reverse speed.

To return to normal playback, press **▶**.

Viewing from a desired camera angle

Some DVD-Video discs may contain scenes which have been shot simultaneously from a number of different camera angles.

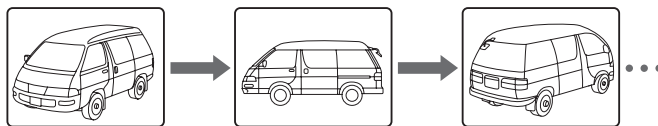

The jacket or case of discs that are recorded with angles will be marked.

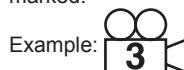

In the case of discs that allow the camera angle to be selected, the angle selection menu will be displayed for several seconds at the beginning. The camera angle can be changed by pressing **▲** or **▼** while this menu is displayed.

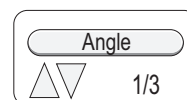

After this menu disappears, if you want to change the camera angle again, see "Various Playback Operations Using T/C Tools" on page 24.

Repeat Playback

Each press of the **PLAYMODE** button during playback displays the playback modes. Press the **OK** button to select the desired playback mode.

Playback Mode	Explanation
Repeat Chapter	Repeats the chapter currently being played.
Repeat Title	Repeats all chapters.
Repeat A-B	Repeats only a specified section.
(None)	Select this to cancel the PLAY MODE setting. (The setting is cancelled even if you do not press the OK button.)

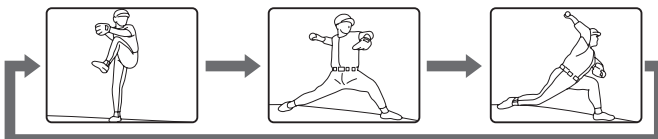

To select a specified section, press the **OK** button at the repeat start point (A). The display changes to Repeat B. Press the **OK** button again at the repeat end point (B).

Picture zoom

Press **ZOOM** during normal/slow playback or still picture. The central part of the picture is magnified, and "ZOOM X 1" appears on the TV screen. Each time you press **ZOOM**, the zoom mode will be changed as follows:

ZOOM X 1 → ZOOM X 1.3 → ZOOM X 2 → ZOOM X 4 → ZOOM OFF

Press **◀, ▶, ▲** or **▼** to change the zoom point.

To return to normal playback, repeatedly press **ZOOM** until the zoom ratio display at the bottom of the screen disappears.

NOTE:

- Picture zoom may not work on some discs.

Various Playback Operations Using T/C Tools

When you press **T/C** during playback or while playback is paused, the "T/C Tools" menu is displayed.

Select the menu item using **▲** or **▼** and set the desired feature according to the description in the following table.



Menu Item	Explanation of Operation
Title	To play back a title, press the number buttons or ◀▶ to specify the number of the desired title to playback.
Chapter	To play back a chapter, press the number buttons or ◀▶ to specify the number of the desired chapter to playback. This feature also allows you to play back chapters that are set to "hide" by the disc management features. The "hide" setting can be changed to "display" during playback. (See page 28.)
Zoom	Zooms in on images. Each press of OK switches the zoom ratio.
Angle	Press ◀▶ to switch the camera angle.
Slow	Each press of ◀▶ switches the slow motion playback speed.
Step	Displays video one frame at a time. ◀ displays the previous frame, and ▶ displays the next frame.
Search	Specifies the time (hours : minutes : seconds) and plays back from that time. When you press the OK button, the frame for entering the time is displayed. Move to the desired digit by ◀▶ , and press the number button to specify the time. Press the OK button. Playback starts from the specified time.
Audio	Press ◀▶ to switch the DVD audio language. Switching the audio language is enabled while the disc is being played. (Specify the audio language to use at all times at "System Menu".)
Subtitles	Press ◀▶ or number buttons to switch the DVD subtitle language. Switching the subtitle language is enabled while the disc is being played. (Specify the subtitle language to use at all times at "System Menu".)
Sound	Press ◀▶ to switch audio output from the analogue audio output terminal to Stereo or Surround. When set to Surround, the sound effect of a multi-channel audio can be simulated. Switching the sound is enabled while the disc is being played. (Specify the subtitle language to use at all times at "System Menu".)

NOTE:

- Some features are not available depending on the type of disc.
- The menu items of unavailable features are displayed on a grey background, and cannot be moved between using **▲** or **▼**.

LISTENING TO MUSIC

Playable Discs

Audio discs can be played on the DVD recorder:

Basic Playback Operations

1. Turn the TV on and select input from the DVD recorder. (For details on operation methods, refer to your TV's manual.)
2. Press **▲OPEN/CLOSE** to open the disc tray.
3. Place the disc with the label facing up on the disc tray.
4. Press **▲OPEN/CLOSE** or **▶**.
The disc tray closes. The disc is then read, and playback automatically begins.
 - While the disc is being read, "READING" is displayed on the front panel.
 - During playback, the elapsed time is displayed on the front panel.

Stopping playback

Press **■** to stop playback.

When you press **▶**, the disc is played from the beginning.

NOTE:

- The resume playback feature is disabled in the case of audio discs.

Pausing/cancelling a pause

Press **PAUSE |||** to pause playback.

To resume playback, press **▶**.

Skipping a track/returning to the beginning of a track

When you press **NEXT ▶▶** during playback, the next track is started.

When you press **PREV ◀◀** during playback, the disc returns to the start of the present track, and playback is started.

Fast-forwarding/fast-reversing

When you press **F.FWD ▶▶**, the disc is fast-forwarded. Each press of **F.FWD ▶▶** changes the fast-forward speed.

When you press **F.REV ◀◀**, the disc is fast-reversed. Each press of **F.REV ◀◀** changes the fast-reverse speed.

Repeat Playback, Random Playback, Intro Playback

Each press of the **PLAY MODE** button during playback displays the play modes. Press the **OK** button to select the desired play mode.

Playback Mode	Explanation of Operation
Repeat Track	Repeats the track currently being played.
Repeat Disc	Repeats all tracks.
Repeat A-B	Repeats only a specified section. To select a specified section, press the OK button at the repeat start point (A). The display changes to Repeat B. Press the OK button again at the repeat end point (B).
Shuffle	Selects and plays tracks on the disc at random.
Scan	Plays back only the first ten seconds of each track.
(None)	Select this to cancel the PLAY MODE setting. (The setting is cancelled even if you do not press the OK button.)

Playing Back a Specific Track

You can specify a track to play back by performing the following operation during playback or while playback is paused.

1. Press **T/C** to display the "T/C Tools" menu.
 2. Select "Track" using **▲** or **▼**.
 3. Press the number buttons or **◀ ▶** to specify the number of the desired track to play back.
- You can advance to the next track by pressing **NEXT ▶▶**.
 - You can return to the previous track by pressing **PREV ◀◀**.

Playing Back from a Specific Point by Time Search

You can specify the time (hours : minutes : seconds) and play back from that time.

The time can be specified only for a track that is currently being played. Perform the following while the desired track is being played.

1. Press **T/C** to display the "T/C Tools" menu.
2. Select "Search" using **▲** or **▼**, and press the **OK** button. The frame for entering the time is displayed. Move to the desired digit by **◀ ▶**, and press the number buttons to specify the time.
3. Press the **OK** button. Playback starts from the specified time.

NOTE:

- When "Playback Mode" is on, "Time Search" is not available. See the table above on "Playback Mode".

Playing Back MP3 Discs

Play back

1. Insert a MP3 disc.
2. "Track, Album and Artist" will be displayed on the screen.
3. MP3 CD will be played automatically.

NOTE:

- When the information for track, album and artist are not recorded, they will not be displayed.

Playing Back a Specific Album or Track

You can specify an album or Track to play back by performing the following operation during playback or while playback is paused.

1. Press **T/C** to display the "T/C Tools" menu.
2. Select "Album" or "Track" using **▲** or **▼**.
3. Press the number buttons or **◀ ▶** to specify the number of the desired album or track to play back.

Stopping playback

Press **■** to stop playback.

Pausing/cancelling a pause

Press **PAUSE ■■** to pause playback.

To resume playback, press **▶**.

Skipping a track/returning to the beginning of a track

Press **NEXT ▶▶** during playback or pause to skip to the next track.

Press **PREV ◀◀** during playback or pause to skip back to the previous track.

You cannot fast-forward or fast-reverse while playing back MP3 discs.

NOTE:

- The file system is ISO9660 Level 1 and Level 2.
- If the CD has both audio CD tracks and MP3 files, only audio CD tracks are played.
- It would take 30 seconds or more for this unit to read MP3 files depending on its structure.
- This unit can recognize up to 999 files or folders per disc. A CD with 1000 files or folders and over cannot read by this unit.
- MP3 CDs may not be played in the recorded order.
- MP3 files must have the extension letters, ".MP3" or ".mp3".
- Standard, sampling frequency, and the bit rate:
MPEG:1 Audio Layer 3
44.1kHz, 48kHz
56kbps to 256kbps (constant bit rate)
- The recommended recording setting for a high-quality sound is 44.1kHz of sampling frequency and 128kbps of constant bit rate.
- Limitations on display
Available letters for display are the following: numbers 0 through 9, and capital or lower-case alphabet characters A through Z.
- Some MP3 CDs cannot be played back depending on the recording conditions.
- The CD has no music data or non-MP3 files cannot be played back.
- The WMA files cannot be played back.
- **Customers should also note that permission is required in order to download MP3 files and music from the Internet. SANYO has no right to grant such permission. Permission should always be sought from the copyright owner.**
- MP3 discs hold about ten times more tracks than audio CDs. Due to the large number of tracks, tracks are divided and saved in groups. These groups are called "folders." Folders are given names that indicate their content.



VIEWING JPEG CD PHOTOS & IMAGES

Playable Discs

Discs recorded with images saved in JPEG format such as KODAK Picture CDs can be played on the DVD recorder.

NOTE:

- The file system is ISO9660 Level 1 and Level 2.
- When creating discs on a personal computer, image files may also be saved without making a folder for the files.
- When images files are saved in two or more folders, each folder is distinguished as a roll. (The uppermost layer is also regarded as a roll.)
- Even if folders are arranged in a series, they may be hierarchically organized and other folders may be created within folders.
- The DVD recorder can handle up to 99 folders up to 1000 images per folder. If the limit of 999 images per folder is exceeded, some images will not be able to be loaded.
- Images up to 2560 x 1920 pixels in size can be read.

Displaying the Thumbnail Screen

1. Turn the TV on and select input from the DVD recorder. (For details on operation methods, refer to your TV's manual.)
2. Press **▲OPEN/CLOSE** to open the disc tray.
3. Place the disc with the label facing up on the disc tray.
4. Press **▲OPEN/CLOSE** or **▶**.

The disc tray closes. The disc is then read, and images are displayed as thumbnails.

- While the disc is being read, "READING" is displayed on the front panel.
- You can change the order of images in this screen or perform a slide show.

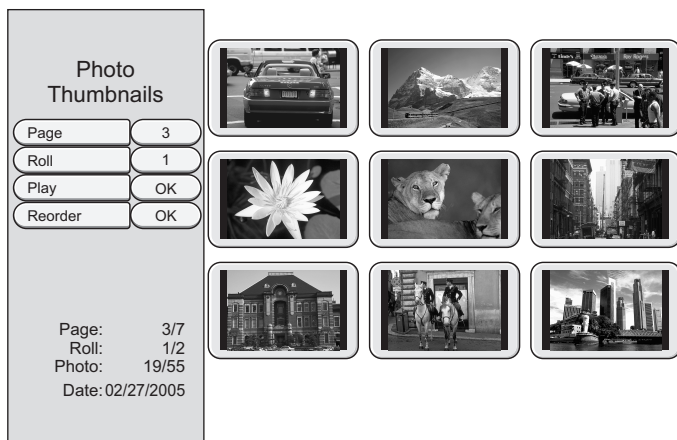

NOTE:

- While viewing the Thumbnail Screen, after you have selected an image and then pressed the **■** button, the image will be replaced by "Hidden Image". The "Hidden Image" will be skipped during slide show. To return to the images, select the "Hidden Image" and press the **■** button again.

Searching for Photos in the Thumbnail Screen

The following operations are available in the thumbnail screen. Select the menu item using **▲** or **▼**, and set the desired feature according to the description in the following table.

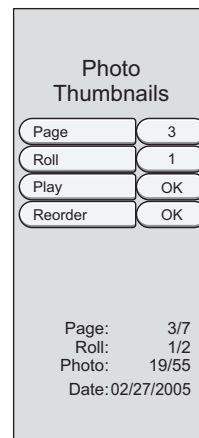

Menu Item	Explanation of Operation
Page	Displays the page number of the thumbnail screen. You can switch the page by pressing the OK button.
Roll	When images are saved in two or more folders, each folder is regarded as a single roll. A number assigned automatically by the DVD recorder to the currently displayed folder is displayed to distinguish each folder. (This number differs according to folder name.) The roll can be switched by pressing the OK button.
Play	When you press the OK button, a slide show of the images in the currently displayed roll is started.
Reorder	The display order of images can be changed. 1) Press the OK button to start reordering images. 2) Select the image to be reordered by ◀, ▶, ▲, ▼ , and press the OK button. 3) Specify the move destination position by ◀, ▶, ▲, ▼ , and press the OK button. The order of the images is changed.

NOTE:

- Some features are not available depending on the type of disc. The menu items of unavailable features are displayed on a grey background, and cannot be moved between using **▲** or **▼**.

Displaying Photos in the Slide Show

Specify the roll in the thumbnail display, and press the **OK** button to start the slide show.

Enlarging images

When **ZOOM** is pressed during the slide show or while the slide show is paused, the currently displayed image can be enlarged up to two times its size.

Each press of **ZOOM** switches the zoom ratio, and the zoom ratio is displayed at the bottom of the screen.

You can adjust which part of the video image will be displayed in the centre of the screen by pressing ◀, ▶, ▲, ▼ during zoom playback.

To return to regular playback, repeatedly press **ZOOM** until the zoom ratio display at the bottom of the screen disappears.

Pausing the slide show

When you press **PAUSE** ■■, the slide show is paused, and the "Photo Slide Show" menu is displayed.

To continue the slide show from the paused position, press ▶.

Ending the slide show

Press ■ to end the slide show and return to the thumbnail screen.

Changing how slide shows are displayed

When you press **PAUSE** ■■, the slide show is paused, and the "Photo Slide Show" menu is displayed. In this menu, set how the slide show is to be displayed (e.g. image display time).

NOTE:

- If you do not perform any operation, the slide show menu disappears. To redisplay the "Photo Slide Show" menu, press **T/C**.

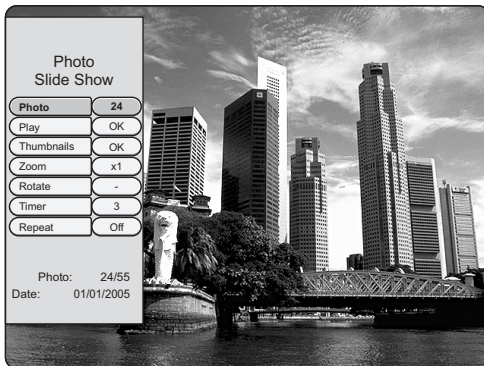

Menu Item	Explanation of Operation
Photo	When you press the number buttons to enter the number of an image in the roll that is being displayed in the slide show, that image is displayed. You can then enlarge or rotate it.
Play	When you press the OK button, the slide show is resumed with the slide show menu displayed.
Thumbnails	When you press the OK button, the screen returns to the thumbnails screen.
Zoom	When you press the OK button, the currently displayed image is displayed enlarged. Each press of the OK button changes the zoom ratio between X1, X2, X4, and X8.
Rotate	When you press the OK button, the currently displayed image is rotated. Each press of the OK button rotates the image 90° clockwise.
Timer	Sets the time (number of seconds) that each image is displayed by pressing the OK button, ◀▶ or the number buttons up to 99(max).
Repeat	Specifies whether or not to repeat the slide show after all of the images have been displayed. Each press of the OK button or ◀▶ switches between on and off.

EDITING & DISC MANAGEMENT

Editing Chapters

A marker will be set every few minutes if the "Auto Chapter" function is activated in the "Recording" menu. This marker is known as a "chapter". These markers can be changed when the recording has finished. It is also possible to add "chapters" later. This means that scenes you do not want to see during playback, such as commercials, can be hidden or skipped. During playback you can watch your recording as a continuous sequence without the hidden chapters.

NOTE:

Markers can be set on DVD+R discs if they have not been finalised.

Insert Chapter

During playback, you can set and delete chapter markers within a title. Each disc can have a maximum of 100 chapters, and 99 per title. When one of these values is reached, "Max Chapter Limit Reached" appears on the screen. Some markers will need to be deleted in order to create new ones or to make recordings.

1. During playback, press **EDIT** at the appropriate point. The "Edit Chapters" menu will appear on the screen.
2. When the image to use as the start position of a new chapter is displayed, select "Insert Chapter" using **▲** or **▼** and press the **OK** button.

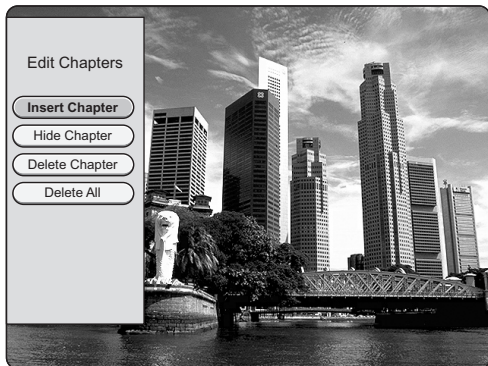

"Inserting Chapter Marker" appears on the TV screen. You can see that the total number of chapters shown on the Status Display is incremented by one.

NOTE:

- This operation is possible even in a paused state.

3. To remove the menu, press **EDIT**.

NOTE:

- If the disc is write-protected or the disc is a finalised DVD+R, subsequent changes cannot be made.

Hide Chapter

By default, all the chapters are visible. You can hide chapters for playback (e.g. commercial skipping).

1. Press **EDIT** during playback of the corresponding chapter. The "Edit Chapters" menu will appear on the screen.
2. When the chapter to return to display is being played back, select "Hide Chapter" using **▲** or **▼** and press the **OK** button. The picture is greyed out.
3. To end, press **EDIT**.

NOTE:

- During playback this chapter will be skipped.

Unhide Chapter

During regular playback, hidden chapters cannot be viewed as they are skipped. In the editing mode, hidden chapters are displayed in grey. You can display hidden chapters by performing the following.

1. Press **EDIT** during playback of the corresponding chapter, the "Edit Chapters" menu will appear on the screen.
2. When the chapter to be displayed is being played back, select "Unhide Chapter" using **▲** or **▼** and press the **OK** button.

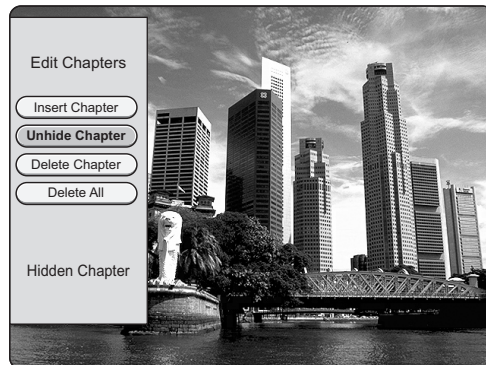

The hidden chapter can be played back normally.

NOTE:

- To view the entire titles including the hidden chapters, see "Playback Title" on page 29.
- You can move to chapters to return to display using **PREV** **◀◀** or **NEXT** **▶▶**.

3. To end, press **EDIT**.

Delete Chapters (Delete Chapter, Delete All)

Within a title, you can either delete individual chapter markers or all markers.

1. Press **EDIT** during playback of the corresponding chapter. The "Edit Chapters" menu will appear on the screen.
2. Select either "Delete Chapter" for current chapter or "Delete All" for all chapters of the selected title using **▲** or **▼** and press the **OK** button.
3. Confirm the deletion of all the chapters by pressing "Press OK to Delete All Chapters". If you do not want to, press "Press STOP to Cancel" button.

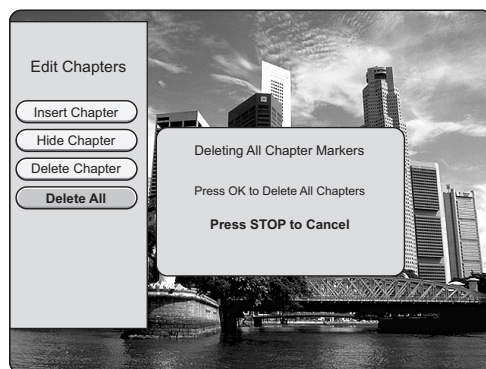

NOTE:

- When "Delete Chapter" is selected, "Deleting Chapter Marker" will be displayed while deleting the chapter.

4. To remove the menu, press **EDIT**.

Editing Titles

Editing Recording Titles (name)

Some TV stations transmit the title (name) of a programme. In this case, the name will be included automatically (e.g. "ROCKY"). Otherwise, the channel number and time of the recording are stored as the name. The name of the recording can be changed only after the recording has been completed.

1. Press the **■** button or during playback press **DISC MENU**.
2. Using **▲** or **▼**, select the title whose name is to be edited and press **▶**. The menu for editing names "Title Settings" appears.
3. Select "Name" using **▲** or **▼** and press the **OK** button.

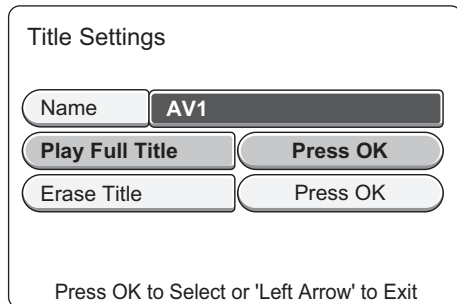

4. Using **◀** or **▶**, select the position where the letter/number/icon is to be changed/re-entered.
5. Change the character using **▲** or **▼**. You can switch between upper and lowercase using **SELECT**. You can delete the character using **CLEAR**.
6. Repeat 4 and 5 until you have made the changes you want.
7. Save the new name with **OK**.
8. To end, press **◀**. "Please Wait" appears on the TV screen for confirmation.

Playback Title

If you have hidden certain chapters of a title, with this setting you can view the entire title including the hidden chapters. Proceed as follows:

1. Press the **■** button or during playback press **DISC MENU**.
2. Using **▲** or **▼**, select the title that you want to play back and press **▶**. The menu for editing titles "Title Settings" appears.
3. Select "Play Full Title" using **▲** or **▼** and press the **OK** button.
4. Playback begins automatically. The full title - including the hidden chapters - is played back.

Erasing a recording/title

You can erase individual recordings from a disc. Follow the instructions below:

1. Press the **■** button or during playback press **DISC MENU**.
2. Using **▲** or **▼**, select the title to be erased and press **▶**. The menu for editing titles "Title Settings" appears.
3. Using **▲** or **▼**, select "Erase Title" and press the **OK** button. "OK to Erase Title" appears on the screen.
4. If you want to erase the title press **OK**.
5. The screen will show "Please Wait".
6. "Empty title" will now appear in this position in the disc menu. A new recording can now be made at this position. If the deleted title was very short (shorter than several minutes), no "Empty Title" will be displayed.

Can titles be deleted from a DVD+R disc?

Titles on DVD+R discs are only marked as deleted. "Deleted Title" will appear in the display instead of "Empty title". During playback the "Deleted Title" is skipped. The space used for this title cannot be used again as the title has not been physically deleted. Once the disc has been finalised no further changes can be made.

Disc settings

Changing the Disc Name

1. Press the **■** button or during playback press **DISC MENU**.
2. The disc menu is displayed. Repeatedly press **▲** to display the disc information.

Repeatedly press **▲** until the disc appears here.

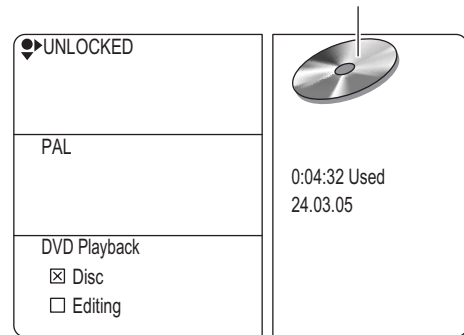

3. In the Disc Info screen press **▶**. The "Disc Settings" menu appears on the TV screen.

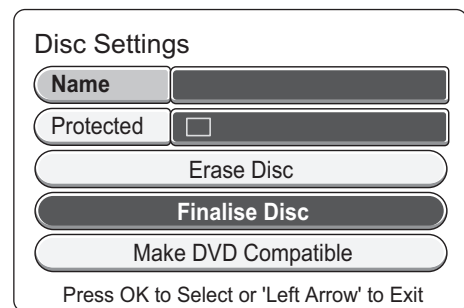

4. Select "Name" using **▲** or **▼** and press the **OK** button.
5. Using **◀** or **▶**, select the position where the letter/number/icon is to be changed/re-entered.
6. Change the name using **▲** or **▼**. You can switch between upper and lowercase using **SELECT**. You can delete the character using **CLEAR**.
7. Repeat 5 and 6 until you have made the changes you want.
8. Save the new title with **OK**.
9. To end, press **◀**. "Please Wait" appears on the TV screen for confirmation.

Erasing DVD+RW Discs

1. Press the **■** button or during playback press **DISC MENU**.
2. The disc menu is displayed. Repeatedly press **▲** to display the disc information.
3. In the Disc Info screen press **▶**. The "Disc Settings" menu will appear on the screen.
4. Select "Erase Disc" using **▲** or **▼**. Confirm with **OK**. The screen will show "OK to Erase Disc".
5. If you want to erase all titles, press **OK**.
6. The screen will show "Please Wait".
Once the disc has been successfully erased, the disc menu shows "Empty Title" is displayed.

NOTE:

- With this procedure, all titles will be erased.

Finalising DVD+R Discs

This feature is required to play back a DVD+R disc in a DVD player. Once the disc has been finalised no further recordings or changes can be made.

1. Press the **■** button or during playback press **DISC MENU**.
2. The disc menu is displayed. Repeatedly press **▲** to display the disc information.
3. In the Disc Info screen press **▶**. The "Disc Settings" menu appears on the TV screen.
"Finalise Disc" can not be selected when either there is no DVD+R disc inserted or the disc is already finalised.
4. Select "Finalise Disc" using **▲** or **▼** and press the **OK** button.
5. Select "OK to Finalise Disc" using **▲** or **▼** and press the **OK** button.
6. The screen will show "Please Wait".
7. When the operation is executed, "Please Wait" will disappear.

NOTE:

- If the disc has been recorded on another DVD recorder, the menu may not appear.

Make DVD Compatible

Even if one or more titles have been edited, a DVD player may still show the original title. You can prepare your disc so that a DVD player will be able to read the edited title.

1. Press the **■** button or during playback press **DISC MENU**.
2. The disc menu is displayed. Repeatedly press **▲** to display the disc information.
3. In the Disc Info screen press **▶**. The "Disc Settings" menu will appear on the screen.
4. Select "Make DVD Compatible" using **▲** or **▼** and press the **OK** button.
5. Select "Make DVD Compatible" using **▲** or **▼** and press the **OK** button.
6. The screen will show "Please Wait".
7. When the operation is executed, "Please Wait" will disappear.

Protecting Discs and Cancelling Disc Protection

To prevent an important recording from being accidentally erased, you can protect the entire disc. You can only protect the disc as a whole. It is not possible to protect an individual recording.

NOTE:

- What happens with DVD+R discs?
As long as these discs are not finalised, they can be protected against accidental erasure in the same way as DVD+RW discs.

Protecting discs

1. Press the **■** button or during playback press **DISC MENU**.
2. The disc menu is displayed. Repeatedly press **▲** to display the disc information.
3. In the Disc Info screen press **▶**. The "Disc Settings" menu will appear on the screen.
4. Select "Protected" using **▲** or **▼** and press the **OK** button. The box is now checked.
5. Exit using **◀** and press **DISC MENU**.
The entire disc is now protected. If you try to record onto this disc the message "PROTECTED" will appear in the display and "Disc is Locked" on the screen.

To cancel disc protection

Press the **OK** button at step 4 in "Protecting discs", and deselect the "Protected" item.

NOTE:

- Each press of **OK** at step 4 in "Protecting discs" selects or deselects the item.

DVD RECORDER SETTINGS

When you press **SYSTEM MENU**, the following menu will be displayed. In this menu, you can change various settings on the DVD recorder to suit your particular requirements.

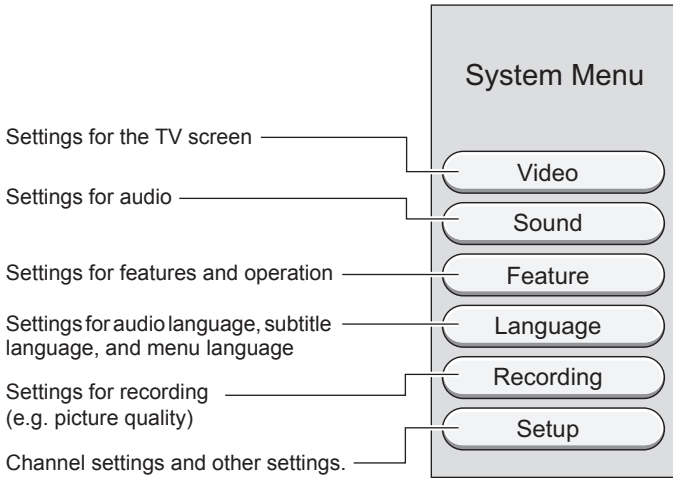

The above menu will be displayed by pressing **SYSTEM MENU** not only while disc operations are stopped, but also during playback, pause and standby.

After you change a setting, the new details are stored to memory as default settings for when you perform various operations.

For example, with the recording mode (picture quality), recordings will be made in the mode set in this System Menu unless you specify a different mode during recording. If you press **REC MODE** before recording to change the recording mode, the setting you make will be enabled only until the DVD recorder is turned off.

NOTE:

- During playback or while disc operations are paused, some items cannot be changed depending on the title that is currently being played.
- During playback or while disc operations are paused, the "Setup" feature cannot be changed.

TV Screen Settings

1. Turn the TV on and select input from the DVD recorder. (For details on operation methods, refer to your TV's manual.)
2. Press **SYSTEM MENU** to display the System Menu.
3. Select "Video" using **▲** or **▼**, and press **▶** once. The setting items at "Video Options" on the right of the screen can now be selected using **▲** or **▼**.
4. Select the item to be changed using **▲** or **▼**, and change the settings.

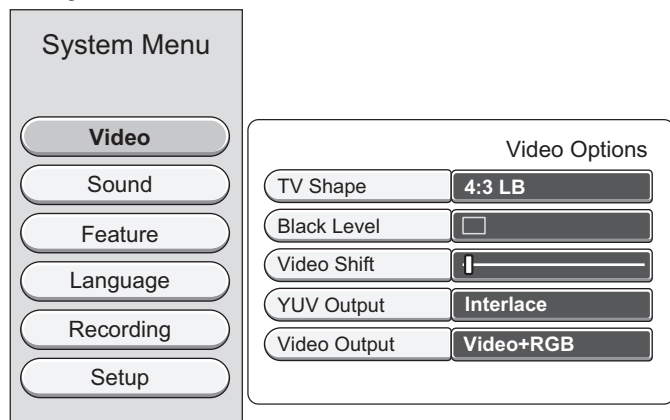

Setting Item	Explanation
TV Shape	Set the aspect ratio (shape) of your TV's screen. When you press the OK button, the selection items are displayed. Select the desired item using ▲ or ▼ , and press the OK button. See Page 14.
Black Level	To use this feature, press the OK button to select it. Each press of the OK button selects or deselects this setting.
Video Shift	Fine-adjust the position of the video on the TV screen to the left and right. Press the OK button, and then adjust the position using ◀ or ▶ and press the OK button.
YUV Output	Set your TV's display mode as "Interlace" or "Progressive." (When the DVD recorder is shipped from the factory, the display mode is set to "Interlace.") When you press the OK button, the selection items are displayed. Select the display mode of your TV using ▲ or ▼ , and press the OK button.
Video Output	Set whether or not to output video to the S-Video terminal. When the DVD recorder is connected to a TV by the SCART cable or other cable, select "S-Video+YUV." When you press the OK button, the selection items are displayed. Select video output using ▲ or ▼ , and press the OK button.

NOTE:

- When you press **◀**, other items in the System Menu can be selected. Set other items as necessary.
5. To end setting, press **SYSTEM MENU**.

Audio Output Settings

1. Turn the TV on and select input from the DVD recorder. (For details on operation methods, refer to your TV's manual.)
2. Press **SYSTEM MENU** to display the System Menu.
3. Select "Sound" using ▲ or ▼, and press ► once. The setting items at "Sound Options" on the right of the screen can now be selected using ▲ or ▼.
4. Select the item to be changed using ▲ or ▼, and change the settings.

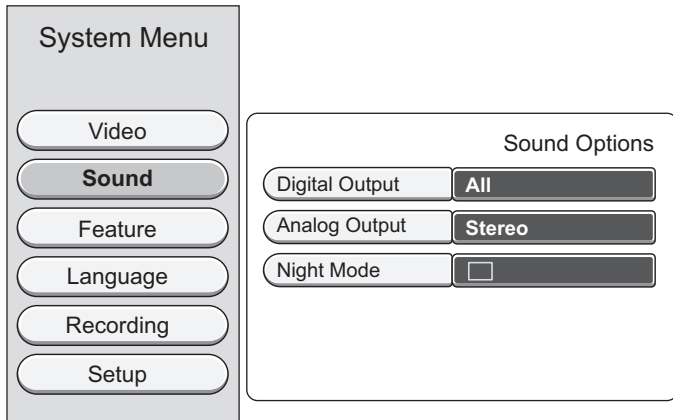

Setting Item	Explanation
Digital Output	<p>Set output from the digital audio output terminal. When you press the OK button, the selection items are displayed. Select digital output using ▲ or ▼, and press the OK button.</p> <p>Off Select this when digital audio output is not used.</p> <p>PCM Only Dolby Digital and MPEG-2 multi-channel signals are converted to PCM (Pulse Code Modulation). This setting is for receivers/amplifiers without digital multi-channel sound decoders. DTS is not converted into PCM. (Sound does not output.)</p> <p>All Dolby Digital and DTS signals are fed unaltered to the digital output. MPEG-2 multi-channel signals are converted to PCM (Pulse Code Modulation). This setting is for receivers/amplifiers with digital multi-channel sound decoders.</p>
Analog Output	<p>Set output from the analogue audio output terminal (L/R AUDIO OUT). When you press the OK button, the selection items are displayed. Select analogue output using ▲ or ▼, and press the OK button.</p> <p>Stereo For devices without Dolby Surround or TruSurround. Use this setting if the DVD recorder is connected only to a stereo TV set.</p> <p>Surround Dolby Digital and MPEG-2 multi-channel are mixed down to a DOLBY surround-compatible two-channel output signal. For devices with Dolby Surround Pro Logic decoder.</p>
Night Mode	<p>Night mode optimises the sound for playback at low volume. You are therefore less likely to disturb your neighbours. This only works for Dolby Digital audio on DVD video discs. This option can be selected if required. Night Mode works only when analog output.</p> <p>To use this feature, press the OK button to select it. Each press of OK selects or deselects this setting.</p>

NOTE:

- When you press ◀, other items in the System Menu can be selected. Set other items as necessary.

5. To end setting, press **SYSTEM MENU**.

Operation and State Display Settings

1. Turn the TV on and select input from the DVD recorder. (For details on operation methods, refer to your TV's manual.)
2. Press **SYSTEM MENU** to display the System Menu.
3. Select "Feature" using ▲ or ▼, and press ► once. The setting items at "Feature Options" on the right of the screen can now be selected using ▲ or ▼.
4. Select the item to be changed using ▲ or ▼, and change the settings.

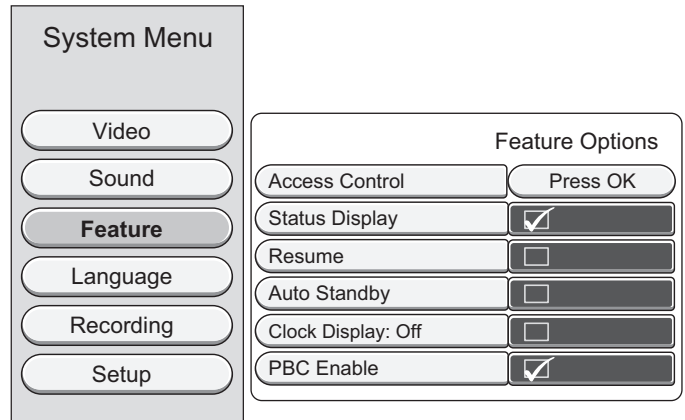

Setting Item	Explanation
Access Control	<p>Parental Level Control Accessing of DVD discs can be controlled. For details, see "Parental Level Control" on page 34.</p>
Status Display	<p>Along with the on-screen menu, the OSD (On Screen Display) also displays information on the current operating status (counter, playback, recording, TV channel, etc.) on the TV screen. By default, this would be off, to see the information about the operating status, check the "Status Display" box. This appears in every selected mode for a few seconds and disappears.</p> <p>To use this feature, press the OK button to select it. Each press of OK selects or deselects this setting.</p>
Resume	<p>If playback of a pre-recorded DVD video disc is interrupted (▲ OPEN/CLOSE), when the disc is reloaded (disc is started), playback starts at the precise location where it stopped. This applies not only to the current disc but to the last 20 discs played. This feature can be switched off if not required.</p> <p>To use this feature, press the OK button to select it. Each press of OK selects or deselects this setting.</p>
Auto Standby	<p>To set whether or not to set the standby mode when no operations have been performed for 10 minutes. When no DVD recorder operation has occurred for 10 minutes after ■ (STOP) button is pressed, this unit will go to standby mode. This function works CD media (Audio, MP3 or JPEG) only.</p> <p>To use this feature, press the OK button to select it. Each press of OK selects or deselects this setting.</p>
Clock Display: Off	<p>To save power, you can switch off the clock display on the DVD recorder. Programmed (TIMER) recordings will still take place.</p> <p>If the recorder is switched off (button ⏻/ON), the clock display is also switched off when checked.</p> <p>If the recorder is switched off (button ⏻/ON), the clock display is visible when unchecked.</p> <p>To use this feature, press the OK button to select it. Each press of OK selects or deselects this setting.</p>

NOTE:

- When you press ◀, other items in the System Menu can be selected. Set other items as necessary.

5. To end setting, press **SYSTEM MENU**.

Setting Item	Explanation
PBC Enable	This function lets you activate or deactivate the PBC menu (Playback Control) for VCD only. When you press the OK button to select this item, this feature is turned on. Each press of the OK button toggles this feature on and off.

Adapt Disc Format

When you insert a disc (DVD+R : not finalised or DVD+RW) recorded on other DVD recorder, "Adapt Disc Format" will appear under the "PBC Enable".

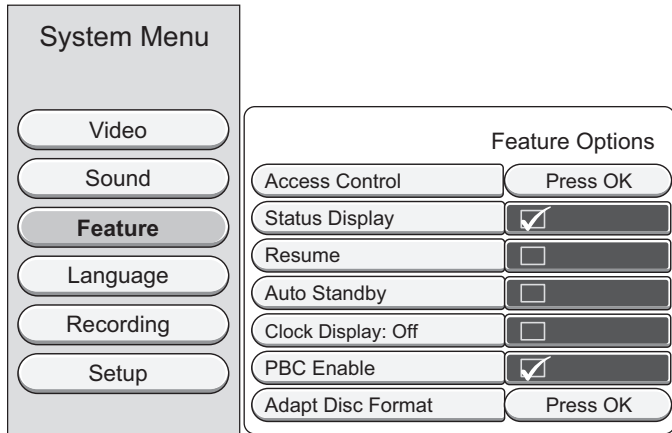

Setting Item	Explanation
Adapt Disc Format	This menu allows you to edit the disc menu on the disc recorded on other DVD recorder. Press the OK button.

Adapt Disc Menu

This Disc Has a Different Menu

Setting the Language

1. Turn the TV on and select input from the DVD recorder. (For details on operation methods, refer to your TV's manual.)
2. Press **SYSTEM MENU** to display the System Menu.
3. Select "Language" using **▲** or **▼**, and press **▶** once. The setting items at "Language Options" on the right of the screen can now be selected using **▲** or **▼**.
4. Select the item to be changed using **▲** or **▼**, and change the settings.

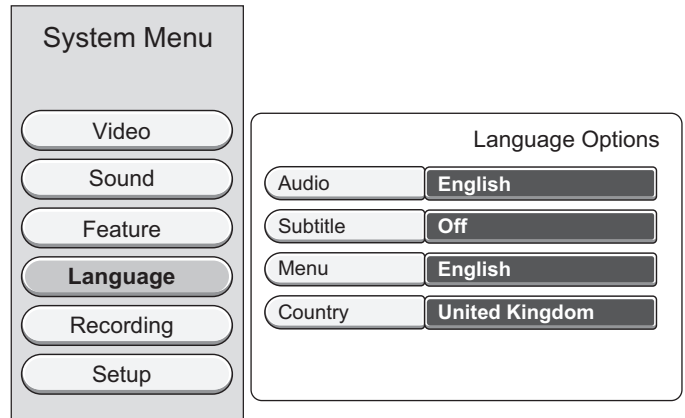

Setting Item	Explanation
Audio	Set the DVD audio language. When you press the OK button, the selection items are displayed. Select the desired item using ▲ or ▼ , and press the OK button.
Subtitle	Set the DVD subtitle language. If subtitle language is not available, the DVD recorder picks the first available language. When you press the OK button, the selection items are displayed. Select the desired item using ▲ or ▼ , and press the OK button.
Menu	Set the menu display language. When you press the OK button, the selection items are displayed. Select the desired item using ▲ or ▼ , and press the OK button.
Country	Set this to call up the specific settings for the respective country. When you press the OK button, the selection items are displayed. Select the desired item using ▲ or ▼ , and press the OK button.

NOTE:

- When you press **◀**, other items in the System Menu can be selected. Set other items as necessary.

5. To end setting, press **SYSTEM MENU**.

Recording Settings

1. Turn the TV on and select input from the DVD recorder. (For details on operation methods, refer to your TV's manual.)
2. Press **SYSTEM MENU** to display the System Menu.
3. Select "Recording" using ▲ or ▼, and press ► once. The setting items at "Recording Options" on the right of the screen can now be selected using ▲ or ▼.
4. Select the item to be changed using ▲ or ▼, and change the settings.

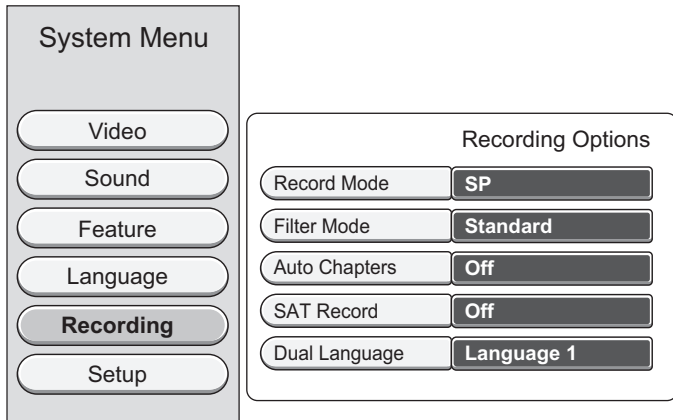

Setting Item	Explanation
Record Mode	Set the picture quality during recording. When you press the OK button, the selection items are displayed. Select the desired item using ▲ or ▼, and press the OK button. See Page 17.
Filter Mode	The filter can be set to " Standard " (Normal) or " Sport " (for fast movements). In LP, EP or EP+ recording mode, you can select the Sport setting in Filter Mode to optimize the video recording for images that contain fast movements, like sports. The setting does not influence HQ or SP recording mode. When you press the OK button, the selection items are displayed. Select the desired item using ▲ or ▼, and press the OK button.
Auto Chapters	When this feature is turned On, chapters can be automatically marked with chapter markers at several minute intervals during recording. When you press the OK button, the selection items are displayed. Select the desired item using ▲ or ▼, and press the OK button.
SAT Record	When a satellite tuner or other equipment on which timer recording can be set are connected to the DVD recorder, video can be recorded synchronized with the start of the broadcast without having to reserve recording on the DVD recorder. When using this feature, specify the input terminal that the equipment is connected to. When this feature is not used, set to Off. When you press the OK button, the selection items are displayed. Select the desired item using ▲ or ▼, and press the OK button.
Dual Language	When recording dual language programmes, set which language to record. When you press the OK button, the selection items are displayed. Select the desired item using ▲ or ▼, and press the OK button. NOTE: - When recording input from the DV-IN (DV socket on the front panel), stereo 1 language from DV equipment is recorded regardless of the setting of this item.

NOTE:

- When you press ◀, other items in the System Menu can be selected. Set other items as necessary.

5. To end setting, press **SYSTEM MENU**.

Parental Level Control

Films on pre-recorded DVD discs may contain scenes not suitable for children. Therefore, some discs may contain "Parental Control" rating (level) information that applies to the entire disc or to certain scenes on the disc. The appropriate scenes have filter values that reach from 1-8. If such a scene is detected during playback, the filter value set on the DVD recorder is compared to the scene. If the filter value is higher than the setting, an alternative scene will be played (if available).

What do the Rating (Level) mean?

Rating (Level) Off (displayed as "--") means that parental level control is not active. Rating (Level) 1 is most restrictive. It means without entering correct password, child cannot view the scenes that are not suitable for children, Rating (Level) 8 is least restrictive. Without entering the passcode, the scenes can be viewed.

What happens if a DVD scene contains a higher level than the rating set?

If the recorder does not find a suitable alternative, playback will stop and you must enter the four-digit passcode.

Setting parental level control

Set parental level control as follows.

1. Turn the TV on and select input from the DVD recorder. (For details on operation methods, refer to your TV's manual.)
2. Press **SYSTEM MENU** to display the System Menu.
3. Select "Feature" using ▲ or ▼, and press ► once. The setting items at "Feature Options" on the right of the screen can now be selected using ▲ or ▼.
4. Select "Access Control", and press the **OK** button.

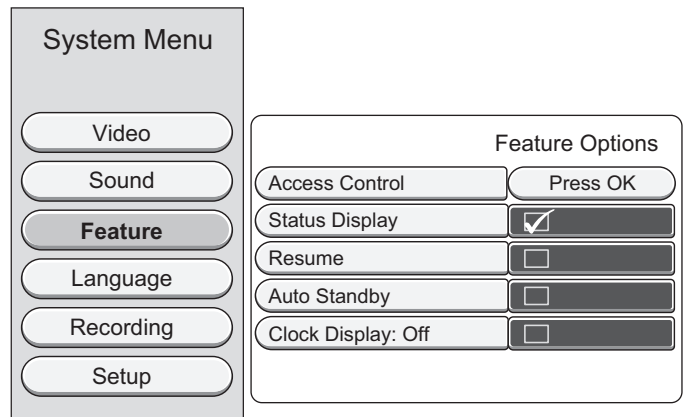

5. Select the item to be changed using ▲ or ▼, and change the settings.

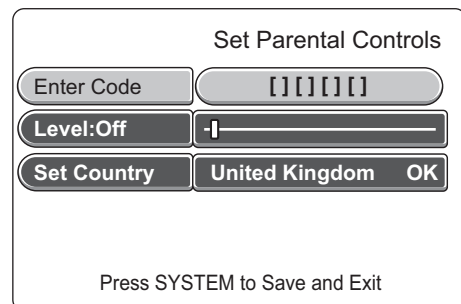

Setting Item	Explanation
Enter Code	<p>The passcode for setting parental level is required. (When the DVD recorder is shipped from the factory, no passcode is set. So, the passcode must first be set.) Follow the procedure below to set the passcode.</p> <p>1) "Enter code" will be displayed. Enter a four-digit code using the number buttons. Entered codes are indicated by "*".</p> <div data-bbox="251 319 705 623" style="border: 1px solid black; padding: 10px; margin: 10px 0;"> <p style="text-align: center;">Set Parental Controls</p> <p>Enter Code [*] [*] [*] []</p> <p>Level:Off - —————</p> <p>Set Country United Kingdom OK</p> <p style="text-align: center;">Press SYSTEM to Save and Exit.</p> </div> <p>2) When "Confirm Code" is displayed, enter the four-digit code again for confirmation. When the code has been set, the display returns to "Press OK".</p> <p>NOTE:</p> <ul style="list-style-type: none"> - When the "Set Parental Controls" screen is displayed from the second operation onwards, "Enter Code" will be displayed on the 1st line instead of "Set Code". Parental level control can be set again by entering the correct passcode. <p>If you have forgotten the passcode, press ■ four times to set the entry field to a non-set state. In this state, set the passcode again.</p>
Parental Level	<p>Set the level of parental control. Press the OK button, and then press ◀ or ▶ to adjust the level. Press the OK button again to apply the level you set.</p> <div data-bbox="251 1159 705 1466" style="border: 1px solid black; padding: 10px; margin: 10px 0;"> <p style="text-align: center;">Set Parental Controls</p> <p>Set Code Press OK</p> <p>Level:2 — —————</p> <p>Set Country United Kingdom</p> <p style="text-align: center;">Press OK to Select Press SYSTEM to Save and Exit.</p> </div>
Set Country	<p>The set filter values depend on the respective country. It is therefore necessary to enter the country to which these filter values apply. When you press the OK button, the country name is displayed. Select the desired country using ▲ or ▼, and press the OK button.</p>

NOTE:

- When you press **◀**, other items in the System Menu can be selected. Set other items as necessary.

6. To send setting, press **SYSTEM MENU**.

To play back a DVD video set with parental level controls.

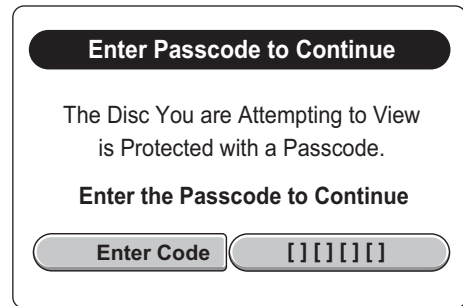

If you attempt to play back a DVD video set with parental level controls, the following screen will be displayed:



Enter the four-digit passcode to start playback.

TROUBLESHOOTING

Check the following guide for the possible cause of a problem before contacting service.

Symptom	Cause	Solution
The unit does not work immediately  /ON button is pressed.	- It takes time for power to be supplied after the  /ON button has been pressed.	- No solution. This unit needs time to start operating because of its structure.
No power. No picture.	- The main lead is disconnected.	- Plug the main lead into the wall outlet securely.
	- The TV is not set to receive DVD Recorder signal output.	- Select the appropriate video input on the TV so that the picture from the DVD Recorder appears on the TV screen.
	- The video cable is not connected securely.	- Connect the video cable securely.
	- The TV is turned off.	- Turn on the TV.
No sound.	- The equipment connected with the audio cable is not set to receive DVD Recorder signal output.	- Select the correct input mode on the audio receiver so you can listen to the sound from the DVD Recorder.
	- The audio cables are not connected securely.	- Connect the audio cable securely.
	- The power of the equipment connected with the audio cable is turned off.	- Turn on the equipment connected with the audio cable.
	- The audio connecting cord is damaged.	- Replace it with a new one.
"Disc Error" message appears.	- The disc which is not supported is inserted.	- Replace a disc.
Playback picture is poor.	- The disc is dirty.	- Clean the disc.
DVD Recorder does not start playback.	- No disc is inserted.	- Insert a disc. (Check that the disc indicator on the front panel display is lit.)
	- An unplayable disc is inserted.	- Insert a playable disc. (Check the disc type, colour system, and regional code.)
	- The disc is placed upside down.	- Place the disc with the playback side down.
	- The disc is not placed within the guide.	- Place the disc on the disc tray correctly inside the guide.
	- The disc is dirty.	- Clean the disc.
	- The Parental Level Control is set.	- Cancel the Parental Level Control function or change the level.
Picture from external input is distorted	- The video signal from the external component is copy-protected.	- You cannot connect via th DVD Recorder. Connect the component directly to your TV.
Some channels are skipped when using CH (+/-)	- The skipped channels were deleted with the CH. Add/Del feature.	- Use the CH. Add/Del feature to restore channels. See "Arranging and Deleting Channels" on page 16.
Picture or sound of broadcasting channel is weak or missing.	- Antenna or cables are loose.	- Tighten connections or replace cable.
	- Wrong Tuning Band is selected in the DVD Recorder Setup menu.	- Try all "Auto-Setting the Channel" options; see page 15 for details.
Camcorder image not shown.	- Camcorder is off.	- Turn camcorder on and operate properly.
Camcorder image via A/V input or DV IN to DVD Recorder is not shown on TV screen.	- DVD Recorder's source is not set to AV3, AV3-S or DV IN.	- Use INPUT to select AV input channel AV3, AV3-S or DV IN.
Can't play disc recorded on this DVD Recorder on another DVD player.	- Some players will not play even a finalized disc recorded in Video mode.	- No solution
	- Discs recorded with copy-once material cannot be played on other players.	- No solution

Symptom	Cause	Solution
Cannot record or did not record successfully.	- The remaining blank space on the disc is insufficient.	- Use another disc.
	- The source you are trying to record is copy-protected.	- You can not record the source.
	- When setting the recording channel, the channel is tuned on the TV's own tuner.	- Select the channel on the DVD Recorder's built-in TV tuner.
	- When recording to disc, programs that are copy-once protected cannot be recorded.	- You can not record the source.
	- The disc is recorded on NTSC on other equipment.	- You can not record on the disc already recorded on NTSC. Replace a disc.
Timer Recording not possible.	- Clock in the DVD Recorder is not set to correct time.	- Set clock to correct time. See "Setting the Clock" on page 15.
	- Timer has been programmed incorrectly.	- Reprogram Timer. See "Timer Recording" on page 18.
	- TIMER indicator light does not appear after programming timer.	- Reprogram Timer.
Stereo Audio Record and/or Playback not present.	- TV is not Stereo-compatible.	- No solution.
	- Broadcast program is not in stereo format.	- No solution.
	- DVD Recorder A/V Out jacks are not connected to TV A/V In jacks.	- Make A/V connections. Stereo is available only via A/V output from DVD Recorder.
	- DVD Recorder Audio/Video Out is not selected for viewing on the TV.	- Select AUX or A/V source as TV input.
	- DVD Recorder's TV audio channel is set to MONO.	- Set TV audio channel mode to Stereo. See "Audio Output Settings" on page 32.
Remote control does not work properly.	- The remote control is not pointed at the remote sensor of the DVD Recorder.	- Point the remote control at the remote sensor of the DVD Recorder.
	- The remote control is too far from the DVD Recorder.	- Operate the remote control within 6m.
	- There is an obstacle in the path of the remote control and the DVD Recorder.	- Remove the obstacle.
	- The batteries in the remote control are exhausted.	- Replace the batteries with new ones.
Playback starts midway after a DVD video is inserted and the ► button is pressed.	- If the Resume function is on, playback starts from the previous position where that disc was stopped for the next 20 discs.	- Turn the Resume function off. See "Operation and State Display Settings" on page 32.

Moisture Condensation

Moisture condensation can occur:	In locations where moisture condensation may occur:
- When the DVD Recorder is moved from a cold place to a warm place.	- Keep the DVD Recorder plugged into an AC power outlet with POWER on. This will help prevent condensation.
- Under extremely humid conditions.	- When condensation has occurred, wait a few hours for the DVD Recorder to dry before using it.

Reset the DVD Recorder

If you observe any of the following symptoms:



- When the DVD Recorder is plugged in, but the power will not be turned on or off
- When the display window does not work
- When the DVD Recorder does not operate normally

Before resetting, please proceed the following procedure first.

1. Turn the /ON button off.
2. Disconnect the Power lead.

If these operation does not work, reset the DVD recorder as follows.

You can reset the DVD Recorder as follows:

1. Disconnect the DVD Recorder from the power outlet.
2. Press and hold down the /ON button on the front of the recorder while reconnecting to the power outlet.
3. Release /ON when "IS TV ON?" appears in the display.
4. Complete the first installation again and reset any items you have adjusted during your use of the recorder.

Warning!!

- The information stored in memory may be reset (cleared).

MAINTENANCE

Cleaning the cabinet

Use a clean soft cloth moistened with plain lukewarm water and wrung dry. Never use benzol, benzene or other strong chemical cleaners since these could damage the finish of your unit. It is important that no liquid reaches the inside of the unit.

SPECIFICATIONS

DVD recorder(DVR-S120)

Playable discs

- DVD-Video
- DVD+R
- DVD+RW
- DVD-RW(Video mode)
- DVD-R(Video mode)
- Audio-CD(CD-DA)
- MP3 CD
- JPEG CD
- Kodak Picture CD

Recordable discs

- DVD+RW
- DVD+R

Video recording format

DVD+RW+R Format

Audio recording format

Dolby Digital (2ch)

Recording time (with 4.7GB disc)

- HQ mode: Approx. 60 minutes
- SP mode: Approx. 120 minutes
- LP mode: Approx. 180 minutes
- EP mode: Approx. 240 minutes
- EP+ mode: Approx. 360 minutes

TV system

PAL standard system

Tuner

System: PAL-I/I

Time indication

24-hour system

Timer

8-event programmable

Connections

Front panel

- Video In : Pin jack (yellow) X1
- S-Video In : S terminal X1
- Audio L/R In : Pin jack (white/red) X1
- DV In : DV (4-pin) terminal X1

Rear panel

- Scart 1: AV connector (RGB/S-Video/Video/Audio out)
(Video/Audio in)
- Scart 2: AV connector (RGB/S-Video/Video/Audio in)
(Video/Audio out)
- Video Out : Pin jack (yellow) X1
- S-Video Out : S terminal X1
- Component Video Out : Pin jack (Y:green/Pb:Blue/Pr:red) X1
- Audio L/R Out : Pin jack (white/red) X1
- Digital audio out : Optical X1

Power requirements

230V AC, 50Hz

Power consumption

30Watts
(clock display: off mode: 3 Watts)

Dimensions (W X H X D)

Approx. 430 X 64 X 320mm

Weight

Approx. 3.7kg

The specifications and appearance of this product are subject to change for improvements without notice.

GUARANTEE TO CUSTOMER

Sanyo Europe Ltd. (the Company) guarantees to the initial retail purchaser that if this equipment is or becomes defective and that, in the opinion of the Company, the defect is due to faulty material or workmanship the Company will, for a period of 12 calendar months from the date of sale to the original purchaser repair or replace, at its sole option, free of charge, any such defective component part of the equipment, always provided that: -

1. The equipment has at all times been used in accordance with the operating instructions issued by the Company, and has not been connected to an electrical mains supply for which it has not been adjusted.
2. Accidental damage, or damage caused by negligence or misuse by the user, including leakage from exhausted batteries, is specifically excluded.
3. Unauthorised repairs, or any modification to the equipment which has not been expressly approved by the Company, shall render this guarantee null and void.
4. Failure due to fair wear and tear of any item, such as batteries, record playing styli, and tape recording, playback and erase heads is specifically excluded.

This guarantee is not transferable and is only applicable within the United Kingdom (and the Republic of Ireland). Nothing in this express guarantee affects the statutory rights available to the purchaser of this equipment.

NOTE:

This guarantee supersedes any other form of guarantee that may inadvertently have been enclosed with or attached to the product. (August 1978).

Dear Customer

Thank you for buying Sanyo. This equipment should give you many years of pleasure and faithful service but in the event that a fault occurs, the following notes for your guidance may be helpful:-

1. PLEASE RETAIN YOUR PURCHASE RECEIPT WHICH WILL BE REQUIRED FOR SERVICE DURING GUARANTEE.
2. If your Sanyo equipment proves faulty during the period of guarantee, take it or send it back to the dealer who originally supplied it together with this guarantee and the proof of purchase. We have made arrangements with our approved dealers under which they will carry out in-guarantee service repairs on our behalf. In this way, we hope to reduce to a minimum the amount of time you will be without your equipment.
3. If for some reason it is impossible to return the equipment to the original supplier, please contact our Consumer Relations Department at the address below for further advice.
4. Should the equipment require servicing after the expiry of the guarantee period, take or send it to the original supplier or any other Sanyo dealer. He will be pleased to give you a quotation for the repair. If you are in any doubt about what to do, write to us at the address below or telephone:

Consumer Relations Department,
Sanyo Europe Ltd.,
18 Colonial Way, Watford
WD24 4PT
Tel: Watford 246363

R6

The Sanyo logo consists of the word "SANYO" in a bold, sans-serif font. The letter "Y" is stylized with multiple vertical lines of varying lengths extending from its top and bottom, creating a sense of motion or a signal.

Free Manuals Download Website

<http://myh66.com>

<http://usermanuals.us>

<http://www.somanuals.com>

<http://www.4manuals.cc>

<http://www.manual-lib.com>

<http://www.404manual.com>

<http://www.luxmanual.com>

<http://aubethermostatmanual.com>

Golf course search by state

<http://golfingnear.com>

Email search by domain

<http://emailbydomain.com>

Auto manuals search

<http://auto.somanuals.com>

TV manuals search

<http://tv.somanuals.com>