

# Network Board

## POA-MD13NET2



### OWNER'S MANUAL

#### **INSTALLATION and OPERATION of the Network Board**

This board is the Network Board to control and set up a projector via a network. Connect a network cable to this board, and by accessing the connected projector using the web browser on your computer, the projector can be controlled and set up remotely.

This board is only used for our projectors that have a terminal for the Network Board.

This manual explains the installation of the Network Board and its operation.

**Chapter 1 Preparation**

**Chapter 2 Installation**

**Chapter 3 Basic Setting & Operation**

**Chapter 4 Controlling the Projector**

**Chapter 5 Controlling the Multi-Projectors**

**Chapter 6 Use of Serial Port**

**Chapter 7 Appendix**

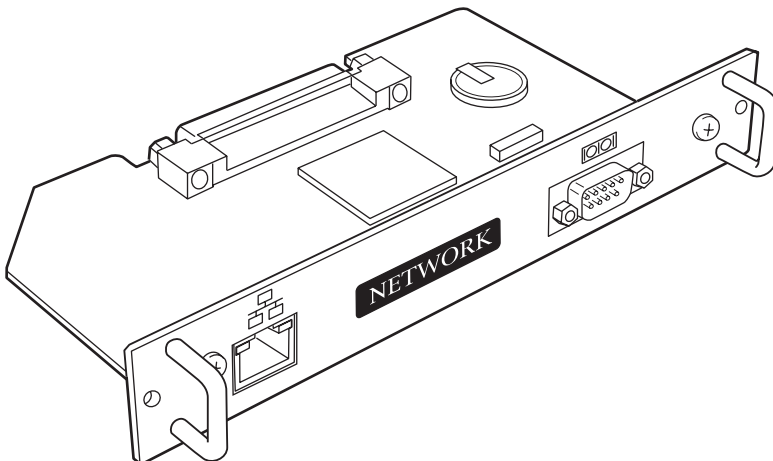

# Compliance

---

## Federal Communication Commission Notice

This equipment has been tested and found to comply with the limits for a Class A digital device, pursuant to Part 15 of FCC Rules. These limits are designed to provide reasonable protection against harmful interference when the equipment is operated in a commercial environment. This equipment generates, uses, and can radiate radio frequency energy and, if not installed and used in accordance with the instruction manual, may cause harmful interference to radio communications. Operation of this equipment in a residential area is likely to cause harmful interference in which case the user will be required to correct the interference at his own expense.

Do not make any changes or modifications to the equipment unless otherwise specified in the instructions. If such changes or modifications should be made, you could be required to stop operation of the equipment.

## Warning

This is a Class A product. In a domestic environment this product may cause radio interference in which cause the user may be required to take adequate measures.

### CAUTION

This product provides a lithium battery. When you discard this product, you should return it to your local dealer.



### CAUTION ON USE IN NETWORK

- When you receive an alert e-mail from the projector, you must check the projector immediately. Fire or accident may result if the projector is used in an abnormal condition.
- When you install the projector at remote location and use it through the network, you must perform the safety inspections periodically. In this case you must pay attention to the change of environment in which you installed the projector. It may cause fire or an accident depending on the change of environment.

### CAUTION

We assume no responsibility for the loss or damage of data or damage of the computer caused by use of this product.

# Contents

---

<b>Chapter 1</b>	
<b>Preparation</b> .....	<b>5</b>
Features .....	6
Operating Environment .....	8
Notices .....	10
<b>Chapter 2</b>	
<b>Installation</b> .....	<b>11</b>
Flow of installation .....	12
1 Name and function of each part .....	13
2 Installation and Network configuration .....	14
Mounting .....	14
Connection of LAN cable .....	15
Network configuration (Type1) .....	16
Network PIN code setting .....	18
Network configuration (Type2) .....	20
Password setting [Display] .....	22
Notice about system construction .....	23
<b>Chapter 3</b>	
<b>Basic Setting and Operation</b> .....	<b>25</b>
Login the setting page of the projector .....	26
1 Enter the IP address .....	26
2 Select a display mode and login .....	26
3 Display of main setting page .....	27
Initial Settings .....	29
1 Language Setting .....	29
2 Password Setting .....	30
3 Date/Time Setting .....	30
Network Configuration .....	31
1 Configure the network .....	31
2 Name the projector .....	31
E-mail Setting .....	32
1 Registering SMTP Server, Administrator Address .....	32
2 Registering and deleting E-mail addresses .....	33
3 Condition selection for sending alert message .....	33
Examples: Type and contents of alert mail .....	34
<b>Chapter 4</b>	
<b>Controlling the Projector</b> .....	<b>35</b>
Power on/off the projector .....	36
Check the status of projector .....	37
Control the projector .....	38
Input .....	38
PC Adjustment .....	39
Save a Set .....	40
Load a Set .....	40
System Adjustment .....	41

- Image Adjustment .....42
- Save a image adjustment value .....43
- Load a image mode .....43
- Screen Adjustment .....44
- Sound Adjustment .....44
- Setting .....45
- How to set the Timer .....48
- Check the Timer events .....48
- Getting the current time .....49
- Cancel the timer .....49
- Service .....50
- Save Actual Adjustment .....51
- Check the Save items .....51
- Control the projector's menu .....53
- Make a memo .....54

## Chapter 5

### Controlling the Multi-Projectors .....55

- Multi-Control .....56
  - Register IP address and projector name .....57
  - Check IP address and projector name .....57
  - Exclude/Add/Delete a projector .....58
  - Status .....58
- Control .....59
- Load and apply the setting value .....59
- Control multi-projectors at the same time .....60

## Chapter 6

### Use of Serial Port .....61

- Serial Port setting .....62
- Control Examples .....64
- Use of Telnet .....66
  - Control the projector with Telnet .....68

## Chapter 7

### Appendix:A .....69

- Examples of Connection .....70
  - Peer-To-Peer connection .....70
  - The gateway (Router) installed in the network .....71
- Web browser setting .....72
  - Active Script/JavaScript enable .....72
  - Proxy setting .....72
- Examples: OS/Browsers .....73
  - Windows XP Professional .....73
  - Mac OS 8.6 .....77
- Product specification .....81
- Port Specification .....82

### Appendix:B .....83

- Q&A .....84

# Chapter 1 Preparation

1

ENGLISH

## Features

### Web Management function (☞ p.36)

With this function, you can monitor projector functions such as power status, lamp status, input mode, signal condition, lamp-use time, etc. through the network by using the web browser installed on your computer.

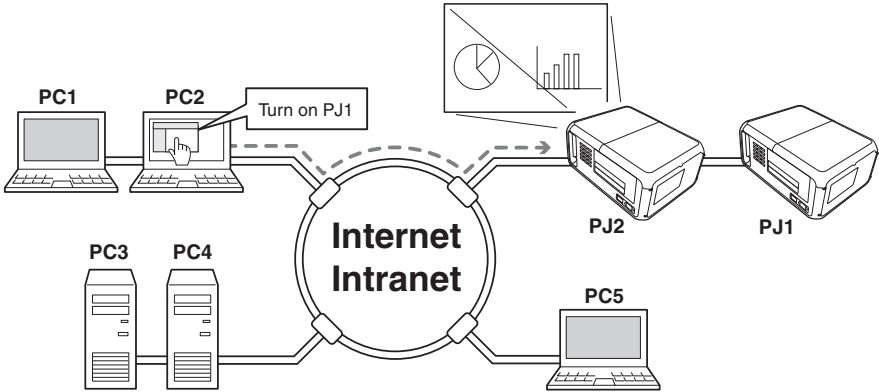

### E-Mail Alert function (☞ p.32)

Projector (Network Board) sends messages to the registered e-mail addresses when a lamp abnormality or power failure occurs with the projector. In this message, it describes how to solve the cause of the problems. You can take efficient action for quick recovery.

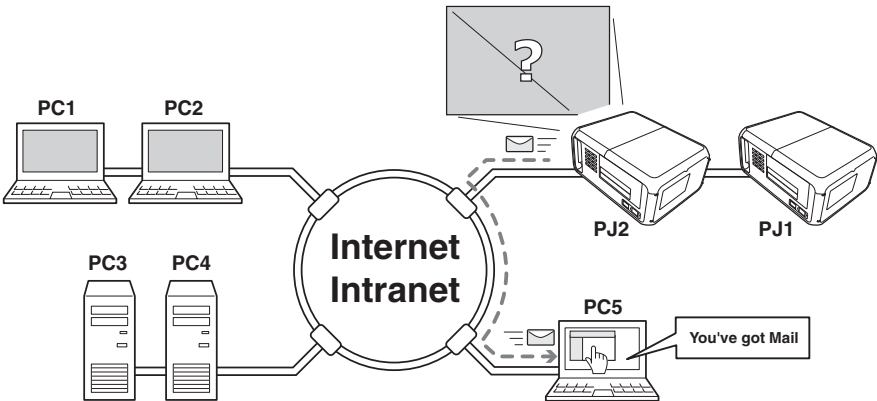

### Multi-control function (☞ p.56)

A single computer can control and set up the multiple computers at the same time.

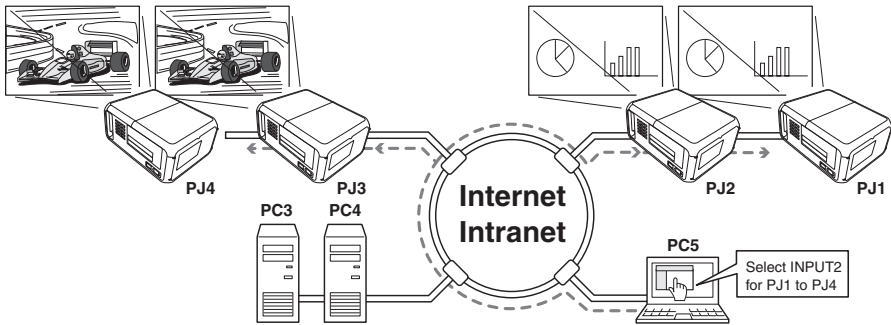

### Automatic On/Off using Timer function (☞ p.47)

Automatically turn on or off the projectors at specified date/day and time by using the clock function.

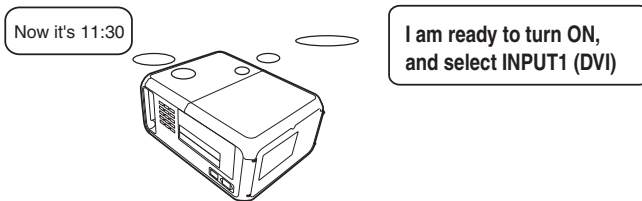

### Control port ready for external equipment via network (☞ p.62)

This product provides a serial port (RS-232C) for controlling external equipment. By connecting the equipment which has a serial port, it can be controlled by a computer via the network. \* This product does not provide the interface driver software to control external equipment.

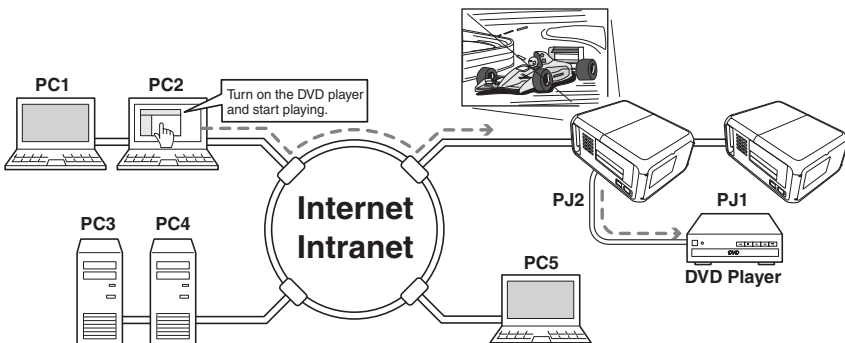

## Operating Environment

To perform the management and setting up the projector using this product, the environment described below is required.

### Operating System

Windows 95 / Windows 98 / Windows 2000 / Windows Me / Windows NT /  
Windows XP / Windows Vista (32bit version)  
Mac OS 8.0 or later

### Network

Network must handle Ethernet correctly and accept TCP/IP protocol.

### Computer

The computer must provide a 10Base-T or 100Base-TX network card.

### Web browser application\*

- Microsoft Internet Explorer version 5.0 or later
- Netscape Navigator version 4.7 or later

\* Use to control and set up the projector. The layout of pages in the browser may slightly differ from each type of application or operating system you use.

### Internet mail application\*

- Microsoft Outlook
- Microsoft OutlookExpress
- Netscape Mail

\* Required the internet e-mail application software to receive an e-mail alert sent from this product. If you do not use the function E-mail Alert, this application is not required.



## The limitation\*<sup>1</sup> of connection between this product and Hub or Computer

Suitable LAN cables are limited by length and type as follows;

Connection	Type of usable LAN cable	Maximum length
Network Board - Hub	UTP Straight Cable with category 3 or 5 * <sup>2</sup>	100m
Network Board - Computer	UTP Cross Cable with category 3 or 5* <sup>2</sup>	100m

\*1 There may be other limitations depending on your network environment or LAN specification. Please consult your network administrator for further details.

\*2 Category of LAN cable indicates the cable quality. Normally, cable with category 3 or 5 is used for 10Base-T network and cable with category 5 is used for 100Base-TX network.

## Notices

### Expression/Abbreviation

The following abbreviations may appear in this manual:

- Windows 95, Windows 98, Windows 2000, Windows Me,  
Windows XP, Windows NT4.0, Windows Vista → Windows
- Macintosh, Power Macintosh → Macintosh
- Mac OS 8 or later → Mac OS

The word "projector" found in this manual means "projector provided with Network unit" unless otherwise noted.

The OS of the computer and the Web browser described in this manual is Windows XP Professional and Internet Explorer 6.0. In case of another OS or Web browser, some instruction procedures may differ from the actual operation depending on your computer environment.

### Use of this manual

This manual does not provide the description of basic operation and functions for computer, web browser, projector and network. For instructions about each piece of equipment or application software, please refer to the respective booklet.

### Trademark

Ethernet is a registered trademark of Xerox Corporation. Microsoft, Windows, Windows NT are registered trademarks of Microsoft Corporation. Macintosh, Mac OS are registered trademarks of Apple Computer Inc. Internet Explorer is a registered trademark of Microsoft Corporation. Netscape Navigator and Netscape Communicator are trademarks or registered trademarks of Netscape Communications Corporation. JavaScript is a registered trademark of Sun Microsystems, Inc.

DLP is a registered trademark of Texas Instruments. BrilliantColor and DynamicBlack are trademarks of Texas Instruments.

Other product or brand names in this manual are registered trademarks or trademarks of their respective owners.

\* Unauthorized use of a part or whole of the contents in this manual is prohibited.

\* The contents of this manual are subject to change without notice.

## Chapter 2 Installation

---

# 2

## Flow of installation

The following are instructions for attaching this product to the projector and connecting it to the network. Please review the entire procedure to become familiar with it.

### 1 Function of the Network Board (☞ p.13)

Check the contents of a package. This product contains a network board, owner's manuals (2 books), a ferrite core and 2 screws. Also check the name and function of each part.

### 2 Installation and network configuration (☞ p.14-23)

- 1 Mount this product onto the projector.
- 2 Connect the LAN cable and join it to the network.
- 3 Configure the network of the Network Board.\*1
- 4 Set the password.\*1

\*1

The procedure of the network setting up and network PIN code/Password may differ from the actual depending of the projector's model types.

See pages 16 to 19 for the case "Projector provides the Network main menu".

See pages 20 to 22 for the case "Projector provides the Network sub menu in the Setting main menu".

Set up is completed.

The preparation to control the projector connected to the network is completed. At the next step, set up and control the projector via the network by using the web browser installed on your computer. Please see chapter 3 "Basic setting and operation". (☞ p.25)

# 1 Name and function of each part

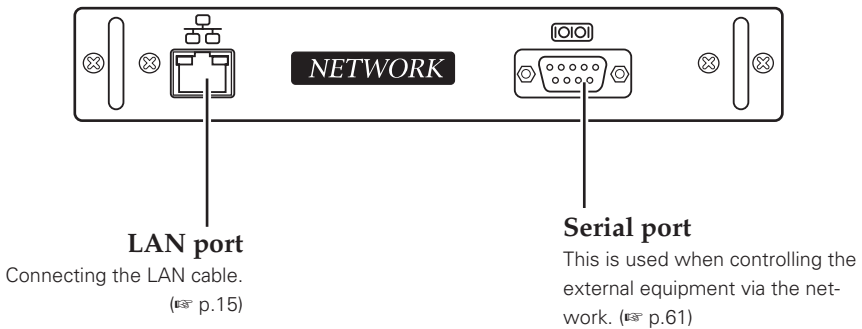
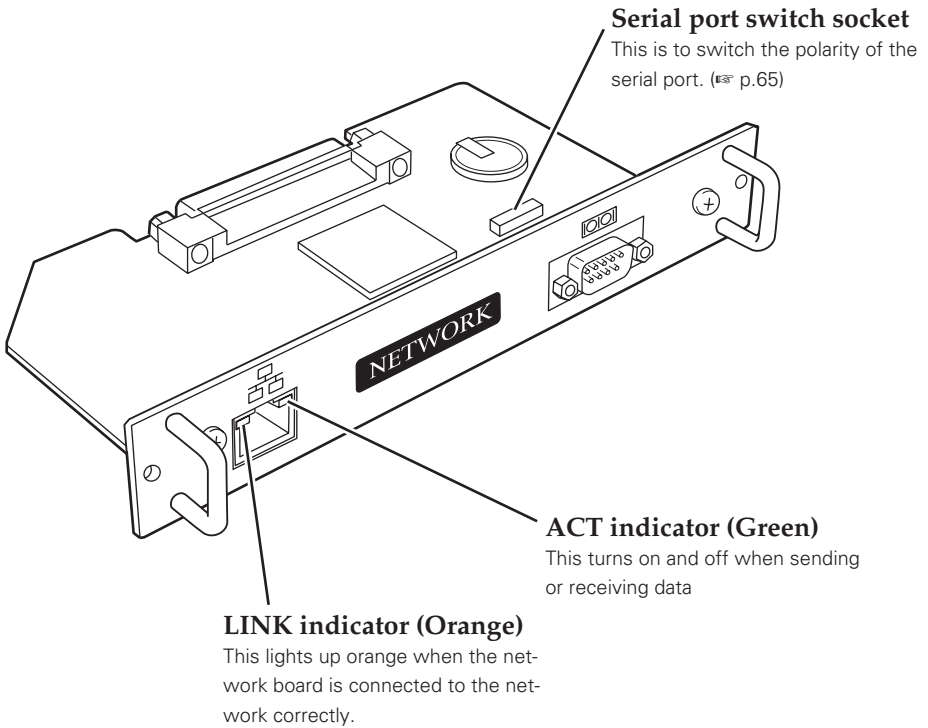

**Caution**

Do not touch the connector. It may damage the product.

ENGLISH

## 2 Installation and Network configuration

### Mounting

1 Turn the Mains switch off.

NOTE;

When replacement of terminal board, MAIN ON/OFF switch should be OFF position.

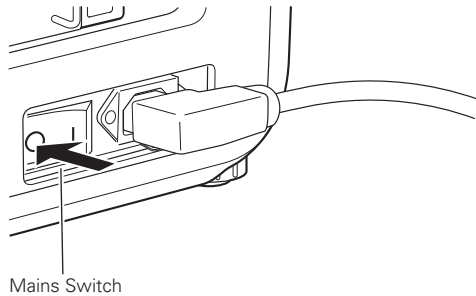

2 Remove 2 screws on a board from any of the slots 1 to 4\*, and then pull the board out from the projector.

\* The number of the slots may differ from the actual depending on type of the projector.

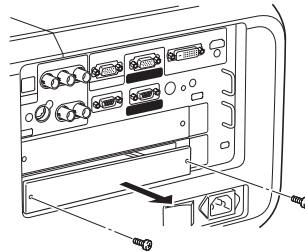

3 Put the Board into the board slot along the guide. Mount the board connector into the socket in the slot firmly.

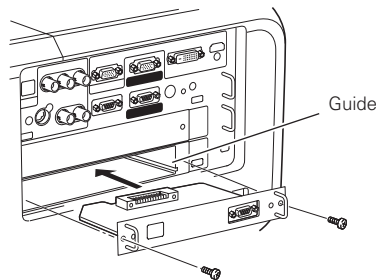

4 Secure the board with two screws (supplied).

\* Mounting example of the 2 slots model.

### ⚠ Caution

- ⚠ Mains switch must be turned off when mounting or removing this product otherwise it may damage the product.
- ⚠ Do not install multiple network boards into a projector otherwise it may damage the product.
- ⚠ Do not connect the AC cord until after connecting the LAN cable and computer.

## Connection of LAN cable

To connect to the network, it is required to use the UTP (Unshielded Twisted Pair) straight cable with RJ-45 plug. There are two different types of cables depending on whether the network is constructed with 10Base-T or 100Base-TX. Prepare the Hub (10Base-T or 100Base-TX) to distribute the network cable if required.

**1** Turn the Mains switch off.

**2** Wind the UTP straight cable once around the ferrite core (supplied) as the illustrated below.

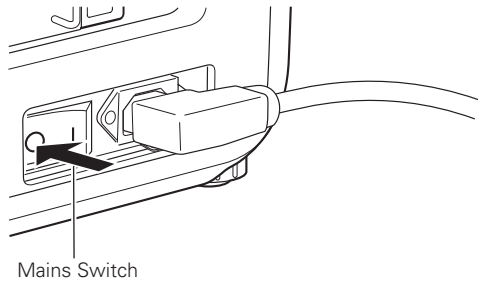
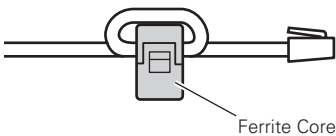

**3** Connect the UTP straight cable to the LAN port on the network board.

**4** Connect the UTP straight cable to the hub.

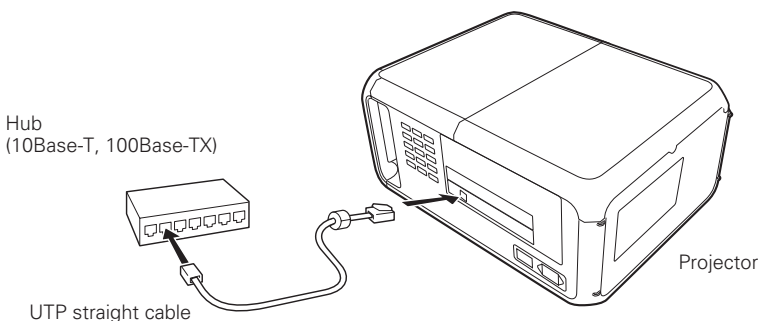

- ☞ Use the UTP cross cable when you connect the computer and projector directly not using the hub.
- ☞ When you connect the projector into the 10Base-T network, use cable with category 3 or 5. When you connect the projector into the 100Base-TX network, use cable with category 5.
- ☞ The length of cable between hub and projector should be less than 100m.

## Network configuration (Type1)

### Confirmation of the network menu

When installing this product to the projector, the network on-screen menu items for this product are activated automatically. If not activated, the product may not have been installed correctly. Please check item "Mounting" (p.14).

### Configure the network

When you connect the projector to the network, the network number of projector must be the same as the network you intend to connect. You should configure projector's network first.

This example explains how to set the following configuration.

IP Address	: 192.168.1.201
Subnet Mask	: 255.255.255.0
Default Gateway	: 192.168.1.1
DNS	: 0.0.0.0

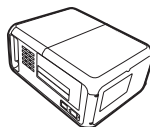

The default network configuration is set as follows.

IP Address	: 192.168.0.2
Subnet Mask	: 255.255.255.0
Default Gateway	: 0.0.0.0
DNS	: 0.0.0.0

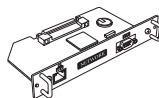

## 1 Selection of network menu

Turn on the projector and display the menu on the screen. Select network icon from the main menu and then press **SELECT** button once. Check that the mode is "On". If not, change mode to "On" using the point buttons (◀▶).

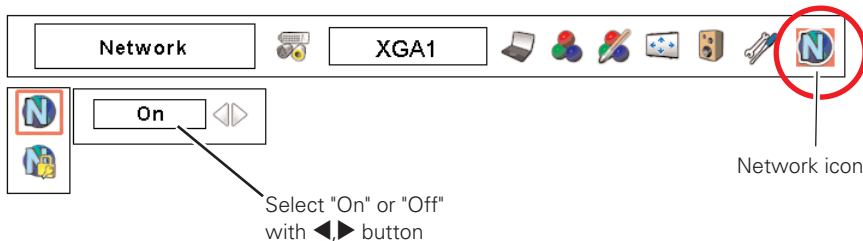

\* The above on-screen display may differ from the actual display depending on the functions of the projector you use.



## 2 Configuration for IP Address/ Subnet mask/Default Gateway\*/DNS\*

Press **SELECT** button again. The following network setting pallet appears on the screen.

Enter the specified network addresses.

IP address	192	168	1	201
Subnet	255	255	255	0
Gateway	192	168	1	1
DNS	0	0	0	0
	Set		Cancel	

The red frame moves sequentially left or right with ◀▶ button.  
The number up or down with ▼▲ button.

### How to enter the numbers

There are 2 ways to enter the numbers, one is by using the point buttons (▼▲) on the remote control or on the projector, the other is by using the screen 10-key pallet by which the numbers can be entered directory. For further information see "How to enter the numbers with the screen 10-key pallet" (p.19).

### 3 Restart the Network board

After completing the entering of address, select "Set" and press **SELECT** button. The network unit starts re-booting and displays message "Please wait..." on the screen until the re-booting is complete. Do not turn off the mains switch during this period.



### Completing of installation

Now the installation is completed. The IP address of this projector is set to "192.168.1.201".

Item	Description
IP address .....	Sets IP address of the projector
Subnet .....	Sets Subnet mask. Normally sets 255.255.255.0
Gateway*1 .....	Sets IP address of the default gateway (Router)
DNS*2 .....	Sets IP address of the DNS server. Must be set when using the e-mail function

\*Refer to the projector's owner's manual for operation of the projector.

\*1 In the network environments not using a Gateway or Router, the Default Gateway address should be set to [0.0.0.0].

\*2 If you do not use the functions E-mail or DNS server, it should also be set to [0.0.0.0] for the DNS address.

### Network PIN code setting

The Network PIN code can be set to restrict access to the setting page of the projector using the web browser.

🔑 Default Network PIN code [0000] means no Network PIN code is set.

#### 1 Displaying Network PIN code menu

Select network menu and then select "Network PIN code" sub menu. Press **SELECT** button twice to display the Network PIN code entry pallet.

\* The number on the pallet is the current Network PIN code.

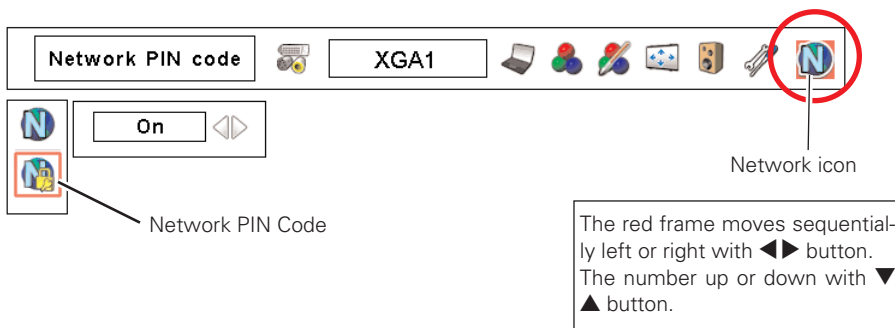

#### 2 Entering the Network PIN code

To enter the Network PIN code, use point buttons (▲▼◀▶) on the projector or the remote control.

#### 3 Fixing the Network PIN code

After entering a 4-digit number, select "Set" by using point buttons (◀▶) and then press **SELECT** button.

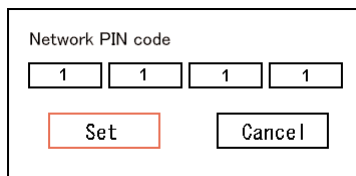

🔑 The screen 10-key pallet can be used for entering the Network PIN code. See item "How to enter the numbers with the screen 10-key pallet" (📖 p.19)

🔑 It is recommended to set up the Network PIN code when you connect the projector to the network. This setting is carried out through the projector's menu and also it can be set through the network using the web browser. For further information please refer to item "Initial Setting/Password setting" (📖 p.30).

🔑 Valid characters for password are only 4 digits numeric numbers 0 to 9. The number "0000" means no password set.

🔑 This Network PIN code is not to restrict the use of the projector. This Network PIN code is to set the security against the use of the projector through the network.

## How to enter the numbers with the screen 10-key pallet

1. Select a column with a red frame by using the point buttons ◀▶.
2. Press **SELECT** button. The screen 10-key pallet appears on the screen.
3. By using the point buttons(▼▲◀▶), select numbers 0 to 9 and press **SELECT** button. By repeating the above to enter the complete number on the column.  
\*To change the number in a column, select "C" and press **SELECT** button to clear the number in the column and then enter the number again.
4. After entering the number in the column, select a move key (◀▶▲▼) located on the lower part of the pallet repeatedly to move the red frame.
5. Repeat steps 3 to 4 for entering all the network address.
6. After finishing, select "Exit" and press **SELECT** button. The 10-key pallet disappears on the screen.

IP address	192	168	1	201
Subnet	255	255	255	0
Gateway	192	168	1	1
DNS	0	0	0	0
	Set		Cancel	



## Network configuration (Type2)

### Confirmation of the network menu

When installing this product to the projector, the network on-screen menu items for this product are activated automatically. If not activated, the product may not have been installed correctly. Please check item "Mounting" (p.14).

### Configure the network

When you connect the projector to the network, the network number of projector must be the same as the network you intend to connect. You should configure projector's network first.

This example explains how to set the following configuration.

IP Address	: 192.168.1.201
Subnet Mask	: 255.255.255.0
Default Gateway	: 192.168.1.1
DNS	: 0.0.0.0

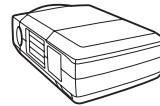

The default network configuration is set as follows.

IP Address	: 192.168.0.2
Subnet Mask	: 255.255.255.0
Default Gateway	: 0.0.0.0
DNS	: 0.0.0.0

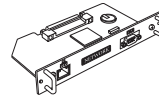

### 1 Selection of network menu [Network]

Turn on the projector and display the menu on the screen. Select the **Network** icon from the **Setting** sub menu using the point buttons (▼▲◀▶) and then press the **SELECT** button on the remote control or on the projector. Confirm that its mode is set "On". If not, change mode to "On" using the point buttons ◀▶.

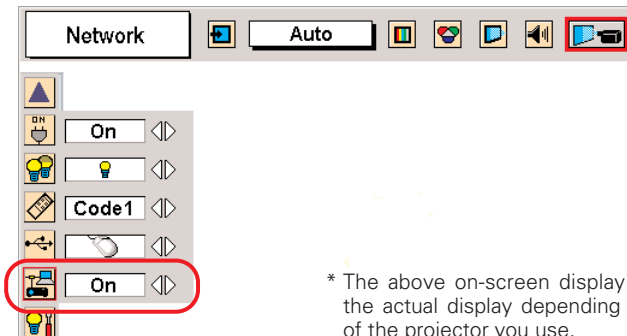

\* The above on-screen display may differ from the actual display depending on the functions of the projector you use.

## 2 Configuration for IP Address/ Subnet mask/Default Gateway\*/DNS\*

Press the **SELECT** button again, the following network setting menu appears on the screen. Enter the specified network address with the point buttons (▼▲◀▶). The following is an example of a network configuration.

NETWORK SETTING				
IP Address	192	168	1	201
Sub net	255	255	255	0
Gateway	192	168	1	1
DNS	0	0	0	0
			SET	CANCEL

### How to enter the numbers

To move the selection and change the values, use the point buttons (▼▲◀▶) on the projector or on the remote control.

The point buttons ◀▶ are used to select the column.

The point buttons ▼▲ are used to change the numbers up and down.

## 3 Restart the Network board

Select the **SET** with the point buttons (◀▶) and press the **SELECT** button again. The network configuration display disappears and the network board begins restarting\*. It takes about 40 seconds. Do not turn off the mains switch during this period.

## Completing of installation

Now the installation is completed. The IP address of this projector is set to "192.168.1.201".

\* In the network environments not using a Gateway or Router, the Default Gateway address should be set to [0.0.0.0]. If you do not use the functions E-mail or DNS server, it should also be set to [0.0.0.0] for the DNS address.

## Password setting [Display]

A password can be set to restrict access to the setting pages of the projector using the web browser. The default password is set "0000" as no password.

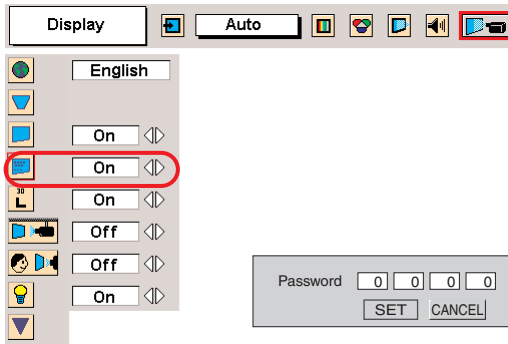

- 1 Use the projector's menu and select the **Setting** icon on the menu.
- 2 Select the **Display** sub icon from the submenu, and then press the **SELECT** button once. Check that the mode is "On".
- 3 Then press the **SELECT** button once again.
  - \*The setting window appears. The numbers on the display indicates the current password.
- 4 Enter your desired number by using the point buttons on the projector or remote control, and then select **SET** and press the **SELECT** button.
  - \*The password setting window disappears and the Network Board begins restarting. It takes about 40 seconds. Do not turn off the mains switch during this period.

- 🔑 Password setting must be done when you connect the projector to the network. This setting is carried out through the projector's menu and also it can be set through the network using the web browser. For further information please refer to item "Initial Setting/Password setting" (p.30).
- 🔑 Valid characters for password are only 4 digits numeric numbers 0 to 9. The number "0000" means no password set.
- 🔑 This password is not to restrict the use of the projector. This password is to set the security against the use of the projector through the network.

## Notice about system construction

### **For installation of multiple projectors into the same network with Network Board.**

Do not install multiple projectors with Network Boards that have their default network settings to the same network. The use of the Network Boards which have the default IP address set to the same network settings will cause IP addresses to collide and create a malfunction. When you install multiple projectors into the same network, configure the network with the following steps.

1. Change the IP address from the default IP address. To change the IP address, use the network setting menu on the projector. Please see chapter "Network Configuration" for further information (p.16-22).
2. Make sure that there is no network equipment set with the same IP address in the network, and then connect to the network.
3. When installing other projectors, follow the above steps to change the IP address and connect to the network.

### **In case of installing the projector with Network Board into the network constructed with the DHCP/BOOTP server.**

This Network Board does not support the DHCP/BOOTP server. The static IP address must be manually configured. To use this product in this network environment, set it up so that the DHCP/BOOTP server does not assign the IP address configured to this product for another device on the network. Please consult your network administrator for further information.





# Chapter 3

## Basic Setting and Operation

---

# 3

ENGLISH

This chapter describes basic operations and settings for controlling the projector via a network using this product. It is required that computer and projector are connected to the network and the network address be properly configured.

## Login the setting page of the projector

### 1 Enter the IP address

Launch the web browser installed in your computer, enter the IP address into the "Address" on the browser and then press the "Enter" key.

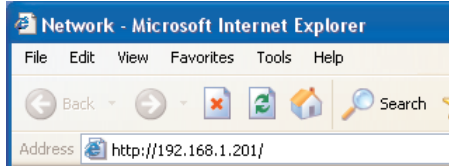

Enter the IP address that you configured in chapter "Network Configuration" (p.16-22). The default IP address is [192.168.0.2].

### 2 Select a display mode and login

This product provides 2 types of control mode, Graphic Mode and Text Mode as the below. Select a proper mode to match your computer and network environment by clicking on the text link.

Once you select your desired display mode, the setting page you selected display mode will be displayed automatically from the next login. To change the display mode, click "Top" on the lower-left corner of the setting page (p.27).

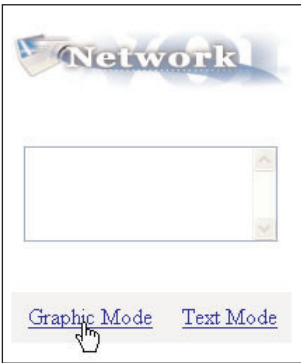

#### **Graphic Mode**

Displays with 600 x 400 dots and the menus and settings with graphic icons. This mode is recommended for standard use.

#### **Text Mode**

Displays with 200 x 300 dots. This mode is optimized for use of the handheld computer, PDA, etc. It is also convenient if the network traffic is heavy.

If the setting page has set the password, the authentication window will appear. In this case type "user" onto the **User Name** text area and the login password onto the **Password** text area and then press the **OK** button.

\* The entering **User Name** must be "user" and it cannot be changed.



[Note]

When accessing projector for the first time or setting the no password [0000], the auto-login will be performed and the next main setting page is displayed.

### 3 Display of main setting page

The following main setting page will be displayed according to your display mode selection. Perform the various kinds of setting through this page. Click on the linked text to display the control and setting pages.

#### 1 Main setting page in the Graphic Mode display

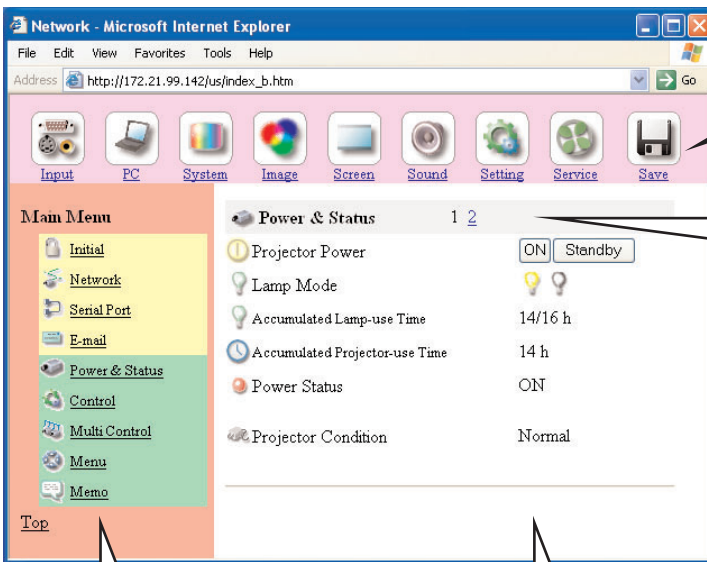

**Control sub menu**  
For selection of sub menu to control and set the projector.

**Setting page number**  
browses pages by clicking the linked number.

**Main menu**  
For selection of control and setting items of the projector.  
( p.35)

**Setting page**  
Displays the control and setting items according to the selected menu. The "Power & Status" page is displayed as the default.

**Functions of a representative projector model are mentioned in this manual. Available functions may differ from the actual depending on the projector's model type. The mark of "--" may appear if the projector does not support the function. Please see the owner's manual of the projector to know available functions.**

\* This graphic mode display is mainly used through this manual for the setting and control description.

**2** Main setting page in the Text Mode display

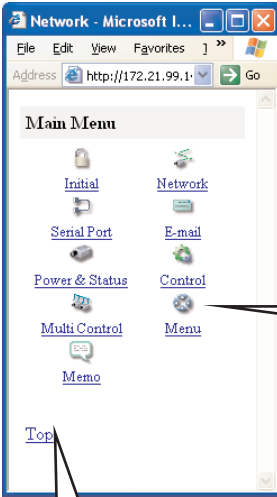

**Main menu**  
For selection of control and setting items of the projector. Displays sub menu and status of selected items when clicking the linked text.

Returns to the display mode selection page.

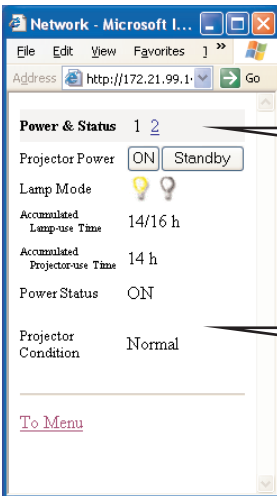

**Setting page number**  
Browses pages by clicking the linked number.

**Setting page**  
Displays the control and setting items according to the selected menu.



## Initial Settings

After installing this product to the projector, perform the following basic initial setting.

Click on the **Initial** linked text on the main menu to display the initial setting page. The Languages, Date/Time and Password can be set in this page. The model name of the projector on which this product is mounted is displayed on the page.

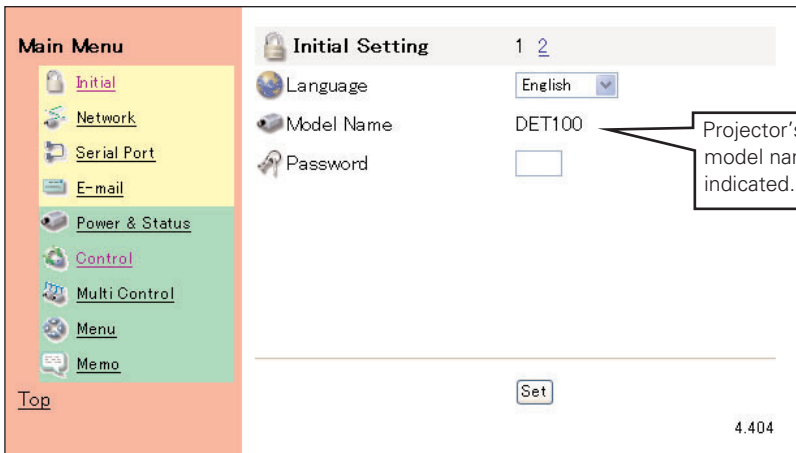

### 1 Language Setting

This setting is to select the display language of the web page. Select your language with the pull-down menu button and then press the **Set** button. The selectable language is English or Japanese. You may find the unrecognized character text in the menu if the computer does not provide Japanese fonts.

#### [Note]

This language selection is realized by using the JavaScript function of the web browser. If the preference of the browser is set not to use the JavaScript, the "Set" linked text appears on the page as the below. Click on its text to change the language display. There are various kind of ways to change this preference depending on the web browser's version and application. Please refer to chapter "Appendix: Web browser setting/Active Script (JavaScript enable)" (p.72).

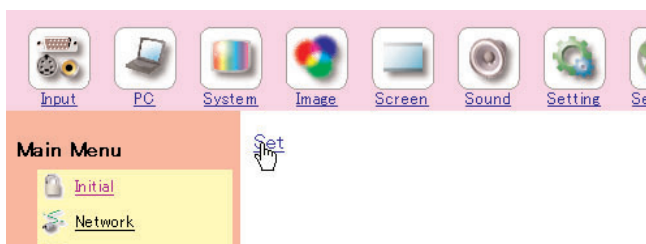

## 2 Password Setting

This page is to set the password to restrict the access from an unauthorized person through the network.

Enter the password onto the text box and press the **Set** button.



The Network Board begins restarting and it takes about 40 seconds. Close (Quit) the web browser and access to the login page again in 40 seconds. This is to perform the login authentication firmly.

The default password [0000] means no password. You should change password from the default in normal use. When you connect the projector with this product to the network, you should set a password. Only a four-digit numeric number is valid characters for the password.

\* If you forget the password to the projector, you can check it with the menu on the projector. For further information, please see item "Network PIN code" (p.18) or "Password Setting" (p. 22).

## 3 Date/Time Setting

Click on the page number "2" to display the Time Setting page.

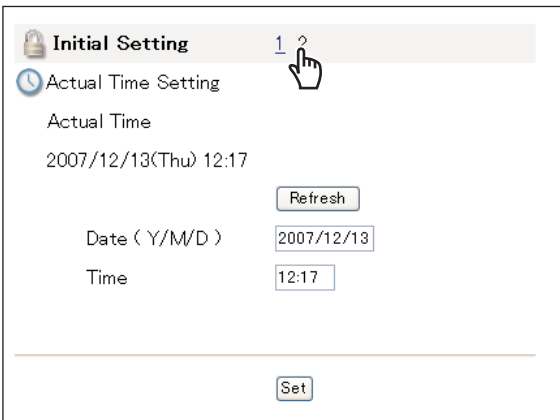

Type present date onto the date text area with (Year/Month/Date) format and type present time onto the time text area with (Hour:Minute) format in 24 hours indication. Press the **Set** button and confirm that the data and time are set correctly. The displayed date and time are not updated automatically, press the **Refresh** button to get the present date and time.

### Caution

#### Use of Battery

This product provides a lithium battery. When the battery runs down, the clock and timer functions do not operate properly. Contact your local dealer for the replacement of battery. The replacement must be carried out by a qualified service personnel. Prohibit the battery replacement by user because of a risk of explosion.



## Network Configuration

Click on the **Network Setting** linked text on the main menu. The following setting page is displayed. This page is to set the IP Address, Subnet Mask, Default gateway, DNS (Domain Name Server) and projector name.

Main Menu	Network Setting
<ul style="list-style-type: none"> <li>Initial</li> <li><b>Network</b></li> <li>Serial Port</li> <li>E-mail</li> <li>Power &amp; Status</li> <li>Control</li> <li>Multi Control</li> <li>Menu</li> <li>Memo</li> </ul>	<p>IP Address <input type="text" value="172.21.99.142"/></p> <p>Subnet Mask <input type="text" value="255.255.255.0"/></p> <p>Default Gateway <input type="text" value="0.0.0.0"/></p> <p>DNS <input type="text" value="0.0.0.0"/></p> <p>Projector Name <input type="text"/></p> <p style="text-align: right;"><input type="button" value="Set"/></p>

### 1 Configure the network

The IP address and Subnet Mask have been configured already in chapter "Installation". If you want to change them or configure default gateway\*<sup>1</sup> or DNS\*<sup>2</sup>, perform them in this page. Enter an applicable address number onto each parameter and press the **Set** button.

The Network Board begins restarting and it takes about 40 seconds. Close (Quit) the web browser and access to the login page again in 40 seconds.

You must use the number specified by your administrator. The address must be entered as a group with four numbers split by dots like [192.168.1.101].

### 2 Name the projector

You can name\*<sup>3</sup> the projector. By setting this name properly for the DNS server, the projector can be accessed by using this name instead of the IP address.

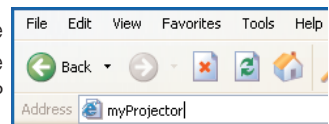

For further information, please consult your network administrator.

\*1 Set [0.0.0.0] if the network does not provide the gateway (router).

\*2 Set [0.0.0.0] if you do not use the function E-Mail alert.

\*3 If you use the DNS server, register the host name registered to the DNS server as a projector name. You can access with this projector name from any computers in your network. If you do not use the DNS server, access with the IP address assigned to the projector.



## E-mail Setting

This product has an E-mail function which can send an alert message to users or an administrator if it detects an abnormality on the projector or run out of the life span of the lamp. Click on the **E-Mail Setting** linked text on the main menu and follow the below steps.

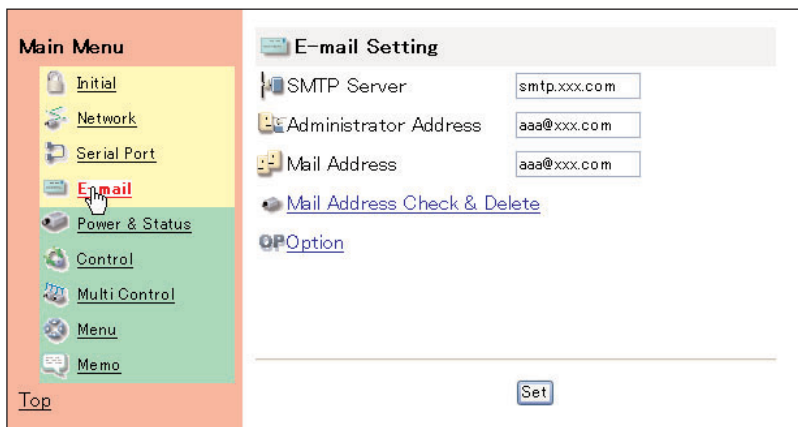

### 1 Registering SMTP Server\*1, Administrator Address

Type the E-mail address of SMTP server and administrator and press the **Set** button. The administrator address is set to "Reply-To" address sent from the projector.

\*1 The SMTP server is a server for sending E-mail. Please contact your network administrator to have this SMTP server address.

\* If the network board sends an alert message due to the abnormality on the projector but the SMTP server is down in some reason, the message will not be sent. In this case, the message "Unable to connect to server" will be displayed on this page. To clear this message, click the **Set** button.

- ☞ To use the E-mail function, it must be set the DNS address on the Network Setting page correctly.
- ☞ You cannot use this E-mail function if the DNS server and SMTP server cannot be used in your network environment. If the SMTP server is located in your LAN (Local Area network), the address set to SMTP server should be specified in the SMTP server located in your LAN. The server located outside of your LAN may not be available for security reason. For further information please contact your network administrator.
- ☞ Up to 10 e-mail addresses can be registered.



## 2 Registering and deleting E-mail addresses

Type the E-mail address onto the **Mail Address** text area and press the **Set** button.

To check the registered addresses, click on the **Mail Address Check & Delete** linked text. The addresses are listed as the figure on the right.

To delete the registered addresses, check the address you want to delete and press the **Delete** button.

[Mail Address Check & Delete](#)

**Check & Delete**

- aaa@xxx.com
- bbb@xxx.com
- ccc@xxx.com

[Return](#)

## 3 Condition selection for sending alert message

Click on the **Option** linked text. Check the condition items under which alert messages will be sent and press the **Set** button.

[Option](#)

Please refer to chapter "Examples :Type and contents of alert messages" described on the next page.

**Mail Option** 1 2

- Filter Warning

**Mail Option** 1 2

- When the projector lamp is off.
- When the life span of Lamp is reached.
- When projector needs service.
- When internal projector temperature is too high.
- When the projector is turned off with power ON/OFF button.
- When Power management function turns the projector lamp off.
- When the signal is interrupted.

[Return](#)

\* The mail option item may differ from the actual depending on the projector's function.

## Examples: Type and contents of alert mail

When the projector has an abnormality, the following alert messages are sent to the registered E-mail address according to your selected condition. Administrator or user can take an efficient action quickly by receiving this message. This is very useful to maintain and service the projector.

The following are examples of received messages.

### ● When the internal temperature is too high:

```
TITLE: Message from projector
01-12-2007 00:59
Projector Model Name: Model Name
TCP/IP: 192.168.0.2 Projector Name: myProjector
```

It sends you following message.

\*The Projector lamp is turned off, because internal projector temperature is too high.  
Wait Temperature Warning Indicator turned off, turn the Projector on again.  
If the Indicator continues to flash, check the air filter for dust accumulation.

```
[A] 36.5 Degree [B] 58.2 Degree [C] 37.8 Degree
Temperature of Sensor B is too high.
```

☞ The Network Board let users know which thermal sensor [A], [B] or [C] inside the projector detected the abnormal temperature risen and so the projector was turned off. Please refer to item "Check the status of projector" for the location of the sensors [A], [B], [C], and temperature (☞ p.37). Also see the owner's manual of the projector for further details.

\* Sensor [C] may not be supported depending on the projector models.

### ● When projector needs service:

```
TITLE: Message from projector
01-012-2007 00:58
Projector Model Name: Model Name
TCP/IP: 192.168.0.2 Projector Name: myProjector
```

It sends you following message.

\*Maintenance requirement from Projector is detected.  
Check up LED statuses of projector and consult with the dealer.  
Information : FFFFFFFFFF

☞ Maintenance requirement from Projector is detected. Unplug the AC power cord and plug it, and then turn on the projector once again to verify operation. If the problem still persists, unplug the AC power cord and ask servicing to a qualified service personnel with the information code.

\* Contents and format of the information code may differ from the actual depending on each projector's model type.

### ● When the life span of lamp is reached:

```
TITLE: Message from projector
01-12-2007 00:58
Projector Model Name: Model Name
TCP/IP: 192.068.0.2 Projector Name: myProjector
```

It sends you following message.

\*The life span of lamp2 is reached.  
Lamp2 replacement is required.  
Lamp1 ON 350 h  
Lamp2 ON 500 h  
Lamp3 ON 60 h  
Lamp4 ON 350h

☞ Replace it with a new lamp immediately and reset the lamp counter. If the projector is used without resetting the lamp counter, the alert mail is sent to users every time the projector is turned on. This alert mail will not be sent when unchecking the mail sending condition "When the life span of lamp is reached".

\* Lamp3 and Lamp4 are not indicated if the projector support dual lamp system only.

# Chapter 4

## Controlling the Projector

---

# 4



## Power on/off the projector

Click on the **Power & Status** linked text on the main menu. The control page will be displayed.

By Pressing the **On** or **Standby** button on the page, the power of the projector can be controlled. When you press the **Standby** button, another confirmation popup window\*1 will appear, and then press the **OK** button if it is set to standby.

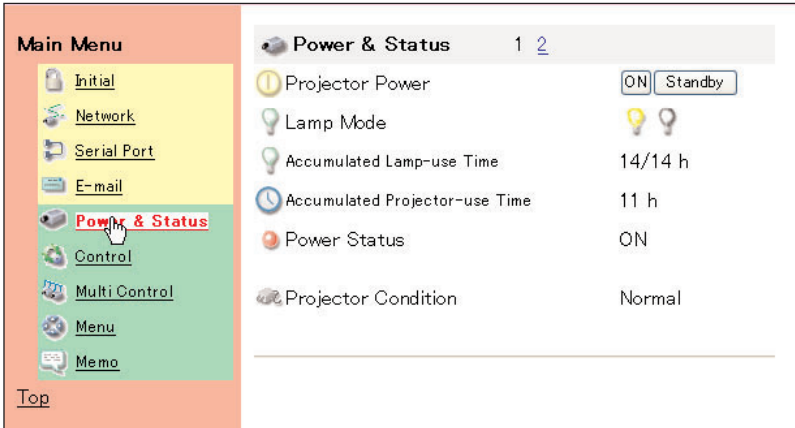

### [Note]

\*1 This popup window is realized by using the JavaScript function of web browser. If the preference of the browser is set not to use JavaScript, the popup window will not appear on the screen.

There are various kind of ways to change this preference depending on the web browser's version and application. Please refer to chapter "Appendix: Web browser setting/Active Script (JavaScript enable)" (p.72).

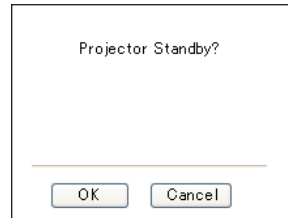
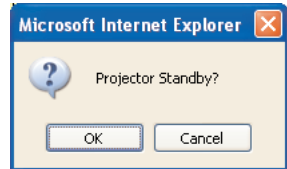

☞ The projector is not turned on for about 90 seconds after switching into the standby mode. After the power status indicator on the control page changes from "On Cooling down" to "OFF", then try to turn on the projector with **On** button.

☞ The web browser checks and updates projector's condition every 20 seconds automatically.

# Check the status of projector

In the "Power & Status" page, you can control the projector power, and also you can check the status of the projector as follows. To change the page, click on the page number linked text.

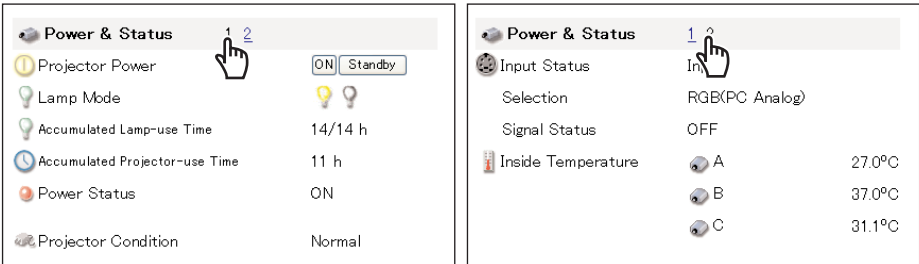

**Items Description**

**Lamp Mode** .....Displays 2 lamps or 4 lamps mode and lamp status as below icons with Lamp1/Lamp2/Lamp3/Lamp4 order.



**Accumulated**

**Lamp-use Time** .....Displays the accumulated lamp use time in hour units (h) and displays each time with Lamp1/Lamp2/Lamp3/Lamp4 order.

**Accumulated**

**Projector-use Time** .....Displays the accumulated projector use time in hour unit (h).

**Power Status** .....Displays the status of the lamp.

**Projector Condition\*** .....Displays the status of the projector's power.

\* When occurring the internal power failure, The word "Power Failure" and error information is displayed.

**Input Status** .....Displays the selected input.

**Selection**.....Displays the selected input mode.

**Signal Status** .....Displays the signal status of the selected input mode.

**Inside temperature** .....Displays the internal temperature of the projector. The icons [A], [B], [C] on the page represent the thermal sensors\*<sup>2</sup> located in the projector. If the temperature at one of those sensors exceeds specified temperature, the appearance of its icon changes to the following alert icon to let users know about the abnormal temperature. Please check surrounding temperature of the projector, check for clogged air filters and check area surrounding the ventilation fans.

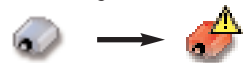

The icons [A], [B] and [C] represent the sensors located in the projector as follows:

[A]: Surrounding temperature of the projector\*<sup>1</sup>

[B]: Internal temperature of the projector

[C]: Internal temperature of the projector\*<sup>2</sup>

\*<sup>1</sup> The indicated peripheral temperature of the projector is a little higher than actual surrounding temperature.

\*<sup>2</sup> Sensor C icon may not indicated depending on the projector's model type.

# Control the projector

The control menus are displayed on the upper side of the page. When you click each control icon, the control page is displayed according to the control menu you selected. The setting method differs depending on the contents of the page. Click on the page number linked texts to change pages and select desired setting items.

- ✎ Please see the owner's manual of the projector to have the further information of each control item.
- ✎ If the adjustment items are not required by the projector itself or input signal, the mark of "--" may be indicated.



- ✎ The control page displays valid control items depending on the selected input mode, signal or functions of the projector you use, therefore, there may be different controls between the described items and actual control items on the page display.
- ✎ When the projector is in standby, only the timer on the setting menu is effective; others are inactive.



## Input

This function is to select the input mode and slot to the projector. Select the input slot with the radio button, and input source mode with the pull-down menu button. Then set the selected input source and source mode by pressing the **Set** button.

Select a slot with radio buttons.

Select a source mode with pull-down menu.

Mounted Board name

Item	Description
Input(SLOT) .....	Displays input number and board name installed in the projector. The setting items differ from the actual depending on the board function.

\* Available slots and indications may differ from the actual depending on the projector's model type.



## PC Adjustment

This function is to adjust the signal from the computer connected to the projector to obtain the proper picture image on the screen. Click on the page number linked texts to change the setting pages.

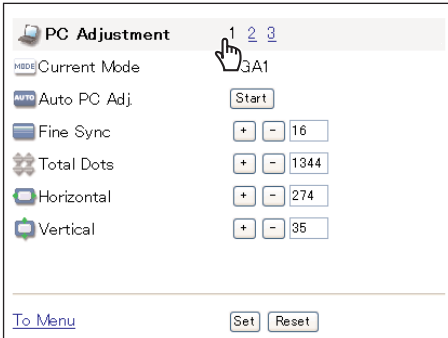

Item	Description
Current Mode .....	Displays current mode of the computer.
Auto PC Adj. ....	Performs automatic adjustment.
Fine Sync.....	Performs Fine Sync adjustment.
Total Dots .....	Adjust the number of total dots in the horizontal period.
Horizontal .....	Adjusts horizontal picture position.
Vertical .....	Adjusts vertical picture position.

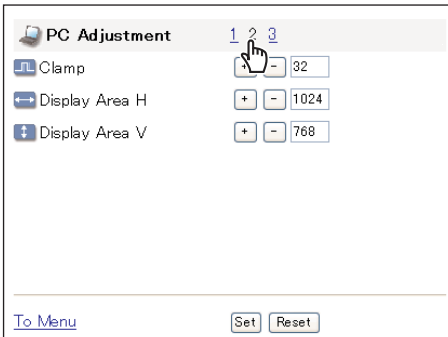

Item	Description
Clamp .....	Adjusts clamp position of the picture.
Display Area H .....	Adjusts the image area horizontally.
Display Area V .....	Adjusts the image area vertically.
Full Screen* .....	Makes the image full screen display.

\* This function is not available for some projector's model types. In such a case, please refer to the section of the screen adjustment (p.44)

☞ These parameters will appear only when the analog computer input mode is selected.

## Save a Set

- 1 Decide your desired PC adjustment values through the PC Adjustment pages "1" to "2".
- 2 Display the page "3" and select a mode number\*1 with the pull-down menu button of the **Save to**. Type a memo into the **Memo** text area for simple description of your selected number.



- 3 Register by pressing the **Set** button. To restore the adjustments, press the **Reset** button.

It is displayed with "Stored" or "Free" for the memo of Mode1 to Mode5. The memo of ExMode6 to ExMode50 can be stored into the selected mode.

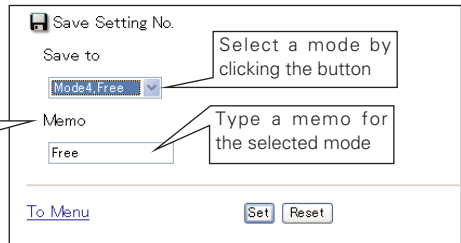

## Load a Set

Select a set to load with the pull-down menu button of the **Load Setting No.** and press the **Set** button. The stored setting values will be applied to the each PC adjustment item.

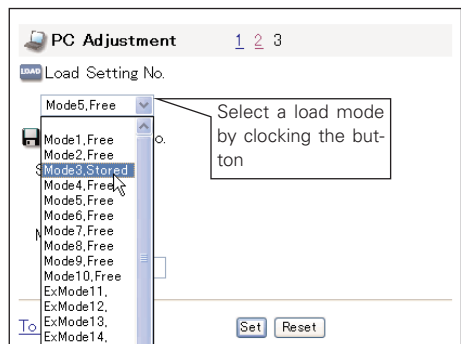

\*1 Available mode may differ from the actual depending on the projector's model type.

Type1: Mode1 to Mode5, ExMode6 to ExMode50

Type2: Mode1 to Mode10, ExMode11 to ExMode50

✎ The Display settings can be stored up to 50 sets, Mode1 to Mode5(Mode10) are stored into the projector and ExMode6(ExMode11) to ExMode50 are stored into the Network Board.







## System Adjustment

This function is to select the color system of video signal or scanning system of component signal input to the projector. Select a system with the radio buttons to match the color system or scanning system of input source, and then press the **Set** button. The displayed systems are switched according to the input mode.

### Available selection when the VIDEO/S-VIDEO input

 **System Adjustment**

 Color System Adjustment

Auto  PAL

SECAM  NTSC

NTSC4.43  PAL-M

PAL-N

---

[To Menu](#) **Set**

Item	Description
Color System	.....Selects a color system of the input video signal.
AUTO	.....It automatically switches to the color system of the input signal.

### Available selection when the Y, Cb/Pb, Cr/Pr input

 **System Adjustment**

 System Adjustment

Auto  1080p

1080i  1035i

720p  575p

480p  575i

480i

---

[To Menu](#) **Set**

Item	Description
System	.....Selects a scanning system of the input component signal.
AUTO	.....It automatically switches to the scanning system of the input signal.

 These selections will not appear when the source mode is set to the computer mode.



## Image Adjustment

This function is to adjust the projected picture image and set the image mode. For selection of image mode, select a desired image mode with the **Image Adjustment Mode** pull-down menu button and then press the **Set** button. The setting items are switched automatically according to selected input mode, computer or video input.

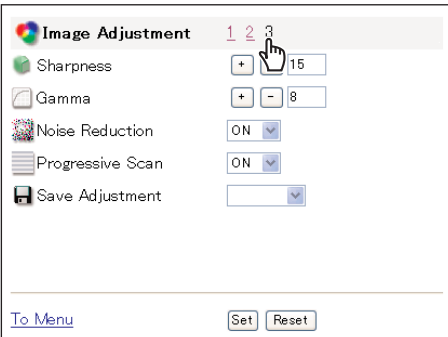
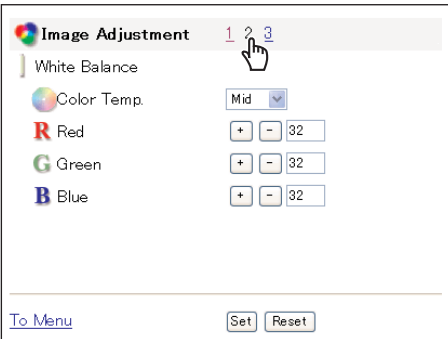
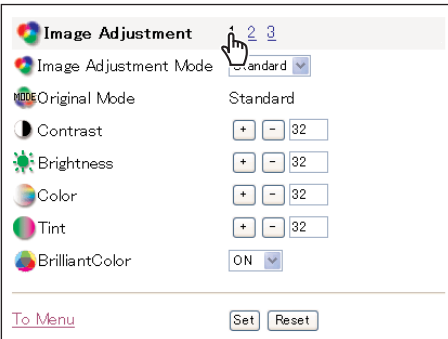

Item	Description
------	-------------

**Image Adjustment\***. Selects image mode among the Standard, Real, Cinema, Dynamic, Image1 to Image4 with pull-down button menu. Image1 to 4 are user preset mode.

**Original Mode** .....Displays which predefined image adjustment mode is based upon.

**Adjustment items** .....Contrast, Brightness, Color, Tint  
**BrilliantColor** .....Improve the color performance with BrilliantColor™ technology.

\* Available image mode may differ from the actual depending on the projector's model type.  
 Type1: Image1 to Image4  
 Type2: Image1 to Image10

Item	Description
------	-------------

**White Balance**  
**Color Temp.** .....Sets a color temperature mode.  
**Red, green,**  
**Blue** .....Adjusts a white balance respectively.

Item	Description
------	-------------

**Sharpness**.....Adjusts picture sharpness.  
**Gamma**.....Adjusts brightness of darker part of the picture.  
**Noise Reduction** .....Switches noise reduction on/off.  
**Progressive** .....Switches progressive mode.  
**Save Adjustment** ....Select a mode to store the image adjustment values.

\* The displayed adjustment items may differ from the actual depending on the functions of projector you use. The error message may appear if the projector does not support the function.

## Save a image adjustment value

- 1 Decide your desired image adjustment value through the image adjustment pages "1" to "3".
- 2 Display the page "3" and select the desired image number\*1 with the pull-down menu of the **Save Adjustment**.
- 3 Register by pressing the **Set** button.  
To restore the adjustments, press the **Reset** button.

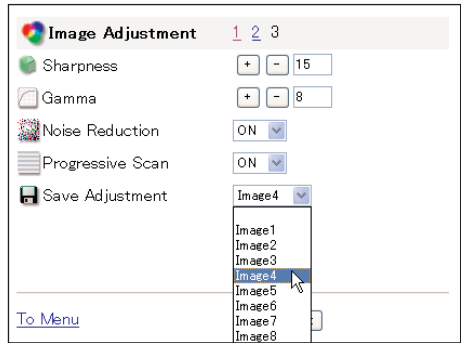

The **Image1** to **Image10** are for the user preset modes to store the image adjustment.

The **Original Mode** is represented the mode that user preset mode **Image1** to **Image10** is created from the predefined image modes **Standard**, **Real** or **Cinema**.

## Load a image mode

Display the page "1" and select a set to load with the pull-down menu button of the **Image Adjustment Mode** and press the **Set** button.

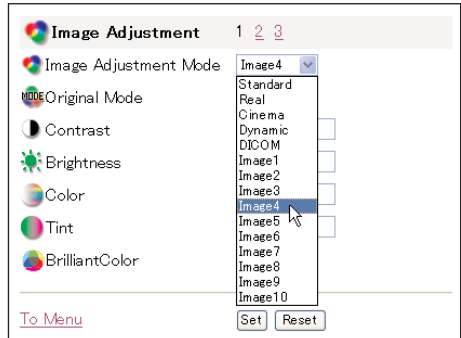

\*1 Available image mode may differ from the actual depending on the projector's model type.

Type1: Image1 to Image4

Type2: Image1 to Image10



## Screen Adjustment

This function is to adjust the screen mode of the projector. The setting items are switched automatically according to selected input mode, computer or video input.

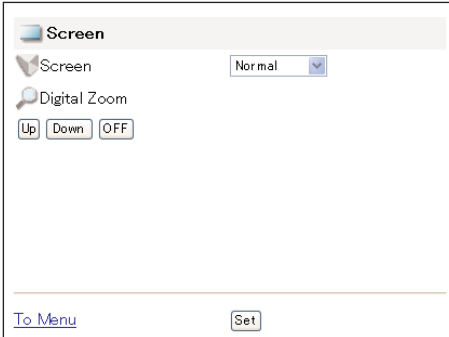

Item	Description
Screen* <sup>1</sup>	Changes the screen mode.
Aspect* <sup>1</sup>	Changes the screen mode.
Computer Input	Normal/True/Wide/ Full screen/Custom
Video Input	Normal/Wide/Custom
True* <sup>2</sup>	Switches the projected image mode.
Digital Zoom* <sup>3</sup>	Adjusts the image zooming or compressing.

\*<sup>1</sup> Either of item "Screen" or "Aspect" is available depending on the projector's model type.

\*<sup>2</sup> Item "True" is not available depending on the projector's model type. In that case, use the screen item.

\*<sup>3</sup> These items are only available in the computer input mode.

\* There may not be available depending on the projector's model type.



## Sound Adjustment

This function is to adjust the sound of the projector. The values in each text box represent the current control value or status.

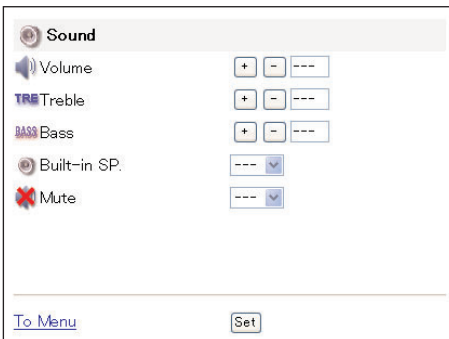

Item	Description
Volume	Adjusts the sound volume from the built-in speakers.
Treble	Adjusts the high-frequency sound band.
Bass	Adjusts the low-frequency sound band.
Built-in SP	Switches the sound output from the built-in speaker
Mute	Suppresses the sound.

\* There may not be available depending on the projector's model type.



## Setting

This function is to set up the projector. Click on the page number "1" to "5" linked texts to change the setting pages.

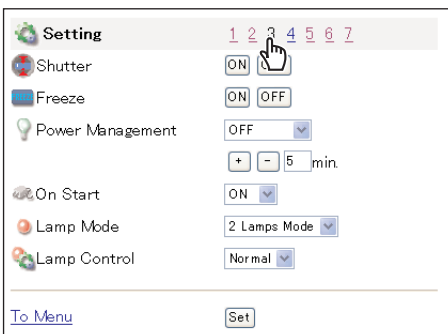
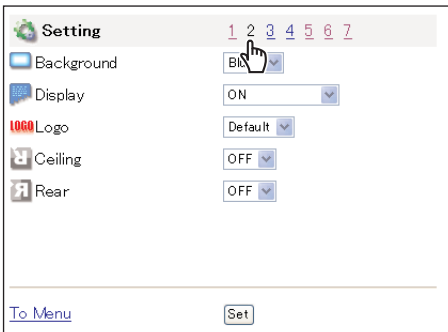
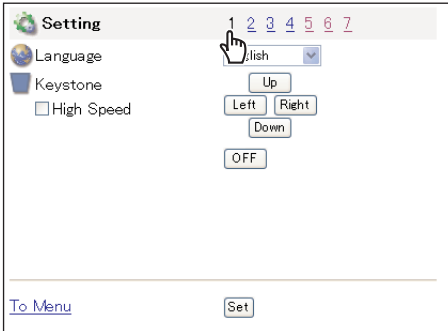

\* The displayed items may differ from the actual depending on the functions of projector you use. The Error message may appear if the projector does not support the function.

Item	Description
Language .....	Changes the on-screen menu language of the projector.
Keystone* .....	Corrects the keystone distortion of the projected image on the screen. It moves quickly if the "High Speed" is checked.

\* The control button [Left], [Right] may be not available depending on the projector's model type.

Item	Description
Background* .....	Sets screen background when no input signal received
Blue Back* .....	Sets screen background color when no input signal received.
Display .....	Sets on-screen menu display
Logo .....	Sets the logo display setting on the screen during the startup.
Ceiling.....	Sets the image top/bottom and left/right reversed.
Rear .....	Sets the image left/right reversed.

\* Either of item "Blue Back" or "Background" may appear depending on the projector's model type.

Item	Description
Shutter* <sup>1</sup> .....	Sets the image black out mode.
No Show* <sup>1</sup> .....	Sets the image black out mode.
Freeze.....	Sets the image frozen mode.
Power Management.....	Sets the power management if the input signal is interrupted and no control key is pressed during the specified period of time. Sets the time periods* <sup>2</sup> until the power management operates.
On Start .....	Sets the power-on mode when turning on the mains switch.
Lamp Mode.....	Switches lamp mode 1 lamp or 2 lamps mode, or 2 lamps or 4 lamps mode.
Lamp Control* ..	Switches lamp control mode

\*<sup>1</sup> Either of item "No Show" or "Shutter" may appear depending on the projector's model type.  
\*<sup>2</sup> The time cannot be setup depending on the projector's model type. In this case please see the projector's owner's manual.

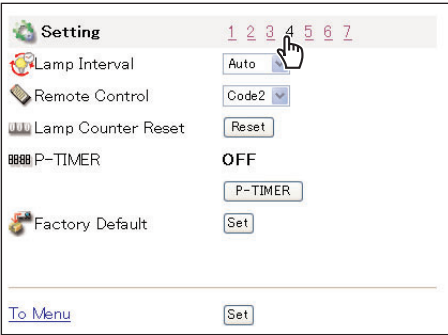

Item	Description
Lamp Interval	....Sets the interval period of switching two lamps.
Remote Control	.....Sets the remote control codes.
Lamp Counter	
Reset	.....Resets the lamp use-time. Reset when replaced lamp.
P-TIMER	.....Used to display the timer on the screen. The status is changed as ON -> STOP -> OFF when this button is pressed repeatedly.
Factory Default	..Restore the value of the setting items to the factory default value.

\* There may not be available depending on the projector's model type.

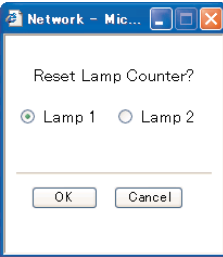

(Set JavaScript On)

\* In case of 2 lamps model

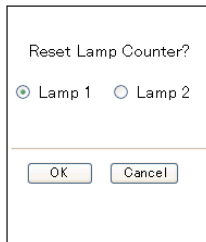

(Set JavaScript Off)

### About Lamp Counter reset

The confirmation window as the left will appear when the Reset button of the "Lamp Counter Reset" is pressed. Select which lamp counter is to be reset with the radio button and then press the OK button.

\* There may fail to be reset depending on the projector's type.

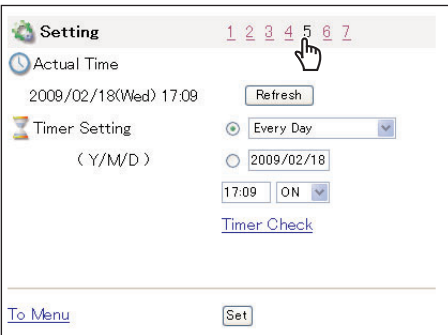
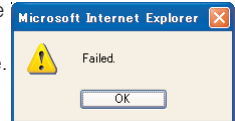

Item	Description
Actual Time	.....Displays the current time set to the projector.
Timer Setting	....Function to switch on or off the projector at the programmed date and time. Please see chapter "How to set the Timer" for further instructions.

\* Please see the pages 48 - 49 for details.

There are various kind of ways to change the JavaScript preference depending on the web browser's version and application. Please refer to chapter "Appendix: Web browser setting/Active Script (JavaScript enable)" (p.72).

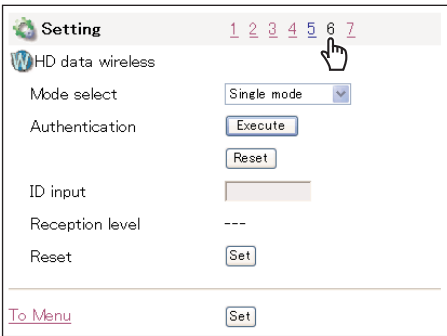

Item	Description
HD data wireless .....	Sets the HD data wireless board.
Mode select .....	Switches the communication mode (Single mode or Broadcast mode).
Authentication .....	Executes or resets the authentication at the Single mode.
ID input .....	Inputs ID number at the broadcast mode.
Reset .....	Restore the value of the HD data wireless setting items to the factory default value.

\* There may not be available depending on the projector's model type.

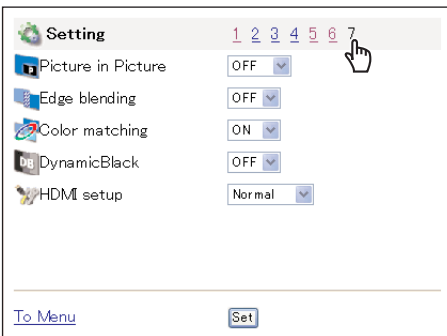

Item	Description
Picture in Picture .....	Sets the "P in P" or "P by P" mode which has been preset in the setting menu. (OFF, User1 - User5)
Edge blending .....	Sets the seamless overlapping for multi-screen.
Color matching .....	Corrects the difference of color for multi-screen.
DynamicBlack .....	Improve the black level of the image. (OFF/Low/High)
HDMI setup .....	Switches Normal or Enhanced according to the HDMI source.

\* There may not be available depending on the projector's model type.

- ☞ When the Picture in Picture mode is ON, there are some restrictions as follows;
- The last memorized input source is displayed in Input menu.
  - "PC Adjustment", "System Adjustment" and "Save Adjustment" are invalid.

## How to set the Timer

This function is used to turn the projector off or on at a programmed day/date and time. Follow the below steps for setting.

### 1 Set a day or date

To set the timer event at same time everyday, select "day" entry with radio button and then select desired day with the pull-down menu button. The selectable days are as follows:

- Same time everyday
- Every week ( a day from Monday to Sunday)
- Every week (Monday to Friday) - Every week (Monday to Saturday)

To set the timer event on specified date, select "date" entry with radio button and then type the date with (Year/Month/Date) format.

Ex.: Type [2007/08/20] if you specify [August 20, 2007].

### 2 Set a time

Type the time with (Hour:Minute) and 24 hours format.

Ex.: Type [18:25] if you specify [PM 6 o'clock and 25 minutes].

### 3 Select an event "ON" or "OFF".

Select an event ON or OFF with the pull-down menu to turn on or off the projector.

### 4 Register an event

Press the **Set** button to register the set timer event. Repeat steps 1 to 4 for another timer event setting.

## Check the Timer events

To check the set timer events, click on the **Timer Check** linked text.

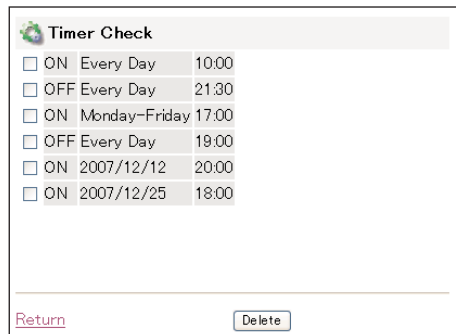
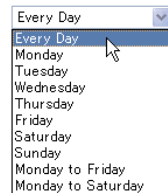
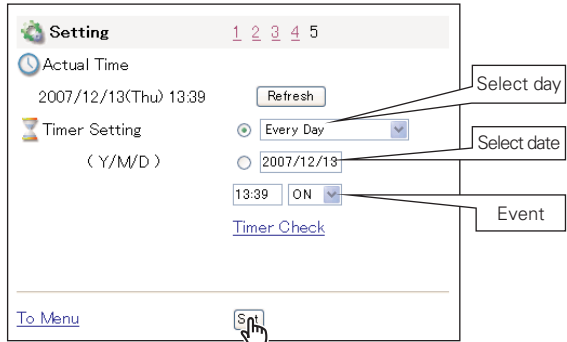



## Getting the current time

The displayed time is the value set when the setting page was displayed. This time value is not updated automatically. To update the display time press the **Refresh** button.

## Notes on timer setting

Up to 10 timer events can be registered. Timer events always operate according to the next valid event depending on the projector's power status. In the example below, event 3 turns on the projector so next event 4 (also turning on projector) will not be effective because the projector is already turned on. Similarly, when the projector is turned off by event 5, event 6 OFF will not be effective in turning it off again. But these secondary events (event 4 and event 6) will become effective if a person turns off the projector (after event 3 and before event 4) or turns on the projector (after event 5 and before event 6).

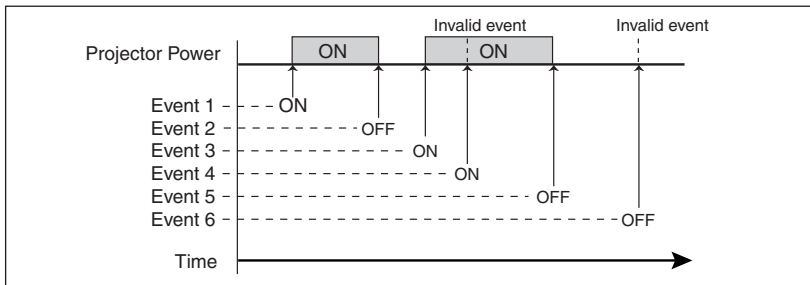

- When the timer events are set at the same time, the last event set will override the previous events. For example, if there is an event like "On at 8:00 everyday" and then new event is set like "Off at 8:00 everyday", only the last setting event is effective.
- When the timer event **ON** occurs during cooling down period, this is invalid event because the projector cannot be turned on during this cooling down period.

## Cancel the timer

To cancel the timer event, check the timer event you want to delete and then press the **Delete** button.

Timer Check		
<input type="checkbox"/>	ON Every Day	10:00
<input checked="" type="checkbox"/>	OFF Every Day	21:30
<input checked="" type="checkbox"/>	ON Monday-Friday	17:00
<input type="checkbox"/>	OFF Every Day	19:00

- The timer operates by using the clock function provided in this product. Before setting the timer, please confirm that the current date and time are set correctly. Timer and clock functions are functioning using a lithium battery provided in this product. When the battery runs down, the clock and timer functions will not operate correctly. Consult your local dealer for the replacement of battery. The replacement must be carried out by a qualified service personnel.



## Service

This function sets parameters for service items of the projector. As these service items are used mainly for maintenance, please use the default setting unless a change is needed. There may be not available items depending on the projector's function.

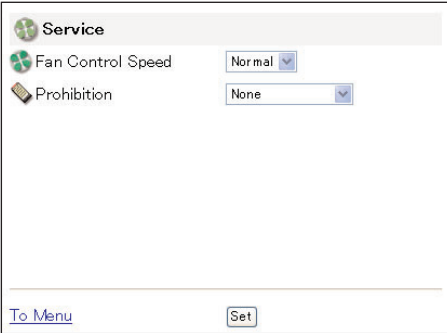

Item	Description
------	-------------

### Fan Control

Speed .....Sets fan control speed.

Prohibition.....Sets the prohibition of the projector control by the remote control or the keys on the projector.

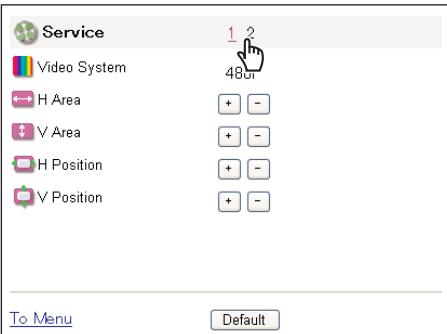
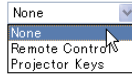

Item	Description
------	-------------

Video System\*1 ..Displays the current video system mode.

H Area\*1 .....Adjusts the horizontal effective area.

V Area\*1 .....Adjusts the vertical effective area.

H Position\*1 .....Moves image horizontally

V Position\*1 .....Moves image vertically.

\*1 It cannot be displayed in the computer mode.

\* To restore the setting, press the Default button.

\* Some projector's model types cannot support this function.

- The indication of video system in this page is displayed as follows.

Video System	Input Signal
480I	NTSC [VIDEO], [S-VIDEO], [Y, Cb/Pb, Cr/Pr]
480P	NTSC [Y, Cb/Pb, Cr/Pr]
575I	PAL [VIDEO], [S-VIDEO], [Y, Cb/Pb, Cr/Pr]
575P	PAL [Y, Cb/Pb, Cr/Pr]
720P60	[Y, Pb, Pr]
720P50	[Y, Pb, Pr]
1035I	[Y, Pb, Pr]
1080I60	[Y, Pb, Pr]
1080I50	[Y, Pb, Pr]
1080P60	[Y, Pb, Pr]
1080P50	[Y, Pb, Pr]

The adjustments of H/V Area and Position are effective only for video input mode. These adjustment values are stored with each video system mode as the above.



## Save Actual Adjustment

This function is to save and load the control values of the projector. The storable control items are Input, PC, System, Image and Screen controls.

### 1 Adjust and set the controls

Set the controls properly according to the selected source. (see pages 38-44 for further adjustment)

### 2 Select the Save page

Click on the **Save** icon from the control menu. The setting page is displayed as the right. Change pages by clicking on the page numbers "1" to "7" linked text and check the current settings. For further information please see the next page.

### 3 Name the current setting

Select a set number (Set1 to set10) you intend to store current settings with the pull-down menu button of the **Save Setting No.:** **Save to**. Name this set number onto the **Memo** text area.

### 4 Save the current setting

Press the **Set** button to store the current setting and name into the selected set number.

You can store up to 10 sets of controls into the Network Board.

## Check the Save items

Browse pages by clicking on the page numbers and check each setting status. The pages for the save items are constructed by 7 pages. The contents of the pages may differ from the actual depending on the selected input mode and the function of the projector.

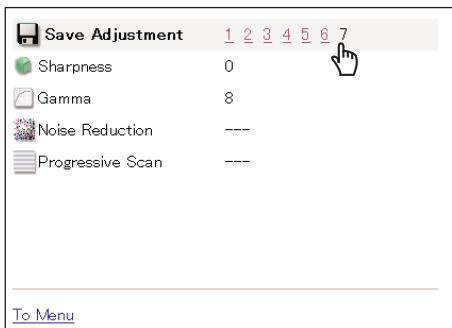
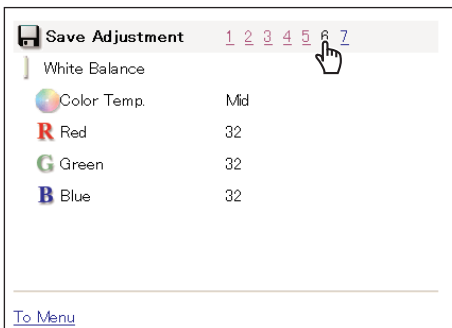
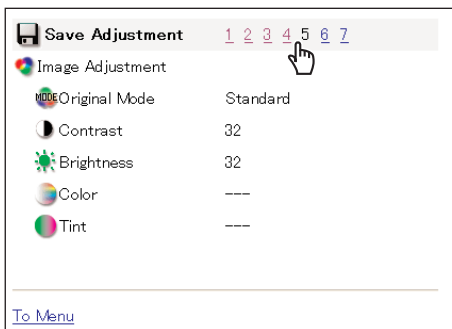
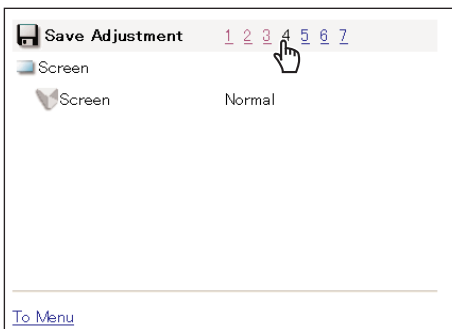

### Load a control set

Select your desired set number with the pull-down menu button of the **Load Setting No.** and then press the **Set** button. The setting values of the selected set number are applied to the current settings.

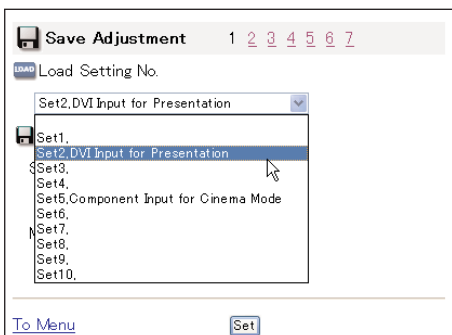

Example of setting

If the contents of the saved set are not match for the slot equipped on the projector, the invalid alert message may be displayed. For example, the message "Invalid setting for SLOT1" will be displayed in the following case.

Example: In case of after setting the DVI computer input for SLOT1 and then it was changed to video input board.



## Control the projector's menu

Click on the **Menu** linked text on the main menu. The following menu control page is displayed. This page is to control the on-screen display menu of the projector.

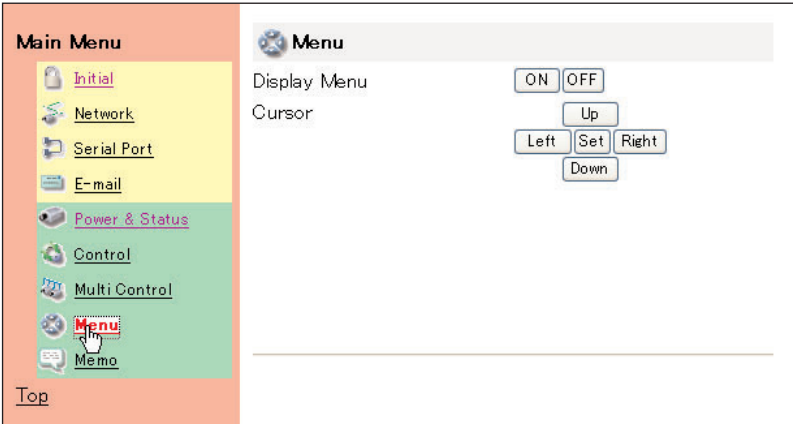

Item	Description
Display Menu	.....To switch the on-screen display menu on or off by pressing the <b>ON</b> or <b>OFF</b> button. The same operation with the <b>MENU</b> button on the projector and remote control handset.
Cursor	.....Used to select an item or adjust value in on-screen menu by pressing the <b>Up</b> , <b>Down</b> , <b>Left</b> and <b>Right</b> button. The same operation with the pointers on the projector and remote control handset. Used to execute the item selected by pressing the Set button. The same operation with the <b>SELECT</b> button on the projector and remote control handset.



## Make a memo

Select the Memo setting page by clicking on the **Memo** linked text on the main menu. The following setting page is displayed. It is convenient to use as a memo for the simple description where the projector is placed in. This note will be displayed on the login page. Input a memo and then press the **Save** button.

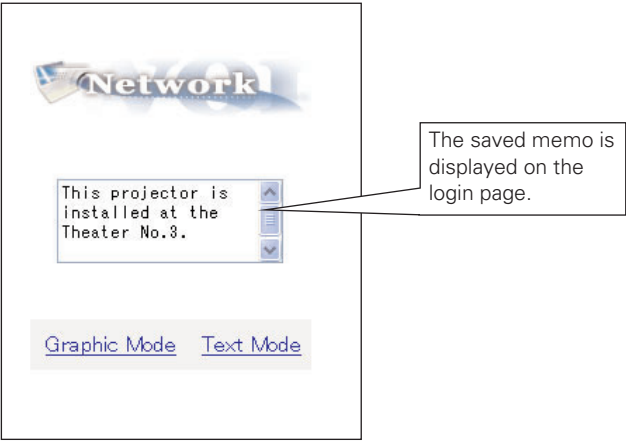
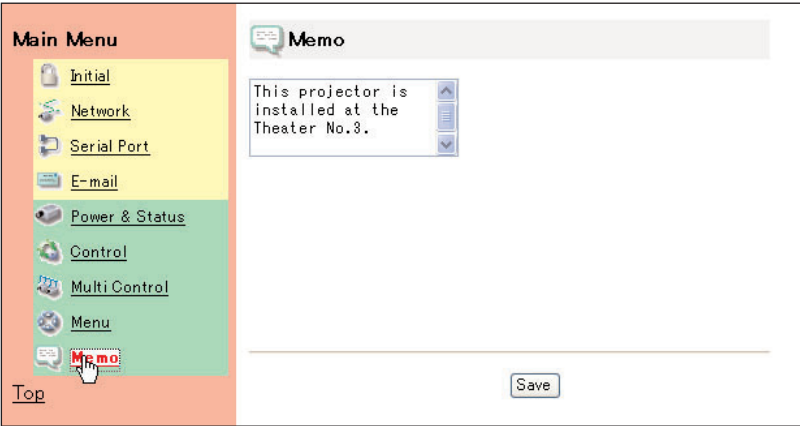

# Chapter 5

## Controlling the Multi-Projectors

---

# 5

ENGLISH



## Multi-Control

This function enables you to control (Power, Image, Date/Time, Timer, Screen, etc.) the multiple projectors equipped with the Network Board connected to the network. Click on the **Multi Control** linked text on the main menu to display the control page.

**Note:**

To control the multiple projectors, each projector must have the same password.

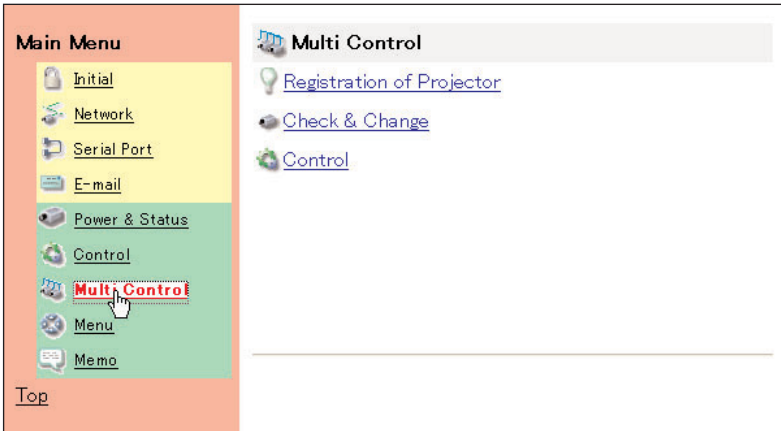

### Example of multi control

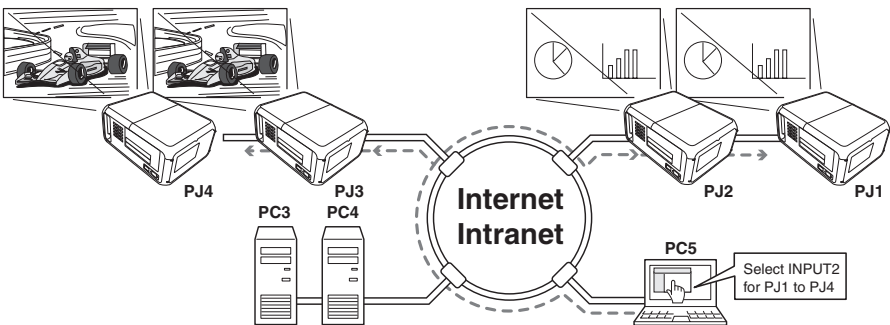



## Register IP address and projector name

Click on the **Registration of Projector** linked text to display the registration page. Type the IP address and projector name\*1 if required and then press the **Register** button.



**Registration of Projector**

IP Address

Projector Name

[Check](#)

[Return](#)

## Check IP address and projector name

To check the registered information, click on the **Check & Change** linked text. The registered information of the projector is listed as the right.

\* The word "None" is displayed if the projector name is not registered.



**Change**

● TheaterNo.1	192.168.1.100	ON
● TheaterNo.2	192.168.1.200	ON
● Cinema220	192.168.10.220	ON
● PU110	172.21.99.142	ON
● MeetingRoom2F	192.168.10.155	ON

Projector name

When you click on a listed IP address, the login page for the selected projector will be displayed with a new window and then enter the password for this projector and login.

Network - Microsoft Internet Explorer

Address: http://172.21.99.142/ndoc\_b.htm

Input PC System Image Screen Sound Setting Service Save

**Main Menu**

- Initial
- Network
- Serial Port
- Email
- Power & Status
- Control
- Multi Control
- Menu
- Menu

**Power & Status** 1 2

- Projector Power  Standby
- Lamp Mode
- Accumulated Lamp-use Time 14/16 h
- Accumulated Projector-use Time 14 h
- Power Status ON
- Projector Condition Normal

Top

\*1 Normally, the projector in the network is recognized with the IP address. This product allows you to name the projector instead of the IP address. By registering the projector's nickname like "MeetingRoom101", it can be managed and recognized easily. If you use the DNS server, register the host name registered to the DNS server as projector name. For further information please consult your network administrator.

☞ You can register the projectors up to 100 sets for the multi-control.

### Exclude/Add/Delete a projector

To change the mode of the registered projectors, Select a mode with the pull-down menu button under the IP address of the target projector and then press the Set button.

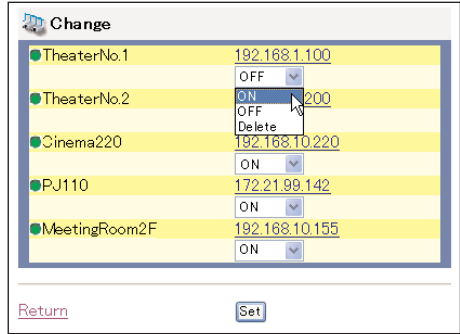

Mode	Operation
OFF	: Exclude from the multi-control
ON	: Add to the multi-control
Delete	: Delete from the multi-control

### Status

If some of the registered projectors are deactivated by some reasons (such as disconnecting the power source, disconnecting the LAN cable, disconnecting from the network), control changes will continue to be effective for the projectors that are still activated. At the same time, the deactivated projectors are excluded from the multi-control. The status of the registered projectors are indicated under the projector name. See the table below for status indications.

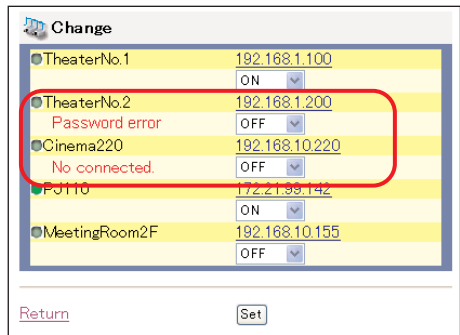

Status	Description
(blank)	.....The projector is connected to the network correctly
No connected	.....The projector may not be connected to the network. Please check the connection and network configuration of this projector.
Password error	.....The login password is incorrect. The password for the multi-controlled projectors must be the same. Change password of this projector to the common password.

- ☞ If the multi-controlled projector is in the standby mode, any change is not effective except timer setting.
- ☞ It is recommended that a specified projector should be chosen for setting when you use this multi-control function. The control for the multi-controlled projectors will become too complicated operation if this function is used for each projector.
- ☞ If the registered projector is not connected to the network, it will take some time to complete the multi-control operation because the network board is waiting for the response from each registered projector.

## Control

Display the control page by clicking on the **Control** linked text on the multi-control page. The setting pages are constructed from 1 to 6 page and each items are indicated on the next page.

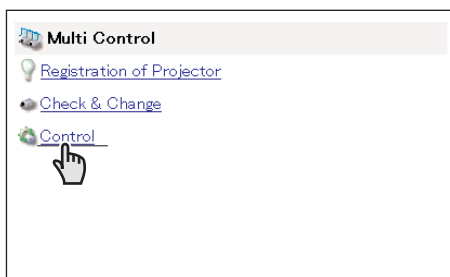

## Load and apply the setting value

The control sets saved for each projector (see p.50) can be used while the multi-controlled projectors function is being used. Select a setting number from the item **Load Setting No.** with the pull-down menu button and then press the **Set** button. The control values stored with selected set number for each projector will be applied to the individual projector assigned to that set. The same control values will not be applied to all of the projectors under the multi-control.

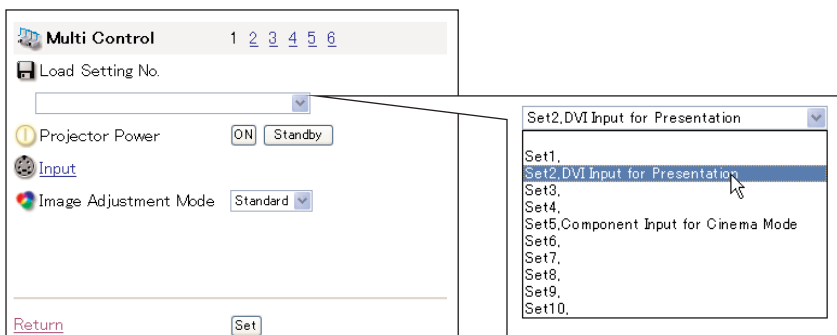

☞ If loading a set to the multiple projectors, the contents of the set must be effective to current accessed projector. If not, the multi-control cannot be performed.

Example: If the DVI computer input for SLOT1 is set into the "Set1" and the current accessed projector has a video board on the SLOT1, the load set will become invalid this time and the loading of set for the another projectors will not be carried out.

## Control multi-projectors at the same time

The valid controls are shown below. Please refer to chapter 4 “Controlling the Projector” (p.35) for further control and description. When the control button or setting button is pressed, the registered projectors for the multi-control are controlled at the same time. \* These control items differ from each selected input mode and functions of the projector you use. Change of function is disable if the multi-controlled projector does not support its function.

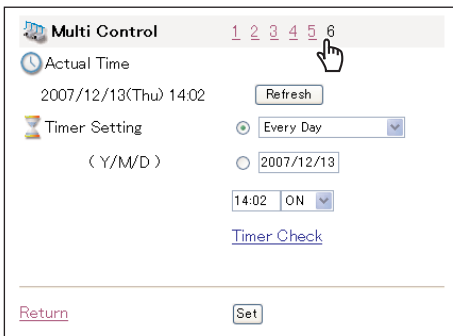
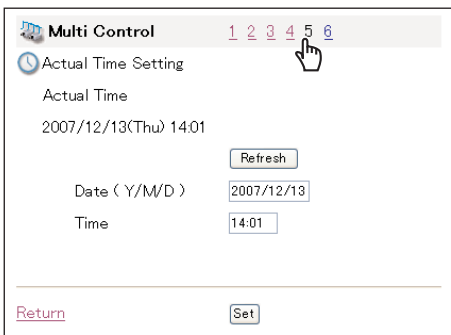
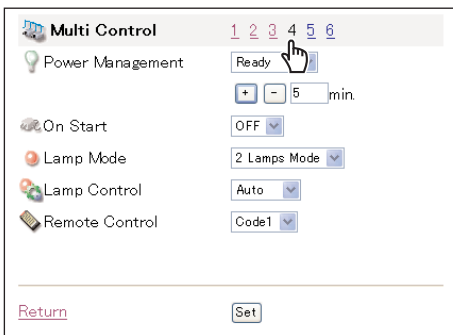
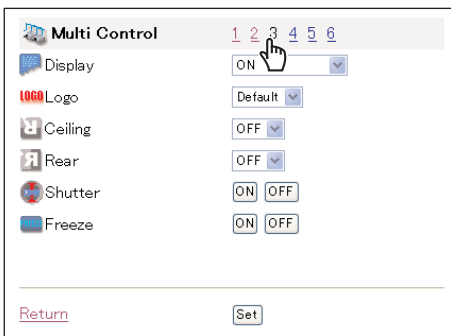
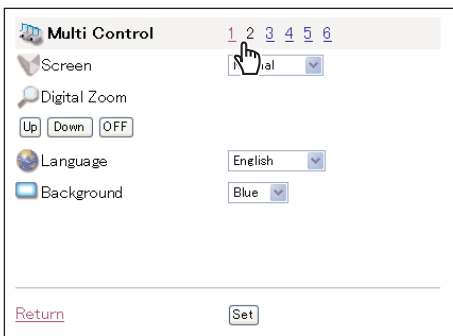

\* The above pages are example. They may differ from the actual depending on the projector's model type.

# Chapter 6

## Use of Serial Port

# 6



This product provides a serial control port (RS-232C) to control the external equipment which has an RC-232C port. This function allows external equipment to be controlled by the computer through the network and the projector can be controlled by the external serial controller. Before connecting the external equipment, perform the setting "Serial port setting" described below.

## Serial Port setting

This is to set up the serial port on the network board. Display the setting page by clicking on the **Serial Port** linked text on the main menu. To communicate with external equipment correctly, communication condition must be set to the same values as that the connected equipment is using. After fixing the setting, press the **Set** button\*1.

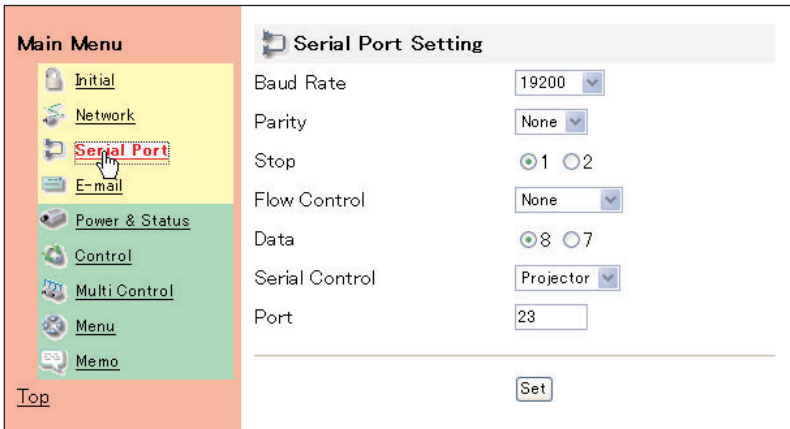

Item	Description
Baud Rate.....	Communication speed for serial port, select with the pull-down menu.
Parity.....	Parity check, the ways for error detecting of the transferred data.
Stop .....	Stop bit, indicates the end of communication.
Flow Control .....	Ways for communication flow.
Data .....	Indicates the length of data
Serial Control .....	Selects equipment to control
External .....	Used to select when the external equipment connected to the serial port is controlled by the computer through the LAN port.
Projector.....	Used to select when the projector is controlled by the serial controller connected to the serial port.
Port.....	Indicates the port number of TCP/IP. The default number is 23. Use the same port number specified by application. There are some reserved port number*2. If one of those port numbers is used, the alert dialog window will appear and let you know that it is an invalid port number.

## Setting to control the equipment connected to the serial port from the computer

- Serial Control** :Selects "External"
- Port** :Sets according to the computer specified port no. Do not use port no. 10000\*2.
- Other Settings** :Sets according to the communication condition of the equipment

Serial Control	External ▼
Port	External Projector

## Setting to control the projector from the serial controller connected to the serial port

- Serial Control** :Selects "Projector"
- Port** :Not specified. Do not use port no. 10000\*2.
- Other Settings** :Sets according to the communication condition of the serial controller

Serial Control	Projector ▼
Port	External Projector

## Setting to control the projector from the computer through the LAN port

- Serial Control** :Not specified
- Port** :Not specified
- Other Settings** :Not specified

Serial Control	Projector ▼
Port	23

\* The port no. of the computer must be used with 10000.

\*1 This product will restart automatically when "Port" or "Serial Control" is changed and it takes about 40 seconds.

\*2 The reserved port numbers are http (80), ftp (21), telnet (23), etc. The port no. 10000 is reserved to control the projector through the LAN port.

☞ There are 2 types of RS-232C serial cable, Normal(Straight) and Reverse(Cross) type. This product provides with a serial port switching socket. Set this switch to proper side according to the cable type. How to switch the serial port socket, see item "Serial Port Switching".(p.61)

☞ Exclusive driver software for control of the external equipment is required. This product does not provide any driver software. Please consult your local dealer.

# Control Examples

## Example 1

Controlling AV equipment through network

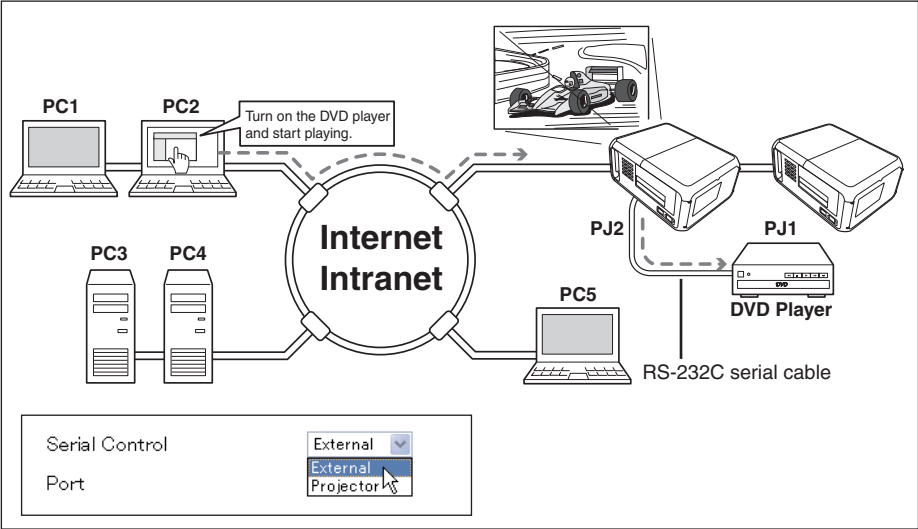

## Example 2

Controlling a projector which is not on the network function through network.

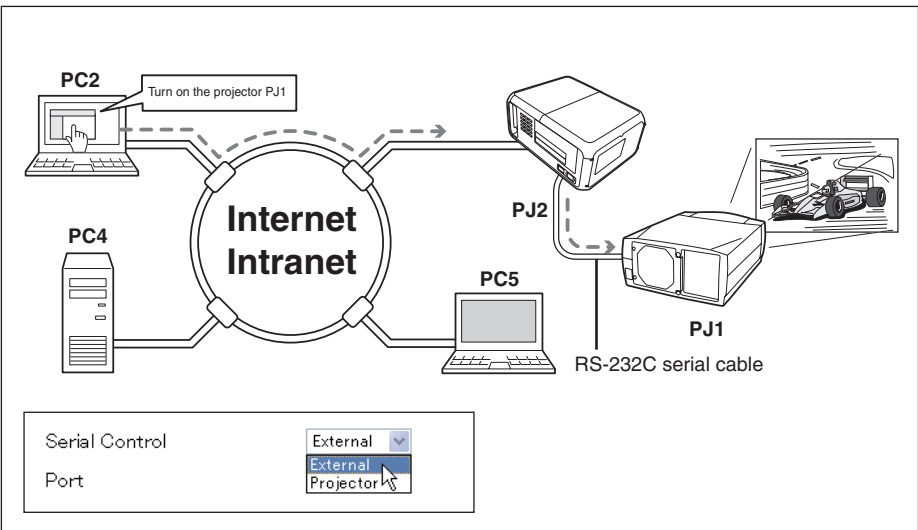



### Example 3

Controlling the projector with the serial controller through the serial port (RS-232C).

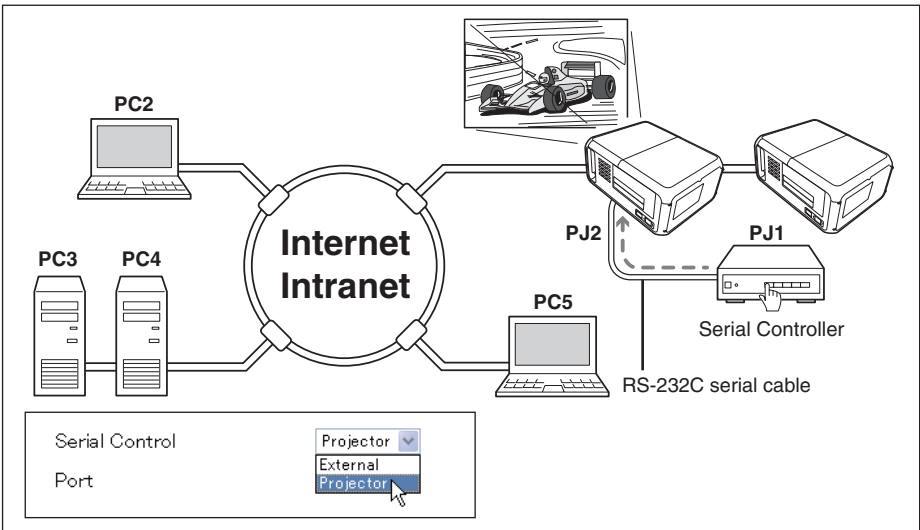

### Serial Port Switching

When connecting the peripheral equipment to this network board, you should notice the type of serial cables. At the factory shipping, the polarity of serial port on the network board is set to the reverse (cross) type. When connecting the peripheral equipment, please use an optimum serial cable according to the polarity of the port on the equipment. And this product provides a socket to switch the polarity of the serial port. By switching the socket on the board as shown below, it is possible to switch the polarity of the port either the normal (straight) type or the reverse (cross) type. By means of this, you can use both kinds of the serial cable. For further pin allocation please see item "Port Specification". (p. 82)

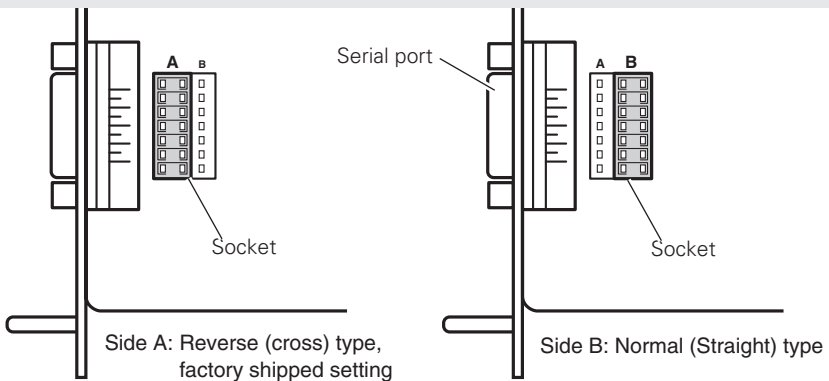

## Use of Telnet

You can control the equipment connected to the serial port on the Network Board and the projector itself by using the telnet application\*<sup>1</sup> installed on your computer. The following is a control example of external equipment. The telnet application is needed to use commands\*<sup>2</sup> which controls the external equipment.

### Preparation

- 1 Turn the projector off with the mains switch and connect an external equipment to the serial port with an RS-232C serial cable.
- 2 Turn on the projector and external equipment.
- 3 Display the setting page by clicking on **Serial Port** on the main menu with the web browser. (p.62)
- 4 Change the serial port setting to be the same communication condition as the connected external equipment and then click **Set** button.

The following example setting is for our projector communication condition. When controlling our projector set as follows:

Baud rate	.....19200
Parity	.....NONE
Stop	.....1
Flow Control	.....NONE
Data	.....8
Serial Control	....External
Port	.....23

### Control

(For example, in case of using the Telnet application of the Windows XP Professional.)

- 1 Select **Run...** submenu from **Start** menu on the computer. Type "telnet" onto the **Open** text area on the displayed window and press **OK** button.

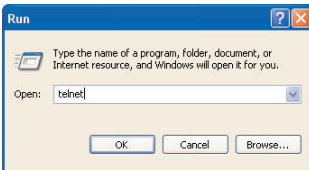

- 2 The telnet application will start and the following window will be displayed. Type as below to connect the projector.  
> open 192.168.1.201 return

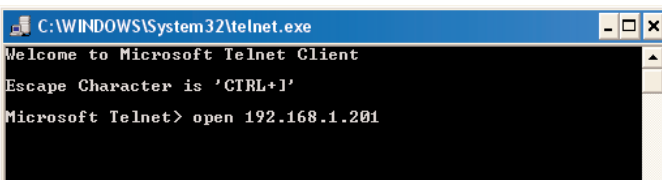

\* Use the IP address assigned to the projector

- 3 When communication is established, the word "PASSWORD:" appears on the window. Type the login password\* for the projector and then press "Enter" key on the keyboard. If you do not register the login password, just press "Enter" key. When the word "Hello" is replied, login has been succeeded.

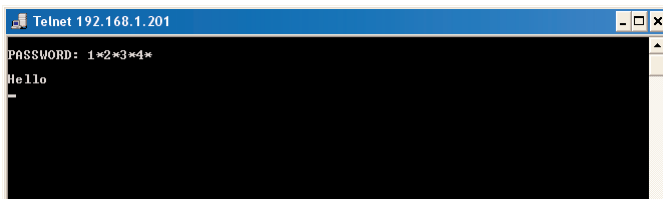

\* For example, entering password [1234]

- 4 Type the commands from the key board to control the external equipment and then enter "Enter" key for termination. For example, type "C00" and enter "Enter" key.
- The extra projector will be turned on.

\* "C00" is a command to turn the projector on.

\* Enter with ASCII 64-byte capital characters and one-byte characters.

To disconnect the communication, type "Ctrl" key and "]" key at the same time.

- \*1 Further instructions about the telnet application, please see the on-line guide on your computer.
- \*2 The commands are defined by each product independently, so please consult the manufacturer or sales dealer for further information of the commands.
- \* The password is a login password decided on page 18, 22 or 30. If the authentication of the entered password is failed 4 times continuously, the communication will be disconnected automatically. Please try again for the connection.

## Control the projector with Telnet

This product allows you to control the projector by using the Telnet application. Normally, it is used for controlling the external equipment connected to the serial port and also control the projector itself by specifying the telnet port no.10000.

\* It is not affected by the serial port setting of the projector when using the telnet application.

In the step 2 of the previous page, enter port no. "10000" after the IP address no.  
> open 192.168.1.201 10000 return

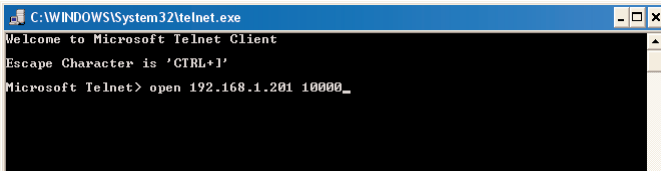

\* Use the IP address assigned to the projector

After the communication is established, type the password and the command for controlling the projector and then enter "Enter" key.

The right table shows the typical command lists for controlling the our projector and please consult your local dealer for further information of another commands.

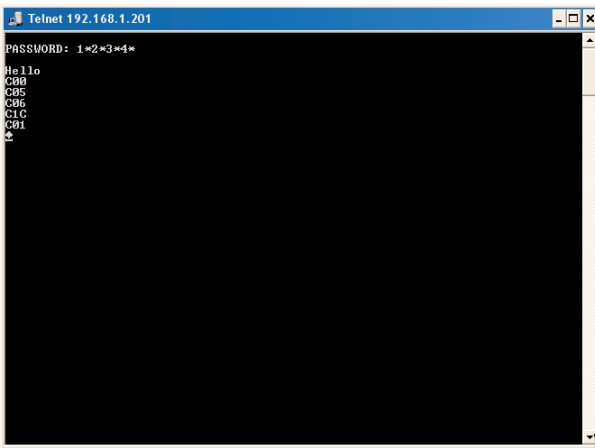

**Command list table**

Command	Function
C00	Turn the projector on
C01	Turn the projector off
C05	Selects input1
C06	Selects input2
C07	Selects input3
C08	Selects input4
C09	Volume up
C0A	Volume down
C0B	Mute on
C0C	Mute off
C0D	Video mute on
C0E	Video mute off
C1C	Menu display on
C1D	menu display off



## Chapter 7 Appendix:A

Connection examples  
Web browser setting  
Technical data

# Examples of Connection

## Peer-To-Peer connection

Connect the projector (PJ01) to the control computer (PC05) directly

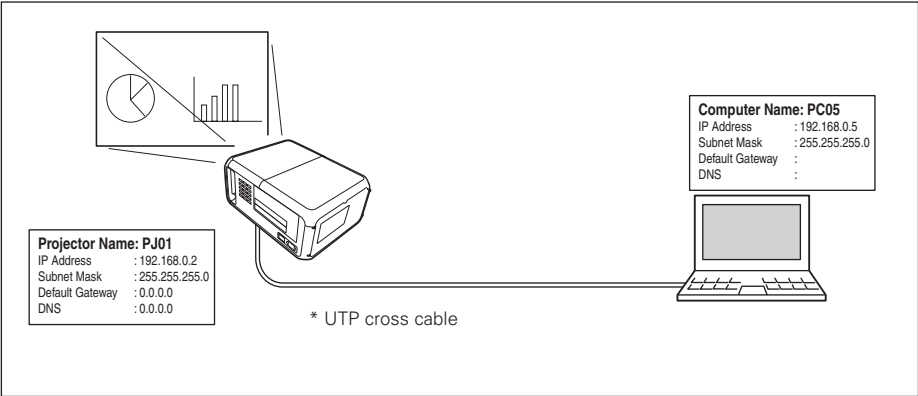

Connect the projector (PJ01) to the control computer (PC05) via the hub.

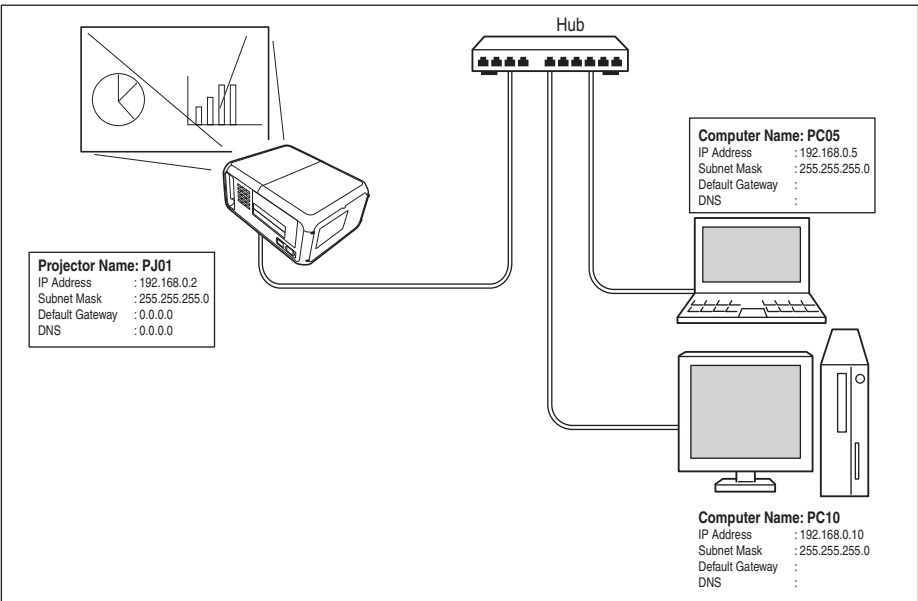

When the projector is connected to the computer directly without hub, the UTP cross cable should be used .

## The gateway (Router) installed in the network

Connect the projector (PJ01) to the control computer (PC05) via the gateway.

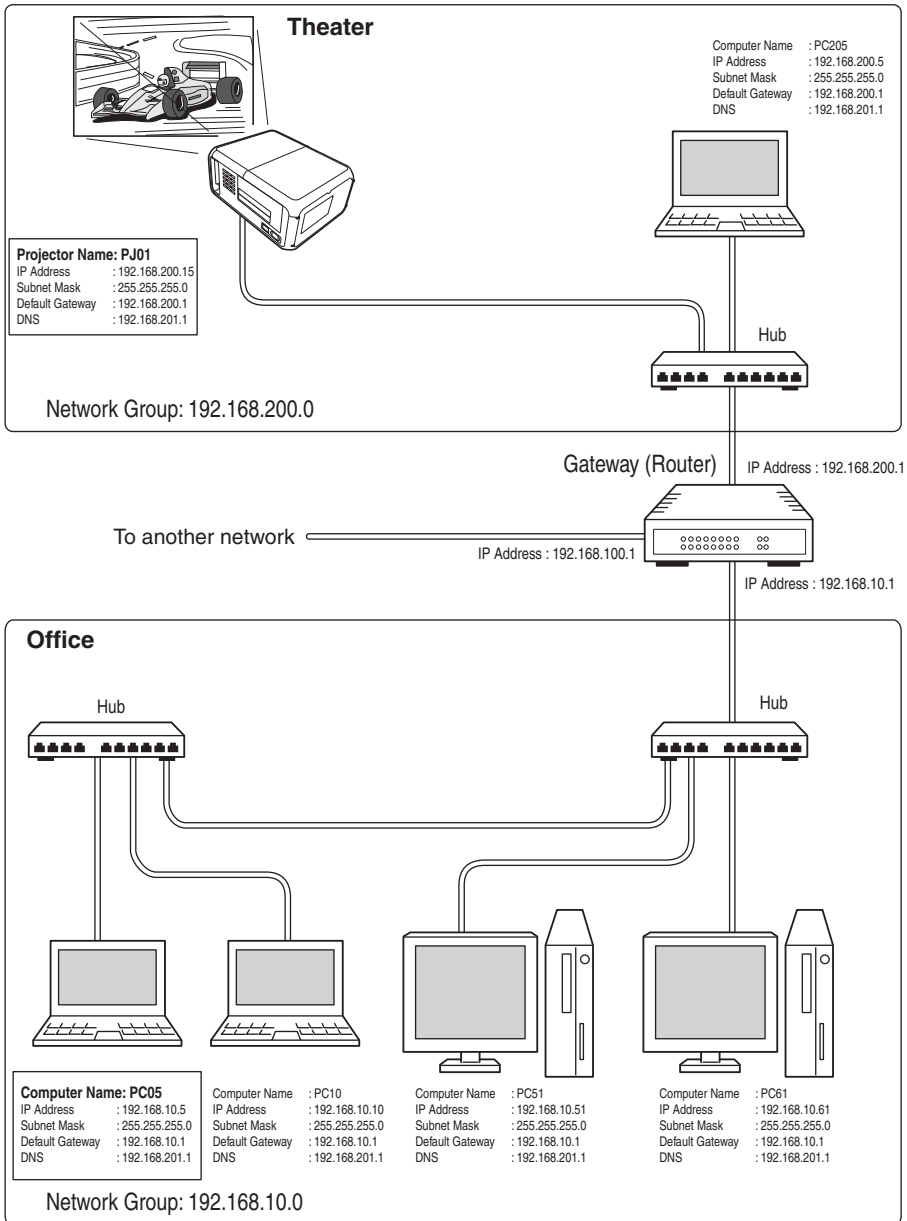

ENGLISH

## Web browser setting

This product is designed enable the projector to be set up and controlled from an Internet web browser. Depending on the preference settings of the web browser, some control functions may not be available. Please make sure that the following functions are set up properly in the web browser.

### Active Script/JavaScript enable

There are some control items used with the JavaScript function in the setting pages. If the web browser is set not to use this JavaScript function, it may not control the projector properly. In this case, the following warning message will be displayed on the top of the page. To enable the JavaScript, please see further instructions on the next page.

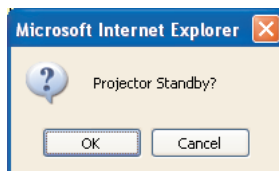

Make sure JavaScript is ON.



### Proxy setting

In some cases, your web browser is set up to use the proxy server for the internet or intranet connection. In this case, when you install this product into the local network, you should set up the proxy setting of web browser preference correctly. Especially when connecting the projector and computer with a UTP cross cable directly, or when the network does not provide the proxy server, make sure that "not use proxy server" is set up in your web browser preference. To set up the proxy setting, please see further instructions of item "Proxy setting" (p.74).

There are various ways to change your browser preferences depending on the version, Windows, Macintosh or applications. Please see the setting instructions on next page for example and also refer to on-line help of your web browser.



## Examples: OS/Browsers

### Windows XP Professional

#### Internet Explorer v.6.0

##### ActiveScript setting

Select the **Internet Options** menu from the **Tool** menu on the web browser and then select **Security** tab and click **Customize Level...** button. On the security setting window, scroll down and find the **Scripting** item, make sure that "Enable" is selected in item **Active Scripting**.

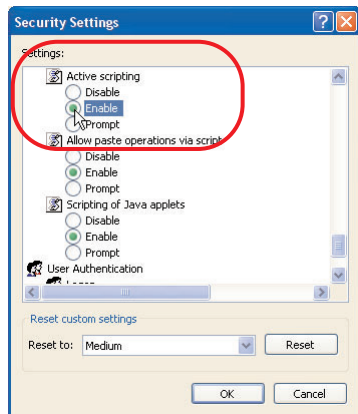
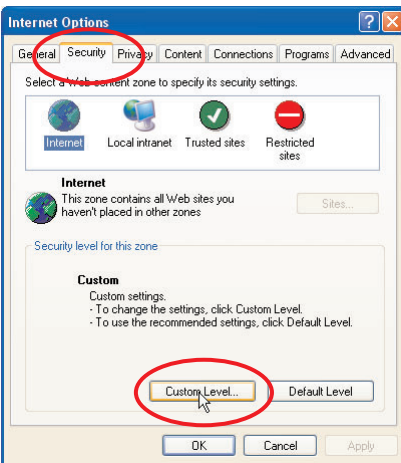

## Proxy setting

Select the **Internet Options** menu from the **Tool** menu on the web browser and then select **Connection** tab and click **LAN Settings** button. Properly set up your web browser's the proxy server settings according to the local area network environment to which the projector is connected.

### - Using proxy server

To use an external internet connection from the local area network, check the item **Use a proxy server** and enter the proxy server address and port correctly in the proxy settings window. For further instruction please consult your network administrator.

### - Not using proxy server

Uncheck the item **Use a proxy server**.

If you connect the projector to the computer directly with UTP cross cable, this must be unchecked.

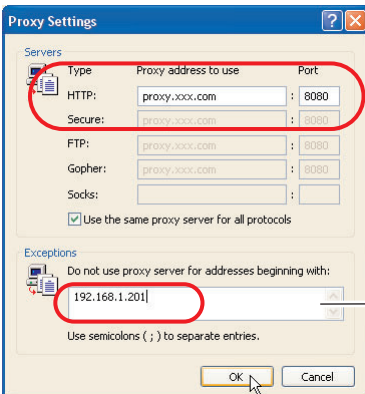
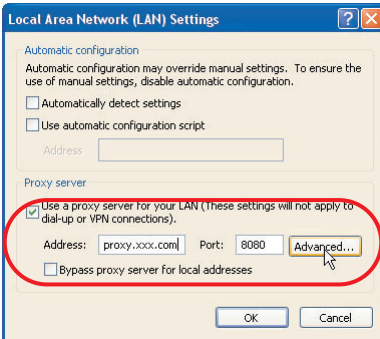

To designate proxy settings that will not use the proxy server when accessing the projector installed in the local area network, enter the IP address or domain name here.

## Netscape Navigator v.7.0

### JavaScript Setting

Select the **Preference** menu from the **Edit** menu on the web browser and then select the item **Advanced/Scripts & Plugins** in the **Category** column. Make sure that the **Enable JavaScript for Navigator** is checked.

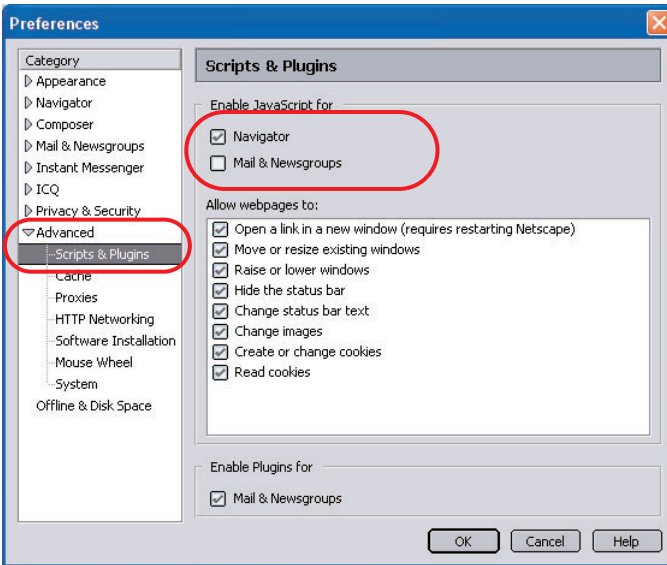

## Proxy setting

Select the **Preference** menu from the **Edit** menu on the web browser and then select the item **Advanced/Proxies** in the **Category** column. Properly set up your web browser's the proxy server settings according to the local area network environment to which the projector is connected.

### - Using proxy server

When you use an external internet connection from the local area network, select the item **Manual proxy configuration**. Enter the proxy server address and port number correctly on the **HTTP Proxy** item. For further instruction please consult your network administrator.

### - Not using proxy server

Select the item **Direct connection to the Internet** in the proxy setting window. If you connect the projector to the computer directly with UTP cross cable, this must be selected.

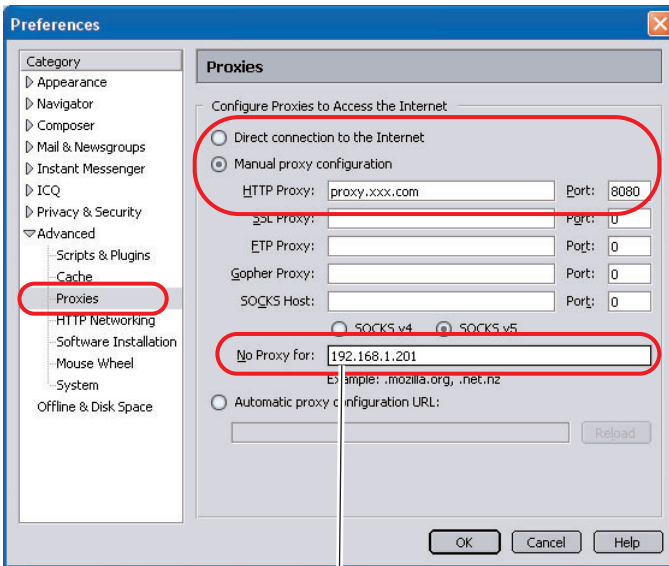

To designate proxy settings that will not use the proxy server when accessing the projector installed in the local area network, enter the IP address or domain name here.

## Mac OS 8.6

## Internet Explorer v.5.0

## ActiveScript setting

Select the **Preference** menu from the **Edit** menu on the web browser and then select **Web Content** under the **Web Browser** heading the preference settings window. Make sure that the **Enable scripting** is checked in the **Active Content** column.

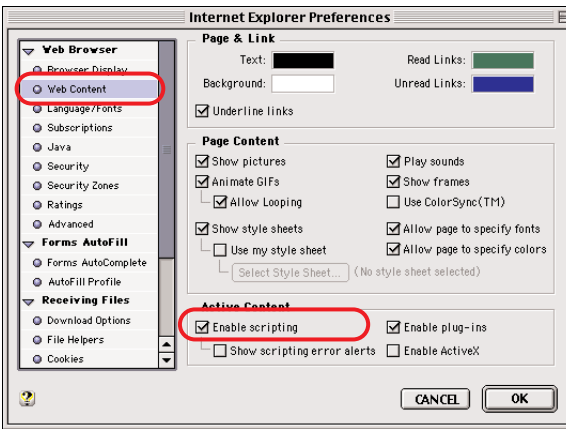

### Proxy setting

Select the **Preference** menu from the **Edit** menu on the web browser and then select **Proxies** under the **Network** heading the preference settings window. Properly set up your web browser's the proxy server settings according to the local area network environment to which the projector is connected.

#### - Using proxy server

When you use an external Internet connection from the local area network, check the item **Web Proxy** and enter the proxy server address correctly. To make advanced settings, press the **Settings** button to display the Web proxy settings window. For further instruction please consult your network administrator.

#### - Not using proxy server

Uncheck the item **Web Proxy**.

If you connect the projector to the computer directly with UTP cross cable, this must be unchecked.

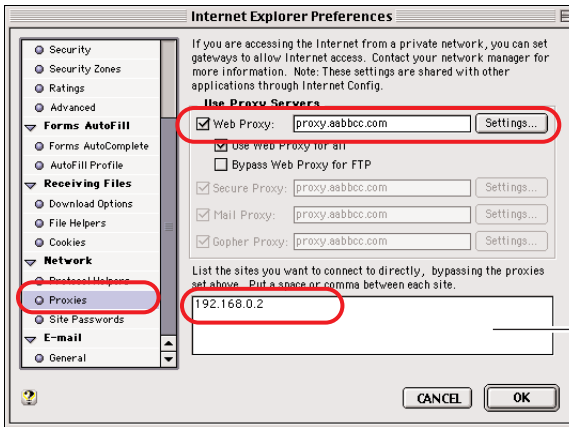

To designate proxy settings that will not use the proxy server when accessing the projector installed in the local area network, enter the IP address or domain name here.

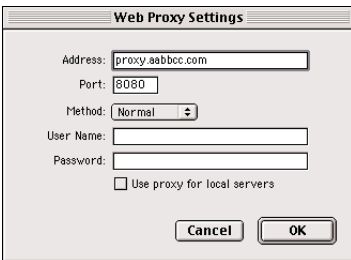

## Netscape Navigator v.4.7

### JavaScript Setting

Select the **Preference** menu from the **Edit** menu on the web browser and then select the item **Advanced** in the **Category** column. Make sure that **Enable JavaScript** is checked.

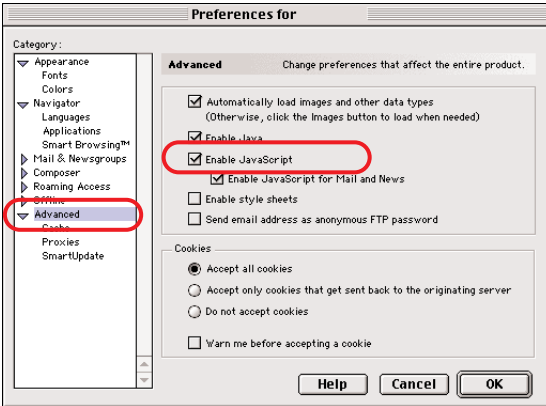

## Proxy setting

Select the **Preference** menu from the **Edit** menu on the web browser and then select **Proxies** under the **Advanced** heading in the Category column. Properly set up your web browser's the proxy server settings according to the local area network environment to which the projector is connected.

### - Using proxy server

When you use an external Internet connection from the local area network, select item **Manual proxy configuration** and press the **Configure** button. The proxy setting window will appear. Enter the proxy server address and port number correctly on the **HTTP proxy** item in the proxy settings window. For further instruction please consult your network administrator.

### - Not using proxy server

Select item **Direct connection to the Internet** in the proxy setting window.

If you connect the projector to the computer directly with UTP cross cable, this must be selected.

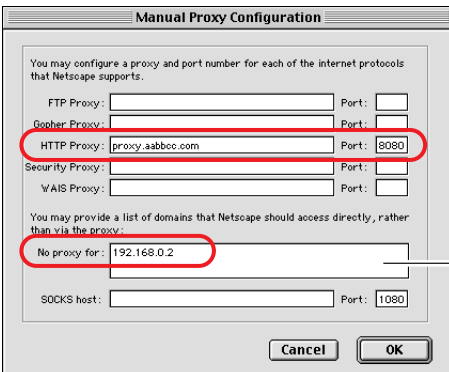
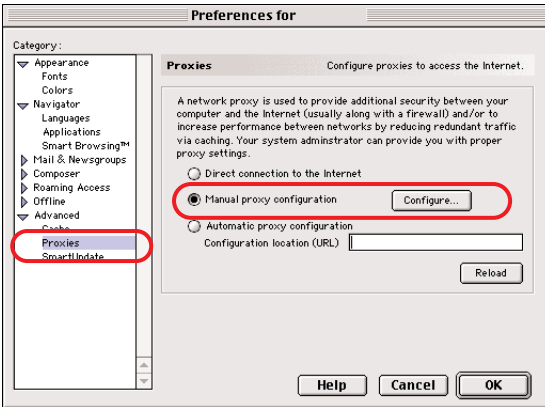

To designate proxy settings that will not use the proxy server when accessing the projector installed in the local area network, enter the IP address or domain name here.



## Product specification

Type .....	Network Board	
LAN interface .....	Applicant regulation	IEEE802.3 (10Base-T)
		IEEE802.3u (100Base-TX)
	Data transfer speed	10Mbps/100Mbps
	Data transfer mode	Half duplex/Full duplex
	Terminal	8-pin modular (RJ-45)
Network protocol	TCP/IP specification	TCP/IP
Serial interface	RS-232C	
	Baud rate	0.3/1.2/2.4/4.8/9.6/19.2/28.8/57.6/115.2 Kbps
	Flow control	Hardware flow control (RTS/CTS, Xon/Xoff)
	Parity check	Odd/Even
	Terminal	D sub 9-pin Male
Power source .....	Supplied from the projector	
Power consumption .....	3.0 watts	
Dimensions (W x H x D).....	5.39" x 1.18" x 4.33" (137 x 30 x 110mm)	
Weight .....	0.34 lbs (155 g)	
Built-in battery .....	Lithium battery, Type CR2032, 3.0V	
Operating temperature.....	41°F ~ 95 °F (5°C ~ 35 °C)	
Storage temperature .....	14°F ~ 140°F (-10°C ~ 60°C)	

\* The specifications are subject to change without notice.

# Port Specification

## LAN port specification

8-pin modular connector (RJ-45)

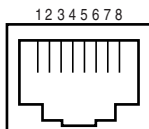

pin No.	Signal	Function
1	TX+	Transfer data (+)
2	TX-	Transfer data (-)
3	RD+	Receive data (+)
4	(not used)	
5	(not used)	
6	RD-	Receive data (-)
7	(not used)	
8	(not used)	

## Serial port specification

D sub 9-pin connector (RS-232C)

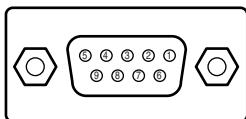

\* It is possible to switch the polarity of the serial port as shown in table below by switching the socket on the network board. For further information, see item "Serial Port Switching" (p.65). At the factory shipped setting, the socket is set to side A.

Pin No. Socket	Signal Name	
	Side A	Side B
1	CD	-
2	RXD	TXD
3	TXD	RXD
4	DTR	-
5	Ground	Ground
6	DSR	-
7	RTS	-
8	CTS	-
9	-	-

### - Explanation of signal names

	Function
CD	Carrier detection
RXD	Receive data
TXD	Transfer data
DTR	Data terminal ready
DSR	Data set ready
RTS	Request to send
CTS	Clear to send
-	Not used

# Appendix:B

## Q&A



## Q&A

### Installation/ Access

#### **Q** Why doesn't the setting page appear in my web browser?

**A** Following causes are possible. Please check them.

1. The projector is not connected to the network.  
Check LED indicators status (☞ p.13).
  - Check the connection of LAN cable if the LINK indicator does not illuminate orange.
  - Check the network configuration of the projector if ACT indicator does not illuminate green.
2. Function "Network" in the projector is not set to "ON".  
Set up by using the projector's on-screen menu (☞ p.16, 20).
3. Wrong network configuration of the projector  
Check the network configuration of the projector by using the projector's on-screen menu (☞ p.16, 20).
4. Wrong network configuration of the computer.  
Check the network configuration of the computer.
5. The Network Board is used with the default setting (☞ p.16, 20).
6. The proxy setting of the web browser is not set correctly (☞ p.72).
7. The computer does not provide TCP/IP protocol.

#### **Q** No setting page in my web browser? Is the problem in the network or in the projector? I would like to find out the problem whether it is in the network or in the projector

**A** Check it by the following steps

1. Disconnect the projector from the network and connect the projector and computer with the UTP cross cable directly.
2. Change network configuration of the computer and projector as shown in the example below.

(Projector setting)	(Computer setting)
IP Address : 192.168.0.2	IP Address : 192.168.0.5
Subnet Mask : 255.255.255.0	Subnet Mask : 255.255.255.0
Default gateway : 0.0.0.0	Default gateway : (blank)
DNS : 0.0.0.0	DNS : (blank)

3. Enter the projector's IP address [192.168.0.2] at the "Address" column on the Web browser. [Note] Make sure that the proxy setting of your web browser is set to "Not use a proxy server" (☞ p.72).
4. If the login page appears, this product is operating properly. The problems may be in the network configuration of the computer or in the network. Please try to set up the network by following chapter "Network configuration" (☞ p.16, 20).  
If the login page does not appear, please check for proper mounting of this product onto the projector by referring to chapter 2 "Installation" (☞ p.11).

**Q How can I restrict access from the computer.**

- A**
1. Please use the password authentication function on the login page (☞ p.30).
  2. Please use the IP filtering function provided with the gateway (router) to restrict the accessing from the computer. For further information please consult your network administrator.

**Q Can I access the projector installed on the company's local area network from a remote location?**

- A**
- There are some ways to access to the projector in the LAN, but you must consult your network administrator.
- ☛ Use of modem  
(Connect to the company's network from your home or some other places by using modem.)
  - ☛ Use of private line  
(Connect to the company's network from the branch office or maintenance office by using private line.)
  - ☛ Use of internet  
(Connect to the company's network from your home, branch office or some other places by using the internet.)

**Q We use the DHCP/BOOTP server to assign the IP address. Is it possible to use the Network Board in this network environment?**

- A**
- Possible. As the Network Board does not support the DHCP/BOOTP server, the fixed IP address must be configured manually. Please consult your network administrator (☞ p.23).

**Q How can I install several projectors equipped with the Network Board?**

**A** Install and configure network one by one to avoid the IP address collision each other (☞ p.23).  
To configure the IP address please see chapter “Network configuration” (☞ p.16. p.20)

**Q How many projectors can I control with multi-control function?**

**A** It has been designed to control up to 100 sets but it depends on the network environment.

Password/Login

**Q What should I do when I forget the password?**

**A** Select the "Network PIN code" menu or the "Password" menu on the projector's on-screen menu. The current password will appear on the screen (☞ p.18, 22).

**Q Can I register the setting page as a web browser “Favorites” or “Bookmarks”?**

**A** Please add the “Login” page to your “Favorites” or “Bookmarks”. Do not add the specified setting page because it will not be able to perform the password authentication correctly.

## Operation

### **Q Why can't I change the controls in the setting page with web browser?**

**A** Please make sure the projector is turned on. If it is in the standby mode, the setting is not effective to the projector. To control the projector with a web browser, the projector must be in the powered-on condition. Also, projectors registered for multi-control cannot have any controls changed if they are in standby mode. But timer and clock settings are always effective, even for projectors in standby mode.

### **Q Why does it sometimes take a lot of time to complete the page display?**

**A** The display speed of the page depends on the network environment in which both the projector and computer are placed. It may take much time to complete the page display if network traffic is heavy. Please consult your network administrator. By changing the preference of your web browser to "not show pictures", you may have page display more quickly at the heavy network traffic. Please see the browser's on-line help for further information. Also you can select the Text mode for displaying pages quickly (☞ p.26).

### **Q I use many of the projectors in the network. How can I use names of the projectors to recognize each projector instead of IP addresses?**

**A** You can manage the projectors with nicknames instead of the IP address. Please see chapter "Controlling the Multi-Projectors" for further information (☞ p.55).  
By registering the projector name and IP address with the DNS server, it can be accessed with the nickname from the any computer referred to the DNS server. Please consult your network administrator (☞ p.31, 57).

### **Q How many numbers of the E-mail addresses can I register in the E-mail setting page.**

**A** You can register up to 10 addresses.

**Q** Why am I not receiving E-mail alert messages?

**A** Make sure that the registered E-mail address and SMTP server address are correct. If the SMTP server is located in your LAN (Local Area network), the address should be set to the SMTP server in your LAN. The SMTP server located outside of your LAN may not be available for security reason. For further information please contact your network administrator (☞ p.32).

It may be required for the authentication depending on the SMTP server. This product does not support this kind of SMTP server.

Others

**Q** Can I develop a driver to control external serial equipment?

**A** This product does not provide any driver software. To control the external equipment connected to the extra serial port, it should be required to clarify the commands and communication condition defined by each equipment. If they are clarified, it can be controlled by using the Telnet application installed on your computer. Please see item "Use of telnet" (☞ p.66).

**Q** Can I control the projector by using the telnet application?

**A** Possible. Please refer to item "Control the projector with telnet" (☞ p.68).



**Q Can I update the firmware of the Network Board.**

**A** It is possible to update the firmware through the network. It is required to have a special tool for the updating. For further information please consult your local dealer. The version number of the firmware is indicated on the lower part of the "Initial Setting" page.

The screenshot shows a web interface for "Initial Setting". At the top, there is a header "Initial Setting" with a lock icon and a page number "1 2". Below this are three configuration items: "Language" set to "English" with a dropdown arrow, "Model Name" set to "DET100", and "Password" with an empty input field. At the bottom of the form is a "Set" button. In the bottom right corner of the page, the number "4.404" is displayed and circled in red.

**Q What are the rules for IP address assignment?**

**A** If the network is constructed with TCP/IP protocol, a unique IP address is required for each piece of network equipment. The following are basic rules of the assignment.

Rule1

Do not configure the same IP address to the network equipment in the same network group. Each piece of equipment must be assigned a unique IP address.

If the IP address is set [192.168.x.x], the Subnet Mask should be set [255.255.255.0] for example.

Rule2

The start address [xxx.xxx.xxx.0] and the last address [xxx.xxx.xxx.255] of the IP address must not be assigned to any other equipment. These address numbers are reserved.

Rule3

The IP address must correlate to a network number. If network numbers are different between the equipment, they cannot establish communications each other. In this case, the router is placed in the networks to make the routing.

**Q What is the MAC address assigned to the Network Board?**

**A** The MAC address is indicated on the printed board as the below.

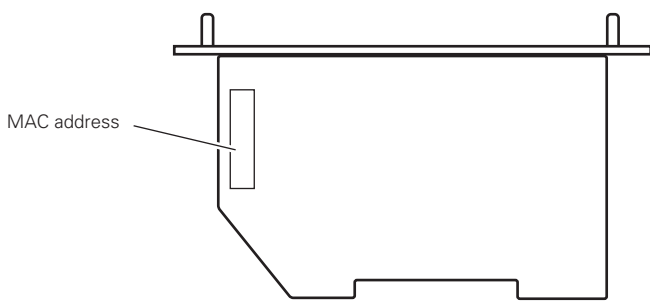





## Free Manuals Download Website

<http://myh66.com>

<http://usermanuals.us>

<http://www.somanuals.com>

<http://www.4manuals.cc>

<http://www.manual-lib.com>

<http://www.404manual.com>

<http://www.luxmanual.com>

<http://aubethermostatmanual.com>

Golf course search by state

<http://golfingnear.com>

Email search by domain

<http://emailbydomain.com>

Auto manuals search

<http://auto.somanuals.com>

TV manuals search

<http://tv.somanuals.com>