

INSTRUCTION MANUAL

Pharmaceutical Refrigerator

MPR-513 MPR-513R MPR-1013 MPR-1013R



MPR-513R



MPR-1013R

Note:

1. No part of this manual may be reproduced in any form without the expressed written permission of SANYO.
2. The contents of this manual are subject to change without notice.
3. Please contact SANYO if any point in this manual is unclear or if there are any inaccuracies.

SANYO Electric Biomedical Co., Ltd. All rights reserved. Printed in Japan.

CONTENTS

| | |
|--------------------------------|-------|
| PRECAUTIONS FOR SAFE OPERATION | P. 2 |
| CAUTIONS FOR USAGE | P. 6 |
| ENVIRONMENTAL CONDITIONS | P. 7 |
| REFRIGERATOR COMPONENTS | P. 8 |
| INSTALLATION | P. 11 |
| OPTIONAL COMPONENTS | P. 13 |
| START-UP OF UNIT | P. 15 |
| DEFROST CYCLES | P. 15 |
| TEMPERATURE SETTING | P. 16 |
| ALARMS & SAFETY FUNCTIONS | P. 18 |
| ROUTINE MAINTENANCE | P. 20 |
| TROUBLE SHOOTING | P. 23 |
| DISPOSAL OF UNIT | P. 23 |
| SPECIFICATIONS | P. 24 |
| PERFORMANCE | P. 25 |
| SAFETY CHECK SHEET | P. 26 |

PRECAUTIONS FOR SAFE OPERATION

It is imperative that the user complies with this manual as it contains important safety advice.

Items and procedures are described so that you can use this unit correctly and safely. If the precautions advised are followed, this will prevent possible injury to the user and any other person.

Precautions are illustrated in the following way:

WARNING

Failure to observe WARNING signs could result in a hazard to personnel possibly resulting in serious injury or death.

CAUTION

Failure to observe CAUTION signs could result in injury to personnel and damage to the unit and associated property.

Symbol shows;

 this symbol means caution.

 this symbol means an action is prohibited.

 this symbol means an instruction must be followed.

Be sure to keep this manual in a place accessible to users of this unit.

< Label on the unit >















This mark is labeled on the cover in which the electrical components of high voltage are enclosed to prevent the electric shock.

The cover should be removed by a qualified engineer or a service personnel only.











PRECAUTIONS FOR SAFE OPERATION

WARNING



-  **Do not use the unit outdoors.** Current leakage or electric shock may result if the unit is exposed to rain water.
 -  **Only qualified engineers or service personnel should install the unit.** The installation by unqualified personnel may cause electric shock or fire.
 -  **Install the unit on a sturdy floor.** If the floor is not strong enough or the installation site is not adequate, this may result in injury from the unit falling or tipping over.
 -  **Never install the unit in a humid place or a place where it is likely to be splashed by water.** Deterioration of the insulation may result which could cause current leakage or electric shock.
 -  **Never install the unit in a flammable or volatile location.** This may cause explosion or fire.
 -  **Never install the unit where acid or corrosive gases are present** as current leakage or electric shock may result due to corrosion.
 -  **Use a dedicated power source** as indicated on the rating label attached to the unit. **Ensure that a suitable fuse of adequate amperage is used to allow for compressor start up.**
 -  **Remove dust from the power supply plug** before inserting in a power source. A dusty plug or improper insertion may pose a hazard.
 -  **Use a power supply outlet with ground (earth)** to prevent electric shock. If the power supply outlet is not grounded, it will be necessary to install a ground by qualified engineers.
 -  **Never ground the unit through a gas pipe, water main, telephone line or lightning rod.** Such grounding may cause electric shock in the case of an incomplete circuit.
 -  **Do not insert metal objects such as a pin or a wire into any vent, gap or any outlet** for inner air circulation. This may cause electric shock or injury by accidental contact with moving parts.
 -  **Never store volatile or flammable substances** in this unit. This may cause explosion or fire.
 -  **Never store corrosive substances** in this unit. This may lead to damage to the inner components or electric parts.
- If this unit is to be used for storing poisons, radioactive material or other harmful products, ensure that it is in a safe area.** Failure to do so may lead to an adverse effect on the health of personnel in the area and the local environment. In this case, a request for repair or maintenance will necessitate a safety check sheet for maintenance personnel.

PRECAUTIONS FOR SAFE OPERATION

WARNING







-  **Do not pull out more than 2 drawers at the same time** when storing or taking out of the stocked material. This may cause injury by falling or tipping of the unit if something heavy items are stored.
-  **Disconnect the power supply to the unit prior to any repair or maintenance** of the unit in order to prevent electric shock or injury.
-  **Ensure you do not inhale or consume medication or aerosols** from around the unit at the time of maintenance. These may be harmful to your health.
-  **Never splash water directly onto the unit** as this may cause electric shock or short circuit.
-  **Never disassemble, repair, or modify the unit yourself.** Any such work carried out by an unauthorized person may result in fire or injury due to a malfunction.
-  **Disconnect the power supply plug before replacement of the fluorescent lamp** to prevent electric shock.
-  **Disconnect the power supply plug if there is something wrong with the unit.** Continued abnormal operation may cause electric shock or fire.
-  If the unit is to be stored unused in an unsupervised area for an extended period, **ensure that children do not have access and that doors cannot be closed completely.**
-  **The disposal of the unit should be undertaken by appropriate personnel.** Remove doors to prevent accidents such as suffocation.
-  **Prepare a safety check sheet** when you request any repair or maintenance for the safety of service personnel.

CAUTION

-  **Select a level and sturdy floor for installation.** This precaution will prevent the unit from tipping. Improper installation may result in water spillage or injury from the unit tipping over.
-  **Never install the unit in a place where the possibility exists that an object may fall on it.** There are electric components in the upper part of this unit. Current leakage or electric shock may be caused if an object falls on it.
-  **Connect the unit to a power source as indicated on the rating label attached to the unit.** Use of any other voltage or frequency other than that on the rating label may cause fire or electric shock.

PRECAUTIONS FOR SAFE OPERATION

CAUTION

-  **Fix the shelves securely.** Incomplete installation may cause injury or damage.
-  **When removing the plug from the power supply outlet, grip the power supply plug,** not the cord. Pulling the cord may result in electric shock or fire by short circuit.
-  **Never damage or break the power supply plug or cord. Do not use the supply plug if its cord is loose.** This may cause fire or electric shock.
-  **Do not touch any electrical parts** such as the power supply plug or any switches with a wet hand. This may cause electric shock.
-  **Do not put a container with water or heavy articles on the unit.** Injury may be caused if the articles fall. Current leakage or electric shock may result from the introduction of spilled water into electrical components.
-  **Do not climb onto the unit.** This may cause damage to the unit and cause it to tip over.
-  **Hold the handle when closing the door.** This will reduce the likelihood of a trapped finger.
-  **Never place your hand on the glass or use excessive force on the glass.** Intentional force may break the glass resulting in injury from the broken glass.
-  **Do not touch the condenser directly** when the filter is removed for cleaning. This may cause injury due to hot surface. (MPR-1013, MPR-1013R only)
-  **Disconnect the power supply plug** before moving the unit. Take care not to damage the power cord. A damaged cord may cause electric shock or fire.
-  **Dispose of any water in the evaporation tray completely before moving the unit.** Spilled or splashed water may cause current leakage or electric shock.
-  **Be careful not to tip the unit over** during movement to prevent damage or injury.
-  **Disconnect the power plug** when the unit is not used for long periods.
-  **Do not put the packing plastic bag used in the packaging within reach of children** as suffocation may result

CAUTIONS FOR USAGE

1. If the unit is unplugged or the power to the unit is interrupted, do not restart the unit for at least 5 minutes. This protects the compressor.
2. This inner cabinet is refrigerated by forced circulation of cooled air inside the chamber. Ensure that the intake and exhaust air vents are not blocked.
3. Adequate space should be provided between the items inside the unit to allow air circulation.
4. The temperature alarm may be operated at the time of first start-up. The alarm will be canceled automatically when the chamber temperature will reach the set temperature.
5. Check that the door is closed tightly. The door check lamp lights when the door is open. The alarm buzzer sounds two minutes after door opening. The buzzer can be canceled automatically when the door is closed.
6. Always open and close the door gently. Rough door operation may lead fall down of stocked items, incomplete closing, or damage of door gasket.
7. Never store corrosive materials such as acid or alkali unless the container is completely sealed up. Corrosion may lead to failure of the unit in time.
8. Once the chamber temperature has stabilized, put the items into the chamber in small batches to minimize the temperature increase.
9. Fix the shelves securely and make sure to place any materials on the shelves. Do not place items on the floor of the chamber.
10. If an instrument requiring a power source is placed inside the cabinet, the cable can be lead through the access port on the cabinet. After installation, a rubber cap should be used to seal the access port. Failure to do this can affect the temperature uniformity inside the cabinet and lead the condensation on the outside of the access port.
11. In case condensation forms on the front glass or frame due to a high humidity environment, wipe it off with a soft and dry cloth.
12. Do not clean the unit with scrubbing brushes, acid, thinner, solvents powdered soap, cleanser or hot water. These agents can scratch the paint or cause it to peel. Plastic and rubber parts can be easily damaged by these materials, especially solvents. When a neutral detergent is used to clean the unit, wipe it up thoroughly with a cloth soaked in clean water.
13. Check the condenser filter and clean it regularly. A dusty filter may cause temperature increase in the chamber or compressor failure. (MPR-1013, MPR-1013R only)

CAUTIONS FOR USAGE

Circuit breaker

This unit is equipped with a circuit breaker on the back. Make sure to switch ON this breaker before the unit starts to run. Following figures show the circuit breaker position.

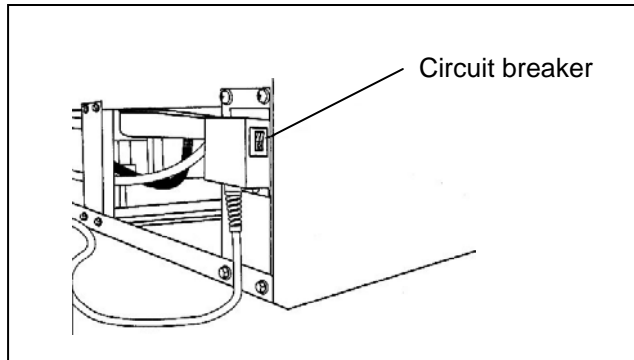

When the operation of the unit is stopped by this breaker, contact a dealer or a service station after disconnected the power supply plug.

⚠ WARNING

Never disassemble, repair, or modify the unit yourself. Any such work carried out by an unauthorized person may result in fire or injury due to a malfunction.

Disconnect the power supply plug if there is something wrong with the unit. Continued abnormal operation may cause electric shock or fire.

⚠ CAUTION

Connect the unit to a power source as indicated on the rating label attached to the unit. Use of any other voltage or frequency other than that on the rating label may cause fire or electric shock.

ENVIRONMENTAL CONDITIONS

This equipment is designed to be safe at least under the following conditions (based on the IEC 1010-1):

1. Indoor use;
2. Altitude up to 2000 m;
3. Ambient temperature 5°C to 40°C
4. Maximum relative humidity 80% for temperature up to 31°C decreasing linearly to 50% relative humidity at 40°C;
5. Mains supply voltage fluctuations not to exceed $\pm 10\%$ of the nominal voltage;
6. Other supply voltage fluctuations as stated by the manufacturer;
7. Transient overvoltages according to Installation Categories (Overvoltage Categories) II; For mains supply the minimum and normal category is II;
8. Pollution degree 2 in accordance with IEC 664.

REFRIGERATOR COMPONENTS

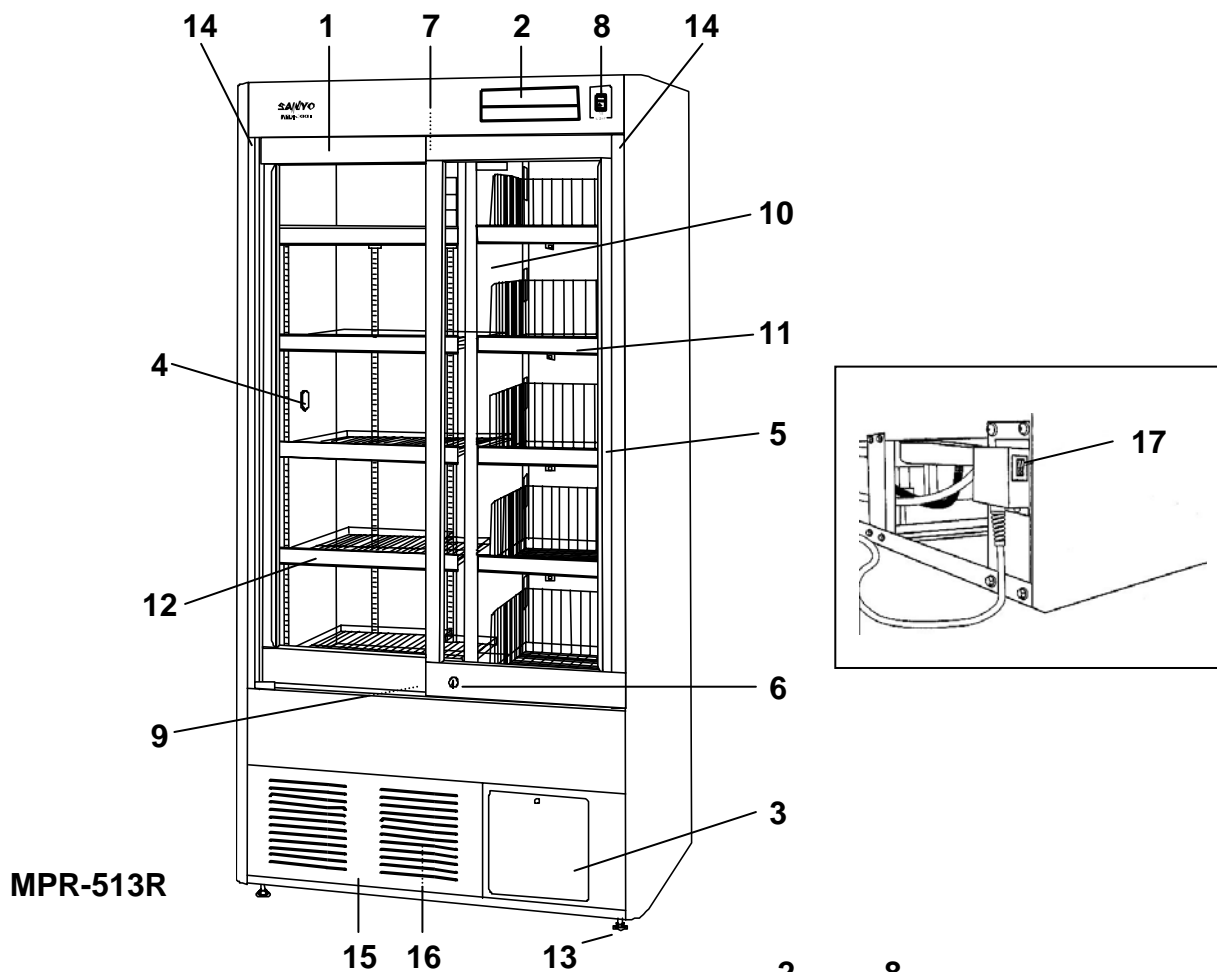

MPR-513R

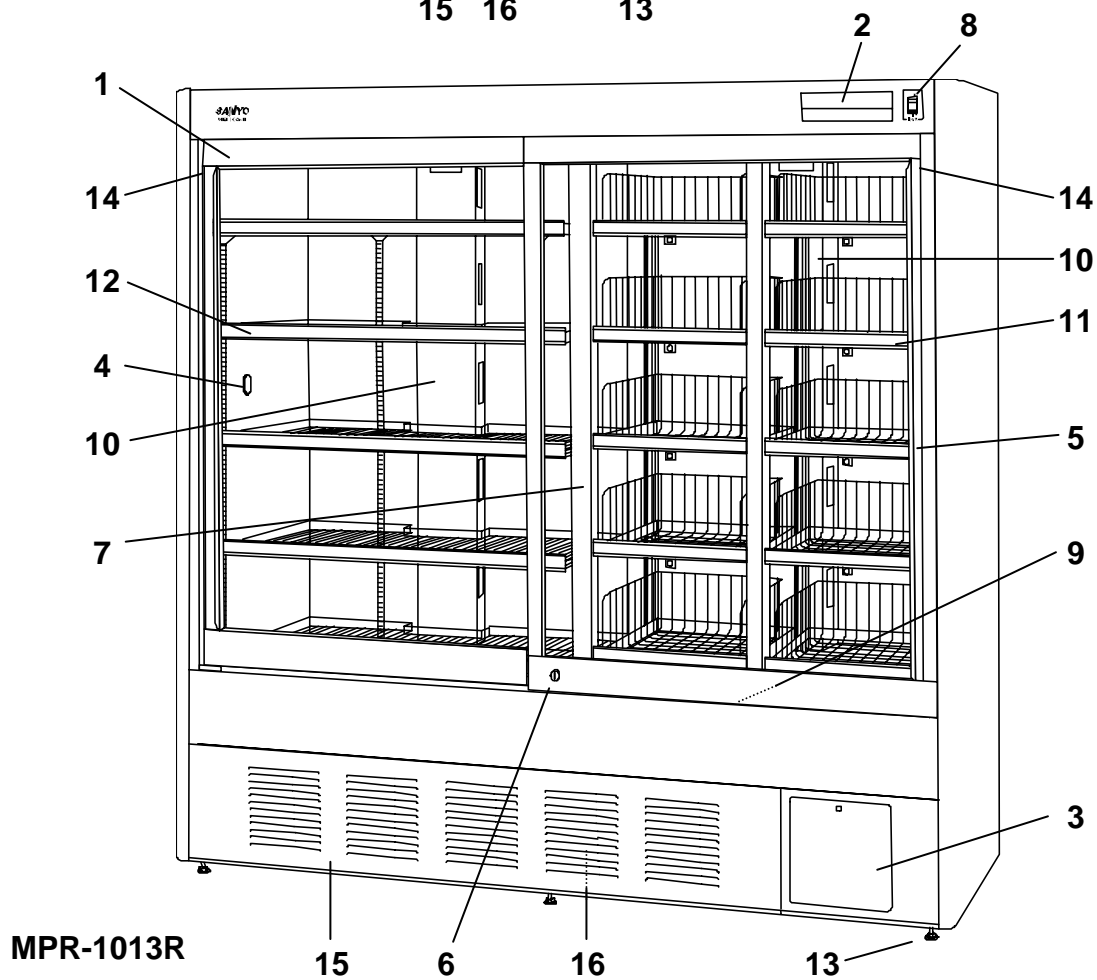

MPR-1013R

REFRIGERATOR COMPONENTS

1. Door:

Sliding type. The recessed portion on the rail enables the self-closing of the door. The glass is pair construction.

2. Control panel:

Panel can be opened when upper right corner of the lower part cover is pushed. Refer to page 10.

3. Space for automatic temperature recorder:

An automatic temperature recorder (optional accessory) can be mounted here. See page 13.

4. Access port:

This port allows temperature measurement cables to enter the chamber from outside.

5. Handle:

Always hold the middle of the handle indicated by a label when opening/closing the door.

6. Lock:

To lock, turn clockwise to 90° with a key, push the key and turn counterclockwise to 90° with the key pushed. The door can be securely locked.

7. Fluorescent lamp:

20 W white light in MPR-513 and MPR-513R. 40 W white light in MPR-1013 and MPR-1013R. For the replacement, refer to page 22.

8. Light switch:

This switch is used for turning the fluorescent lamp off and on.

9. Air intake vent (in the chamber):

Do not block this vent. If this vent is blocked, temperature regulation will become unstable.

10. Air exhaust vent:

Do not block this vent. If this vent is blocked, temperature regulation will become unstable. Do not place stored items in the path of the cold air.

11. Drawer (Right side of MPR-1013R and MPR-513R):

Items to be stored in the chamber must be placed on the drawers. To pull out the drawer, take out the drawer with pushing the button on the bottom of the drawer. The maximum storage weight for each drawer is 20 kg.

12. Shelf:

Items to be stored in the chamber must be placed on the shelves. The maximum storage weight for each shelf is 50 kg. (For MPR-513R, allowable weight is 20 kg.) Do not put stored items directly onto the interior floor of the chamber.

13. Leveling feet:

Adjust the height of the leveling feet by turning the screw bolts until the unit is level.

14. Door switch:

The door check lamp is lit when the door is open.

15. Unit cover:

The refrigerating units are mounted inside the cover. Remove this cover at the time of cleaning of evaporating tray and filter (filter is attached in MPR-1013 and MPR-1013R only).

16. Evaporating tray:

Defrost water from the evaporator accumulates on the tray and evaporates into the atmosphere. See page 21 for cleaning.

17. Circuit breaker:

Switch ON this breaker before the unit starts to run. When the operation of the unit is stopped by this breaker, contact a dealer or a service station after disconnected the power supply plug.

REFRIGERATOR COMPONENTS

Control panel and keypad

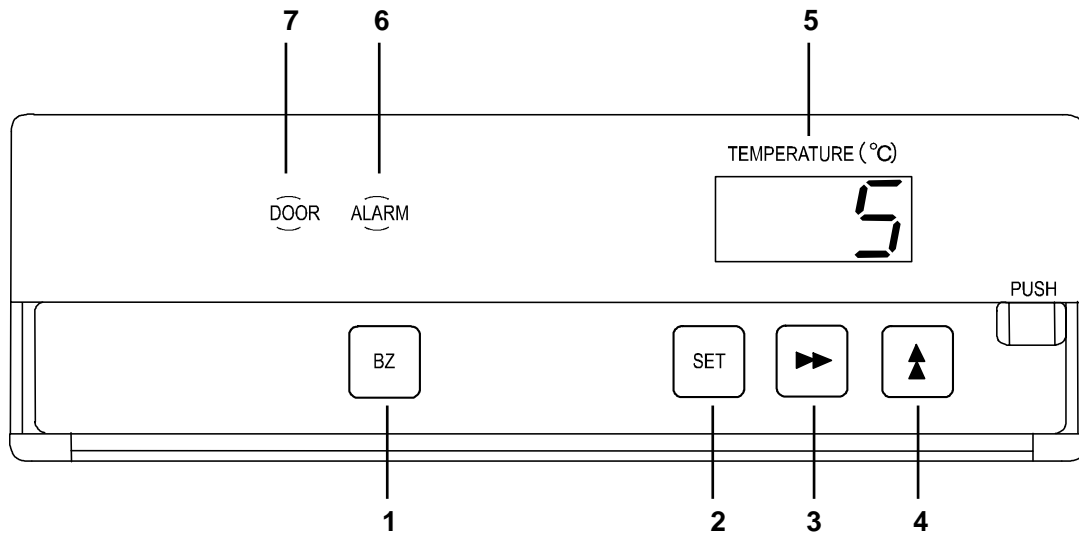

1. Buzzer stop key (BZ): To silence the audible alarm, press this key. Press it once again to reactivate the alarm.

2. Set key (SET): Temperature setting mode is initiated by pressing this key. Once the key is pressed, the digit to be changed will flash. Pressing this key again after setting the desired temperature stores the set temperature in the memory.

3. Digit shift key (▶▶): Pressing this key in the set mode alters the digit to be set. Key lock is available by pressing this key for more than 5 seconds in the temperature display mode. See page 16.

4. Numerical value shift key (▲): Pressing this key in the set mode causes the numerical value to scroll up. "ON-OFF" of key lock can be selected by pressing this key in the key lock mode. See page 16.

5. Digital temperature indicator: This indicator shows the present chamber temperature or set temperature.

6. Alarm lamp (ALARM): This lamp flashes during an alarm condition.

7. Door alarm lamp (DOOR): This lamp is lit when the door is opened.

INSTALLATION

Installation site

To operate this unit properly and to obtain maximum performance, install the unit in a location with the following conditions:

1. A location not subjected to direct sunlight

Installation in a location subjected to direct sunlight may lead to inadequate cooling.

2. A location with adequate ventilation

Leave at least 10 cm around the unit for ventilation. Poor ventilation will result in a reduction of the refrigeration capacity.

3. A location away from heat generating sources

Avoid installing the unit near heat-emitting appliances such as gas ranges or stoves. Heat can cause inefficient refrigeration.

4. A location with a sturdy and level floor



WARNING

Install the unit on a sturdy floor. If the floor is not strong enough or the installation site is not adequate, this may result in injury from the unit falling or tipping over.

Select a level and sturdy floor for installation. This precaution will prevent the unit from tipping. Improper installation may result in water spillage or injury from the unit tipping over.

5. A location where objects will not fall on the unit



CAUTION

Never install the unit in a place where the possibility exists that an object may fall on it. There are cooling circuits and electric components in the upper part of this unit. Current leakage or electric shock may be caused if an object falls on it.

6. A location without flammable or corrosive gas



WARNING

Never install the unit in a flammable or volatile location. This may cause explosion or fire.

Never install the unit where acid or corrosive gases are present as current leakage or electric shock may result due to corrosion.

7. A location not prone to high humidity



WARNING

Do not use the unit outdoors. Current leakage or electric shock may result if the unit is exposed to rain water.

Never install the unit in a humid place or a place where it is likely to be splashed by water. Deterioration of the insulation may result which could cause current leakage or electric shock.



CAUTION

The unit starts defrosting frequently due to excessive frost on the evaporator if it is installed in high temperature and high humidity location. **The chamber temperature goes up to approximately 10°C temporarily during defrosting.**

INSTALLATION

Installation

1. Remove the packaging materials and tapes

Remove all transportation packaging materials and tapes. Open the doors and ventilate the unit. If the outside panels are dirty, clean them with a neutral detergent and wipe it off with a soft cloth washed in clean water.

2. Adjust the leveling foot

Extend the leveling feet by rotating them counterclockwise until they make contact with the floor. See Fig. 1. Ensure the unit is level.

3. Fix the unit

Two fixtures are attached to the rear of the frame. Fix the frame to the wall by attaching a rope or chain between the wall and the fixtures.

- 1) Reattach the fixtures as shown in Fig. 2.
- 2) If holes can be drilled in the wall, drill a 10.5mm diameter hole and fix the unit by using the special bolt-nut supplied. This bolt-nut can only be used on a concrete wall. See Fig. 3.

4. Ground (earth)

WARNING

Use a power supply outlet with ground (earth) to prevent electric shock. If the power supply outlet is not grounded, it will be necessary to install a ground by qualified engineers.

Never ground the unit through a gas pipe, water main, telephone line or lightning rod. Such grounding may cause electric shock in the case of an incomplete circuit.

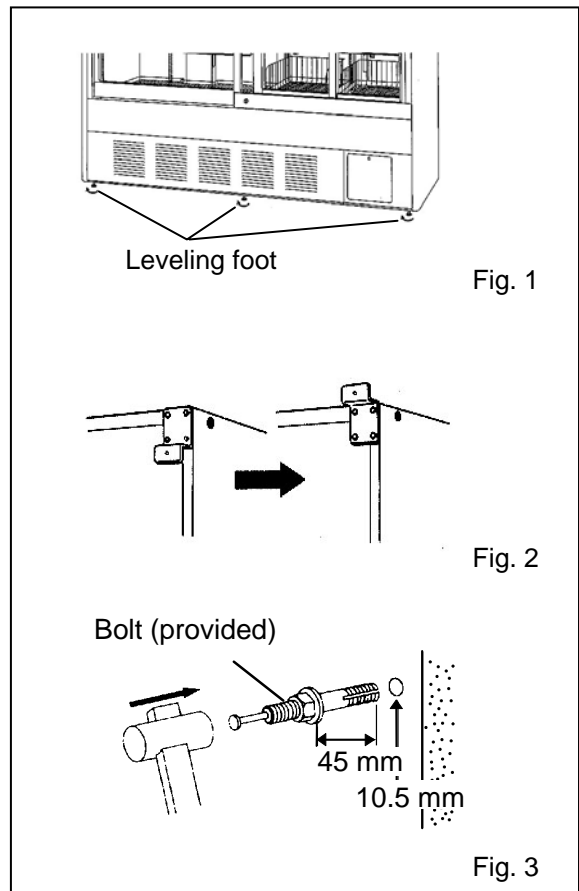

OPTIONAL COMPONENTS

Automatic temperature recorder

An automatic temperature recorder is available for this refrigerator as an optional accessory. If an automatic temperature recorder is required, contact your Sanyo dealer.

For the proper usage of temperature recorder, refer to an instruction manual included with the recorder.

The available recorder and a dedicated fixture is as follows:

Recorder: Model MTR-G04A (AC 100 to 150 V)

Model MTR-G04C (AC 220 to 240 V)

Fixture: Model MPR-S7

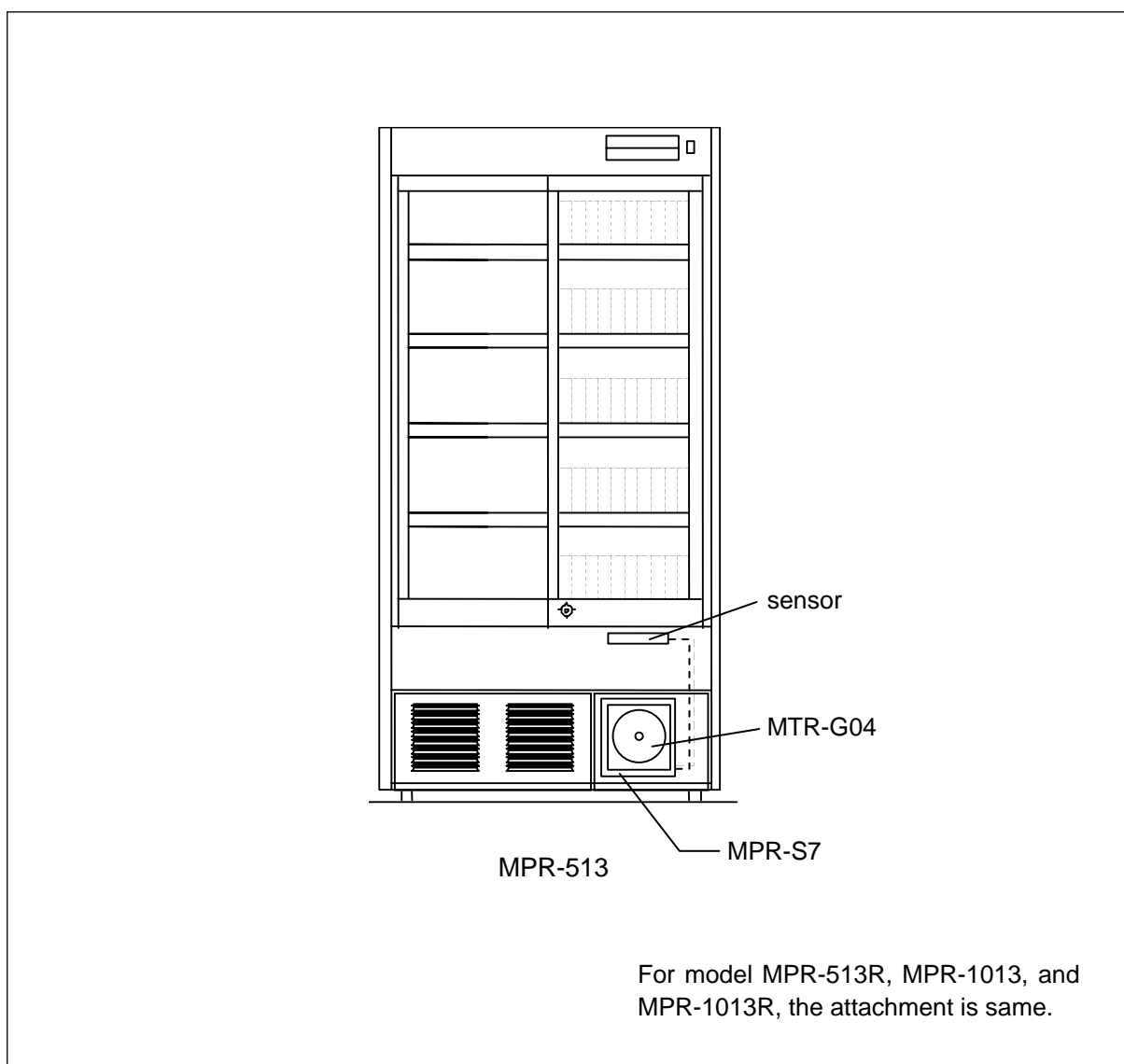

OPTIONAL COMPONENTS

Attachment of recorder MTR-G04

WARNING

Always disconnect the power supply plug before installing an automatic temperature recorder in order to prevent electric shock or injury.

1. Follow the instruction manual provided with the temperature recorder and attach the recorder to the fixture MPR-S7.
2. Open the cover for recorder attachment space by removing the screw.
3. Remove the cover by pushing the shaft on both side outward. See Fig. 1.
4. As shown in Fig. 2, attach the temperature recorder to the fixture with enclosed screws.
5. Remove two screws fixing the plate for air intake vent (far right side) and remove the plate.
6. Lead the sensor of the recorder in the chamber through the hole after taking out the thermal insulation from it as shown in Fig. 3.
7. Fix the recorder sensor to the sensor fixture as shown in Fig. 4.
8. Connect the connector on recorder with that on the unit. See Fig. 5
9. After installing the bottom cut of the fixture on the shaft, secure the fixture by screws.
10. Return the thermal insulation and then attach the plate for air intake vent to the original place.

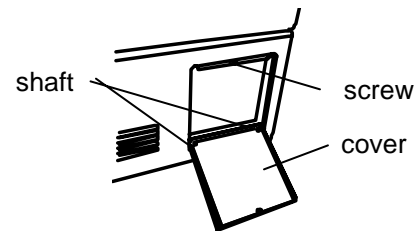

Fig. 1

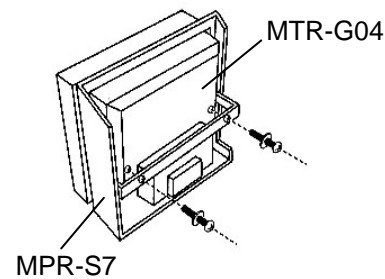

Fig. 2

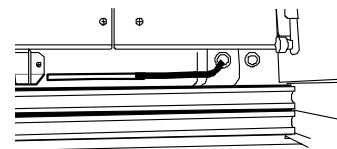

Fig. 3

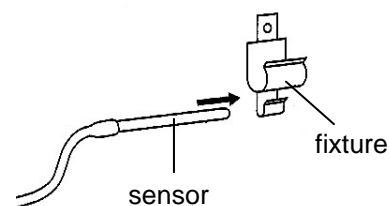

Fig. 4

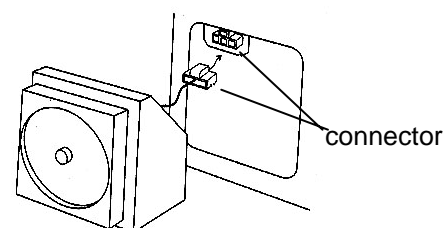

Fig. 5

START-UP OF UNIT

Follow the procedures for the initial and consequent operations of the unit.

1. Connect the power cord to the dedicated outlet with appropriate rating.
2. On start-up, the alarm buzzer sometimes operates. In this case, stop the buzzer by pressing the alarm stop key (BZ).
3. Set the chamber temperature to 5°C.
4. Allow the chamber temperature to fall to 5°C. Check the chamber temperature on the temperature indicator.
5. Turn on the fluorescent light switch to check the light. After checking, turn off the switch if the light is not necessary.
6. Set the desired temperature. When the chamber temperature gets to the set temperature, begin slowly placing items into the chamber to minimize the temperature rise.

DEFROST CYCLES

There is no need for routine defrosting of the unit as this occurs automatically as follows:

1. Cycle defrost

To keep the chamber temperature stable, the refrigeration compressor is cycled on and off. During “off” period any frost which has accumulated on the evaporator is melted by energizing a defrost heater. This will not have any discernible effect on the chamber temperature.

2. Forced defrost

When the ambient humidity is high, or a large amount of damp product is being stored inside the chamber, there is a possibility that cycle defrost may not be enough to remove all of the frost on the evaporator. In this case, a forced defrost cycle can be initiated.

When the unit is operating under a forced defrost cycle, the current chamber temperature and dF is displayed alternately on the digital temperature display.

Once the forced defrost cycle is completed, normal operation resumes.

CAUTION

The unit may collect excessive frost on the evaporator if it is installed in high temperature and high humidity location. For example, the unit starts to defrost once a week with 2°C setting in the ambient of 35°C and 80% R.H. **The chamber temperature goes up to approximately 10°C temporarily during defrosting.**





TEMPERATURE SETTING

Chamber temperature

Table 1 shows the basic procedure for setting the chamber temperature. Perform key operations in the sequence indicated in the table. The example in the table is based on the assumption that the desired temperature is 4°C.

Note: The unit is set at the factory with a chamber temperature of 5°C.

Table 1. Basic operation sequence (Example: Chamber set temperature 4°C)

| | Description of operation | Key operated | Indication after operation |
|---|---|--------------|--|
| 1 | Turn the power switch ON. | ---- | The current chamber temperature is displayed.  |
| 2 | Press SET key. | SET | The first digit is flashed.  |
| 3 | Press ▲ key and scroll the figure to 4. | ▲ | When pressed, the figure of settable digit increases.  |
| 4 | Press SET key. | SET | Set temperature is memorized and the current chamber temperature is displayed.  |

Note:

The temperature set mode returns to the temperature display mode automatically when 90 seconds has passed without any key operation. In this case, the chamber temperature setting is not accepted.

The available set range of chamber temperature is between 2 and 14°C. The partial freezing may occurred if the set temperature is lower than 3°C.

Key lock function

This unit is provided with a key lock function. When the key lock is ON, change of temperature setting through the key pad is not available. The key lock is set in OFF at the factory.







| Display | Mode | Function |
|---|-----------------|--|
|  | Key lock is OFF | Enable to change of temperature setting |
|  | Key lock is ON | Disable to change of temperature setting |

Table 2. Procedure for key lock setting (change from key lock OFF to key lock ON)

| | Description of operation | Key operated | Indication after operation |
|---|---|--------------|--|
| 1 | | ---- | The current chamber temperature is displayed.  |
| 2 | Press ►► key for 5 seconds. | ►► | The first digit is flashed.  |
| 3 | Press ▲ key and scroll the figure to 1. | ▲ | When pressed, the figure of settable digit increases.  |
| 4 | Press SET key. | SET | The key lock is set to ON. The current chamber temperature is displayed.  |

TEMPERATURE SETTING

Alarm temperature setting

This unit is provided with both high and low temperature alarms. The temperature at which the alarm is activated may be changed.

The available set range for high temperature alarm is between +2°C and +14°C and -2°C and -14°C for low temperature alarm against the chamber temperature.

Note: The temperature alarm is set at $\pm 5^\circ\text{C}$ of the set temperature at the factory.

| Display | Mode | Function |
|---------|----------------------------|------------------------|
| F01 | High temperature alarm set | See Table 5 on page 18 |
| F02 | Low temperature alarm set | See Table 5 on page 18 |

As an example, Table 3 shows the procedure to set the high temperature alarm so that the alarm can activate when the chamber temperature is 3°C higher than the set temperature.

Table 4 shows the procedure to set the low temperature alarm so that the alarm can activate when the chamber temperature is 3°C lower than the set temperature.

Table 3. Procedure for setting high temperature alarm

| | Description of operation | Key operated | Indication after operation |
|---|--|--|---|
| 1 | | ---- | The current chamber temperature is displayed. □□4 |
| 2 | Press \blacktriangle key for 5 seconds. | \blacktriangle | The first digit is flashed. F00 |
| 3 | Press \blacktriangle key and scroll the figure to 1. | \blacktriangle | When pressed, the figure of settable digit increases. F01 |
| 4 | Press SET key. | SET | The first digit is flashed. 005 |
| 5 | Set the temperature to 003 with the $\blacktriangleright\blacktriangleright$ key and \blacktriangle key. | $\blacktriangleright\blacktriangleright$ | Pressing the key shifts the digit which can be set. |
| | | \blacktriangle | When pressed, the figure of settable digit increases. 003 |
| 6 | Press SET key. | SET | Alarm temperature is memorized and the current chamber temperature is displayed. □□4 |

Table 4. Procedure for setting low temperature alarm

| | Description of operation | Key operated | Indication after operation |
|---|--|--|---|
| 1 | | ---- | The current chamber temperature is displayed. □□4 |
| 2 | Press \blacktriangle key for 5 seconds. | \blacktriangle | The first digit is flashed. F00 |
| 3 | Press \blacktriangle key and scroll the figure to 2. | \blacktriangle | When pressed, the figure of settable digit increases. F02 |
| 4 | Press SET key. | SET | The first digit is flashed. -05 |
| 5 | Set the temperature to -03 with the $\blacktriangleright\blacktriangleright$ key and \blacktriangle key. | $\blacktriangleright\blacktriangleright$ | Pressing the key shifts the digit which can be set. |
| | | \blacktriangle | When pressed, the figure of settable digit increases. -03 |
| 6 | Press SET key. | SET | Alarm temperature is memorized and the current chamber temperature is displayed. □□4 |

Note: The alarm may operate depending on the setting of high temperature alarm when a large amount of load is put in the chamber after defrosting. This does not mean abnormality. The alarm is canceled automatically when the chamber temperature gets to the set temperature.

With regardless the setting of low temperature alarm, the alarm is activated when the chamber temperature is lower than 0°C. This is a safety function to prevent the stocked materials from freezing.

ALARMS & SAFETY FUNCTIONS

This unit has the alarms and safety functions shown in Table 5, and also self diagnostic functions.

Table 5. Alarms and safety functions

| Alarm & Safety | Situation | Indication | Buzzer | Safety operation |
|----------------------------|---|---|--|--|
| High temperature alarm | If the chamber temperature deviates from the set temperature +2°C or up to +14°C. | ALARM lamp is flashed. Temperature indicator is flashed. | Intermittent tone with 15 minutes delay. | Remote alarm with 15 minutes delay. |
| Low temperature alarm | If the chamber temperature deviates from the set temperature -2°C or up to -14°C. | ALARM lamp is flashed. Temperature indicator is flashed. | Intermittent tone with 15 minutes delay. | Remote alarm with 15 minutes delay. |
| | If the chamber temperature is lower than 0°C. | | Intermittent tone | Remote alarm |
| Over-heat protection | When the chamber temp. is higher than 28°C. (Reset when the chamber temp. is lower than about 18°C) | ----- | ----- | Inside fan, drain pan heater, defrost heater OFF |
| Over-cooling protection | When the chamber temp. is lower than -1°C. (Reset when the chamber temp. is higher than 8°C) | ----- | ----- | Compressor OFF |
| Power failure alarm | When the power to the unit is disconnected. | ----- | ----- | Remote alarm. |
| Door alarm | When the door is open. | Door check lamp is lit. | Intermittent tone with 2 minutes delay. | ----- |
| Auto-return | When there is no key pressing in each setting mode for 90 seconds. | Chamber temperature is displayed. | ----- | Finishing of each setting mode. |
| Key lock | When the key lock is "ON". | ----- | ----- | Change of setting is disable. |
| Thermal sensor abnormality | If the thermal sensor is disconnected or short-circuited. | ALARM lamp is flashed. E01 and 50°C (or -50°C) are displayed alternately. | Intermittent tone | Remote alarm. Operation by the defrost sensor |
| | If the defrost sensor 1 is disconnected or short-circuited. | ALARM lamp is flashed. E02 and chamber temp. are displayed alternately. | Intermittent tone | Remote alarm. Unit keeps running. |
| | If the defrost sensor 2 is disconnected or short-circuited. (MPR-1013,1013R only) | ALARM lamp is flashed. E03 and chamber temp. are displayed alternately. | Intermittent tone | Remote alarm. Unit keeps running. |
| Memory back-up | When power failure or disconnected the power cord. | ----- | ----- | Set value memorized |

Note:

The remote alarm is silenced by pressing the buzzer stop key (BZ) as the remote alarm is operated in conjunction with the buzzer, except for the power failure alarm.

When more than two alarm conditions occur simultaneously, the lowest number error code has priority on the error display.

After a power failure, the unit will resume operation with the set value that was in place before power failure occurred.

The over-cooling protection may activate when the set temperature is 2°C. In this case, the chamber temperature will rise to 8°C, but this is not malfunction.

ALARMS & SAFETY FUNCTIONS

Remote alarm terminal

WARNING

Always disconnect the power supply to the unit prior to connection of alarm equipment to the terminal in order to prevent electric shock or injury.

The terminal to which a lead wire of remote alarm is connected is positioned in the box at the rear of the cabinet. The contact capacity is DC30V, 2A.

Contact output: at normal condition; "open"
at abnormal condition; "close"

Note:

The alarm is silenced by the alarm buzzer stop key (BZ) since the remote alarm is operated in conjunction with alarm buzzer.

Connection of remote alarm terminal

1. Remove the terminal cover at rear of cabinet.
2. Connect the lead wire of alarm equipment to the terminal.
3. Replace the terminal cover.

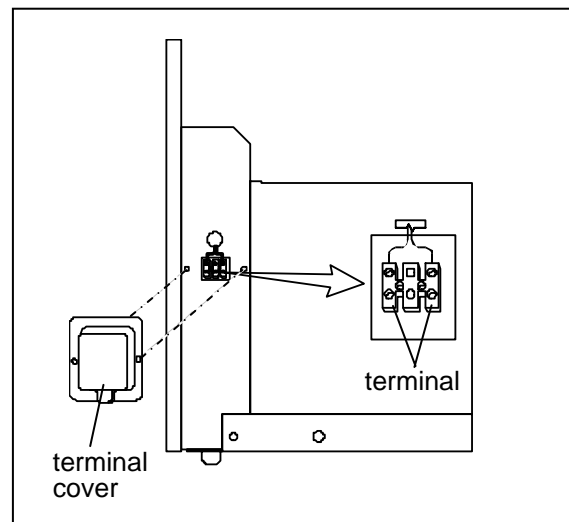

ROUTINE MAINTENANCE

⚠ WARNING

Always disconnect the power supply to the unit prior to any repair or maintenance of the unit in order to prevent electric shock or injury.

Ensure you do not inhale or consume medication or aerosols from around the unit at the time of maintenance. These may be harmful to your health.

⚠ CAUTION

Always wear dry gloves to protect hands at the time of maintenance. Failure to wear gloves may result in injury from edges and corners.

Cleaning of cabinet

1. Clean the unit once a month. Regular cleaning keeps the unit looking new.
2. Use a dry cloth to wipe off small amounts of dirt on the outside and inside of the unit and all accessories. If the unit is very dirty, use a neutral detergent.
3. After cleaning, wipe away the cleaner completely with a cloth washed in clean water.
4. Never pour water onto or into the unit. Doing so can damage the electric insulation and cause failure.
 - The compressor and other mechanical parts are completely sealed. This unit requires absolutely no lubrication.
 - Remove dust from the power supply plug periodically.

Cleaning of condenser filter (MPR-1013, 1013R)

1. Remove the screws on the bottom of the unit cover and remove the cover as shown in the figure.
2. Slide the filter to the left with holding on the black marking on the filter as shown in the figure.
3. Clean the filter with clean water and dry it completely .
4. After returning the filter to the original position and attach the unit cover.

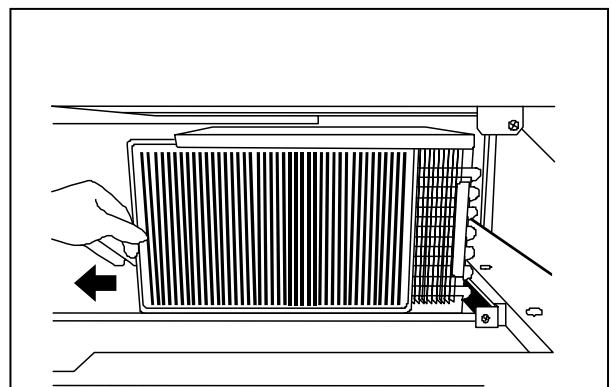

ROUTINE MAINTENANCE

Clean the evaporating tray once a month following the procedure below.

Cleaning of evaporating tray

1. Remove the screws on the bottom of the unit cover and remove the cover. See Fig. 1.

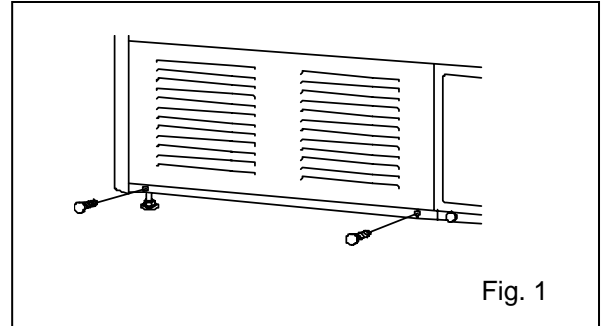

2. For model MPR-513 and MPR-513R, remove the evaporating tray mounting plate by pulling out the clips towards front. Then take out the evaporating tray as shown in Fig. 2 and Fig. 3.

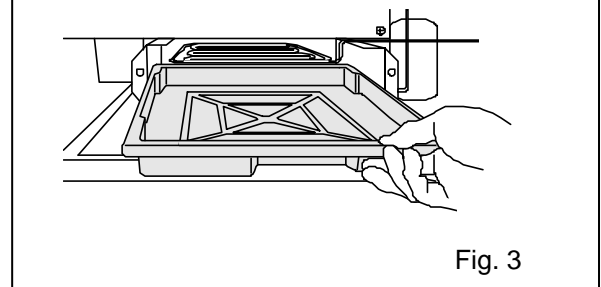
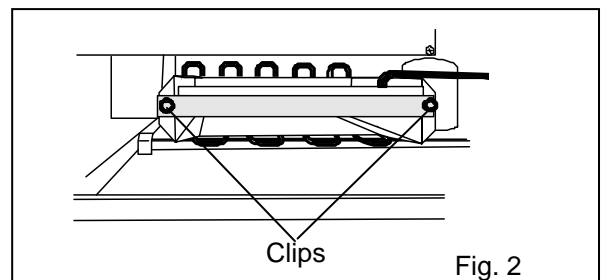

For MPR-1013 and MPR-1013R, as shown in Fig. 4, pull out the evaporating tray by lifting up and pulling out towards front.

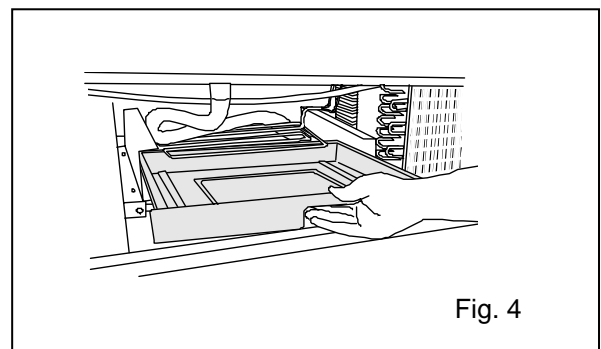

3. Wash away any accumulated dirt in the evaporating tray with a neutral detergent and clean water. Never use the hot or boiled water to clean the tray.

4. Replace the tray in its original position and attach the unit cover.

ROUTINE MAINTENANCE

Replacement of fluorescent lamp

1. The fluorescent lamp is placed vertically at the center of the frame (MPR1013 and MPR-1013R) and horizontally at the top front of the cabinet (MPR-513 and MPR-513R)

2. Turn off the fluorescent lamp switch and disconnect the power supply plug .

3. For MPR-513 and MPR-513R, remove the top shelf, for MPR-1013 and MPR-1013R, remove all shelves in the left side of the cabinet.

4. As shown in Fig. 1 and Fig. 2, pull the fluorescent lamp towards the rear together with the cover and wiring.

5. Take out the fluorescent lamp and remove the connector water-proofing rubber at both ends. As shown in Fig. 3, shift the rubber by rolling it.

6. Pull out the fluorescent lamp. Pull gently from the cover.

7. After replacing a new fluorescent lamp, return it to the original position.

Recommended fluorescent lamp:

MPR-513, MPR-513R: FL20SD

MPR-1013, MPR-1013R: FL40SD

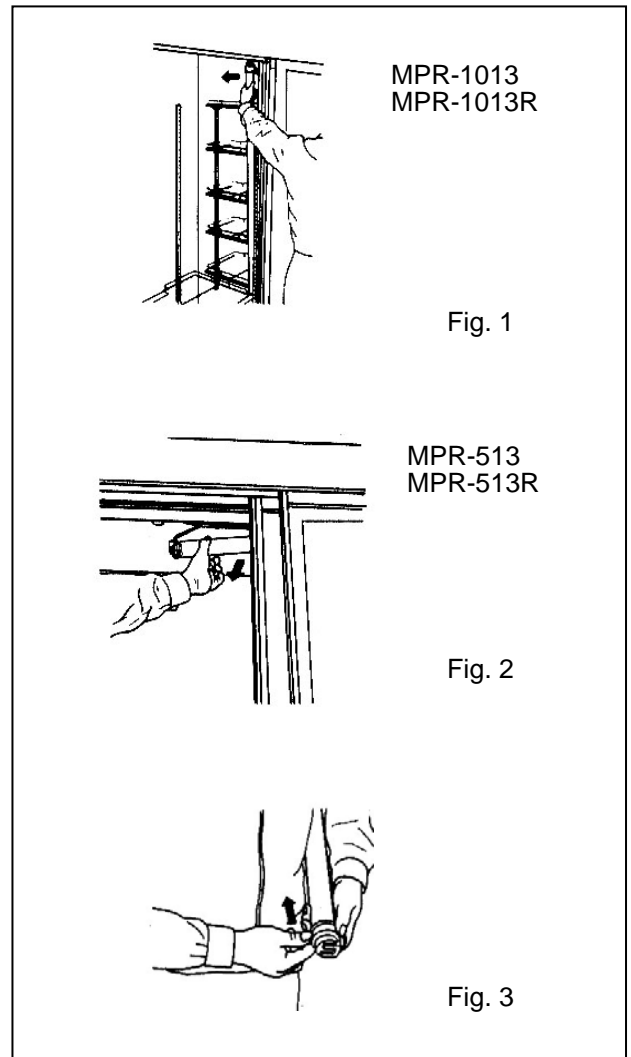

Replacement of glow starter

The glow starter is located on the right side of top front for MPR-513 and MPR-513R, and center of top front for MPR-1013 and MPR-1013R in the chamber.

1. Turn off the fluorescent lamp and then disconnect the power supply cord of the refrigerator.

2. Remove the water-proof cover and take out the glow starter.

3. Attach a new lamp surely. The starter designation is as follows:

MPR-513, MPR-513R: FG-1P

MPR-1013, MPR-1013R: FG-4P

4. Replace the water-proof cover on the glow starter.

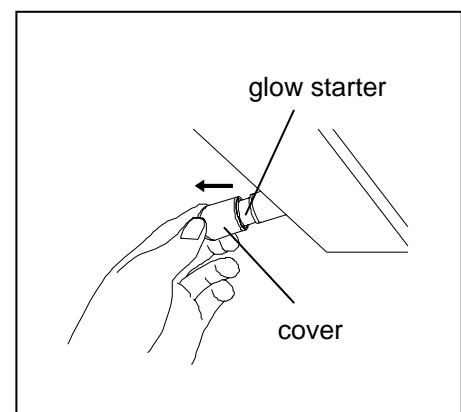

TROUBLESHOOTING

If the unit malfunctions, check out the following before calling for service.

If nothing operates even when switched on

1. There is a power failure.
2. The circuit breaker is inactivated.
3. The unit is not connected to the power supply.

When no key operation is available

1. The key lock is set in OFF (L 0).

The alarm device is activated

< On start-up >

1. The temperature in the unit does not match set value.

< In use >

1. The door was kept opened for a long time.
 2. The temperature setting was changed.
 3. The containers of high temperature (load) were put in the unit.
- In these cases, alarm is removed automatically by running the unit for several hours.

When unit does not get cold enough

1. A large amount of items or warm product was put in the unit.
2. Air exhaust vent is blocked up with containers.
3. The unit is in direct sunlight.
4. The door is frequently opened.
5. There is a nearby heat source.
6. Ambient temperature is too high.
7. The door is not securely closed.
8. The heat source is put in the unit.
9. The door seal is damaged or foreign substance is inserted between door gaskets.

DISPOSAL OF UNIT

WARNING

If the unit is to be stored unused in an unsupervised area for an extended period **ensure that children do not have access and doors cannot be closed completely.**

The disposal of the unit should be accomplished by appropriate personnel. Always remove doors to prevent accidents such as suffocation.

SPECIFICATIONS

| Name | Pharmaceutical Refrigerator | | | |
|------------------------------------|--|-----------|--|----------|
| Model | MPR-1013 | MPR-1013R | MPR-513 | MPR-513R |
| External dimensions | W1800 x D600 x H1790 (mm) | | W900 x D600 x H1790 (mm) | |
| Internal dimensions | W1700 x D465 x H1300 (mm) | | W800 x D465 x H1300 (mm) | |
| Effective capacity | 1037 L | 1034 L | 489 L | 486 L |
| Exterior | Painted steel | | | |
| Interior | Stainless steel | | | |
| Door | 2 pcs. , Sliding type, 2-layer pair glass with heat ray reflection film | | | |
| Insulation | Rigid polyurethane foamed-in place | | | |
| Shelves | Hard steel wire on polyester coating, 5 pcs. (10 pcs in MPR-1013 only) Allowable load; 50 kg/shelf (20 kg/shelf in MPR-513R only) | | | |
| Drawers (MPR-1013R, -513R only) | Hard steel wire on polyester coating, 10 pcs. (MPR-1013R), 5 pcs. (MPR-513R) Allowable load; 20 kg/shelf | | | |
| Cooling method | Forced cool air circulation | | | |
| Compressor | Hermetic type, Output; 300 W, 1 pc. | | Hermetic type, Output; 220 W, 1 pc. | |
| Fan motor | For chamber cooling; output 3 W, 2 pcs. For condenser; output 4 W, 1 pc. | | For chamber cooling; output 3 W, 1 pc. | |
| Evaporator | Fin and tube type, Forced air circulation | | | |
| Condenser | Fin and tube type, Forced air circulation | | Wire and tube condenser + skin condenser | |
| Refrigerant | R-134a | | | |
| Defrosting | Cycle defrost + forced defrost, Fully automatic | | | |
| Defrost heater | 175 W | | 148 W | |
| Temperature controller | Electronic control system (control range; between 2 and 14°C) | | | |
| Thermometer | Digital thermometer | | | |
| Fluorescent light | 40 W x 1 | | 20 W x 1 | |
| High temp. alarm | Flashing of temperature display and alarm lamp, Buzzer, (Remote alarm operated) | | | |
| Low temp. alarm | Flashing of temperature display and alarm lamp, Buzzer, (Remote alarm operated) | | | |
| Door alarm | Buzzer, Door check lamp ON | | | |
| Remote alarm contact | During alarm buzzer and power failure, Output; "close" | | | |
| Accessories | Key set; 1, Special bolt-nut; 2 | | | |
| Option | Automatic temperature recorder (MTR-G04A, -G04C) | | | |
| Weight | 240 kg | 252 kg | 136 kg | 142 kg |

Note: Design or specifications will be subject to change without notice.

PERFORMANCE

| | | | | | | |
|----------------------------|-------------------|----------|----------|----------|----------|----------|
| Model | MPR-513, MPR-513R | | | | | |
| Temperature control range | +2°C to +14°C | | | | | |
| Usable ambient temperature | -5°C to +35°C | | | | | |
| Noise level | 45dB (A scale) | | | | | |
| Maximum pressure | 1500 kPa | | | | | |
| Rated voltage | AC 110 V | AC 115 V | AC 220 V | AC 220 V | AC 230 V | AC 240 V |
| Rated frequency | 60 Hz | 60 Hz | 60 Hz | 50 Hz | 50 Hz | 50 Hz |
| Power consumption | 245 W | 220 W | 220 W | 205 W | 210 W | 210 W |

| | | | | | | |
|----------------------------|---------------------|----------|----------|----------|----------|----------|
| Model | MPR-1013, MPR-1013R | | | | | |
| Temperature control range | +2°C to +14°C | | | | | |
| Usable ambient temperature | -5°C to +35°C | | | | | |
| Noise level | 50 dB (A scale) | | | | | |
| Maximum pressure | 1343 kPa | | | | | |
| Rated voltage | AC 110 V | AC 115 V | AC 220 V | AC 220 V | AC 230 V | AC 240 V |
| Rated frequency | 60 Hz | 60 Hz | 60 Hz | 50 Hz | 50 Hz | 50 Hz |
| Power consumption | 340 W | 305 W | 285 W | 290 W | 305 W | 310 W |

Note: The unit with CE mark complies with EC directives 73/23/EEC, 89/336/EEC, and 93/68/EEC.

CAUTION

Please fill in this form before servicing.
Hand over this form to the service engineer to keep for his and your safety.

Safety check sheet

1. Refrigerator contents :

| | | |
|--------------------------------|-----|----|
| Risk of infection: | Yes | No |
| Risk of toxicity: | Yes | No |
| Risk from radioactive sources: | Yes | No |
| | Yes | No |

(List all potentially hazardous materials that have been stored in this unit.)

Notes :

2. Contamination of the unit

| | | |
|------------------|-----|----|
| Unit interior | | |
| No contamination | Yes | No |
| Decontaminated | Yes | No |
| Contaminated | Yes | No |
| Others: | Yes | No |

3. Instructions for safe repair/maintenance of the unit

| | | |
|-------------------------------------|-----|----|
| a) The unit is safe to work on | | |
| b) There is some danger (see below) | Yes | No |
| | Yes | No |

Procedure to be adhered to in order to reduce safety risk indicated in b) below.

Date :

Signature :

Address, Division :

Telephone :

| | | | |
|--|--|----------------|-----------------------|
| Product name: Pharmaceutical Refrigerator | Model: MPR-513, 513R MPR-1013, 1013R | Serial number: | Date of installation: |
|--|--|----------------|-----------------------|

Please decontaminate the unit yourself before calling the service engineer.

7FB6P101277006
(5 April 2005)

Recycled paper

SANYO

SANYO Electric Biomedical Co., Ltd.

10-15, Hongo 3-Chome
Bunkyo, Tokyo 113-8434 Japan

Printed in Japan

Free Manuals Download Website

<http://myh66.com>

<http://usermanuals.us>

<http://www.somanuals.com>

<http://www.4manuals.cc>

<http://www.manual-lib.com>

<http://www.404manual.com>

<http://www.luxmanual.com>

<http://aubethermostatmanual.com>

Golf course search by state

<http://golfingnear.com>

Email search by domain

<http://emailbydomain.com>

Auto manuals search

<http://auto.somanuals.com>

TV manuals search

<http://tv.somanuals.com>