



## INSTRUCTION MANUAL

# MPR-411F MPR-411FR

## Pharmaceutical Refrigerator with Freezer



**MPR-411FR**

## Note:

1. No part of this manual may be reproduced in any form without the expressed written permission of SANYO.
2. The contents of this manual are subject to change without notice.
3. Please contact SANYO if any point in this manual is unclear or if there are any inaccuracies.

SANYO Electric Biomedical Co., Ltd. All rights reserved. Printed in Japan.

## CONTENTS

|                                |       |
|--------------------------------|-------|
| PRECAUTIONS FOR SAFE OPERATION | P. 2  |
| CAUTIONS FOR USAGE             | P. 6  |
| ENVIRONMENTAL CONDITIONS       | P. 7  |
| NAME AND FUNCTION OF PARTS     | P. 8  |
| BEFORE COMMENCING OPERATION    | P. 10 |
| START-UP OF UNIT               | P. 11 |
| OPERATING INSTRUCTIONS         | P. 12 |
| TEMPERTURE RECORDER            | P. 16 |
| REMOTE ALARM TERMINAL          | P. 18 |
| MAINTENANCE                    | P. 18 |
| TROUBLE SHOOTING               | P. 19 |
| DISPOSAL OF UNIT               | P. 19 |
| SPECIFICATIONS                 | P. 20 |
| PERFORMANCE                    | P. 21 |
| SAFETY CHECK SHEET             | P. 22 |

# PRECAUTIONS FOR SAFE OPERATION

**It is imperative that the user complies with this manual as it contains important safety advice.**

Items and procedures are described so that you can use this unit correctly and safely. If the precautions advised are followed, this will prevent possible injury to the user and any other person.

Precautions are illustrated in the following way:

## **WARNING**

Failure to observe WARNING signs could result in a hazard to personnel possibly resulting in serious injury or death.

## **CAUTION**

Failure to observe CAUTION signs could result in injury to personnel and damage to the unit and associated property.

Symbol shows;

this symbol means caution.

 this symbol means an action is prohibited.

this symbol means an instruction must be followed.

Be sure to keep this manual in a place accessible to users of this unit.

















< Label on the unit >

This mark is labeled on the cover in which the electrical components of high voltage are enclosed to prevent the electric shock.

The cover should be removed by a qualified engineer or a service personnel only.









# PRECAUTIONS FOR SAFE OPERATION

## **WARNING**





-  **Do not use the unit outdoors.** Current leakage or electric shock may result if the unit is exposed to rain water.
-  **Only qualified engineers or service personnel should install the unit.** The installation by unqualified personnel may cause electric shock or fire.
-  **Be sure to install the unit on a sturdy floor.** If the floor is not strong enough or the installation site is not adequate, this may result in injury from the unit falling or tipping over.
-  **Never install the unit in a humid place or a place where it is likely to be splashed by water.** Deterioration of the insulation may result which could cause current leakage or electric shock.
-  **Install a leak breaker on the power supply side** when you use the unit in humid or wet situations, as well as installing an earth plate. Consult our shops or an electrician for these installations.
-  **Never install the unit in a flammable or volatile location.** This may cause explosion or fire.
-  **Never install the unit where acid or corrosive gases are present** as current leakage or electric shock may result due to corrosion.
-  **Make sure a dedicated power source is used** as indicated on the rating label attached to the unit.
-  **Make sure to remove dust from the power supply plug** before inserting in a power source. A dusty plug or improper insertion may pose a hazard.
-  **Use a power supply outlet with ground (earth)** to prevent electric shock. If the power supply outlet is not grounded, it will be necessary to install a ground by qualified engineers.
-  **Never ground the unit through a gas pipe, water main, telephone line or lightning rod.** Such grounding may cause electric shock in the case of an incomplete circuit.
-  **Do not insert metal objects such as a pin or a wire into any vent, gap or any outlet** for inner air circulation. This may cause electric shock or injury by accidental contact with moving parts.
-  **Never store volatile or flammable substances** in this unit. This may cause explosion or fire.
-  **Never store corrosive substances** in this unit. This may lead to damage to the inner components or electric parts.
-  **If this unit is to be used for storing poisons, radioactive material or other harmful products, ensure that it is in a safe area.** Failure to do so may lead to an adverse effect on the health of personnel in the area and the local environment. In this case, a request for repair or maintenance will necessitate a safety check sheet for maintenance personnel.

# PRECAUTIONS FOR SAFE OPERATION

## **WARNING**













-  **Always disconnect the power supply to the unit prior to any repair or maintenance** of the unit in order to prevent electric shock or injury.
-  **Ensure you do not inhale or consume medication or aerosols** from around the unit at the time of maintenance. These may be harmful to your health.
-  **Never splash water directly onto the unit** as this may cause electric shock or short circuit.
-  **Never disassemble, repair, or modify the unit yourself.** Any such work carried out by an unauthorized person may result in fire or injury due to a malfunction.
-  **Make the power supply to the unit is disconnected when the lamp is replaced** as this will prevent electric shock.
-  **Disconnect the power supply plug if there is something wrong with the unit.** Continued abnormal operation may cause electric shock or fire.
-  If the unit is to be stored unused in an unsupervised area for an extended period, **ensure that children do not have access and that doors cannot be closed completely.**
-  **The disposal of the unit should be accomplished by appropriate personnel. Always remove doors** to prevent accidents such as suffocation.
-  **Make sure to prepare a safety check sheet** when you request any repair or maintenance for the safety of service personnel.

## **CAUTION**

-  **Select a level and sturdy floor for installation.** This precaution will prevent the unit from tipping. Improper installation may result in water spillage or injury from the unit tipping over.
-  **Connect the unit to a power source as indicated on the rating label attached to the unit.** Use of any other voltage or frequency other than that on the rating label may cause fire or electric shock.
-  **Fix the shelves securely.** Incomplete installation may cause injury or damage.
-  **When removing the plug from the power supply outlet, grip the power supply plug,** not the cord. Pulling the cord may result in electric shock or fire by short circuit.

# PRECAUTIONS FOR SAFE OPERATION

## CAUTION

-  **Never damage or break the power supply plug or cord. Do not use the supply plug if its cord is loose.** This may cause fire or electric shock.
-  **Do not touch any electrical parts** such as the power supply plug or any switches with a wet hand. This may cause electric shock.
-  **Do not climb onto the unit or do not put articles on the unit.** This may cause injury by tipping or damage to the unit.
-  **Do not store bottle or cans in the freezer.** This may cause injury by broken of containers due to the frozen.
-  **Do not touch any stock (especially metal objects) in the freezer with a wet hand.** This may cause frostbite.
-  **Always hold the handle when closing the door.** This will reduce the likelihood of a trapped finger.
-  **Never lean or press on the glass.** Intentional force may cause injury if the glass breaks.
-  **Do not lean on the door.** This may cause injury if the unit tips over.
-  **Always disconnect the power supply plug** before moving the unit. Take care not to damage the power cord. A damaged cord may cause electric shock or fire.
-  **Dispose of water in the evaporation tray completely prior to the movement.** Spilled water or splashed water may cause current leakage or electric shock.
-  **Be careful not to tip over the unit** during movement to prevent damage or injury.
-  **Always disconnect the power plug** when the unit is not used for long periods.
-  **Do not put the packing plastic bag within reach of children** as suffocation may result

# CAUTIONS FOR USAGE

1. If the unit is unplugged or the power to the unit is interrupted, do not restart the unit for at least 5 minutes. This protects the compressor.
2. This inner cabinet is refrigerated by the forced circulation of cooled air inside the chamber. Ensure that the intake and exhaust vents are not blocked. Adequate space should be provided between the items inside the unit to allow air circulation.
3. Never store corrosive materials such as acid or alkali unless the container is completely sealed up. Corrosion may lead to failure of the unit in time.
4. If the ambient temperature is fairly high, the alarm lamp is flashed, the buzzer sounds, and the temperature display is flashed at the time of initial start up. The alarm is canceled automatically when the chamber temperature is decreased.
5. Once the chamber temperature has stabilized, put the items into the chamber in small batches to minimize the temperature increase.
6. Fix the shelves securely. Place items on the shelves and leave a space between the walls of the cabinet and the contents to allow air circulation. Do not place items on the floor of the chamber.
7. Always close the door firmly. The door check lamp is lit when the door is open. The alarm buzzer sounds two minutes after door opening. The buzzer can be canceled automatically when the door is closed.
8. Always open and close the door gently. Rough operation may lead fall down of stocked items, incomplete closing, or damage of door gasket.
9. The cooling pipe is routed in the rear of the freezer. Never use a knife or a screw driver, etc. to remove the frost. They may cause damage of chamber wall or improper operation of the unit.
10. Do not drop any heavy items or sharp edge materials onto the freezer floor.
11. Move the freezer switch to OFF position when the freezer is not used or at the time of defrosting of freezer. In the OFF condition, the freezer is not cooled down at all.
12. If an instrument requiring a power source is to be placed inside the cabinet, the cable can be lead through the access port on the left hand side of the cabinet. After installation, a rubber cap should be used to seal the access port. Failure to do this can affect the temperature uniformity inside the cabinet and lead to condensation on the outside of the access port.
13. Do not clean the unit with scrubbing brushes, acid, thinner, solvents powdered soap, cleanser or hot water. These agents can scratch the paint or cause it to peel. Plastic and rubber parts can be easily damaged by these materials, especially solvents. When a neutral detergent is used to clean the unit, wipe it up thoroughly with a cloth soaked in clean water.
14. If condensation forms on the front glass or frame surface, wipe it off with a dry soft cloth.

# CAUTIONS FOR USAGE

## Model with CE mark

This unit is equipped with a circuit breaker on the back. Make sure this breaker is switched ON before the unit starts to run.

When the operation of the unit is stopped by this breaker, contact with dealer or service station after disconnected the power supply plug.

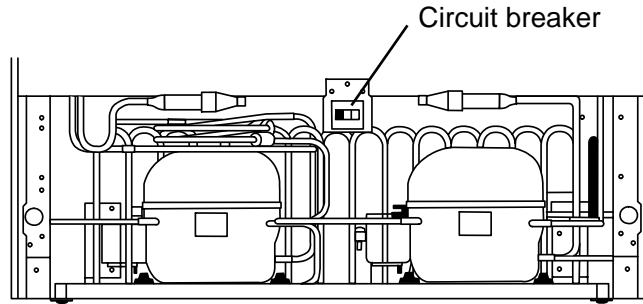

# ENVIRONMENTAL CONDITIONS

This equipment is designed to be safe at least under the following conditions (based on the IEC 1010-1):

1. Indoor use;
2. Altitude up to 2000 m;
3. Ambient temperature 5°C to 40°C
4. Maximum relative humidity 80% for temperature up to 31°C decreasing linearly to 50% relative humidity at 40°C;
5. Mains supply voltage fluctuations not to exceed  $\pm 10\%$  of the nominal voltage;
6. Other supply voltage fluctuations as stated by the manufacturer;
7. Transient overvoltages according to Installation Categories (Overvoltage Categories) II; For mains supply the minimum and normal category is II;
8. Pollution degree 2 in accordance with IEC 664.



# NAME AND FUNCTION OF PARTS

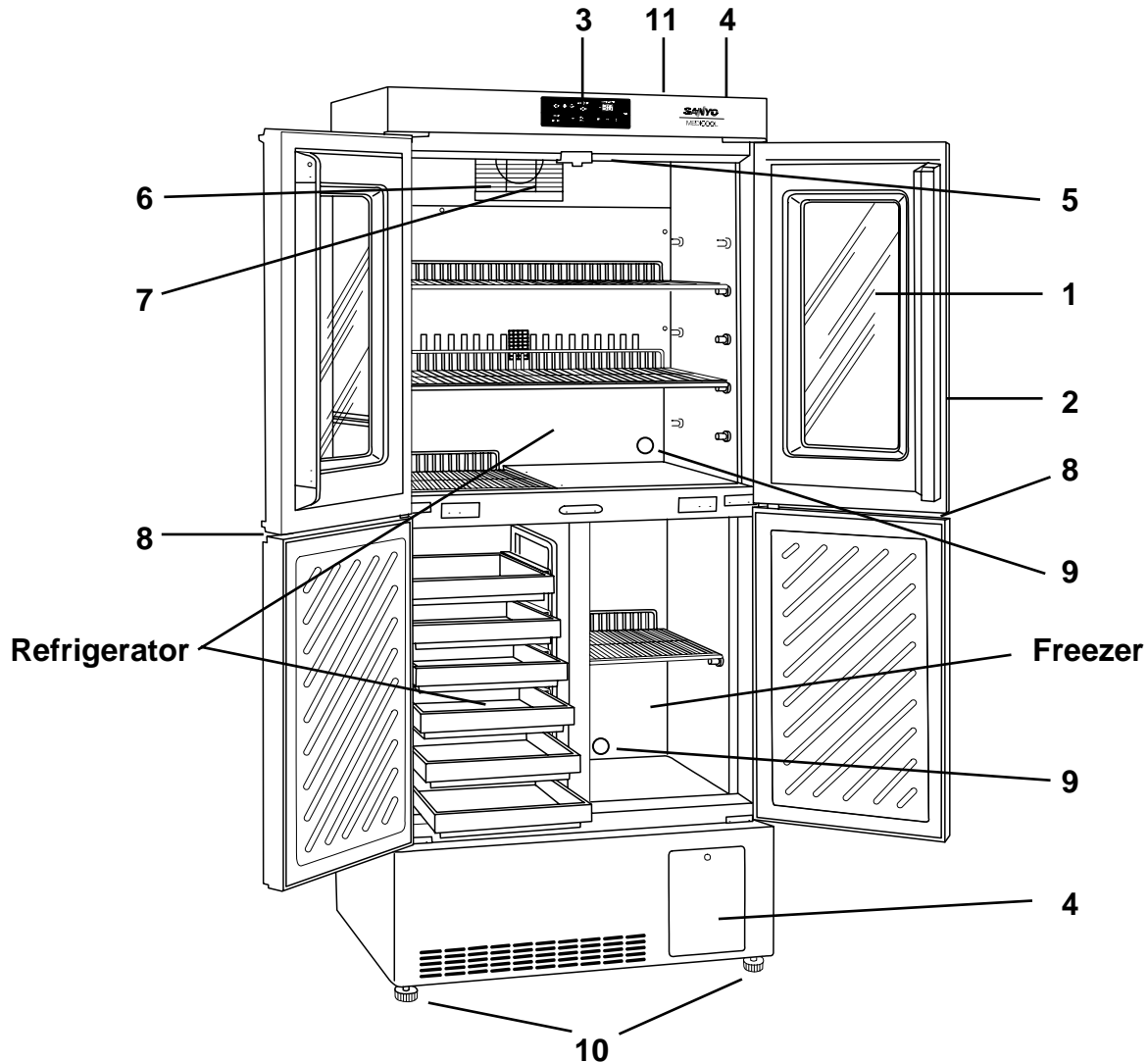

**1. Glass window:** Water can sometimes condense on the glass in areas of high humidity. Wipe off the condensation with a dry soft cloth.

**2. Magnetic door gasket:** Always keep clean.

**3. Control panel:** The panel is divided into two portion; Upper portion is an indicator and lower is a controller. Press upper right corner to open the lower cover. Temperature setting is available through this panel. Refer to page 9 for the details.

**4. Mounting space for temperature recorder:** Space for an automatic temperature recorder available separately. See page 17.

**5. Lamp:** This lamp lights up when the refrigerator door is open.

**6. Air intake vent:** Ensure this vent is never blocked. Failure to do so will result in unstable temperature distribution.

**7. Circulating fan:** Fan is installed inside the enclosure. Do not insert anything into the enclosure. The air exhaust vent is located at the upper of the fan.

**8. Lock:** Turn key clockwise through 180° to lock the door.

**9. Access port (rear):** This hole allows cables to be passed into the cabinet.

**10. Leveling feet:** Use this screw/bolt to adjust the height and level the unit.

**11. Remote alarm terminal (rear):** This terminal is used to alarm an abnormal status at a remote location. See page 18 for the details.

# NAME AND FUNCTION OF PARTS

## Control panel

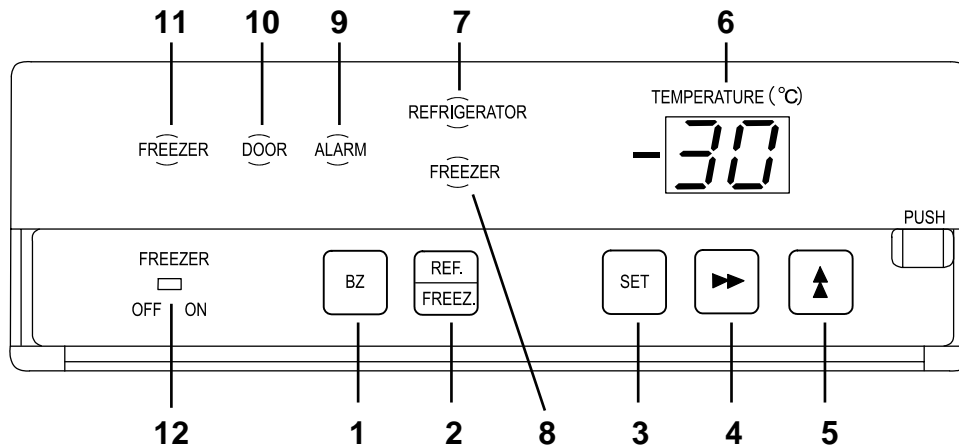

- 1. Alarm buzzer stop key (BZ):** Press this key to silence the buzzer in the event that the alarm operates and buzzer sounds.
- 2. Display select key (REF./FREEZ.):** By pressing this key, internal temperature display of refrigerator or freezer and each setting is selected.
- 3. Set key (SET):** Pressing this key activates temperature set mode. The digit which can be set is flashed. By pressing the key again after setting, the set value is accepted.
- 4. Digit shift key (▶▶):** Pressing this key in set mode causes the changeable digits to move. Key lock is activated by pressing this key for more than 5 seconds in the temperature display mode. See "Key lock operation" on page 13.
- 5. Numerical value shift key (▲):** Pressing this key in the setting mode causes the numerical value to change. "ON-OFF" of key lock can be selected by pressing this key in the key lock mode.
- 6. Temperature display:** This indicator shows the chamber temperature or set temperature.
- 7. Refrigerator indicator (REFRIGERATOR):** This indicator is lit when the refrigerator is selected.
- 8. Freezer indicator (FREEZER):** This indicator is lit when the freezer is selected.
- 9. Alarm lamp (ALARM):** This lamp is flashed during alarm condition.
- 10. Door check lamp (DOOR):** This lamp is lit when the door is open.
- 11. Freezer lamp (FREEZER):** This lamp is lit during freezer operation.
- 12. Freezer switch:** Turn this switch "OFF" when the freezer is to be defrosted or is not to be used.  
Note: When the freezer switch is OFF, the freezer chamber is not refrigerated at all.

# BEFORE COMMENCING OPERATION

## Installation site

To operate this unit properly and to obtain maximum performance, install the unit in a location with the following conditions:

### 1. A location not subjected to direct sunlight

Installation in a location subjected to direct sunlight may lead to inadequate cooling.

### 2. A location with adequate ventilation

Leave at least 10cm around the unit for ventilation. Poor ventilation will result in a reduction of the refrigeration capacity.

### 3. A location away from heat generating sources

Avoid installing the unit near heat-emitting appliances such as gas ranges or stoves. Heat can cause inefficient refrigeration.

### 4. A location with a sturdy and level floor

Install the unit on a sturdy floor to avoid vibration and noise. Placing the unit on an unsteady floor may cause vibration and noise.

#### **WARNING**

**Be sure to install the unit on a sturdy floor.** If the floor is not strong enough or the installation site is not adequate, this may result in injury from the unit falling or tipping over.

#### **CAUTION**

**Select a level and sturdy floor for installation.** This precaution will prevent the unit from tipping. Improper installation may result in water spillage or injury from the unit tipping over.

### 5. A location not prone to high humidity

#### **WARNING**

**Do not use the unit outdoors.** Current leakage or electric shock may result if the unit is exposed to rain water.

**Never install the unit in a humid place or a place where it is likely to be splashed by water.** Deterioration of the insulation may result which could cause current leakage or electric shock.

**Do not install the unit under water pipes or steam pipes.** Deterioration of the insulation may result which could cause current leakage or electric shock.

### 6. A location without a flammable or corrosive gas

Avoid placing the unit where chemicals are stored or gases are produced. Also avoid areas where there is a great deal of dust.

#### **WARNING**

**Never install the unit in a flammable or volatile location.** This may cause explosion or fire.

**Never install the unit where acid or corrosive gases are present** as current leakage or electric shock may result due to corrosion.

### 7. A location not subjected to strong electromagnetic interference

# BEFORE COMMENCING OPERATION

## Installation

### 1. Remove the packaging materials and tapes

Remove all transportation packaging materials and tapes. Open the doors and ventilate the unit. If the outside panels are dirty, clean them with a neutral detergent and wipe it up with a wet cloth.

### 2. Adjust the leveling foot

Extend the leveling feet by rotating them counterclockwise to contact them to the floor. Ensure the unit is level.

### 3. Fix the unit

Two fixtures are attached to the rear of the frame. Fix the frame to the wall with these fixtures and rope or chain.

### 4. Ground (earth)

#### **⚠️ WARNING**

**Use a power supply outlet with ground (earth) to prevent electric shock.** If the power supply outlet is not grounded, it is necessary to install a ground by qualified engineers.

**Never ground the unit through a gas pipe, water main, telephone line or lightning rod.** Such grounding may cause electric shock in the case of an incomplete circuit.

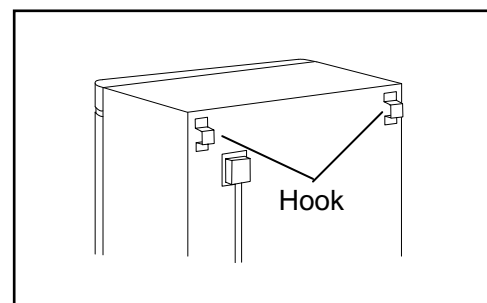
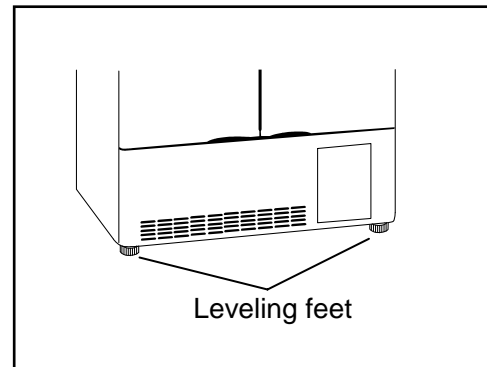

## START-UP OF UNIT

The following procedures should be adhered to for initial start-up and continuous operation.

1. Connect unit to dedicated power supply. Do not put any product in the unit at this time.
2. On start-up, the alarm buzzer sometimes operates. In this case, stop the buzzer by pressing the alarm buzzer stop key (BZ).
3. Set the desired temperature.
4. Confirm that the chamber temperature is at the desired temperature.
5. When you are satisfied that the unit is working correctly, begin slowly placing product into the chamber to minimize the temperature rise.

# OPERATING INSTRUCTIONS

















## Control panel

### 1. Setup of chamber temperature

Table 1 shows the basic operation method. Perform key operation in the sequence indicated in the table. The example in the table is based on the assumption that the refrigerator temperature is 4°C and the freezer temperature is -25°C.

**Note:** The unit is set at the factory so that the refrigerator temperature is 5°C and the freezer temperature is -20°C.

Table 1 Basic operation procedure (Example of setting: refrigerator; 4°C, freezer; -25°C)

|   | Operation   | Key operated  | Indication after operation   | Display mode                        |
|---|---|---|--|-------------------------------------|
| 1 | Connect the power supply plug to the power outlet                                     | -----   | The current refrigerator or freezer temperature is displayed.                             | Refrigerator temperature            |
| 2 | By pressing the display select key, select the refrigerator                           |    | The refrigerator indicator lights and the current refrigerator temperature is displayed.  |                                     |
| 3 | Press the set key   |    | The second digit of the temperature display flashes.                                      | Refrigerator temperature setup mode |
| 4 | Set the temperature to 04 with the digit shift key and the numerical value shift key  |  | Pressing the key shifts the digit which can be set.                                     |                                     |
|   |   |  | Pressing the key shifts up the figure of the current digit.  |                                     |
| 5 | Press the set key   |  | The value is stored in memory and the current refrigerator temperature is displayed.   |                                     |
| 6 | By pressing the display select key, select the freezer                                |  | The freezer indicator lights and the current freezer temperature is displayed.          |                                     |
| 7 | Press the set key   |  | The second digit of the temperature display flashes.                                    | Freezer temperature setup mode      |
| 8 | Set the temperature to -25 with the digit shift key and the numerical value shift key |  | Pressing the key shifts the digit which can be set.  |                                     |
|   |   |  | Pressing the key shifts up the figure of the current digit.                             |                                     |
| 9 | Press the set key   |  | The value is stored in memory and the current freezer temperature is displayed.  |                                     |

Note:

If no key has been pressed for about 90 seconds in the temperature setup mode, the display mode returns automatically to the current chamber display mode. In this case, the chamber temperature setting is not changed.

The freezer temperature can be set in the range between -10 and -35 . Remember that the guaranteed temperature with no load at an ambient temperature of 30 is -30 .

# OPERATING INSTRUCTIONS

## 2. Key lock operation

This unit incorporates a key lock feature which can inhibit the tampering using the keys on the control panel.

The key lock is set to OFF at the factory.







| Display   | Mode         | Function                    |
|---|--------------|-----------------------------|
|  | Key lock OFF | Temperature change enabled  |
|  | Key lock ON  | Temperature change disabled |

Table 2 Key lock setup procedure (Example: Key lock OFF      Key lock ON)

|   | Operation   | Key operated  | Indication after operation  | Display mode             |
|---|---|---|---|--------------------------|
|   |   | -----   | The current refrigerator or freezer temperature is displayed.  | Temperature display mode |
| 1 | Press and hold the digit shift key for about 5 seconds      |  | The lower digit of the temperature display blinks.  | Key lock mode            |
| 2 | Set the lower digit to "1" with the numeric value shift key |  | Pressing the key shifts up the figure of the digit.            |                          |
| 3 | Press the set key   |  | Key lock is set to ON and the current refrigerator or freezer temperature is displayed.   | Temperature display mode |

### Note:

Key lock can be set any time when the current refrigerator or freezer temperature is displayed.

If the numerical value shift key is held depressed for more than about 5 seconds, F0 is displayed. This is one of the functions used by the service personnel and the figure should not be changed. To return to the refrigerator or freezer temperature display mode, press the set key or leave the unit for about 90 seconds without pressing any key.

# OPERATING INSTRUCTIONS

## Alarm and safety functions

This unit has the alarm and safety functions shown in Table 3, and also a self diagnostic function.

| Kind of alarm or safety    | Situation   | Indication  | Buzzer   | Safety operation   |
|----------------------------|---|---|--|--|
| High temperature alarm     | <ul style="list-style-type: none"> <li>• Refrigerator</li> </ul> If the chamber temperature deviates from the set temperature +5°C or more. | Alarm lamp flashes.<br>All digits on the temperature display flash.                                     | Intermittent tone after a delay of 15 minutes. | Remote alarm is activated after a delay of 15 minutes.         |
|                            | <ul style="list-style-type: none"> <li>• Freezer</li> </ul> If the chamber temperature deviates from the set temperature +10°C or more.     |   |  |  |
| Low temperature alarm      | <ul style="list-style-type: none"> <li>• Refrigerator</li> </ul> If the chamber temperature drops to 0°C or lower.                          |   | Intermittent tone                              | Remote alarm is activated.                                     |
|                            | <ul style="list-style-type: none"> <li>• Freezer</li> </ul> If the chamber temperature deviates from the set temperature -10°C or lower.    |   | Intermittent tone after a delay of 15 minutes. | Remote alarm is activated after a delay of 15 minutes.         |
| Power failure alarm        | In the event of a power failure or disconnection of power supply plug from the outlet   | -----   | -----  | Remote alarm is activated.                                     |
| Door alarm                 | When the door is opened   | Door check lamp is lit.   | Intermittent tone after a delay of 2 minutes.  | -----  |
| Auto return                | If a key operation is not performed for about 90 seconds in each setting mode.  | Chamber temperature is displayed.   | -----  | Setting mode is canceled.                                      |
| Key lock                   | When the key lock is ON (L1).   | -----   | -----  | Key input is disabled.   |
| Thermal sensor abnormality | If the thermal sensor of refrigerator goes open or short circuit.   | Alarm lamp flashes.<br>E1 and chamber temperature are displayed alternately on the temperature display. | Intermittent tone                              | Remote alarm is activated.<br>Operation by the defrost sensor. |
|                            | If the freezer sensor of refrigerator goes open or short circuit.   | Alarm lamp flashes.<br>E2 and chamber temperature are displayed alternately on the temperature display. |  | Remote alarm is activated.<br>Freezer will run continuously .  |
|                            | If the defrost sensor goes open or short circuit.   | Alarm lamp flashes.<br>E3 and chamber temperature are displayed alternately on the temperature display. |  | Remote alarm is activated.<br>Continuous running.              |
| Over-heat protector        | <ul style="list-style-type: none"> <li>• Refrigerator</li> </ul> If the chamber temperature is higher than 28°C.                            | -----   | -----  | Heater and fan motor OFF.                                      |

Note: The remote alarm can be canceled by pressing the alarm buzzer stop key (BZ) as it is activated in conjunction with the buzzer (except power failure alarm).

When more than two alarm condition occur simultaneously, the lowest number error code has priority on the error display.

After a power failure, the unit will resume operation with the set value that was in place before power failure occurred.

# OPERATING INSTRUCTIONS

## Defrost cycles

### Refrigerator

There is no need for routine defrosting of the unit as this occurs automatically as follows:

#### 1. Cycle defrost

To keep the temperature stable inside the chamber, the refrigeration compressor is cycled on and off. During "off" periods any frost which has accumulated on the refrigeration coils is melted by energizing a small heater. This will not have any discernible effect on the chamber temperature.

#### 2. Forced defrost

When the set temperature is low, ambient humidity is high, or a large amount of damp product is being stored inside the refrigerator, there is a possibility that cycle defrost may not be enough to remove all of the frost on the refrigeration coils. In this case, a forced defrost cycle can be initiated.

When the unit is operating under a forced defrost cycle, the current chamber temperature and "dF" is displayed alternately on the digital temperature display.

Once the forced defrost cycle is complete, normal operation resumes. The chamber temperature rises to about 10°C during the forced defrost cycle.

### Freezer

When the frost is built-up on the freezer wall, defrost the freezer by the following procedure as the freezer has no automatic defrosting function.

1. Temporarily move all the contents of the freezer to another freezer.

2. Turn the freezer switch to "OFF".

3. When the frost on the wall has been eliminated, remove the water and wipe the inside of the freezer completely.

4. Turn the freezer switch to "ON".

5. Once the chamber temperature has resumed normal set-point temperature, place the original contents back in the freezer.

**Note:** The freezer does not automatically reset to normal operation.



# TEMPERATURE RECORDER

## Automatic temperature recorder

To record the chamber temperature, an optional automatic temperature recorder is available. Please consult with our sales department or agency for recorder installation.

For the proper usage of temperature recorder, refer to an instruction manual included with the recorder.

The available recorder and a dedicated fixture is as follows:

Temperature recorder: Model MTR-0620LH (for refrigerator)  
Model MTR-4014LH (for freezer)

Fixture: MDF-53RO (H)

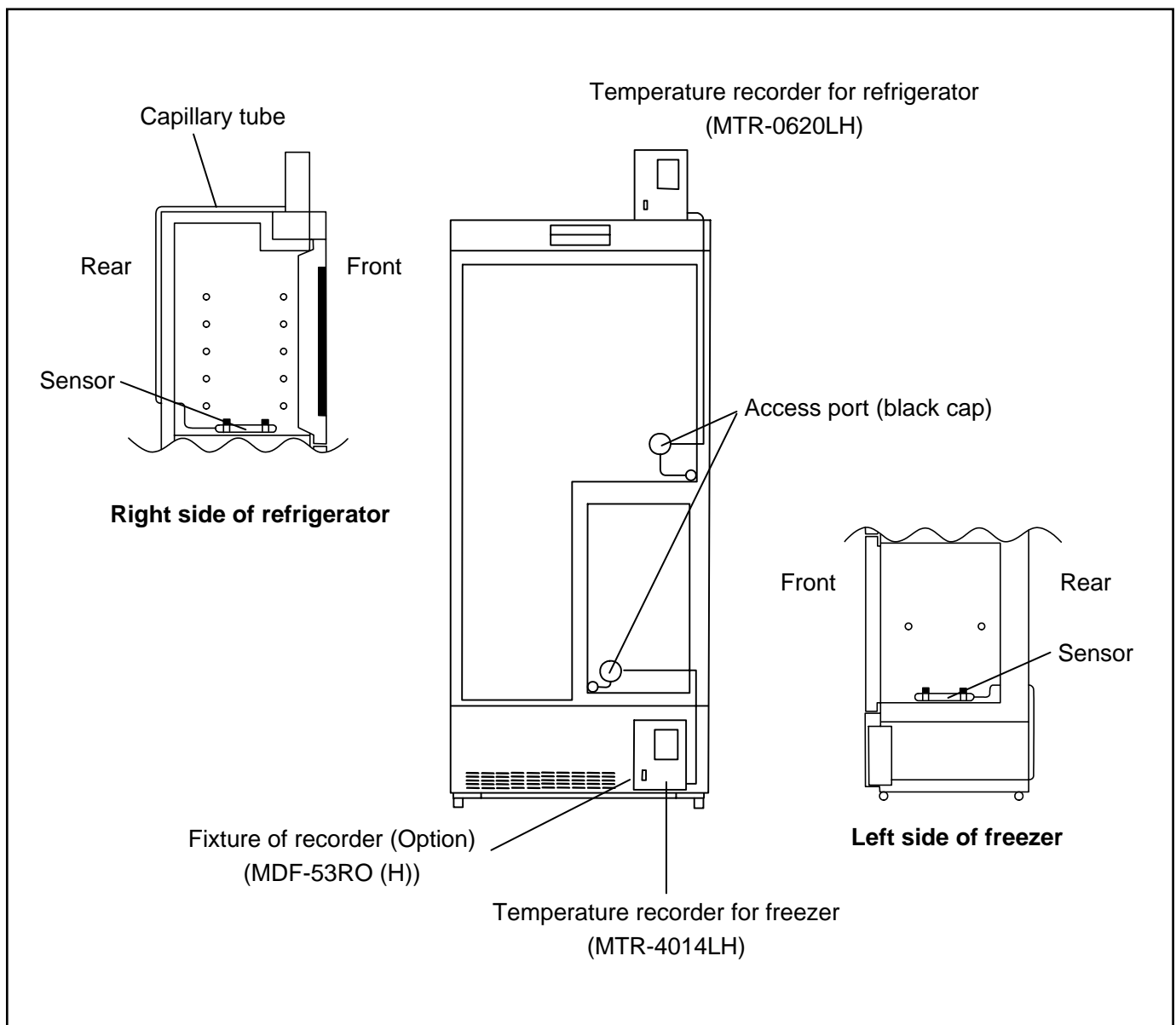

# TEMPERATURE RECORDER

## Attachment of temperature recorder

### For refrigerator

1. Attach the fixture to the temperature recorder with two screws. (Fig. 1)
2. Remove the screws at the right corner on the top of the unit and fix the recorder to the position. (Fig. 2)
3. Remove a rubber cap and insulation covering the access hole on the back of the unit.
4. Take the recorder sensor into the refrigerator chamber through the access hole.
5. Fix the recorder sensor on the right wall of the chamber with the enclosed clips (large). (Fig. 3)
6. Make a cut on the rubber cap and route the lead wire through it. (Fig. 4)
7. Cover the access port with the insulation and rubber cap.

### For freezer

1. Remove a cap for the fixing screw on the cover for mounting space of temperature recorder.
2. Remove the fixing screw and open the panel. (Fig. 5)
3. Remove the panel by pushing the shaft on both side outward and remove the panel fixture.
4. Attach the temperature recorder (MTR-4014LH) to the recorder fixture [MDF-53RO (H)] by using the enclosed screws. (Fig. 6)
5. Remove a rubber cap and insulation covering the access port on the back of the unit.
6. Take out the recorder sensor from the back of the unit through the mounting space.
7. Pass the sensor through the access port of the freezer. The length of the capillary inside the freezer should be about 40 cm.
8. Fix the recorder sensor on the left wall of the chamber with the enclosed clips (small). (Fig. 7)
9. Make a cut on the rubber cap and route the lead wire through it. (Fig. 4 above)
10. Cover the access port with the insulation and rubber cap.
11. Fix the extra capillary tube to the back of the recorder with the enclosed clip and screw. (Fig. 8)
12. Mount the recorder fixture to the mounting space in the unit. (Fig. 9)

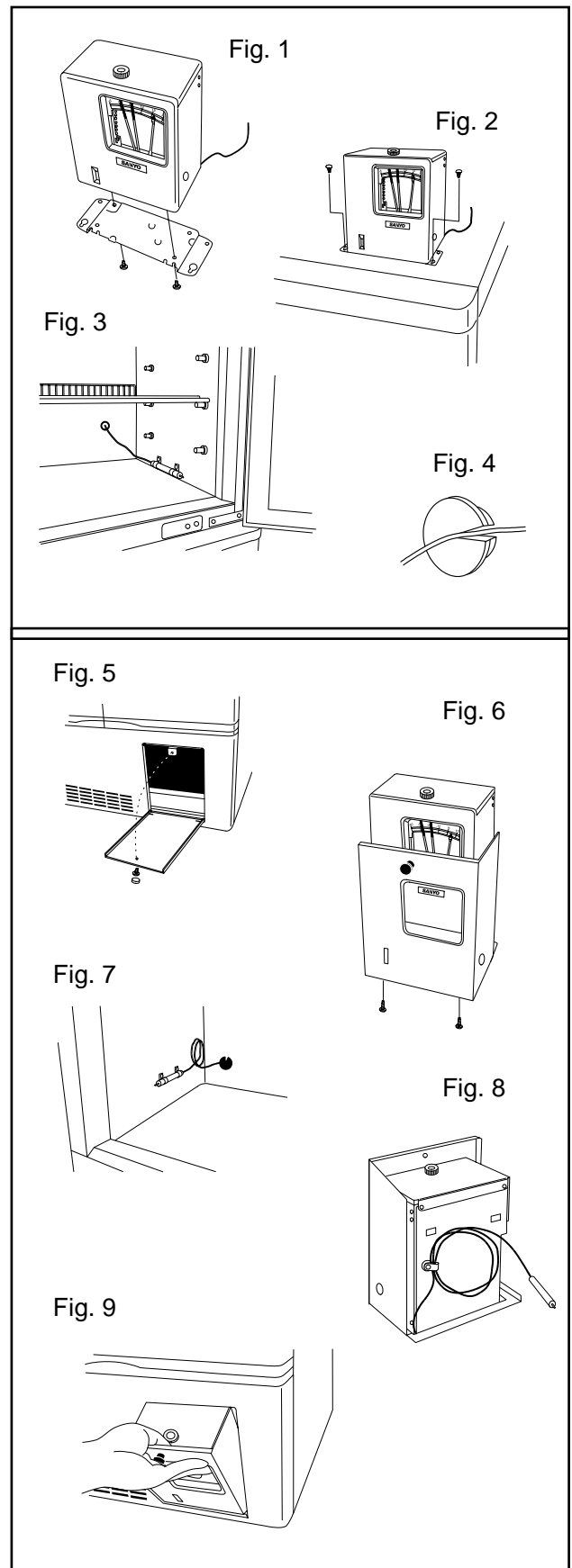

# REMOTE ALARM TERMINAL

## **⚠️ WARNING**

**Always disconnect the power supply to the unit** before connection of alarm equipment to remote alarm terminals to prevent electric shock or injury.

The terminal of the remote alarm is installed in the terminal cover at rear of the cabinet. The maximum contact rating is DC 30 V, 2 A.

Output: normal "open"  
abnormal "close"

Note:

The alarm is silenced by the alarm buzzer stop key (BZ) since the remote alarm is operated in conjunction with alarm buzzer. The alarm is activated when the power supply plug is disconnected. In this case, the alarm buzzer cannot be canceled with the alarm buzzer stop key (BZ).

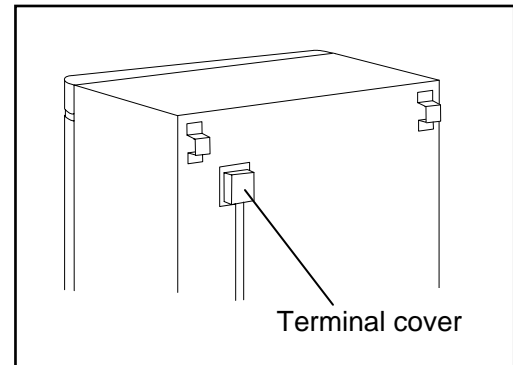

## Connection of remote alarm terminal

1. Remove the terminal cover at rear of the cabinet.
2. Connect the lead wire of alarm equipment to the terminal.
3. Replace the terminal cover.

# MAINTENANCE

## **⚠️ WARNING**

**Always disconnect the power supply to the unit prior to any repair or maintenance** of the unit in order to prevent electric shock or injury.

**Ensure you do not inhale or consume medication or aerosols** from around the unit at the time of maintenance. These may be harmful to your health.

## Cleaning

1. Clean the unit once a month. Regular cleaning keeps the unit looking new.
2. Use a dry cloth to wipe off small amounts of dirt on the outside and inside of the unit and all accessories. If the unit is very dirty, use a neutral detergent.
3. After cleaning, wipe away the cleaner completely with a cloth washed in clean water.
4. Never pour water onto or into the unit. Doing so can damage the electrical insulation and may cause electric shock or short circuit.
5. The compressor and other mechanical part are completely sealed. This unit requires absolutely no lubrication.

# TROUBLE SHOOTING

If the unit malfunctions, check out the following before calling for service.

## **If nothing operates even when plug in**

1. The unit is not connected to the power supply or capacity of power source enough.
2. There is a power failure.
3. The fuse is blown or the circuit breaker is activated.

## **When the unit does not accept changes of set-point temperature**

1. The key lock is "OFF"?

## **When alarm is activated**

On start-up

1. The temperature in the unit does not match set value.

In use

1. The door was kept opened for long time.
2. The set value was changed.
3. The containers of high temperature (load) were put in the unit.

In these cases, alarm is removed automatically by running the unit for several hours.

## **When the unit does not get cold enough**

1. The air exhaust vent is blocked by refrigerator contents.
2. A large amount of warm product was put in the unit.
3. There is any heat sources in the unit.
4. The door is opened frequently.
5. The ambient temperature is too high.
6. The unit is in direct sunlight.
7. The door is not securely closed.
8. The door seal is damaged or foreign substance inserted between the door gaskets.

# DISPOSAL OF UNIT

## **⚠ WARNING**

If the unit is to be stored unused in an unsupervised area for an extended period **ensure that children do not have access and doors cannot be closed completely.**

**The disposal of the unit should be accomplished by appropriate personnel. Always remove doors to prevent accidents such as suffocation.**

# SPECIFICATIONS

|                        |   |   |
|------------------------|---|---|
| Name                   | Pharmaceutical Refrigerator with Freezer  |   |
| Model                  | MPR-411F/MPR-411FR  |   |
|                        | Refrigerator  | Freezer   |
| External dimensions    | W800 x D600 x H1805 (mm)  |   |
| Internal dimensions    | W720 x D495x H1425 (mm)   | W317 x D440x H576 (mm)                                |
| Effective capacity     | 340 L   | 82 L  |
| Exterior               | Acrylic finish baked on zinc galvanized steel   |   |
| Interior               | Acrylic finish baked on zinc galvanized steel   | Painted aluminum plate                                |
| Door                   | Acrylic finish baked on zinc galvanized steel   |   |
| Shelf                  | Polyethylene coated wire<br>Maximum load; 25 kg/shelf (large size)<br>Maximum load; 15 kg/shelf (small size)  | Polyethylene coated wire<br>Maximum load; 15 kg/shelf |
| Rack                   | Stainless rack (MPR-411FR only)<br>Maximum load; 15 kg/rack   | -----   |
| Access hole            | Inner diameter 30 mm, Back side   | Inner diameter 30 mm, Back side                       |
| Insulation             | Rigid polyurethane foamed-in place (CFC-FREE)   |   |
| Cooling method         | Forced air circulation  | Direct cooling  |
| Compressor             | Hermetic reciprocating type, Output; 160 W  | Hermetic reciprocating type, Output; 160 W            |
| Condenser              | Wire tube   | Rear side condenser                                   |
| Evaporator             | Fin tube type   | Tube on sheet type                                    |
| Refrigerant            | R-412A (TP5R)   |   |
| Defrosting             | Cycle defrost and forced defrost<br>Fully automatic   | Natural defrost by switch OFF                         |
| Temperature controller | Microprocessor control system   |   |
| Temperature display    | Digital display   |   |
| Sensor                 | Thermister sensor   |   |
| Heater                 | 99 W  | -----   |
| Alarm & Safety         | High temp. alarm, Over-heat protector, Low temp. alarm, Power failure alarm,<br>Door alarm, Auto-return, Key lock, Thermal sensor abnormality                                     |   |
| Remote alarm contact   | Contact capacity: DC 30 V, 2 A  |   |
| Lighting               | Incandescent lamp (T22E17)<br>125V, 10W (AC 110 to 115V)<br>250V, 15W (AC 220 to 240V)  | -----   |
| Accessories            | Key 1set, Nylon clip; large 2 pcs., small 2 pcs.  |   |
| Weight                 | MPR-411F; 124 Kg, MPR-411FR; 135 Kg   |   |
| Option                 | Automatic temperature recorder (for refrigerator MTR-0620LH, for freezer MTR-4014LH)<br>Mounting kit for temperature recorder [MDF-53RO(H)]<br>Rack [MPR-41R] (for MPR-411F only) |   |

**Note :** Design or specifications will be subject to change without notice.

# PERFORMANCE

|                   | Refrigerator   |          |          | Freezer   |          |          |
|-------------------|--|----------|----------|---|----------|----------|
| Control range     | 2°C to 14°C<br>(Ambient temp.; -5°C to +35°C, No load) |          |          | -10°C to -30°C<br>(Ambient temp.; -5°C to +35°C, No load) |          |          |
| Noise level       | 39 dB (A scale)  |          |          |   |          |          |
| Maximum pressure  | 1705 kPa   |          |          | 1901 kPa  |          |          |
| Rated voltage     | AC 110 V   | AC 115 V | AC 220 V | AC 220 V  | AC 230 V | AC 240 V |
| Rated frequency   | 60 Hz  | 60 Hz    | 50 Hz    | 60 Hz   | 50 Hz    | 50 Hz    |
| Power consumption | 370 W  | 370 W    | 350 W    | 370 W   | 350 W    | 350 W    |

**Note** : The unit with CE mark complies with EC directives 89/336/EEC, 93/68/EEC and 73/23/EEC.

**⚠ CAUTION**

**Please fill in this form before servicing.  
Hand over this form to the service engineer to keep for his and your safety.**

## Safety check sheet

- |                                |     |    |
|--------------------------------|-----|----|
| 1. Refrigerator contents :     | Yes | No |
| Risk of infection:             | Yes | No |
| Risk of toxicity:              | Yes | No |
| Risk from radioactive sources: | Yes | No |

(List all potentially hazardous materials that have been stored in this unit.)

Notes :

### 2. Contamination of the unit

- |                  |     |    |
|------------------|-----|----|
| Unit interior    | Yes | No |
| No contamination | Yes | No |
| Decontaminated   | Yes | No |
| Contaminated     | Yes | No |
| Others:          |     |    |

### 3. Instructions for safe repair/maintenance of the unit

- |                                     |     |    |
|-------------------------------------|-----|----|
| a) The unit is safe to work on      | Yes | No |
| b) There is some danger (see below) | Yes | No |

Procedure to be adhered to in order to reduce safety risk indicated in b) below.

Date :

Signature :

Address, Division :

Telephone :

|                           |           |                 |                        |
|---------------------------|-----------|-----------------|------------------------|
| Product name :            | Model :   | Serial number : | Date of Installation : |
| Pharmaceutical            | MPR-411F  |                 |                        |
| Refrigerator with Freezer | MPR-411FR |                 |                        |

Please decontaminate the unit yourself before calling the service engineer.



---

**SANYO Electric Biomedical Co., Ltd.**

5-5, Keihan-Hondori 2-Chome  
Moriguchi City, Osaka 570-8677 Japan

Printed in Japan

7FB6P101242002

Recycled paper



## Free Manuals Download Website

<http://myh66.com>

<http://usermanuals.us>

<http://www.somanuals.com>

<http://www.4manuals.cc>

<http://www.manual-lib.com>

<http://www.404manual.com>

<http://www.luxmanual.com>

<http://aubethermostatmanual.com>

Golf course search by state

<http://golfingnear.com>

Email search by domain

<http://emailbydomain.com>

Auto manuals search

<http://auto.somanuals.com>

TV manuals search

<http://tv.somanuals.com>