



Operating Instructions
Facsimile Reference
<Basic Features>
<Advanced Features>



Part #G1619



Read this manual carefully before you use this product and keep it handy for future reference.

For safety, please follow the instructions in this manual.

Introduction

This manual contains detailed instructions on the operation and maintenance of this machine. To get maximum versatility from this machine all operators should carefully read and follow the instructions in this manual. Please keep this manual in a handy place near the machine.

Please read the Safety Information in the Copy Reference manual before using this machine. It contains important information related to USER SAFETY and PREVENTING EQUIPMENT PROBLEMS.

Notes:

Some illustrations might be slightly different from your machine.

Certain options might not be available in some countries. For details, please contact your local dealer.

Two kinds of size notation are employed in this manual. With this machine refer to the inch version.

Machine Types

The model names of the machines do not appear in the following pages. Check the type of your machine before reading this manual. (For details, see p.1 "Machine Types".)

Important

Parts of this manual are subject to change without prior notice. In no event will the company be liable for direct, indirect, special, incidental, or consequential damages as a result of handling or operating the machine.

NOTICE

⚠ CAUTION:

Use of controls, adjustments or performance of procedures other than those specified herein may result in hazardous radiation exposure.

Shielded interconnect cables must be employed with this equipment to ensure compliance with the pertinent RF emission limits governing this device.

Direct (or indirect reflected) eye contact with the laser beam may cause serious eye damage. Safety precautions and interlock mechanisms have been designed to prevent any possible laser beam exposure to the operator.

Note to users in the United States of America



 **Notice:**

This equipment has been tested and found to comply with the limits for a Class B digital device, pursuant to Part 15 of the FCC Rules. These limits are designed to provide reasonable protection against harmful interference in a residential installation. This equipment generates, uses and can radiate radio frequency energy and, if not installed and used in accordance with the instructions, may cause harmful interference to radio communications. However, there is no guarantee that interference will not occur in a particular installation. If this equipment does cause harmful interference to radio or television reception, which can be determined by turning the equipment off and on, the user is encouraged to try to correct the interference by one more of the following measures:

- Reorient or relocate the receiving antenna.
 - Increase the separation between the equipment and receiver.
 - Connect the equipment into an outlet on a circuit different from that to which the receiver is connected.
 - Consult the dealer or an experienced radio /TV technician for help.
- 

 **Warning**

Changes or modifications not expressly approved by the party responsible for compliance could void the user's authority to operate the equipment.



Note to users in Canada

 **Note:**

This Class B digital apparatus complies with Canadian ICES-003.



Remarque concernant les utilisateurs au Canada

 **Avertissement:**

Cet appareil numérique de la classe B est conforme à la norme NMB-003 du Canada.

 **Notice about the Telephone Consumer Protection Act (Valid in USA only).**

The Telephone Consumer Protection Act of 1991 among other things makes it unlawful for any person to send any message via a telephone fax machine unless such message clearly contains in a margin at the top or bottom of each transmitted page or on the first page of the transmission, the date and time it is sent and an identification of the business, other entity, or other individual sending the message and the telephone number of the sending machine or such business, other entity or individual. This information is transmitted with your document by the TTI (Transmit Terminal Identification) feature. In order for you to meet the requirement, your machine must be programmed by following the instructions in the accompanying Operation Manual. In particular, please refer to the chapter of Installation. Also refer to the TTI (Transmit Terminal Identification) programming procedure to enter the business identification and telephone number of the terminal or business. Do not forget to set the date and time.

Thank you.

For this machine, TTI is called FAX HEADER.



Important Safety Instructions

Caution

When using your telephone equipment, basic safety precautions should always be followed to reduce the risk of fire, electric shock and injury to persons, including the following:

- Do not use this product near water, for example, near a bath tub, wash bowl, kitchen sink or laundry tub, in a wet basement or near a swimming pool.
- Avoid using a telephone during an electrical storm. There may be a remote risk of electric shock from lightning.
- Do not use a telephone in the vicinity of a gas leak to report the leak.
- Use only the power cord and batteries indicated in this manual. Do not dispose of batteries in a fire. They may explode. Check with local codes for possible special disposal instructions.

Save these instructions.

Certaines mesures de sécurité doivent être prises pendant l'utilisation de matériel téléphonique afin de réduire les risques d'incendie, de choc électrique et de blessures. En voici quelquesunes:

- Ne pas utiliser l'appareil près de l'eau, p.ex., près d'une baignoire, d'un lavabo, d'un évier de cuisine, d'un bac à laver, dans un sous-sol humide ou près d'une piscine.
- Éviter d'utiliser le téléphone (sauf s'il s'agit d'un appareil sans fil) pendant un orage électrique. Ceci peut présenter un risque de choc électrique causé par la foudre.
- Ne pas utiliser l'appareil téléphonique pour signaler une fuite de gaz s'il est situé près de la fuite.
- Utiliser seulement le cordon d'alimentation et le type de piles indiqués dans ce manuel. Ne pas jeter les piles dans le feu: elles peuvent exploser. Se conformer aux règlements pertinents quant à l'élimination des piles.

Conserver ces instructions.

How to Read this Manual

Symbols

In this manual, the following symbols are used:

WARNING:

This symbol indicates a potentially hazardous situation that might result in death or serious injury when you misuse the machine without following the instructions under this symbol. Be sure to read the instructions, all of which are described in the Safety Information section in the Copy Reference manual.

CAUTION:

This symbol indicates a potentially hazardous situation that might result in minor or moderate injury or property damage that does not involve personal injury when you misuse the machine without following the instructions under this symbol. Be sure to read the instructions, all of which are described in the Safety Information section in the Copy Reference manual.

* The statements above are notes for your safety.

Important

If this instruction is not followed, paper might be misfed, originals might be damaged, or data might be lost. Be sure to read this.

Preparation

This symbol indicates the prior knowledge or preparations required before operating.

Note

This symbol indicates precautions for operation, or actions to take after misoperation.

Limitation

This symbol indicates numerical limits, functions that cannot be used together, or conditions in which a particular function cannot be used.

Reference

This symbol indicates a reference.

[]

Keys built into the machine's operation panel.

Manuals for This Machine

Two Facsimile Reference manuals are provided, the Basic Features manual and the Advanced Features manual. Please refer to the manual that suits your needs.

Basic Features (this manual)

The Basic Features manual explains the most frequently used fax functions and operations.

Advanced Features

The Advanced Features manual describes more advanced functions, and also explains settings for key operators.

❖ **Chapter 1 Transmission Options**

Explains about sending at a specific time without having to be by the machine and also taking advantage of off-peak telephone line charges.

❖ **Chapter 2 Job Information**

Explains about erasing a fax message stored in memory and checking the contents of any files in memory.

❖ **Chapter 3 Other Transmission Features**

Explains about useful features for transmission. You can find out about dialing numbers easily.

❖ **Chapter 4 Reception Features**

Explains about reception features. You can find out about screening out message from anonymous senders.

❖ **Chapter 5 Facsimile User Tools**

Explains about programming frequently used functions for User Function Key and setting the Date and Time.

❖ **Chapter 6 Key Operator Settings**

Explains about functions the key operator handles. You can find out how to change the user parameter settings.

❖ **Chapter 7 Troubleshooting**

Explains about things you should do when an Error Report is printed and power is turned off.

❖ **Chapter 8 Appendix**

You can check the specifications for this machine.

TABLE OF CONTENTS

1. Getting Started

Machine Types	1
Guide to Components	2
Front View	2
Side View	3
Control Panel	4
Starting the Machine	6
Turning On the Power	6
Turning Off the Power	7
Changing Modes	8
Reading the Display	9
Reading the Display and Using Keys	9
Standby Display	10
Communication Display	10
Display Prompts	10

2. Faxing

Transmission Modes	11
Switching between Memory Transmission and Immediate Transmission....	12
Setting Originals	13
Placing a Single Original on the Exposure Glass.....	14
Loading Originals in the Document Feeder.....	14
Original Sizes Difficult to Detect.....	15
Memory Transmission	16
Canceling a Memory Transmission	19
Before the Start Key is Pressed	19
While the Original is Being Scanned.....	19
During Transmission	19
While the Original is Awaiting Transmission	20
Immediate Transmission	21
Canceling an Immediate Transmission	23
Before the Start key is Pressed.....	23
After the Start key is Pressed.....	23
Scan Settings	24
Resolution	24
Original Type.....	25
Image Density (Contrast)	25
Dialing	26
Entering Numbers Directly	26
Using Quick Dials.....	27
Using Speed Dials.....	28
Using Groups	29

Reception Modes	31
Selecting the Reception Mode	31

3. Registering

Own Name/Fax Header/Own Fax Number	33
Registering	34
Editing	35
Deleting	36
Quick Dial	38
Registering	38
Editing	40
Deleting	41
Quick Dial Key Label (Dial label).....	42
Speed Dial	44
Registering	44
Editing	46
Deleting	47
Groups	49
Registering	49
Editing	52
Deleting	55
Entering Characters	59
Available Characters	59
Keys	59
How to Enter Characters	60

4. Troubleshooting

Adjusting Volume	61
Error Messages	63
When the [Facsimile] key is Lit in Red	64
When the Receive File Indicator is Lit	65
Solving Problems	66
INDEX	67

ADVANCED FEATURES are in second section.

1. Getting Started

Machine Types

This machine comes in three models.

	Model A	Model B	
	Type1	Type1	Type2
Copy Speed	12 copies/minute (A4, 8 ¹ / ₂ "×11")	13 copies/minute (A4, 8 ¹ / ₂ "×11")	13 copies/minute (A4, 8 ¹ / ₂ "×11")
Paper Capacity for Bypass Tray	1 sheet	100 sheets	100 sheets
Paper Tray Unit	Not available	Option	Option
Fax Unit	Option	Option	Standard
Document Feeder	Option	Option	Standard

Guide to Components

1

Front View

Following illustration is for Model B.

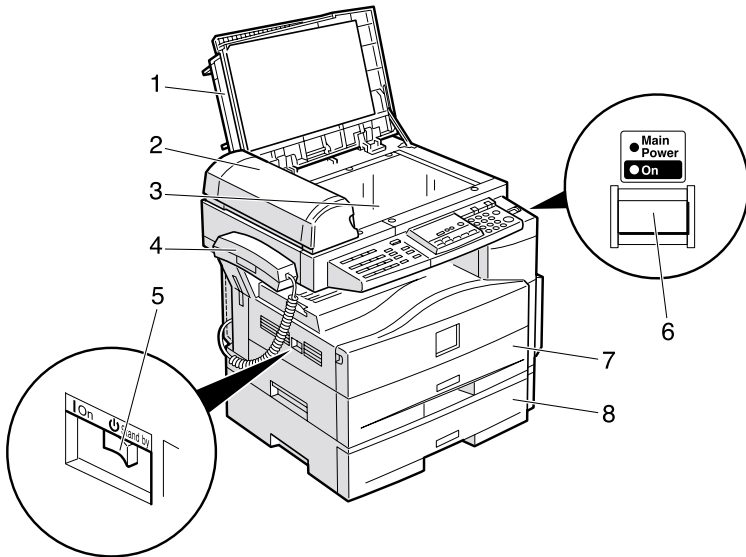

ZFRH020N

1. Exposure Glass Cover

Lower the Exposure Glass Cover over originals placed on the exposure glass.

2. Document Feeder (ADF) (Option for Type1)

Originals will be fed automatically.

3. Exposure Glass

Place the original face down on the upper left corner of the exposure glass, aligning the upper left corner with the reference mark. Close the exposure glass cover when you set a document on the exposure glass.

4. Handset (Option)

This permits voice communication.

5. main power switch

If the machine does not operate after turning on the operation switch, check if the main power switch is turned on. If it is off, turn it on. However, if the machine is installed with the fax option, do not turn the main power switch off.

Note

- The main power switch is normally set by your service representative. Do not touch this switch.
- When you press the operation switch and there is still no power, turn on the main power switch.
- If you leave the main power switch off for more than 12 hours, all files in memory are lost.

6. Operation switch

Press this switch to turn the power on (the **On** indicator lights up). To turn the power off, press this switch again (the **On** indicator goes off). See p.6 "Turning On the Power".

7. Paper Tray

Set paper here.

8. Paper Tray Unit (Option for Model B Only)

You can set more paper here.

Side View

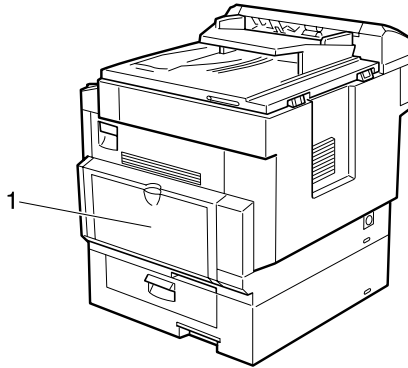

ZFKH030E

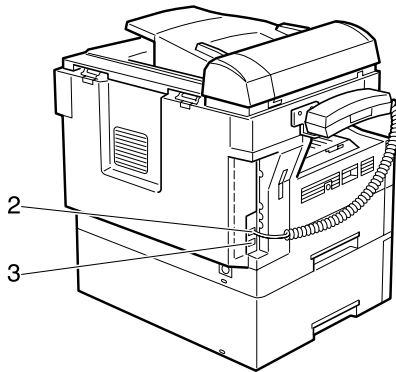

ZFKH040N

1. Bypass Tray

A fax message can be printed on the paper placed here. (Model B only)

2. External Telephone Connector

3. G3 Line Connector

Control Panel

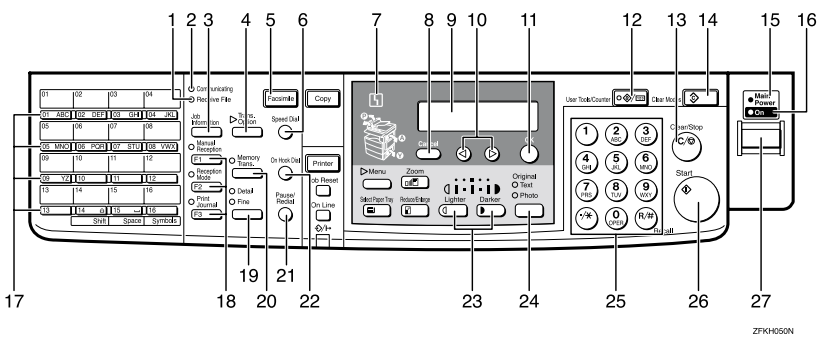

ZFKH050N

1. Receive File Indicator

Lights when a message has been received into memory.

2. Communicating Indicator

Lights during transmission or reception.

3. [Job Information] key

Press to search for information on a specific job.

4. [Transmission Option] key

Press to change the transmission option settings. The indicator lights when option settings are changed.

5. [Facsimile] key

Press to switch to Facsimile mode.

6. [Speed Dial] key

Press to select a Speed Dial.

7. Indicator

The indicator shows errors or the status of the machine.

8. [Cancel] key

Press to cancel an operation or return to the previous display.

9. LCD display

This guides you through tasks and informs you of the machine status. A message appears here.

10. [Left] [Right] keys

Press to move the cursor or select functions.

11. [OK] key

Press to answer " Yes " to a question displayed on the display.

12. [User Tools] key

Press to enter User Tools mode. These tools allow you to customize the default settings.

13. [Clear/Stop] key

Clear:

Deletes one character or digit.

Stop:

Interrupts the current operation (transmission, scanning, copying or printing).

14. [Clear Modes] key

15. Main Power Indicator

16. On Indicator

17. Quick Dial keys

Use to dial numbers at a single touch or to enter letters and symbols. Also use for the Group Dial function.

18. User Function keys

Each of these can be programmed for rapid access to frequently used functions.

❖ Functions Programmed by Default

Key	Function
F1	Manual Reception
F2	Reception Mode
F3	Print Journal

19. [Resolution] key

Press to switch between **Standard**, **Detail** and **Fine**. When the indicator is not lit, **Standard** is selected.

20. [Memory Trans.] key

Press this key to toggle between Memory Transmission (**Memory Trans.**) and Immediate Transmission (**Immediate Trans**) modes.

When the indicator is not lit, Immediate Transmission is selected, and when the indicator is lit, Memory Transmission is selected.

21. [Pause/Redial] key

Pause:

Inserts a pause when you are dialing or storing a fax number. A pause cannot be inserted as the first digit.

Redial:

Press to redial one of the last ten numbers.

22. [On Hook Dial] key

Use to dial a number from the numeric keypad without having to lift the handset.

23. [Image Density] keys (**Ⓒ** and **Ⓓ**)

Use to change the setting of image density.

24. [Original Type] key

Press to select original type, Text or Photo. When the original type is selected, the corresponding indicator lights.

25. Number keys

Use to dial fax numbers or enter the number of copies.

26. [Start] key

Press to start all tasks.

27. Operation switch

Press this switch to turn the power on (the **On** indicator goes on). To turn the power off, press this switch again (the **On** indicator goes off).

Starting the Machine

1

To start the machine, turn on the operation switch.

Note

- ❑ This machine automatically enters Energy Saver mode or turns itself off if you do not use the machine for a while. See Chapter 2 “Settings You Can Change with the User Tools” in the System Settings manual.

Power switches

This machine has two power switches: See p.2 “Guide to Components”.

❖ Operation switch

Turn on this switch to activate the machine. When the machine has warmed up, you can make copies or send faxes.

❖ Main power switch

If the machine does not operate after turning on the operation switch, check if the main power switch is turned on. If it is off, turn it on.

Important

- ❑ Fax files stored in memory can be kept for 12 hours after the main power is switched off if the machine has been on for at least a week. However, if the surrounding temperature is low, the storage time might be shorter.
- ❑ If you leave the main power switch off for more than 12 hours, all fax files in memory are deleted. See p.7 “Turning Off the Power”.

Turning On the Power

- 1** Confirm that the power cord is plugged into the wall outlet firmly and the main power switch is on.
- 2** Turn on the operation switch. The On indicator should light.

The panel display will turn on.

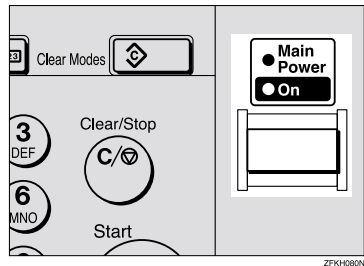

Note

- ❑ If nothing happens when you turn on the operation switch, make sure the main power switch is turned on.

Turning Off the Power

- 1 Turn off the operation switch. The On indicator will go out.

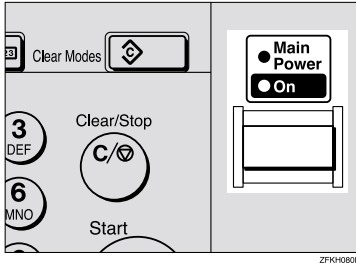

- 1 Make sure the On indicator is off.
- 2 Turn off the main power switch. The main power indicator turns off.

Important

- Before you unplug the power cord, confirm that the display in Facsimile mode indicates that the remaining memory space is 100%.

Turning Off the main power switch

When the main power switch is turned off while using the fax function, waiting fax jobs and print jobs may be canceled, and incoming fax documents cannot be received. Normally, only the service representative operates this switch. When you have to turn off this switch for some reason, follow the procedure below.

Important

- Make sure that 100% is shown on the Fax standby display before you turn the main power switch off or you unplug the power cord. Fax files programed in memory will be deleted 12 hours after you turn the main power switch off or you unplug the power cord.

Changing Modes

1

This machine is both a fax and a copier. If the machine is not in Facsimile mode, press the **[Facsimile]** key to use fax function.

You can set this machine to display facsimile mode immediately after the operation switch is turned on. See Chapter 2 "Settings You Can Change with the User Tools" in the System Settings manual.

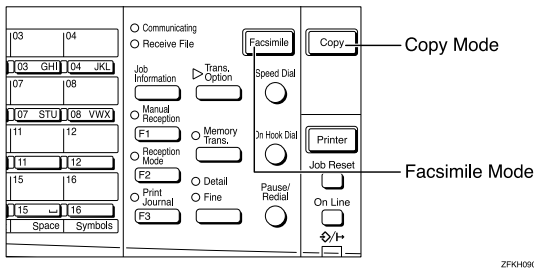

ZFRH090N

● Limitation

- ☐ You cannot switch modes under the following circumstances:
 - While scanning with fax
 - During Immediate Transmission
 - While editing the System Settings
 - While using On Hook Dial

Reading the Display

The machine status and instructions are shown on the display.

Note

- ❑ All procedures in this manual assume you are in Facsimile mode. If the machine is not in Facsimile mode, press the **[Facsimile]** key to change to Facsimile mode. You can have the machine start in Facsimile mode. See Chapter 2 "Settings You Can Change with the User Tools" in the System Settings.
- ❑ This machine automatically returns to the standby mode if you do not use the machine for a certain period of time. You can select the period in Fax Reset Timer. See Chapter 5 "Setting the Fax Reset Timer" in the Advanced Features manual.

Reading the Display and Using Keys

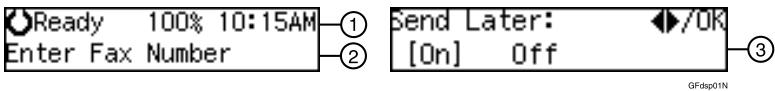

- ① Display for the machine status or currently selected function.
- ② Display for the messages.
Items which can be selected or specified.
- ③ Display for items which can be selected.

Note

- ❑ Press ⏪ or ⏩ to display another function on the LCD display or move the brackets to select another values.
- ❑ Press the **[OK]** key to set a selected function or entered value, and return to the previous display.
- ❑ Press the **[Cancel]** key to cancel the selected function or entered value, and return to the previous display.
- ❑ Press the **[Clear Modes]** key to cancel the settings and return to the initial display.

Standby Display

While the machine is in standby mode (immediately after it is turned on or after the **[Cancel]** key is pressed), the following display is shown.

```

Ready 100% 10:20AM
Set Orig. / Enter No.
  
```

Note

- ❑ To return the machine to standby mode, do one of the following:
 - If you have set the original and have not pressed the **[Start]** key, remove the original.
 - If you have not set an original, press the **[Cancel]** key.
 - If you are in User Tools mode, press the **[User Tools]** key or the **[Cancel]** key.

Communication Display

While the machine is communicating, the status is displayed.

◆ Display during Memory Transmission or Reception:

The destination's name or fax number appears on the top of the LCD display.

```

ABC COMPANY
Set Orig. / Enter No.
  
```

Note

- ❑ Even when the machine is sending or receiving a fax message from/into memory, you can still scan the next original into memory.

◆ Immediate Transmission:

```

ABC COMPANY
Transmitting...
  
```

Display Prompts

Depending on the situation, the machine will show various prompts on the display.

◆ Instructions and Requests

```

Send Later: Press OK
Time [ 9:00] PM
  
```

◆ Questions

```

Store as Wildcard?
[Yes] No
  
```

◆ Selections

```

Label Insertion: ◀/OK
[On] Off
  
```

◆ Status

```

ABC COMPANY
Dialing...
  
```

2. Faxing

Transmission Modes

There are two types of transmission.

❖ Memory Transmission

When a fax document is stored in memory, then transmission starts automatically.

This makes it convenient when you would like to take documents back in a hurry.

You can send the same message to more than one destination in a single operation. This technique is referred to as Broadcasting.

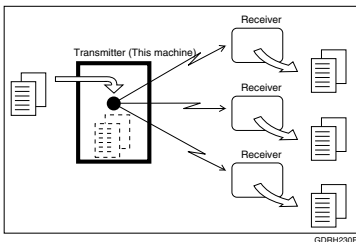

❖ Immediate Transmission

The machine dials immediately, and transmits the fax while scanning.

It is convenient when you would like to send a document immediately, and would like to check whether you have successfully connected with the other party's fax machine.

A fax document is not stored in memory.

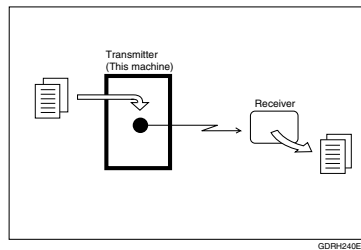

⚠ Important

- ❑ If there is a power failure, the power switch is turned off, or the plug is pulled out for more than 12 hours, all documents stored in memory are deleted. As soon as power is restored, the Power Failure Report is printed to help you identify deleted documents. See Chapter 7 "Power Failure Report" in the Advanced Features manual.

Switching between Memory Transmission and Immediate Transmission

Press the **【Memory Trans.】** key to switch between Memory Transmission and Immediate Transmission. When the indicator of the **【Memory Trans.】** key is not lit, Immediate Transmission is selected. When the indicator of the **【Memory Trans.】** key is lit, Memory Transmission is selected.

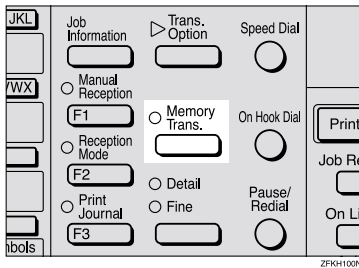

Note





- You can set whether the machine is in Memory Transmission mode or Immediate Transmission mode right after the power is turned on with the User Parameters. See Chapter 6 "User Parameters" in the Advanced Features manual (Switch 00 Bit 6).
- You can set whether the Transmission mode returns to the default mode after each transmission with the User Parameters. See Chapter 6 "User Parameters" in the Advanced Features manual (Switch 01 Bit 7).

Setting Originals

You can set your originals either in the Document Feeder or on the exposure glass. Some types of originals are unsuitable for the Document Feeder so they must be set on the exposure glass.



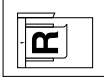

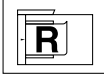

Which way you place your original depends on its size and whether you are using the Document Feeder or the exposure glass.

◆ How to set A4, B5, A5, 5 $\frac{1}{2}$ "x8 $\frac{1}{2}$ ", 8 $\frac{1}{2}$ "x11, 8 $\frac{1}{2}$ "x14" and 8"x13" size originals

Original	Where original is set	
	Exposure glass	Document Feeder
		
		

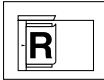
THY922E

◆ How to set A5 and 8 $\frac{1}{2}$ "x5 $\frac{1}{2}$ " size originals

Original	Where original is set	
	Exposure glass	Document Feeder
		
		

THY912E

Note

- When sending a fax, the image output at the other end depends on the size and direction of paper used in the receiver's terminal. If the receiver does not use paper of the same size and direction as that of the original, the fax image size may be reduced on output, trimmed at the both edges, or divided into two or more sheets. When sending an important original, we recommend that you ask the receiver about the size and direction of the paper used in their terminal.
- Make sure that all ink, correcting fluid, etc., has completely dried before setting your original. If it is still wet, the exposure glass will be marked and those marks will appear on the received image.
- You can set the original any time up until you press the **[Start]** key.

Placing a Single Original on the Exposure Glass

Set originals that cannot be placed in the Document Feeder, such as a book, on the exposure glass one page at a time.

- 1 Lift the Exposure Glass Cover. Place the original face down and align its upper left corner with the reference mark at the upper left corner of the exposure glass.

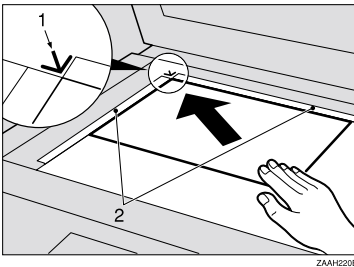

1. Reference mark
2. Scale

- 2 Close the Exposure Glass Cover.

Note

- When sending a bound original, the received image may contain some black areas. To reduce this effect, press down on the original to prevent its bound part from rising.

Loading Originals in the Document Feeder

Use the Document Feeder to scan in a stack of originals in one operation. The Document Feeder can handle single-sided originals.

Limitation

- The maximum document length is 1260mm (49.6") with manual assistance.
- Place all the originals to be sent in a single stack.
- You cannot set originals in the Document Feeder one page at a time or in sheaves.
- Do not open the Document Feeder while it is scanning the originals or your document could be jammed.

Note

- If an original jams, press the **【Clear/Stop】** key, and then remove the original carefully.
- If your original is bent or folded, flatten it before you set it.
- Set thin originals on the exposure glass.

Reference

For information about the sizes and number of originals that can be placed in the Document Feeder, see Chapter 8 "Originals" in the Advanced Features manual.

- 1** Adjust the document guide to match the size of your originals. Align the edges of your originals and stack them in the Document Feeder face up. Adjust the document guide to match the size of the originals again.

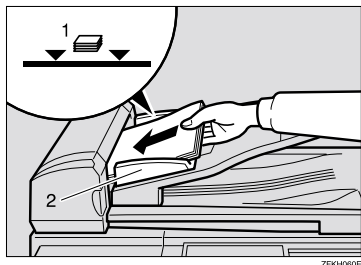

1. Limit mark
2. Document guide

Originals unsuitable for the Document Feeder (ADF)

Do not set the following types of originals in the Document Feeder because they may be damaged. Place them on the exposure glass instead.

- Thin and soft originals
 - Originals of inappropriate weight
 - Originals in bound form, such as books
 - Transparent originals, such as OHP transparencies or translucent paper
-
- ### Original Sizes Difficult to Detect
-
- The machine finds it difficult to detect the size of the following kinds of originals.
- Originals with index tabs, tags, or projecting parts
 - Transparent originals, such as OHP transparencies or translucent paper
 - Dark originals with many characters or drawings
 - Originals which partially contain solid printing
 - Originals which have solid printing at their edges

Memory Transmission

Memory Transmission is convenient because:

- Fax documents can be scanned much more quickly. Your scanned document is stored in the memory, and then sent automatically, meaning you do not have to wait for your document to send.
- While your fax document is being sent, another user can operate the machine (people do not have to wait long to use the fax machine).
- You can send the same document to more than one place with the same operation. (Broadcasting)
- There are two kinds of Memory Transmission: Parallel and Normal. See Chapter 3, "Parallel Memory Transmission" in the Advanced Features manual.

Important

- If there is a power failure (main power switch is off) or the plug is pulled out for more than 12 hours, all the files stored in memory are deleted. As soon as the main power switch is turned on, the Power Failure Report is printed to help you identify deleted files. If you turn just the operation switch off, files are not deleted.

Limitation

- If memory is full (0% appears on the display), Memory Transmission is disabled. Use Immediate Transmission instead.

Note

- Maximum number of Memory Transmission files: 133
- Maximum number of destinations per Memory Transmission: 133
- Combined total number of destinations that can be stored: 300
- The theoretical maximum number of destinations you can enter with the number keys is 67, but this will depend on the amount of memory currently available.
- The number of pages that you can store in memory depends on the original images and the scan settings. You can store up to 80 standard pages (ITU-T #1 chart, Resolution: Standard, Original Type: Text).
- You can set whether the machine returns to the default transmission mode after every transmission. You can change this so that the desired setting is maintained. See Chapter 6 "User Parameters" (Switch 01, Bit 7) in the Advanced Features manual.

1 Make sure that the Memory Transmission indicator is lit.

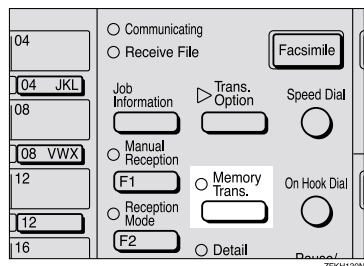

If it is not lit, press the **[Memory Trans.]** key.

2 Set the original.**Limitation**

- You can send the first pages from the exposure glass, and then the remaining pages from the Document Feeder. After you place the last page on the exposure glass, you have 60 seconds to insert the remaining pages in the Document Feeder.
- Note that you cannot place pages on the exposure glass after you have started using the Document Feeder.
- Do not open the Document Feeder while it is scanning in originals.

Note

- Place the original you want to store in memory on the exposure glass or the Document Feeder. To store multiple page originals from the exposure glass, set them page by page.

Reference

p.13 "Setting Originals"

3 Select any scan settings you require. See p.24 "Scan Settings".**4** Dial. If you wish to send the same message to more than one destination, press the **[OK]** key, and then dial another destination. Repeat this step for all destinations.

If you make a mistake, press the **[Clear/Stop]** key, and then enter the correct number again.

Note

- When specifying a destination using a Quick Dial, the destination is added even if you did not press the **[OK]** key.

Reference

p.26 "Dialing"

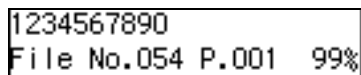
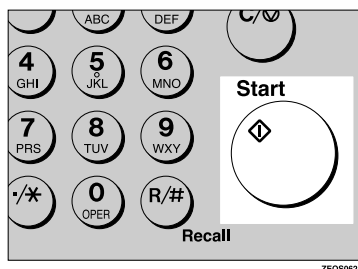
5 Press the **[Start]** key.

The machine starts scanning the original.

The machine calls the destination. The name or fax number which is programmed as the Own Name or Own Fax Number at the other end is shown on the top of the display.

Reference

p.33 "Own Name/Fax Header/Own Fax Number"

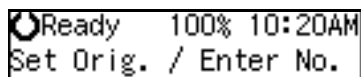

After transmission, the machine will return to standby mode.

Sending Originals from the Exposure Glass

1 Place the first page of your original on the exposure glass face down.

2 Dial.

3 Press the **[Start]** key.

The machine starts scanning the original.

4 Place the next original on the exposure glass within 60 seconds after the machine has finished scanning the first original.

 **Note**

Repeat steps **3** to **4** for all pages.

5 Press the **[#]** key to finish.

Canceling a Memory Transmission

Before the Start Key is Pressed

- 1 Press the **[Clear Modes]** key.

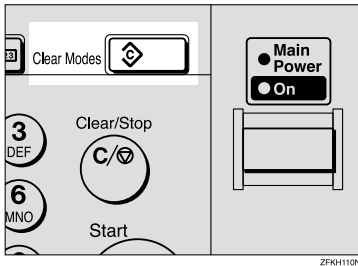

Note

- When you set the document in the Document Feeder, you can cancel the transmission by just removing it.

While the Original is Being Scanned

- 1 Press the **[Clear/Stop]** key.

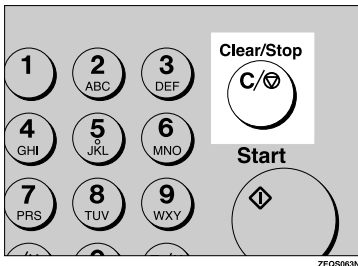

The machine will stop storing the original and the data will not be sent.

During Transmission

Use this procedure to cancel a transmission after the original has been scanned.

Limitation

- If transmission finishes while you are carrying out this procedure, it will not be canceled.

Note

- If you cancel a message while it is being sent, transmission is halted as soon as you finish this procedure. However, some pages of your message may have already been sent and will be received at the other end.

- 1 Make sure that the machine is in Facsimile mode and the standby display is shown.
- 2 Press the **[Job Information]** key, and confirm that "1. Cancel TX / RX" is displayed.

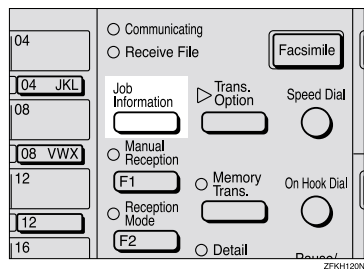

Job Information:
1.Cancel TX / RX

The Information menu is shown.

3 Press the **[OK]** key.

4 Display the file you want to delete.

Enter the file number with the number keys, or search using **⏪** or **⏩**.

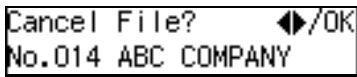

5 Press the **[OK]** key.

6 Press **⏪** or **⏩** to select "Yes"

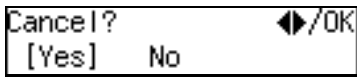

7 Press the **[OK]** key.

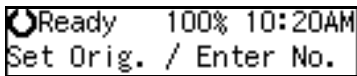

The file is erased, and the machine will return to standby mode

While the Original is Awaiting Transmission

📌 **Limitation**

- ❑ Pages already being sent to the destination cannot be canceled, even if you cancel the transmission. The transmission may be sent before you can cancel it, even if you start canceling the transmission before it is fully sent.

1 Press the **[Job Information]** key, and confirm that "1. Cancel TX/RX" is displayed.

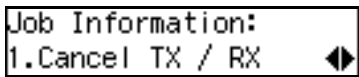
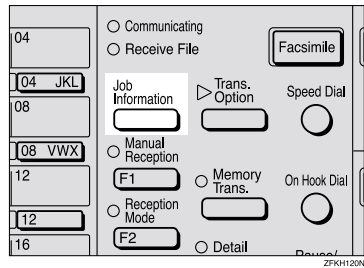

2 Press the **[OK]** key.

3 Display the file you want to delete.

Enter the file number with the number keys, or search using **⏪** or **⏩**.

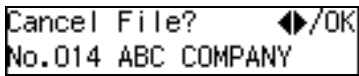

If you are unable to find the file, it has already been sent.

4 Press the **[OK]** key.

5 Press **⏪** or **⏩** to select "Yes".

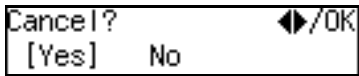

6 Press the **[OK]** key.

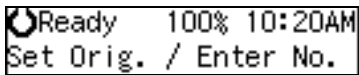

The file is erased, and the machine will return to standby mode

Immediate Transmission

Immediate Transmission is convenient when:

- You wish to send a document immediately as it is scanning.
- You wish to quickly check whether you have successfully connected with the other party's fax machine.
- Your machine's memory is getting full.

The machine dials immediately after you press the **[Start]** key. The message is scanned and transmitted page by page without being stored in memory.

 **Note**

- You can only specify one destination for Immediate Transmission.
- You can set whether the machine is in Memory Transmission mode or Immediate Transmission mode right after the power is turned on with the User Parameters.
- The machine does not redial with immediate transmission.

1 Check that the **Memory Transmission** indicator is not lit.

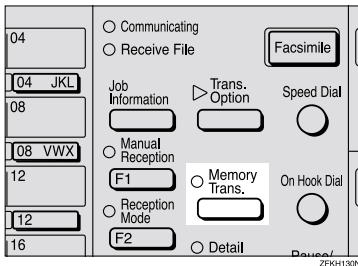

If it is lit, press the **[Memory Trans.]** key.

2 Set your original.

 **Reference**
p.13 "Setting Originals"

3 Select any scan settings you require. See p.24 "Scan Settings".

4 Dial.

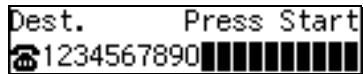

If you make a mistake, press the **[Clear/Stop]** key, and then enter the correct number again.

 **Reference**
p.26 "Dialing"

See Chapter 3 "Chain Dial" in the Advanced Features manual.

5 Press the **[Start]** key.

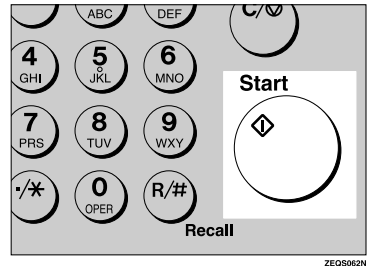

The machine calls the destination. While it is dialing, the number or name which is programmed as the Own Name or Own Fax Number in the machine of the other party is shown on the display. When connected, the machine starts scanning the original.

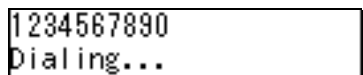

 **Reference**

p.33 "Own Name/Fax Header/Own Fax Number"



2

After transmission the machine will return to standby mode.

Sending Originals from the Exposure Glass

- ❶ Place the first page face down on the exposure glass.
- ❷ Dial.
- ❸ Press the **[Start]** key.
The machine starts scanning the original.
- ❹ Place the next original on the exposure glass within 10 seconds after the machine has finished scanning the first original.

 **Note**

- Repeat steps ❸ to ❹ for all originals.
- ❺ Press the **[#]** key to finish.

Canceling an Immediate Transmission

Before the Start key is Pressed

- 1 Press the **[Clear Modes]** key.

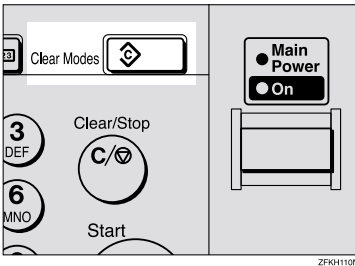

Note

- When you have already set the original, you can also cancel an Immediate Transmission by removing the original from the machine.

After the Start key is Pressed

- 1 Press the **[Clear/Stop]** key, and then remove the original.

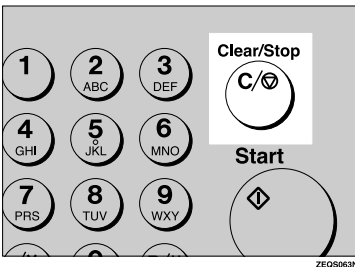

Note

- If the transmission finishes while you are carrying out this procedure, it will not be canceled.

Scan Settings

You may wish to send many different types of fax messages. Some of these may be difficult to reproduce at the other end. However, your machine has three settings that you can adjust to help you transmit your document with the best possible image quality.

- ◆ **Resolution:**
Standard, Detail, Fine
- ◆ **Original Type:**
Text, Photo
- ◆ **Image Density (Contrast):**
Manual Image Density

Resolution

Images and text are scanned into the machine by converting them to a sequence of dots. The frequency of dots determines the quality of the image and how long it takes to transmit. Therefore, images scanned at high resolution (**Fine**) have high quality but transmission takes longer. Conversely, low resolution (**Standard**) scanning results in less quality but your original is sent more quickly. Choose the setting that matches your needs based upon this trade off between speed and image clarity.

- ◆ **Standard (8×3.85lines/mm, 200×100dpi)**
Select for originals containing normal sized characters.
- ◆ **Detail (8×7.7lines/mm, 200×200dpi)**
Select for originals containing small characters or when you require greater clarity. This resolution is twice as fine as Standard.

- ◆ **Fine (8×15.4lines/mm, 200×400dpi)**
Select for originals with very fine details or when you require the best possible image clarity. This resolution is four times as fine as Standard.

⚠ Limitation

- ❑ If the other party's machine does not support the resolution at which you are sending, this machine automatically switches to a resolution which is supported.
- ❑ Sending with **Fine** resolution requires that the other party's machine has the capability to receive fax messages at **Fine** resolution.

📝 Note

- ❑ The resolution returns to the default setting after every transmission. You can change this with the User Parameters. See Chapter 6 "User Parameters (Switch01, Bit7)" in the Advanced Features manual.

- 1 Press the **[Resolution]** key to switch between resolutions. The indicators above the key shows the current selection. When neither of the indicators are lit, **Standard** is selected.

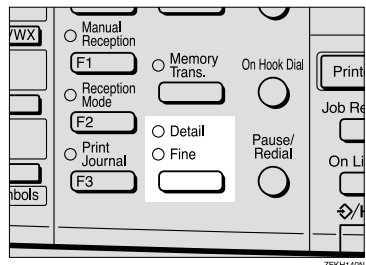

Original Type

If your original contains photographs, illustrations or diagrams with complex shading patterns or grays, select the appropriate Original Type to optimize image clarity.

❖ Text

Select **Text** to send an original containing a high-contrast black-and-white image. Use this setting even if your original contains text and photographs or if you only want to send clearer text.

❖ Photo

Select **Photo** to send an original containing a halftone image such as a photograph or a color original.

! Limitation

- ❑ If you select **Photo**, resolution is automatically set to **Detail**. Even if you select **Text** again, the resolution will not return to **Standard**.

📝 Note

- ❑ If you select **Photo**, the transmission will take longer than when **Text** is selected.
- ❑ If you send a fax message with **Photo** and the background of the received image is dirty, reduce the density setting and re-send the fax.
- ❑ When the machine is turned on or modes are cleared, the Original Type is set to **Text**.
- ❑ You can set whether the machine returns to the Original Type default setting after every transmission with the User Parameters. See Chapter 6 "User Parameters (Switch 01 Bit 7)" in the Advanced Features manual.

- 1 Press the **[Original Type]** key for the type you require.

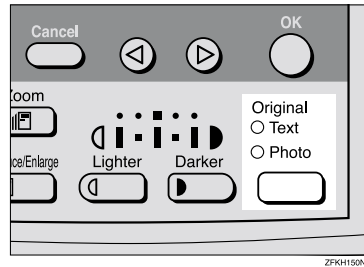
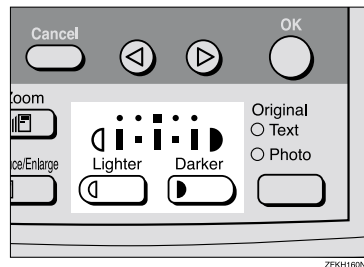

Image Density (Contrast)

The text and diagrams in your original should stand out clearly from the paper they are written on. If your original has a darker background than normal (for example, a newspaper clipping), or if the writing is faint, adjust the image density.

Use the **[Image Density]** keys to select the image density within 5 levels.

- 1 Press **◀** or **▶** to change the density from five density levels.



Dialing

There are four main ways to dial a number:

- ❖ **Entering Numbers Directly**
See p.26 “Entering Numbers Directly”
- ❖ **Using Quick Dials:**
See p.27 “Using Quick Dials”
- ❖ **Using Speed Dials:**
See p.28 “Using Speed Dials”
- ❖ **Using Groups**
See p.29 “Using Groups”

Entering Numbers Directly

Enter numbers directly using the number keys on the right side of the operation panel.

 **Note**

- Maximum length of a fax number: 254 digits.
- You can insert pauses and tones in a fax number. See p.27 “Pause”, p.27 “Tone”

- 1** Make sure that the machine is in standby mode.
- 2** Set your original and select any scan settings you require.

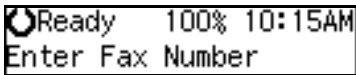

- 3** Enter the fax number with the number keys.

The digits appear on the display as you enter them.

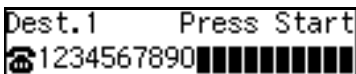

 **Note**

- If you make a mistake, press the **[Clear/Stop]** key and enter again.
- If you wish to send this message to more than one destination, press the **[OK]** key, and then enter the next destination.

- 4** Press the **[Start]** key.

 **Limitations when dialing with the number keys**

Fax numbers entered with the number keys are stored in internal memory (separate from memory for storing original data). Therefore, using the number keys, you cannot program more than 67 numbers for the following:

- Destinations specified in a Memory Transmission (including Polling Reception)
- Destinations specified in a Group

For example, when 60 destinations are registered in a Group with the number keys, only 7 destinations can be dialed for Memory Transmission from the number keys.

Note

- If a memory file is awaiting transmission and the "Exceeded the Max. Cannot Add" message is displayed when dialing with the number keys, you cannot dial any more numbers. That is because the fax numbers have been dialed with the number keys for some of the files awaiting transmission. When these files have been sent and their fax numbers are deleted from memory, additional fax numbers can be dialed.
- The display shows the percentage of free memory space for storing originals. Since fax numbers are stored in separate memory, dialing fax numbers with the number keys does not change the percentage on the display.

**Pause**

Press the **[Pause/Redial]** key when dialing or storing a number to insert about a two-second pause.

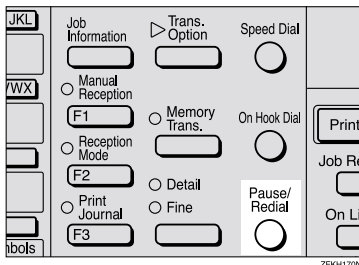
**Limitation**

- You cannot insert a pause before the first digit of a fax number.

Note

- A pause is shown as a "-" on the display.
- You can insert a pause in numbers stored in Quick Dials and Speed Dials.

Tone

This function allows a machine connected to a pulse dialing line to send tone signals (for example if you want to use a special service on a tone dialing line). When you press the **[*]** key, the machine dials the number using tone signals.

Limitation

- You cannot place a tone before the first digit of a fax number.
- Some services may not be available when using the **[*]** key.

Note

- A tone is shown as a "•" on the display.

Using Quick Dials

You can specify destinations simply by pressing the Quick Dial.

You must program the destination's fax number in a Quick Dial beforehand.

Additionally, you can store a name for the destination in Quick Dials.

Note

- To register, edit, or delete a Quick Dial, see p.38 "Quick Dial"
- To check the contents of all Quick dials, print the quick Dial list. See Chapter 5 "Printing Reports/Lists" in the Advanced Features manual.
- You can have the label stored with a Quick Dial printed on the first page received at the other end.

Reference

p.26 "Dialing"

- 1 Make sure that the machine is in standby mode.
- 2 Set your original and select any scan settings you require.

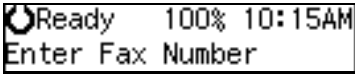

- 3 Press the Quick Dial key in which the destination's number is programmed.

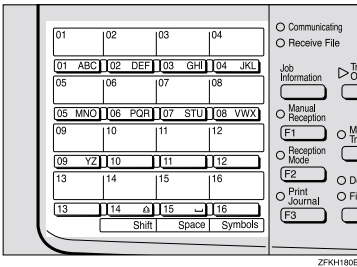

If the destination's name has been stored, the name is shown on the display. If it is not, the fax number is shown.

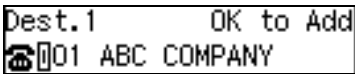

Note

- If you make a mistake, press the **[Clear/Stop]** key and try again.
- If you wish to dial another destination, press the **[OK]** key and dial another fax number.

- 4 Press the **[Start]** key.

Using Speed Dials

You can specify destinations simply by pressing the **[Speed Dial]** key and a Speed Dial code (00 to 49).

You must store the destination's fax number in a Speed Dial beforehand. Additionally, you can store a name for the destination in Speed Dials.

Note

- To register, edit, or delete Speed Dial entries, see p.44 "Speed Dial"
- To check the contents of all Speed Dials, print the Speed Dial list. See Chapter 5, "Printing Reports/Lists" in the Advanced Features manual.
- You can use codes 00-49 for Speed Dials.
- If a search letter is registered with a Speed Dial, you can find this number quickly using the Telephone Directory function. See Chapter 3 "Telephone Directory" in the Advanced Features manual.
- You can have the label stored with a Speed Dial printed on the first page received at the other end.

- 1 Make sure that the machine is in standby mode.
- 2 Set your original and select any scan settings you require.

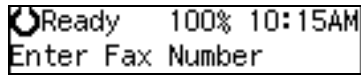

3 Press the **[Speed Dial]** key.

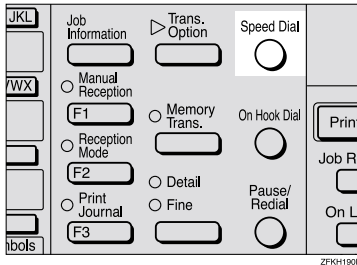

Speed Dial: Enter No.
[8][1]

4 Enter the two digit code (00 to 49) for the destination with the number keys.

Dest.1 OK to Add
☎00 DEF COMPANY

Note

- When a name is stored for the destination, the name is displayed, and when no name is stored, the fax number is displayed.
- If you wish to dial another destination, press the **[OK]** key and dial another fax number.
- If you make a mistake, press the **[Clear/Stop]** key, and try again.

5 Press the **[Start]** key.

Using Groups

You can store multiple destinations as a single Group and simply specify a particular Group.

You must store the destinations' fax number in a Group beforehand.

Additionally, you can store destination names and a Group name in Groups.

The method for specifying Groups differs according to the way they were programmed.

- When programmed in a Quick Dial: Press the Quick Dial key.
- When not programmed in a Quick Dial: First, Program the Group function in a User Function key (**[F1]** to **[F3]**). When you want to specify a destination, press the User Function key in which the Group Function is programmed, and then press the Group number with the number keys. (See Chapter 5, "User Function Keys" in the Advanced Features manual.)

Limitation

- Quick Dials programmed for Groups cannot be used for any other function.
- You cannot use Immediate Transmission to send Groups. You can only use Memory Transmission.

Note

- To register, edit, or delete Groups, see p.49 "Groups"
- To check the contents of all Groups, print the Group Dial list. See Chapter 5, "Printing Report/Lists" in the Advanced Features manual.

When Specifying a Group with a Quick Dial

Make sure that the Memory Transmission indicator is lit, if not, press the **[Memory Trans.]** key to light it.

 **Note**

- You must register Groups to Quick Dials beforehand. See p.49 “Groups”

1 Make sure that the machine is in standby mode.

2 Set your original and select any scan settings you require.

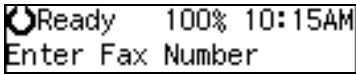

3 Press the Quick Dial key in which the Group is programmed.

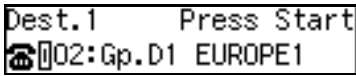

 **Note**

- If you make a mistake, press the **[Clear/Stop]** key and try again.
- If you wish to dial another destination, press the **[OK]** key, and then dial another fax number.

4 Press the **[Start]** key.

When Specifying a Group with the Group key

Make sure that the Memory Transmission indicator is lit, if not, press the **[Memory Trans.]** key to light it.

 **Note**

- You must program the Group function in a User Function key beforehand. See Chapter 5 “User Function Keys” in the Advanced Features manual.

1 Make sure that the machine is in standby mode.

2 Set your original and select any scan settings you require.

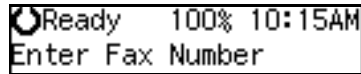

3 Press the User Function key programmed with the Group function.

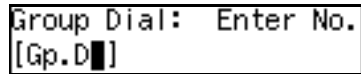

4 Enter the Group number (1 to 5) with the number keys.



 **Note**

- If you want to specify another Group, press the **[OK]** key, and then repeat step **3** above.
- If you make a mistake, press the **[Clear/Stop]** key, and the display will return to that in step **2**.

5 Press the **[Start]** key.

Reception Modes

The machine can treat incoming fax messages and telephone calls in three ways.

❖ Manual Receive

Use this mode if your line is shared by a fax machine and a telephone but you wish to answer all calls yourself and decide whether they are fax documents or telephone calls. You must manually press the **[Start]** key to receive a fax.

The machine will ring continuously until you answer the call, so you have to be near the machine at all times. The Manual Receive indicator is lit when the machine is in this mode.

❖ Auto Receive

Use this mode if you have a dedicated fax line. The machine assumes all calls are fax documents. It will ring once to alert you of an incoming call, and then starts receiving.

❖ Auto Select

In this mode, the machine rings a number of times. You can answer the call while the machine is ringing. If you do not answer the call, the machine automatically changes to receive fax messages.

📎 Note

- ❑ You can change the number of rings. See Chapter 5, "Setting the Auto Ring Time" in the Advanced Features manual.
- ❑ When the other party send a fax message, the machine changes to receive the fax message automatically.

- ❑ You can connect a telephone answering machine with Auto Select.
- ❑ Set a smaller number of rings for the telephone answering machine than for the fax machine.
- ❑ It could not work correctly depends on a telephone answering machine.

Selecting the Reception Mode

This function also requires the use of a User Function key. By default, the **[F2]** key is assigned as the **[Reception Mode]** key.

- 1 Press the **[Reception Mode]** key.

```
Reception Mode: ◀▶/OK
[Auto Receive]
```

- 2 Press **⏪** or **⏩** to select the reception mode.

```
Reception Mode: ◀▶/OK
Manual Receive
```

- 3 Press the **[OK]** key.

```
🔄Ready 100% 10:20AM
Set Orig. / Enter No.
```



Distinctive Ring

Two numbers (telephone number and fax number) can be assigned to one line by making a contract with your telephone company for Distinctive Ring. Each number will have a different ringing pattern. This is useful for distinguishing a fax from a telephone call.

Please contact your telephone company for details.

After making a contract with your telephone company, turn this function on with the User Parameters (Switch12 Bit1).

Note

- When Distinctive Ring is set, Reception Mode can not be selected.



3. Registering

Own Name/Fax Header/Own Fax Number

Make sure that all necessary settings are made before connecting your machine to the telephone line.

❖ Own Name

This should be your name or company name, in 20 characters or less. During communication, if the other party's fax machine supports Own Name, this replaces the Own Fax Number that follows. This name will appear on the display of the other party's fax machine, and the name registered on that machine will appear on yours.

💡 Limitation

- ❑ The registered name will not be used unless the other party has the same machine of the same make that supports the Own Name function.

❖ Fax Header

This is ordinarily your name or company name. Your fax header can be up to 32 characters long, and is printed on the header of every page you send.

❖ Own Fax Number (Required by international law)

This is your fax machine's phone number, which must include country and area codes, in 20 characters or less. During any communication, your Own Fax Number appears on their display. (Conversely their Own Fax Number appears on your display.)

📝 Note

- ❑ In some areas, the Own Fax Number is preprogrammed by your service representative, and cannot be re-programmed by the user.

⚠ Important

- ❑ When sending a fax, your Own Fax Number is required by international law. You cannot legally connect a fax machine to the telephone system if the Own Fax Number is not programmed.

📝 Note

- ❑ You can confirm the Own Name, Fax Header, and Own Fax Number settings in the User Parameters List. See Chapter 6 "Printing the User Parameter List" in the Advanced Features manual.

Registering

The following procedure describes how to make initial settings.

- 1 Press the **[User Tools]** key.

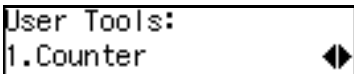
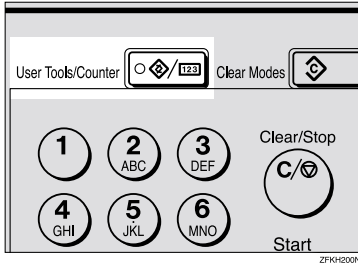

- 2 Press **[4]** or **[6]** until " 4. Fax Features " is displayed.

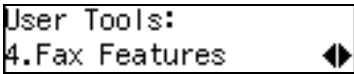

- 3 Press the **[OK]** key.

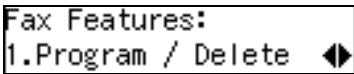

- 4 Press **[4]** or **[6]** until " 3. Setup " is displayed.

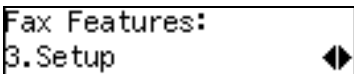

- 5 Press the **[OK]** key.

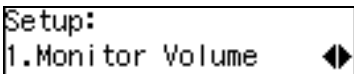

- 6 Press **[4]** or **[6]** until "6. Fax Information" is displayed.



- 7 Press the **[OK]** key.

Confirm that " 1. Own Name " is displayed.

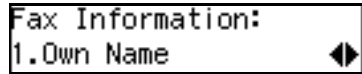

- 8 Press the **[OK]** key.



- 9 Enter your Own Name.



Note

- If you want to erase a character in the name, press the **[Clear/Stop]** key.

Reference

See p.59 "Entering Characters" for how to enter characters.

- 10 Press the **[OK]** key.

Your Own Name is programmed.

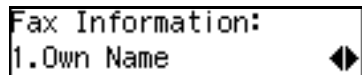

- 11 Press **[4]** or **[6]** until " 2. Fax Header " is displayed.

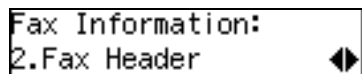

12 Press the **[OK]** key.

The programmed Own Name is displayed.

```
Header: [ABC] /OK
MAIN OFFICE ██████████
```

13 Enter your Fax Header.

If your Fax Header is the same as your Own Name, go to step 14.

```
Header: [ABC] /OK
MAIN OFFICE ██████████
```

14 Press the **[OK]** key.

Your Fax Header is programmed.

```
Fax Information:
2.Fax Header ◀▶
```

15 Press **⏪** or **⏩** until "3. Own Fax Number" is displayed.

```
Fax Information:
3. Own Fax Number ◀▶
```

16 Press the **[OK]** key.

```
Fax Number:
☎ ██████████
```

17 Enter your Own Fax Number.

```
Fax Number: /OK
☎ 1234567890 ██████████
```

Note

- The format of the number is normally as follows: International Dial Prefix, Your Country Code, Your Area Code (do not insert a pause after your Area Code), followed by your telephone number. Check the International Dialing Prefix and the Country Code with your local telecommunications operator.

Characters you can enter include numerals 0-9, plus signs (+), and spaces.

18 Press the **[OK]** key.

Your Own Fax Number is programmed.

```
Fax Information:
3. Own Fax Number ◀▶
```

19 Press the **[User Tools]** key to return to standby display.**Editing**

The following procedure describes how to edit initial settings.

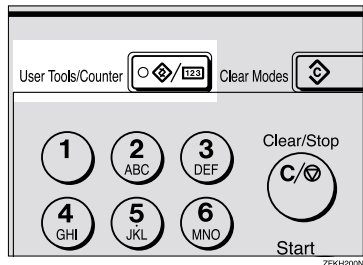
1 Press the **[User Tools]** key.

```
User Tools:
1.Counter ◀▶
```

2 Press **⏪** or **⏩** until "4. Fax Features" is displayed.

```
User Tools:
4.Fax Features ◀▶
```

3 Press the **[OK]** key.

```
Fax Features:
1.Program / Delete ◀▶
```

- 4** Press **⏪** or **⏩** until "3. Setup " is displayed.

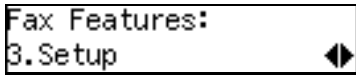

- 5** Press the **[OK]** key.

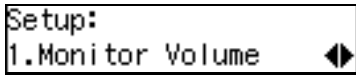

- 6** Press **⏪** or **⏩** until "6. Fax Information " is displayed.

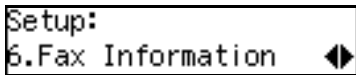

- 7** Press the **[OK]** key.

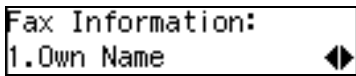

- 8** Press **⏪** or **⏩** to select the item that you want to edit.

- 9** Press the **[OK]** key.

- 10** Press the **[Clear/Stop]** key, and then reenter the Number or Name.

- 11** Press the **[OK]** key.

- 12** Press the **[User Tools]** key to return to standby display.

Deleting

The following procedure describes how to delete initial settings.

- 1** Press the **[User Tools]** key.

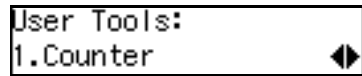
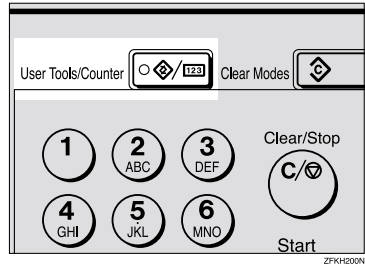

- 2** Press **⏪** or **⏩** until "4. Fax Features " is displayed.

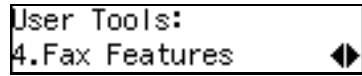

- 3** Press the **[OK]** key.

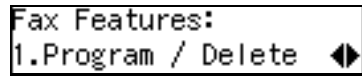

- 4** Press **⏪** or **⏩** until "3. Setup " is displayed.

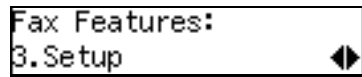

- 5** Press the **[OK]** key.

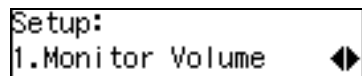

- 6** Press ◀ or ▶ until " 6. Fax Information " is displayed.

```
Setup:
6.Fax Information  ◀▶
```

- 7** Press the [OK] key.

```
Fax Information:
1.Own Name        ◀▶
```

- 8** Press ◀ or ▶ to select the item that you want to delete.

- 9** Press the [OK] key.

- 10** Press the [Clear/Stop] key.

- 11** Press the [OK] key.

- 12** Press the [User Tools] key to return to standby display.

Quick Dial

To save time, you can program a fax number that you use often into a Quick Dial key. Then, whenever you are sending a message to that location, just press that Quick Dial key to dial.

3

Registering

The following procedure describes how to register fax numbers in Quick Dial keys. There are 16 Quick Dials available.

You can register the following items in each key:

- Destination fax number (up to 254 digits)
- Destination name (up to 20 characters)
- Label Insertion (whether to print the destination name on faxes sent to this number)

Important

- ☐ We recommend that you print the Quick Dial list and keep it when you program or change fax numbers. See Chapter 5 "Printing Reports/Lists" in the Advanced Features manual.

Limitation

- ☐ When a registered Quick Dial key is being used for a standby Memory Transmission, the message "This Dial is in Use. Cannot Change." is shown and you cannot change the destination for this key.

Note

- ☐ You can confirm fax numbers stored in Quick Dials on the Quick Dial List. See Chapter 5, "Printing Reports/Lists" in the Advanced Features manual.

1 Press the **[User Tools]** key.

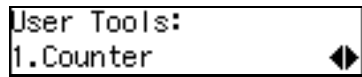
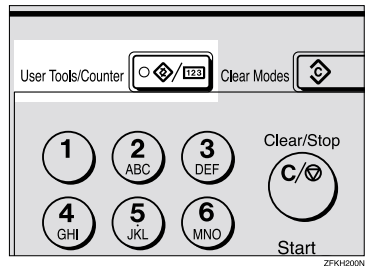

2 Press **⏪** or **⏩** until "4. Fax Features" is displayed.

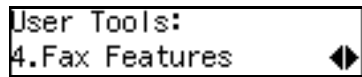

3 Press the **[OK]** key.

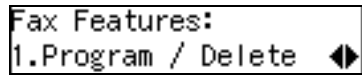

Confirm that "1. Program / Delete" is displayed.

4 Press the **[OK]** key.

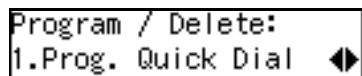

Confirm that "1. Prog. Quick Dial" is displayed.

- 5** Press the **[OK]** key.

Press Key to Program
(Browse◀▶)

- 6** Display the number of the Quick Dial key you want to register.

Press a Quick Dial key, or search using ◀ or ▶.

001 Fax No.
☎ [████████████████████]

 **Note**

- If a Quick Dial has already been registered, the contents are displayed. Press ◀ or ▶ to select a Quick Dial that is not programmed, and then press the **[OK]** key.

- 7** Enter a fax number with the number keys.

001 Press OK
☎ 1234567890 [████████████]

 **Note**

- If you make a mistake, press the **[Clear/Stop]** key and try again.
- If you press the **[Pause/Redial]** key, the last 10 fax numbers dialed are displayed. Press ◀ or ▶ to select the fax number you want to specify, and then press the **[OK]** key.
- Make sure a Dial Option is stored in one of the User Function keys, and then enter the other party's fax number, and then press the User Function key that contains the Dial Option. You can specify SUB or SEP, SID and PWD (See Chapter 3 "SEP Code" or "SUB Code" in the Advanced Features manual).

- 8** Press the **[OK]** key.

The fax number is programmed.

001 [ABC] Name
[████████████████████]

- 9** Enter the destination name.

001 [ABC] /OK
[ABC COMPANY ██████████]

 **Note**

- Under rare circumstances, garbled characters may appear during name registration if you use the **[Pause/Redial]** key to display the fax number of parties located in other countries. If this happens, simply delete the garbled characters using ◀ or ▶ and the **[Clear/Stop]** keys, then go on to enter the name.

- 10** Press the **[OK]** key.

The name is programmed.

Label Insertion: ◀▶/OK
On [Off]

- 11** Press ◀ or ▶ to select either "On" or "Off".

 **Note**

- Label insertion allows the receiver's name that is programmed in Quick Dial or Speed Dial to be printed on the fax when it is received at the other end. See Chapter 1 "Label Insertion" in the Advanced Features manual.

Label Insertion: ◀▶/OK
[On] Off

12 Press the **[OK]** key.

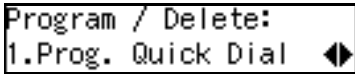

If you want to store another Quick Dial, go to step **5**.

13 Press the **[User Tools]** key to return to standby display.

Editing

The following procedure describes how to edit fax numbers registered in Quick Dial keys.

1 Press the **[User Tools]** key.

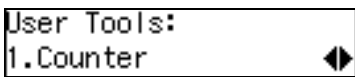
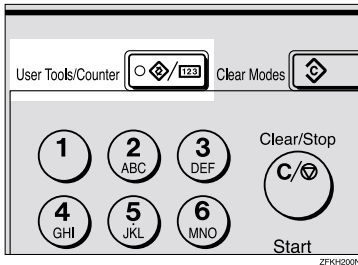

2 Press **[4]** or **[5]** until " 4. Fax Features " is displayed.

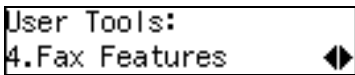

3 Press the **[OK]** key.

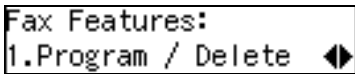

Confirm that " 1. Program / Delete " is displayed.

4 Press the **[OK]** key.

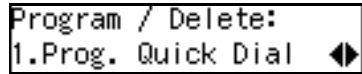

Confirm that " 1. Prog. Quick Dial " is displayed.

5 Press the **[OK]** key.

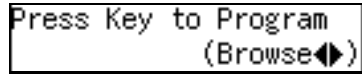

6 Display the number of the Quick Dial key you want to edit.

Press a Quick Dial key, or search using **[4]** or **[5]**.

7 Press the **[OK]** key.

8 Press the **[Clear/Stop]** key, and then reenter the fax number with the number keys.

Note

- If you make a mistake, press the **[Clear/Stop]** key and try again.
- If you press the **[Pause/Redial]** key, the last 10 fax numbers dialed are displayed. Press **[4]** or **[5]** to select the fax number you want to specify, and then press the **[OK]** key.
- Make sure a Dial Option is stored in one of the User Function keys, and then enter the other party's fax number and press the User Function key that contains the Dial Option. You can specify SUB or SEP, SID and PWD (See Chapter 3 "SEP Code" or "SUB Code" in the Advanced Features manual).

9 Press the **[OK]** key.

- 10** Press the **[Clear/Stop]** key, and then reenter the destination name.

 **Note**

- Under rare circumstances, garbled characters may appear during name registration if you use the **[Pause/Redial]** key to display the fax number of parties located in other countries. If this happens, simply delete the garbled characters using **⏪** or **⏩** and the **[Clear/Stop]** keys, and then go on to enter the name.

- 11** Press the **[OK]** key.

The name is programmed.

```
Label Insertion: ◀/OK
On [Off]
```

- 12** Press **⏪** or **⏩** to select either "On" or "Off".

 **Note**

- Label insertion allows the receiver's name that is programmed in Quick Dial or Speed Dial to be printed on the fax when it is received at the other end. See Chapter 1 "Label Insertion" in the Advanced Features manual.

```
Label Insertion: ◀/OK
[On] Off
```

- 13** Press the **[OK]** key.

```
Program / Delete:
1.Prog. Quick Dial ▶
```

If you want to store another Quick Dial, go to step **5**.

- 14** Press the **[User Tools]** key to return to standby display.

Deleting

The following procedure describes how to delete fax numbers registered in Quick Dial keys.

 **Limitation**

- When a Quick Dial key is being used for a standby Memory Transmission, the message "This Dial is in Use. Cannot Delete." is shown and you cannot delete the destination for this key.

- 1** Press the **[User Tools]** key.

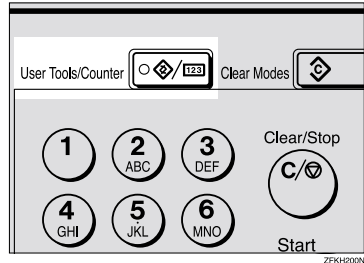

```
User Tools:
1.Counter ▶
```

- 2** Press **⏪** or **⏩** until "4. Fax Features" is displayed.

```
User Tools:
4.Fax Features ▶
```

- 3** Press the **[OK]** key.

```
Fax Features:
1.Program / Delete ▶
```

Confirm that "1. Program / Delete" is displayed.

- 4** Press the **[OK]** key.

- 5** Press **⏪** or **⏩** until "2. Del. Quick Dial" is displayed.

```

Program / Delete:
2.Del. Quick Dial  ⏪
    
```

- 6** Press the **[OK]** key.

```

Press Key to Delete
(Browse⏪)
    
```

- 7** Display the Quick Dial key that you want to delete.

Press a Quick Dial key or search by pressing **⏪** or **⏩**.

```

Delete?  ⏪/OK
001 DEF COMPANY
    
```

The number of the Quick Dial key and the fax number or name are displayed.

- 8** Press the **[OK]** key.

The stored data (fax number and name) is deleted.

```

Program / Delete:
2.Del. Quick Dial  ⏪
    
```

If you want to delete another Quick Dial key, go to step **5**.

- 9** Press the **[User Tools]** key to return to standby display.

Quick Dial Key Label (Dial label)

You can print a template that can be used to make labels for Quick Dial keys. The template will have destination or Group names programmed in Quick Dial keys.

⚠ Limitation

- Set the label paper to landscape in the Bypass Tray. Portrait position will print the wrong size.

📝 Note

- To print the label template, see Chapter 5 "Printing Reports/Lists" in the Advanced Features manual.

Label paper

P. 1

* * * QUICK DIAL LABEL (OCT.11.2001 11:45 AM) * * *

FAX HEADER: MAIN OFFICE

1	2		
01 : ABC PANY	02 : COM	03 : EUROPE	04 :
05 :	06 :	07 :	08 :
09 :	10 :	11 :	12 :
13 :	14 :	15 :	16 :

01 : ABC CO MPANY	02 : EUROPE	03 :	04 :
05 :	06 :	07 :	08 :
09 :	10 :	11 :	12 :
13 :	14 :	15 :	16 :

CUT ALONG THE DOTTED LINES AND SET THE LABEL(S) TO THE OPERATION PANEL.

ZFKH210N

1. Quick Dial key number

2. Destination name

3

Speed Dial

Registering

If you register numbers in Speed Dials, you can specify the fax number simply by pressing the **[Speed Dial]** key, and entering a two-digit Speed Dial number.

3

The following procedure describes how to register fax numbers in Speed Dials.

You can register the following items in a Speed Dial:

- Destination fax number (up to 50 numbers, up to 254 digits for each number)
- Destination name (up to 20 characters)
- A Telephone Directory search letter (A to Z)
- Label Insertion (whether to print the destination name on faxes sent to this number)

Important

- We recommend that you print the Speed Dial list and keep it when you register or change a destination.

Limitation

- When a registered Speed Dial is being used for a standby Memory Transmission, the message " This Dial is in Use. Cannot Change. " is shown and you cannot change the destination for this Quick Dial. .

Note

- You can specify codes 00 to 49.
- You can confirm the contents of Speed Dial numbers in the Speed Dial List. See Chapter 5, "Printing Reports/Lists" in the Advanced Features manual.

1 Press the **[User Tools]** key.

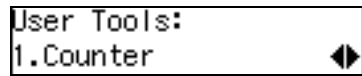
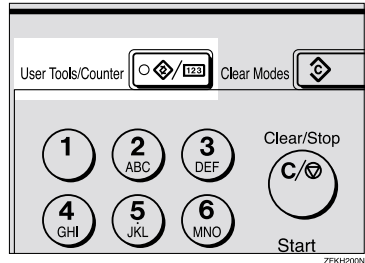

2 Press **[Left]** or **[Right]** until " 4. Fax Features " is displayed.

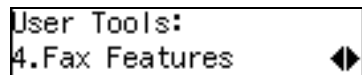

3 Press the **[OK]** key.

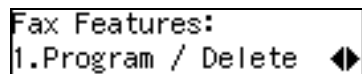

Confirm that " 1. Program / Delete " is displayed.

4 Press the **[OK]** key.

5 Press **[Left]** or **[Right]** until " 3. Prog. Speed Dial " is displayed.

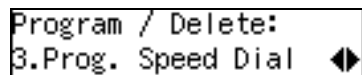

6 Press the **[OK]** key.

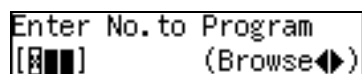

- 7** Display the number of the Speed Dial you want to register (00 to 49).

Enter the Speed Dial number with the number keys, or search using ◀ or ▶.



Note

- If you make a mistake, press the **[Clear/Stop]** key and try again.
- If a Speed Dial number has already been stored, the contents are displayed. Press ◀ or ▶ to select an unprogrammed number, then press the **[OK]** key.

- 8** Enter a fax number with the number keys.

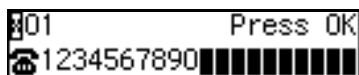

Note

- If you make a mistake, press the **[Clear/Stop]** key and try again.
- If you press the **[Pause/Redial]** key, the last 10 fax numbers dialed are displayed. Press ◀ or ▶ to select the fax number you want to specify, and then press the **[OK]** key.

- 9** Press the **[OK]** key.

The fax number is programmed.



- 10** Enter the Destination name.



Note

- If a destination name is already registered in the Speed Dial, the name is shown on the display. If you wish to change the destination name, press the **[Clear/Stop]** key, and then enter another name.

- 11** Press the **[OK]** key.

The search letter is registered.

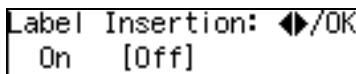

- 12** Press ◀ or ▶ to select "On" or "Off".

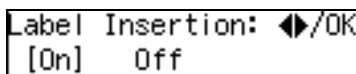

Note

- Label insertion allows the destination name that is programmed in Quick Dial or Speed Dial to be printed on the fax when it is received at the other end. See Chapter 1 "Label Insertion" in the Advanced Features manual.

- 13** Press the **[OK]** key.

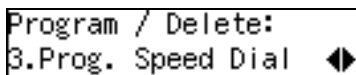

If you want to store another Speed Dial number, go to step 8.

- 14** Press the **[User Tools]** key to return to standby display.

Editing

The following procedure describes how to edit registered Speed Dial numbers.

- 1 Press the **[User Tools]** key.

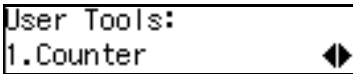
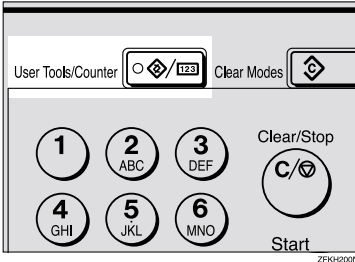

- 2 Press **[Left]** or **[Right]** until " 4. Fax Features " is displayed.

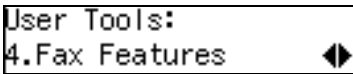

- 3 Press the **[OK]** key.

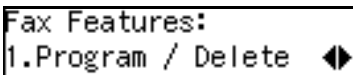

Confirm that " 1. Program / Delete " is displayed.

- 4 Press the **[OK]** key.

- 5 Press **[Left]** or **[Right]** until " 3. Prog. Speed Dial " is displayed.

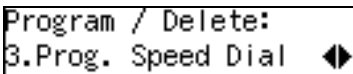

- 6 Press the **[OK]** key.

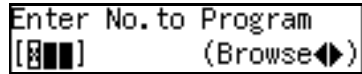

- 7 Display the number of the Speed Dial you want to edit (00 to 49).

Enter the Speed Dial number with the number keys, or search using **[Left]** or **[Right]**.

- 8 Press the **[OK]** key.

- 9 Press the **[Clear/Stop]** key, and then reenter a fax number with the number keys.



Note

- If you make a mistake, press the **[Clear/Stop]** key and try again.
- If you press the **[Pause/Redial]** key, the last 10 fax numbers dialed are displayed. Press **[Left]** or **[Right]** to select the fax number you want to specify, and then press the **[OK]** key.

- 10 Press the **[OK]** key.

The fax number is programmed.

- 11 Press the **[Clear/Stop]** key, and then reenter the Destination name.



- 12 Press the **[OK]** key.

The search letter is registered.

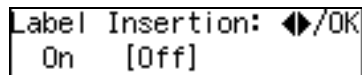

- 13 Press **⏪** or **⏩** to select "On" or "Off".

```
Label Insertion: ◀/OK
[On] Off
```

Note

- ❑ Label insertion allows the destination name that is programmed in Quick Dial or Speed Dial to be printed on the fax when it is received at the other end. See Chapter 1 "Label Insertion" in the Advanced Features manual.

- 14 Press the **[OK]** key.

```
Program / Delete:
3.Prog. Speed Dial ▶
```

If you want to edit another Speed Dial number, go to step 6.

- 15 Press the **[User Tools]** key to return to standby display.

Deleting

The following procedure describes how to delete fax numbers in Speed Dials.

Limitation

- ❑ If a registered Speed Dial is being used for a standby Memory Transmission, the message "This Dial is in Use. Cannot Delete." is shown and you cannot delete the destination for this Speed Dial.

- 1 Press the **[User Tools]** key.

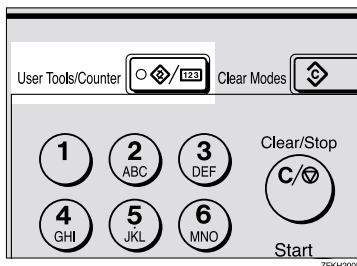

```
User Tools:
1.Counter ▶
```

- 2 Press **⏪** or **⏩** until "4. Fax Features" is displayed.

```
User Tools:
4.Fax Features ▶
```

- 3 Press the **[OK]** key.

```
Fax Features:
1.Program / Delete ▶
```

Confirm that "1. Program / Delete" is displayed.

- 4 Press the **[OK]** key.

- 5** Press \leftarrow or \rightarrow until "4. Del. Speed Dial" is displayed.

```
Program / Delete:
4.Del. Speed Dial  ◀▶
```

- 6** Press the **[OK]** key.

```
Enter No. to Delete
[8] (Browse▶▶)
```

3

- 7** Display the Speed Dial number you want to delete (00 to 49).

Enter the Speed Dial number with the number keys or search using \leftarrow or \rightarrow .

```
Delete? ▶▶/OK
001 DEF COMPANY
```

The Speed Dial number and the fax number or name are displayed.

- 8** Press the **[OK]** key.

The programmed data (fax number and name) is deleted.

```
Program / Delete:
4.Del. Speed Dial  ▶▶
```

If you want to delete another name, go to step **6**.

- 9** Press the **[User Tools]** key to return to standby display.

Groups

If you regularly broadcast documents to the same set of destinations, you can combine these numbers into a group. Then just select the group and each number will be dialed in sequence automatically.

There are two ways of programming Groups:

❖ Registering groups in Quick Dial keys

If you register a group in a Quick Dial key, you can specify that group by pressing a Quick Dial key. However, if you use Quick Dial keys to register groups, you will be able to register fewer Quick Dial keys.

📌 Limitation

- ❑ You cannot register another function (Quick Dials) in a Quick Dial key already used for a group. Also, you cannot register groups in a Quick Dial key already used for another function.

❖ Assigning the Group Functions to the Group key

To assign the Group Function to the Group key, you must first assign the Group function to a User Function key. To send a fax, press the Group key, and then enter the group number (1 to 5). To select a Group using a Group key, one more step is required than when using a Quick Dial key. However, multiple Groups (a maximum of five) can be stored in a Group key, thus leaving the Quick Dial keys to be used more effectively.

Registering

You can register the following items in a Group:

- Destination fax numbers
- Group name (up to 20 characters)

You can enter destination numbers by Quick Dial keys, Speed Dials, or the number keys.

📌 Note

- ❑ You can register up to 5 Groups.
- ❑ The maximum number of destinations you can register in a Group is 133.
- ❑ The combined maximum number of destinations you can register in all Groups is 133. This 133 can be composed of up to 16 Quick Dial numbers, 50 Speed Dial numbers and 67 numbers entered directly with the number keys.
- ❑ The number of destinations that can be registered with the number keys depends on how the machine is used. In theory you can register up to a combined maximum of 67 destinations with the number keys for all groups.
- ❑ If you register 67 destinations with the number keys, Memory Transmission using the number keys becomes unavailable, and only Immediate Transmission is available.
- ❑ If you register a Group with the number keys when a file is waiting to be transmitted, a message is shown. You sometimes cannot register any more destinations even when the number of specified destination is 66 or less.

- ❑ It is recommended that you print the Group Dial list and keep it when you register or change destinations. See Chapter 5, "Printing Reports/ Lists" in the Advanced Features manual.
- ❑ If you register the same destination in different Groups, it is only counted as one item.
- ❑ How to count numbers.

3

	Registered destinations	Total Number of items
Group 1	Quick Dial: [01], [03], [05] Speed Dial: [02], [04], [06] number key: 12345678	9
Group 2	Quick Dial: [01], [05] Speed Dial: [02], [04], [09] number key: 12345678, 87654321	

1 Press the **[User Tools]** key.

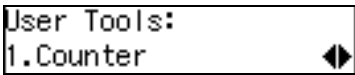
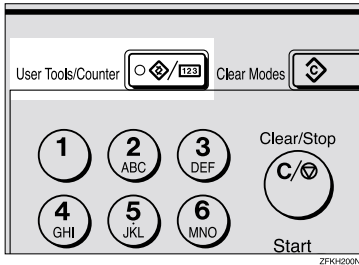

2 Press **⏪** or **⏩** until " 4. Fax Features " is displayed.

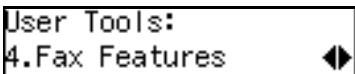

3 Press the **[OK]** key.

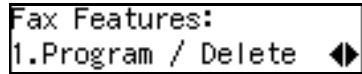

Confirm that " 1. Program / Delete " is displayed.

4 Press the **[OK]** key.

5 Press **⏪** or **⏩** until " 5. Prog. Group Dial " is displayed.



6 Press the **[OK]** key.

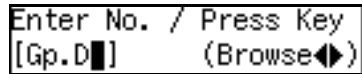

7 Display the number of the Group you want to register (1 to 5).

Enter the group number with the number keys, or search using **⏪** or **⏩**.



Note

- ❑ If you make a mistake, press the **[Cancel]** key and try again.
- ❑ If a group has already been stored, the contents are displayed. Press **⏪** or **⏩** to select a group number that is not programmed, and then press the **[OK]** key.
- ❑ If a group is programmed, but no name is specified, the group number only is displayed on the lower line of the display.

- 8** Specify the destination using one of the following three methods:

Enter the fax number with the number keys.

```
Gp.D1:#1      Press OK
☎123456789
```

Press a Quick Dial key.

```
Gp.D1:#1      Press OK
☎01 ABC COMPANY
```

Press the **[Speed Dial]** key, and then enter a Speed Dial number.

```
Gp.D1:#1      Press OK
☎00 London office
```

- 9** Press the **[OK]** key.
The destination is programmed.
- 10** Press the **[◀]** or **[▶]** to select "Add" or "Exit".

```
Program?      ◀/OK
[Add] Delete Exit
```

- 11** Press the **[OK]** key.
If you selected "Exit", go to step **10**.
- 12** Repeat step **7** to **11** for all the destinations you want to register in the Group.
- 13** Enter the Group name.

```
Gp.D1 [abc]   /OK
[Europe
```

Note

- If the Group name is already registered, it is shown on the display. If you wish to change the Group name, press the **[Clear/Stop]** key, and then enter another name.

- 14** Press the **[OK]** key to register the Group.

```
Assign to Key? ◀/OK
[Yes] No
```

- 15** Press **[◀]** or **[▶]** to select "Yes" or "No" to be programmed in the Quick Dial key. Then press the **[OK]** key.
If you selected "No", go to step **10**.

- 16** Press the Quick Dial key you want to register in the Group.

```
Press Quick Dial Key
[[03]
```

- 17** Press the **[OK]** key.

```
Program / Delete:
5.Prog. Group Dial ▶
```

- 18** Press the **[User Tools]** key to return to standby display.

Editing

You can edit the group name or add destinations for programmed groups. To edit a destination:

- For destinations programmed in Quick Dial or Speed Dial, edit the contents of the programmed Quick Dial or Speed Dial.
- For destinations programmed with the number keys, delete the destination you want to edit from the group, and then program the new destination.

Editing a Group Name

- 1 Press the **[User Tools]** key.

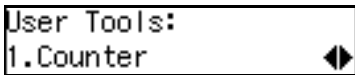
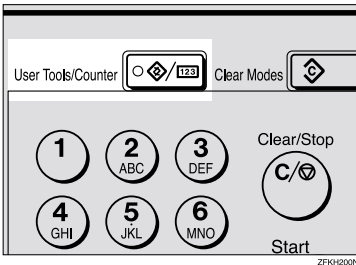

- 2 Press **[Left]** or **[Right]** until " 4. Fax Features " is displayed.

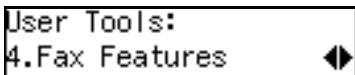

- 3 Press the **[OK]** key.

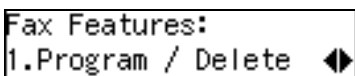

Confirm that " 1. Program / Delete " is displayed.

- 4 Press the **[OK]** key.

- 5 Press **[Left]** or **[Right]** until " 5. Prog. Group Dial " is displayed.



- 6 Press the **[OK]** key.

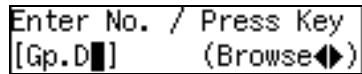

- 7 Display the number of the group you want to edit (1 to 5).

Enter the group number with the number keys, or search using **[Left]** or **[Right]**.



- 8 Press the **[OK]** key.

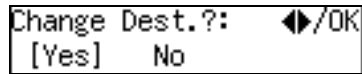

- 9 Press **[Left]** or **[Right]** to select "No".

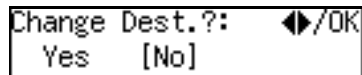

- 10 Press the **[OK]** key.

- 11 Press the **[Clear/Stop]** key, and then enter the new name.

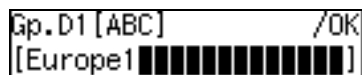

Note

- If you want to delete a character of the name, press the **[Clear/Stop]** key.
- If you press the **[Cancel]** key, the display will return to that shown for step 5.

- 12** Press the **[OK]** key.

The name is changed.

- 13** Press **⏪** or **⏩** to select "Yes" if the group was programmed in a Quick Dial, or select "No" if it was not.

```
Assign to Key?  ⏪/OK
[Yes]  No
```

- 14** Press the **[OK]** key.

If you selected "No", go to step **13**.

```
Press Quick Dial Key
[005]
```

Note

- If you want to edit a programmed Quick Dial key, press the Quick Dial key, and then the **[OK]** key.

- 15** Press the **[OK]** key.

```
Program / Delete:
5.Prog. Group Dial  ⏪
```

If you want to program another group name, go to step **13**.

- 16** Press the **[User Tools]** key to return to standby mode.

Adding a Fax Number to a Group

- 1** Press the **[User Tools]** key.

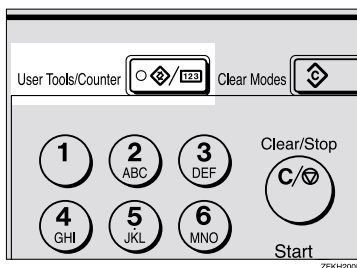

```
User Tools:
1.Counter  ⏪
```

- 2** Press **⏪** or **⏩** until "4. Fax Features" is displayed.

```
User Tools:
4.Fax Features  ⏪
```

- 3** Press the **[OK]** key.

```
Fax Features:
1.Program / Delete  ⏪
```

Confirm that "1. Program / Delete" is displayed.

- 4** Press the **[OK]** key.

- 5** Press **⏪** or **⏩** until "5. Prog. Group Dial" is displayed.

```
Program / Delete:
5.Prog. Group Dial  ⏪
```

- 6** Press the **[OK]** key.

```
Enter No. / Press Key
[Gp.D] (Browse⏪)
```

- 7** Display the number of the group to which you want to add a number (1 to 5).

Enter the group number with the number keys, or search using ⏪ or ⏩.



- 8** Press the **[OK]** key.

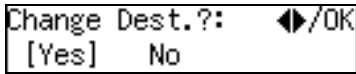

- 9** Press ⏪ or ⏩ to select "Yes".

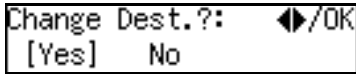

- 10** Press the **[OK]** key



Note

- ☐ If you have finished adding destinations, select "Exit" and go to step 11.

- 11** Press ⏪ or ⏩ to select "Add".



- 12** Press the **[OK]** key.



- 13** Specify the destination using one of the following three methods:

Enter the fax number with the number keys.

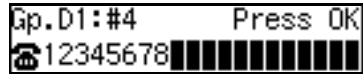

Press a Quick Dial key.

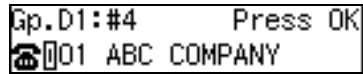

Press the **[Speed Dial]** key and enter a Speed Dial number.

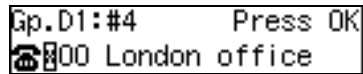

Note

- ☐ If you specify a Quick Dial or Speed Dial that is not programmed, "This key is Not Programmed" is displayed. Re-specify the destination.

- 14** Press the **[OK]** key.

The destination is added.

- 15** To add another destination, repeat steps 10 to 14.

- 16** If you have finished adding destinations, select "Exit".

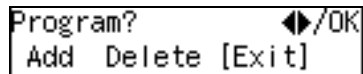

- 17** Press the **[OK]** key.



Note

- ☐ If you want to change the group name, press the **[Clear/Stop]** key and enter the new name.

- 18 Press the **[OK]** key.

```
Assign to Key? ◀/▶/OK
[Yes] No
```

- 19 Press **◀** or **▶** to select "Yes" if the group was programmed in a Quick Dial, or select "No" if it was not.

```
Assign to Key? ◀/▶/OK
[Yes] No
```

- 20 Press the **[OK]** key.

If you selected "No", go to step 2.

```
Press Quick Dial Key
[05]
```

Note

- If you want to edit a programmed Quick Dial, press the Quick Dial key, and then the **[OK]** key.

- 21 Press the **[OK]** key.

```
Program / Delete:
5.Prog. Group Dial ▶◀
```

If you want to add another destination to the group, go to step 6.

- 22 Press the **[User Tools]** key to return to standby mode.

Deleting

The following procedure describes how to delete a destination from a group.

- When you delete a destination from a group programmed in a Quick Dial or a Speed Dial, the contents of the Quick Dial or Speed Dial are not deleted.

To delete a destination from a group

- 1 Press the **[User Tools]** key.

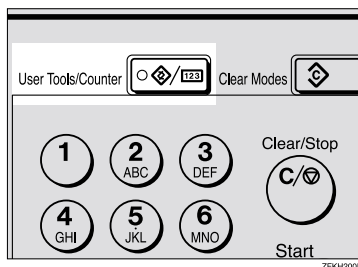

```
User Tools:
1.Counter ▶◀
```

- 2 Press **◀** or **▶** until "4. Fax Features" is displayed.

```
User Tools:
4.Fax Features ▶◀
```

- 3 Press the **[OK]** key.

```
Fax Features:
1.Program / Delete ▶◀
```

Confirm that "1. Program / Delete" is displayed.

- 4 Press the **[OK]** key.

- 5** Press **⏪** or **⏩** until " 5. Prog. Group Dial " is displayed.

```
Program / Delete:
5.Prog. Group Dial ◀▶
```

- 6** Press the **[OK]** key.

```
Enter No. / Press Key
[Gp.D] (Browse◀▶)
```

- 7** Display the group number for the destination you want to delete (1 to 5).

Enter the group number with the number keys, or search using **⏪** or **⏩**.

```
Program? ◀▶/OK
Gp.D1 Europe1
```

- 8** Press the **[OK]** key.

```
Change Dest.?: ◀▶/OK
[Yes] No
```

- 9** Press **⏪** or **⏩** to select "Yes".

```
Change Dest.?: ◀▶/OK
[Yes] No
```

- 10** Press the **[OK]** key.

```
Program? ◀▶/OK
[Add] Delete Exit
```

- 11** Press **⏪** or **⏩** to select "Delete".

```
Program? ◀▶/OK
Add [Delete] Exit
```

- 12** Press the **[OK]** key.

```
Select Destination
with ◀▶
```

- 13** Press **⏪** or **⏩** to display the destination you want to delete.

```
Delete? ◀▶/OK
000 London office
```

- 14** Press the **[OK]** key.

```
Program? ◀▶/OK
Add [Delete] Exit
```

To delete another destination, repeat steps **12** to **14**.

- 15** If you are finished deleting destinations, press **⏪** or **⏩** to select "Exit".

```
Program? ◀▶/OK
Add Delete [Exit]
```

- 16** Press the **[OK]** key.

```
Gp.D1 [ABC] /OK
[Europe1 ████████████████████]
```

- 17** Press the **[OK]** key.

```
Assign to Key? ◀▶/OK
[Yes] No
```

- 18** Press **⏪** or **⏩** to select "Yes" if the group was programmed in a Quick Dial, or select "No" if it was not.

```
Assign to Key? ◀▶/OK
[Yes] No
```

- 19** Press the **[OK]** key.

If you selected "No", go to step **14**.

```
Press Quick Dial Key
[005]
```

Note

- If you want to edit a programmed Quick Dial key, press the Quick Dial key and then the **[OK]** key.

- 20** Press the **[OK]** key to return to standby mode.

```
Program / Delete:
5.Prog. Group Dial
```

If you want to delete another destination from the group, go to step **6**.

- 21** Press the **[User Tools]** key to return to standby mode.

To delete an entire group

- 1** Press the **[User Tools]** key.

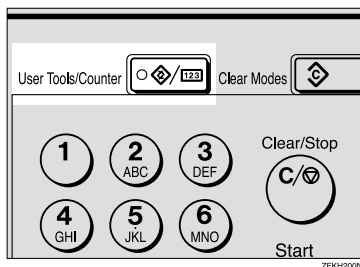

```
User Tools:
1.Counter
```

- 2** Press **⏪** or **⏩** until " 4. Fax Features " is displayed.

```
User Tools:
4.Fax Features
```

- 3** Press the **[OK]** key.

```
Fax Features:
1.Program / Delete
```

Confirm that " 1. Program / Delete " is displayed.

- 4** Press the **[OK]** key.

- 5** Press **⏪** or **⏩** until " 6. Del. Group Dial " is displayed.

```
Program / Delete:
6.Del. Group Dial
```

- 6** Press the **[OK]** key.

```
Enter No. / Press Key
[Gp.D] (Browse)
```

- 7** Display the number of the group you want to delete (1 to 5).

Enter the group number with the number keys, or search using **⏪** or **⏩**.

```
Delete?
Gp.D1 Europe1
```

- 8** Press the **[OK]** key.

The entire Group is deleted.

```
Program / Delete:
6.Del. Group Dial
```

- 9** Press the **[User Tools]** key to return to standby display.



 **To change and delete Quick Dials programmed as groups:**

To store an entire group under a different Quick Dial key, or to delete the group from the Quick Dial key altogether, perform the following procedure:

- 3**
- ① Press the **[User Tools]** key.
 - ② Press **⏪** or **⏩** until " 4. Fax Features " is displayed.
 - ③ Press the **[OK]** key.
 - ④ Press the **[OK]** key, and then press **⏪** or **⏩** to display "5. Prog. Group Dial".
 - ⑤ Press the **[OK]** key.
 - ⑥ Enter the group number (1 to 5).
 - ⑦ Press the **[OK]** key.
 - ⑧ Press **⏪** or **⏩** to select "No", and then press the **[OK]** key.
 - ⑨ Press the **[OK]** key.
 - ⑩ If you want to change the Quick Dial key, press "Yes", and if you want to delete the Quick Dial key, press "No".
 - ⑪ Press the **[OK]** key.
If you selected "No" in step ⑨, the Quick Dial key is deleted. Go to step ⑬.
 - ⑫ If you want to change the Quick Dial key, press the new Quick Dial key.
 - ⑬ Press the **[OK]** key.
The Quick Dial key is changed.
 - ⑭ Press the **[User Tools]** key to return to standby mode.
- 

Entering Characters

This section describes how to enter characters.

Available Characters

- Letters:
ABCDEFGHIJKLMNOPQRSTUVWXYZabcdefghijklmnopqrstuvwxyz
- Symbols:
- _ (space) . , () / @ & \$! ' # * % + : ; < = > ? ^ [] ` { | } ~
- Numbers:
0123456789

Keys

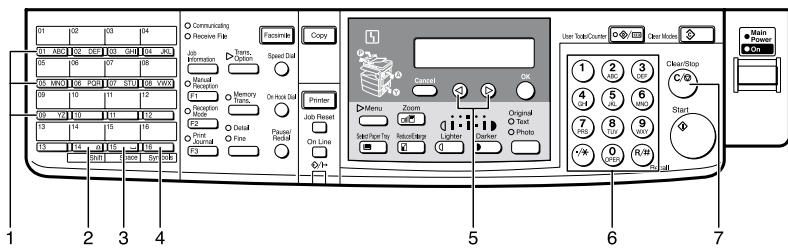

ZFKH220N

1. Quick Dial 01 to Quick Dial 09 (A to Z)

Press these keys to enter upper and lower case letters.

Every time you press the same Quick Dial key, one of the three letters printed on a Quick Dial key is displayed. For example, when you press Quick Dial 01, letters in display are changed A → B → C → A as you press the key. Press to move cursor and enter next one.

2. [Shift] key (Quick Dial 14)

Use to switch between upper and lower case.

3. [Space] key (Quick Dial 15)

Press to enter a space.

4. [Symbol] key (Quick Dial 16)

Press to enter symbols.

5. or

Use to move the cursor left or right and select the symbol.

6. Number keys

Use to enter numbers.

7. [Clear/Stop] key

Deletes a character at the cursor position. Even if the cursor is placed to the right of the character, you can delete a character at the right end of a line.

How to Enter Characters



The following procedure describes how to enter characters.

 **Note**

- When you enter a character, it is shown at the position of the cursor. If there is a character at the cursor position, the entered character is shown before the character.

1 Enter letters, symbols or numbers.

Characters are entered and the cursor moves.

- For letters, press the Quick Dial keys (01 to 09). When the desired letter is displayed, press .
- For symbols, press the **[Symbol]** key and  or  to select the symbol, and then press the **[OK]** key.
- For numbers, press the number key.

 **Note**

- When you make a mistake, press the **[Clear/Stop]** key.
- When you want to insert a character, move the cursor to the character right of the position you want to enter. Now the inserted character is shown left of the cursor position.

2 Press the **[OK]** key.

 **Wild Cards**

When you register other party's Own Name or Own Fax Numbers for multiple destinations, you can register a sequence of characters common to these identifications as a wild card instead of registering every identification.

If a destination has an Own Name or Own Fax Numbers containing a wild card, the machine determines that the destination matches the registered destination.

❖ Not using a wild card

Destination to be registered (Own Name)	Number of registered identifications
NEW YORK BRANCH HONG KONG BRANCH SYDNEY BRANCH	3

❖ Using a wild card

Destination to be registered (Own Name)	Number of registered identifications
BRANCH	1

 **Limitation**

- You can register up to 30 wild cards.

 **Note**

- Compare identifications by neglecting spaces.
- You can use wild cards for the following functions:
 - See Chapter 6 “Memory Lock” in the Advanced Features manual.
 - See Chapter 6 “Forwarding” in the Advanced Features manual.

4. Troubleshooting

Adjusting Volume

You can change the volume of the following sounds the machine makes.

- ❖ **On Hook**
Sounds when you press the **[On Hook Dial]** key.
 - ❖ **Transmission**
Sounds when the machine send a message.
 - ❖ **Reception**
Sounds when the machine receives a message.
 - ❖ **Dialing**
After pressing the **[Start]** key, this sound is made until the line connects to the destination.
 - ❖ **Key Tone**
Sounds when keys on the Control panel are pressed.
 - ❖ **Alarm**
The sound to signal something going amiss.
- 1** Press the **[User Tools]** key.

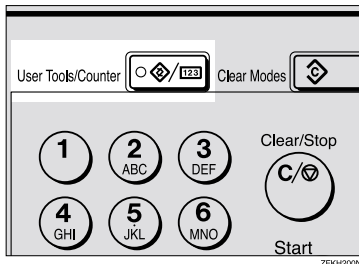

```
User Tools:
1.Counter
```

- 2** Press **[Left]** or **[Right]** until " 4. Fax Features " is displayed.

```
User Tools:
4.Fax Features
```

- 3** Press the **[OK]** key.

```
Fax Features:
1.Program / Delete
```

Confirm that " 1. Program / Delete " is displayed.

- 4** Press **[Left]** or **[Right]** until " 3. Setup " is displayed.

```
Fax Features:
3.Setup
```

- 5** Press the **[OK]** key.

Confirm that " 1. Monitor Volume " is displayed.

```
Setup:
1.Monitor Volume
```

- 6** Press the **[OK]** key.

```
Monitor Volume:
1.On Hook
```

- 7** Press **[Left]** or **[Right]** to select the item you want to adjust, and then press the **[OK]** key.

```
On Hook:
Low-1-----High
```

- 8 Press ◀ or ▶ to adjust the volume.



- 9 Press the [OK] key.

The volume is adjusted.

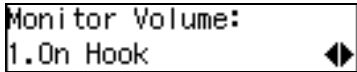

If you want to adjust another item, repeat steps 7 to 9.

- 10 Press the [User Tools] key to return to standby display.

Error Messages

If there is an error, one of the following messages may appear on the display. It might just flash up briefly, so if you are watching for errors, stay by the machine and check the display.

Message	Problem and Solution
Clear Misfed Orig. Remove original from ADF Cover	Original misfeed Remove originals from the Document Feeder. Set any pages of the original that were not scanned and send again.
	A document jam occurred during Immediate Transmission. Press the [OK] key, and then resend the page which has not been sent.
	An error occurred during Immediate Transmission. Press the [OK] key, and then resend the original. Note <input type="checkbox"/> There may be a problem with the machine or the telephone line (for example noise or cross talk). If the error re-occurs frequently, contact your service representative.
Reset Original(s) and press Start	Original jammed during Memory Transmission. Reset originals that have not been scanned.
Memory is Full.Storing Stopped.	After you press the [OK] key, you can select whether to transmit pages which have been stored in memory or to delete those pages. Check the number of transmitted pages on the Communication Result Report when you select to transmit those pages.
Exceeded the Max.Cannot Add	You cannot dial any more numbers. When these files have been sent and their fax numbers are deleted from memory, additional fax numbers can be dialed.

When the **【Facsimile】** key is Lit in Red





When the **【Facsimile】** key is lit in red while machine is in Copy mode, press the **【Facsimile】** key and read the message.

If **4** is lit, refer to the table below and take the appropriate action.

Problem	Solution
Paper has run out.	Add paper. See Chapter 3 “Loading Paper” in the Copy Reference.
A facsimile error has occurred.	The facsimile has a problem. Contact a service representative. The copier function will still work normally.











When the Receive File Indicator is Lit

If the **Receive File** indicator is lit, a message has been received but could not be printed for some reason. The message was stored in memory (Substitute Reception). When you solve the problem, the message will be automatically printed out. The table below lists some problems that could have caused Substitute Reception to take place and their solutions.

Why Substitute Reception Occurred	Indication/Status	Solution
Paper has run out	 is lit red.	Add paper. See Chapter 3 “Loading Paper” in the Copy Reference.
Toner is empty	 is lit red.	Replace the toner cartridge. See Chapter 3 “Changing the Toner Cartridge” in the Copy Reference. Note <input type="checkbox"/> Even if there is no toner left, you can still send fax messages.
Paper is jammed	 is lit red.	Remove the jammed paper. See Chapter 3 “Clearing Misfeeds” in the Copy Reference.
Cover is open	 is lit red.	Close the cover. A cover other than the Document Feeder or front cover is open.
Machine is busy printing with other function	The machine is printing with other function.	The message will be printed after the current job finishes automatically.

Solving Problems

This table lists some common problems and their solutions.

Problem	Required Action
Image background appears dirty when a fax is received at the other end.	Adjust the scan density.  Reference See p.25 "Image Density (Contrast)"
Printed or sent image contains spots.	The Document Feeder (ADF) or exposure glass is dirty, clean them. Make sure that ink or eraser is dry before setting the original.  Reference See Chapter 5 "Maintaining Your Machine" in the Copy Reference
Received image is too light.	Request the sender to increase the image density. When using moist, rough or processed paper, the printed image may be partly invisible. Only use recommended paper.  Reference See Appendix, "Originals" in the Advanced Features manual. When  appears on the display, toner is beginning to run out. Replace the toner cartridge soon.  Reference See Chapter 3 "Changing the Toner Cartridge" in the Copy Reference.
Message appears blank at the other end.	The original was set upside down. Set it properly.  Reference See p.13 "Setting Originals"
You want to cancel a Memory Transmission.	If the original is being stored, press the [Clear/Stop] key.  Reference See p.19 "Canceling a Memory Transmission" If the original is being sent, use "Cancel TX/RX" in the Job Information menu.  Reference See Chapter 2 "Canceling Transmission or Reception" in the Advanced Features manual.
You want to cancel an Immediate Transmission.	Press the [Clear/Stop] key.  Reference See p.23 "Canceling an Immediate Transmission"
You cannot add any destination in Group, even though it does not reach the maximum number.	67 destinations have been programmed with the number keys. Program more numbers with Quick Dials or Speed Dials.  Reference See p.49 "Groups"

INDEX

A

- ADF→Document Feeder, 2
- Adjusting Volume
 - Alarm*, 61
 - Dialing*, 61
 - Key Tone*, 61
 - On Hook*, 61
 - Reception*, 61
 - Transmission*, 61
- Advanced Features, v
- Auto Receive, 31
- Auto Select, 31

B

- Basic Features (this manual), v
- Bypass Tray, 3

C

- Cancel key, 4
- Changing Modes, 8
- Characters
 - Available Characters*, 59
 - Entering*, 59
 - Keys*, 59
- Clear Modes key, 4
- Clear/Stop key, 4
- Communicating Indicator, 4
- Components, 2
- Control Panel, 4
- CSI→Own Fax Number, 33

D

- Deleting
 - Groups*, 55
 - Quick Dial*, 41
 - Speed Dial*, 47
- Detail, 24
- Dialing, 26
 - Entering Numbers Directly*, 26
 - Using Groups*, 29
 - Using Quick Dials*, 27
 - Using Speed Dials*, 28
- Dial label, 42
- Display, 9
- Document Feeder (ADF), 2, 14

E

- Editing
 - Fax Header*, 35
 - Groups*, 52
 - Own Fax Number*, 35
 - Own Name*, 35
 - Quick Dial*, 40
 - Speed Dial*, 46
- Entering Characters, 59
- Error Messages, 63
- Exposure Glass, 2, 14
- Exposure Glass Cover, 2
- External Telephone Connector, 3

F

- Facsimile key, 4, 8, 64
- Fax Header, 33
 - Editing*, 35
 - Registering*, 34
- Faxing, 11
- Fine, 24
- Front View, 2

G

- G3 Line Connector, 3
- Getting Started, 1
- Group Name, 52
- Groups, 29, 49
 - Deleting*, 55
 - Dialing*, 29
 - Editing*, 52
 - Registering*, 49

H

- Handset, 2
- How to Read this Manual, iv

I

- Image Density (Contrast), 24, 25
- Image Density key, 5
- Immediate Transmission, 11, 21
 - Canceling*, 23
- Indicator, 4

J

- Job Information key, 4

L

LCD display, 4

M

Machine Types, 1
Main Power Indicator, 4
main power switch, 2
Manual Receive, 31
Manuals for This Machine, v
Memory Trans. key, 5
Memory Transmission, 11, 16
 Canceling, 19

N

NOTICE, i
Number keys, 5
 Dialing, 26

O

OK key, 4
On Hook Dial key, 5
On Indicator, 4
Operation switch, 3, 5
Original Type, 24, 25
Original Type key, 5
Own Fax Number, 33
 Editing, 35
 Registering, 34
Own Name, 33
 Editing, 35
 Registering, 34

P

Paper Tray, 3
Paper Tray Unit, 3
Pause, 27
Pause/Redial key, 5
Photo, 25

Q

Quick Dial, 38
 Deleting, 41
 Dialing, 27
 Dial label, 42
 Editing, 40
 Registering, 38
Quick Dial keys, 4

R

Receive File Indicator, 4, 65
Reception Mode
 Selecting, 31
Reception Modes
 Auto Receive, 31
 Auto Select, 31
 Manual Receive, 31
Registering
 Fax Header, 33
 Groups, 49
 Own Fax Number, 33
 Own Name, 33
 Quick Dial, 38
 Speed Dial, 44
Resolution, 24
Resolution key, 5
RTI→Own Name, 33

S

Scan Settings, 24
Setting Originals, 13
Side View, 3
Solving Problems, 66
Speed Dial, 44, 46, 47
 Deleting, 47
 Dialing, 28
 Editing, 46
 Registering, 44
Speed Dial key, 4
Standard, 24
Starting the Machine, 6
Start key, 5
Substitute Reception, 65

T

Text, 25
Tone, 27
Transmission Modes, 11
Transmission Option key, 4
Troubleshooting, 61
TTI→Fax Header, 33

U

User Function Keys, 5
User Tools key, 4

V

Volume, 61

W

Wild Cards, 60

MEMO

MEMO

MEMO

How to Read this Manual

Symbols

In this manual, the following symbols are used:

WARNING:

This symbol indicates a potentially hazardous situation that might result in death or serious injury when you misuse the machine without following the instructions under this symbol. Be sure to read the instructions, all of which are described in the Safety Information section in the Copy Reference manual.

CAUTION:

This symbol indicates a potentially hazardous situation that might result in minor or moderate injury or property damage that does not involve personal injury when you misuse the machine without following the instructions under this symbol. Be sure to read the instructions, all of which are described in the Safety Information section in the Copy Reference manual.

* The statements above are notes for your safety.

Important

If this instruction is not followed, paper might be misfed, originals might be damaged, or data might be lost. Be sure to read this.

Preparation

This symbol indicates the prior knowledge or preparations required before operating.

Note

This symbol indicates precautions for operation, or actions to take after misoperation.

Limitation

This symbol indicates numerical limits, functions that cannot be used together, or conditions in which a particular function cannot be used.

Reference

This symbol indicates a reference.

[]

Keys built into the machine's operation panel.

Manuals for This Machine

Two Facsimile Reference manuals are provided, the Basic Features manual and the Advanced Features manual. Please refer to the manual that suits your needs.

Advanced Features (this manual)

The Advanced Features manual describes more advanced functions and also explains settings for key operators.

Basic Features

The Basic Features manual explains the most frequently used fax functions and operations.

❖ Chapter 1 Getting Started

Names and describes the parts of the control panel and machine.

❖ Chapter 2 Faxing

Explains basic transmission. You can also learn about other types of transmissions.

❖ Chapter 3 Registering

Explains how to make initial settings, such as the Own Name and Own Fax Number settings. Also explains the Quick Dial, Speed Dial and Group keys. These keys allow you to store numbers and save time when dialing. This chapter also explains how to enter letters and symbols.

❖ Chapter 4 Troubleshooting

Explains how to adjust the volume of sounds generated by the machine and how to interpret error messages. When the display or indicator lights show unusual information, check the list and take appropriate action.

TABLE OF CONTENTS

1. Transmission Options

Sending at a Specific Time (Send Later)	1
Fax Header Print	3
Label Insertion	4
Calling to Request a Message (Polling Reception)	5
File Reserve Report (Polling RX)	7
Communication Result Report (Polling RX)	7

2. Job Information

Canceling Transmission or Reception	9
Printing a List of Files in Memory (Print File List)	10
Printing a Stored Message (Print TX File)	11
Printing a Memory-locked Message	12
Printing the Journal	13
Report Formats	14

3. Other Transmission Features

Handy Dialing Functions	15
Chain Dial.....	15
Telephone Directory.....	16
Redial	16
On Hook Dial	17
Manual Dial	18
Transmission Features	19
SEP Code	19
SUB Code	20
More Transmission Functions	22
If Memory Runs Out While Storing an Original	22
Checking the Transmission Result.....	22
Broadcasting Sequence	23
Sending a Fax Message Immediately	23
Broadcasting : Checking Progress.....	23
Automatic Redial	23
Batch Transmission.....	23
Dual Access	24
ECM (Error Correction Mode)	24
Parallel Memory Transmission.....	24

Printed Reports.....	25
File Reserve Report (Switch 03, Bit 2)	25
Communication Result Report (Switch 03, Bit 0)	25
Communication Failure Report (Switch 03, Bit 0)	25
Transmission Result Report (Immediate Transmission) (Switch 03, Bit 5) ...	26

4. Reception Features

General	27
Immediate Reception	27
Memory Reception	27
Printing Documents that have been Received into Memory (Substitute Reception)...	28
Receiving Messages in Telephone Mode	29
Auto Fax Reception Power-up	29
Printing Options	30
Center Mark	30
Checked Mark.....	30
TSI Print	30
Reception Time	31
Page Separation and Length Reduction	31
When There is No Paper of the Correct Size	32

5. Facsimile User Tools

User Function Keys.....	35
Functions You Can Assign to User Function Keys	35
Making a User Function Key Assignment	36
Using a User Function Key	37
Deleting a User Function Key	37
Printing Reports/Lists	39
Adjusting the Display Contrast.....	42
Setting the Date and Time	43
Setting the Auto Ring Time	45
Setting the Fax Reset Timer	46
On Hook Timeout.....	47

6. Key Operator Settings

Function List	49
Using Key Operator Settings	50
Memory Lock.....	50
Forwarding	52
User Parameters	58
Personal Codes.....	63
ID Code	66
Line Type	67
PSTN Access Number	68
Memory File Transfer	69
RDS (Remote Diagnostic System).....	70

7. Troubleshooting

Reading Reports	71
Error Report	71
Power Failure Report	71

8. Appendix

Connecting to a Telephone Line and a Telephone	73
Connecting the Optional Handset and an External Telephone	74
Specifications	75
Base Machine	75
Available Options	76
Originals	76
Maximum Values	78
Advanced Transmission Features	79
Job Information	80
User Tools	81
Key Operator Tools	83
INDEX	84

1. Transmission Options

Sending at a Specific Time (Send Later)

Using the Send Later function, you can delay transmission of your fax message until a specified time. This allows you to take advantage of off-peak telephone line charges without having to be by the machine at the time of transmission.

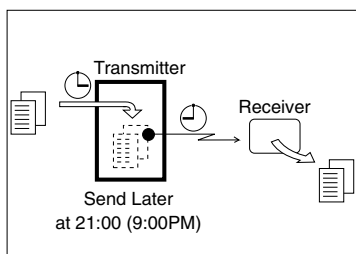

Note

- You can not specify a time more than 24 hours later.
- This function is only available with Memory Transmission.

1 Make sure that the machine is in Facsimile mode and the standby display is shown.

```
Ready 100% 10:20AM
Set Orig. / Enter No.
```

2 Place your original and select any scan settings you require.

3 Press the [Transmission Option] key.

```
Trans. Option:
1.Send Later
```

4 Confirm that " 1. Send Later " is displayed.

5 Press the [OK] key.

6 Press ⏪ or ⏩ to select "On".

```
Send Later:  ⏪/OK
[On] Off
```

7 Press the [OK] key.

8 Press ⏪ or ⏩ to select "AM" or "PM".

```
Send Later:  ⏪/OK
Time AM [PM]
```

9 Press the [OK] key.

10 Enter the time that you want to send the fax message with the number key.

```
Send Later:  Press OK
Time [ 9:00] PM
```

Enter the hour setting (1 to 12). Then press ⏪ or ⏩.

Then enter a 2-digit number for the minute setting (00 to 59).

Note

- When entering numbers smaller than 10, add a leading zero.
- If you make a mistake, press the [Clear/Stop] key and try again.
- If the current time shown on the display is not correct, change it. See p.43 "Setting the Date and Time".

11 Press the **[OK]** key.

The specified time is set.

12 Specify the destination.

If you want to specify another destination, press the **[OK]** key and repeat step 12.

13 Press the **[Start]** key.

 **Note**

- You can cancel a message transmission set for Send Later. See p.9 "Canceling Transmission or Reception".

Fax Header Print

Normally, the Fax Header programmed in your machine is printed at the top of each of the pages you transmit when they are received at the other end. The top of the image will be overprinted if there is no margin at the top of the transmitted page.

Important

- ❑ In the USA, this must contain the telephone number of the line your machine is connected to. It will be printed on the header of every page you send. Required in the USA.

Note

- ❑ In the USA, law requires that your fax number be included in the Fax Header. Register the fax number and switch on Fax Header Print with the User Parameters. See p.58 "User Parameters" (Switch06, Bit0)

- 1** Make sure that the machine is in Facsimile mode and the standby display is shown.

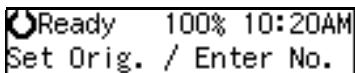

Ready 100% 10:20AM
Set Orig. / Enter No.

- 2** Place your original, and then select any scan settings you require.

- 3** Press the **[Transmission Option]** key.
The Transmission Option menu appears.

- 4** Press **◀** or **▶** until "2. Fax Header Print" is displayed.

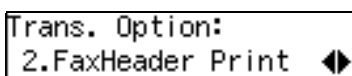

Trans. Option:
2. FaxHeader Print ▶

- 5** Press the **[OK]** key.

- 6** Press **◀** or **▶** to select "On".

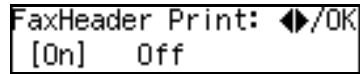

FaxHeader Print: ▶/OK
[On] Off

- 7** Press the **[OK]** key.

- 8** Press the **[Transmission Option]** key.

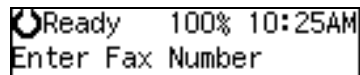

Ready 100% 10:25AM
Enter Fax Number

- 9** Specify the destination.

If you want to specify another destination, press the **[OK]** key and repeat step 9.

- 10** Press the **[Start]** key.

Label Insertion

1

With this function, you can have the receiver's name programmed in Quick Dial or Speed Dial printed on the message when it is received at the other end. The name will be printed at the top of the page and will be preceded by "To".

If you program the Label Insertion function in a Quick Dial or Speed Dial, the function is enabled when you select "On". This function cannot be used if the other party's name is not programmed.

If you select the Label Insertion function then enter your personal code, your personal code will also appear on the page. "From" is automatically inserted before your personal code. This function is available when personal code is registered and the Restricted Access is turned on.

Note

- You can set this function for each destination.

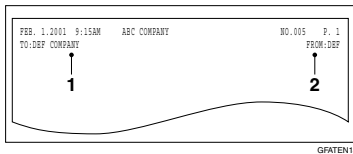

1. Name that is registered in the Quick Dial or Speed Dial key.

2. Name that is assigned to the Personal Code.

Reference

To program the Label Insertion function in the Quick Dial, see Chapter 3 "Quick Dial" in the Basic Features manual.

To program the Label Insertion function in the Speed Dial, see Chapter 3 "Speed Dial" in the Basic Features manual.

For details about Personal Codes, see p.63 "Personal Codes".

Calling to Request a Message (Polling Reception)

Use this function if you want to poll a message from another terminal. You can also poll documents from many terminals.

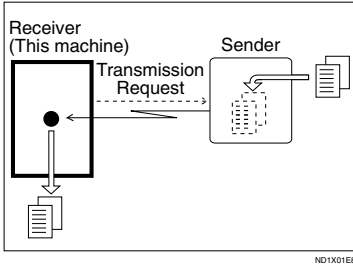

There are two types of Polling Reception:

◆ Secured Polling Reception

If the Polling ID is programmed in your machine, any messages waiting in the transmitting machine with the same ID are received. If the other machine does not have any messages waiting with the same Polling ID, any messages that do not require an ID are received (Free Polling).

◆ Stored ID Override Polling Reception

You must enter an Override Polling ID unique to this transmission. This ID overrides the Polling ID. Your machine will receive any messages waiting in the transmitting machine with matching ID's. If no ID's match, any messages that does not require an ID are received (Free Polling).

! Limitation

- Polling Reception requires that the other machine can perform Polling Transmission.
- To receive a message sent by any Secured Polling Transmission or Stored ID Override Polling Transmission, it is necessary to specify the same Polling ID as the sender's.
- To receive a message sent by Secured Polling Transmission or Stored ID Override Polling Transmission, the sender must be a machine of the same manufacturer and equipped with the Polling Reception function.

✎ Note

- The communication fee is charged to the receiver.

- 1** Make sure that the machine is in Facsimile mode and the standby display is shown.

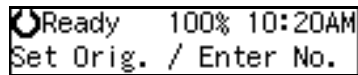

- 2** Press the **[Transmission Option]** key.

- 3** Press **[OK]** or **[Left Arrow]** until "3. Polling RX" is displayed.

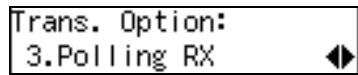

- 4** Press the **[OK]** key.

- 5** Press **[Left]** or **[Right]** to select "On".

```

Polling RX:      ◀/OK
[On]   Off
    
```

- 6** Press the **[OK]** key.

- 7** Select the type of Polling Reception.

Secured Polling Reception

- 1** Press **[Left]** or **[Right]** to select "Default".

```

Polling RX:      ◀/OK
[Default] Override
    
```

Stored ID Override Polling Reception

- 1** Press **[Left]** or **[Right]** to select "Override".

```

Polling RX:      ◀/OK
Default [Override]
    
```

- 2** Press the **[OK]** key.

```

Polling RX:
Override ID [■■■■]
    
```

- 3** Enter the Polling ID (4 digits) with the number keys or Quick Dial keys.

```

Polling RX:   Press OK
Override ID [1234]
    
```

Note

- You can enter A to F by the Quick Dial keys.
- You can enter 0 to 9 by the number keys.
- 0000 and FFFF can not be entered.

If you make a mistake, press the **[Clear/Stop]** key and try again.

- 8** Press the **[OK]** key.

- 9** Specify the other party's fax number.

- 10** Press the **[Start]** key.

⚙️ Polling Documents from Other Manufacturer's Fax Machines:

Standard Polling Reception only works with machines of the same manufacturer that have the Polling Reception function. However, if the other party's fax machine supports SEP Code Polling Reception, you can receive documents from them using SEP Code. (See p.19 "SEP Code".)

File Reserve Report (Polling RX)

This report is printed after Polling Reception has been set up.

You can check the date and time, Fax Header, File No., Transmission condition and the Other party's name with this report.

Note

- You can turn this function on or off with the User Parameters. See p.58 "User Parameters" (Switch03, Bit3).

Communication Result Report (Polling RX)

This report is printed after a Polling Reception has been completed and shows the result of the Polling Reception.

You can check the date and time, Other party's name and result with this report.

Note

- You can also check the result of a Polling Reception with the Journal.
- You can turn this function on or off with the User Parameters. See p.58 "User Parameters" (Switch03, Bit4).

2. Job Information

Canceling Transmission or Reception

Transmission files are originals that have been stored in memory and are awaiting transmission. The functions that produce transmission files are Memory Transmission and Polling Reception.

If you notice an error in the destination specified or the document content after scanning a document into memory, you can cancel transmission of that document. This is done by searching for the document in the fax machine's memory and deleting it.

Note

- You can cancel Memory Transmission even while files are being sent. However, any pages that have already been sent cannot be canceled.
- To cancel transmission in progress, press the **[Clear/Stop]** key.
- You can print out a File List to confirm the transmission files stored in memory.

Reference

For details about Memory Transmission and Polling Reception, see Chapter 2 "Memory Transmission" in the Basic Features manual, and p.5 "Calling to Request a Message (Polling Reception)".

- 1** Make sure that the machine is in Facsimile mode and the standby display is shown.

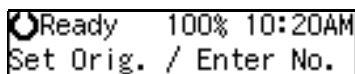

Ready 100% 10:20AM
Set Orig. / Enter No.

- 2** Press the **[Job Information]** key.

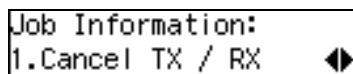

Job Information:
1.Cancel TX / RX

Confirm that " 1. Cancel TX / RX " is displayed.

- 3** Press the **[OK]** key.

- 4** Display the file you want to cancel.

To display the file, enter the file number with the number keys or press \leftarrow or \rightarrow until the file number is displayed.

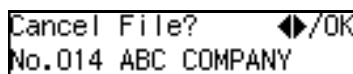

Cancel File? \leftarrow /OK
No.014 ABC COMPANY

Note

- If you make a mistake, press the **[Cancel]** key and try again.
- If you cannot find the file you want to cancel, the document has already been sent.

- 5** Press the **[OK]** key.

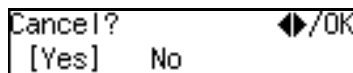

Cancel? \leftarrow /OK
[Yes] No

- 6** Confirm that you have selected the correct file, and press the **[OK]** key.

" Trans. Cancelled File Deleted " is displayed, and the machine returns to the standby display.

Printing a List of Files in Memory (Print File List)

Print this list if you wish to find out which files are stored in memory and what their file numbers are. Knowing the file number can be useful (for example when erasing files).

Note

- The contents of an original stored in memory can also be printed. See p.11 "Printing a Stored Message (Print TX File)".

- 1** Make sure that the machine is in Facsimile mode and the standby display is shown.

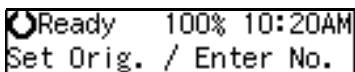

Ready 100% 10:20AM
Set Orig. / Enter No.

- 2** Press the **[Job Information]** key.

- 3** Press **[Left]** or **[Right]** until "2. Print File List" is displayed.

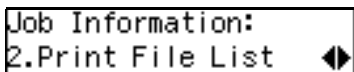

Job Information:
2.Print File List ◀▶

- 4** Press the **[OK]** key.

- 5** Press the **[Start]** key.

The File List is printed out and the machine returns to the standby display.

Printing a Stored Message (Print TX File)

If you wish to check the contents of a fax that is stored in memory and has not been sent yet, use this procedure to print it out.

- 1 Make sure that the machine is in Facsimile mode and the standby display is shown.

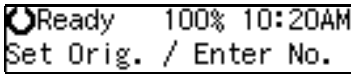

Ready 100% 10:20AM
Set Orig. / Enter No.

- 2 Press the **[Job Information]** key.

The Information menu is shown.

- 3 Press **[Left]** or **[Right]** until "3. Print TX File" is displayed, and then press the **[OK]** key.

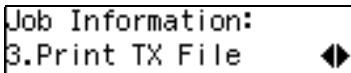

Job Information:
3.Print TX File →

- 4 Display the file you want to print.

The registered name or fax number appears on the lower line.

Note

- Enter the file number with the number keys or search using **[Left]** or **[Right]**.
- If you make a mistake, press the **[Cancel]** key and try again.

- 5 Press the **[OK]** key.

- 6 Press the **[Start]** key.

The document is printed and the machine returns to the standby display.

Printing a Memory-locked Message

This is a security function that prevents unauthorized individuals from reading printed messages. If Memory Lock is switched on, all received messages are stored in memory and are not automatically printed. To print the messages, you have to enter the Memory Lock ID code. When your machine has received a message with Memory Lock, the "Receive File" indicator flashes. See p.50 "Memory Lock" .

Note

- Before you start, register your Memory Lock ID. (See p.66 "ID Code".)
- Messages received by Polling Reception are automatically printed even if this function is switched on.
- If the main power switch is turned off for more than 12 hours, all messages protected by Memory Lock are deleted. If this happens, use the Power Failure Report to identify which messages have been lost. (See p.71 "Power Failure Report".)

- 1** Make sure that the machine is in Facsimile mode and the standby display is shown.

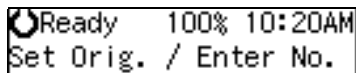

Ready 100% 10:20AM
Set Orig. / Enter No.

- 2** Press the **[Job Information]** key.

- 3** Press **[Left]** or **[Right]** until "4. Print Mem. Lock" is displayed.

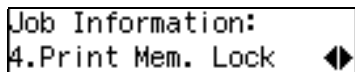

Job Information:
4. Print Mem. Lock ◀▶

- 4** Press the **[OK]** key.

- 5** Enter the Memory Lock ID (4 digits) with the number keys.

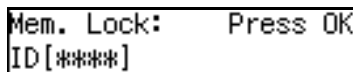

Mem. Lock: Press OK
ID [****]

The Memory Lock ID you entered is not displayed.

- 6** Press the **[OK]** key.

- 7** Press the **[Start]** key.

The document is printed out and the machine returns to standby mode.

Printing the Journal

When automatic communication report printing is turned on, the Journal is printed automatically after every 50 communications (receptions + transmissions). You can also print a copy of the Journal at any time by following the procedure below.

Note

- The sender's name column of the Journal is useful when you need to register a Specified Sender.
- If you do not want the Journal to be printed automatically, you can turn automatic printing off. See p.58 "User Parameters" (switch 03, bit 7).

1 Make sure that the machine is in Facsimile mode and the standby display is shown.

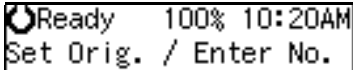

```

Ready 100% 10:20AM
Set Orig. / Enter No.
  
```

2 Press the **[Job Information]** key.

3 Press **⏪** or **⏩** until "5. Print Journal" is displayed.

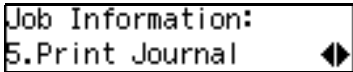

```

Job Information:
5. Print Journal  ◀▶
  
```

4 Press the **[OK]** key.

5 Press the **[Start]** key.

The report is printed and the machine returns to the standby display.

Report Formats

* * * JOURNAL (OCT. 10. 2001 11:07 AM) * * *

FAX HEADER:MAIN OFFICE

(MANUAL PRINT)

Transmission details appear here

Reception details appear here

TX 0000001 # :BATCH @ :FORWARDING E :ECM F :FINE	RX 0000002 M :MEMORY TX L :SEND LATER S :STANDARD D :DETAIL
---	---

ZF0K02300N

1. The Mode Column

Codes and alphabet on this column inform the type of communication. These codes are explained on the bottom of the report.

2. The Result Column

OK: Successful communication
 E: An error occurred
 D: Power Failure

3. The Footnote on the Journal

Transmission counter: Total number of transmitted pages
 Reception counter: Total number of received pages

3. Other Transmission Features

Handy Dialing Functions

Chain Dial

This function allows you to compose a telephone number from various parts, some of which may be registered in Quick Dials or Speed Dials and some of which may be entered using the number keys.

You can program commonly used area or country codes into Speed Dials or Quick Dial keys.

Example: 01133-1-5551234 (From the United States to Paris).

Assume that the following Quick Dial and Speed Dial numbers have already been programmed.

- Quick Dial **[03]** = 01133 (Overseas to France)
- Quick Dial **[02]** = 1 (Paris)
- Speed Dial **[0][1]** = 5551234

Limitation

- Maximum length of telephone or fax number: 254 digits

Note

- For Memory Transmission and Immediate Transmission, insert a pause between numbers. For On Hook Dial and Manual Dial, no pause is needed.

Reference

For registering fax numbers to Speed Dials or Quick Dial keys, See Chapter 3 "Speed Dial" or "Quick Dial" in the Basic Features manual.

- 1 Set your original and select any scan settings you require.

- 2 Press Quick Dial key **[03]**.

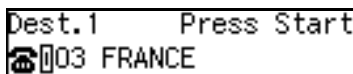

Dest.1 Press Start
☎ 01133 FRANCE

- 3 Press the **[Pause/Redial]** key.

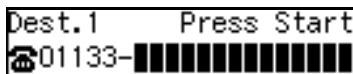

Dest.1 Press Start
☎ 01133- [|||||]

- 4 Press Quick Dial key **[02]**.

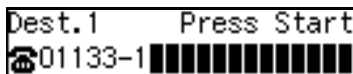

Dest.1 Press Start
☎ 01133-1 [|||||]

- 5 Press the **[Pause/Redial]** key.

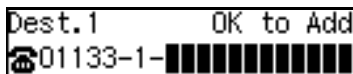

Dest.1 OK to Add
☎ 01133-1- [|||||]

- 6 Press the **[Speed Dial]** key, and then press **[0][1]**.

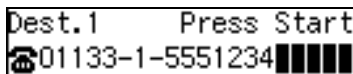

Dest.1 Press Start
☎ 01133-1-5551234 [|||||]

If you want to send the same fax to another party, press the **[OK]** key and repeat the above steps from step 2.

- 7 Press the **[Start]** key.

Telephone Directory

This function lets you find a registered Speed Dial quickly by just entering a single letter, for example, the first letter of the name registered for that number.

! Limitation

- Speed Dial codes cannot be searched for by symbol or number.
- Names enclosed within brackets are not searched.

1 Set your original, and then select any scan settings you require.

2 Press the **[Speed Dial]** key.

3 Enter the search letter by pressing one of the Quick Dial keys (A to Z).

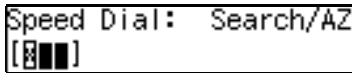

📝 Note

- The names or fax numbers registered in Speed Dials are shown in numerical order on the display.

4 Press **⏪** or **⏩** until the destination you are searching for is displayed, and then press the **[OK]** key.



📝 Note

- If you make a mistake, press the **[Cancel]** key and try again.
- If you wish to dial another destination, press the **[OK]** key and dial another fax number.

5 Press the **[Start]** key.

Redial

The machine can recall the last 10 destinations that have been dialed. If you wish to send a message to a destination which you faxed recently, the Redial function saves you from finding and entering the number again.

1 Place your original and select any scan settings you require.

2 Press the **[Pause/Redial]** key.

3 Press **⏪** or **⏩** until the destination you want to redial is displayed.

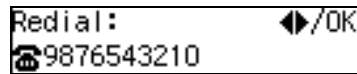

4 Press the **[OK]** key.

5 Press the **[Start]** key.

! Limitation

- The following kinds of destinations can not be recalled.
 - Quick Dials
 - Speed Dials
 - Group Dials
 - Any destinations if multiple destinations were dialed
 - Destinations dialed by Redial (regarded as already memorized)

On Hook Dial

You can send a fax message without lifting the receiver, while still listening to the dial tone.

If the other party has a telephone fax machine, you can talk by lifting the receiver after your machine has connected to theirs.

Reference

See Chapter 4 "Adjusting Volume" in the Basic Features manual.

1 Place your original, and then select any scan settings you require.

2 Press the **[On Hook Dial]** key.

You will hear a tone from the internal speaker. If you wish to cancel this operation, press the **[On Hook Dial]** key again.



3 Dial.



On Hook:  
 123456789 

The machine immediately dials the destination. If you make a mistake, press the **[On Hook Dial]** key and return to step **2**.

Note

You can change the volume of sound with  or .

4 When the line is connected and you hear a high-pitched tone, press the **[Start]** key.

When the originals are placed on Document Feeder (ADF), the machine starts transmitting the originals. The display will be that shown for step **5**.

Note

If you hear a voice, pick up the external telephone before you press the **[Start]** key and notify the destination that you want to send a fax message (ask them to switch to Facsimile mode).

5 When the originals are not placed on the Document Feeder, press  or  to select "Send".

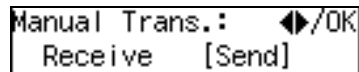

Manual Trans.: /OK
 Receive [Send]

6 Press the **[OK]** key.

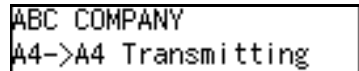

ABC COMPANY
 A4->A4 Transmitting

The originals are transmitted.

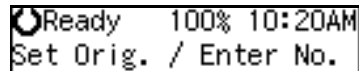

 Ready 100% 10:20AM
 Set Orig. / Enter No.

After transmission, the machine will return to standby mode.

Manual Dial

The external telephone is required.

You can send a fax message using an external telephone.

 **Note**

- The result of transmission with manual dial is not mentioned in the Transmission Result Report (Immediate Transmission).

3

1 Place your original, and then select any scan settings you require.

2 Pick up the external telephone.

You will hear a tone.

3 Dial.

If you make a mistake, replace the external telephone and try again from step **2**.

4 When the line is connected and you hear a high-pitched tone, press the **[Start]** key to send your fax message.

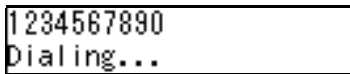

1234567890
Dialing...

 **Note**

- If the other party answers the phone, inform them that you are sending a fax.

5 Replace the handset of the external telephone.

After transmission the machine will return to standby mode.

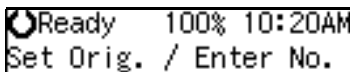

Ready 100% 10:20AM
Set Orig. / Enter No.

Transmission Features

SEP Code

If you want to receive a message stored in the memory of another party's fax machine, use this function. The machine will receive the message with the SEP and PWD code that matches the SEP and PWD code you enter in the following procedure.

Preparation

You need to assign the Dial Option function to a User Function key beforehand. See p.35 "User Function Keys".

Note

- The ID can be up to 20 digits long and consist of digits.
- Make sure the ID matches the other terminal of the fax you are receiving from.
- You can store IDs in Quick Dials, Speed Dials, and Groups.
- Messages you receive using this function are marked "SEP" on all reports.
- When you send a fax message with SEP Code to other makers' machines, sometimes a password (PWD) is necessary. Use PWD when it is necessary.

- 1** Dial the destination fax number using the number keys.

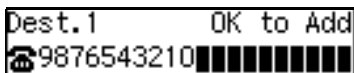

- 2** Press the **[User Function]** key assigned with the Dial Option function.

- 3** Press **[Left]** or **[Right]** until " 2. SEP " is displayed.

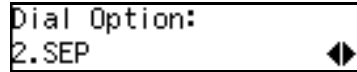

- 4** Press the **[OK]** key.

- 5** Enter the SEP code with the number keys.



- 6** Press the **[OK]** key.

When a password (PWD) is necessary

- 1** Press the **[User Function]** key assigned with the Dial Option function.

- 2** Press **[Left]** or **[Right]** until " 4. PWD " is displayed.

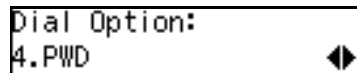

- 3** Press the **[OK]** key.

- 4** Enter the PWD code with the number keys.



- 5** Press the **[OK]** key

- 7** Press the **[Transmission Option]** key.

- 8** Press **◀** or **▶** until "3. Polling RX" is displayed.

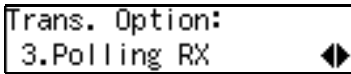

- 9** Press the **[OK]** key.

- 10** Press **◀** or **▶** to select "On".

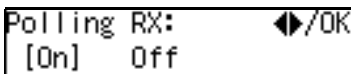

- 11** Press the **[OK]** key.

- 12** Press **◀** or **▶** to select "Default".

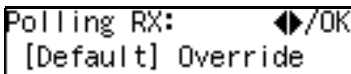

- 13** Press the **[OK]** key.

- 14** Press the **[Start]** key.

SUB Code

If the other party's machine has functions like Transfer Request and Confidential Transmission with SUB/SID Code, you can use those functions with SUB/SID Code.

Preparation

You need to assign the Dial Option function to a User Function key beforehand. See p.35 "User Function Keys".

Note

- The ID can be up to 20 digits long and consist of numbers, spaces, **【#】** and **【*】**.
- Make sure the ID matches the specification of the fax you are sending to.
- You can store IDs in Quick Dials, Speed Dials, and Groups.
- Messages you send using this function are marked "SUB" on all reports.
- When you send fax message with SUB Code to other makers' machines, sometimes a password (SID) is necessary. Use SID when it is necessary.

- 1** Place your original and make any changes to the scan settings if necessary.

- 2** Dial the destination fax number using the number keys.

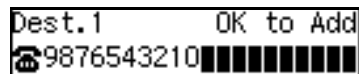

- 3** Press the **[User Function]** key assigned with the Dial Option function.

- 4** Confirm that " 1. SUB " is displayed.

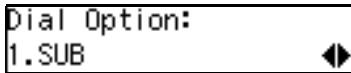

Dial Option:
1.SUB

- 5** Press the **[OK]** key.
- 6** Enter the SUB code with the number keys.



SUB: Press OK
[1234]

- 7** Press the **[OK]** key.

When a password (SID) is necessary

- 1** Press the **[User Function]** key assigned with the Dial Option function.
- 2** Press **[Left]** or **[Right]** until " 3. SID " is displayed.

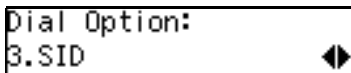

Dial Option:
3.SID

- 3** Press the **[OK]** key
- 4** Enter the SID code with the number keys.



SID: Press OK
[1234]

- 5** Press the **[OK]** key

- 8** Press the **[Start]** key.

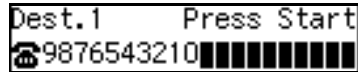

Dest.1 Press Start
9876543210

Note

- If you use Immediate Transmission and the destination fax machine does not support the Dial Option function, a message will appear on the display to inform you of this. In this case, press the **[OK]** key to cancel the transmission.

More Transmission Functions

If Memory Runs Out While Storing an Original

- 1** If you run out of memory while storing an original (free space reaches 0%), "Memory is Full. Storing Stopped." is displayed.

```
Memory is Full.  
Storing Stopped, /OK
```

- 2** Press the **[OK]** key.

```
Stored Pages ◀▶/OK  
[Transmit] Delete
```

When transmitting the stored pages

- 1** Press **◀** or **▶** to select "Transmit" and press the **[OK]** key.

 **Note**

- Successfully scanned pages are sent. Check the number of transmitted pages on Communication Result Report.

When deleting the stored pages

- 1** Press **◀** or **▶** to select "Delete" and press the **[OK]** key.

```
Trans. Cancelled.  
File Deleted.
```

Checking the Transmission Result

- Turn on the printing of the Communication Result Report if you want a report to be printed after every successful transmission. See p.25 "Printed Reports".
If you leave off the printing of the Communication Result Report, the report will not be printed after every transmission. However, should a transmission fail, a Communication Failure Report will be printed instead.
- If you turn off the printing of the Transmission Result Report (Immediate Transmission), the Error Report will be printed when the communication on fails.
- You can also check the transmission result by examining the Journal. See p.13 "Printing the Journal".
- You can assign the function of printing Transmission Result Report to User Function Keys.

Broadcasting Sequence

If you dial several destinations for the same message (Broadcasting), the messages are sent in the order in which they were dialed. If the fax message could not be transmitted to a destination, the machine redials that destination after the last destination specified for Broadcasting. For example, if you specify four destinations A through D for broadcasting, and if the lines to destinations A and C are busy, the machine dials the destinations in the following order: A, B, C, D, A, and C.

Sending a Fax Message Immediately

To send a fax message immediately, use Immediate Transmission. If you have just set up an original for broadcasting, Immediate Transmission will interrupt the current communication. Your message will not be sent until previously queued files have been sent.

Broadcasting : Checking Progress

To check which destinations the fax message has been sent to so far, print the TX file list.

Automatic Redial

If a fax message could not be transmitted because the line was busy or an error occurred during transmission, redialing is done 4 times at 5 minutes intervals (these figures vary according to which country you are in).

If redialing fails after four redials, the machine cancels the transmission and prints the Communication Result Report or Communication Failure Report.

Batch Transmission

If you send a fax message by Memory Transmission and there is another fax message waiting in memory to be sent to the same destination, that message is sent along with your message. Several fax messages can be sent with a single call, thus eliminating the need for several separate calls. This helps save communication costs and reduces transmission time.

Fax messages for which the transmission time has been set in advance are sent by Batch Transmission when that time is reached.

Note

- You can switch this function on or off with the User Parameters. See p.58 "User Parameters" (Switch06, Bit4).

Dual Access

The machine can scan other messages into memory even while sending a fax message from memory, receiving a message into memory, or automatically printing a report. Since the machine starts sending the second message immediately after the current transmission terminates, the line will be used efficiently.

Note that during Immediate Transmission or when in User Tools mode, the machine cannot scan an original.

ECM (Error Correction Mode)

This function automatically resends data that was not transmitted successfully using a system that complies with international standards.

ECM requires that the receiver has the same function.

Parallel Memory Transmission

This function dials while the original is being scanned. Standard Memory Transmission stores the original in memory, then dials the destination. Parallel Memory Transmission allows you to quickly determine whether a connection was made. In addition, this function scans the original faster than Immediate Transmission and is useful when you are in a hurry and need to use the original for another purpose.

Note

- ❑ You can switch this function on or off with the User Parameters. See p.58 "User Parameters" (Switch07, Bit2).

Limitation

- ❑ Standard Memory Transmission is used instead of Parallel Memory Transmission in the following cases.
 - When the line is busy and could not be connected to
 - With Send Later
 - When you store an original for Memory Transmission while another communication is in progress
 - When two or more destinations are specified
 - When the original is set on the exposure glass

Note

- ❑ If you press the **[Clear/Stop]** key, the original jams, or memory becomes full during Parallel Memory Transmission, the machine stops transmitting and prints the Communication Result Report. The file is erased.
- ❑ Total stored page numbers are not printed in the Parallel Memory Transmission. Only the page numbers are printed, such as P.1, P.2 not 1/2, 2/2.
- ❑ If you run out of memory, normal Memory Transmission takes place.
- ❑ File Reserve Report will not be printed with Parallel Memory Transmission.

Printed Reports

You can obtain reports from your machine either by having your machine print them out automatically, or by printing them out yourself.

Note

- You can switch on or off the printing of the various reports with the User Parameters. See p.58 "User Parameters" (switch 03, bits 7-0).
- For reference purposes, the machine prints part of the original image on the File Reserve Report, Communication Result Report and Communication Failure Report. You can choose whether to include part of the original image on reports with User Parameters (Switch 04. Bit 7).

File Reserve Report (Switch 03, Bit 2)

This report is printed after an original is stored in memory. Use it to review the contents and destinations of stored originals. Even if the machine is set up not to print this report, it is still printed if an original could not be stored.

Note

- File Reserve Report will not be printed with Parallel Memory Transmission.

Communication Result Report (Switch 03, Bit 0)

This report is printed when a Memory Transmission is completed so you can check the result of the transmission. If two or more destinations are specified, this report is printed after the fax message has been sent to all the destinations. If the machine is set up not to print this report and the fax message could not be successfully transmitted, the Communication Failure Report is printed. See p.25 "Communication Failure Report (Switch 03, Bit 0)".

Communication Failure Report (Switch 03, Bit 0)

This report is only printed if the Communication Result Report is turned off and a message could not be successfully transmitted with Memory Transmission. Use it to keep a record of failed transmissions so you can send them again.

Note

- The "Page" column gives the total number of pages. The "Not Sent" column gives the number of pages that could not be sent successfully.

Transmission Result Report (Immediate Transmission) (Switch 03, Bit 5)

If you turn on the printing of this report, a report will be printed after every Immediate Transmission so you have a record of whether the transmission was successful or not. If the machine is set up not to print this report and the fax message could not be successfully transmitted, the error report is printed instead.

3

Note

- If the page was sent successfully, the "Page" column gives the total number of pages that were sent successfully. The "Not Sent" column gives the number of pages that could not be sent successfully.

4. Reception Features

General

Immediate Reception

Each page of a received fax message is printed as soon as it is received. This method is used for standard fax messages.

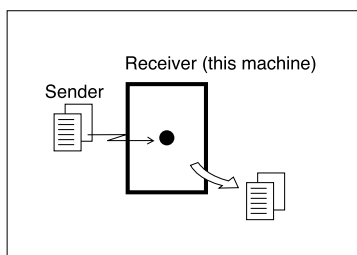

❖ Display during reception

The sender's name or fax number appears on the upper line.

```
ABC COMPANY  
Set Orig. / Enter No.
```

❖ Reception resolution

This machine supports **Standard** and **Detail** resolutions for reception. A fax message may be printed in a resolution different from the one specified by the sender.

Note

- Reception will not take place if there is not enough free memory left. If free memory reaches 0% during Immediate Reception, any further reception becomes impossible and the current communication is terminated.

Memory Reception

The machine waits until all pages of the message have been received into memory before printing the message.

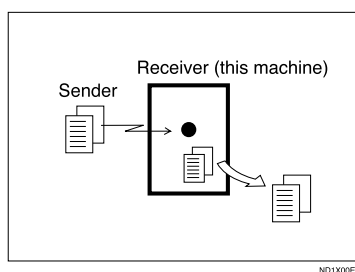

This method is used with Substitute Reception. See p.28 "Printing Documents that have been Received into Memory (Substitute Reception)".

Important

- All the messages stored in memory are deleted if the power is switched off for more than 12 hours.
- The machine may not be able to receive large numbers of messages or messages with a high data content. In such cases, we recommend you switch the above functions off.

Limitation

- The machine may not be able to receive fax messages when the free memory space is low.

Note

- If the memory free space reaches 0% during Memory Reception, the machine can no longer receive the current fax message and stops communicating.

Printing Documents that have been Received into Memory (Substitute Reception)

If any of the conditions listed below are met, the machine automatically switches to Memory Reception mode and stores messages in memory instead of printing them. This reception mode, in which a received fax message is stored in memory unprinted, is called Substitute Reception. Messages received using Substitute Reception are automatically printed when the condition which caused the machine to use Substitute Reception is rectified. Substitute Reception takes place when:

- Paper runs out
- Toner runs out
- Paper is jammed
- A cover is open
- A fax is received during a copy or print run
- Memory Lock

Limitation

- Reception may not take place if there is not enough free memory left.

Note

- The **Receive File** indicator lights to let you know when message(s) have been received using Substitute Reception.
- If free memory reaches 0% during Substitute Reception, any further reception becomes impossible and the current communication is terminated.

Screening Out Messages from Anonymous Senders

To help you screen out unwanted messages that may fill up your memory, the machine can be programmed to only use Substitute Reception for messages that arrive with name or fax number identification.

Two settings are available:

- When a name or fax number is received
- Free

Note

- When "When a name or fax number is received" is selected, the machine only stores messages when the name or fax number is present. You can change this with User Parameters. See p.58 "User Parameters" (switch 05, bit 1).

When a name or fax number is received

The machine switches to Substitute Reception only when the sender programs their name or fax number. If the power is switched off for more than 12 hours, all the messages received into memory are deleted. If this occurs, the Power Failure Report or Journal can be used to identify which messages were lost so you can ask the senders to transmit them again.

Important

- If a sender does not program their name or fax number, the machine may reject an important fax message. We recommend that you ask important senders to register their name or fax number in advance.

❖ Free

The machine switches to Substitute Reception regardless of whether or not the sender has programmed their name or fax number.

Receiving Messages in Telephone Mode

In this mode you have to answer the call yourself and decide whether it is a fax or a telephone call.

The procedure for answering a call is as follows:

- 1** Pick up the handset of the external telephone and listen to the other end.
- 2** If you hear a voice, continue your conversation as you would normally.
- 3** If you hear a fax tone, remove any originals from the feeder.

Note

- If the function of Manual Reception is registered to the User Function Key, press the User Function key and receive the message, then go to **3**.

- 4** Make sure that the machine is in Facsimile mode and the standby display is shown.
- 5** Press the **[Start]** key.

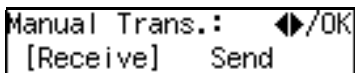

Manual Trans.: ◀/OK
[Receive] Send

- 6** Press ◀ or ▶ to select "Receive".
- 7** Press the **[OK]** key.
- 8** Replace the handset.

Auto Fax Reception Power-up

This machine can be set to shut down automatically if no one uses it for a while. In this situation, even though the operation switch is off, the machine can still receive incoming messages as long as the main power switch is on.

Important

- Reception is not possible if both the operation switch and main power switch are turned off.

Printing Options

Center Mark

When this function is turned on, marks are printed halfway down the left side and at the top center of each page received. This makes it easy for you to position a hole puncher correctly when you file received messages.

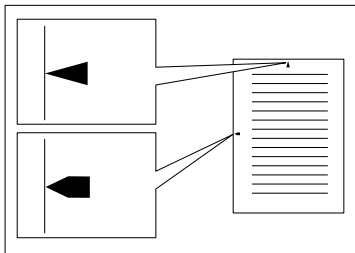

ZFH0240E

Limitation

- The center marks may deviate a little from the exact center of the edge.

Note

- You can turn this function on or off with the User Parameters (Switch 02 Bit 1). See p.58 “User Parameters”.

Checkered Mark

When this function is turned on, a checkered mark is printed on the first page of fax messages to help you separate them.

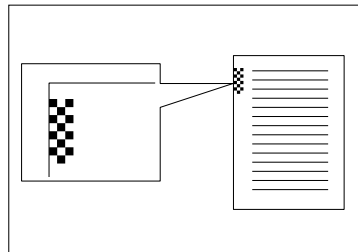

ND1X00E5

Note

- You can turn this function on or off with the User Parameters (Switch 02 Bit 4) See p.58 “User Parameters”.

TSI Print

Usually the sender's Fax Header is printed on received messages. If the sender has not programmed their Fax Header, you will not be able to identify them. However, if you turn this function on, the sender's Name or Fax Number is printed instead so you can find out where the message came from. See p.58 “User Parameters” (Switch 02 Bit 3)

Reception Time

When this function is turned on, you can have the date and time when a message was received printed at the bottom of the received image. Turn it on or off with the User Parameters (Switch 02 Bit 2). See p.58 "User Parameters".



Limitation

- When a received message is printed on two or more sheets, the date and time is printed on the last page.

Note

- The date and time when the message was printed can also be recorded on the message. If you need this function, please contact your service representative.

Page Separation and Length Reduction

When the size of a received message is longer than the paper loaded in the machine, each page of the message can be split and printed on several sheets, or reduced and printed on a single sheet. For example, When the paper size is A4 , this function splits the message if the message length is 92mm (3.7") or longer than the paper used. The message is reduced if it is less than 92mm (3.7"). When the paper size is 8 1/2"x11" , this function splits the message if the message length is 85mm (3.4") or longer than the paper used. The message is reduced if it is less than 85mm (3.4"). When a message is split, the split mark (*) is inserted at the split position and about 10mm (0.4") of the split area is duplicated on the top of the second sheet.

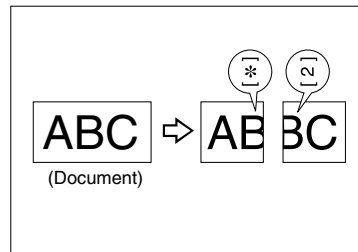

ND1X01E1

Note

- This function is not available in some countries.
- Your service representative can customize this function with the following settings.
 - Reduction
 - Print split mark
 - Overprinting
 - Guideline for split

When There is No Paper of the Correct Size

If there is no paper in your machine that matches the size of a received message, the machine will choose a paper size based upon the paper you have available. For example, if your machine has A4 and 8 1/2" x 11" installed and you receive a A5 size message, check the A5 column of the table below. The paper size at the top has the highest priority. In this case, since 8 1/2" x 11" is a higher priority than A4, the message is printed on 8 1/2" x 11".

◆ Priority Table

		Received Image Size					
		8 1/2" x 14" 8 1/4" x 14"	8 1/2" x 13" 8 1/4" x 13" 8" x 13"	A4	8 1/2" x 11"	A5	5 1/2" x 8 1/2"
Paper Select Priorities	1	8 1/2" x 14" 8 1/4" x 14" 	8 1/2" x 13" 8 1/4" x 13" 8" x 13" 	A4 	8 1/2" x 11" 	A5 	5 1/2" x 8 1/2"
	2	8 1/2" x 13" 8 1/4" x 13" 8" x 13" 	A4 	8 1/2" x 11" 	A4 	5 1/2" x 8 1/2" 	A5
	3	A4 	8 1/2" x 11" 	8 1/2" x 13" 8 1/4" x 13" 8" x 13" 	8 1/2" x 13" 8 1/4" x 13" 8" x 13" 	8 1/2" x 11" 	8 1/2" x 11"
	4	8 1/2" x 11" 	8 1/2" x 14" 8 1/4" x 14" 	8 1/2" x 14" 8 1/4" x 14" 	8 1/2" x 14" 8 1/4" x 14" 	A4 	A4
	5	A5 	A5 	A5 	A5 	8 1/2" x 13" 8 1/4" x 13" 8" x 13" 	8 1/2" x 13" 8 1/4" x 13" 8" x 13"
	6	5 1/2" x 8 1/2" 	5 1/2" x 8 1/2" 	5 1/2" x 8 1/2" 	5 1/2" x 8 1/2" 	8 1/2" x 14" 8 1/4" x 14" 	8 1/2" x 14" 8 1/4" x 14"

- Portrait
- Landscape
- Reduction

ZFKH250E

- and indicate that the message is split over two pages of paper with the orientation and size shown.

Page Reduction	Disabled
Reduction in Sub-scan Direction	Enabled
Width or Length Priority	Width

 **Limitation**

- The paper size used to print a received message may be different from the size of the sent original.

 **Reference**

p.31 "Page Separation and Length Reduction"

5. Facsimile User Tools

User Function Keys

You can program each of the User Function keys (**[F1]** to **[F3]**) with a function that you use frequently. When you wish to use that function, instead of having to search through several menus to find it, just press the appropriate User Function key.

Important

- When registering and editing User Function keys, we recommend that you print out a User Function List for reference. (See p.39 "Printing Reports/Lists".)

Functions You Can Assign to User Function Keys

You can program each of the User Function keys with one of the following functions.

Function Name	Function Contents	Condition	Reference
Manual Reception	Use this mode if your line is shared by a fax machine and a telephone but you wish to answer all calls yourself and decide whether they are fax messages or telephone calls.	-	See Chapter2, "Reception Modes" in the Basic Features manual.
Reception Mode	Use this mode to switch Reception modes.	-	See Chapter 2 "Reception Modes" in the Basic Features manual.
Print Journal	Use when you want to print out a Journal.	-	See p.13 "Printing the Journal"
TX Result Report	Use this to have a result report printed after every transmission.	○	See p.25 "Communication Result Report (Switch 03, Bit 0)" and p.26 "Transmission Result Report (Immediate Transmission) (Switch 03, Bit 5)"
Fax Header Print	You can turn this function on or off.	○	See p.3 "Fax Header Print"
Group	Use when you want to specify a group of destinations.	-	See Chapter 2, "Using Groups" in the Basic Features manual.
Tone	Use when you want to enter a tone signal.	-	See Chapter 2, "Tone" in the Basic Features manual.

Function Name	Function Contents	Condition	Reference
Dial Option	Use this function to attach various information to a fax message.	-	See p.19 "SEP Code", p.20 "SUB Code"
Batch Trans.	You can turn this function on or off.	○	See p.23 "Batch Transmission"
Forwarding	You can turn this function on or off.	○	See p.52 "Forwarding"
Prog. Quick Dial	Use when you want to register the other party's number as a Quick Dial destination.	-	See Chapter 3, "Quick Dial" in the Basic Features manual.
Monitor volume	Use this to adjust the volume for the monitor and buzzer.	-	See Chapter 4, "Adjusting Volume" in the Basic Features manual.

- The "○" notation indicates that the User Function key lights when that function is selected "On".

To assign a function to a User Function key, perform the following procedure.

5

Making a User Function Key Assignment

- 1 Press the **[User Tools]** key.

```
User Tools:
1.Counter
```

- 2 Press **⏪** or **⏩** until " 4. Fax Features " is displayed.

```
User Tools:
4.Fax Features
```

- 3 Press the **[OK]** key.

Confirm that " 1. Program / Delete " is displayed

```
Fax Features:
1.Program / Delete
```

- 4 Press the **[OK]** key.

- 5 Press **⏪** or **⏩** to scroll and display " 7. User Functions ".

```
Program / Delete:
7.User Functions
```

- 6 Press the **[OK]** key.

```
Press Key to Program
(F1-F3)
```

- 7 Press the User Function key (**[F1]** to **[F3]**) you want to assign.

```
User Functions /OK
[Print Journal]
```

- 8 Press **⏪** or **⏩** to display the function name you want to assign.

```
User Functions /OK
Group
```

- 9** Press the **[OK]** key.

```
User Functions  ◀/OK
[Group]
```

If you want to register another User Function key, repeat the above steps from step **8**.

- 10** Press the **[User Tools]** key.

The machine returns to standby mode.

Using a User Function Key

To use a User Function key (**[F1]** to **[F3]**), press the User Function key that contains the desired registered function.

```
Group Dial: Enter No.
[Gp.D]
```

The display for Group function is registered.

The display changes for each assigned function.

Deleting a User Function Key

To delete a User Function key, perform the following procedure.

- 1** Press the **[User Tools]** key.

```
User Tools:
1.Counter  ▶
```

- 2** Press **⏪** or **⏩** until "4. Fax Features" is displayed.

```
User Tools:
4.Fax Features  ▶
```

- 3** Press the **[OK]** key.

- 4** Confirm that "1. Program / Delete" is displayed.

```
Fax Features:
1.Program / Delete  ▶
```

- 5** Press the **[OK]** key

- 6** Press **⏪** or **⏩** until "7. User Functions" is displayed.

```
Program / Delete:
7.User Functions  ▶
```

- 7** Press the **[OK]** key

```
Press Key to Program
(F1-F3)
```

- 8** Press the User Function key you want to delete.

```
User Functions  ▶/OK
[Group]
```

If you make a mistake, press the correct User Function key.

- 9** Press **⏪** or **⏩** to display "None".

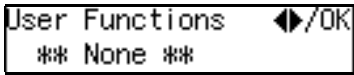

- 10** Press the **[OK]** key.

If you want to delete another User Function key, repeat the above steps from step **7**.

- 11** Press the **[User Tools]** key.

The machine returns to standby mode.

Printing Reports/Lists

This function allows you to print the following reports and lists manually. Select a report or list as needed.

- Journal
See p.13 "Printing the Journal".
- TX File List
See p.11 "Printing a Stored Message (Print TX File)".
- Quick Dial List
See Chapter 3 "Quick Dial" in the Basic Features manual.
- Speed Dial List
See Chapter 3 "Speed Dial" in the Basic Features manual.
- Group Dial List
See Chapter 3 "Groups" in the Basic Features manual.
- All Lists
You can print all Dial lists (Quick Dial List, Speed Dial List and Group Dial List).
- Quick Dial Label
See Chapter 3 "Quick Dial" in the Basic Features manual.
- User Function List
See p.35 "User Function Keys"

1 Press the **[User Tools]** key.

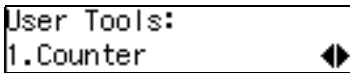

User Tools:
1.Counter

2 Press **⏪** or **⏩** until " 4. Fax Features " is displayed.

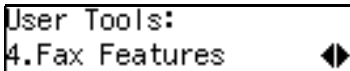

User Tools:
4.Fax Features

3 Press the **[OK]** key.

4 Press **⏪** or **⏩** until " 2. Reports / Lists " is displayed.

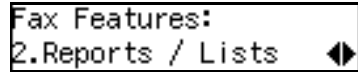

Fax Features:
2.Reports / Lists

5 Press the **[OK]** key.

Printing the Journal

1 Confirm that " 1. Journal " is displayed and press the **[OK]** key.

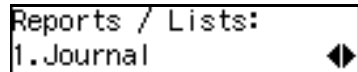

Reports / Lists:
1.Journal

 **Note**

- If you make a mistake, press the **[Cancel]** key and try again.

Printing a TX File List

1 Press **⏪** or **⏩** until " 2. TX File List " is displayed.

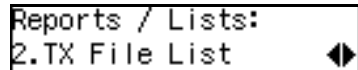

Reports / Lists:
2.TX File List

2 Press the **[OK]** key.

 **Note**

- If you make a mistake, press the **[Cancel]** key and try again.

Printing the Quick Dial List

- 1 Press **⏪** or **⏩** until " 3. Dial List " is displayed.

```
Reports / Lists:
3.Dial List      ◀▶
```

- 2 Press the **[OK]** key.
Confirm that " 1. Quick Dial List " is displayed.

```
Dial List:
1.Quick Dial List  ◀▶
```

- 3 Press the **[OK]** key.

 **Note**

- If you make a mistake, press the **[Cancel]** key and try again.

Printing the Speed Dial List

- 1 Press **⏪** or **⏩** until " 3. Dial List " is displayed.

```
Reports / Lists:
3.Dial List      ◀▶
```

- 2 Press the **[OK]** key
- 3 Press **⏪** or **⏩** until " 2. Speed Dial List " is displayed.

```
Dial List:
2.Speed Dial List  ◀▶
```

- 4 Press the **[OK]** key

 **Note**

- If you make a mistake, press the **[Cancel]** key and try again.

Printing the Group Dial List

- 1 Press **⏪** or **⏩** until " 3. Dial List " is displayed.

```
Reports / Lists:
3.Dial List      ◀▶
```

- 2 Press the **[OK]** key
- 3 Press **⏪** or **⏩** until " 3. Group Dial List " is displayed.

```
Dial List:
3.Group Dial List  ◀▶
```

- 4 Press the **[OK]** key

 **Note**

- If you make a mistake, press the **[Cancel]** key and try again.

Printing the All Lists

You can print all Dial Lists (Quick Dial List, Speed Dial List and Group Dial List) by the following operation.

- 1 Press **⏪** or **⏩** until " 3. Dial List " is displayed.

- 2 Press the **[OK]** key.

- 3 Press **⏪** or **⏩** until " 4. All Lists " is displayed.

```
Dial List:
4.All Lists       ◀▶
```

- 4 Press the **[OK]** key.

 **Note**

- If you make a mistake, press the **[Cancel]** key and try again.

Printing the Quick Dial Label

- 1 Press **⏪** or **⏩** until " 4. Quick Dial Label " is displayed.

```
Reports / Lists:
4.Quick Dial Label ◀▶
```

- 2 Press the **[OK]** key.

 **Note**

- If you make a mistake, press the **[Cancel]** key and try again.

Printing the User Function List

- 1 Press **⏪** or **⏩** until " 5. U. Function List " is displayed.

```
Reports / Lists:
5.U. Function List ◀▶
```

- 2 Press the **[OK]** key.

 **Note**

- If you make a mistake, press the **[Cancel]** key and try again.

- 6 Press the **[Start]** key.

- 7 Press the **[User Tools]** key.

The machine returns to the stand-by display.

Adjusting the Display Contrast

Use this function to adjust the brightness of the display.

- 1 Press the **[User Tools]** key.

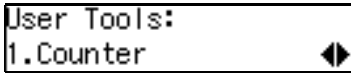

- 2 Press **⏪** or **⏩** until " 4. Fax Features " is displayed.

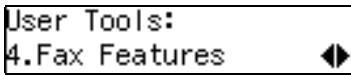

5

- 3 Press the **[OK]** key.

- 4 Press **⏪** or **⏩** until " 3. Setup " is displayed.

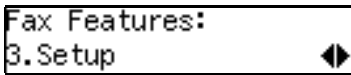

- 5 Press the **[OK]** key.

- 6 Press **⏪** or **⏩** until " 2. Display Contrast " is displayed.

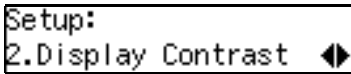

- 7 Press the **[OK]** key.

- 8 Press **⏪** or **⏩** to adjust the brightness of the display.

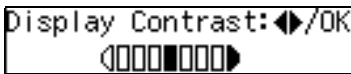

- 9 Press the **[OK]** key.

- 10 Press the **[User Tools]** key to return to the standby display.

Setting the Date and Time

Use this function to set your machine's internal clock to the current time and date.

If the current date and time are wrong, use this procedure to correct them.

Note

- ❑ If you make a mistake when entering numbers, press the **[Clear/Stop]** key and try again.
- ❑ The machine automatically sets the internal clock one hour ahead when daylight saving time begins, and one hour back when it ends.

1 Press the **[User Tools]** key.

User Tools:
1. Counter

2 Press **[Left]** or **[Right]** until "4. Fax Features" is displayed.

User Tools:
4. Fax Features

3 Press the **[OK]** key.

4 Press **[Left]** or **[Right]** until "3. Setup" is displayed.

Fax Features:
3. Setup

5 Press the **[OK]** key.

6 Press **[Left]** or **[Right]** until "3. Date/Time" is displayed.

Setup:
3. Date/Time

7 Press the **[OK]** key.

8 Use the number keys to enter the year.

Year: Press OK
[2001]

9 Press the **[OK]** key

10 Press **[Left]** or **[Right]** to select the correct month.

Month: **[Left/Right]**/OK
[May]

11 Press the **[OK]** key.

12 Use the number keys to enter the correct number for the date (1 to 31).

Day: Press OK
[20]

13 Press the **[OK]** key.

14 Press **[Left]** or **[Right]** to select "AM" or "PM".

AM/PM: **[Left/Right]**/OK
[AM] PM

15 Press the **[OK]** key.

16 Use the number keys to enter the correct time.

Time: Press OK
[3:52]

Enter the current hour setting (1 to 12), and then use the number keys to enter a 2-digit number for the current minute setting (00 to 59)

17 Press the **[OK]** key.

After " Function Accepted " flashes briefly in the display, the next setting is displayed.

18 Press the **[User Tools]** key to return to standby display.

Setting the Auto Ring Time

In Auto Select mode, the machine rings a number of times to give you the chance to pick up the handset before taking the call automatically. You can change the number of rings with the Auto Ring Time.

- 1** Press the **[User Tools]** key.

```
User Tools:
1.Counter
```

- 2** Press **⏪** or **⏩** until " 4. Fax Features " is displayed.

```
User Tools:
4.Fax Features
```

- 3** Press the **[OK]** key.

- 4** Press **⏪** or **⏩** until " 3. Setup " is displayed.

```
Fax Features:
3.Setup
```

- 5** Press the **[OK]** key.

- 6** Press **⏪** or **⏩** until " 5. No. of Rings " is displayed.

```
Setup:
5.No. of Rings
```

- 7** Press the **[OK]** key.

```
No. of Rings: /OK
[ 8] (1-29)
```

- 8** Enter the new number using the number keys.

```
No. of Rings: /OK
[ 6] (1-29)
```

Note

- If you make a mistake, press the **[Clear/Stop]** key and try again.

- 9** Press the **[OK]** key.

- 10** Press the **[User Tools]** key to return to the standby display.

Setting the Fax Reset Timer

This machine automatically returns to the standby mode if you do not use the machine for a certain period of time. You can select this period.

- 1** Press the **[User Tools]** key.

```
User Tools:
1.Counter  ◀▶
```

- 2** Press **⏪** or **⏩** until "4. Fax Features" is displayed.

```
User Tools:
4.Fax Features  ◀▶
```

- 3** Press the **[OK]** key.

- 4** Press **⏪** or **⏩** until "3. Setup" is displayed.

```
Fax Features:
3.Setup  ◀▶
```

- 5** Press the **[OK]** key.

- 6** Press **⏪** or **⏩** until "7. Fax Reset Timer" is displayed.

```
Setup:
7.Fax Reset Timer  ◀▶
```

- 7** Press the **[OK]** key.

```
Fax Reset Timer: ◀▶/OK
[30 seconds]
```

- 8** Press **⏪** or **⏩** to select a period of time.

```
Fax Reset Timer: ◀▶/OK
3 minutes
```

- 9** Press the **[OK]** key.

- 10** Press the **[User tools]** key to return to the standby display.

5

On Hook Timeout

This machine automatically cancels the On Hook Dial mode if you do not dial a number from the numeric keypad for a certain period of time after pressing the **[On Hook Dial]** key. You can select this period.

- 1** Press the **[User Tools]** key.

```
User Tools:
1.Counter
```

- 2** Press **⏪** or **⏩** until " 4. Fax Features " is displayed.

```
User Tools:
4.Fax Features
```

- 3** Press the **[OK]** key.

- 4** Press **⏪** or **⏩** until " 3. Setup " is displayed.

```
Fax Features:
3.Setup
```

- 5** Press the **[OK]** key.

- 6** Press **⏪** or **⏩** until " 8. On Hook Timeout " is displayed.

```
Setup:
8.On Hook Timeout
```

- 7** Press the **[OK]** key.

```
On Hook Timeout: ⏪/OK
[3 minutes]
```

- 8** Press **⏪** or **⏩** to select a period of time.

```
On Hook Timeout: ⏪/OK
5 minutes
```

- 9** Press the **[OK]** key.

- 10** Press the **[User tools]** key to return to standby display.

6. Key Operator Settings

Function List

Here is a list of the functions that are available for setting. Please refer to the reference page numbers for more information.

Display (Specs.)	Description	Reference
1. Memory Lock	Allows you to have messages from Specified Senders stored in memory and not printed as soon as they are received. To print the fax messages, you must enter an ID.	p.50 "Memory Lock"
2. Forwarding	Allows you to automatically forward fax messages to the fax machines of Specified Senders.	p.52 "Forwarding"
3. User Parameters	Allows you to customize various default settings as required.	p.58 "User Parameters"
4. Personal Code	Allows you to set up personal codes for using the Restricted Access. Before using the fax machine, users must enter the Personal Code. This allows you to limit transmission to specified users.	p.63 "Personal Codes"
5. ID Code	Allows you to register IDs required for various types of transmissions.	p.66 "ID Code"
6. Line Type	Allows you to select tone or pulse dialing to match the telephone line connected to your fax machine.	p.67 "Line Type"
7. PSTN Access No.	Allows you to specify the code used to access an outside line when you dialing.	p.68 "PSTN Access Number"
8. Mem. File Trans.	Allows you to send all messages stored in memory to another fax machine and print them out there, for example, when your fax machine runs out of toner.	p.69 "Memory File Transfer"
9. RDS On/Off	Allows you to switch on RDS (Remote Diagnostic System) so a service representative can test your fax machine remotely from a service station, diagnose the problem, and can change your machine settings to correct the problem.	p.70 "RDS (Remote Diagnostic System)"

Copy this table and use it as a quick reference.

Using Key Operator Settings

This chapter explains about functions the key operator handles.

Memory Lock

This is a security function to prevent unauthorized individuals from reading printed fax messages. When Memory Lock is switched on, all received messages are stored in memory and are not automatically printed. To print the messages, you have to enter the Memory Lock ID.

Note

- ❑ Before you can use this function, you must register the Memory Lock ID. See p.66 "ID Code"

Limitation

- ❑ Memory Lock cannot be selected until you have registered the Memory Lock ID.
- ❑ To use this function you must switch Memory Lock on after you register the Memory Lock ID.
- ❑ You can select to lock only messages from Specified Users, or you can select to lock messages from senders other than from Specified Users. See p.58 "User Parameters" (switch 09, bits 1 and 0).

- 1** Press the **[User Tools]** key.

```
User Tools:
1.Counter
```

- 2** Press **⏪** or **⏩** until "4. Fax Features" is displayed.

```
User Tools:
4.Fax Features
```

- 3** Press the **[OK]** key.

- 4** Press **⏪** or **⏩** until "4. Key Op. Tools" is displayed.

```
Fax Features:
4.Key Op. Tools
```

- 5** Press the **[OK]** key.

```
Key Op. Tools:
1.Memory Lock
```

Confirm that "1. Memory Lock" is displayed.

- 6** Press the **[OK]** key.

```
Memory Lock:
1.On/Off
```

- 7** Follow the procedures below to switch Memory Lock On/Off, register a Specified Sender, delete a Specified Sender, or print a list of Specified Senders.

Switching Memory Lock On/Off

- 1** Press the **[OK]** key.

```
Memory Lock:  ⏪/OK
On  [Off]
```

- 2** Press **⏪** or **⏩** to "On" to switch this function on, or select "Off" to switch this function off.

```
Memory Lock:  ⏪/OK
[On]  Off
```

- 3** Press the **[OK]** key.

Registering a Specified Sender for Memory Lock

You can register Specified Senders for this function.

- 1 Press **⏪** or **⏩** to display " 2. Program Sender ".

```
Memory Lock:
2. Program Sender  ⏪
```

- 2 Press the **[OK]** key.
- 3 Enter "Own Name" or "Own Fax Number" for the Specified Sender.

Enter the other party's "Own Name" or "Own Fax Number"

```
Name/No.: [ABC] /OK
[ABC COMPANY ██████████]
```

- 4 Press the **[OK]** key.

```
Store as Wildcard?
[Yes] No
```

- 5 If you want to specify a wildcard, press **⏪** or **⏩** key to select "Yes".

```
Store as Wildcard?
Yes [No]
```

- 6 Press the **[OK]** key.
The Specified Sender is registered.
If you want to register another Specified Sender, repeat from step 2.

Deleting a Specified Sender for Memory Lock

You can delete Specified Senders for this function.

- 1 Press **⏪** or **⏩** to select " 3. Delete Sender ".

```
Memory Lock:
3. Delete Sender  ⏪
```

- 2 Press the **[OK]** key.
- 3 Press **⏪** or **⏩** to select the name of the Specified Sender that you want to delete.
- 4 Press the **[OK]** key.

The Specified Sender is deleted.

If you want to delete more Specified Senders, repeat from step 2.

Printing a List of Specified Senders for Memory Lock

You can print a list of Specified Senders for Memory Lock.

- 1 Press **⏪** or **⏩** to display " 4. Print Sender List ".

```
Memory Lock:
4. Print Sender List  ⏪
```

- 2 Press the **[OK]** key.
- 3 Press the **[Start]** key. The list prints.
- 8 Press the **[User Tools]** key to return to the standby display.

Forwarding

Use this function to print fax specified from Specified Senders on your own machine and then forward the messages to other fax machines. This is useful, for example, if you are visiting another office and would like copies of your messages from the head office forwarded to you so you can read them.

In this section, the machines that messages are forwarded to are referred to as Forwarding Stations. The locations from which you would like messages forwarded from are referred to as Specified Senders.

You can register:

- 5 Forwarding Stations
- 30 Specified Senders (maximum 10 per Forwarding Station, up to 24 characters each)
- Wild Cards

Important

- We recommend that you print the Forwarding/Sender list and keep it when you register or change a receiver or sender.

Limitation

- This function only works if the incoming message is from another party that has been programmed as a Specified Sender.
- The Forwarding function does not forward messages received with Polling Reception mode.
- You cannot register a sender who does not have an Own Name or Own Fax Number.
- You can register up to 30 senders for the Forwarding function. You sometimes cannot register 30 senders depending on the number of senders registered with other functions.

Note

- To register a sender, use an Own Name or Own Fax Number.
- You can find out the Own Name or Own Fax Number of a sender by looking in the destination name column of the Journal.

Forwarding Mark

You can print a forwarding mark on forwarded messages. See p.58 "User Parameters" (Switch02, Bit0).

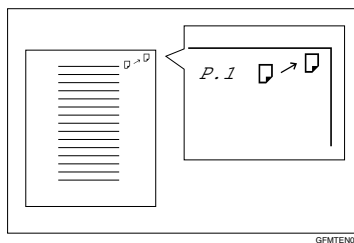

GFMTEUJ

Switching Forwarding On/Off

- 1 Press the **[User Tools]** key.

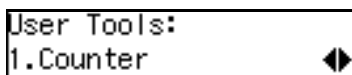

- 2 Press **⏪** or **⏩** until "4. Fax Features" is displayed.

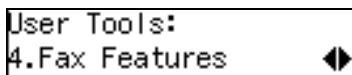

- 3 Press the **[OK]** key.

- 4** Press **⏪** or **⏩** until " 4. Key Op. Tools " is displayed.

```
Fax Features:
4.Key Op. Tools
```

- 5** Press the **[OK]** key.

- 6** Press **⏪** or **⏩** until " 2. Forwarding " is displayed.

```
Key Op. Tools:
2.Forwarding
```

- 7** Press the **[OK]** key.

Confirm that " 1. On/Off " is displayed.

```
Forwarding:
1.On/Off
```

- 8** Press the **[OK]** key.

- 9** Press **⏪** or **⏩** to "On" to switch this function on, or select "Off" to switch this function off.

```
Forwarding:      ⏪/OK
[On]  Off
```

- 10** Press the **[OK]** key.

Note

- If you select "On" and no forwarding station is registered, "Press OK to Program Forwarding Station" is displayed. Press the **[OK]** key, and then register a forwarding station by following steps **10** to **11** on p.53 "Registering Forwarding Stations".

- 11** Press the **[User Tools]** key to return to the standby display.

Registering Forwarding Stations

You can register a Forwarding Station as follows.

- 1** Press the **[User Tools]** key.

```
User Tools:
1.Counter
```

- 2** Press **⏪** or **⏩** until " 4. Fax Features " is displayed.

```
User Tools:
4.Fax Features
```

- 3** Press the **[OK]** key.

- 4** Press **⏪** or **⏩** until " 4. Key Op. Tools " is displayed.

```
Fax Features:
4.Key Op. Tools
```

- 5** Press the **[OK]** key.

- 6** Press **⏪** or **⏩** until " 2. Forwarding " is displayed.

```
Key Op. Tools:
2.Forwarding
```

- 7** Press the **[OK]** key.

- 8** Press **⏪** or **⏩** until " 2. Prog. Station " is displayed.

```
Forwarding:
2.Prog. Station
```

- 9** Press the **[OK]** key.

- 10** Press **⏪** or **⏩** to display the number of the forwarding station you want to register.

```

Program? ◀/OK
1:
    
```

If a forwarding station is already registered, the fax number for that station is displayed.

- 11** Press the **[OK]** key.
- 12** Enter the other party's fax number with the number keys.

```

Station 1: Press OK
☎1234567890 ██████████
    
```

- 13** Press the **[OK]** key.
- The Forwarding Station's fax number is registered.

```

Sender Setting:
1.Program Sender ▶
    
```

- 14** Press the **[OK]** key.

```

Name/No.: [ABC]
[████████████████████]
    
```

- 15** Enter the other party's name.

```

Name/No.: [ABC] /OK
[ABC COMPANY ██████████]
    
```

- 16** Press the **[OK]** key.
- 17** If you want to register the Specified Sender as a Wildcard, press **⏪** or **⏩** to select "Yes".

```

Store as Wildcard?
[Yes] No
    
```

- 18** Press the **[OK]** key.
- To register another Specified Sender, repeat the above steps from step **14**.
- To register a different Forwarding Station, press the **[Cancel]** key and repeat the above steps from step **9**.

! Limitation

- Names for Specified Senders can be up to 24 characters long.

📎 Note

- You can confirm the names and fax numbers of Specified Senders on the Journal.
- You can confirm registered Specified Senders using the Specified Sender list.

- 19** Press the **[User Tools]** key to return to the standby display.

Editing a Forwarding Station

To edit a Forwarding Station that is already registered, perform the following procedure.

- 1** Press the **[User Tools]** key.
- ```

User Tools:
1.Counter ▶

```
- 2** Press **⏪** or **⏩** until "4. Fax Features" is displayed.
- ```

User Tools:
4.Fax Features ▶
    
```
- 3** Press the **[OK]** key.

- 4** Press **⏪** or **⏩** until " 4. Key Op. Tools " is displayed.

```
Fax Features:
4.Key Op. Tools  ◀▶
```

- 5** Press the **[OK]** key.

- 6** Press **⏪** or **⏩** until " 2. Forwarding " is displayed.

```
Key Op. Tools:
2.Forwarding  ◀▶
```

- 7** Press the **[OK]** key.

- 8** Press **⏪** or **⏩** until " 2. Prog. Station " is displayed.

```
Forwarding:
2.Prog. Station  ◀▶
```

- 9** Press the **[OK]** key.

- 10** Press **⏪** or **⏩** to display the fax number of the Forwarding Station you want to edit.

```
Program?  ◀▶/OK
1:1234567890
```

- 11** Press the **[OK]** key.

- 12** Press the **[Clear/Stop]** key, and then enter the Forwarding Station's correct fax number.

```
Station 1:  Press OK
☎9876543210■■■■■■■■■■
```

- 13** Press the **[OK]** key.

The fax number is registered.

If you want to edit another Forwarding Station, press the **[Cancel]** key and repeat the above steps from step **4**.

- 14** Press the **[User Tools]** key to return to the standby display.

Editing a Specified Sender

To edit a Specified Sender, delete the Specified Sender you want to edit (See p.56 "Deleting a Specified Sender"), and then register it as a new Specified Sender. (See p.53 "Registering Forwarding Stations").

Deleting a Forwarding Station

To delete a Forwarding Station, perform the following procedure.

- 1** Press the **[User Tools]** key.

```
User Tools:
1.Counter  ◀▶
```

- 2** Press **⏪** or **⏩** until " 4. Fax Features " is displayed.

```
User Tools:
4.Fax Features  ◀▶
```

- 3** Press the **[OK]** key.

- 4** Press **⏪** or **⏩** until " 4. Key Op. Tools " is displayed.

```
Fax Features:
4.Key Op. Tools  ◀▶
```

- 5** Press the **[OK]** key.

- 6** Press **⏪** or **⏩** until " 2. Forwarding " is displayed.

```
Key Op. Tools:
2.Forwarding  ◀▶
```

- 7** Press the **[OK]** key.

- 8** Press **⏪** or **⏩** until " 3. Delete Station " is displayed.

Forwarding:
3.Delete Station ◀▶

- 9** Press the **[OK]** key.

- 10** Press **⏪** or **⏩** to display the fax number of the Forwarding Station you want to delete.

Delete? ◀▶/OK
1:9876543210

- 11** Press the **[OK]** key.

The Forwarding Station is deleted.
If you want to delete another Forwarding Station, repeat the procedure from step **9**.

- 12** Press the **[User Tools]** key to return to the standby display.

Deleting a Specified Sender

To delete a Specified Sender, perform the following procedure.

- 1** Press the **[User Tools]** key.

User Tools:
1.Counter ◀▶

- 2** Press **⏪** or **⏩** until " 4. Fax Features " is displayed.

User Tools:
4.Fax Features ◀▶

- 3** Press the **[OK]** key.

- 4** Press **⏪** or **⏩** until " 4. Key Op. Tools " is displayed.

Fax Features:
4.Key Op. Tools ◀▶

- 5** Press the **[OK]** key.

- 6** Press **⏪** or **⏩** until " 2. Forwarding " is displayed.

Key Op. Tools:
2.Forwarding ◀▶

- 7** Press the **[OK]** key.

- 8** Press **⏪** or **⏩** until " 2. Prog. Station " is displayed.

Forwarding:
2.Prog. Station ◀▶

- 9** Press the **[OK]** key.

- 10** Press **⏪** or **⏩** to display the fax number of the Forwarding Station that contains the Specified Sender you want to delete.

Program? ◀▶/OK
1:1234567890

- 11** Press the **[OK]** key.

- 12** Press the **[OK]** key.

- 13** Press **⏪** or **⏩** until " 2. Delete Sender " is displayed.

Sender Setting:
2.Delete Sender ◀▶

- 14** Press the **[OK]** key.

- 15** Use **⏪** or **⏩** to display the Specified Sender you want to delete.

```
Delete?      ◀/OK
ABC COMPANY
```

- 16** Press the **[OK]** key.

The Specified Sender is deleted.

If you want to delete another Specified Sender, repeat the above steps from step **15**.

- 17** Press the **[User Tools]** key to return to the standby display.

Printing the Specified Sender list

You can check which Specified Senders are registered for a Forwarding Address.

Follow the steps below to print this list.

- 1** Press the **[User Tools]** key.

```
User Tools:
1.Counter    ▶◀
```

- 2** Press **⏪** or **⏩** until "4. Fax Features" is displayed.

```
User Tools:
4.Fax Features ▶◀
```

- 3** Press the **[OK]** key.

- 4** Press **⏪** or **⏩** until "4. Key Op. Tools" is displayed.

```
Fax Features:
4.Key Op. Tools ▶◀
```

- 5** Press the **[OK]** key.

- 6** Press **⏪** or **⏩** until "2. Forwarding" is displayed.

```
Key Op. Tools:
2.Forwarding ▶◀
```

- 7** Press the **[OK]** key.

- 8** Press **⏪** or **⏩** until "4. Print Sender List" is displayed.

```
Forwarding:
4.Print Sender List ▶◀
```

- 9** Press the **[OK]** key.

- 10** Press the **[Start]** key.

The list is printed.

- 11** Press the **[User Tools]** key to return to the standby display.

User Parameters

The User Parameters allow you to customize various settings to match your needs.

To change the function settings, set the user parameter switches.

Preparation

Access to some User Parameter Settings requires installation of optional equipment or that other settings be made beforehand.

◆ Switches and Bits

User Parameters are divided into switches and each switch is divided into eight bits. The right most bit is bit 0 and the left most is bit 7.

Bit Number	7	6	5	4	3	2	1	0
Bit Value	↓	↓	↓	↓	↓	↓	↓	↓
	0	1	0	0	0	0	0	0

The User Parameter switches are outlined below.

Switch	Bit	Item	1	0
00	3,2,1	Image density adjustment level home position (the higher level, the greater image density) 000: Standard, 001: lighter, 010: darker 101: somewhat lighter 110: somewhat darker		
	5,4	5, 4: Default resolution when you send a message. RESOLUTION 00: Standard 01: Detail 10: Fine		
	6	Default setting for transmission. TRANSMISSION MODE	Immediate	Memory
	7	Home position for the Original Type. HALFTONE	Photo	Text
01	7	Return the machine to the default settings after each communication (Return to default after transmission)	On	Off

Switch	Bit	Item	1	0
02	0	Default setting for printing the Forwarding Mark. FORWARDING MARK	On	Off
	1	Default setting for the Center Mark. CENTER MARK	On	Off
	2	Default setting for printing the Reception Time. RECEPTION TIME	On	Off
	3	Print Sender Information (TSI Print)	On	Off
	4	Default setting for the Checkered Mark. CHECKERED MARK	On	Off
03	0	Automatic printing of the Communication Result Report (Memory TX)	On	Off
	2	Automatic printing of the File Reserve Report (Memory TX)	On	Off
	3	Automatic printing of the File Reserve Report (Polling RX)	On	Off
	4	Automatic printing of the Communication Result Report (Polling RX)	On	Off
	5	Automatic printing of the Transmission Result Report (Immediate TX)	On	Off
	7	Automatic printing of the Journal	On	Off
04	7	Include a portion of the image on the Communication Result Report, File Reserve Report, Communication Failure Report.	On	Off

Key Operator Settings

Switch	Bit	Item	1	0
05	0	Store incoming faxes when machine is out of supplies. SUBSTITUTE RECEPTION	On	Off
	1	Default setting for Substitute Reception. CONDITIONS OF MEMORY RECEPTION	Reject (If no name or fax number is received)	Accept (Free)
	4	Restricts fax machine usage to specific users. RESTRICTED ACCESS	On	Off
06	0	Default setting for a header with each page. FAX HEADER PRINT	On	Off
	4	Default setting for Batch Transmission. BATCH TRANSMISSION	On	Off
07	2	Parallel Memory Transmission	On	Off
	4	Assign the Tone key as the "*" key on the operation panel. TONE SWITCH BY ASTERISK KEY	On	Off
08	6	Forwarding	On	Off
	7	Forwarding 0: Forward messages from Specified Senders only. 1: Forward messages from non-Specified Senders only.		
09	0	Memory Lock	On	Off
	1	Memory Lock 0: Messages from Specified Senders are not printed unless you enter the Memory Lock ID. 1: Messages from non-Specified Senders are not printed unless you enter the Memory Lock ID.		
	6	ADD DESTINATIONS WITH A SERIES OF QUICK DIALS	On	Off

Switch	Bit	Item	1	0
10	7	Use dithering halftone (SPD) or standard halftone (STD). HALFTONE METHOD	SPD	STD
11	6	Print the received message when acting as a Forwarding Station PRINT MEMORY TRANSFER FILES	On	Off
12	1	Distinctive Ring	On	Off
13	0	Access to the public telephone line PABX/PSTN G3	PABX	PSTN

Changing the User Parameters

We recommend that you print the User Parameter list and keep it when you register or change a user parameter. See p.62 "Printing the User Parameter List".

Do not change any bit switches other than those shown on the previous pages.

- 1** Press the **[User Tools]** key.

```
User Tools:
1.Counter
```

- 2** Press **⏪** or **⏩** until "4. Fax Features" is displayed.

```
User Tools:
4.Fax Features
```

- 3** Press the **[OK]** key.

- 4** Press **⏪** or **⏩** until "4. Key Op. Tools" is displayed.

```
Fax Features:
4.Key Op. Tools
```

- 5** Press the **[OK]** key.

- 6** Press **⏪** or **⏩** until "3. User Parameters" is displayed.

```
Key Op. Tools:
3.User Parameters
```

- 7** Press the **[OK]** key.

```
User Parameters:
1.Change
```

8 Press the **[OK]** key.

Refer Op. Manual:
Switch 00 :0000 0110

For a list of the switches and settings, see p.58 "User Parameters".

Use the User Parameters table to look up the number of the switch that you want to change, and then press the **[←]** or **[→]** key to display the number of the switch.

The bits are numbered 7~0. To change a setting, press the corresponding number key to toggle the setting between "0" and "1"

Key to Press	7	6	5	4	3	2	1	0
SW 00:	1	0	0	0	0	1	1	0

For example, if you want to change the setting at bit 7, press the 7 number key to toggle the setting between "1" and "0".

9 When you are finished making adjustments, press the **[OK]** key.

User Parameters:
1.Change

10 Press the **[User Tools]** key to return to the standby display.

Printing the User Parameter List

Print this list to see the current User Parameter settings.

1 Press the **[User Tools]** key.

User Tools:
1.Counter

2 Press **[←]** or **[→]** until " 4. Fax Features " is displayed.

User Tools:
4.Fax Features

3 Press the **[OK]** key.

4 Press **[←]** or **[→]** until " 4. Key Op. Tools " is displayed.

Fax Features:
4.Key Op. Tools

5 Press the **[OK]** key.

6 Press **[←]** or **[→]** until " 3. User Parameters " is displayed.

Key Op. Tools:
3.User Parameters

7 Press the **[OK]** key.

User Parameters:
1.Change

8 Press the **[←]** or **[→]** key until " 2. Print List " is displayed.

User Parameters:
2.Print List

9 Press the **[OK]** key.

10 Press the **[Start]** key to print the list.

User Parameters List:
Press Start to Print

Note

- If you press the **[Cancel]** key before printing starts, the list will not be printed and the display shown in step **8** appears again.

- 1** Press the **[User Tools]** key to return to the standby display.

Personal Codes

This function allows you to keep track of machine usage. When Personal Codes are programmed, users have to enter their Personal Code before they send a fax. This function is used for the Restricted Access. See p.65 "Restricted Access"

Important

- We recommend that you print the Personal Code List and keep it when you register or change a Personal Code. See p.64 "Printing the Personal Code List".

Limitation

- Personal Codes can be up to 8-digits long, and you can enter the following numbers and symbols : 0 to 9, #, *, and spaces.
- You can register up to 10 Personal Codes. Each Personal Code name can be up to 20 characters long.

Registering and Editing

- 1** Press the **[User Tools]** key.

- 2** Press **⏪** or **⏩** until " 4. Fax Features " is displayed.

- 3** Press the **[OK]** key.

- 4** Press **⏪** or **⏩** until " 4. Key Op. Tools " is displayed.

- 5** Press the **[OK]** key.

- 6** Press **⏪** or **⏩** until " 4. Personal Code " is displayed.

- 7** Press the **[OK]** key.

Confirm that " 1. Prog. Pers. Code " is displayed.

- 8** Press the **[OK]** key.

- 9** To register a new Personal Code , enter the Personal Code (8 digits or less) with the number keys. To edit a registered personal code, press **⏪** or **⏩** to display the desired Personal Code.

- 10** Press the **[OK]** key.

- 11** Enter the user name.

- 12** Press the **[OK]** key.

- 13** Press the **[User Tools]** key to return to the standby display.

Deleting

- 1 Press the **[User Tools]** key.

User Tools:
1.Counter

- 2 Press **[Left]** or **[Right]** until " 4. Fax Features " is displayed.

User Tools:
4.Fax Features

- 3 Press the **[OK]** key.

- 4 Press **[Left]** or **[Right]** until " 4. Key Op. Tools " is displayed.

Fax Features:
4.Key Op. Tools

- 5 Press the **[OK]** key.

Note

- If the key operator code is registered and turned on, enter the key operator code, and then press the **[OK]** key.

- 6 Press **[Left]** or **[Right]** until " 4. Personal Code " is displayed.

Key Op. Tools:
4.Personal Code

- 7 Press the **[OK]** key.

- 8 Press **[Left]** or **[Right]** until " 2. Delete " is displayed.

Personal Code:
2.Delete

- 9 Press the **[OK]** key.

- 10 Press **[Left]** or **[Right]** to display the Personal Code you want to delete.

Delete? **[Left]/[Right]**
11111111:DEF COMPANY

- 11 Press the **[OK]** key.

The Personal Code is deleted.

If you want to delete another Personal Code, repeat the above steps from step 9.

- 12 Press the **[User Tools]** key to return to the standby display.

Printing the Personal Code List

Print this list to find out the registered Personal Codes and their names.

- 1 Press the **[User Tools]** key.

User Tools:
1.Counter

- 2 Press **[Left]** or **[Right]** until " 4. Fax Features " is displayed.

User Tools:
4.Fax Features

- 3 Press the **[OK]** key.

- 4 Press **[Left]** or **[Right]** until " 4. Key Op. Tools " is displayed.

Fax Features:
4.Key Op. Tools

- 5 Press the **[OK]** key.

- 6** Press **◀** or **▶** until " 4. Personal Code " is displayed.

```
Key Op. Tools:
4. Personal Code  ◀▶
```

- 7** Press the **[OK]** key.

- 8** Press **◀** or **▶** until " 3. Print List " is displayed.

```
Personal Code:
3. Print List  ◀▶
```

- 9** Press the **[OK]** key.

- 10** Press the **[Start]** key.

The list is printed.

- 11** Press the **[User Tools]** key to return to the standby display.

Restricted Access

Use this function to limit transmission to specific users. When turned on, users must enter a previously assigned Personal Code in order to transmit documents.

The Restricted Access function makes it possible to monitor machine usage by user or department.

Preparation

In order to use this function, you need to register the Personal Code and turn this function on with the User Parameters beforehand. See p.63 "Registering and Editing". and p.58 "User Parameters" (Switch 05, Bit 4).

Note

- The machine returns to the state where a Personal Code must be entered to use the machine in the following situations:

- The machine is not used for a certain time
- A previously set document is removed
- The current operation is completed

- When Restricted Access is turned on, incoming faxes are received and printed as normal.

- 1** Check that the Restricted Access display is shown.

```
Pers. Code:
[■■■■■■■■]
```

- 2** Enter your personal code with the number keys.

```
Pers. Code:  Press OK
[*****]
```

- 3** Press the **[OK]** key.

ID Code

Use this procedure to register the following kinds of ID Codes:

Important

- ❑ You can confirm ID Codes in the Parameter Settings list. We recommend you print a new list each time you register or change ID Codes.
- ❑ You can edit registered ID Codes by performing the steps for registering ID Codes in the following procedure. Display the ID Code you want to change, and then press the **[Clear/Stop]** key and re-enter the ID Code.

❖ Polling ID

This ID is required for using Default ID Polling Reception. See p.5 "Calling to Request a Message (Polling Reception)"

Note

- ❑ You can enter A to F by the Quick Dial keys.
- ❑ You can enter 0 to 9 by the number keys.
- ❑ 0000 and FFFF can not be entered.

❖ Memory Lock ID

This ID is required for printing a message received using the Memory Lock function. See p.12 "Printing a Memory-locked Message".

Note

- ❑ You can enter 0 to 9 by the number keys.
- ❑ 0000 can not be entered.

Registering

To register ID Codes, perform the following procedure.

The following example is for Memory Lock ID.

- 1 Press the **[User Tools]** key.

```
User Tools:
1.Counter
```

- 2 Press **[Left]** or **[Right]** until " 4. Fax Features " is displayed.

```
User Tools:
4.Fax Features
```

- 3 Press the **[OK]** key.

- 4 Press **[Left]** or **[Right]** until " 4. Key Op. Tools " is displayed.

```
Fax Features:
4.Key Op. Tools
```

- 5 Press the **[OK]** key.

- 6 Press **[Left]** or **[Right]** until " 5. ID Code " is displayed.

```
Key Op. Tools:
5.ID Code
```

- 7 Press the **[OK]** key.

- 8 Press **[Left]** or **[Right]** until " 2. Memory Lock ID " is displayed.

```
ID Code:
2.Memory Lock ID
```

- 9 Press the **[OK]** key.

- 10** Enter the Memory Lock ID (4-digits) with the number keys.

Memory Lock ID: /OK
ID[1234]

If you make a mistake, press the **[Clear/Stop]** key and try again.

- 11** Press the **[OK]** key.

If you want to enter another item, repeat the above steps from step **9**.

- 12** Press the **[User Tools]** key to return to the standby display.

Line Type

You must register the Line Type before you connect the machine to the line.

Note

- This function is not available in some areas.
- If you do not know the type of line you are connected to, select "Tone" and dial a trial number. If the connection was successful, your Line Type is "Tone", if it was not, set the Line Type to "Pulse" and dial a trial number. If the connection was successful, your Line Type is "Pulse".

Limitation

- If you do not correctly set the Line Type, you will be able to receive messages, but you may not be able to send them.

To register the Line Type, perform the following procedure.

- 1** Press the **[User Tools]** key.

User Tools:
1.Counter

- 2** Press **[Left]** or **[Right]** until "4. Fax Features" is displayed.

User Tools:
4.Fax Features

- 3** Press the **[OK]** key.

- 4** Press **[Left]** or **[Right]** until "4. Key Op. Tools" is displayed.

Fax Features:
4.Key Op. Tools

- 5** Press the **[OK]** key.

- 6** Press **[Left]** or **[Right]** until "6. Line Type" is displayed.

Key Op. Tools:
6.Line Type

- 7** Press the **[OK]** key.

- 8** Press **[Left]** or **[Right]** and select "Tone" or "Pulse".

Line Type: /OK
Pulse [Tone]

- 9** Press the **[OK]** key.

- 10** Press the **[User Tools]** key to return to the standby display.

PSTN Access Number

Use this setting to save having to enter a pause after the PSTN access number when dialing. When you program an access number, a pause is automatically added as soon as that number is pressed. For example, if you register "0" as the PSTN Access Number, a pause will be inserted automatically after dialing "0".

Limitation

- PSTN access numbers can be up to 2 digits long.
- This function does not work when using On Hook mode or when dialing from an external telephone.

Note

- After you have registered PSTN access number, select the line to PABX on User Parameters (Switch 13 Bit 0).

To register an PSTN access number, perform the following procedure.

- 1** Press the **[User Tools]** key.

```
User Tools:
1.Counter
```

- 2** Press **⏪** or **⏩** until " 4. Fax Features " is displayed.

```
User Tools:
4.Fax Features
```

- 3** Press the **[OK]** key.

- 4** Press **⏪** or **⏩** until " 4. Key Op. Tools " is displayed.

```
Fax Features:
4.Key Op. Tools
```

- 5** Press the **[OK]** key.

- 6** Press **⏪** or **⏩** until " 7. PSTN Access No." is displayed.

```
Key Op. Tools:
7.PSTN Access No.
```

- 7** Press the **[OK]** key.

- 8** Enter the PSTN access number (2-digits) with the number keys.

If you make a mistake, press the **[Clear/Stop]** key and try again.

```
PSTN Access No.: /OK
[0]
```

- 9** Press the **[OK]** key.

" Programmed " is displayed.

- 10** Press the **[User Tools]** key to return to the standby display.

Memory File Transfer

If the machine cannot print out a received message, you can send all messages currently stored in memory to another fax machine and have them printed out there (for example, when toner is empty, paper has run out, or the printing function is out of order). All messages in memory including Memory-locked messages can be sent to another fax machine. Use this function when you are in an urgent situation.

Limitation

- Even if a transmission error occurs, messages are not resent.

Note

- All documents are not erased from memory regardless of whether forwarding was successful or not.
- Details of the forwarding operation are not printed in the Journal.

To transfer all of the messages currently stored in memory, perform the following procedure.

- 1** Press the **[User Tools]** key.

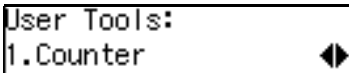

User Tools:
1.Counter

- 2** Press **⏪** or **⏩** until "4. Fax Features" is displayed.

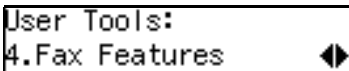

User Tools:
4.Fax Features

- 3** Press the **[OK]** key.

- 4** Press **⏪** or **⏩** until "4. Key Op. Tools" is displayed.

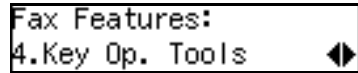

Fax Features:
4.Key Op. Tools

- 5** Press the **[OK]** key.

- 6** Press **⏪** or **⏩** to display "8. Mem. File Trans."

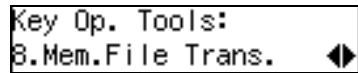

Key Op. Tools:
8.Mem.File Trans.

- 7** Press the **[OK]** key.

If no files are available, "No Files Exist" is displayed.

- 8** Enter the transfer destination's fax number with the number keys.

- 9** Press the **[Start]** key.

File transfer starts.

Once file transfer has finished, the machine returns to standby mode.

RDS (Remote Diagnostic System)

If your machine has a problem, a service representative can perform various diagnostic tasks over the telephone line from the service station to try to find out what is wrong with your machine. The service representative can also use RDS to change some of your machine's settings if you request it.

- 1** Press the **[User Tools]** key.

```
User Tools:
1.Counter
```

- 2** Press **⏪** or **⏩** until "4. Fax Features" is displayed.

```
User Tools:
4.Fax Features
```

- 3** Press the **[OK]** key.

- 4** Press **⏪** or **⏩** until "4. Key Op. Tools" is displayed.

```
Fax Features:
4.Key Op. Tools
```

- 5** Press the **[OK]** key.

- 6** Press **⏪** or **⏩** until "9. RDS On/Off" is displayed.

```
Key Op. Tools:
9.RDS On/Off
```

- 7** Press the **[OK]** key.

- 8** Press **⏪** or **⏩** and select "On" or "Off".

```
RDS On/Off:
[On] Off
```

- 9** Press the **[OK]** key.

- 10** Press the **[User Tools]** key to return to the standby display.

7. Troubleshooting

Reading Reports

Error Report

An error report is printed when a message could not be successfully sent or received.

Possible causes include a problem with your machine or noise on the telephone line. If an error occurs during transmission, re-send the original. If an error occurs during reception, ask the sender to re-send the message.

Note

- If the error happens frequently, contact your service representative.
- The "Page" column gives the total number of pages. The "Page Not Sent" column gives the number of pages that were not sent or received successfully.

Power Failure Report

Even if the main power switch is turned off, the contents of the machine's memory (for example, programmed numbers) will not be lost. However, if power is lost for about 12 hours through the main power switch being turned off, a power cut or the power cable being removed, contents of the Fax memory will be lost. Lost items will include any fax messages stored in memory using Memory Transmission or Reception.

If a file has been deleted from memory, a Power Failure Report is automatically printed as soon as power is restored. This report can be used to identify lost files. If a memory stored for Memory Transmission was lost, re-send it. If a message received by Memory Reception or Substitute Reception was lost, ask the sender to re-send it.

Important

- Make sure that 100% is shown on the display before you unplug the machine. If a lower value is shown, some data is currently stored in memory.
- Right after a power failure, the internal battery needs to be sufficiently recharged to guard against future data loss. Please keep the machine plugged in and the main power switch on for about one week after the power loss occurs.

8. Appendix

Connecting to a Telephone Line and a Telephone

To connect the machine to a telephone line, use a snap-in modular type connector.

Important

- Make sure the connector is the correct type before you start.
- By law in the United States, you must program your phone number identification (your OWN FAX NUMBER) into your machine before you can connect the public phone system. See chapter3 "Own Name/Fax Header/Own Fax Number" in the Basic Features manual.

◆ Where to connect the machine

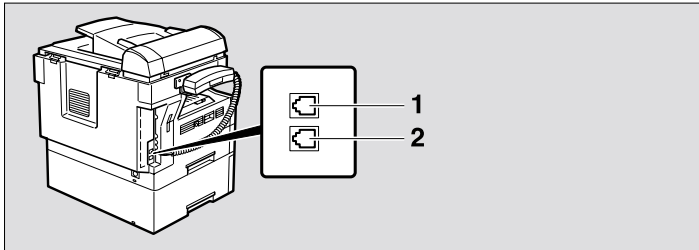

ZFKH070N

1. External Telephone

2. Line

Connecting the Optional Handset and an External Telephone

You can connect the handset and an external telephone to the machine. You can use them for telephone calls.

Note

- Some telephone may not be connected or may suffer reduced functionality.

Limitation

- When you use the handset or an optional external telephone with the **[On Hook Dial]** key for telephone calls, you can not talk with the other party without pressing the **[On Hook Dial]** or **[Clear/Stop]** key after taking off the receiver.

Specifying the handset line type

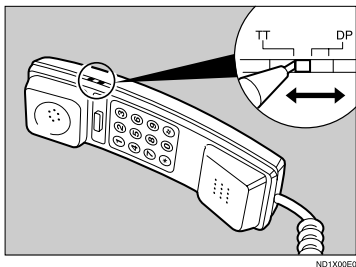

The switch on the handset should be in the appropriate position-TT (Tone Dialing) or DP (Pulse Dialing).

Adjusting the handset bell volume

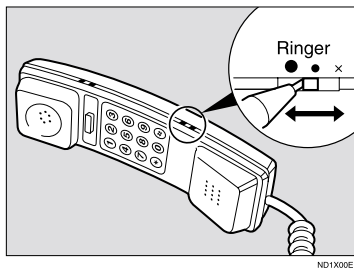

Adjust the handset ringer volume using the volume switch.

Specifications

Base Machine

❖ Power Consumption

Standby mode	100W
Immediate Transmission	130W
Immediate Reception	290W
Printing	480W
Night Timer Off mode	2W
Low-Power mode, Auto Off Mode	2W

❖ Protocol:

G3

❖ Resolution:

- Standard: 8×3.85/mm
- Detail: 8×7.7/mm
- Fine: 8×15.4/mm

❖ Transmission Time:

3 seconds at 28,800bps, Standard resolution

❖ Data Compression Method:

MH, MR, MMR

❖ Maximum Original Size:

216×1260mm / 8.5"×49.6" (Standard and Detail)
216×600mm / 8.5"×23.7" (Fine)

❖ Maximum Scanning Size:

216×1260mm / 8.5"×49.6" (Standard and Detail)
216×600mm / 8.5"×23.7" (Fine)

❖ Print Process:

Printing on standard paper using a laser

❖ Transmission Speed:

33,600/31,200/28,800/26,400/24,000/21,600/19,200/16,800/14,400/12,000/
9,600/7,200/4,800/2,400bps (auto shift down system)

Available Options

- ◆ **Expansion Memory (32MB)**
Increase memory capacity.
- ◆ **Paper Tray Unit (Option for Model B only)**
Holds 500 sheets of paper.
- ◆ **Document Feeder (ADF) (Option for Type1)**
Originals will be fed automatically.
- ◆ **Handset (Handset Type 1018)**
This permits voice communication.

Originals

Make sure your originals are completely dry before placing them in the machine. Originals containing wet ink or correcting fluid will mark the exposure glass and affect the resulting image.

Sizes and weights of Recommended Originals

Where Original is Placed	Acceptable Original Size	Maximum Number of Sheets	Paper Thickness
Exposure glass	Maximum A4 (210×297mm) □, 8 ¹ / ₂ "×11" (216×279mm) □	1	----
Document Feeder (ADF)	Fax transmission: A5 □ to A4 □ (up to 1260mm long), 8 ¹ / ₂ "×11" □ to 8 ¹ / ₂ "×14" □	30 sheets (80g/m ² , 21 lb)	52–105g/m ² (45–90kg, 14–28 lb)

Paper Size and Scanned Area

◆ Exposure Glass

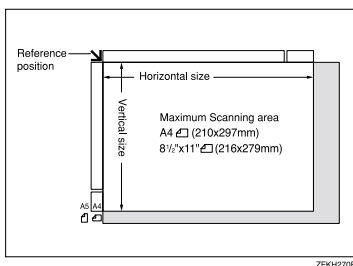

❖ Document Feeder (ADF)

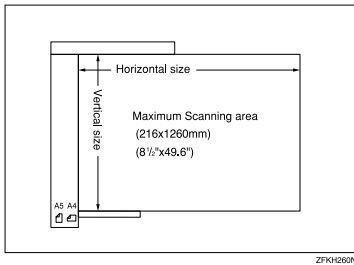

! Limitation

- Even if an original is correctly placed on the exposure glass or in the Document Feeder, a margin of 3mm to 5mm (0.1" to 0.2") around each edge of the original may not be sent.
- There may be a difference in the size of the image when it is printed at the destination.

✎ Note

- The maximum scanning area on ADF is 1260mm (49.6") when the Resolution is Detail or Standard, 600mm (23.7") when it is Fine.
- If the receiver uses paper narrower than the original, the image will be reduced to fit the paper width.

Maximum Values

The following list contains the maximum value for each item.

Item	Standard
Memory	1MB
The number of pages that you can store in memory (Using A4 size Standard <ITU-T #1Chart, Resolution: Standard, Original Type: Text >)	80 (320 with Optional Memory)
Total number of Memory Transmission files	133
The number of pages per file	500
The number of pages for all files	500
The number of destinations you can specify for one file	133
The number of destinations you can specify for all files	300
The number of Quick Dials you can register	16
The number of Speed Dials you can register	50
The number of Group Dials you can register	5
The number of destinations you can specify by the number keys	67
The number of destinations you can register in a group	133
The number of destinations you can register in all groups	133
The number of personal codes you can register	10
The number of digits for Dials	254

Advanced Transmission Features

Functions selectable with the **【Trans. Option】** key are as follows.

Function name	Description	Reference
Send Later	Sets the machine to automatically start transmission or polling reception at an appointed time.	p.1 "Sending at a Specific Time (Send Later)"
Fax Header Print	You can add a Fax Header (e.g. registered name) to the message you send so it appears on the message printed by the receiving machine.	p.3 "Fax Header Print"
Polling Reception	Use this function if you want to poll a message from another terminal.	p.5 "Calling to Request a Message (Polling Reception)"

Job Information

Functions selectable with the **【Job Information】** key are as follows.

Function name	Description	Reference
Canceling Transmission or Reception	This function cancels a file (reservation) for Memory Transmission or Polling Reception.	p.9 "Canceling Transmission or Reception"
Printing the File List	The transmission file list can be manually printed. This list allows you to know what files are stored in memory and the file numbers.	p.10 "Printing a List of Files in Memory (Print File List)"
Printing a Stored Message	Prints the contents of a fax that is stored in memory and has not been sent yet.	p.11 "Printing a Stored Message (Print TX File)"
Printing a Memory-locked Message	The Memory-locked messages can be manually printed. To print the messages, you have to enter the Memory Lock ID.	p.12 "Printing a Memory-locked Message"
Printing the Journal	The Journal can be manually printed. This report shows the results of the last 50 communications.	p.13 "Printing the Journal"

User Tools

Function name	Description	Reference
Register/Delete Quick Dial	When you register a destination in a Quick Dial, you can specify the destination by only pressing the Quick Dial key.	Chapter3 "Quick Dial" in the Basic Features manual.
Register/Delete Speed Dial	When you register a destination in a Speed Dial, you can specify the destination by entering the two-digit Speed Dial code after pressing the Speed Dial key.	Chapter3 "Speed Dial" in the Basic Features manual.
Register/Delete Group Dial	If you program several destinations into a Group, you can dial with just a few key-strokes.	Chapter3 "Groups" in the Basic Features manual.
Assigning User Function Keys	Stores a frequently used function in a User Function Key (F1) to (F3).	p.35 "User Function Keys"
Reports/Lists	This function allows you to print various reports and lists manually. You can print the following reports and lists: <ul style="list-style-type: none"> • Journal • Transmission File List • Quick Dial list • Speed Dial list • Group Dial list • Quick Dial Label • User Function List 	p.39 "Printing Reports/Lists"
Monitor Volume	Adjusts the volume of monitoring and beeper sounds from the speaker inside the machine.	Chapter4 "Adjusting Volume" in the Basic Features manual.
Display Contrast	Adjust the brightness of the display.	p.42 "Adjusting the Display Contrast"
Date/Time	Adjusts the date and the time as a reference.	p.43 "Setting the Date and Time"
Reception Mode	The machine can treat incoming fax messages and telephone calls in two ways.	Chapter 2 "Reception Modes" in the Basic Features manual.

Function name	Description	Reference
Setting the Auto Ring Time	You can alter the number of rings by changing the Auto Ring Time.	p.45 "Setting the Auto Ring Time"
Fax Information	Registers your Own Name, Fax Header and Own Fax Number.	Chapter3 "Own Name /Fax Header / Own Fax Number" in the Basic Features manual.
Fax Reset Timer	You can select a period of time before this machine automatically returns to the standby mode.	p.46 "Setting the Fax Reset Timer"
On Hook Timeout	You can select a period before the machine cancels the On Hook Dial mode.	p.47 "On Hook Timeout"

Key Operator Tools

Function name	Description	Reference
Memory Lock	All received messages are stored in memory and are not automatically printed.	p.50 "Memory Lock"
Forwarding	Transfers received messages to a registered receiver (forwarding destination).	p.52 "Forwarding"
Changing User Parameters	Allows you to change the function settings to meet your needs.	p.58 "User Parameters"
Printing User Parameter List	Allows you to print and check User Parameter settings.	p.62 "Printing the User Parameter List"
Personal Code	Personal Code is used for Restricted Access. When turn the Restricted Access on, users must enter the Personal Code in order to transmit documents.	p.63 "Personal Codes"
ID Code	Registers the ID required for using Polling Reception and Memory Lock.	p.66 "ID Code"
Line Type	Registers the type of line (Tone or Pulse) you are connected to.	p.67 "Line Type"
PSTN Access Number	Allows you to specify the code used to access an outside line when dialing.	p.68 "PSTN Access Number"
Memory File Transfer	You can send all messages currently stored in memory to another fax and have them printed out there.	p.69 "Memory File Transfer"
RDS On/Off	Allows you to switch on RDS (Remote Diagnostic system) to a service representative can test your fax machine remotely from a service station, diagnose the problem, and can change your machine settings to correct the problem.	p.70 "RDS (Remote Diagnostic System)"

INDEX

A

Adjusting Volume→Monitor Volume, 81
Advanced Transmission Features, 79
Assigning User Function Keys, 36, 81
Auto Fax Reception Power-up, 29
Automatic Redial, 23
Auto Ring Time, 45, 82

B

Batch Transmission, 23
Broadcasting Sequence, 23

C

Canceling Transmission or Reception, 9, 80
Center Mark, 30
Chain Dial, 15
Changing Key Operator Settings, 50
Changing User Parameters, 83
Checkered Mark, 30
Communication Failure Report, 25
Communication Result Report, 25
Communication Result Report (Polling RX), 7

D

Date and Time, 43
Date/Time, 81
Deleting
 Forwarding Station, 55
 Specified Sender, 56
 Specified Sender for Memory Lock, 51
Display Contrast, 42, 81
Dual Access, 24

E

ECM (Error Correction Mode), 24
Editing
 Forwarding Station, 54
 Specified Sender, 55
Error Report, 71
External Telephone, 74

F

Fax Header Print, 3, 79
Fax Information, 82
Fax Reset Timer, 46, 82
File Reserve Report, 25
File Reserve Report (Polling RX), 7
Forwarding, 52, 83
Forwarding Station, 53, 54, 55
Function List
 Advanced Transmission Features, 79
 Job Information, 80
 Key Operator Settings, 49, 83

G

Group Dial, 81
Group Dial List, 40

H

Handset, 74
Handy Dialing Functions, 15

I

ID Code, 66, 83
Immediate Reception, 27

J

Job Information, 9, 80
Journal, 13, 39, 80

K

Key Operator Settings, 49
Key Operator Tools, 83

L

Label Insertion, 4
Line Type, 67, 83

M

Manual Dial, 18
Maximum Values, 78
Memory File Transfer, 69, 83
Memory Lock, 50, 83
Memory-locked Message, 12, 80
Memory Lock ID, 66
Memory Reception, 27
Monitor Volume, 81
More Transmission Functions, 22

O

On Hook Dial, 17
On Hook Timeout, 47, 82
Options, 76
Originals, 76
Other Transmission Features, 15
Outside Line Access Number → PSTN
Access Number, 68

P

Page Separation and Length Reduction, 31
Parallel Memory Transmission, 24
Personal Code, 63, 83
Personal Code List, 64
Polling ID, 66
Polling Reception, 5, 79
Polling Reserve Report → File Reserve
Report (Polling RX), 7
Polling Result Report → Communication
Result Report (Polling RX), 7
Power Failure Report, 71
Printed Report, 25
Print File List, 10
Printing
 Group Dial List, 39
 Journal, 13, 39, 80
 List of Files in Memory, 10, 80
 List of Specified Senders for Memory Lock, 51
 Memory-locked Message, 12, 80
 Quick Dial Label, 39
 Quick Dial List, 39
 Reports/Lists, 39
 Specified Sender list, 57
 Speed Dial List, 39
 Stored Message, 11, 80
 TX File List, 39
 User Function List, 39
 User Parameter List, 83

Printing Options, 30
Print TX File, 11
PSTN Access Number, 68, 83
PWD, 19

Q

Quick Dial, 81
Quick Dial Label, 39
Quick Dial List, 40

R

RDS, 70
RDS On/Off, 83
Reception
 Auto Fax Reception Power-up, 29
 Immediate Reception, 27
 Memory Reception, 27
 Receiving Messages in Telephone Mode, 29
 *Screening Out Messages from
 Anonymous Senders*, 28
 Substitute Reception, 28
Reception Features, 27
Reception Mode, 81
Reception Time, 31
Redial, 16
Register/Delete
 Group Dial, 81
 Quick Dial, 81
 Speed Dial, 81
Registering
 Forwarding Station, 53
 ID Codes, 66
 Specified Sender for Memory Lock, 51
Report, 71
Report Formats, 14
Reports, 25
 Communication Failure Report, 25
 Communication Result Report, 25
 Error Report, 71
 File Reserve Report, 25
 Journal, 13, 14
 Power Failure Report, 71
 Reports/Lists, 39
 *Transmission Result Report
 (Immediate Transmission)*, 26
Reports/Lists, 39, 81
Restricted Access, 65

S

- Secured Polling Reception, 5
- Send Later, 1, 79
- SEP Code, 19
- SID, 20
- Specifications, 75
- Specified Sender, 55, 56
- Specified Sender list, 57
- Speed Dial, 81
- Speed Dial List, 40
- Stored ID Override Polling Reception, 5
- Stored Message, 11
- SUB Code, 20
- Substitute Reception, 28
- Switches and Bits, 58

T

- Telephone Directory, 16
- Telephone Line, 73
- Telephone Mode, 29
- Transmission Features, 15, 19
- Transmission Options, 1
- Transmission Result Report
(Immediate Transmission), 26
- Troubleshooting, 71
- TSI Print, 30
- TTI Print → Fax Header Print, 3
- TX File List, 39

U

- User Function key
 - Deleting*, 37
 - Using*, 37
- User Function Keys, 35, 81
- User Function keys
 - Making key assignment*, 36
- User Function List, 39
- User Parameter List, 58, 83
- User Parameters, 58, 83
- User Tools, 35, 81

USA

◆ FCC Requirements

1. This equipment complies with Part 68 of the FCC rules. On the cover of this equipment is a label that contains, among other information, the FCC registration number and ringer equivalence number (REN) for this equipment. If requested, this information must be provided to the telephone company.
2. This equipment uses the following USOC jack: RJ11C
An FCC compliant telephone cord and modular plug is provided with this equipment. This equipment is designed to be connected to the telephone network or premises wiring using a compatible modular jack that is Part 68 compliant. See the Operating Instructions for details.
3. The REN is used to determine the quantity of devices which may be connected to the telephone line. Excessive REN's on the telephone line may result in the devices not ringing in response to an incoming call. Typically, the sum of the REN's should not exceed five (5.0). Contact the telephone company to determine the maximum REN for the calling area.
4. If this equipment causes harm to the telephone network, the telephone company will notify you in advance that temporary discontinuance of service may be required. But if advance notice is not practical, the telephone company will notify the customer as soon as possible. Also, you will be advised of your right to file a complaint with the FCC if you believe it is necessary.
5. The telephone company may make changes to its facilities, equipment, operations, or procedures that could affect the operation of the equipment. If this happens, the telephone company will provide advance notice so that you can make the necessary modifications to maintain uninterrupted service.
6. In the event of operation problems (document jam, copy jam, communication error indication), refer to the solving problems section in this manual.
7. If you cannot correct the problem, please contact the RICOH CORP. CUSTOMER SUPPORT DEPT. at 1-800-FASTFIX for repair or warranty information. If the equipment is causing harm to the telephone network, the telephone company may request you to disconnect the equipment from the network until the problem is resolved.
8. This equipment cannot be used telephone company-provided coin service. Connection to Party Line Service is subject to state tariffs.

◆ WHEN PROGRAMMING EMERGENCY NUMBERS AND/OR MAKING TEST CALLS TO EMERGENCY NUMBERS:

1. Remain on the line and briefly explain to the dispatcher the reason for the call before hanging up.
2. Perform such activities in the off-peak hours, such as early morning hours or late evenings.

CANADA

The Industry Canada label identifies certified equipment. This certification means that the equipment meets telecommunications network protective, operational, and safety requirements as prescribed in the appropriate Terminal Equipment Technical Requirements document(s). The department does not guarantee the equipment will operate to the user's satisfaction.

Before installing this equipment, users should ensure that it is permissible to be connected to the facilities of the local telecommunications company. The equipment must also be installed using an acceptable method of connection. The customer should be aware that compliance with the above conditions may not prevent degradation of service in some situations.

Repairs to certified equipment should be coordinated by a representative designated by the supplier. Any repairs or alterations made by the user to this equipment, or equipment malfunctions, may give the telecommunications company cause to request the user to disconnect the equipment.

User should ensure for their own protection that the electrical ground connections of the power utility, telephone lines, and internal metallic water pipe system, if present, are connected together. This precaution may be particularly important in rural areas.

Caution: Users should not attempt to make such connections themselves, but should contact the appropriate electric inspection authority, or electrician, as appropriate.

The Ringer Equivalence Number (REN) assigned to each terminal device provides an indication of the maximum number of terminals allowed to be connected to a telephone interface. The termination on an interface may consist of any combination of devices subject only to the requirement that the sum of the Ringer Equivalence Numbers of all the devices does not exceed 5.



Operating Instructions Facsimile Reference



Printed in China

UE (USA) B465-8607

Free Manuals Download Website

<http://myh66.com>

<http://usermanuals.us>

<http://www.somanuals.com>

<http://www.4manuals.cc>

<http://www.manual-lib.com>

<http://www.404manual.com>

<http://www.luxmanual.com>

<http://aubethermostatmanual.com>

Golf course search by state

<http://golfingnear.com>

Email search by domain

<http://emailbydomain.com>

Auto manuals search

<http://auto.somanuals.com>

TV manuals search

<http://tv.somanuals.com>