

Paper type: OK Prince Eco G100(55kg), Paper Thickness=80 μm // Pages in book=84 // Print scale=81%  
Gap (when printed at 81% scale) = Pages in book × Paper thickness / 2 = 4.200000 mm

**3725**  
**F9103**

**Operating Instructions**  
**<Basic Features>**

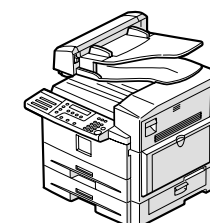

- 1** Getting Started
- 2** Faxing
- 3** Registering
- 4** Troubleshooting

Type for 3725/F9103/LF310/3310L  
Printed in China  
UE (USA) H555-8600

For safety, please read this manual carefully before you use this product and keep it handy for future reference.

## Introduction

This manual contains detailed instructions on the operation and maintenance of this machine. To get maximum versatility from this machine all operators should carefully read and follow the instructions in this manual. Please keep this manual in a handy place near the machine.

Please read the Safety Information in the Basic Features manual before using this machine. It contains important information related to USER SAFETY and PREVENTING EQUIPMENT PROBLEMS.

### Notes:

Some illustrations in this manual might be slightly different from the machine.

Certain options might not be available in some countries. For details, please contact your local dealer.

### Laser Safety:

#### CDRH Regulations

This equipment complies with requirements of 21 CFR subchapter J for class 1 laser products. This equipment contains a 5 milliwatt, 760–800 nanometer wavelength, GaAlAs laser diode. This equipment does not emit hazardous light, since the beam is totally enclosed during all customer modes of operation and maintenance.

### Warning:

Use of controls or adjustment or performance of procedures other than those specified in this manual might result in hazardous radiation exposure.

Two kinds of size notation are employed in this manual. With this machine refer to the inch version.

For good copy quality, the supplier recommends that you use genuine toner from the supplier.

The supplier shall not be responsible for any damage or expense that might result from the use of parts other than genuine parts from the supplier with your office products.

### Important

Contents of this manual are subject to change without prior notice. In no event will the company be liable for direct, indirect, special, incidental, or consequential damages as a result of handling or operating the machine.

### Power Source:

115V, 60Hz

Please be sure to connect the power cord to a power source as above. For details about power source, see Chapter 10, "Connecting the Power and Switching On" in the Advanced Features manual.

### Declaration of Conformity

Product Name: Facsimile

Model Number: 3725/F9103/LF310AG/3310L

Responsible party: Ricoh Corporation

Address: 5 Dedrick Place, West Caldwell, NJ 07006

Telephone number: 973-882-2000

This device complies with part 15 of FCC Rules.

Operation is subject to the following two conditions:

1. This device may not cause harmful interference, and
2. this device must accept any interference received, including interference that may cause undesired operation.

## USA

### ❖ FCC Requirements

1. This equipment complies with Part 68 of the FCC rules. On the cover of this equipment is a label that contains, among other information, the FCC registration number and ringer equivalence number (REN) for this equipment. If requested, this information must be provided to the telephone company.
2. The following is applicable only for an equipment using an analog G3 line.  
This equipment uses the RJ11C USOC jack.  
An FCC compliant telephone cord and modular plug is provided with this equipment. This equipment is designed to be connected to the telephone network or premises wiring using a compatible modular jack that is Part 68 compliant. See the Operating Instructions for details.
3. The REN is used to determine the quantity of devices which may be connected to the telephone line. Excessive REN's on the telephone line may result in the devices not ringing in response to an incoming call. Typically, the sum of the REN's should not exceed five (5.0). Contact the telephone company to determine the maximum REN for the calling area.
4. If this equipment causes harm to the telephone network, the telephone company will notify you in advance that temporary discontinuance of service may be required. But if advance notice is not practical, the telephone company will notify the customer as soon as possible. Also, you will be advised of your right to file a complaint with the FCC if you believe it is necessary.
5. The telephone company may make changes to its facilities, equipment, operations, or procedures that could affect the operation of the equipment. If this happens, the telephone company will provide advance notice so that you can make the necessary modifications to maintain uninterrupted service.
6. In the event of operation problems (document jam, copy jam, communication error indication), refer to the solving problems section in this manual.
7. If you cannot correct the problem, please contact the RICOH CORP. CUSTOMER SUPPORT DEPT. at 1-800-FASTFIX for repair or warranty information. If the equipment is causing harm to the telephone network, the telephone company may request you to disconnect the equipment from the network until the problem is resolved.
8. This equipment cannot be used with telephone company-provided coin service. Connection to Party Line Service is subject to state tariffs.

### ❖ WHEN PROGRAMMING EMERGENCY NUMBERS AND/OR MAKING TEST CALLS TO EMERGENCY NUMBERS:

1. Remain on the line and briefly explain to the dispatcher the reason for the call before hanging up.
2. Perform such activities in the off-peak hours, such as early morning hours or late evenings.

## CANADA

The Industry Canada label identifies certified equipment. This certification means that the equipment meets telecommunications network protective, operational, and safety requirements as prescribed in the appropriate Terminal Equipment Technical Requirements document(s). The department does not guarantee the equipment will operate to the user's satisfaction.

Before installing this equipment, users should ensure that it is permissible to be connected to the facilities of the local telecommunications company. The equipment must also be installed using an acceptable method of connection. The customer should be aware that compliance with the above conditions may not prevent degradation of service in some situations.

Repairs to certified equipment should be coordinated by a representative designated by the supplier. Any repairs or alterations made by the user to this equipment, or equipment malfunctions, may give the telecommunications company cause to request the user to disconnect the equipment.

User should ensure for their own protection that the electrical ground connections of the power utility, telephone lines, and internal metallic water pipe system, if present, are connected together. This precaution may be particularly important in rural areas.

Caution: Users should not attempt to make such connections themselves, but should contact the appropriate electric inspection authority, or electrician, as appropriate.

The Ringer Equivalence Number (REN) assigned to each terminal device provides an indication of the maximum number of terminals allowed to be connected to a telephone interface. The termination on an interface may consist of any combination of devices subject only to the requirement that the sum of the Ringer Equivalence Numbers of all the devices does not exceed 5.

In accordance with IEC 60417, this machine uses the following symbols for the main power switch:

- means POWER ON.
- means POWER OFF.

Copyright © 2001

# TABLE OF CONTENTS

<b>NOTICE</b> .....	<b>1</b>
Safety Information .....	3
Safety During Operation .....	3
<b>Important Safety Instructions</b> .....	<b>5</b>
Grounding .....	5
Important Safety Instructions .....	5
Caution .....	5
<b>Positions of Labels and Hallmarks for <math>\Delta</math>WARNING and <math>\Delta</math>CAUTION ...</b>	<b>6</b>
<b>ENERGY STAR Program</b> .....	<b>7</b>
Energy Saving Modes .....	8
Recycled Paper .....	9
<b>How to Read this Manual</b> .....	<b>10</b>
Symbols .....	10
<b>Manuals for This Machine</b> .....	<b>11</b>
Basic Features (this manual) .....	11
Advanced Features .....	11

## 1. Getting Started

<b>Guide to Components</b> .....	<b>13</b>
Front View .....	13
Side View .....	14
<b>Control Panel</b> .....	<b>15</b>
<b>Starting the Machine</b> .....	<b>17</b>
Turning On the Power .....	17
Turning Off the Power .....	17
<b>Reading the Display</b> .....	<b>18</b>
Reading the Display and Using Keys .....	18
Standby Display .....	18
Communication Display .....	19
Display Prompts .....	19

## 2. Faxing

<b>Transmission Modes</b> .....	<b>21</b>
Switching between Memory Transmission and Immediate Transmission....	22
<b>Setting Originals</b> .....	<b>23</b>
Loading Originals in the Document Feeder.....	24
Original Sizes Difficult to Detect.....	24
<b>Memory Transmission</b> .....	<b>25</b>
<b>Canceling a Memory Transmission</b> .....	<b>27</b>
Before the Start Key is Pressed .....	27
While the Original is Being Scanned .....	27
During Transmission .....	27
While the Original is Awaiting Transmission .....	28
<b>Immediate Transmission</b> .....	<b>29</b>
<b>Canceling an Immediate Transmission</b> .....	<b>31</b>
Before the Start key is Pressed.....	31
After the Start key is Pressed.....	31
<b>Scan Settings</b> .....	<b>32</b>
Resolution .....	32
Original Type.....	33
<b>Dialing</b> .....	<b>34</b>
Entering Numbers Directly .....	34
Pause.....	35
Tone.....	35
Using Quick Dials.....	35
Using Speed Dials.....	36
Using Groups .....	37
When Specifying a Group with a Quick Dial .....	38
When Specifying a Group with the Group key.....	38
<b>Reception Modes</b> .....	<b>39</b>
Selecting the Reception Mode .....	39

## 3. Registering

<b>Own Name/Fax Header/Own Fax Number</b> .....	<b>41</b>
Registering .....	42
Editing .....	44
Deleting.....	45
<b>Quick Dial</b> .....	<b>46</b>
Registering .....	46
Editing .....	48
Deleting .....	49
Quick Dial Key Label (Dial label).....	50
Label paper.....	51

<b>Speed Dial .....</b>	<b>52</b>
Registering .....	52
Editing .....	54
Deleting .....	55
<b>Groups.....</b>	<b>57</b>
Registering .....	57
Editing .....	60
Editing a Group Name .....	60
Adding a Fax Number to a Group.....	61
Deleting.....	63
To delete a destination from a group.....	63
To delete an entire group.....	65
<b>Entering Characters .....</b>	<b>67</b>
Available Characters .....	67
Keys .....	67
How to Enter Characters.....	68

## **4. Troubleshooting**

---

<b>Loading Paper in the Main Paper Tray .....</b>	<b>69</b>
<b>Adjusting Volume.....</b>	<b>70</b>
<b>Clearing Original Jams .....</b>	<b>72</b>
<b>Clearing a Copy, Fax, or Print Jam .....</b>	<b>73</b>
Inside the Machine .....	73
<b>Error Messages.....</b>	<b>74</b>
<b>When the Receive File Indicator is Lit.....</b>	<b>76</b>
<b>Solving Problems .....</b>	<b>77</b>
<b>INDEX.....</b>	<b>78</b>

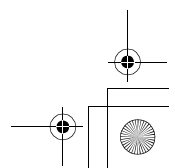
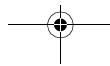
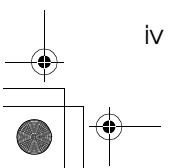
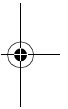
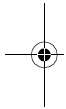
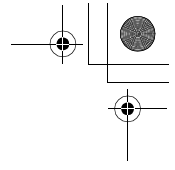
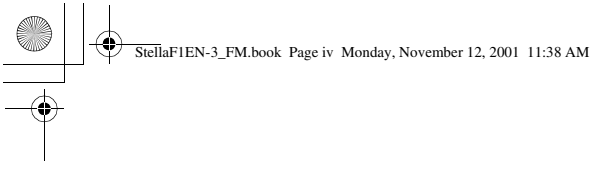

## NOTICE

---

### **CAUTION:**

---

Use of controls, adjustments or performance of procedures other than those specified herein may result in hazardous radiation exposure.

Shielded interconnect cables must be employed with this equipment to ensure compliance with the pertinent RF emission limits governing this device.

Direct (or indirect reflected) eye contact with the laser beam may cause serious eye damage. Safety precautions and interlock mechanisms have been designed to prevent any possible laser beam exposure to the operator.

---

### Note to users in the United States of America

---

 **Notice:**

This equipment has been tested and found to comply with the limits for a Class B digital device, pursuant to Part 15 of the FCC Rules. These limits are designed to provide reasonable protection against harmful interference in a residential installation. This equipment generates, uses and can radiate radio frequency energy and, if not installed and used in accordance with the instructions, may cause harmful interference to radio communications. However, there is no guarantee that interference will not occur in a particular installation. If this equipment does cause harmful interference to radio or television reception, which can be determined by turning the equipment off and on, the user is encouraged to try to correct the interference by one more of the following measures:

- Reorient or relocate the receiving antenna.
- Increase the separation between the equipment and receiver.
- Connect the equipment into an outlet on a circuit different from that to which the receiver is connected.
- Consult the dealer or an experienced radio /TV technician for help.

 **Warning**

Changes or modifications not expressly approved by the party responsible for compliance could void the user's authority to operate the equipment.

---

**Note to users in Canada**

---

•••••  
 **Note:**

This Class B digital apparatus complies with Canadian ICES-003.

•••••

---

**Remarque concernant les utilisateurs au Canada**

---

•••••  
 **Avertissement:**

Cet appareil numérique de la classe B est conforme à la norme NMB-003 du Canada.

•••••

•••••  
 **Notice about the Telephone Consumer Protection Act (Valid in USA only).**

The Telephone Consumer Protection Act of 1991 among other things makes it unlawful for any person to send any message via a telephone fax machine unless such message clearly contains in a margin at the top or bottom of each transmitted page or on the first page of the transmission, the date and time it is sent and an identification of the business, other entity, or other individual sending the message and the telephone number of the sending machine or such business, other entity or individual. This information is transmitted with your document by the TTI (Transmit Terminal Identification) feature. In order for you to meet the requirement, your machine must be programmed by following the instructions in the accompanying Operation Manual. In particular, please refer to the chapter of Installation. Also refer to the TTI (Transmit Terminal Identification) programming procedure to enter the business identification and telephone number of the terminal or business. Do not forget to set the date and time.

Thank you.

For this machine, TTI is called FAX HEADER.

•••••



---

## Safety Information

---



When using this machine, the following safety precautions should always be followed.

---

### Safety During Operation

---

In this manual, the following important symbols are used:

- |  |
|--|
| <p> <b>WARNING:</b><br/><i>Indicates a potentially hazardous situation which, if instructions are not followed, could result in death or serious injury.</i></p> <p> <b>CAUTION:</b><br/><i>Indicates a potentially hazardous situation which, if instructions are not followed, may result in minor or moderate injury or damage to property.</i></p> |
|--|

---

### **WARNING:**

---

- |  |
|--|
| <ul style="list-style-type: none"><li>• <b>Connect the power cord directly into a wall outlet and never use an extension cord.</b></li><li>• <b>Disconnect the power plug (by pulling the plug, not the cable) if the power cable or plug becomes frayed or otherwise damaged.</b></li><li>• <b>To avoid hazardous electric shock or laser radiation exposure, do not remove any covers or screws other than those specified in this manual.</b></li><li>• <b>Turn off the power and disconnect the power plug (by pulling the plug, not the cable) if any of the following occurs:</b><ul style="list-style-type: none"><li>• <b>You spill something into the machine.</b></li><li>• <b>You suspect that your machine needs service or repair.</b></li><li>• <b>The external housing of your machine has been damaged.</b></li></ul></li><li>• <b>Do not incinerate spilled toner or used toner. Toner dust might ignite when exposed to an open flame.</b></li><li>• <b>Disposal can take place at our authorized dealer.</b></li><li>• <b>Dispose of the used toner cartridge in accordance with the local regulations.</b></li></ul> |
|--|

---

**⚠ CAUTION:**

---

- *Protect the machine from dampness or wet weather, such as rain and snow.*
- *Unplug the power cord from the wall outlet before you move the machine. While moving the machine, you should take care that the power cord will not be damaged under the machine.*
- *When you disconnect the power plug from the wall outlet, always pull the plug (not the cable).*
- *Do not allow paper clips, staples, or other small metallic objects to fall inside the machine.*
- *Keep toner (used or unused) and toner cartridge out of the reach of children.*
- *For environmental reasons, do not dispose of the machine or expended supply waste at household waste collection points. Disposal can take place at an authorized dealer.*
- *The inside of the machine could be very hot. Do not touch the parts with a label indicating the "hot surface". Otherwise an injury might occur.*
- *Our products are engineered to meet high standards of quality and functionality, and we recommend that you use only the expendable supplies available at an authorized dealer.*

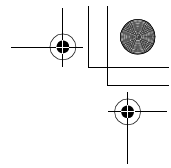
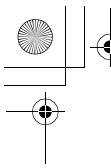

## Important Safety Instructions

---

### Grounding

---

In order to prevent potentially hazardous electrical shock, provide means of connecting to the protective grounding conductor in the building, wiring those grounding conductors of power cable and 3 pins plug.

---

### Important Safety Instructions

---

---

#### Caution

---

When using your telephone equipment, basic safety precautions should always be followed to reduce the risk of fire, electric shock and injury to persons, including the following:

- Do not use this product near water, for example, near a bath tub, wash bowl, kitchen sink or laundry tub, in a wet basement or near a swimming pool.
- Avoid using a telephone during an electrical storm. There may be a remote risk of electric shock from lightning.
- Do not use a telephone in the vicinity of a gas leak to report the leak.
- Use only the power cord and batteries indicated in this manual. Do not dispose of batteries in a fire. They may explode. Check with local codes for possible special disposal instructions.

Save these instructions.

#### IMPORTANTES MESURES DE SÉCURITÉ

Certaines mesures de sécurité doivent être prises pendant l'utilisation de matériel téléphonique afin de réduire les risques d'incendie, de choc électrique et de blessures. En voici quelquesunes:

- Ne pas utiliser l'appareil près de l'eau, p.ex., près d'une baignoire, d'un lavabo, d'un évier de cuisine, d'un bac à laver, dans un sous-sol humide ou près d'une piscine.
- Éviter d'utiliser le téléphone (sauf s'il s'agit d'un appareil sans fil) pendant un orage électrique. Ceci peut présenter un risque de choc électrique causé par la foudre.
- Ne pas utiliser l'appareil téléphonique pour signaler une fuite de gaz s'il est situé près de la fuite.
- Utiliser seulement le cordon d'alimentation et le type de piles indiqués dans ce manual. Ne pas jeter les piles dans le feu: elles peuvent exploser. Se conformer aux égrlements pertinents quant à l'élimination des piles.

Conserver ces instructions.

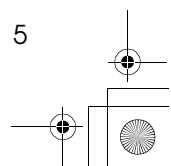
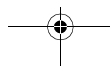
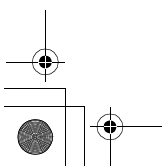

## Positions of Labels and Hallmarks for ⚠WARNING and ⚠CAUTION

This machine has labels and hallmarks for ⚠WARNING, ⚠CAUTION at the positions shown below. For safety, please follow the instructions and handle the machine as indicated.

The inside of the machine becomes very hot. Do not touch the inside. Doing so could result in a burn.

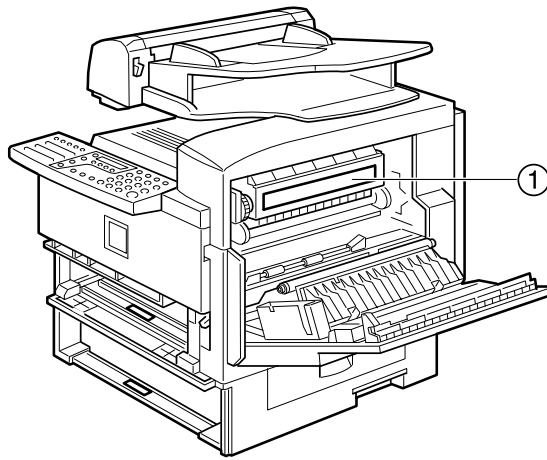

①



## ENERGY STAR Program

	<p>As an ENERGY STAR Partner, we have determined that this machine model meets the ENERGY STAR Guidelines for energy efficiency.</p>
---	--

The ENERGY STAR Guidelines intend to establish an international energy-saving system for developing and introducing energy-efficient office equipment to deal with environmental issues, such as global warming.

When a product meets the ENERGY STAR Guidelines for energy efficiency, the Partner shall place the ENERGY STAR logo onto the machine model.

This product was designed to reduce the environmental impact associated with office equipment by means of energy-saving features, such as Low-power mode.

- **Low-power Mode**

At the factory, this fax machine is set to enter the low power mode after no operation takes place for more than 5 minutes. To exit the low power mode, press the **[Energy Saver/Clear Modes]** key. The machine starts printing in about 40 seconds in the Energy Saving Standby mode, or in about 30 seconds in the Fax Standby Mode.

- ◆ **Specification**

Low-power mode	Power Consumption	1.2W
	Default Time	5 minutes

## Energy Saving Modes

Energy Saving mode enables you to avoid using unnecessary power and economize on electricity. Although we recommend you use this mode from the viewpoint of environmental consciousness, you can also turn it off.

When you install this machines for the first time, Energy Saving mode is turned on by default.

Two types of Energy Saving mode are available:

- Fax Standby: Use when you receive faxes regularly.
- Energy Saving Standby: Use when you wish to economize on power consumption.

Choose the one that best suits your circumstances.

Even though the operation panel display goes out in Energy Saving mode, Indicators that flash or light during communication or reception still work. When the Receive File indicator lights, exit Energy Saving mode and take the appropriate action.

Energy Saving Mode Type	Status	How long before you can print after exiting Energy Saving mode	Power consumption
Fax Standby	Display turns off The machine maintains the heating roller temperature at half the full temperature; warm up takes less time. (Heater half cool)	Within about 30 seconds	40W
Energy Saving Standby	Display turns off The machine lets the heating roller cool to room temperature; warm-up takes longer. (Heater off)	Within about 40 seconds	1.2W

You can turn Energy Saving mode on or off with User Parameter. When the machine is shipped, Energy Saving Standby is selected on.

The machine enters Energy Saving mode when:

- Nobody uses the machine for about 5 minutes (the machine automatically enters Energy Saving mode)
- The user holds down the Energy Saver key for about 2 seconds.

To exit Energy Saving mode:

- In Energy Saving Standby mode, press the Energy Saver key.
- In FAX Standby mode, press any key.
- Set a document.
- Pick up the optional handset or the external telephone handset.

 **Note**

- When you load paper in Energy Saving mode, no error will be displayed even if the cassette is not pushed right in.
- After loading paper, press the Energy Saver key and check that "READY" is shown on the display.

The Manual Receive indicator goes out in Energy Saving mode even if Manual Receive is turned on.

**Reception in Energy Saving mode**

In Energy Saving mode, documents that have been stored in memory are still sent and the machine can still receive messages.

When a message is received in Energy Saving mode, the machine prints it and returns to Energy Saving mode.

**Limitation**

It is not possible to enter Energy Saving mode when an original is set.

---

**Recycled Paper**

---

In accordance with the ENERGY STAR Program, we recommend use of recycled paper which is environmentally friendly. Please contact your sales representative for recommended paper.

## How to Read this Manual

---

### Symbols

---

The following set of symbols is used in this manual.

 **WARNING:**

This symbol indicates a potentially hazardous situation that might result in death or serious injury when you misuse the machine without following the instructions under this symbol. Be sure to read the instructions, all of which are described in the Safety Information section.

 **CAUTION:**

This symbol indicates a potentially hazardous situation that might result in minor or moderate injury or property damage that does not involve personal injury when you misuse the machine without following the instructions under this symbol. Be sure to read the instructions, all of which are described in the Safety Information section.

\* The statements above are notes for your safety.

 **Important**

If this instruction is not followed, paper might be misfed, originals might be damaged, or data might be lost. Be sure to read this.

 **Preparation**

This symbol indicates information or preparations required prior to operating.

 **Note**

This symbol indicates precautions for operation, or actions to take after abnormal operation.

 **Limitation**

This symbol indicates numerical limits, functions that cannot be used together, or conditions in which a particular function cannot be used.

 **Reference**

This symbol indicates a reference.



Keys built into the operation panel of the machine.



## Manuals for This Machine

Two Facsimile Reference manuals are provided, the Basic Features manual and the Advanced Features manual. Please refer to the manual that suits your needs.

---

### Basic Features (this manual)

---

The Basic Features manual explains the most frequently used fax functions and operations.

---

### Advanced Features

---

The Advanced Features manual describes more advanced functions, and also explains settings for key operators.

❖ **Chapter 1 Transmission Options**

Explains about sending at a specific time without having to be by the machine and also taking advantage of off-peak telephone line charges.

❖ **Chapter 2 Job Information**

Explains about erasing a fax message stored in memory and checking the contents of any files in memory.

❖ **Chapter 3 Other Transmission Features**

Explains about useful features for transmission. You can find out about dialing numbers easily.

❖ **Chapter 4 Reception Features**

Explains about reception features. You can find out about screening out message from anonymous senders.

❖ **Chapter 5 Copying**

Explains about copying operations and functions.

❖ **Chapter 6 Facsimile User Tools**

Explains about programming frequently used functions for User Function Key and setting the Date and Time.

❖ **Chapter 7 Key Operator Settings**

Explains about functions the key operator handles. You can find out how to change the user parameter settings.

❖ **Chapter 8 Solving Operation Problems**

Explains about things you should do when an Error Report is printed and power is turned off.

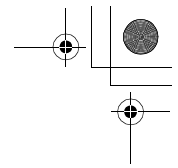

❖ **Chapter 9 Maintaining Your Machine**

Explains about changing the paper size in the paper trays, cleaning the scanner and so on.

❖ **Chapter 10 Installation**

Explains about installation considerations, connecting to a telephone line, and connecting the power.

❖ **Chapter 11 Appendix**

You can check the specifications for this machine.

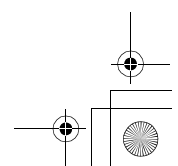
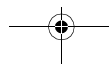
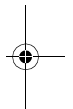
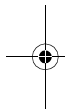

# 1. Getting Started

## Guide to Components

### Front View

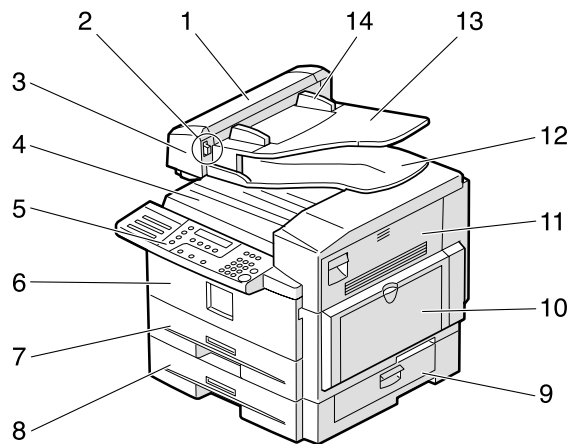

ZFWH220E

**1. ADF Cover**

Cover for the document feeder (ADF).

**2. Release Button**

Push this button to open the document feeder.

**3. Document Feeder (ADF)**

Originals will be fed automatically.

**4. Output Tray**

Received fax messages and copies are stacked here.

**5. Control Panel**

Operate the machine using keys and watching the display on the Control Panel.

**6. Front Cover**

Open this cover when changing the toner cassette and the photo conductor unit inside the machine.

**7. Main Paper Tray**

Load paper here.

**8. Paper Tray Unit (Option)**

You can load more paper here.

**9. Lower Right Cover**

Open this cover to remove jammed paper fed from the optional paper tray unit.

**10. Bypass Tray**

A fax message can be printed, and the original is copied on the paper placed here.

Getting Started

1

**11. Right Cover**

Open this cover to remove jammed paper fed from the paper tray.

**12. Original Output Tray**

Scanned originals are stacked here.

**13. Original Tray**

Place originals here for sending a fax and copying.

**14. Original guide**

Adjust the original guide to match the size of the originals.

**Side View**

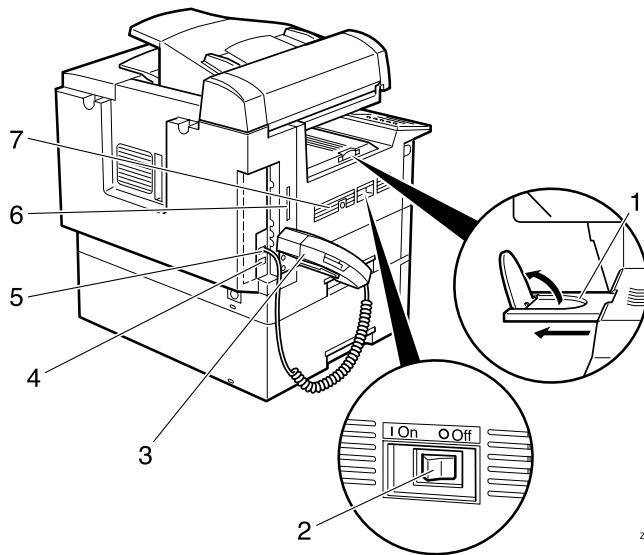

ZFWH230N

**1. Output tray guide**

Pull out and raise the end fence to support large papers.

**2. Power Switch**

The power switch turns your machine on and off.

**3. Handset (Option)**

This permits voice communication.

**4. G3 Line Connector**

**5. External Telephone Connector**

Insert an optional memory card here.

**7. Ventilation hole**

Prevents overheating. Do not obstruct the ventilation hole by placing an object near it. If the machine overheats, a fault might occur.

# Control Panel

1

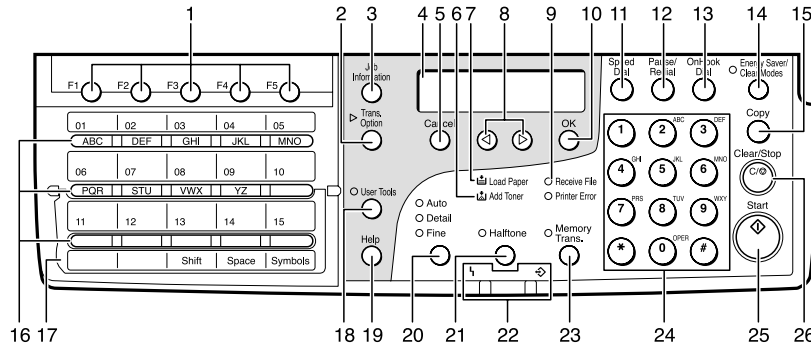

ZFW5030N

## 1. User Function keys

Each of these can be programmed for rapid access to frequently used functions.

### ◆ Functions Programmed by Default

Key	Function
F1	Print Journal
F2	FAX Header Print
F3	TX Result Report
F4	Group Dial
F5	Dial Option

## 2. [Trans. Option] key

Press to change the transmission option settings. The indicator lights when option settings are changed.

## 3. [Job Information] key

Press to search for information on a specific job.

## 4. LCD display

This guides you through tasks and informs you of the machine status. A message appears here.

## 5. [Cancel] key

Press to cancel an operation or return to the previous display.

## 6. Add Toner indicator

Blinks when toner is about to run out and lights continuously when toner has run out.

## 7. Load Paper indicator

Lights when a paper tray is empty or the paper tray is not fully inserted.

## 8. ⏪ ⏩ keys

Press to move the cursor or select functions.

## 9. Receive File indicator

Lights when a message has been received into memory.

## 10. [OK] key

Press to answer " Yes " to a question displayed on the display.

## 11. [Speed Dial] key

Press to select a Speed Dial.

## 12. [Pause/Redial] key

Pause: Inserts a pause when you are dialing or storing a fax number. A pause cannot be inserted as the first digit.

Redial: Press to redial one of the last ten numbers.

## Getting Started

## 1

**13. [On Hook Dial] key**

Use to dial a number from the numeric keypad without having to lift the handset.

**14. [Energy Saver/Clear Modes] key**

**Energy Saver:** Hold down 2 seconds to select or deselect energy saver mode. When the machine is not used for a fixed period, the machine goes into energy saver mode automatically.

**Clear Modes:** Press to clear any selected settings and return the machine to its previous condition.

**15. [Copy] key**

Press to copy the original currently loaded in the feeder.

**16. Quick Dial keys**

Use to dial numbers with a single touch or to enter letters and symbols. Also use for the Group Dial function.

**17. Quick Dial Key Flip Plate**

Flip down to access Quick Dials **[01]** to **[15]**, and flip up to access Quick Dials **[16]** to **[30]**.

**Note**

- Make sure the plate is flat against the control panel.

**18. [User Tools] key**

Press to enter User Tools mode. These tools allow you to customize the default settings.

**19. [Help] key**

Press the Help key when you want to print a help list.

**20. [Resolution] key**



Press to switch between **Standard**, **Auto**, **Detail** and **Fine**. When the indicator is not lit, **Standard** is selected.

**21. [Halftone] key**

Select halftone when faxing or copying photographs or illustrations with fine gradations. Also can be used for color originals.

**22. Status Indicators**

These indicators keep you informed about the current status of the unit.

-  **Alarm**  
When the alarm indicator flashes, check the display and read the message to identify the problem (such as a paper jam or open cover).
-  **Communicating**  
Lights during fax transmission or reception.

**23. [Memory Trans.] key**

Press this key to switch between Memory Transmission and Immediate Transmission modes.

When the indicator is not lit, Immediate Transmission is selected, and when the indicator is lit, Memory Transmission is selected.

**24. Number keys**

Use to dial fax numbers or enter the number of copies.

**25. [Start] key**

Press to start all tasks.

**26. [Clear/Stop] key**

**Clear:** Deletes one character or digit.

**Stop:** Interrupts the current operation (transmission, scanning, copying or printing).

## Starting the Machine

To start the machine, turn on the power switch.

### Note

- ☐ This machine automatically enters Energy Saver mode if you do not use the machine for a while.

### Turning On the Power

- 1** Confirm that the power cord is plugged into the outlet firmly.
- 2** Turn on the power switch.

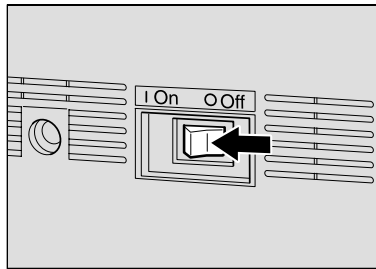

### Turning Off the Power

1

#### Important

- ☐ Make sure that 100% is shown on the Fax standby display before you turn off the power switch or you unplug the power cord. Fax files programmed in memory will be deleted 12 hours or more after you turn off the power switch or you unplug the power cord. The storage time might be shorter if the surrounding temperature is low or the machine has been on for less than a week.
- ☐ Fax files programmed in memory will not be deleted while the optional memory card is installed. When you install the memory card to the machine, make sure that 100% is shown on the display and turn off the power switch.

- 1** Turn off the power switch.

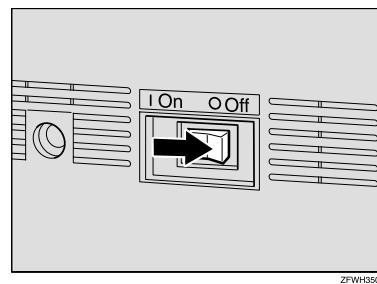

## Getting Started

## Reading the Display

The machine status and instructions are shown on the display.

1

 **Note**

- This machine automatically returns to the standby display if you do not use the machine for a certain period of time. You can select the period in Fax Reset Timer. See p.64 "Setting the Fax Reset Timer", <Advanced Features> .

---

### Reading the Display and Using Keys

---

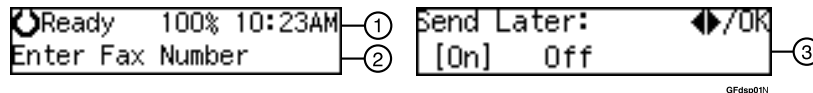

- ① Display for the machine status or currently selected function.
- ② Display for the messages.  
Items which can be selected or specified.
- ③ Display for items which can be selected.

 **Note**

- Press **[Left]** or **[Right]** to display another function on the LCD display or move the brackets to select another values.
- Press the **[OK]** key to set a selected function or entered value, and return to the previous display.
- Press the **[Cancel]** key to cancel the selected function or entered value, and return to the previous display.

---

### Standby Display

---

While the machine is in standby display (immediately after it is turned on or after the **[Cancel]** key is pressed), the following display is shown.

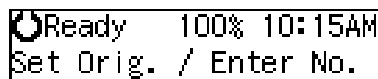

 **Note**

- To return the machine to standby display, do one of the following:
  - If you have set the original and have not pressed the **[Start]** key, remove the original.
  - If you have not set an original, press the **[Cancel]** key.
  - If you are in User Tools mode, press the **[User Tools]** key or the **[Cancel]** key.



## Communication Display

While the machine is communicating, the status is displayed.

### ◆ Display during Memory Transmission or Reception:

The destination's name or fax number appears on the top of the LCD display.

```
ABC COMPANY
Set Orig. / Enter No.
```

#### ✎ Note

- Even when the machine is sending or receiving a fax message from/into memory, you can still scan the next original into memory.

### ◆ Immediate Transmission:

```
ABC COMPANY
Transmitting...
```

## Display Prompts

Depending on the situation, the machine will show various prompts on the display.

### ◆ Instructions and Requests

```
Send Later:   Press OK
Time  [11:30] PM
```

### ◆ Questions

```
Store as Wildcard?
[Yes]  No
```

### ◆ Selections

```
Label Insertion:  ◀/OK
[On]  Off
```

### ◆ Status

```
ABC COMPANY
Dialing...
```

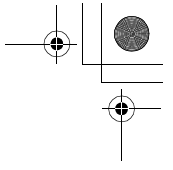
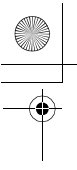

Getting Started

---

1

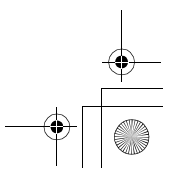
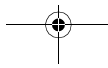
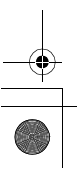
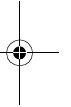
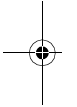

## 2. Faxing

### Transmission Modes

There are two types of transmission.

#### ◆ Memory Transmission

When a fax document is stored in memory, then transmission starts automatically.

This makes it convenient when you would like to take documents back in a hurry.

You can send the same message to more than one destination in a single operation. This technique is referred to as Broadcasting.

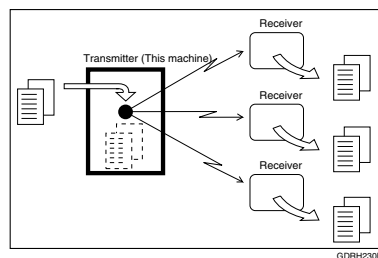

#### ◆ Immediate Transmission

The machine dials immediately, and transmits the fax while scanning.

It is convenient when you would like to send a document immediately, and would like to check whether you have successfully connected with the other party's fax machine.

A fax document is not stored in memory.

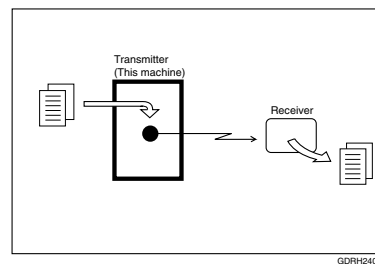

#### ⚠ Important

- If there is a power failure, the power switch is turned off, or the plug is pulled out for a certain period of time, all documents stored in memory are deleted. As soon as power is restored, the Power Failure Report is printed to help you identify deleted documents. See p.103 "Power Failure Report", <Advanced Features> .

## Switching between Memory Transmission and Immediate Transmission

2

Press the **[Memory Trans.]** key to switch between Memory Transmission and Immediate Transmission. When the indicator of the **[Memory Trans.]** key is not lit, Immediate Transmission is selected. When the indicator of the **[Memory Trans.]** key is lit, Memory Transmission is selected.

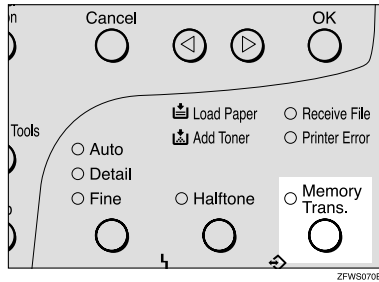

### Note

- ❑ You can set whether the machine is in Memory Transmission mode or Immediate Transmission mode right after the power is turned on with the User Parameters (Switch 00 Bit 6). See p.85 "User Parameters", <Advanced Features> .
- ❑ You can set whether the Transmission mode returns to the default mode after each transmission with the User Parameters (Switch 01 Bit 7). See p.85 "User Parameters", <Advanced Features> .

## Setting Originals

You can set your originals in the Document Feeder.

### ◆ How to set A4, B5, A5, 5 $\frac{1}{2}$ "x8 $\frac{1}{2}$ ", 8 $\frac{1}{2}$ "x11, 8 $\frac{1}{2}$ "x14" and 8"x13" size originals

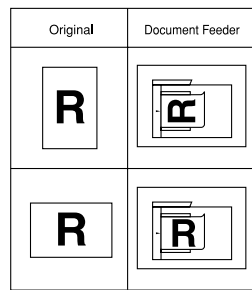

GFMUK11E

### ◆ How to set A5 and 8 $\frac{1}{2}$ "x5 $\frac{1}{2}$ " size originals

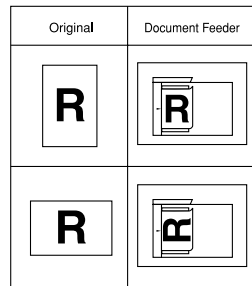

GFMUK12E

#### Note

- When sending a fax, the image output at the other end depends on the size and direction of paper used in the receiver's terminal. If the receiver does not use paper of the same size and direction as that of the original, the fax image size may be reduced on output, trimmed at the both edges, or divided into two or more sheets. When sending an important original, we recommend that you ask the receiver about the size and direction of the paper used in their terminal.
- Make sure that all ink, correcting fluid, etc., has completely dried before setting your original. If it is still wet, the scanner will be marked and those marks will appear on the received image.
- You can set the original any time up until you press the **[Start]** key.

## 2

## Loading Originals in the Document Feeder

Use the Document Feeder to scan in a stack of originals in one operation. The Document Feeder can handle single-sided originals.

### Note

- The maximum document length is 600mm (23.7") with manual assistance.
- Place all the originals to be sent in a single stack.
- Do not open the Document Feeder while it is scanning the originals or your document could be jammed.
- If an original jams, press the **[Clear/Stop]** key, and then remove the original carefully.
- If your original is bent or folded, flatten it before you set it.

### Reference

For information about the sizes and number of originals that can be placed in the Document Feeder, see p.127 "Originals", <Advanced Features> .

- 1** Adjust the document guide to match the size of your originals. Align the edges of your originals and stack them in the Document Feeder face up. Adjust the document guide to match the size of the originals again.

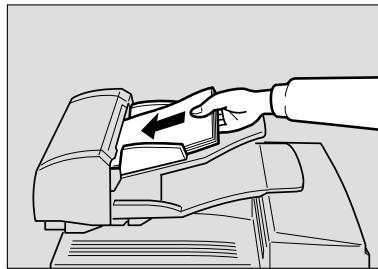

ZFWH90E

### Note

- Set the originals gently.

### Reference

For details about unsuitable originals, see p.127 "Originals unsuitable for the Document Feeder (ADF)", <Advanced Features> .

## Original Sizes Difficult to Detect

The machine finds it difficult to detect the size of the following kinds of originals.

- Originals with index tabs, tags, or projecting parts
- Transparent originals, such as OHP transparencies or translucent paper
- Dark originals with many characters or drawings
- Originals which partially contain solid printing
- Originals which have solid printing at their edges

## Memory Transmission

Memory Transmission is convenient because:

- Fax documents can be scanned much more quickly. Your scanned document is stored in the memory, and then sent automatically, meaning you do not have to wait for your document to send.
- While your fax document is being sent, another user can operate the machine (people do not have to wait long to use the fax machine).
- You can send the same document to more than one place with the same operation. (Broadcasting)
- There are two kinds of Memory Transmission: Parallel and Normal. See p.31 "Parallel Memory Transmission", <Advanced Features> .

### Important

- If there is a power failure (power switch is off) or the plug is pulled out for a certain period of time, all the files stored in memory are deleted. As soon as the power switch is turned on, the Power Failure Report is printed to help you identify deleted files. See p.103 "Power Failure Report", <Advanced Features> .

### Limitation

- If memory is full (0% appears on the display), Memory Transmission is disabled. Use Immediate Transmission instead.

### Note

- Maximum number of Memory Transmission files: 140
- Maximum number of destinations per Memory Transmission: 140
- Combined total number of destinations that can be stored: 300
- The theoretical maximum number of destinations you can enter with the number keys is 69, but this will depend on the amount of memory currently available.
- The number of pages that you can store in memory depends on the original images and the scan settings. You can store up to 240 standard pages (ITU-T #1 chart, Resolution: Standard, Original Type: Text).
- You can set whether the machine returns to the default transmission mode after every transmission with the User Parameters. See p.85 "User Parameters", <Advanced Features> (Switch 01, Bit 7) .

### 1 Make sure that the Memory Transmission indicator is lit.

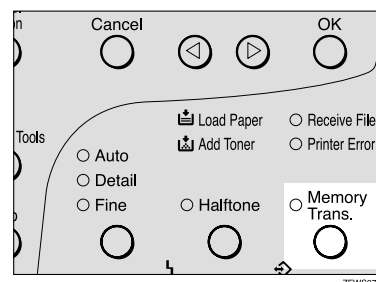

If it is not lit, press the **[Memory Trans.]** key.

Faxing

2

**2** Set the original.

**Note**

- Do not open the Document Feeder while it is scanning in originals.

**Reference**

p.23 "Setting Originals"

**3** Select any scan settings you require. See p.32 "Scan Settings".

**4** Dial. If you wish to send the same message to more than one destination, press the **[OK]** key, and then dial another destination. Repeat this step for all destinations.



If you make a mistake, press the **[Clear/Stop]** key, and then enter the correct number again.

**Note**

- When specifying a destination using a Quick Dial, the destination is added even if you did not press the **[OK]** key.

**Reference**

p.34 "Dialing"

**5** Press the **[Start]** key.

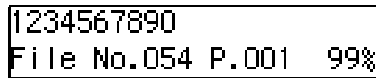
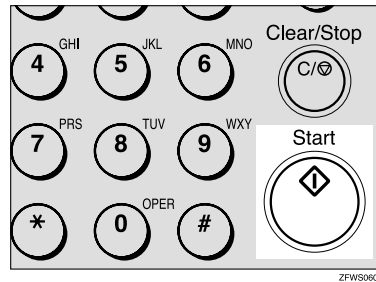

The machine starts scanning the original.

The machine calls the destination. The name or fax number which is programmed as the Own Name or Own Fax Number at the other end is shown on the top of the display.

**Reference**

p.41 "Own Name/Fax Header/Own Fax Number"



After transmission, the machine will return to standby display.



## Canceling a Memory Transmission

### Before the Start Key is Pressed

- 1 Press the **[Energy Saver / Clear Modes]** key.

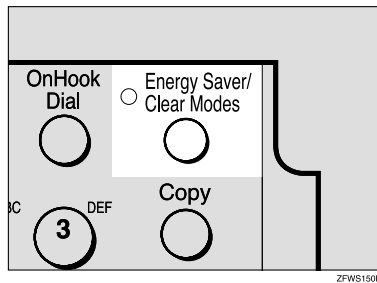

**Note**

- When you have already set the original, you can also cancel the transmission by removing the original from the machine.

### While the Original is Being Scanned

- 1 Press the **[Clear/Stop]** key.

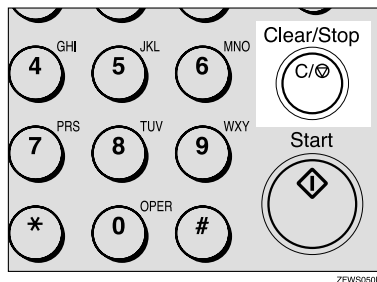

The machine will stop storing the original and the data will not be sent.

### During Transmission

Use this procedure to cancel a transmission after the original has been scanned.

2

**Note**

- If transmission finishes while you are carrying out this procedure, it will not be canceled.
- If you cancel a message while it is being sent, transmission is halted as soon as you finish this procedure. However, some pages of your message may have already been sent and will be received at the other end.

- 1 Press the **[Job Information]** key, and confirm that "1. Cancel TX / RX" is displayed.

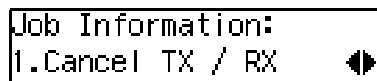
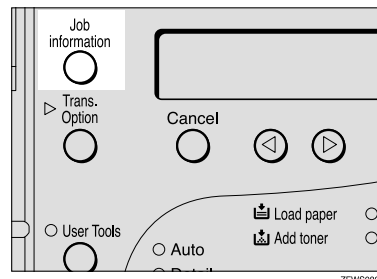

The Information menu is shown.

- 2 Press the **[OK]** key.

Faxing

- 3 Display the file you want to delete.

Enter the file number with the number keys, or search using or .

2

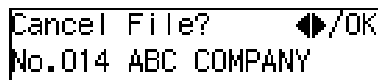

- 4 Press the [OK] key.
- 5 Press or to select "Yes "

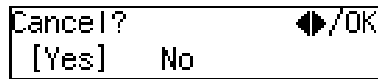

- 6 Press the [OK] key.

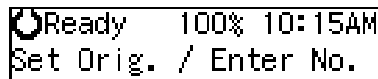

The file is erased, and the machine will return to standby display

### While the Original is Awaiting Transmission

**Note**

- Pages already being sent to the destination cannot be canceled, even if you cancel the transmission. The transmission may be sent before you can cancel it, even if you start canceling the transmission before it is fully sent.

- 1 Press the [Job Information] key, and confirm that "1. Cancel TX / RX" is displayed.

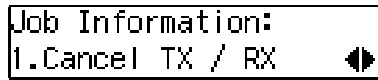
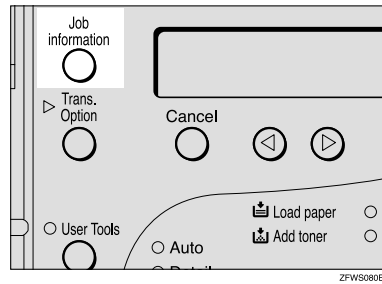

- 2 Press the [OK] key.
- 3 Display the file you want to delete.  
Enter the file number with the number keys, or search using or .



If you are unable to find the file, it has already been sent.

- 4 Press the [OK] key.
- 5 Press or to select "Yes ".

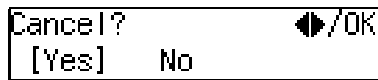

- 6 Press the [OK] key.



The file is erased, and the machine will return to standby display

## Immediate Transmission

Immediate Transmission is convenient when:

- You wish to send a document immediately as it is scanning.
- You wish to quickly check whether you have successfully connected with the other party's fax machine.
- Your machine's memory is getting full.

The machine dials immediately after you press the **[Start]** key. The message is scanned and transmitted page by page without being stored in memory.

**Note**

- You can only specify one destination for Immediate Transmission.
- You can set whether the machine is in Memory Transmission mode or Immediate Transmission mode right after the power is turned on with the User Parameters.
- The machine does not redial with immediate transmission.

**1 Check that the Memory Transmission indicator is not lit.**

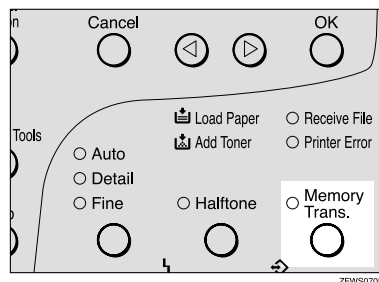

If it is lit, press the **[Memory Trans.]** key.

**2 Set your original.**

**Reference**  
p.23 "Setting Originals"

**3 Select any scan settings you require. See p.32 "Scan Settings".**

2

**4 Dial.**



If you make a mistake, press the **[Clear/Stop]** key, and then enter the correct number again.

**Reference**  
p.34 "Dialing"  
See p.21 "Chain Dial", <Advanced Features> .

**5 Press the [Start] key.**

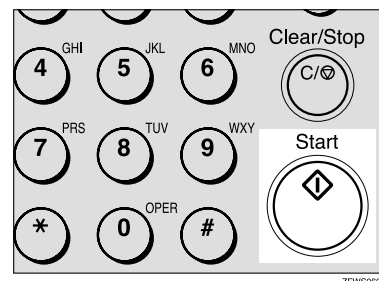

The machine calls the destination. While it is dialing, the number or name which is programmed as the Own Name or Own Fax Number in the machine of the other party is shown on the display. When connected, the machine starts scanning the original.

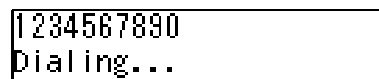

Faxing

---

 **Reference**

p.41 "Own Name/Fax Header/Own Fax Number"



```
Ready 100% 10:15AM
Set Orig. / Enter No.
```

**2**

After transmission the machine will return to standby display.

## Canceling an Immediate Transmission

### Before the Start key is Pressed

- 1 Press the **[Energy Saver / Clear Modes]** key.

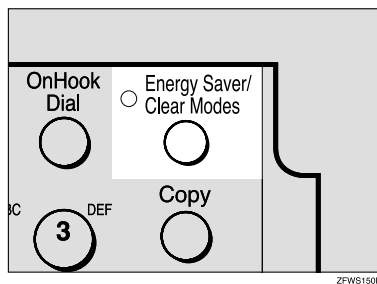

#### Note

- When you have already set the original, you can also cancel the transmission by removing the original from the machine.

### After the Start key is Pressed

- 1 Press the **[Clear/Stop]** key, and then remove the original.

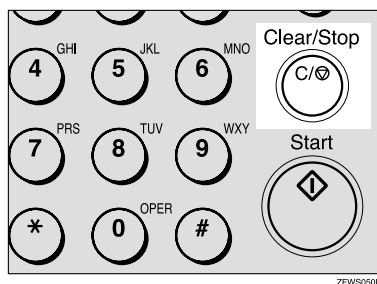

#### Note

- If the transmission finishes while you are carrying out this procedure, it will not be canceled.

2

## Scan Settings

You may wish to send many different types of fax messages. Some of these may be difficult to reproduce at the other end. However, your machine has three settings that you can adjust to help you transmit your document with the best possible image quality.

- ❖ **Resolution:**  
Standard, Detail, Fine, Auto
- ❖ **Original Type:**  
Halftone

### Resolution

Images and text are scanned into the machine by converting them to a sequence of dots. The frequency of dots determines the quality of the image and how long it takes to transmit. Therefore, images scanned at high resolution (**Fine**) have high quality but transmission takes longer. Conversely, low resolution (**Standard**) scanning results in less quality but your original is sent more quickly. Choose the setting that matches your needs based upon this trade off between speed and image clarity.

- ❖ **Standard (8×3.85 lines/mm, 200×100dpi)**  
Select for originals containing normal sized characters.
- ❖ **Detail (8×7.7 lines/mm, 200×200dpi)**  
Select for originals containing small characters or when you require greater clarity. This resolution is twice as fine as Standard.

- ❖ **Fine (8×15.4 lines/mm, 200×400dpi)**  
Select for originals with very fine details or when you require the best possible image clarity. This resolution is four times as fine as Standard.
- ❖ **Auto (8×3.85 lines/mm, 200×100dpi) and (8×7.7 lines/mm, 200×200dpi)**  
Select for originals containing normal size characters and small size characters. The machine will choose either Standard or Detail for originals automatically.

### Limitation

- If the other party's machine does not support the resolution at which you are sending, this machine automatically switches to a resolution which is supported.
- Sending with **Fine** resolution requires that the other party's machine has the capability to receive fax messages at **Fine** resolution.

### Note

- The resolution returns to the default setting after every transmission. You can change this with the User Parameters (Switch01, Bit7). See p.85 "User Parameters", <Advanced Features> .
- Auto** resolution can be selected when the machine is in memory transmission mode and it can not be selected when the machine is in immediate transmission mode.
- Standard Memory Transmission is used instead of Parallel Memory Transmission when **Auto** resolution is selected.
- Auto** resolution can not be selected when copying.

- Usually, transmission takes shorter when **Auto** resolution is selected than **Detail** resolution is selected. However, transmission for some originals containing normal size characters and small size characters takes longer because resolution modes are changed.

**1** Press the **[Resolution]** key to switch between resolutions. The indicators above the key show the current selection. When none of the indicators are lit, **Standard** is selected.

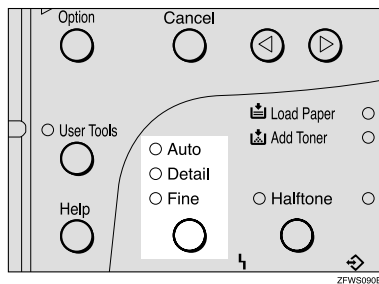

## Original Type

If your original contains photographs or colored illustrations, select **Halftone** to optimize image clarity.

### ◆ Halftone

Select **Halftone** to send an original containing a halftone image such as a photograph or a color original.

2

### ✎ Note

- If you select **Halftone**, resolution is automatically set to **Detail**. Even if you do not select **Halftone** again, the resolution will not return to **Standard**.
- If you select **Halftone**, the transmission will take longer than when it is not selected.
- You can set whether the machine returns to the **Original Type** default setting after every transmission with the User Parameters (Switch 01 Bit 7). See p.85 "User Parameters", <Advanced Features>.

**1** Press the **[Halftone]** key.

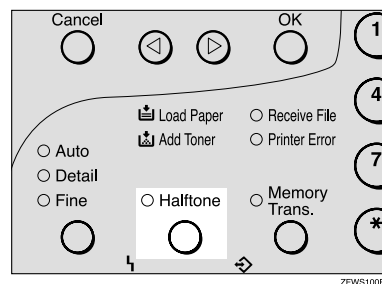

## Dialing

There are four main ways to dial a number:

- 2**
- ◆ **Entering Numbers Directly**  
See p.34 "Entering Numbers Directly"
  - ◆ **Using Quick Dials:**  
See p.35 "Using Quick Dials"
  - ◆ **Using Speed Dials:**  
See p.36 "Using Speed Dials"
  - ◆ **Using Groups**  
See p.37 "Using Groups"

### Entering Numbers Directly

Enter numbers directly using the number keys on the right side of the operation panel.

#### Note

- Maximum length of a fax number: 254 digits.
- You can insert pauses and tones in a fax number. See p.35 "Pause", p.35 "Tone"

- 1** Make sure that the machine is in standby display.
- 2** Set your original and select any scan settings you require.

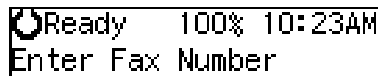

Ready 100% 10:23AM  
Enter Fax Number

- 3** Enter the fax number with the number keys.  
The digits appear on the display as you enter them.



Dest.1 Press Start  
1234567890

#### Note

- If you make a mistake, press the **[Clear/Stop]** key and enter again.
- If you wish to send this message to more than one destination, press the **[OK]** key, and then enter the next destination.

- 4** Press the **[Start]** key.

#### Limitations when dialing with the number keys

Fax numbers entered with the number keys are stored in internal memory (separate from memory for storing original data). Therefore, using the number keys, you cannot program 69 or more numbers for the following:

- Destinations specified in a Memory Transmission (including Polling Reception)
- Destinations specified in a Group

For example, when 60 destinations are registered in a Group with the number keys, only 9 destinations can be dialed for Memory Transmission from the number keys.



**Note**

- If a memory file is awaiting transmission and the "Exceeded the Max. Cannot Add" message is displayed when dialing with the number keys, you cannot dial any more numbers. That is because the fax numbers have been dialed with the number keys for some of the files awaiting transmission. When these files have been sent and their fax numbers are deleted from memory, additional fax numbers can be dialed.
- The display shows the percentage of free memory space for storing originals. Since fax numbers are stored in separate memory, dialing fax numbers with the number keys does not change the percentage on the display.

**Pause**

Press the **[Pause/Redial]** key when dialing or storing a number to insert about a two-second pause.

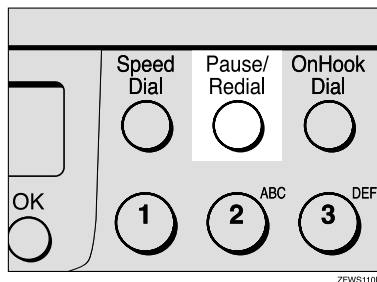
**Note**

- You cannot insert a pause before the first digit of a fax number.
- A pause is shown as a "-" on the display.
- You can insert a pause in numbers stored in Quick Dials and Speed Dials.

**Tone**

This function allows a machine connected to a pulse dialing line to send tone signals (for example if you want to use a special service on a tone dialing line). When you press the **[\*]** key, the machine dials the number using tone signals.

**Note**

- You cannot place a tone before the first digit of a fax number.
- Some services may not be available when using the **[\*]** key.
- A tone is shown as a "•" on the display.

**Using Quick Dials**

You can specify destinations simply by pressing the Quick Dial.

You must program the destination's fax number in a Quick Dial beforehand.

Additionally, you can store a name for the destination in Quick Dials.

**Note**

- To register, edit, or delete a Quick Dial, see p.46 "Quick Dial"
- To check the contents of all Quick dials, print the quick Dial list. See p.56 "Printing Reports/Lists", <Advanced Features> .
- You can have the label stored with a Quick Dial printed on the first page received at the other end.

**Reference**

p.34 "Dialing"

Faxing

2

- 1 Make sure that the machine is in standby display.
- 2 Set your original and select any scan settings you require.

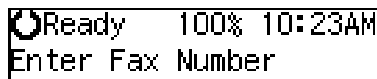

- 3 Press the Quick Dial key in which the destination's number is programmed.

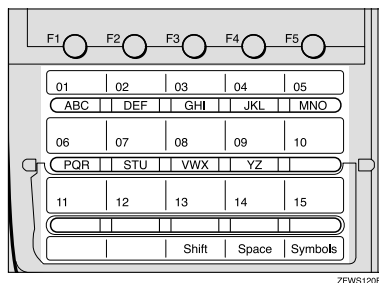

If the destination's name has been stored, the name is shown on the display. If it is not, the fax number is shown.



- Note**
- If you make a mistake, press the **[Clear/Stop]** key and try again.
- If you wish to dial another destination, press the **[OK]** key and dial another fax number.

- 4 Press the **[Start]** key.

## Using Speed Dials

You can specify destinations simply by pressing the **[Speed Dial]** key and a Speed Dial code (00 to 49).

You must store the destination's fax number in a Speed Dial beforehand. Additionally, you can store a name for the destination in Speed Dials.

**Note**

- To register, edit, or delete Speed Dial entries, see p.52 "Speed Dial"
- To check the contents of all Speed Dials, print the Speed Dial list. See p.56 "Printing Reports/Lists", <Advanced Features> .
- You can use codes 00-49 for Speed Dials.
- If a search letter is registered with a Speed Dial, you can find this number quickly using the Telephone Directory function. See p.22 "Telephone Directory", <Advanced Features> .
- You can have the label stored with a Speed Dial printed on the first page received at the other end.

- 1 Make sure that the machine is in standby display.
- 2 Set your original and select any scan settings you require.

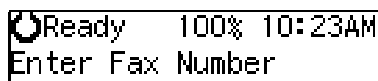

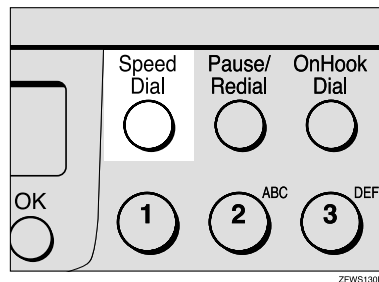
**3** Press the **[Speed Dial]** key.

Speed Dial: Enter No.  
[ ]

**4** Enter the two digit code (00 to 49) for the destination with the number keys.

Dest. 1 OK to Add  
☎ 00 DEF COMPANY

**Note**

- When a name is stored for the destination, the name is displayed, and when no name is stored, the fax number is displayed.
- If you wish to dial another destination, press the **[OK]** key and dial another fax number.
- If you make a mistake, press the **[Clear/Stop]** key, and try again.

**5** Press the **[Start]** key.**Using Groups**

You can store multiple destinations as a single Group and simply specify a particular Group.

You must store the destinations' fax number in a Group beforehand.

Additionally, you can store destination names and a Group name in Groups.

The method for specifying Groups differs according to the way they were programmed.

- When programmed in a Quick Dial: Press the Quick Dial key.
- When not programmed in a Quick Dial: Use the User Function Key. Group Dial is assigned to **[F4]** as a default setting. If this setting is changed, program the Group function in a User Function key (**[F1]** to **[F5]**). When you want to specify a destination, press the User Function key in which the Group Function is programmed, and then press the Group number with the number keys. See p.53 "User Function Keys", <Advanced Features> .

**Limitation**

- You cannot use Immediate Transmission to send Groups. You can only use Memory Transmission.

**Note**

- Quick Dials programmed for Groups cannot be used for any other function.
- To register, edit, or delete Groups, see p.57 "Groups"
- To check the contents of all Groups, print the Group Dial list. See p.56 "Printing Reports/Lists", <Advanced Features> .

## Faxing

**When Specifying a Group with a Quick Dial**

Make sure that the Memory Transmission indicator is lit, if not, press the **[Memory Trans.]** key to light it.

**2****Note**

- You must register Groups to Quick Dials beforehand. See p.57 "Groups"

**1** Make sure that the machine is in standby display.

**2** Set your original and select any scan settings you require.

```
Ready 100% 10:23AM
Enter Fax Number
```

**3** Press the Quick Dial key in which the Group is programmed.

```
Dest.1 Press Start
02:Gp.D1 EUROPE1
```

**Note**

- If you make a mistake, press the **[Clear/Stop]** key and try again.
- If you wish to dial another destination, press the **[OK]** key, and then dial another fax number.

**4** Press the **[Start]** key.

**When Specifying a Group with the Group key**

Make sure that the Memory Transmission indicator is lit, if not, press the **[Memory Trans.]** key to light it.

**Note**

- Group Dial is assigned to **[F4]** as a default setting. If this setting is changed, you must program the Group function in a User Function key beforehand. See p.53 "User Function Keys", <Advanced Features> .

**1** Make sure that the machine is in standby display.

**2** Set your original and select any scan settings you require.

```
Ready 100% 10:23AM
Enter Fax Number
```

**3** Press the User Function key programmed with the Group function.

```
Group Dial: Enter No.
[Gp.D1]
```

**4** Enter the Group number (1 to 5) with the number keys.

```
Dest.1 Press Start
Gp.D1 EUROPE1
```

**Note**

- If you want to specify another Group, press the **[OK]** key, and then repeat step **3** above.
- If you make a mistake, press the **[Clear/Stop]** key, and the display will return to that in step **2**.

**5** Press the **[Start]** key.

## Reception Modes

The machine can treat incoming fax messages and telephone calls in three ways.

### ❖ Manual Receive

Use this mode if your line is shared by a fax machine and a telephone but you wish to answer all calls yourself and decide whether they are fax documents or telephone calls. You must manually press the **[Start]** key to receive a fax. The machine will ring continuously until you answer the call, so you have to be near the machine at all times.

### ❖ Auto Receive

Use this mode if you have a dedicated fax line. The machine assumes all calls are fax documents. It will ring once to alert you of an incoming call, and then starts receiving.

### ❖ Auto Select

In this mode, the machine rings a number of times. You can answer the call while the machine is ringing. If you do not answer the call, the machine automatically changes to receive fax messages.

#### Note

- You can change the number of rings. See p.61 "Setting the Auto Ring Time", <Advanced Features> .
- When the other party send a fax message, the machine changes to receive the fax message automatically.
- You can connect a telephone answering machine with Auto Select.

- Set a smaller number of rings for the telephone answering machine than for the fax machine.
- It could not be work correctly depends on a telephone answering machine.

2

### Selecting the Reception Mode

Select the Reception Mode using the following procedure.

- 1** Press the **[User Tools]** key.

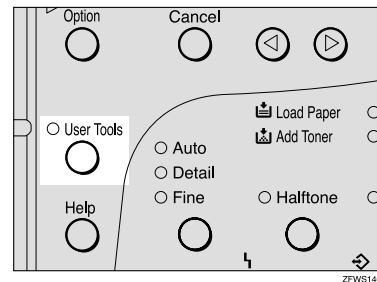

User Tools:  
1. Counter

- 2** Press **[Left]** or **[Right]** until " 2. Fax Features " is displayed.

User Tools:  
2. Fax Features

- 3** Press the **[OK]** key.

Fax Features:  
1. Program / Delete

## Faxing

- 4** Press  $\leftarrow$  or  $\rightarrow$  until " 3. Setup " is displayed.

```
Fax Features:
3.Setup      ◀▶
```

2

- 5** Press the [OK] key.

```
Setup:
1.Monitor Volume  ◀▶
```

- 6** Press  $\leftarrow$  or  $\rightarrow$  until " 5. Reception Mode " is displayed.

```
Setup:
4.Reception Mode  ◀▶
```

- 7** Press the [OK] key.

```
Reception Mode: ◀▶/OK
[Auto Receive]
```

- 8** Press  $\leftarrow$  or  $\rightarrow$  to select the reception mode.

```
Reception Mode: ◀▶/OK
Manual Receive
```

- 9** Press the [OK] key.

- 10** Press the [User Tools] key to return to the standby display.

```
Ready 100% 10:15AM
Set Orig. / Enter No.
```

## 3. Registering

### Own Name/Fax Header/Own Fax Number

Make sure that all necessary settings are made before connecting your machine to the telephone line.

#### ❖ Own Name

This should be your name or company name, in 20 characters or less. During communication, if the other party's fax machine supports Own Name, this replaces the Own Fax Number that follows. This name will appear on the display of the other party's fax machine, and the name registered on that machine will appear on yours.

#### ⚠ Limitation

- The registered name will not be used unless the other party has the same machine of the same make that supports the Own Name function.

#### ❖ Fax Header

This is ordinarily your name or company name. Your fax header can be up to 32 characters long, and is printed on the header of every page you send.

#### ❖ Own Fax Number (Required by international law)

This is your fax machine's phone number that must include country and area codes using 20 characters or less. During any communication, your Own Fax Number appears on their display. (Conversely their Own Fax Number appears on your display.)

#### 📝 Note

- In some areas, the Own Fax Number is preprogrammed by your service representative, and cannot be re-programmed by the user.

#### ⚠ Important

- When sending a fax, your Own Fax Number is required by international law. You cannot legally connect a fax machine to the telephone system if the Own Fax Number is not programmed.

#### 📝 Note

- You can confirm the Own Name, Fax Header, and Own Fax Number settings in the User Parameters List. See p.90 "Printing the User Parameter List", <Advanced Features> .

Registering

## Registering

The following procedure describes how to make initial settings.

- 1** Press the **[User Tools]** key.

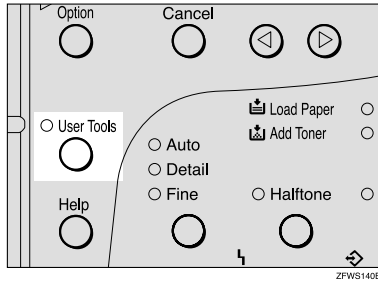

- 2** Press **⏪** or **⏩** until "2. Fax Features" is displayed.



- 3** Press the **[OK]** key.

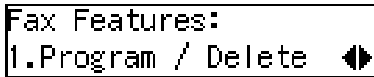

- 4** Press **⏪** or **⏩** until "3. Setup" is displayed.

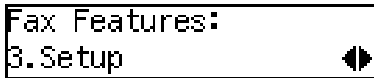

- 5** Press the **[OK]** key.

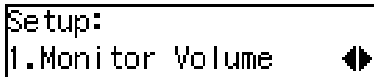

- 6** Press **⏪** or **⏩** until "6. Fax Information" is displayed.



- 7** Press the **[OK]** key.

Confirm that "1. Own Name" is displayed.



- 8** Press the **[OK]** key.



- 9** Enter your Own Name.



**Note**

- ❑ If you want to erase a character in the name, press the **[Clear/Stop]** key.

**Reference**

See p.67 "Entering Characters" for how to enter characters.

- 10** Press the **[OK]** key.

Your Own Name is programmed.



- 11** Press **⏪** or **⏩** until "2. Fax Header" is displayed.





**12** Press the **[OK]** key.

The programmed Own Name is displayed.

```
Header: [ABC] /OK
MAIN OFFICE
```

**13** Enter your Fax Header.

If your Fax Header is the same as your Own Name, go to step 14.

```
Header: [ABC] /OK
MAIN OFFICE
```

**14** Press the **[OK]** key.

Your Fax Header is programmed.

```
Fax Information:
2.Fax Header
```

**15** Press **[Left]** or **[Right]** until "3. Own Fax Number" is displayed.

```
Fax Information:
3.Own Fax Number
```

**16** Press the **[OK]** key.

```
Fax Number:
☎
```

**17** Enter your Own Fax Number.

```
Fax Number: /OK
☎+441234567890
```

**Note**

- The format of the number is normally as follows: International Dial Prefix, Your Country Code, Your Area Code (do not insert a pause after your Area Code), followed by your telephone number. Check the International Dialing Prefix and the Country Code with your local telecommunications operator.

Characters you can enter include numerals 0-9, plus symbols (+), and spaces.

**18** Press the **[OK]** key.

Your Own Fax Number is programmed.

```
Fax Information:
3.Own Fax Number
```

**19** Press the **[User Tools]** key to return to standby display.

Registering

**Editing**

The following procedure describes how to edit initial settings.

- 1 Press the **[User Tools]** key.

3

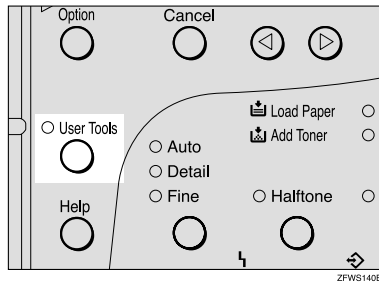

- 2 Press **⏪** or **⏩** until " 2. Fax Features " is displayed.



- 3 Press the **[OK]** key.

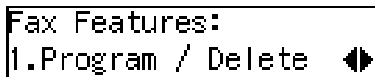

- 4 Press **⏪** or **⏩** until " 3. Setup " is displayed.

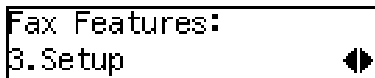

- 5 Press the **[OK]** key.

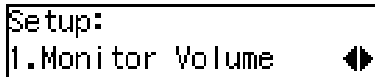

- 6 Press **⏪** or **⏩** until "6. Fax Information" is displayed.



- 7 Press the **[OK]** key.



- 8 Press **⏪** or **⏩** to select the item that you want to edit.

- 9 Press the **[OK]** key.

- 10 Press the **[Clear/Stop]** key, and then reenter the Number or Name.

- 11 Press the **[OK]** key.

- 12 Press the **[User Tools]** key to return to standby display.

## Deleting

The following procedure describes how to delete initial settings.

- 1 Press the **[User Tools]** key.

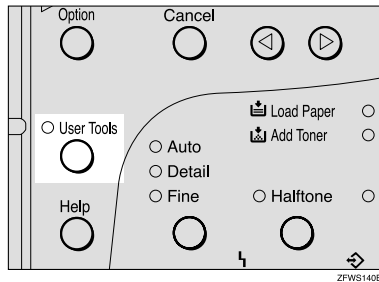

User Tools:  
1.Counter

- 2 Press **◀** or **▶** until " 2. Fax Features " is displayed.

User Tools:  
2.Fax Features

- 3 Press the **[OK]** key.

Fax Features:  
1.Program / Delete

- 4 Press **◀** or **▶** until " 3. Setup " is displayed.

Fax Features:  
3.Setup

- 5 Press the **[OK]** key.

Setup:  
1.Monitor Volume

- 6 Press **◀** or **▶** until "6. Fax Information" is displayed.

Setup:  
6.Fax Information

- 7 Press the **[OK]** key.

Fax Information:  
1.Own Name

- 8 Press **◀** or **▶** to select the item that you want to delete.

- 9 Press the **[OK]** key.

- 10 Press the **[Clear/Stop]** key.

- 11 Press the **[OK]** key.

- 12 Press the **[User Tools]** key to return to standby display.

3

Registering

## Quick Dial

To save time, you can program a fax number that you use often into a Quick Dial key. Then, whenever you are sending a message to that location, just press that Quick Dial key to dial.

### 3

### Registering

The following procedure describes how to register fax numbers in Quick Dial keys. There are 30 Quick Dials available.

You can register the following items in each key:

- Destination fax number (up to 254 digits)
- Destination name (up to 20 characters)
- Label Insertion (whether to print the destination name on faxes sent to this number)

#### Important

- We recommend that you print the Quick Dial list and keep it when you program or change fax numbers. See p.56 "Printing Reports/Lists", <Advanced Features> .

#### Limitation

- When a registered Quick Dial key is being used for a standby Memory Transmission, the message " This Dial is in Use. Cannot Change. " is shown and you cannot change the destination for this key.

#### Note

- You can confirm fax numbers stored in Quick Dials on the Quick Dial List. See p.56 "Printing Reports/Lists", <Advanced Features> .

#### 1 Press the [User Tools] key.

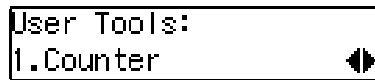
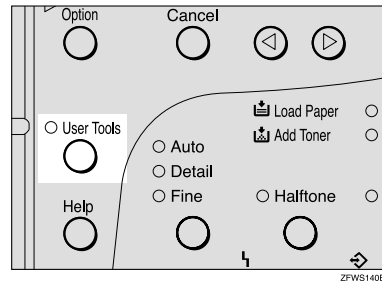

#### 2 Press ◀ or ▶ until " 2. Fax Features " is displayed.



#### 3 Press the [OK] key.



Confirm that " 1. Program / Delete " is displayed.

#### 4 Press the [OK] key.

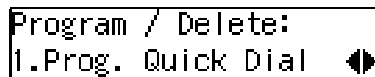

Confirm that " 1. Prog. Quick Dial " is displayed.

**5** Press the **[OK]** key.

Press Key to Program  
(Browse◀▶)

**6** Display the number of the Quick Dial key you want to register.

Press a Quick Dial key, or search using ◀ or ▶.

01 Fax No.  
[████████████████████]

**Note**

- If a Quick Dial has already been registered, the contents are displayed. Press ◀ or ▶ to select a Quick Dial that is not programmed, and then press the **[OK]** key.

**7** Enter a fax number with the number keys.

01 Press OK  
[1234567890████████]

**Note**

- If you make a mistake, press the **[Clear/Stop]** key and try again.
- If you press the **[Pause/Redial]** key, the last 10 fax numbers dialed are displayed. Press ◀ or ▶ to select the fax number you want to specify, and then press the **[OK]** key.
- Make sure a Dial Option is stored in one of the User Function keys, and then enter the other party's fax number, and then press the User Function key that contains the Dial Option. You can specify SUB or SEP, SID and PWD. See p.25 "SEP Code", <Advanced Features> or p.26 "SUB Code", <Advanced Features> .

**8** Press the **[OK]** key.

The fax number is programmed.

01 [ABC] Name  
[████████████████████]

**9** Enter the destination name.

01 [ABC] /OK  
[ABC COMPANY████████]

**Note**

- Under rare circumstances, garbled characters may appear during name registration if you use the **[Pause/Redial]** key to display the fax number of parties located in other countries. If this happens, simply delete the garbled characters using ◀ or ▶ and the **[Clear/Stop]** keys, then go on to enter the name.

**10** Press the **[OK]** key.

The name is programmed.

Label Insertion: ◀/OK  
On [Off]

**11** Press ◀ or ▶ to select "On" or "Off".

**Note**

- Label insertion allows the receiver's name that is programmed in Quick Dial or Speed Dial to be printed on the fax when it is received at the other end. See p.8 "Label Insertion", <Advanced Features> .

Label Insertion: ◀/OK  
[On] Off

Registering

**12** Press the **[OK]** key.



If you want to store another Quick Dial, go to step **5**.

**13** Press the **[User Tools]** key to return to standby display.

**3**

**Editing**

The following procedure describes how to edit fax numbers registered in Quick Dial keys.

**1** Press the **[User Tools]** key.

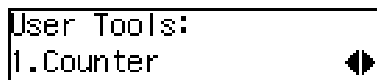
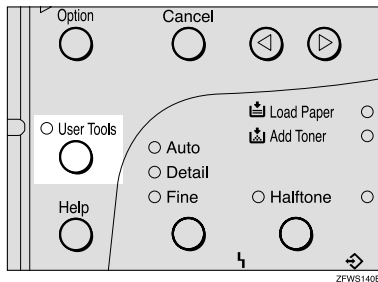

**2** Press **[Left]** or **[Right]** until " 2. Fax Features " is displayed.

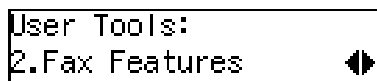

**3** Press the **[OK]** key.

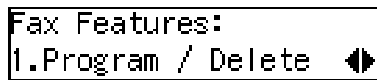

Confirm that " 1. Program / Delete " is displayed.

**4** Press the **[OK]** key.



Confirm that " 1. Prog. Quick Dial " is displayed.

**5** Press the **[OK]** key.

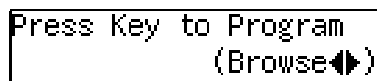

**6** Display the number of the Quick Dial key you want to edit.

Press a Quick Dial key, or search using **[Left]** or **[Right]**.

**7** Press the **[OK]** key.

**8** Press the **[Clear/Stop]** key, and then reenter the fax number with the number keys.

**Note**

- If you make a mistake, press the **[Clear/Stop]** key and try again.
- If you press the **[Pause/Redial]** key, the last 10 fax numbers dialed are displayed. Press **[Left]** or **[Right]** to select the fax number you want to specify, and then press the **[OK]** key.
- Make sure a Dial Option is stored in one of the User Function keys, and then enter the other party's fax number and press the User Function key that contains the Dial Option. You can specify SUB or SEP, SID and PWD. See p.25 "SEP Code", <Advanced Features> or p.26 "SUB Code", <Advanced Features> .

**9** Press the **[OK]** key.

- 10** Press the **[Clear/Stop]** key, and then reenter the destination name.

**Note**

- Under rare circumstances, garbled characters may appear during name registration if you use the **[Pause/Redial]** key to display the fax number of parties located in other countries. If this happens, simply delete the garbled characters using **[Left]** or **[Right]** and the **[Clear/Stop]** keys, and then go on to enter the name.

- 11** Press the **[OK]** key.

The name is programmed.

```
Label Insertion: [Left]/[OK]
On [Off]
```

- 12** Press **[Left]** or **[Right]** to select "On" or "Off".

**Note**

- Label insertion allows the receiver's name that is programmed in Quick Dial or Speed Dial to be printed on the fax when it is received at the other end. See p.8 "Label Insertion", <Advanced Features> .

```
Label Insertion: [Left]/[OK]
[On] Off
```

- 13** Press the **[OK]** key.

```
Program / Delete:
1.Prog. Quick Dial [Left]
```

If you want to store another Quick Dial, go to step **5**.

- 14** Press the **[User Tools]** key to return to standby display.

## Deleting

The following procedure describes how to delete fax numbers registered in Quick Dial keys.

**Limitation**

- When a Quick Dial key is being used for a standby Memory Transmission, the message "This Dial is in Use. Cannot Delete." is shown and you cannot delete the destination for this key.

- 1** Press the **[User Tools]** key.

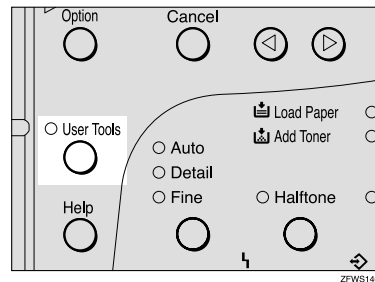

```
User Tools:
1.Counter [Left]
```

- 2** Press **[Left]** or **[Right]** until "2. Fax Features" is displayed.

```
User Tools:
2.Fax Features [Left]
```

- 3** Press the **[OK]** key.

```
Fax Features:
1.Program / Delete [Left]
```

Confirm that "1. Program / Delete" is displayed.

- 4** Press the **[OK]** key.

## Registering

- 5** Press  $\leftarrow$  or  $\rightarrow$  until "2. Del. Quick Dial" is displayed.



- 6** Press the **[OK]** key.

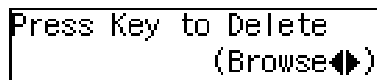

3

- 7** Display the Quick Dial key that you want to delete.

Press a Quick Dial key or search by pressing  $\leftarrow$  or  $\rightarrow$ .



The number of the Quick Dial key and the fax number or name are displayed.

- 8** Press the **[OK]** key.

The stored data (fax number and name) is deleted.

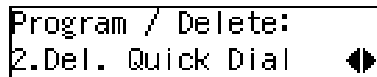

If you want to delete another Quick Dial key, go to step **6**.

- 9** Press the **[User Tools]** key to return to standby display.

## Quick Dial Key Label (Dial label)

You can print a template that can be used to make labels for Quick Dial keys. The template will have destination or Group names programmed in Quick Dial keys.

### Limitation

- Set the label paper to landscape in the Bypass Tray. Portrait position will print the wrong size.

### Note

- To print the label template, see p.56 "Printing Reports/Lists", <Advanced Features> .



## Label paper

P. 1

\* \* \* QUICK DIAL / USER FUNCTION LABEL (AUG.21.2002 11:22AM) \* \* \*

FAX HEADER: XYZ COMPANY

QUICK DIAL LABEL

ABC	COMP	EUROPE				DEF	COMP		
IVV						IVV			

01	ABC	CO	02	EUROPE	03		04		05		06		07	DEF	CO	08		09		10		
11			12		13		14		15		16		17		18		19		20			
21			22		23		24		25		26		27		28		29		30			

USER FUNCTION LABEL

PRINT	FAX	TX	RESULT	DIAL
JOURNAL	HEADER	REPORT	GROUP	OPTION

CUT ALONG THE DOTTED LINES AND SET THE LABEL(S) TO THE OPERATION PANEL.

3

## Registering

## Speed Dial

### Registering

If you register numbers in Speed Dials, you can specify the fax number simply by pressing the **[Speed Dial]** key, and entering a two-digit Speed Dial number.

3

The following procedure describes how to register fax numbers in Speed Dials.

You can register the following items in a Speed Dial:

- Destination fax number (up to 50 numbers, up to 254 digits for each number)
- Destination name (up to 20 characters)
- A Telephone Directory search letter (A to Z)
- Label Insertion (whether to print the destination name on faxes sent to this number)

#### Important

- We recommend that you print the Speed Dial list and keep it when you register or change a destination.

#### Limitation

- When a registered Speed Dial is being used for a standby Memory Transmission, the message "This Dial is in Use. Cannot Change." is shown and you cannot change the destination for this Quick Dial.

#### Note

- You can specify codes 00 to 49.
- You can confirm the contents of Speed Dial numbers in the Speed Dial List. See p.56 "Printing Reports/Lists", <Advanced Features>.

- 1 Press the **[User Tools]** key.

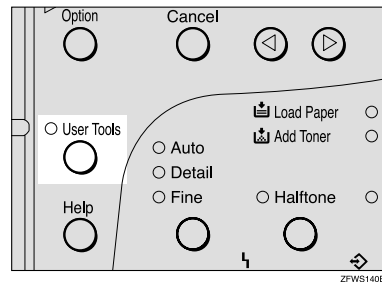

User Tools:  
1.Counter

- 2 Press **[Left]** or **[Right]** until "2. Fax Features" is displayed.

User Tools:  
2.Fax Features

- 3 Press the **[OK]** key.

Fax Features:  
1.Program / Delete

Confirm that "1. Program / Delete" is displayed.

- 4 Press the **[OK]** key.

- 5 Press **[Left]** or **[Right]** until "3. Prog. Speed Dial" is displayed.

Program / Delete:  
3.Prog. Speed Dial

- 6 Press the **[OK]** key.

Enter No. to Program  
[000] (Browse)

**7** Display the number of the Speed Dial you want to register (00 to 49).

Enter the Speed Dial number with the number keys, or search using or .



**Note**

- If you make a mistake, press the **[Clear/Stop]** key and try again.
- If a Speed Dial number has already been stored, the contents are displayed. Press or to select an unprogrammed number, then press the **[OK]** key.

**8** Enter a fax number with the number keys.



**Note**

- If you make a mistake, press the **[Clear/Stop]** key and try again.
- If you press the **[Pause/Redial]** key, the last 10 fax numbers dialed are displayed. Press or to select the fax number you want to specify, and then press the **[OK]** key.

**9** Press the **[OK]** key.

The fax number is programmed.



**10** Enter the Destination name.



**Note**

- If a destination name is already registered in the Speed Dial, the name is shown on the display. If you wish to change the destination name, press the **[Clear/Stop]** key, and then enter another name.

**11** Press the **[OK]** key.

The search letter is registered.



**12** Press or to select "On" or "Off".

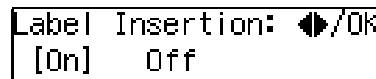

**Note**

- Label insertion allows the destination name that is programmed in Quick Dial or Speed Dial to be printed on the fax when it is received at the other end. See p.8 "Label Insertion", <Advanced Features>.

**13** Press the **[OK]** key.



If you want to store another Speed Dial number, go to step 7.

**14** Press the **[User Tools]** key to return to standby display.

Registering

**Editing**

The following procedure describes how to edit registered Speed Dial numbers.

**1** Press the **[User Tools]** key.

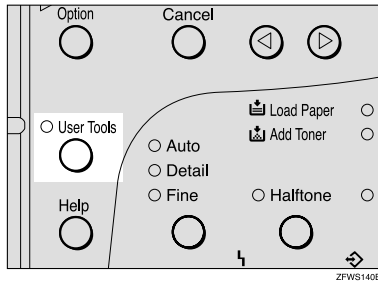

**3**

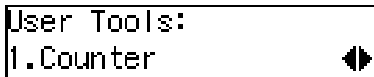

**2** Press **[Left]** or **[Right]** until " 2. Fax Features " is displayed.



**3** Press the **[OK]** key.

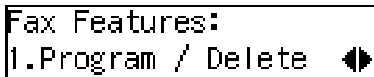

Confirm that " 1. Program / Delete " is displayed.

**4** Press the **[OK]** key.

**5** Press **[Left]** or **[Right]** until " 3. Prog. Speed Dial " is displayed.



**6** Press the **[OK]** key.

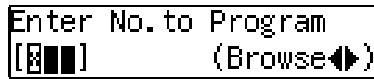

**7** Display the number of the Speed Dial you want to edit (00 to 49).

Enter the Speed Dial number with the number keys, or search using **[Left]** or **[Right]**.

**8** Press the **[OK]** key.

**9** Press the **[Clear/Stop]** key, and then reenter a fax number with the number keys.



**Note**

- If you make a mistake, press the **[Clear/Stop]** key and try again.
- If you press the **[Pause/Redial]** key, the last 10 fax numbers dialed are displayed. Press **[Left]** or **[Right]** to select the fax number you want to specify, and then press the **[OK]** key.

**10** Press the **[OK]** key.

The fax number is programmed.

**11** Press the **[Clear/Stop]** key, and then reenter the Destination name.



**12** Press the **[OK]** key.

The search letter is registered.

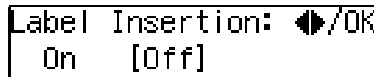

- 13** Press **◀** or **▶** to select "On" or "Off".



**Note**

- Label insertion allows the destination name that is programmed in Quick Dial or Speed Dial to be printed on the fax when it is received at the other end. See p.8 "Label Insertion", <Advanced Features> .

- 14** Press the **[OK]** key.



If you want to edit another Speed Dial number, go to step **13**.

- 15** Press the **[User Tools]** key to return to standby display.

## Deleting

The following procedure describes how to delete fax numbers in Speed Dials.

**Limitation**

- If a registered Speed Dial is being used for a standby Memory Transmission, the message "This Dial is in Use. Cannot Delete." is shown and you cannot delete the destination for this Speed Dial.

**3**

- 1** Press the **[User Tools]** key.

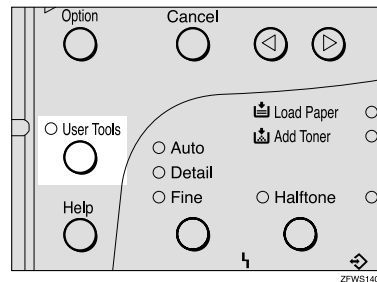

- 2** Press **◀** or **▶** until " 2. Fax Features " is displayed.



- 3** Press the **[OK]** key.

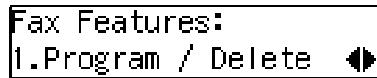

Confirm that " 1. Program / Delete " is displayed.

- 4** Press the **[OK]** key.

## Registering

- 5** Press  $\leftarrow$  or  $\rightarrow$  until "4. Del. Speed Dial " is displayed.

```
Program / Delete:
4. Del. Speed Dial  ◀▶
```

- 6** Press the **[OK]** key.

```
Enter No. to Delete
[ 000 ] (Browse▶◀)
```

3

- 7** Display the Speed Dial number you want to delete (00 to 49).

Enter the Speed Dial number with the number keys or search using  $\leftarrow$  or  $\rightarrow$ .

```
Delete? ◀▶/OK
001 DEF COMPANY
```

The Speed Dial number and the fax number or name are displayed.

- 8** Press the **[OK]** key.

The programmed data (fax number and name) is deleted.

```
Program / Delete:
4. Del. Speed Dial  ◀▶
```

If you want to delete another name, go to step **6**.

- 9** Press the **[User Tools]** key to return to standby display.

## Groups

If you regularly broadcast documents to the same set of destinations, you can combine these numbers into a group. Then just select the group and each number will be dialed in sequence automatically.

There are two ways of programming Groups:

### ❖ Registering groups in Quick Dial keys

If you register a group in a Quick Dial key, you can specify that group by pressing a Quick Dial key. However, if you use Quick Dial keys to register groups, you will be able to register fewer Quick Dial keys.

#### Note

- You cannot register another function (Quick Dials) in a Quick Dial key already used for a group. Also, you cannot register groups in a Quick Dial key already used for another function.

### ❖ Assigning the Group Functions to the Group key

To assign the Group Function to the Group key, you must first assign the Group function to a User Function key. To send a fax, press the Group key, and then enter the group number (1 to 5). To select a Group using a Group key, one more step is required than when using a Quick Dial key. However, multiple Groups (a maximum of five) can be stored in a Group key, thus leaving the Quick Dial keys to be used more effectively.

## Registering

You can register the following items in a Group:

- Destination fax numbers
- Group name (up to 20 characters)

You can enter destination numbers using Quick Dial keys, Speed Dials, or the number keys.

#### Note

- You can register up to 5 Groups.
- The maximum number of destinations you can register in a Group is 140.
- The combined maximum number of destinations you can register in all Groups is 149. This 149 can be composed of up to 30 Quick Dial numbers, 50 Speed Dial numbers and 69 numbers entered directly with the number keys.
- The number of destinations that can be registered with the number keys depends on how the machine is used. In theory you can register up to a combined maximum of 69 destinations with the number keys for all groups.
- If you register 69 destinations with the number keys, Memory Transmission using the number keys becomes unavailable, and only Immediate Transmission is available.

3

Registering

3

- ❑ If you register a Group with the number keys when a file is waiting to be transmitted, a message is shown. You sometimes cannot register any more destinations even when the number of specified destination is 68 or less.
- ❑ It is recommended that you print the Group Dial list and keep it when you register or change destinations. See p.56 "Printing Reports/Lists", <Advanced Features> .
- ❑ If you register the same destination in different Groups, it is only counted as one item.
- ❑ The table below shows how to count numbers.

Group1	Group2	Total Number of items
Quick Dial [01]	Quick Dial [01]	9
Quick Dial [03]		
Quick Dial [05]	Quick Dial [05]	
Speed Dial [02]	Speed Dial [02]	
Speed Dial [04]	Speed Dial [04]	
Speed Dial [06]		
	Speed Dial [09]	
Number keys 12345678	Number keys 12345678	
Number keys 87654321		

**1** Press the **[User Tools]** key.

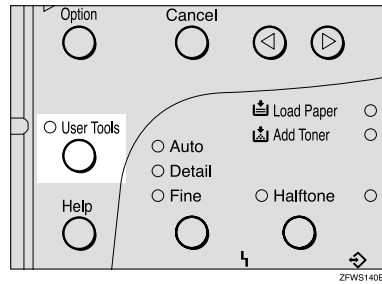

**2** Press **⏪** or **⏩** until " 2. Fax Features " is displayed.



**3** Press the **[OK]** key.



Confirm that " 1. Program / Delete " is displayed.

**4** Press the **[OK]** key.

**5** Press **⏪** or **⏩** until " 5. Prog. Group Dial " is displayed.



**6** Press the **[OK]** key.

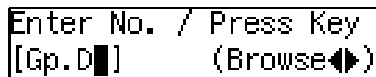



**7** Display the number of the Group you want to register (1 to 5).

Enter the group number with the number keys, or search using  $\leftarrow$  or  $\rightarrow$ .



**Note**

- If you make a mistake, press the **[Cancel]** key and try again.
- If a group has already been stored, the contents are displayed. Press  $\leftarrow$  or  $\rightarrow$  to select a group number that is not programmed, and then press the **[OK]** key.
- If a group is programmed, but no name is specified, the group number only is displayed on the lower line of the display.

**8** Specify the destination using one of the following three methods:

Enter the fax number with the number keys.



Press a Quick Dial key.



Press the **[Speed Dial]** key, and then enter a Speed Dial number.



**9** Press the **[OK]** key.

The destination is programmed.

**10** Press the  $\leftarrow$  or  $\rightarrow$  to select "Add" or "Exit".



**11** Press the **[OK]** key.

If you selected "Exit", go to step 10.

**12** Repeat step 7 to 10 for all the destinations you want to register in the Group.

**13** Enter the Group name.



**Note**

- If the Group name is already registered, it is shown on the display. If you wish to change the Group name, press the **[Clear/Stop]** key, and then enter another name.

**14** Press the **[OK]** key to register the Group.

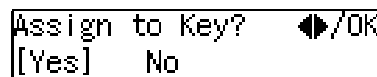

**15** Press  $\leftarrow$  or  $\rightarrow$  to select "Yes" or "No" to be programmed in the Quick Dial key. Then press the **[OK]** key.

If you selected "No", go to step 10.

**16** Press the Quick Dial key you want to register in the Group.



**17** Press the **[OK]** key.



Registering

**18** Press the **[User Tools]** key to return to standby display.

**Editing**

You can edit the group name or add destinations for programmed groups. To edit a destination:

- For destinations programmed in Quick Dial or Speed Dial, edit the contents of the programmed Quick Dial or Speed Dial.
- For destinations programmed with the number keys, delete the destination you want to edit from the group, and then program the new destination.

3

**Editing a Group Name**

**1** Press the **[User Tools]** key.

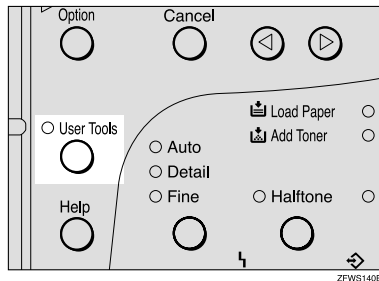

**2** Press **⏪** or **⏩** until " 2. Fax Features " is displayed.

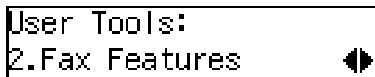

**3** Press the **[OK]** key.



Confirm that " 1. Program / Delete " is displayed.

**4** Press the **[OK]** key.

**5** Press **⏪** or **⏩** until " 5. Prog. Group Dial " is displayed.



**6** Press the **[OK]** key.



**7** Display the number of the group you want to edit (1 to 5).

Enter the group number with the number keys, or search using **⏪** or **⏩**.



**8** Press the **[OK]** key.

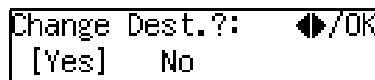

**9** Press **⏪** or **⏩** to select "No".

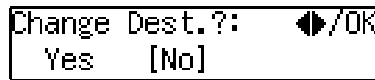

**10** Press the **[OK]** key.





- 18** Press the **[OK]** key.

```
Assign to Key?  ◀▶/OK
[Yes]  No
```

- 19** Press **⏪** or **⏩** to select "Yes" if the group was programmed in a Quick Dial, or select "No" if it was not.

```
Assign to Key?  ◀▶/OK
[Yes]  No
```

- 20** Press the **[OK]** key.

If you selected "No", go to step **19**.

```
Press Quick Dial Key
[005]
```

**Note**

- If you want to edit a programmed Quick Dial, press the Quick Dial key, and then the **[OK]** key.

- 21** Press the **[OK]** key.

```
Program / Delete:
5.Prog. Group Dial  ▶▶
```

If you want to add another destination to the group, go to step **18**.

- 22** Press the **[User Tools]** key to return to standby display.

## Deleting

The following procedure describes how to delete a destination from a group.

- When you delete a destination from a group programmed in a Quick Dial or a Speed Dial, the contents of the Quick Dial or Speed Dial are not deleted.

**3**

### To delete a destination from a group

- 1** Press the **[User Tools]** key.

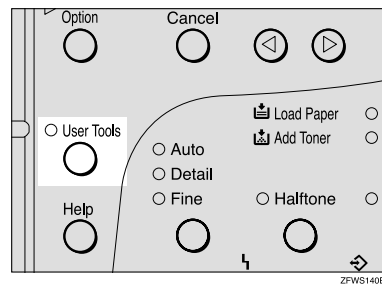

```
User Tools:
1.Counter  ▶▶
```

- 2** Press **⏪** or **⏩** until " 2. Fax Features " is displayed.

```
User Tools:
2.Fax Features  ▶▶
```

- 3** Press the **[OK]** key.

```
Fax Features:
1.Program / Delete  ▶▶
```

Confirm that " 1. Program / Delete " is displayed.

- 4** Press the **[OK]** key.

## Registering

3

- 5** Press  $\leftarrow$  or  $\rightarrow$  until " 5. Prog. Group Dial " is displayed.

```
Program / Delete:
5.Prog. Group Dial
```

- 6** Press the [OK] key.

```
Enter No. / Press Key
[Gp.D] (Browse)
```

- 7** Display the group number for the destination you want to delete (1 to 5).

Enter the group number with the number keys, or search using  $\leftarrow$  or  $\rightarrow$ .

```
Program?
Gp.D1 Europe1
```

- 8** Press the [OK] key.

```
Change Dest.?:
[Yes] No
```

- 9** Press  $\leftarrow$  or  $\rightarrow$  to select "Yes".

```
Change Dest.?:
[Yes] No
```

- 10** Press the [OK] key.

```
Program?
[Add] Delete Exit
```

- 11** Press  $\leftarrow$  or  $\rightarrow$  to select "Delete".

```
Program?
Add [Delete] Exit
```

- 12** Press the [OK] key.

```
Select Destination
with
```

- 13** Press  $\leftarrow$  or  $\rightarrow$  to display the destination you want to delete.

```
Delete?
300 London office
```

- 14** Press the [OK] key.

```
Program?
Add [Delete] Exit
```

To delete another destination, repeat steps **12** to **14**.

- 15** If you are finished deleting destinations, press  $\leftarrow$  or  $\rightarrow$  to select "Exit".

```
Program?
Add Delete [Exit]
```

- 16** Press the [OK] key.

```
Gp.D1 [ABC] /OK
[Europe1]
```

- 17** Press the [OK] key.

```
Assign to Key?
[Yes] No
```

- 18** Press  $\leftarrow$  or  $\rightarrow$  to select "Yes" if the group was programmed in a Quick Dial, or select "No" if it was not.

```
Assign to Key?
[Yes] No
```

**19** Press the **[OK]** key.

If you selected "No", go to step 4.



**Note**

- If you want to edit a programmed Quick Dial key, press the Quick Dial key and then the **[OK]** key.

**20** Press the **[OK]** key.



If you want to delete another destination from the group, go to step 6.

**21** Press the **[User Tools]** key to return to standby display.

**To delete an entire group**

**1** Press the **[User Tools]** key.

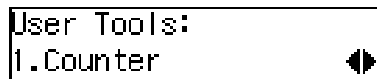
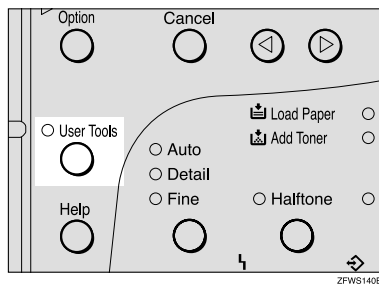

**2** Press **[Left]** or **[Right]** until " 2. Fax Features " is displayed.



**3** Press the **[OK]** key.



Confirm that " 1. Program / Delete " is displayed.

**4** Press the **[OK]** key.

**5** Press **[Left]** or **[Right]** until " 6. Del. Group Dial " is displayed.



**6** Press the **[OK]** key.



**7** Display the number of the group you want to delete (1 to 5).

Enter the group number with the number keys, or search using **[Left]** or **[Right]**.



**8** Press the **[OK]** key.

The entire Group is deleted.



**9** Press the **[User Tools]** key to return to standby display.

3

  
 **To change and delete Quick Dials programmed as groups:**

To store an entire group under a different Quick Dial key, or to delete the group from the Quick Dial key altogether, perform the following procedure:

**3**

- ① Press the **[User Tools]** key.
  - ② Press **[Left]** or **[Right]** until " 2. Fax Features " is displayed.
  - ③ Press the **[OK]** key.
  - ④ Press the **[OK]** key, and then press **[Left]** or **[Right]** to display "5. Prog. Group Dial".
  - ⑤ Press the **[OK]** key.
  - ⑥ Enter the group number (1 to 5).
  - ⑦ Press the **[OK]** key.
  - ⑧ Press **[Left]** or **[Right]** to select "No", and then press the **[OK]** key.
  - ⑨ Press the **[OK]** key.
  - ⑩ If you want to change the Quick Dial key, press "Yes", and if you want to delete the Quick Dial key, press "No".
  - ⑪ Press the **[OK]** key.  
If you selected "No" in step ⑩, the Quick Dial key is deleted. Go to step ⑭.
  - ⑫ If you want to change the Quick Dial key, press the new Quick Dial key.
  - ⑬ Press the **[OK]** key.  
The Quick Dial key is changed.
  - ⑭ Press the **[User Tools]** key to return to standby display.
- 



## Entering Characters

This section describes how to enter characters.

### Available Characters

- Letters:  
ABCDEFGHIJKLMNOPQRSTUVWXYZabcdefghijklmnopqrstuvwxyz
- Symbols:  
\_ (space) . , ( ) / @ & \$ ! ' # \* % + : ; < = > ? ^ [ ] ` { | } ~
- Numbers:  
0123456789

3

### Keys

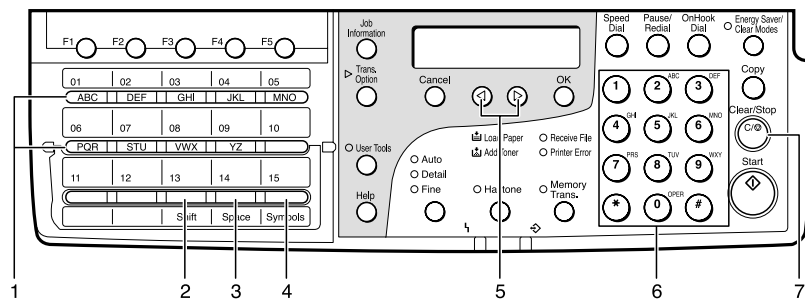

ZPW5040N

#### 1. Quick Dial 01 to 09 or Quick Dial 16 to 24 (A to Z)

Press these keys to enter upper and lower case letters.

Every time you press the same Quick Dial key, one of the three letters printed on a Quick Dial key is displayed. For example, when you press Quick Dial 01, the letter displayed changes in the order A → B → C → A as you press the key. Press to move the cursor and enter the next character.

#### 2. **[Shift]** key (Quick Dial 13 or 28)

Use to switch between upper and lower case.

#### 3. **[Space]** key (Quick Dial 14 or 29)

Press to enter a space.

#### 4. **[Symbols]** key (Quick Dial 15 or 30)

Press to enter symbols.

#### 5. or

Use to move the cursor left or right and to select a symbol.

#### 6. **Number keys**

Use to enter numbers.

## Registering

**7. [Clear/Stop] key**

Deletes the character at the cursor position. If the cursor is placed to the right of the last character at the right end of a line, that character will be deleted.

**How to Enter Characters**

The following procedure describes how to enter characters.

**3****Note**

- When you enter a character, it is shown at the position of the cursor. If there is a character at the cursor position, the entered character is shown before the character.

**1 Enter letters, symbols or numbers.**

Characters are entered and the cursor moves.

- For letters, press the Quick Dial keys (01 to 09 or 16 to 24). When the desired letter is displayed, press **⊞**.
- For symbols, press the **[Symbols]** key and **⏪** or **⏩** to select the symbol, and then press the **[OK]** key.
- For numbers, press the number key.

**Note**

- When you make a mistake, press the **[Clear/Stop]** key.
- When you want to insert a character, move the cursor to the character right of the position you want to enter the character. Now the inserted character is shown left of the cursor position.

**2 Press the [OK] key.****Wild Cards**

When you register other parties' Own Name or Own Fax Numbers for multiple destinations, you can register a sequence of characters common to these identifications as a wild card instead of registering every identification.

If a destination has an Own Name or Own Fax Number containing a wild card, the machine determines that the destination matches the registered destination.

**◆ Not using a wild card**

Destination to be registered (Own Name)	Number of registered identifications
NEW YORK BRANCH HONG KONG BRANCH SYDNEY BRANCH	3

**◆ Using a wild card**

Destination to be registered (Own Name)	Number of registered identifications
BRANCH	1

**Note**

- You can register up to 30 wild cards.
- Compare identifications by neglecting spaces.
- You can use wild cards for the following functions:
  - Memory Lock  
See p.72 "Memory Lock", <Advanced Features> .
  - Forwarding  
See p.76 "Forwarding", <Advanced Features> .

## 4. Troubleshooting

### Loading Paper in the Main Paper Tray

If there is no paper in the main paper tray, the  indicator on the control panel lights.

Use the following procedure to load the paper.

#### Important

- When loading paper, be careful not to pinch your fingers inside the machine.
- Before loading paper, make sure that the machine is not outputting a copy or received document.

#### Note

- Regarding paper types and sizes that can be used, see p.128 "Paper", <Advanced Features> .
- If you want to change the paper size, see p.62 "Changing the Paper Size Setting", <Advanced Features> .

**1** Make sure that the main paper tray is not being used.

**2** Pull out the main paper tray until it stops.

**3** Push the metal plate down, and then square the paper and load it in the tray.

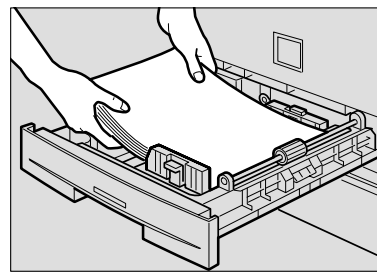

#### Important

- Do not stack paper over the limit mark.

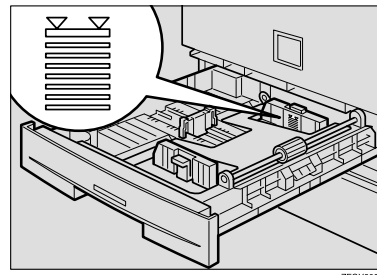

- If paper is left in the main paper tray and you add paper, a mis-feed might occur.

#### Note

- Shuffle the paper before setting it in the tray.

**4** Push the main paper tray in until it stops.

Troubleshooting

## Adjusting Volume

You can change the volume of the following sounds the machine makes.

- ❖ **On Hook**  
Sounds when you press the **[On Hook Dial]** key.
- ❖ **Transmission**  
Sounds when the machine send a message.
- ❖ **Reception**  
Sounds when the machine receives a message.
- ❖ **Dialing**  
After pressing the **[Start]** key, this sound is made until the line connects to the destination.
- ❖ **Key Tone**  
Sounds when keys on the Control panel are pressed.
- ❖ **Alarm**  
The sound to signal something going amiss.

4

**1** Press the **[User Tools]** key.

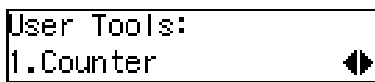
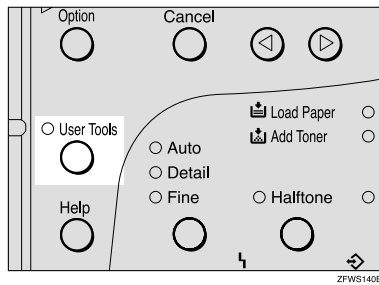

**2** Press **[Left]** or **[Right]** until " 2. Fax Features " is displayed.



**3** Press the **[OK]** key.



Confirm that " 1. Program / Delete " is displayed.

**4** Press **[Left]** or **[Right]** until " 3. Setup " is displayed.

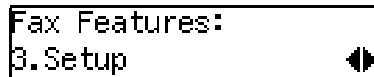

**5** Press the **[OK]** key.

Confirm that " 1. Monitor Volume " is displayed.



**6** Press the **[OK]** key.

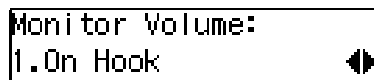

**7** Press **[Left]** or **[Right]** to select the item you want to adjust, and then press the **[OK]** key.

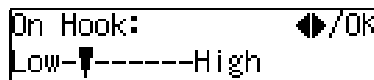

- 8** Press ◀ or ▶ to adjust the volume.



- 9** Press the [OK] key.  
The volume is adjusted.

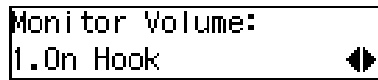

If you want to adjust another item, repeat steps **7** to **9**.

- 10** Press the [User Tools] key to return to standby display.

4

## Troubleshooting

# Clearing Original Jams

If an original is jammed, the **4** indicator on the Control Panel blinks and "Clear Misfed Original (S)" is displayed.

Perform the following procedure to clear the jammed original.

- 1** Open the ADF cover.

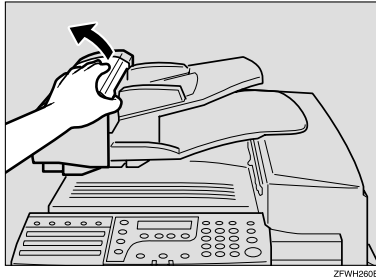

ZFWH260E

- 2** While pushing the release button, lift the ADF unit.

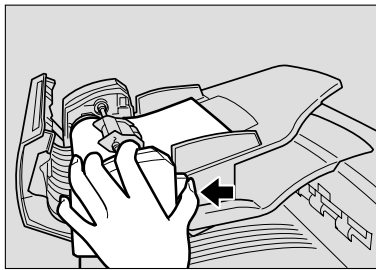

ZFWH270E

- 3** Remove the original.

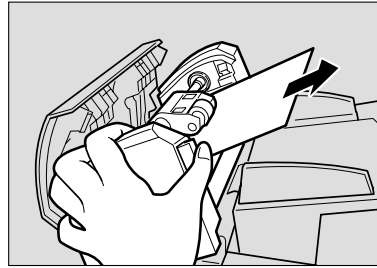

ZFWH280E

- 4** Close the ADF unit and ADF cover making sure it clicks firmly into place.

## Clearing a Copy, Fax, or Print Jam

If a copy, fax, or printed paper is jammed, the **J** indicator on the Control Panel blinks and "Clear Misfed Paper" is displayed.

Perform the following procedure to clear the jammed paper.

The inside of the machine could be very hot. Do not touch the parts with a label indicating the "hot surface". Otherwise an injury might occur.

### **Important**

- The fusing unit and surrounding area inside the machine becomes hot during printing. To avoid injury when removing paper jams, do not touch any parts other than those specified in this manual.

### **Note**

- If paper jams occur in the optional paper tray unit, see p.102 "Clearing a Copy, Fax or Print Jam", <Advanced Features> .

### Inside the Machine

- 1** Open the right cover.

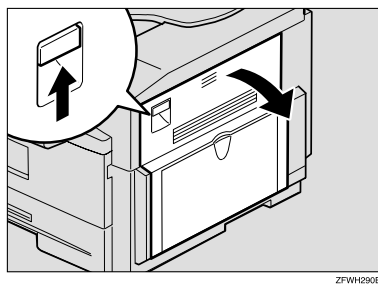

ZFWH230E

- 2** Open the blue cover.

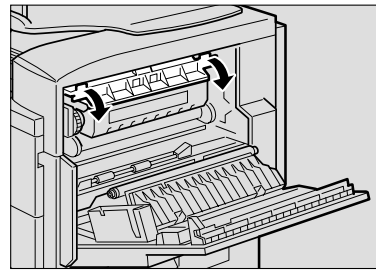

ZFWH300E

4

- 3** Pull out the jammed paper.

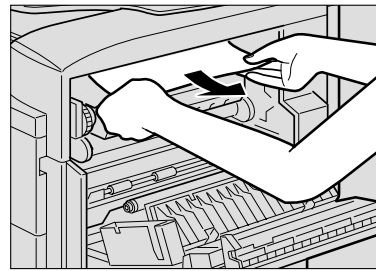

ZFWH310E

When paper is caught in the lower unit

- 1** Pull out the jammed paper.

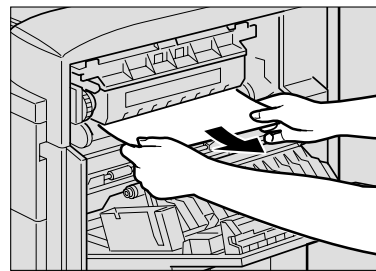

ZFWH320E

- 4** Close the right cover making sure it clicks firmly into place.

## Troubleshooting

# Error Messages

The following messages may appear while you are operating or programming the machine.

Message	Problem/Solution
No Files Exist	No polling reception operations have been programmed. There are no documents in memory waiting for transmission. Incorrect file number. Check the file number and try again.
Cannot Combine : (currently selected function)	Appears when you attempt to select a function that cannot be used in combination with another currently selected function.
This Key is in Use as a Group Dial	This Quick Dial Key has a Group stored in it.
This Key is in Use as a Program	This Quick Dial Key has a Keystroke Program stored in it.
This Key is in Use as a Quick Dial	This Quick Dial Key has a Quick Dial stored in it.
This Key is Not Programmed	Either: <ul style="list-style-type: none"> <li>This Quick Dial Key does not contain a number.</li> <li>This Quick Dial Key does not contain a Keystroke Program.</li> </ul>
This Speed Dial No. is Not Programmed	This Speed Dial number does not contain a number.
This Dest. is Already Selected	Either: <ul style="list-style-type: none"> <li>This number is already included in this Group.</li> <li>The same destination was specified more than once.</li> </ul>
Insert Pause "-" After Area Code	You must add a pause after your area code when you input your fax terminal's own telephone number.
Replace Toner	The toner cassette is empty. Install a new cassette.
Clear Misfed Original(s)	A document is jammed in the feeder.
Clear Misfed Paper	Paper is jammed in the printer.
Close Front/Right Cover	A cover is not closed properly. Check that all covers are closed.
Machine is in Use. Please Wait	Machine cannot print a list/file, because the plotter is not ready.
Call Service	Machine is out of order. Contact your service representative.
Check Paper Size. Press OK to Correct.	The size of the installed paper does not match the currently selected paper size. Press the <b>[OK]</b> key, and then set the paper size or install the appropriate paper.







Error Messages

Message	Problem/Solution
This Dial is in Use. Cannot Delete. This Dial is in Use. Cannot Change.	This Quick Dial is being used (such as for a Send Later Transmission).
Some Page(s) are Blank	An almost entirely blank document was scanned. Check your document.
Reset Toner Correctly	The toner cassette is not set correctly.
Toner is Almost Empty	The toner cassette is nearly empty.
Copy Mode Locked	Copy mode is disabled. Enable it with the User Parameters.
Change ADF Maintenance Kit	Replace the ADF Maintenance Kit.
Scanner Needs Cleaning	Wipe the exposure glass and the white strip.

## Troubleshooting









## When the Receive File Indicator is Lit

If the **Receive File** indicator is lit, a message has been received but could not be printed for some reason. The message was stored in memory (Substitute Reception). When you solve the problem, the message will be automatically printed out. The table below lists some problems that could have caused Substitute Reception to take place and their solutions.

Why Substitute Reception Occurred	Indication/Status	Solution
Paper has run out	 is lit red.	Load paper. See p.69 "Loading Paper in the Main Paper Tray".
Toner is empty	 is lit red.	Replace the toner cassette. See Cp.117 "Replacing the Toner Cassette", <Advanced Features> . <b>Note</b> <input type="checkbox"/> Even if there is no toner left, you can still send fax messages.
Paper is jammed	 is lit red.	Remove the jammed paper. p.73 "Clearing a Copy, Fax, or Print Jam"
Cover is open	 is lit red.	Close the cover.

## Solving Problems

This table lists some common problems and their solutions.

Problem	Required Action
Printed or sent image contains spots.	<p>The Document Feeder (ADF) or scanner is dirty. Clean them.</p> <p>Make sure that ink or correction fluid is dry before setting the original.</p> <p> <b>Reference</b> See p.112 "Cleaning the Scanner", &lt;Advanced Features&gt; .</p>
Received image is too light.	<p>Request the sender to increase the image density.</p> <p>When using moist, rough or processed paper, the printed image may be hard to see. Only use recommended paper.</p> <p> <b>Reference</b> See p.127 "Originals", &lt;Advanced Features&gt; .</p> <p>When  appears on the display, toner is beginning to run out. Replace the toner cassette soon.</p> <p> <b>Reference</b> See p.117 "Replacing the Toner Cassette", &lt;Advanced Features&gt; .</p>
Message appears blank at the other end.	<p>The original was set upside down. Set it properly.</p> <p> <b>Reference</b> See p.23 "Setting Originals".</p>
You want to cancel a Memory Transmission.	<p>If the original is being stored, press the <b>[Clear/Stop]</b> key.</p> <p> <b>Reference</b> See p.27 "Canceling a Memory Transmission".</p> <p>If the original is being sent, use "Cancel TX/RX" in the Job Information menu.</p> <p> <b>Reference</b> See p.13 "Canceling Transmission or Reception", &lt;Advanced Features&gt; .</p>
You want to cancel an Immediate Transmission.	<p>Press the <b>[Clear/Stop]</b> key.</p> <p> <b>Reference</b> See p.31 "Canceling an Immediate Transmission".</p>
You cannot add any destinations to a Group, even though the maximum number of destinations has not been reached.	<p>69 destinations have been programmed with the number keys. Program more numbers with Quick Dials or Speed Dials.</p> <p> <b>Reference</b> See p.57 "Groups"</p>

# INDEX

## A

---

- Add Toner indicator, 15
- ADF Cover, 13
- Adjusting Volume
  - Alarm*, 70
  - Dialing*, 70
  - Key Tone*, 70
  - On Hook*, 70
  - Reception*, 70
  - Transmission*, 70
- Advanced Features, 11
- Auto Receive, 39
- Auto Select, 39

## B

---

- Basic Features (this manual), 11
- Bypass Tray, 13

## C

---

- Cancel key, 15
- Characters
  - Available Characters*, 67
  - Entering*, 67
  - Keys*, 67
- Clear Modes key, 16
- Clear/Stop key, 16
- Components, 13
- Control Panel, 13, 15
- Copy key, 16
- CSI→Own Fax Number, 41

## D

---

- Deleting
  - Groups*, 63
  - Quick Dial*, 49
  - Speed Dial*, 55
- Detail, 32
- Dialing, 34
  - Entering Numbers Directly*, 34
  - Using Groups*, 37
  - Using Quick Dials*, 35
  - Using Speed Dials*, 36
- Dial label, 50
- Display, 18
- Document Feeder (ADF), 13, 24

## E

---

- Editing
  - Fax Header*, 44
  - Groups*, 60
  - Own Fax Number*, 44
  - Own Name*, 44
  - Quick Dial*, 48
  - Speed Dial*, 54
- Energy Saver/Clear Modes key, 16
- Energy Saver key, 16
- Entering Characters, 67
- Error Messages, 74
- External Telephone Connector, 14

## F

---

- Fax Header, 41
  - Editing*, 44
  - Registering*, 42
- Faxing, 21
- Fine, 32
- Front Cover, 13
- Front View, 13

## G

---

- G3 Line Connector, 14
- Getting Started, 13
- Group Name, 60
- Groups, 37, 57
  - Deleting*, 63
  - Dialing*, 37
  - Editing*, 60
  - Registering*, 57

## H

---

- Halftone, 33
- Halftone key, 16
- Handset (Option), 14
- Help key, 16
- How to Read this Manual, 10

## I

---

- Immediate Transmission, 21, 29
  - Canceling*, 31

**J**

Job Information key, 15

**L**

LCD display, 15  
 Loading Paper, 69  
 Load Paper Indicator, 15  
 Lower Right Cover, 13  
 Low-power Mode, 7

**M**

Main Paper Tray, 69  
 Manual Receive, 39  
 Manuals for This Machine, 11  
 Memory Card Slot, 14  
 Memory Trans. key, 16  
 Memory Transmission, 21, 25  
     *Canceling*, 27

**N**

NOTICE, 1  
 Number keys, 16  
     *Dialing*, 34

**O**

OK key, 15  
 On Hook Dial key, 16  
 Original guide, 14  
 Original Output Tray, 14  
 Original Tray, 14  
 Original Type, 32, 33  
 Output Tray, 13  
 Output tray guide, 14  
 Own Fax Number, 41  
     *Editing*, 44  
     *Registering*, 42  
 Own Name, 41  
     *Editing*, 44  
     *Registering*, 42

**P**

Paper Tray Unit, 13  
 Pause, 35  
 Pause/Redial key, 15  
 Power Switch, 14

**Q**

Quick Dial, 46  
     *Deleting*, 49  
     *Dialing*, 35  
     *Dial label*, 50  
     *Editing*, 48  
     *Registering*, 46  
 Quick Dial keys, 16

**R**

Receive File Indicator, 15, 76  
 Reception Mode  
     *Selecting*, 39  
 Reception Modes  
     *Auto Receive*, 39  
     *Auto Select*, 39  
     *Manual Receive*, 39  
 Registering  
     *Fax Header*, 41  
     *Groups*, 57  
     *Own Fax Number*, 41  
     *Own Name*, 41  
     *Quick Dial*, 46  
     *Speed Dial*, 52  
 Release Button, 13  
 Resolution, 32  
 Resolution key, 16  
 Right Cover, 14  
 RTI→Own Name, 41

**S**

Scan Settings, 32  
 Setting Originals, 23  
 Side View, 14  
 Solving Problems, 77  
 Speed Dial, 52, 54, 55  
     *Deleting*, 55  
     *Dialing*, 36  
     *Editing*, 54  
     *Registering*, 52  
 Speed Dial key, 15  
 Standard, 32  
 Starting the Machine, 17  
 Start key, 16  
 Status Indicators  
     *Alarm*, 16  
     *Communicating*, 16  
 Substitute Reception, 76

## T

---

- Tone, 35
- Transmission Modes, 21
- Trans. Option key, 15
- Troubleshooting, 69
  - Error Messages*, 74
- TTI→Fax Header, 41

## U

---

- User Function keys, 15
- User Tools key, 16

## V

---

- Ventilation hole, 14
- Volume, 70

## W

---

- Wild Cards, 68

## Free Manuals Download Website

<http://myh66.com>

<http://usermanuals.us>

<http://www.somanuals.com>

<http://www.4manuals.cc>

<http://www.manual-lib.com>

<http://www.404manual.com>

<http://www.luxmanual.com>

<http://aubethermostatmanual.com>

Golf course search by state

<http://golfingnear.com>

Email search by domain

<http://emailbydomain.com>

Auto manuals search

<http://auto.somanuals.com>

TV manuals search

<http://tv.somanuals.com>