

3460DNP

Operating Instructions

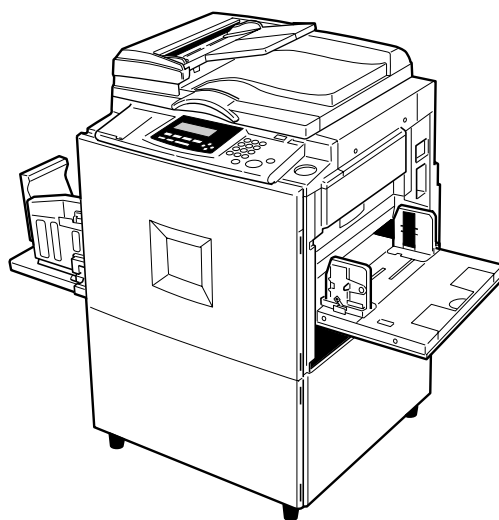

For safety, please read this manual carefully before you use this product and keep it handy for future reference.

Note to users in the United States of America

Notice:

This equipment has been tested and found to comply with the limits for a Class B digital device, pursuant to Part 15 of the FCC Rules. These limits are designed to provide reasonable protection against harmful interference in a residential installation. This equipment generates, uses and can radiate radio frequency energy and, if not installed and used in accordance with the instructions, may cause harmful interference to radio communications. However, there is no guarantee that interference will not occur in a particular installation. If this equipment does cause harmful interference to radio or television reception, which can be determined by turning the equipment off and on, the user is encouraged to try to correct the interference by one more of the following measures:

Reorient or relocate the receiving antenna.

Increase the separation between the equipment and receiver.

Connect the equipment into an outlet on a circuit different from that to which the receiver is connected.

Consult the dealer or an experienced radio /TV technician for help.

Warning

Changes or modifications not expressly approved by the party responsible for compliance could void the user's authority to operate the equipment.

Note to users in Canada

Note:

This Class B digital apparatus complies with Canadian ICES-003.

Remarque concernant les utilisateurs au Canada

Avertissement:

Cet appareil numérique de la classe B est conforme à la norme NMB-003 du Canada.

In accordance with IEC 60417, this machine uses the following symbols for the main switch:

I means POWER ON.

O means POWER OFF.

Introduction

This manual describes detailed instructions on the operation and notes about the use of this machine. To get maximum versatility from this machine all operators are requested to read this manual carefully and follow the instructions. Please keep this manual in a handy place near the machine.



Notes:

Some illustrations in this manual might be slightly different from the machine.
Certain options might not be available in some countries. For details, please contact your local dealer.



Two kinds of size notation are employed in this manual. With this machine refer to the inch version.

For good print quality, Standard recommends that you use genuine Standard masters and inks.

Standard shall not be responsible for any damage or expense that might result from the use of parts other than genuine Standard parts in your Standard office product.

Power Source

120V, 60Hz, 2.4A or more

Please be sure to connect the power cord to a power source as above. For details about power source, ⇒ p.200 "Power Connection".

Safety Information

When using this machine, the following safety precautions should always be followed.

Safety During Operation

In this manual, the following important symbols are used:

⚠ WARNING:
Indicates a potentially hazardous situation which, if instructions are not followed, could result in death or serious injury.

⚠ CAUTION:
Indicates a potentially hazardous situation which, if instructions are not followed, may result in minor or moderate injury or damage to property.

⚠ WARNING:

- **Connect the power cord directly into a wall outlet and never use an extension cord.**
- **Disconnect the power plug (by pulling the plug, not the cable) if the power cable or plug becomes frayed or otherwise damaged.**
- **To avoid hazardous electric shock, do not remove any covers or screws other than those specified in this manual.**
- **Turn off the power and disconnect the power plug (by pulling the plug, not the cable) if any of the following occurs:**
 - **You spill something into the machine.**
 - **You suspect that your machine needs service or repair.**
 - **The external housing of your machine has been damaged.**

⚠ CAUTION:

- *Protect the machine from dampness or wet weather, such as rain, snow.*
- *Unplug the power cord from the wall outlet before you move the machine. While moving the machine, you should take care that the power cord will not be damaged under the machine.*
- *When you disconnect the power plug from the wall outlet, always pull the plug (not the cable).*
- *Do not allow paper clips, staples, or other small metallic objects to fall inside the machine.*
- *For environmental reasons, do not dispose of the machine or expended supply waste at household waste collection points. Disposal can take place at an authorized dealer.*
- *Be careful not to cut yourself on any sharp edges when you reach inside the machine to remove misfed sheets of paper or masters.*
- *Our products are engineered to meet high standards of quality and functionality, and we recommend that you use only the expendable supplies available at an authorized dealer.*

How to Read This Manual

Symbols

In this manual, the following symbols are used:

WARNING:

This symbol indicates a potentially hazardous situation that might result in death or serious injury when you misuse the machine without following the instructions under this symbol. Be sure to read the instructions, all of which are described in the Safety Information section.

CAUTION:

This symbol indicates a potentially hazardous situation that might result in minor or moderate injury or property damage that does not involve personal injury when you misuse the machine without following the instructions under this symbol. Be sure to read the instructions, all of which are described in the Safety Information section.

* The statements above are notes for your safety.

Important

If this instruction is not followed, paper might be misfed, originals might be damaged, or data might be lost. Be sure to read this.

Preparation

This symbol indicates the prior knowledge or preparations required before operating the machine.

Note

This symbol indicates precautions for operation, or actions to take after misoperation.

Limitation

This symbol indicates numerical limits, functions that cannot be used together, or conditions in which a particular function cannot be used.

Reference

This symbol indicates a reference.

[]

Keys that appear on the machine's display panel.

【 】

Keys built into the machine's operation panel.

Making Prints

Before making prints using this machine, you have to make a master by pressing the **[Start]** key. When you press the **[Start]** key, the machine scans the original image and makes a master. This procedure describes how to make basic prints.

1 Place your originals in one of the following two ways:

Placing originals on the exposure glass

1 Place a single page face down.

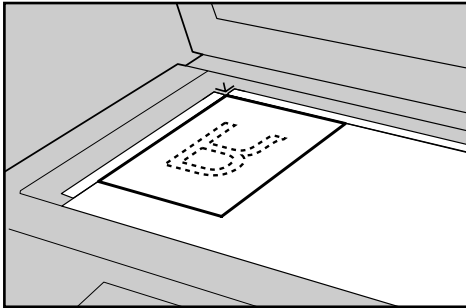

ZDCH110E

Inserting originals in the optional document feeder

1 Insert a stack of originals face up.

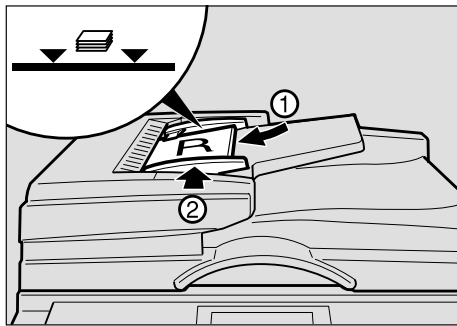

ZDCH120E

Note

- To avoid jamming, fan the originals before placing them in the document feeder.

2 Press the **[Start]** key.

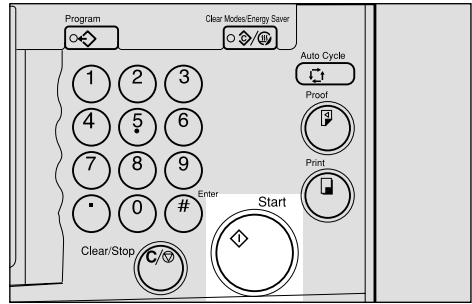

ZBHS280N

3 Press the **[Proof]** key.

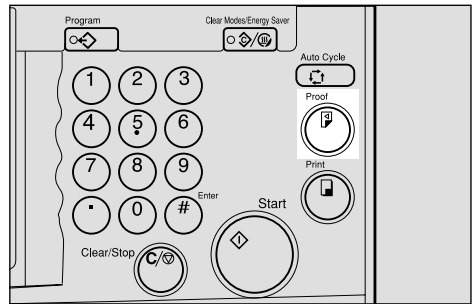

ZBHS290N

Check the print image.

Reference

For changing the image position, see p.24 "Adjusting the Position of Printed Images".

Ready for Master Making/ Printing			
	11x17		0.00in.
Letter	100%	Std.	0.00in.
Original	Ratio	Ppr.Type	Image

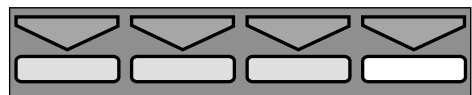

TPES560E

To increase the image density, press the **[<]** key. See p.25 "Adjusting the Image Density of Prints".

To decrease the image density, press the **[▶]** key. See p.25 “Adjusting the Image Density of Prints”.

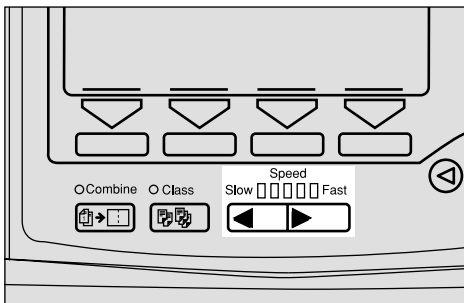

ZBHS300N

- 4** Enter the desired number of prints with the number keys.

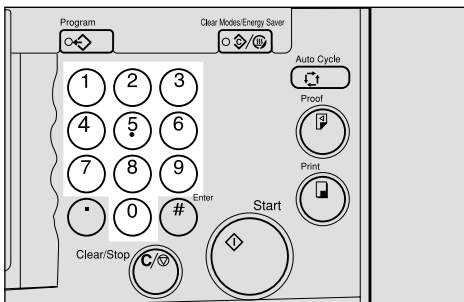

ZBHS310N

- 5** Press the **[Print]** key.

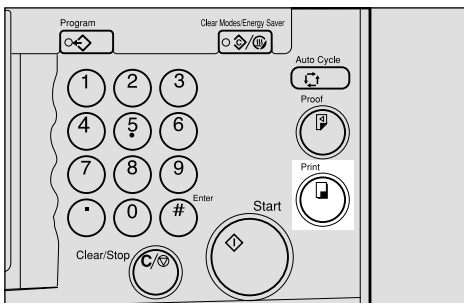

ZBHS320N

When the print job has finished, press the **[Clear Modes/Energy Saver]** key. Previously entered job settings will be cleared.

What You Can do with this Machine

Below is a quick summary of this machine's features and where to look in this manual for more information.

❖ Standard Printing

See p.19 "Standard Printing".

❖ Energy Saver Mode

See p.22 "Energy Saver Mode"

❖ Adjusting the Print Image Position

See p.24 "Adjusting the Position of Printed Images".

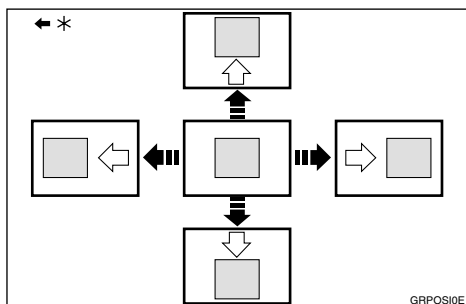

* Paper feed direction

❖ Adjusting the Print Image Density

See p.25 "Adjusting the Image Density of Prints".

❖ Tint Mode

See p.26 "Tint Mode".

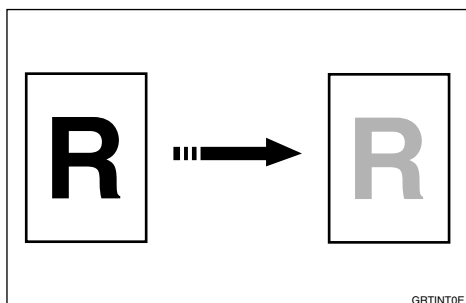

❖ Changing the Printing Speed

See p.27 "Changing the Printing Speed".

❖ Reducing and Enlarging Using Preset Ratios

See p.29 "Reducing and Enlarging Using Preset Ratios".

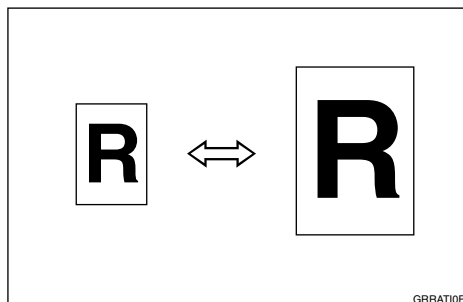

❖ Auto Magnification

See p.31 "Auto Magnification".

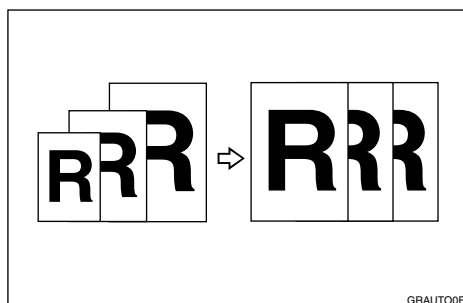

❖ Zoom

See p.34 "Zoom".

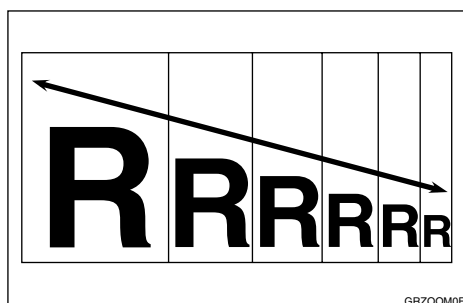

❖ **Directional Magnification (%)**

See p.36 “Directional Magnification (%)”.

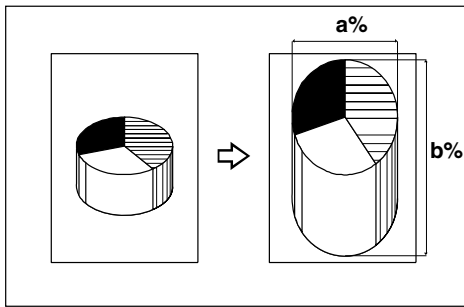

CP2P01EE

❖ **Directional Magnification (Size)**

See p.38 “Directional Magnification (Size)”.

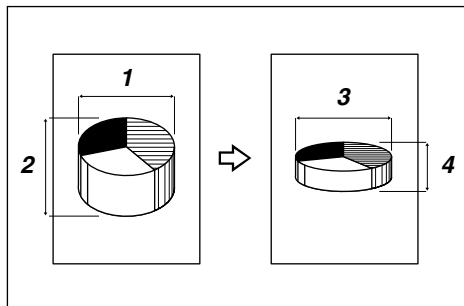

CP2M01EE

❖ **Erasing Center and Edge Margins**

See p.40 “Erasing Center and Edge Margins”.

❖ **Edge Erase**

See p.41 “Edge Erase”.

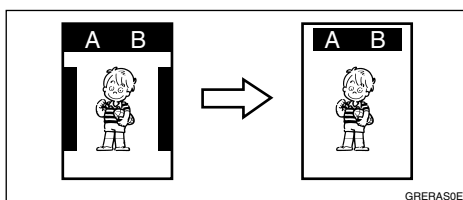

GRERAS0E

❖ **Printing on Various Kinds of Paper**

See p.43 “Printing onto Various Kinds of Paper”.

❖ **Selecting Original Modes**

See p.46 “Selecting Original Modes”.

❖ **Economy Mode**

See p.50 “Economy Mode”.

❖ **Auto Cycle**

See p.51 “Auto Cycle”.

❖ **All Class Mode**

See p.52 “All Class Mode”.

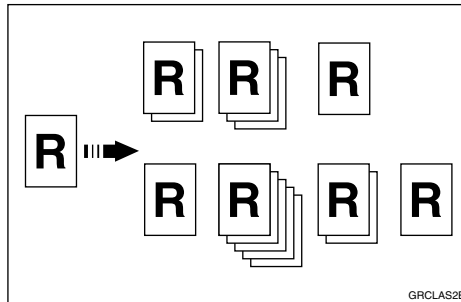

GRCLAS2E

❖ **Auto Class Mode**

See p.54 “Auto Class Mode”.

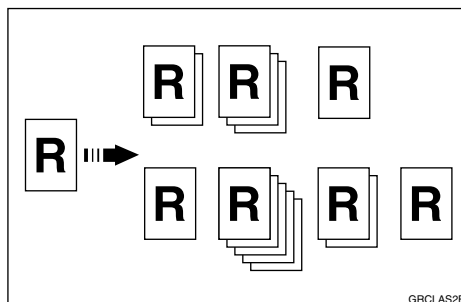

GRCLAS2E

❖ **Manual Class Mode**

See p.57 “Manual Class Mode with One Original”.

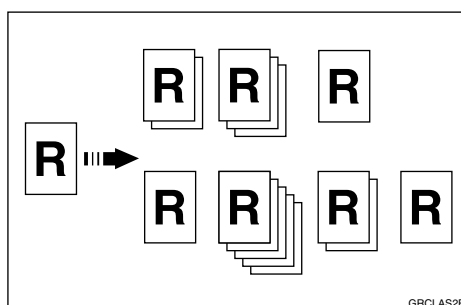

GRCLAS2E

❖ **Manual Class Mode with two or More Originals**

See p.59 "Manual Class Mode with two or More Originals".

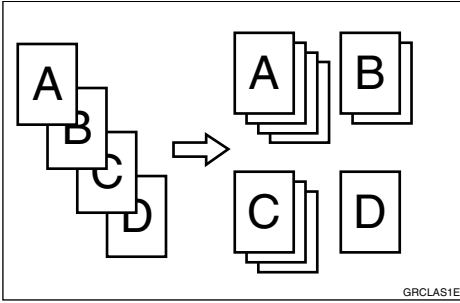

❖ **Class Mode**

See p.62 "Class Mode".

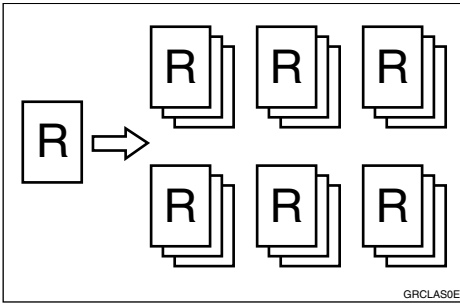

❖ **Combining Originals**

See p.64 "Combine Originals".

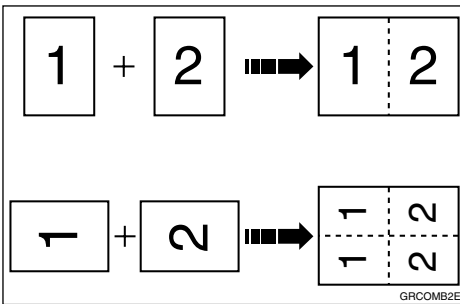

❖ **Auto Combine Mode**

See p.69 "Auto Combine Mode".

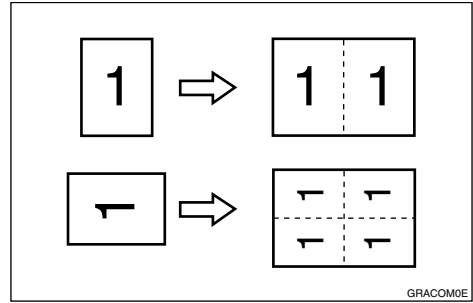

❖ **Skip Feed Printing**

See p.71 "Skip Feed Printing".

❖ **Programs**

See p.73 "Programs".

❖ **Security Mode**

See p.76 "Security Mode".

❖ **Quality Start Mode**

See p.77 "Quality Start Mode".

❖ **Job Separation**

See p.79 "Job Separation".

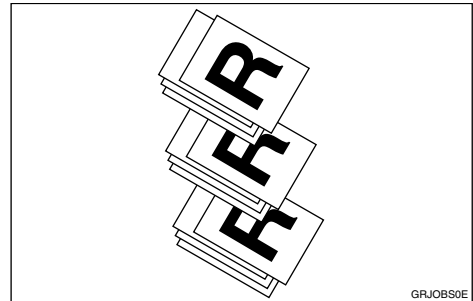

❖ **Conserving the Master**

See p.81 "Conserving the Master".

❖ **On Line Printing**

See p.83 "On Line Printing".

❖ **Making Color Prints**

See p.132 "Making Color Prints".

❖ **Printing in Two Colors**

See p.134 "Printing in Two Colors".

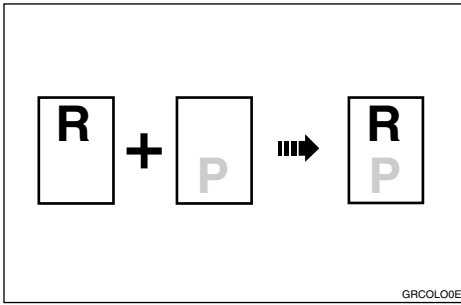

❖ **Date Stamp**

See p.111 "Date Stamp".

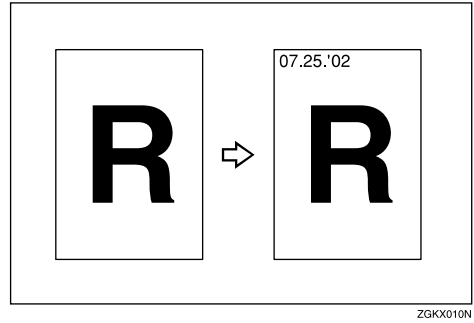

❖ **Image Rotation**

See p.85 "Image Rotation".

❖ **Make-up Printing**

See p.97 "Make-up Printing".

❖ **Merging Images**

See p.108 "Image Overlay".

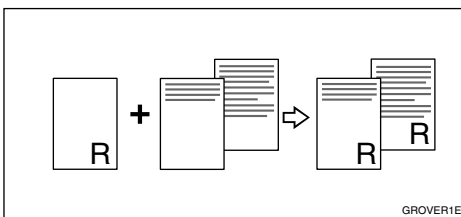
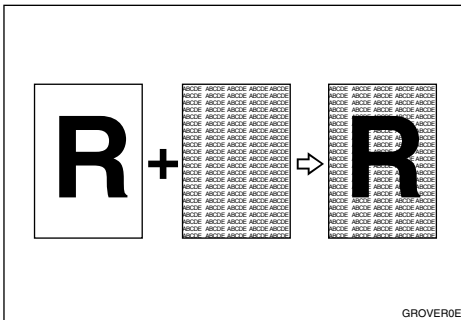

❖ **Page Stamp**

See p.113 "Page Stamp".

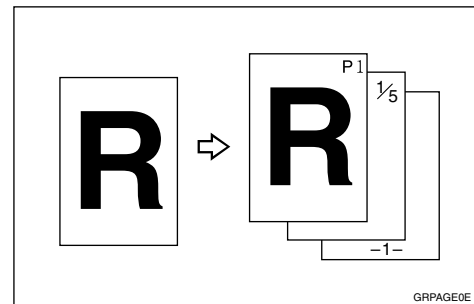

❖ **Stamp**

See p.116 "Stamp".

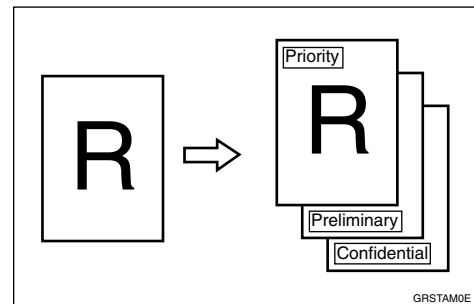

❖ **Memory Combine**

See p.118 “Memory Combine”.

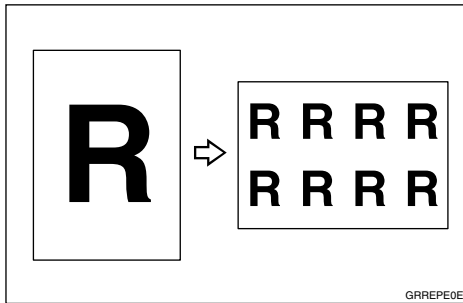
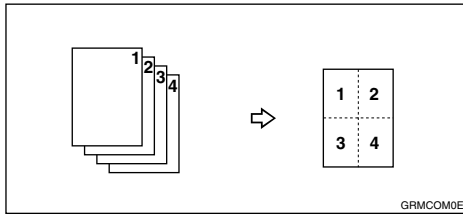

❖ **Original Storage**

See p.103 “Original Storage”.

❖ **Storage Overlay**

See p.108 “Image Overlay”.

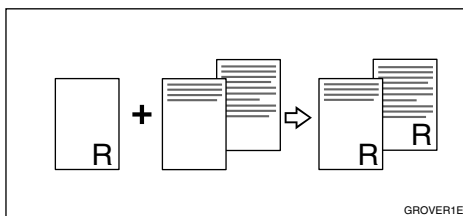
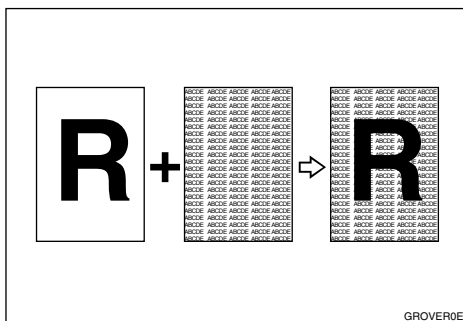

TABLE OF CONTENTS

Machine Exterior	1
Machine Interior	2
Options	4
Operation Panel	5
Keys.....	5
Indicators.....	7
Panel Display	8
Panel Display Layout.....	9

1. Operation

Print Paper	11
Originals	13
Printing Preparations	15
Loading Paper.....	15
Setting Up The Paper Delivery Tray.....	16
Entering a User Code to Use the Machine	18
Standard Printing	19
Removing Prints.....	20
Energy Saver Mode	22
Auto Reset	23
Adjusting the Position of Printed Images	24
Adjusting the Image Density of Prints	25
Before Making a Master.....	25
After Making a Master.....	25
Tint Mode	26
Changing the Printing Speed	27
Stopping a Multi-print Run	28
Stopping a Multi-print Run to Print Another Original.....	28
Changing the Number of Prints Entered and Checking Completed Prints... ..	28
Reducing and Enlarging Using Preset Ratios	29
Auto Magnification	31
Zoom	34
Directional Magnification (%)	36
Directional Magnification (Size)	38
Erasing Center and Edge Margins	40
Edge Erase	41

Printing onto Various Kinds of Paper.....	43
Printing onto Thick Paper.....	43
Printing onto Standard Paper.....	43
Printing onto Envelopes.....	44
Printing onto Special Kinds of Paper.....	44
Selecting Original Modes.....	46
Letter/Photo Mode Printing.....	46
Photo Mode Printing.....	47
Pencil Mode Printing.....	48
Economy Mode.....	50
Auto Cycle.....	51
All Class Mode.....	52
Auto Class Mode.....	54
Manual Class Mode with One Original.....	57
Manual Class Mode with two or More Originals.....	59
Class Mode.....	62
Combine Originals.....	64
Auto Combine Mode.....	69
Skip Feed Printing.....	71
Programs.....	73
Storing a Program.....	73
Protecting a Program.....	74
Removing Program Protection.....	74
Recalling a Program.....	75
Security Mode.....	76
Quality Start Mode.....	77
Using Quality Start Manually.....	77
Job Separation.....	79
Conserving the Master.....	81
Double Feed.....	82
When a Double Feed is Detected.....	82
On Line Printing.....	83
Auto On Line.....	84
Image Rotation.....	85
Make-up Printing Features.....	86
Main Features.....	86
Make-up Modes for Designated Areas.....	86
Make-up Modes for Outside Designated Areas.....	88
Background Patterns.....	89

Command Sheets for Make-Up Printing	90
Command Sheets	90
Making a Command Sheet.....	90
Command Sheets and Finished Prints.....	95
Make-up Printing	97
Make-up Samples	100
Original Storage	103
Storing Originals.....	103
Selecting Stored Originals.....	105
Protecting Stored Originals	105
Deleting Stored Originals	106
Image Overlay	108
Storage Overlay	108
On Line Overlay	109
Overlay Format	109
Date Stamp	111
Page Stamp	113
Stamp	116
Memory Combine	118
Combining onto a Single-sided Print	118
Repeat.....	123

2. Optional Functions

Optional Document Feeder	127
Originals	127
Placing Originals	128
Combine Printing.....	129
Manual Class Mode with Two or More Originals.....	130
Color Printing Using the Optional Color Drum	132
Making Color Prints	132
Changing the Color Drum Unit	132
Printing in Two Colors	134
Changing the Drum Size	136
Printing Area (At 23°C/73°F, 65% RH).....	136
Master Cut Length.....	136

3. Combination Chart

Combination Chart	137
--------------------------------	------------

4. User Tools

Accessing the User Tools.....	141
User Tools Menu.....	143
1. System	143
2. Set Operat'n Mode	144
3. Initial Setting.....	145
4. Mode Setting	146
5. Stamp.....	151
6. Administrator Mode	153
7. On Line Mode.....	154
User Tool Menus in Detail.....	156
1-6 Time Setting.....	156
3-4 Reproduction Ratio	156
3-5 Class Enter No.....	157
3-11 Margin Erase Area.....	158
4-11 No. of Skip Feed	159
4-14 No. of Q.start.....	160
4-19 Type of Paper	161
5-4 Stamp Position	162
5-7 Position (Date)	163
5-10 Position (Page)	164
5-11 Make/Chg. Pattern.....	165
6-1 Check Counter	166
6-2 Reset Counters	167
6-5 Chg. User Code	168
6-6 Del. User Code	168

5. Troubleshooting

If Your Machine Does Not Operate as You Want.....	171
If You Cannot Make Prints as You Want	173
Combine Originals Mode.....	173
Loading Paper.....	174
☞ Clearing Misfeeds.....	175
"☞ + A" Paper Misfeeds in the Paper Feed Section.....	175
"☞ + A + B" Paper Misfeeds in the Paper Feed Section	176
"☞ + B" Paper or Master Wrapped Around the Drum.....	177
"☞ + C" Paper Misfeeds in the Paper Exit Section.....	179
"☞ + D" Master Misfeeds in the Master Feed Section.....	179
"☞ + D + B" Master Misfeeds in the Master Feed Section	180
"☞ + B + E" Master Misfeeds in the Master Eject Section.....	181
"☞ + E" Master Misfeeds in the Master Eject Section	182
"☞ + P" Original Misfeeds Occur When Using the Optional Document Feeder ...	183

When the Open Cover/Unit Indicator (☐*) Lights.....	185
When the Add Ink Indicator (☒) Lights.....	186
When the Master End Indicator (☒) Lights.....	188
When the Master Eject Indicator (☒) Lights.....	190
When Other Indicators Are Lit.....	191
When Prints Are Not Delivered in a Neat Stack.....	192
When Printing on Small Size Paper.....	192
When the Machine Cannot Detect the Paper Size.....	192
Poor Printing.....	193
Dirty Background.....	193
Black Lines/Stained Prints	196
Faint Prints	196

6. Remarks

Do's and Don'ts	197
Where to Put Your Machine.....	199
Environment.....	199
Power Connection.....	200
Machine Clearance	200
Maintaining Your Machine.....	201
Cleaning the Main Frame.....	201
Cleaning the Optional Document Feeder.....	202

7. Specifications

Main Frame.....	203
Document Feeder (Option)	207
Color Drum Type 80(L) A3, 11" × 17" (Option).....	207
Color Drum Type 80(S) A4, 8¹/₂" × 11" (Option)	207
Exposure Glass Cover (Option)	207
Printer Unit Type 80 RCP80 (Option).....	207
Interface Cable Type 85 (Option)	207
Editing Function Type 85 (Option).....	208
PC Controller (Option)	208
Key Counter (Option)	208
Twin Color Press Roller Printing System TC-II (Option).....	209
Consumables.....	210
INDEX.....	211

Machine Exterior

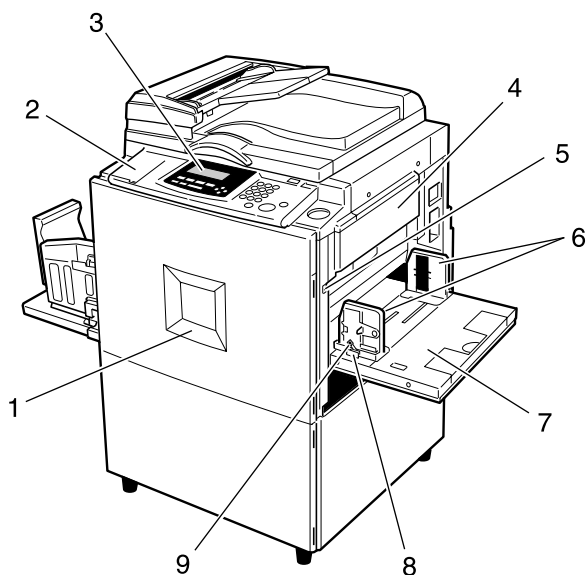

ZGKH010N

1. Front door

Open to access the inside of the machine.

2. Flip up cover

Flip up to access the keys underneath.

3. Operation panel

See p.5 "Operation Panel".

4. Master tray

Open this unit when installing the master.

5. Paper feed tray down key

Press to lower the paper feed tray.

6. Paper feed side plates

Prevent paper skewing.

7. Paper feed tray

Load paper here.

8. Paper feed side plates knob

Use to move the side plates.

9. Paper feed side plates knob lock lever

Locks the paper feed side plates.

Machine Interior

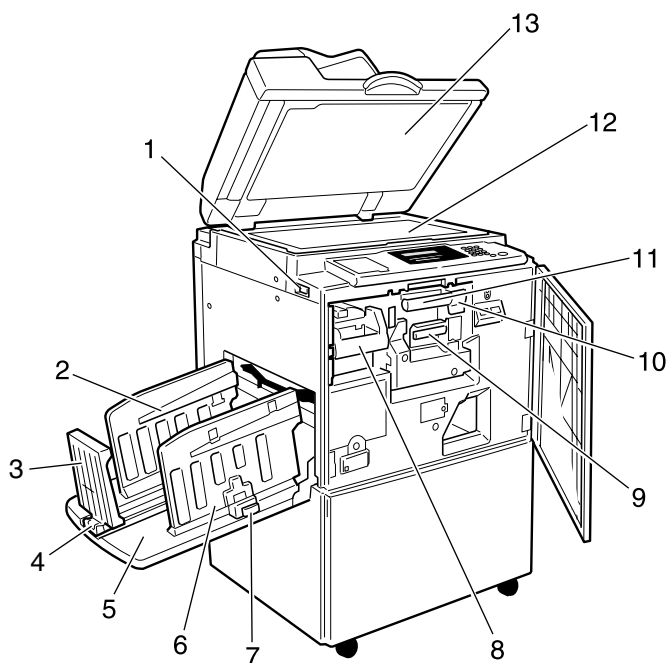

ZBHH180E

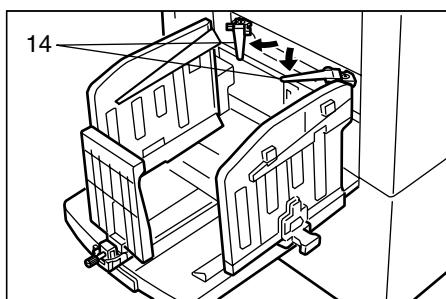

ZDZH120E

1. Main switch

Use to turn the power on or off.

2. Paper alignment wings

Lift or lower the wings depending on the type of paper being used.

3. Paper delivery end plate

This plate aligns the leading edge of prints.

4. Paper delivery end plate knob

Use to move the end plate.

5. Paper delivery tray

Completed prints are delivered here.

6. Paper delivery side plates

These plates align the prints on the paper delivery tray.

7. Paper delivery side plate knobs

Use to move the side plates.

8. Handle E1

Use to pull out the master eject unit.

9. Ink holder

Set the ink cartridge in this holder.

10. Drum unit lock lever B1

Lower to unlock and pull out the drum unit.

11. Drum unit

The master is wrapped around this unit.



12. Exposure glass

Position originals here face down for printing.

13. Exposure glass cover or document feeder (option)

Lower this cover over an original on the exposure glass.

14. Trailing edge guides

Swing out these guides when you use A4, 8¹/₂" × 11"   paper.

Options

◆ Document feeder

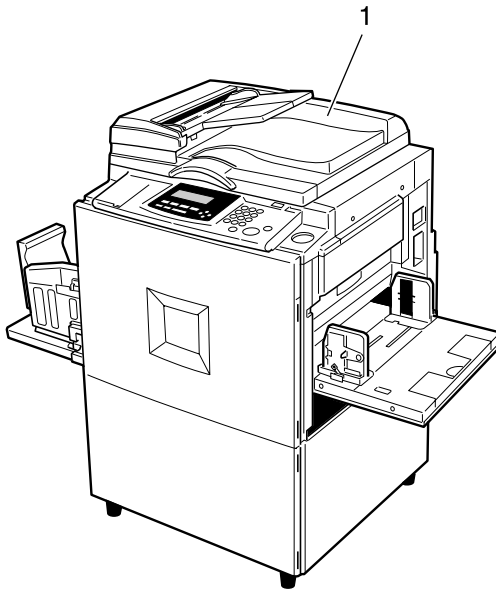

ZGKH020N

1. Document Feeder

Note

Other options:

- Color Drum Type 80(L) A3, 11" × 17"
- Color Drum Type 80(S) A4, 8¹/₂" × 11"
- Exposure Glass Cover
- Printer Unit Type 80 RCP80
- Interface Cable Type 85
- Editing Function Type 85
- Key Counter
- PC Controller
- Twin color press roller printing system TC-II

Operation Panel

Keys

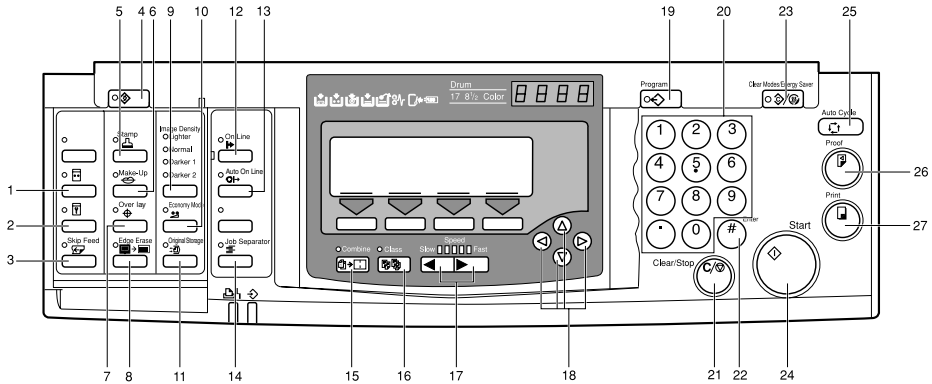

ZDZS200N

1. **[Quality Start]** key

See p.77 "Quality Start Mode".

2. **[Security]** key

See p.76 "Security Mode".

3. **[Skip Feed]** key

Press to select skip feed printing. See p.71 "Skip Feed Printing".

4. **[User Tools]** key

Press to change the default settings to meet your requirements.

5. **[Stamp]** key

Press to select the Stamp mode. See p.111 "Date Stamp", see p.113 "Page Stamp", see p.116 "Stamp".

6. **[Make-Up]** key

Press to select the Make-up mode. See p.97 "Make-up Printing".

7. **[Overlay]** key

Press to select the Image Overlay mode. See p.108 "Image Overlay".

8. **[Edge Erase]** key

Press to select Edge Erase mode. See p.41 "Edge Erase".

9. **[Image Density]** key

Press to make prints darker or lighter. See p.25 "Adjusting the Image Density of Prints".

10. **[Economy Mode]** key

Press to save ink. See p.50 "Economy Mode".

11. **[Original Storage]** key

Press to select the Original Storage function. See p.103 "Original Storage".

12. **[On Line]** key

See p.83 "On Line Printing".

13. **[Auto On Line]** key

See p.83 "On Line Printing".

14. **[Job Separator]** key

See p.79 "Job Separation".

15. **[Combine]** key

Press to combine originals onto one print. See p.64 "Combine Originals", see p.118 "Memory Combine", see p.69 "Auto Combine Mode".

16. [Class] key

Press to select All Class, Auto Class, Manual Class, or Class mode. See p.52 "All Class Mode", see p.54 "Auto Class Mode", see p.57 "Manual Class Mode with One Original", see p.59 "Manual Class Mode with two or More Originals", see p.62 "Class Mode".

17. [◀][▶] keys (Speed keys)

Press to adjust the printing speed. See p.25 "Adjusting the Image Density of Prints", see p.27 "Changing the Printing Speed".

18. [◀][▶][△][▽] keys

Press to shift the image forward, backward, right, or left. See p.24 "Adjusting the Position of Printed Images".

Also use to highlight items you wish to select on the panel display.

19. [Program] key

Press to enter or recall programs. See p.73 "Programs".

20. Number keys

Press to enter the desired number of prints and data for selected modes.

21. [Clear/Stop] key

Press to stop printing.

22. [#] key

Use to enter data in selected modes.

23. [Clear Modes/Energy Saver] key

Press to clear any previously entered job settings.

24. [Start] key

Press to make a master.

25. [Auto Cycle] key

Use to process the master and make prints in one operation. See p.51 "Auto Cycle".

26. [Proof] key

Press to make proof prints.

27. [Print] key

Press to start printing.

Indicators

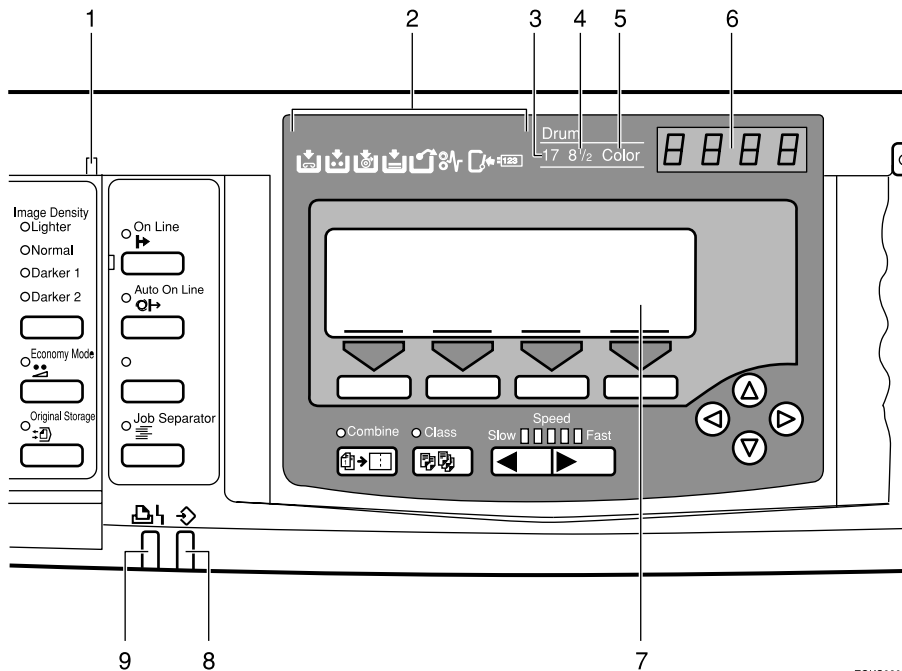

ZGKS020N

1. Special feature indicator

Lights to indicate that special features have been selected. To access the special features, lift up the cover on the left side of the operation panel.

2. Monitor indicators

These indicators light to inform you of the status of the machine. See p.171 "If Your Machine Does Not Operate as You Want".

3. A3/11" × 17" drum indicator

Lights when the A3, 11" × 17" drum unit is installed. See p.136 "Changing the Drum Size".

4. A4, 8¹/₂" × 11" drum indicator

Lights when the A4, 8¹/₂" × 11" drum unit is installed. See p.136 "Changing the Drum Size".

5. Color drum indicator

Lights when the color drum unit is installed. See p.132 "Color Printing Using the Optional Color Drum".

6. Counter

Displays the number of prints entered. While printing, it shows the number of prints remaining.

7. Panel display

See p.8 "Panel Display".

8. Data In indicator (Green)

Indicates the status of this machine:

- On: Data waiting for Master Making and printing is in the machine.
- Blinking: Data is being received, or Master Making or printing is in progress.
- Off: Master Making and printing are completed.

9. Error indicator (Red)

Indicates the status of this machine:

- On: An error has occurred. Master Making and printing stops.
- Off: Normal status

Panel Display

The panel display shows the machine status, error messages, and function menus.

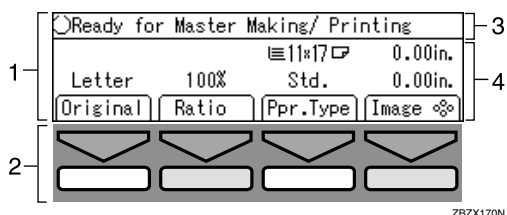

1. Items for the selected function

3. Machine status or messages

2. These keys correspond to the selectable items shown above them on the panel display. To select an item shown on the panel display, press the key directly below it.

4. Items which can be selected

Important

- Strong impact or pressure exceeding 30N will damage the panel display.

Note

- When you select an item on the panel display, it is highlighted (e.g. **Auto**). Items shown grayed-out (e.g. **OK**) cannot be selected.
- Common panel display items

[OK]	Confirms a function selection or enters a value.
[Cancel]	Cancels a function selection or entered value and returns to the previous display.
[Prev.][Next]	When there are too many items to fit on the panel display, use these keys to move between pages.
[◀][▶][△][▽][←][→]	Press to highlight items you wish to select on the panel display.
[Select]	Selects a value.
[Exit]	Returns to the previous display.

Panel Display Layout

The basic elements used on the panel display are shown below. Understanding their meaning helps you use this machine's features quickly and easily.

◆ Sample display when selecting the [Original] key

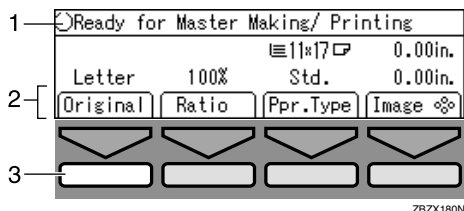

1. Machine status or message

2. Available functions

3. Illustrations of displays in this manual show the next key to be pressed whitened

When the [Original] key is pressed, the following display is shown.

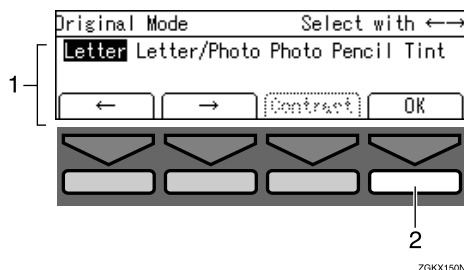

1. Available functions

2. Confirms the settings

1. Operation

Print Paper

The following limitations apply

	Paper Size		Paper Weight
	Metric	Inch	
Paper feed tray	A3 ☐, B4 ☐, A4 ☐ ☐, B5 ☐ ☐, A5 ☐, B6 ☐, A6 ☐, Others (Vertical: 70 - 297mm, Horizontal: 148 - 432mm)	11" × 17" ☐, 8 ¹ / ₂ " × 14" ☐, 8 ¹ / ₂ " × 11" ☐ ☐, 5 ¹ / ₂ " × 8 ¹ / ₂ " ☐ ☐, Others (Vertical: 2.76" - 11.7", Horizontal: 5.83" - 17")	47.1 - 209.3g/m ² , 12.5 - 55.6 lb

Non-recommended paper:

- Roughly cut paper
- Paper of different thickness in the same stack
- Envelopes heavier than 85g/m², 22 lb.
- Folded, curled, creased, or damaged paper
- Torn paper
- Slippery paper
- Rough paper
- Paper with any kind of coating (such as carbon)
- Short grain paper
- Thin paper that has low stiffness
- Paper that may create a lot of dust
- Grained paper with the direction of the grain running opposite to the feed direction
- Certain types of long thin envelopes.
E.g. international mail envelopes

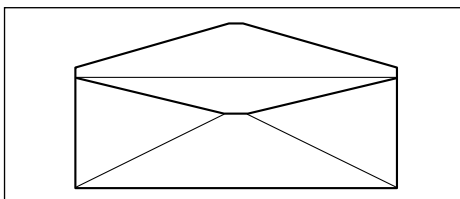

ZFXX040N

- The following types of envelopes

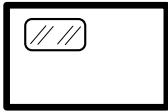
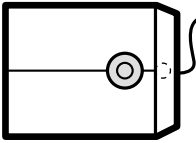
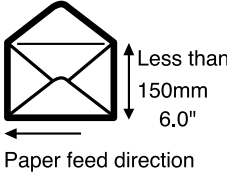
Envelopes with glue or gum	Envelopes with windows	Envelopes with round tags	Open envelopes
			

Note

- If you print on rough grained paper, the copy image might be blurred.
- You can use A3 (297 × 420mm) or 11" × 17" originals or printing paper. When you want to print the entire image of an A3, 11" × 17" original, select Reduce mode because the maximum print areas are as follows:
 - Metric version: 290 × 409mm, 11.4" × 16.1"
 - Inch version: 290 × 419mm, 11.4" × 16.4"
- When you use A3, 11" × 17" and 209.3g/m², 55.6 lb paper, slow the printing speed down to setting 1, 2, or 3.

Important

- Correct curls in the paper before placing it in the machine. When you cannot correct the paper curl, stack the paper with the curl face down or face up as shown in the illustration. If the paper is curled, it might wrap around the drum or stains might appear.

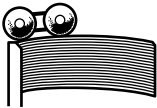
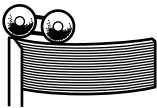
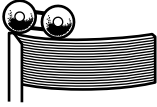
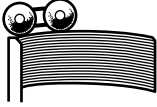
	Right	Wrong
Thin Paper		
Thick Paper		

TPEY990E

Originals

The machine can detect the following original sizes placed on the exposure glass.

Metric version	A3☐, B4☐, A4☐☐, B5☐☐
Inch version	11" × 17"☐, 8 ¹ / ₂ " × 14"☐, 8 ¹ / ₂ " × 11"☐☐

If the machine cannot detect the original sizes properly, select the area to copy with the **[Edge Erase]** key. See p.41 "Edge Erase". The machine may not detect the original size properly when:

- Originals contain index tabs.
- Originals are OHP transparencies or are translucent.
- Originals are dark.
- Originals contain solid images.
- Originals are of sizes other than those listed above.

If you do not lift the exposure glass cover more than 30cm, 12" when you place another original, the machine might not detect the next original size correctly.

The maximum original size you can place on the exposure glass is 304.8 × 432mm, 12" × 17".

If you use originals that have bold letters or solid images at the leading edges, you might get prints with dirty edges. In this case, place the original face down with the widest margin toward the paper delivery tray or raise the printing speed.

Make sure any correction fluid or ink is completely dry before placing originals on the exposure glass. Not taking this precaution could mark the exposure glass and cause marks to be printed.

In most situations, place originals as shown below.

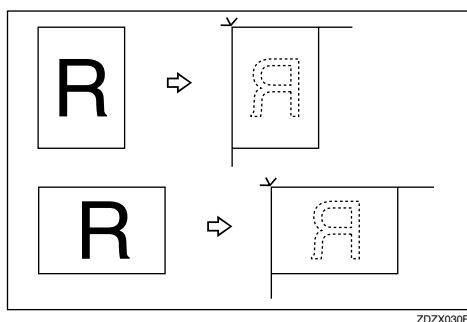

When the original is placed in a direction that differs from the print paper, the machine automatically rotates the original image by 90° to match the print paper direction.

The first 8mm, 0.32", of the leading edge and the last 2mm, 0.08", of the trailing edge cannot be printed. Make sure the leading edge margin is at least 8mm, 0.32", and the trailing edge margin is at least 2mm, 0.08".

1

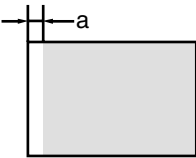
Original	Print
	

$a = 8\text{mm}, 0.32''$

Printing Preparations

Loading Paper

- 1 Carefully open the paper feed tray.

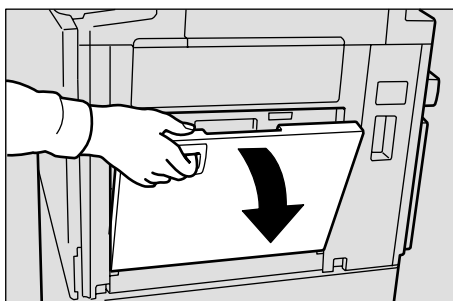

ZDCY130E

- 2 Lift the paper feed side plates.

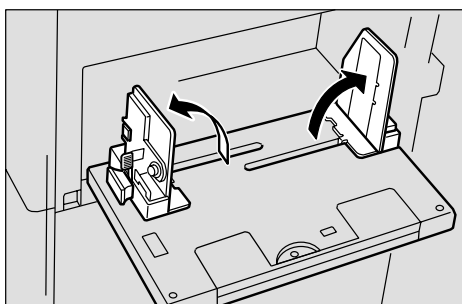

ZDCH050E

 **Note**

- When loading larger paper, slide out the extender.

- 3 Make sure that the paper feed side plates knob lock lever is raised (lock is released), and then grasp the paper feed side plates knob and adjust the paper feed side plates to match the paper size.

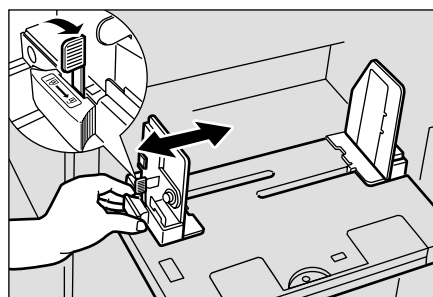

ZDCY01

 **Important**

- Always adjust the position with the lock lever for the paper feed side plates in the raised position (lock released).

- 4 Place the paper on the paper feed tray.

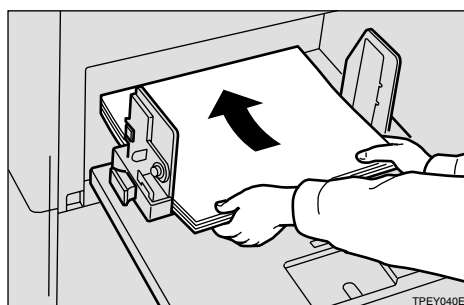

TPEY040E

 **Note**

- Correct the paper curl before loading the paper. If you cannot do so, stack the paper with the curl face down.

 **Reference**

See p.11 "Print Paper".

1

- 5 Make sure that the paper feed side plates are touching both sides of the paper, and then push the lock lever for the side plates down to lock the side plates into position.

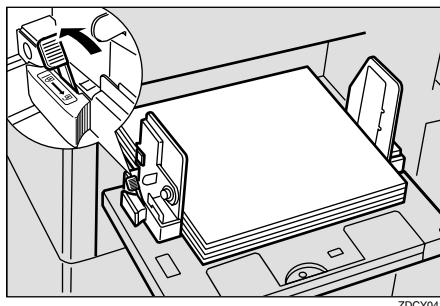

ZDCY04

Important

- Always make sure that you push the lock lever for the side plates down to lock the side plates into position.

Note

- Make sure that the paper size and direction in the panel display correspond with the actual paper size and direction set on the paper feed tray.

Setting Up The Paper Delivery Tray

- 1 Raise the paper delivery tray slightly, and then gently lower it with your hand.

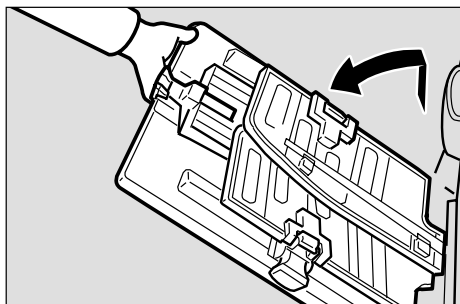

ZBH050E

- 2 Raise each paper delivery side plate, and then grasp the side plate knobs and move the paper delivery side plates to match the print paper size.

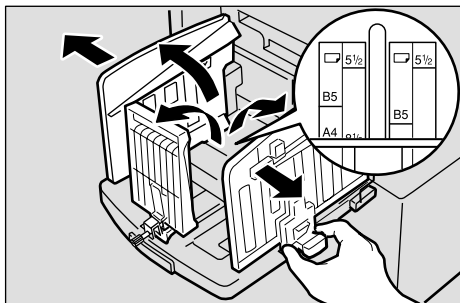

ZDZH180E

Note

- The inside of the plates should correspond to the paper size.

When you use thick paper (128 g/m² to 209.3 g/m², 34 lb to 55.6 lb)

- 1 Adjust the side plates to match the paper size scale on the main frame side.

When you use standard paper (47.1 g/m² to 105 g/m², 12.5 lb to 28 lb)

- 1 Adjust the side plates to match the paper size scale on the end plate side.
- 3 Lower or lift the paper alignment wings by turning the left and right knobs.

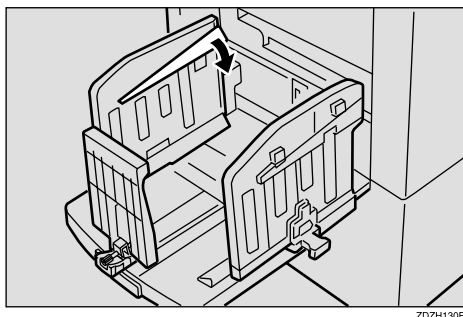

Note

- When the guides are up, you might not be able to load the unit to full capacity (1,000 sheets) depending on the paper you are using.
- Lift the paper alignment wings if B5 prints are curled.

When you use 81.4 g/m², 21.6 lb or thicker paper

- 1 Lower the paper alignment wings.

When you use 81.4 g/m², 21.6 lb or thinner and B5 or smaller paper

- 1 Lower the paper alignment wings.

When you use 81.4 g/m², 21.6 lb or thinner and A4, 8 1/2" × 11" or larger paper

- 1 Lift the paper alignment wings.

When you use A4, 8 1/2" × 11" paper

- 1 Swing out the guides as shown in the illustration.

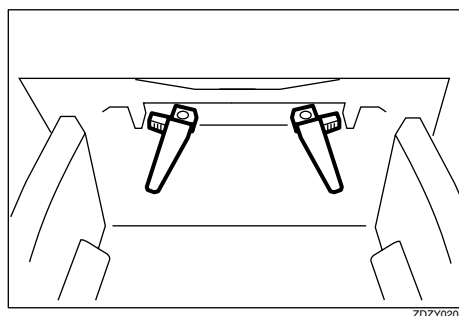

- 4 Turn on the main switch.

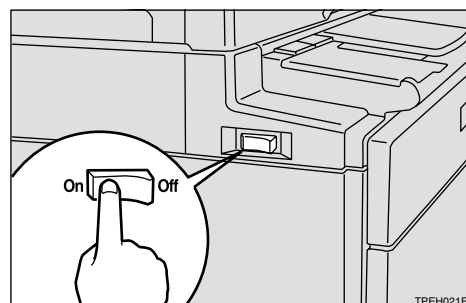

Note

- You can have the machine display how much ink and master are left when you switch it on. See "User Tools—Ink/Master Left" on p.146 "4. Mode Setting".

Entering a User Code to Use the Machine

1

If user codes are turned on, operators must enter their user code before they can use the machine. The machine keeps count of the number of copies made under each user code.

Note

- ❑ If you want to use this feature, you must turn it on and register the user codes with the user tools. You can register up to 20 user codes. See “Set User Code” and “Reg. User Code” on p.153 “6. Administrator Mode”.
- ❑ When user codes are turned on, the machine will prompt you for your user code when you turn on the main switch or after the machine has been reset.

1 Enter your 4–digit user code with the number keys.

Please input user code,
then press # key.
User Code :----

Note

- ❑ User codes are not displayed on the panel display.
- ❑ To change the number entered, press the **[Clear/Stop]** key and enter the new number.

2 Press the **[#]** key.

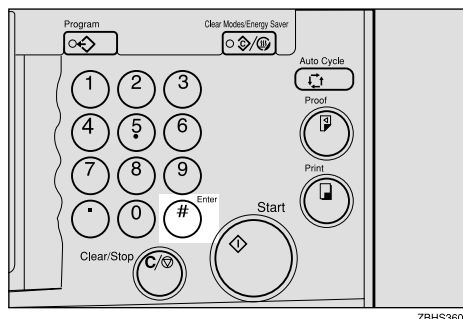

3 Make your prints.

4 To prevent others from making prints with your user code, hold down the **[Clear Modes/Energy Saver]** key, and then press the **[Clear/Stop]** key.

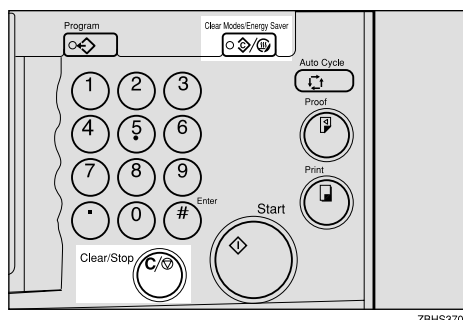

Standard Printing

- 1 Make sure that the machine is ready for printing.

Ready for Master Making/ Printing			
	11x17		0.00in.
Letter	100%	Std.	0.00in.
Original	Ratio	Ppr.Type	Image

- 2 If user codes are turned on, enter your user code with the number keys, and then press the **[#]** key.

Reference

See p.18 "Entering a User Code to Use the Machine".

- 3 Make sure that there are no previous settings remaining.

Note

- To clear any previous settings, press the **[Clear Modes/Energy Saver]** key.

- 4 Lift the exposure glass cover.

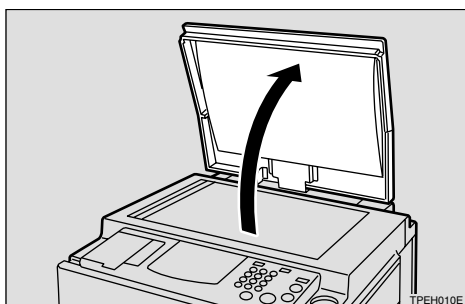

Note

- Be sure to lift the exposure glass cover more than 30cm, 12".

- 5 Place the original face down on the exposure glass. The original should be aligned with the reference mark and the left corner scale.

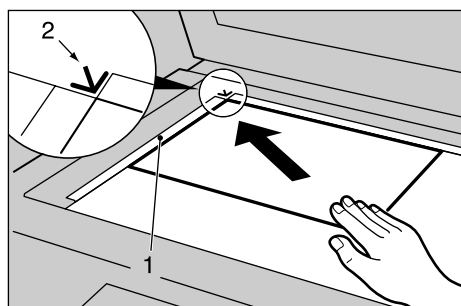

1. Left corner scale
2. Reference mark

- 6 Lower the exposure glass cover.
- 7 Make your desired settings.
- 8 Press the **[Start]** key.

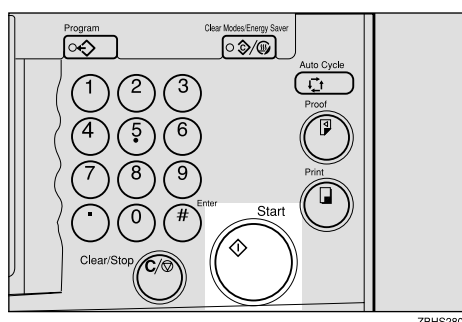

A trial print is delivered to the paper delivery tray.

- 9** Press the **[Proof]** key and check the image density and the image position on the proof print.

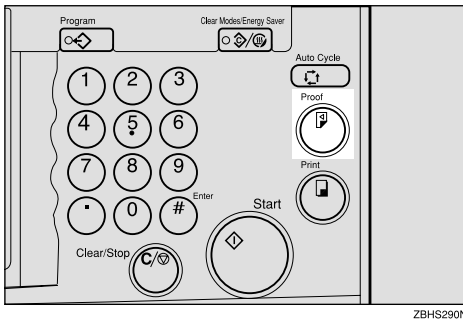

Note

- If the image position is not correct, adjust it using the **[Image ❈]** key. See p.24 "Adjusting the Position of Printed Images".
- If the image density is slightly dark or light, adjust the image density using the **[◀][▶]** keys. See p.25 "Adjusting the Image Density of Prints".

- 10** Enter the number of prints required with the number keys.

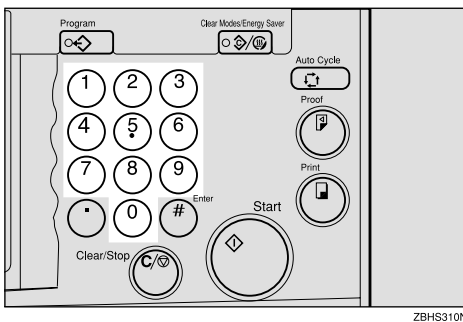

Note

- To change the number entered, press the **[Clear/Stop]** key and enter the new number.

- 11** Press the **[Print]** key.

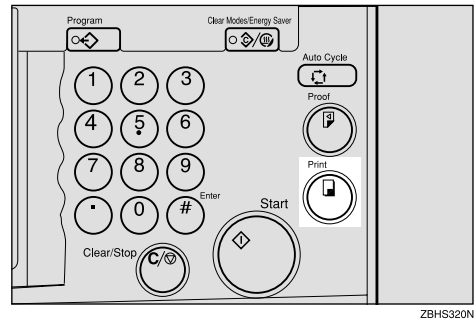

Note

- To stop the machine during a multi-print run, press the **[Clear/Stop]** key.
- To return the machine to the initial condition after printing, press the **[Clear Modes/Energy Saver]** key.

Removing Prints

- 1** Pull the front paper delivery side plate down towards you to open.

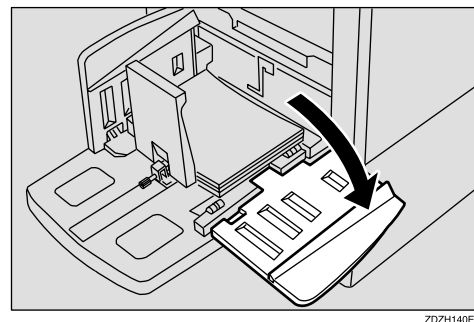

Note

- You cannot open the rear paper delivery side plate.

- 2** Remove the prints from the paper delivery tray and close the paper delivery side plate.

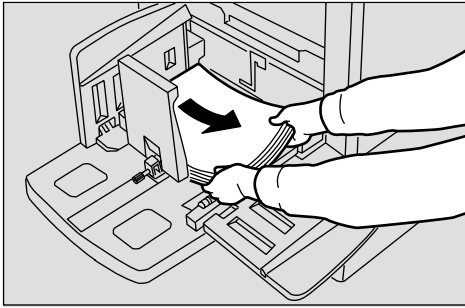

ZDZH150E

Energy Saver Mode

1

If you do not operate the machine for a certain period the machine can enter Idling for pre-printing function to remove ink from inside the ink drum, and then the machine can enter Energy Saver mode to save energy consumption.

You can press the **【Clear Modes/Energy Saver】** key to cancel Energy Saver mode and return the machine to the ready condition.

Idling for pre-printing function helps to reduce excess ink when printing. It reduces recovery time from Energy Saver mode.

Energy Saver mode uses less electricity.

Note

- If you press the **【Clear Modes/Energy Saver】** key for more than three seconds, the machine will enter Idling for pre-printing function, and then it will enter Energy Saver mode.
- You can change the setting so that the machine does not enter Idling for pre-printing function. See “Setting Q.start” on p.146 “4. Mode Setting”.
- Idling for pre-printing function lasts for a few seconds.
- You can change the time the machine waits before Energy Saver mode starts. See “Energy Saving” on p.143 “1. System”.
- The machine will not automatically enter Energy Saver mode in the following cases:
 - If there is no ink
 - If originals or paper are jammed
 - If the machine is making master or printing
 - If the machine is printing the second page of a combined print job
 - If the machine is loading original images in memory
 - If there is no paper
 - If there is no master
 - If the paper delivery box is full
 - If originals are left on the document feeder
 - If there are originals still on the machine
 - If the “cover open” message is displayed
 - If the settings have been reset to their defaults
 - If there are prints in the sorter's paper delivery tray
 - If the User Code entry screen is displayed

Auto Reset

If you do not operate the machine for a certain period after printing, the machine will return to the initial condition. This function is called "Auto Reset".

Note

- You can change the time the machine waits before Auto Reset starts. See "Auto Reset" on p.143 "1. System".
- The machine will not enter Auto Reset in the following cases:
 - If there is no ink
 - If originals or paper are jammed
 - If the machine is making master or printing
 - If the machine is printing the second page of a combined print job
 - If the machine is loading original images in memory
 - If there is no paper
 - If there is no master
 - If the paper delivery box is full
 - If originals are left on the document feeder
 - If the "cover open" message is displayed
 - If the settings have been reset to their defaults
 - If you select "Off" for "Auto Reset" with the user tools

Adjusting the Position of Printed Images

1

Use the following procedure to adjust the position of print images as required.

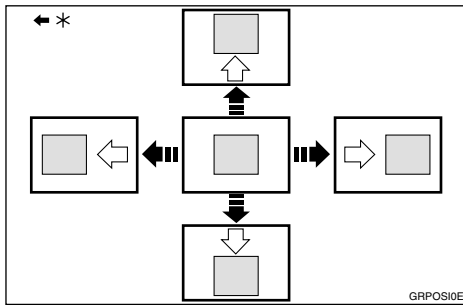

* Paper feed direction

Limitation

- For 308 mm, 12.2"-width paper, you can only adjust the position of the print image 5 mm, 0.2" up or down.

Note

- When the main switch is turned off, the position returns to the default.

1 Press the [Image ⚙️] key.

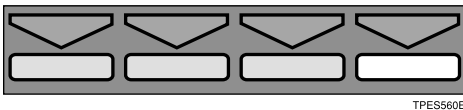

Note

- You can skip step 1 and adjust the image position directly by pressing the [◀], [▶], [▲], and [▼] keys.

2 Adjust image position using the [◀], [▶], [▲], and [▼] keys.

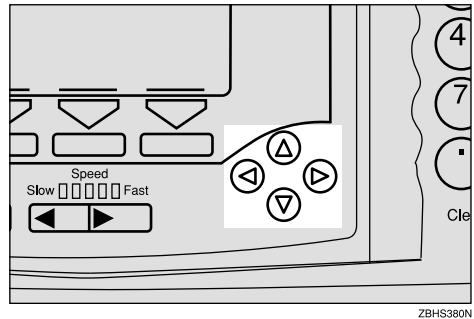

Note

- When you shift the image forward, leave a 10mm, 0.4" margin at the leading edge. If there is no margin, paper might wrap around the drum and cause a misfeed.
- The [◀] and [▶] keys shift the image up to 15mm, 0.6" each way in 0.5mm, 0.02" steps.
- The [▲] and [▼] keys shift the image up to 10mm, 0.4" each way in 0.5mm, 0.02" steps.

3 Press the [OK] key.

4 Press the [Proof] key to check the image position.

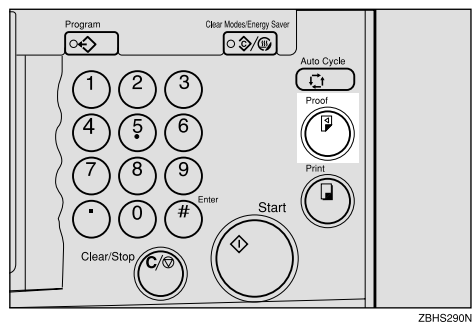

Adjusting the Image Density of Prints

There are two ways to adjust the image density of prints:

- ❖ **Before making a master**
Use the **[Image Density]** key.
- ❖ **After making a master**
Use the **[◀][▶]** (Speed) keys.

Before Making a Master

- 1** Press the **[Image Density]** key to adjust the image density.

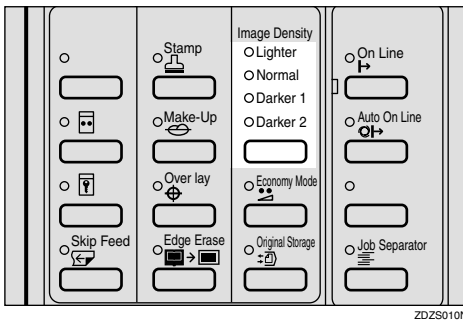

ZDZS010N

- 2** Press the **[Start]** key.

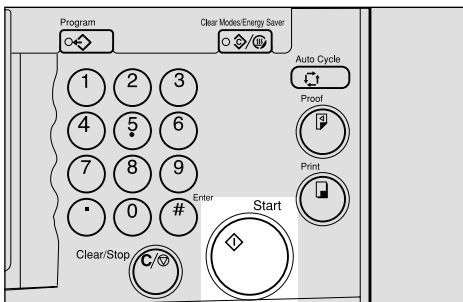

ZBHS280N

After Making a Master

- 1** To increase the image density, press the **[◀]** key. To reduce the image density, press the **[▶]** key.

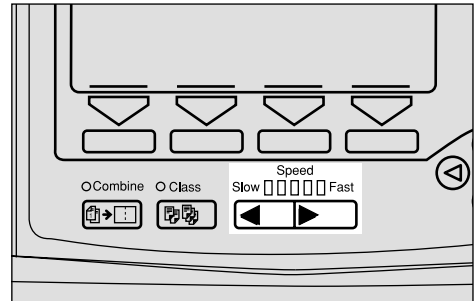

ZBHS300N

Note

- ❑ The faster the printing speed becomes, the lighter the printing density is. If you want darker prints, decrease the printing speed.

Tint Mode

Use this function to make halftone prints.

1

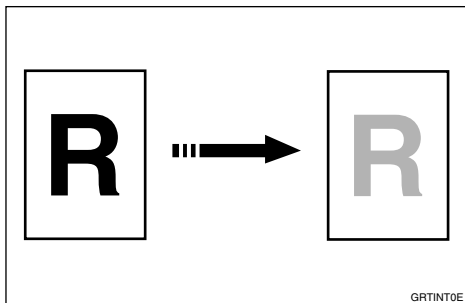

1 Press the [Original] key.

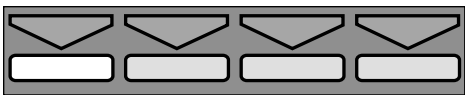
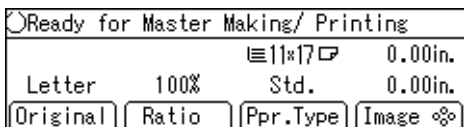

TPES50E

2 Select the [Tint] with the [←] [→] or [◀] [▶] keys.

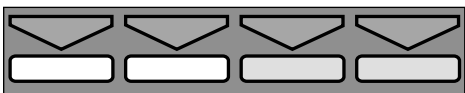

TPES50E

3 Press the [Start] key.

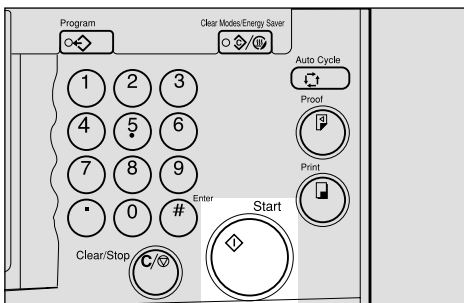

ZBHS280N

Changing the Printing Speed

Use the [◀] or [▶] key to adjust the printing speed. The relationship between printing speed and print quality depends on the type of paper you use.

- 1 Press the [▶] key to increase the speed and press the [◀] key to reduce the speed.

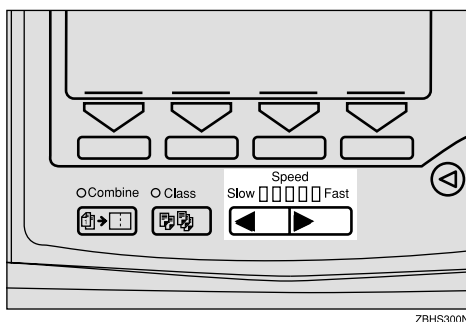

Note

- ❑ The following speeds are available:
 - Setting 1:
60 sheets/minute
 - Setting 2:
75 sheets/minute
 - Setting 3 (default):
90 sheets/minute
 - Setting 4:
105 sheets/minute
 - Setting 5:
120 sheets/minute
- ❑ The faster the printing speed becomes, the lighter the printing density is, and vice versa.
- ❑ When the machine is used in low temperature conditions, the image density might decrease. In this case, slow the printing speed down to setting 1 or 2.

Stopping a Multi-print Run

1

Stopping a Multi-print Run to Print Another Original

1 Press the **[Clear/Stop]** key.

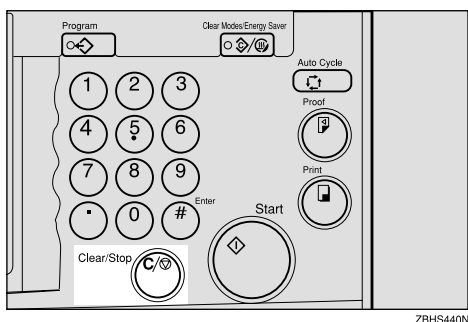

2 Set the original.

3 Enter the number of prints and press the **[Start]** key.

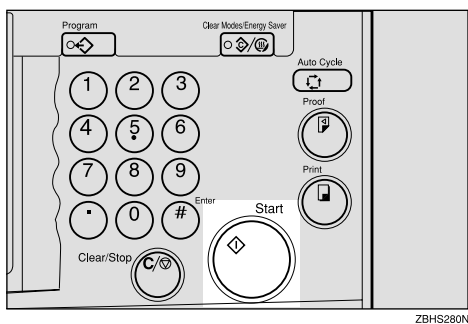

Changing the Number of Prints Entered and Checking Completed Prints

1 Press the **[Clear/Stop]** key.

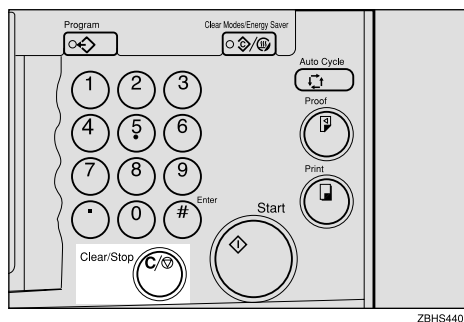

2 Change the number of prints or check the completed prints.

Note

- To change the number of prints, press the **[Clear/Stop]** key, and then re-enter the number of prints with the number keys.

3 Press the **[Print]** key.

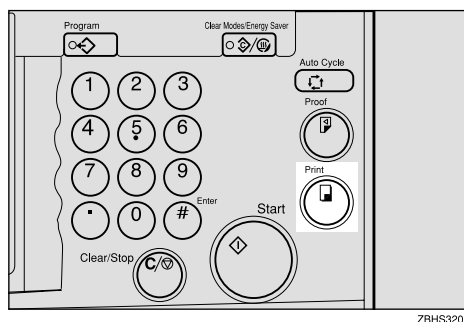

Reducing and Enlarging Using Preset Ratios

Use this function to have originals reduced or enlarged by a preset ratio. A total of 7 ratios are available (3 enlargement ratios, 4 reduction ratios).

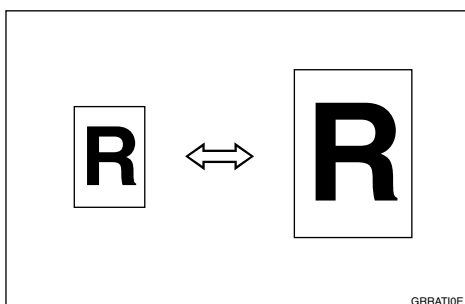

Note

- The leading edge of the print image does not shift when a print image is made with this function.

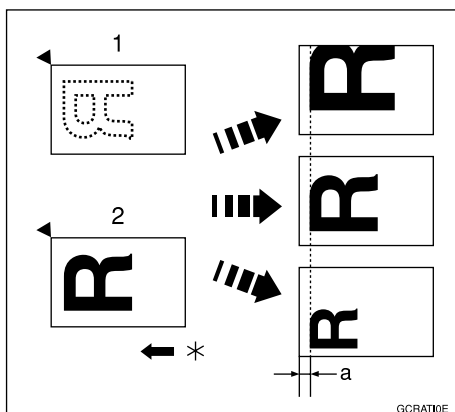

- Place on the exposure glass
- Place in the optional document feeder

* Paper feed direction

a = 8mm, 0.32"

- You can select a ratio regardless of the size of an original or printing paper. With some ratios, parts of the image might not be printed or margins will appear on prints.
- You can change the preset reproduction ratios with the user tools. See "Reproduction Ratio" on p.156 "3-4 Reproduction Ratio".
- Prints can be reduced or enlarged as follows.

◆ Metric version

Ratio (%)	Original → Print paper size
141	A4 → A3, A5 → A4, B5 → B4
122	A4 → B4, A5 → B5
115	B4 → A3, B5 → A4
93	—
87	A3 → B4, A4 → B5
82	B4 → A4, B5 → A5
71	A3 → A4, A4 → A5, B4 → B5

◆ Inch version

Ratio (%)	Original → Print paper size
155	5 1/2" × 8 1/2" → 8 1/2" × 14"
129	8 1/2" × 11" → 11" × 17", 5 1/2" × 8 1/2" → 8 1/2" × 11"
121	8 1/2" × 14" → 11" × 17"
93	—
77	8 1/2" × 14" → 8 1/2" × 11"
74	11" × 15" → 8 1/2" × 11"
65	11" × 17" → 8 1/2" × 11", 8 1/2" × 11" → 5 1/2" × 8 1/2"

1 Press the [Ratio] key.

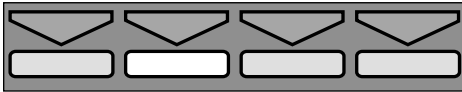

TPES570E

2 Select the desired ratio with the [←] [→] or [◀] [▶] keys.

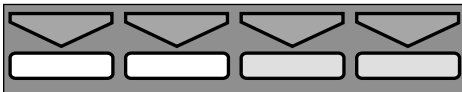
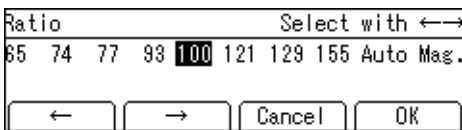

TPES530E

3 Press the [OK] key.

4 Make sure that the original and the print paper are the correct size.

5 Place your original on the exposure glass or in the optional document feeder.

6 Press the [Start] key.

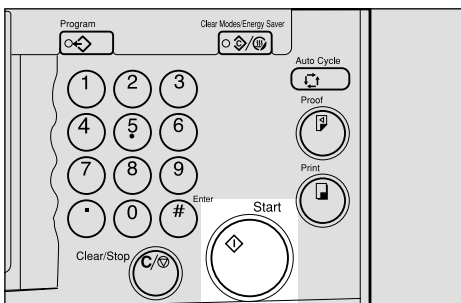

ZBHS280N

7 Check the image position on the trial or proof print.

Note

- If the image position is not correct, adjust it using the [Image] key. See p.24 “Adjusting the Position of Printed Images”.

8 Make your prints.

Auto Magnification

Use this function to have the machine choose an appropriate enlargement or reduction ratio based on the size of your original and the paper size you select.

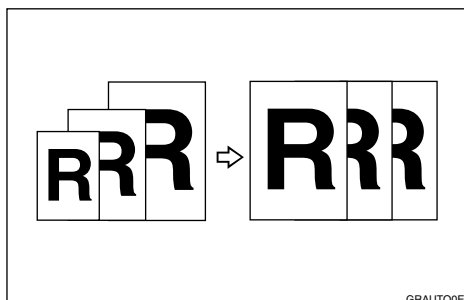

Note

- The range of ratios which the machine can select depends on where you place the original:
 - On the exposure glass: 50 – 200%
- The table below shows the reproduction ratios that can be selected for various combinations of original and paper size.

◆ Metric version

Original Paper	A3☐	B4☐	A4☐	A4☒	B5☐	B5☒	A5☐ *2	A5☒ *2
A3☐	100%	115%	141%	--	163%	--	200%	--
B4☐	87%	100%	122%	--	141%	--	173%	--
A4☐	71%	82%	100%	100% *1	115%	115% *1	141%	141% *1
A4☒	71% *1	82% *1	100% *1	100%	115% *1	115%	141% *1	141%
B5☐	61%	71%	87%	87% *1	100%	100% *1	122%	122% *1
B5☒	61% *1	71% *1	87% *1	87%	100% *1	100%	122% *1	122%
A5☐	50%	50%	71%	71% *1	82%	82% *1	100%	100% *1
B6☐	--	50%	61%	61% *1	71%	71% *1	87%	87% *1

*1 The machine automatically rotates the original image by 90° to match the paper direction and selects an appropriate reproduction ratio. See p.85 "Image Rotation".

*2 Place these originals in the optional document feeder.

❖ Inch version

Original Paper	11" × 17"	8 1/2" × 14"	8 1/2" × 11"	8 1/2" × 11"	8 1/2" × 5 1/2" *2	8 1/2" × 5 1/2" *2
11" × 17"	100%	121%	129%	--	200%	--
8 1/2" × 14"	77%	100%	--	--	155%	--
8 1/2" × 11"	65%	77%	100%	100% *1	129%	129% *1
8 1/2" × 11"	65% *1	77% *1	100% *1	100%	129% *1	129%
8 1/2" × 5 1/2"	50%	61%	65%	65% *1	100%	100% *1

*1 The machine automatically rotates the original image by 90° to match the paper direction and selects an appropriate reproduction ratio. See p.85 "Image Rotation".

*2 Place these originals in the optional document feeder.

- Depending on the original type, a suitable reproduction ratio might not be able to be selected. See p.13 "Originals" and see p.127 "Originals".

1 Place your original on the exposure glass or in the optional document feeder.

2 Press the [Ratio] key.

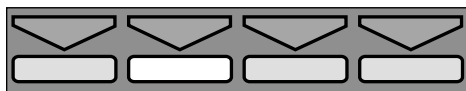

TPES570E

3 Select [Auto] with the [→] or [▷] key.

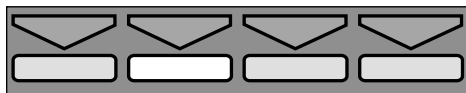
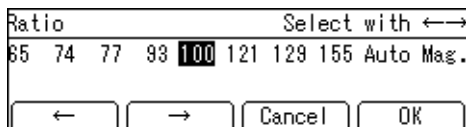

TPES570E

4 Press the [OK] key.

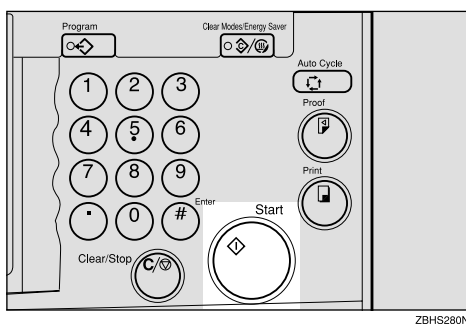
5 Press the **[Start]** key.**6** Check the image position on the trial or proof print. **Note**

- If the image position is not correct, adjust it using the **[Image ⚙️]** keys. See p.24 "Adjusting the Position of Printed Images".

7 Make your prints.

Zoom

1

Use this function to fine-tune the reproduction ratio in increments of 1%.

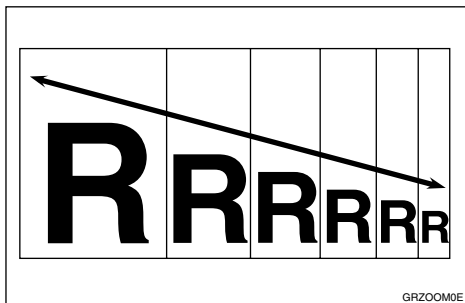

Note

- The range of ratios you can select depends on where you place the original:
 - On the exposure glass: 50–200%

1 Press the [Ratio] key.

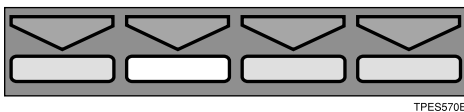

2 Select [Mag.] with the [→] or [▷] key.

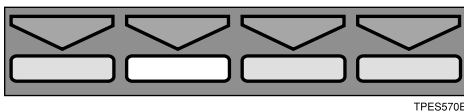
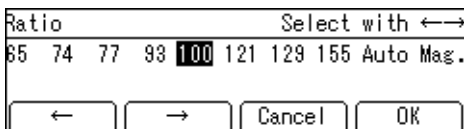

Note

- To select a custom ratio, select the closest ratio with the [←] [→] or [◀] [▶] keys. Then press the [▲] or [▼] key and go to step 6.

3 Press the [OK] key.

4 Make sure that [Zoom] is selected.

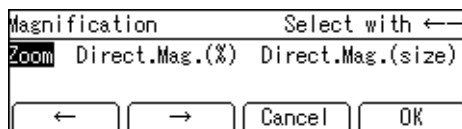

5 Press the [OK] key.

6 Select the desired reproduction ratio in one of the following ways:

Note

- To change the value entered, press the [Clear/Stop] key and enter the new value.

Using the [←] [→] or [◀] [▶] keys

1 Adjust the ratio with the [←] [→] or [◀] [▶] keys.

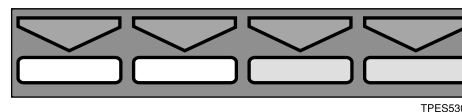
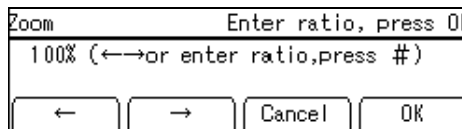

Using the number keys

- 1 Enter the ratio with the number keys.

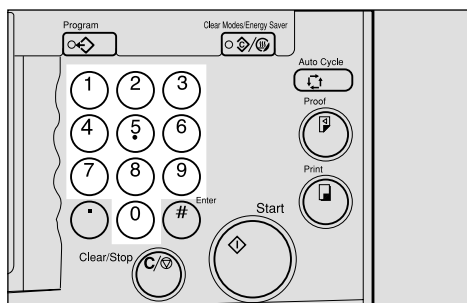

ZBHS310N

- 2 Press the [#] key.

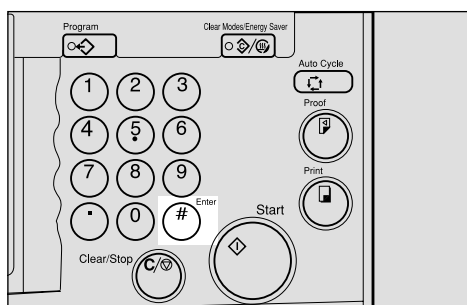

ZBHS360N

- 7 Press the [OK] key.
- 8 Make sure that the original and the print paper are the correct size.
- 9 Place your original on the exposure glass or in the optional document feeder.
- 10 Press the [Start] key.

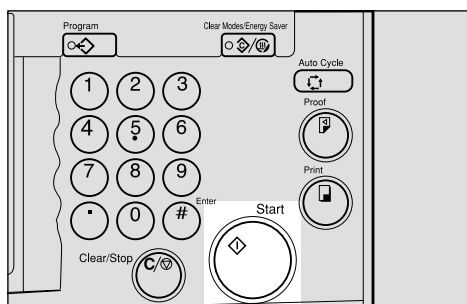

ZBHS280N

- 11 Check the image position on the trial or proof print.

Note

- If the image position is not correct, adjust it using the [Image] key. See p.24 “Adjusting the Position of Printed Images”.

- 12 Make your prints.

1

Directional Magnification (%)

1

Use this function to choose different reproduction ratios for the horizontal and vertical directions. The result is a squeezing or stretching effect.

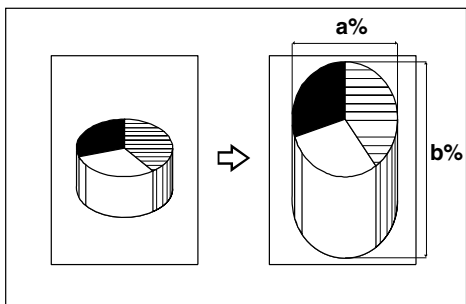

CP2P01EE

Note

The range of ratios you can select depends on where you place the original:

- On the exposure glass: 50 – 200%

1 Press the [Ratio] key.

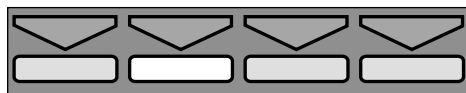

TPES570E

2 Select [Mag.] with the [→] or [▷] key.

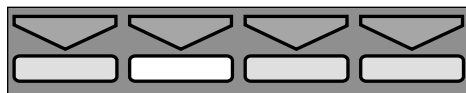
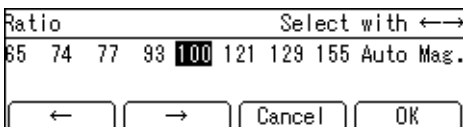

TPES570E

3 Press the [OK] key.

4 Select [Direct.Mag.(%)] with the [→] or [▷] key.

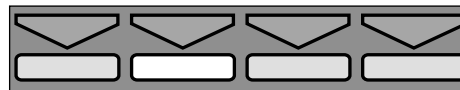
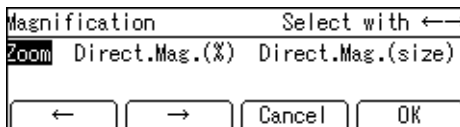

TPES570E

5 Press the [OK] key.

6 Enter the vertical and horizontal ratio.

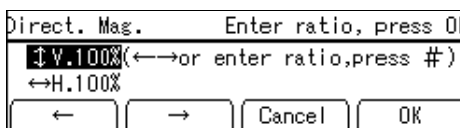

Note

To change the value entered, press the [Clear/Stop] key and enter the new value.

Adjusting ratios with the [←] [→] or [◀] [▶] keys

- 1 Adjust the vertical ratio with the [←] [→] or [◀] [▶] keys.
- 2 Press the [▽] key.
- 3 Adjust the horizontal ratio with the [←] [→] or [◀] [▶] keys.

Entering ratios with the number keys

- 1 Enter the vertical ratio with the number keys.
- 2 Press the [#] key.

- 3 Enter the horizontal ratio with the number keys.
- 4 Press the [#] key.
- 7 Press the [OK] key.
- 8 Make sure that the original and the print paper are the correct size.
- 9 Place your original on the exposure glass or in the optional document feeder.
- 10 Press the [Start] key.

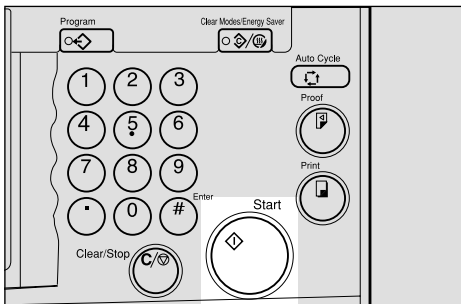

- 11 Check the image position on the trial or proof print.

 **Note**

- If the image position is not correct, adjust it using the [Image ⌘] key. See p.24 "Adjusting the Position of Printed Images".

- 12 Make your prints.

Directional Magnification (Size)

1

Use this function to have the machine select suitable reproduction ratios based upon the dimensions of the print you require and the size of the original you specify.

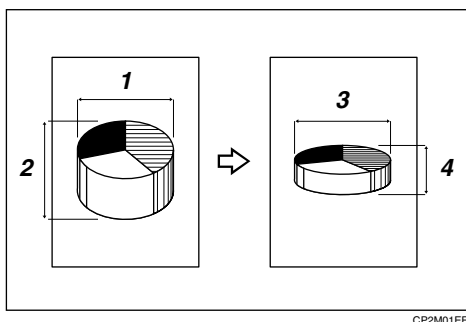

1. Horizontal original size
2. Vertical original size
3. Horizontal print size
4. Vertical print size

Note

You can enter sizes within the following ranges.

Metric version	1 - 999mm (in 1mm steps)
Inch version	0.1" - 99.9" (in 0.1" steps)

- The range of ratios which the machine can select depends on where you place the original:
 - On the exposure glass: 50-200%
- If the calculated ratio is over the maximum or under the minimum ratio, it is corrected within the range of ratios automatically.

1 Press the [Ratio] key.

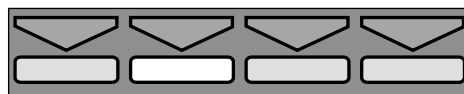
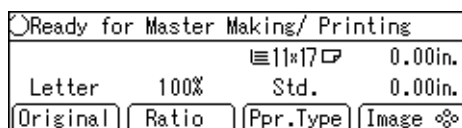

2 Select [Mag.] with the [→] or [▷] key.

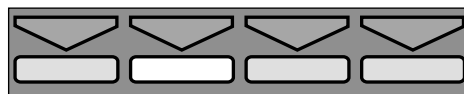
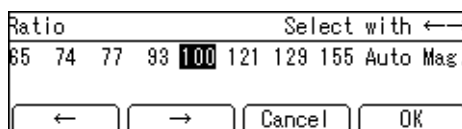

3 Press the [OK] key.

4 Select [Direct.Mag.(Size)] with the [→] or [▷] key.

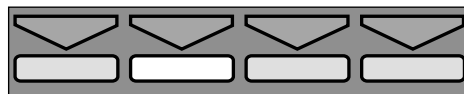
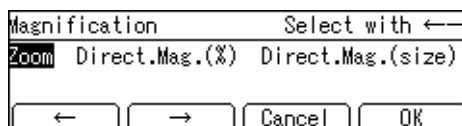

5 Press the [OK] key.

- 6** Enter the vertical original size with the number keys and press the **[#]** key.

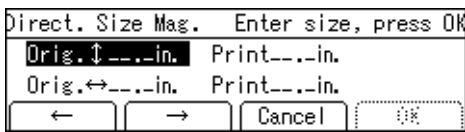

Note

- To change the value entered, press the **[Clear/Stop]** key and enter the new value.
- Up to 999mm, 99.9" can be entered.

- 7** Enter the vertical print size with the number keys, and then press the **[#]** key.

- 8** Enter the horizontal original size with the number keys, and then press the **[#]** key.

- 9** Enter the horizontal print size with the number keys.

- 10** Press the **[OK]** key.

The machine will select appropriate reproduction ratios for the vertical and horizontal directions.

- 11** Make sure that the original and the print paper are the correct size.

- 12** Place your original on the exposure glass or in the optional document feeder.

- 13** Press the **[Start]** key.

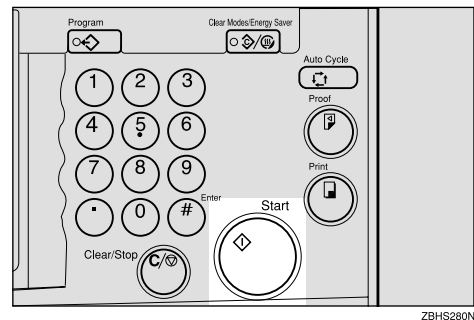

- 14** Check the image position on the trial or proof print.

Note

- If the image position is not correct, adjust it using the **[Image ⌘]** key. See p.24 "Adjusting the Position of Printed Images".

- 15** Make your prints.

Erasing Center and Edge Margins

1

When printing from thick books, or similar originals, the binding margin at the center and the edges might appear on prints. To prevent this, perform the following steps.

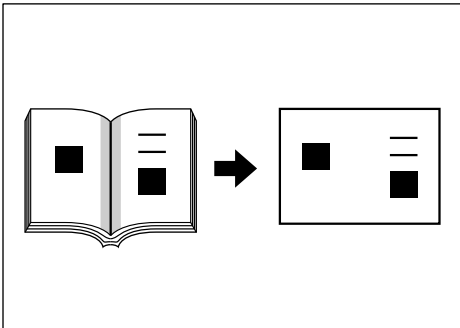

GBCER0E

Important

- Be sure to keep the platen cover at an angle of at least 25 degrees with the exposure glass.
- If you do not press hard on the book while it is scanned, the margin at the center might not be erased completely.

Note

- If your originals have solid images at the edges, the machine might recognize the solid images as shadows and not copy them. In this case, use Edge Erase mode so that only the shadows are not copied. See p.41 "Edge Erase".

- 1** Set the book on the exposure glass.

- 2** Keep the exposure glass cover at an angle of at least 25 degrees with the exposure glass.

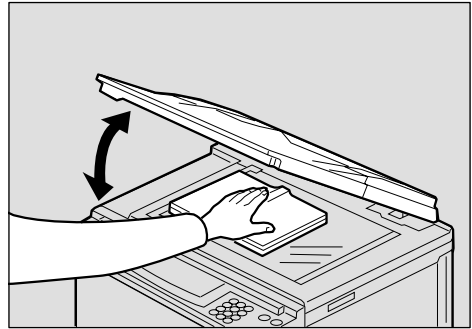

ZADH240E

- 3** Press the **[Start]** key.

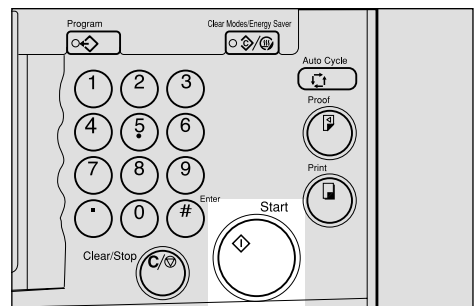

ZBHS280N

Note

- Press hard on the book with your hand while it is scanned.

- 4** Check the image position on the trial or proof print.

Note

- If the image position is not correct, adjust it using the **[Image ⌘]** key. See p.24 "Adjusting the Position of Printed Images".

- 5** Make your prints.

Edge Erase

This function erases all four margins of the original image.

❖ Using Edge Erase mode

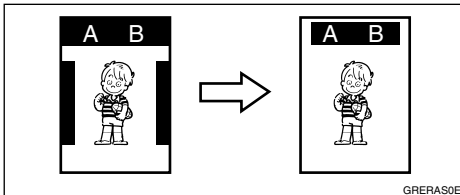

❖ When not using Edge Erase mode

When printing from thick books, or similar originals, the binding margin at the center and the edges might appear on prints. The machine erases these margins automatically. If you do not use Edge Erase mode using the following kind of originals, the images to be printed might be also erased.

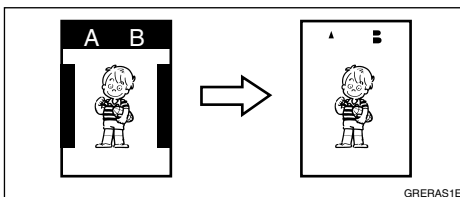

Note

- ❑ You can adjust the size of the margins with the user tools. The default is 2mm, 0.1". See p.158 "3-11 Margin Erase Area".

1 Press the **[Edge Erase]** key.

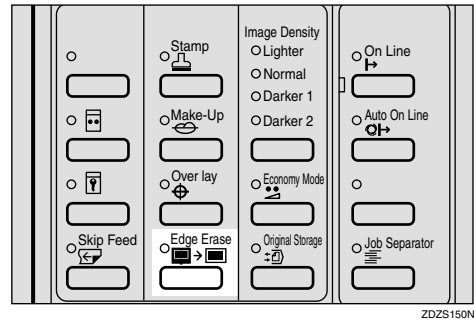

2 Select the size and direction of the original with the **[←]** **[→]** or **[<]** **[>]** keys.

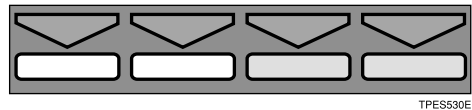
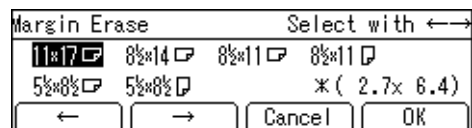

3 Press the **[OK]** key.

4 Place your original on the exposure glass or in the optional document feeder.

5 Press the **[Start]** key.

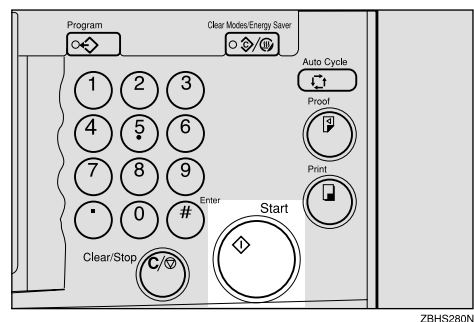

6 Check the image position on the trial or proof print.

 **Note**

- If the image position is not correct, adjust it using the **[Image ⌘]** key. See p.24 "Adjusting the Position of Printed Images".

7 Make your prints.

Printing onto Various Kinds of Paper

Before printing onto thick paper, thin paper, envelopes or special kinds of paper loaded in the paper feed tray, you must select the paper type.

Printing onto Thick Paper

If you wish to print onto thick (128 to 209.3g/m², 34 to 55.6 lb or heavier) paper, perform the following steps.

1 Press the [Ppr.Type] key.

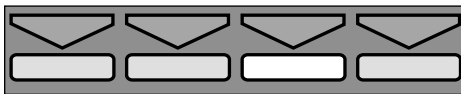
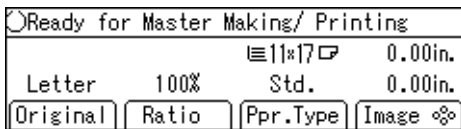

TPES520E

2 Select [Thick] with the [→] or [▷] key.

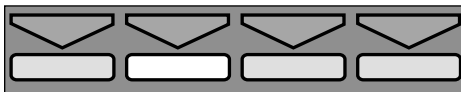
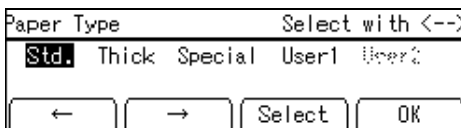

TPES570E

3 Press the [OK] key.

Printing onto Standard Paper

If you wish to print onto standard (47.1 to 105g/m², 12.5 to 28 lb) paper, perform the following steps.

1 Press the [Ppr.Type] key.

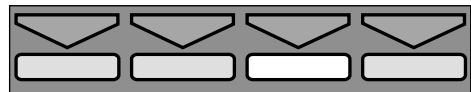
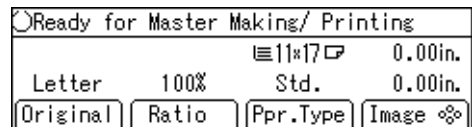

TPES520E

2 Make sure that [Std.] is selected.

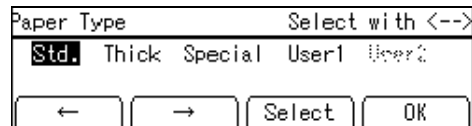

3 Press the [OK] key.

Printing onto Envelopes

1 Press the [Ppr.Type] key.

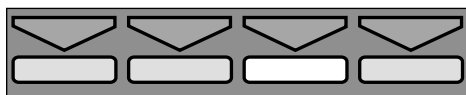
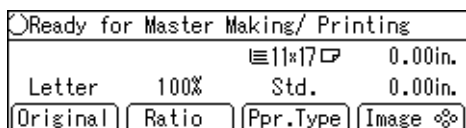

TPES520E

2 Select [Special] with the [→] or [▷] key.

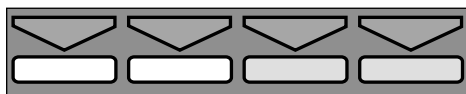
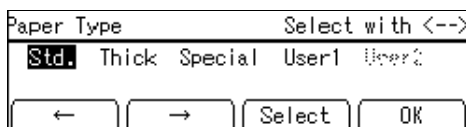

TPES530E

3 Press the [OK] key.

4 Place the envelopes in the paper feed tray as shown in the illustration.

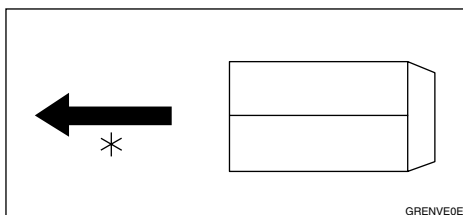

GRENV60E

* Paper feed direction

Note

- When you use envelopes, the paper feed tray capacity is about 150 sheets (85g/m², 22 lb) or enough to load a stack up to 105mm, 4.1" high.

5 If your envelopes do not feed in well, lift the paper feed tray a little, and then lower it so that it slants up slightly.

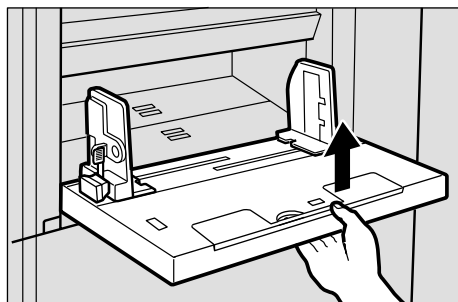

ZDZY030E

Printing onto Special Kinds of Paper

Preparation

To use this function, you have to register the special paper type in [User1] or [User2] with the user tools. See p.161 "4-19 Type of Paper".

1 Press the [Ppr.Type] key.

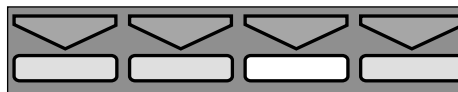
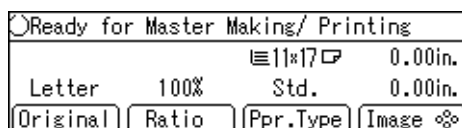

TPES520E

2 Select [User1] or [User2] with the [←] [→] or [◀] [▶] keys.

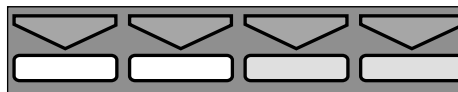
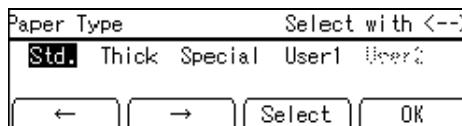

TPES30E

3 Press the [OK] key.

To prevent paper misfeeds:

If paper misfeeds occur frequently, even if you have selected a suitable paper, follow the steps below.

- ① Press the **[Select]** key.

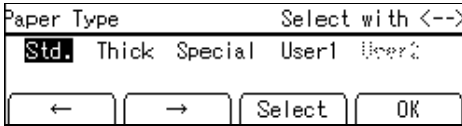

- ② Select the type of paper misfeed and frequency with the **[◀]**, **[▶]**, **[▲]**, or **[▼]** keys.

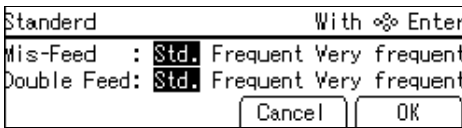

- ③ Press the **[OK]** key.

If paper misfeeds occur frequently in the paper exit section, even if you are using standard or thin paper and have selected **[Std.]**, do the following:

- ① Set the wing guide to the “Down” position with the user tools. See “Deflector Angle” on p.146 “4. Mode Setting”.

If A4 – B5, 8¹/₂" × 11" thick paper is not delivered properly to the paper delivery tray, do the following:

- ① Set the wing guide to the “Up” position with the user tools. See “Deflector Angle” on p.146 “4. Mode Setting”.



Selecting Original Modes

1

Select one of the following five modes to match your originals:

- ❖ **Letter mode**
Select when originals contain only letters (no pictures).
- ❖ **Letter/Photo mode**
Select when originals contain photographs or pictures with letters.
- ❖ **Photo mode**
Select when originals contain photographs or pictures with delicate tones.
- ❖ **Pencil mode**
Select when originals are written in pencil.
- ❖ **Tint mode**
Select when you want to make halftone printing.

 **Note**

- ❑ You can adjust the sharpness of text in Letter mode with the user tools. See “Adjusting sharpness of letters” on p.146 “4. Mode Setting”.
- ❑ When using Photo mode to print originals with both text and photographs, the text will appear lighter. To avoid this, select Letter/Photo mode. Alternatively, use the optional Make-up mode to specify Letter mode for text areas and Photo mode for photograph areas.

Letter/Photo Mode Printing

 **Preparation**

You can adjust the contrast of the image.

1 Press the **[Original]** key.

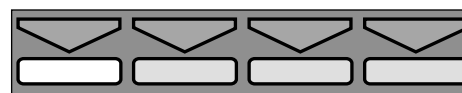

TPES50E

2 Select **[Letter/Photo]** with the **[→]** or **[▷]** key.

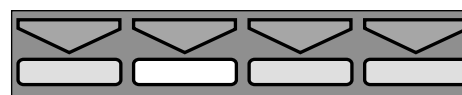

TPES570E

3 Press the **[Contrast]** key.

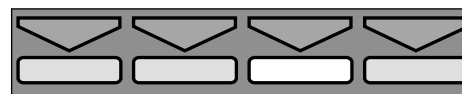

TPES520E

- 4** Adjust the contrast with the [←] [→] or [◀] [▶] keys.

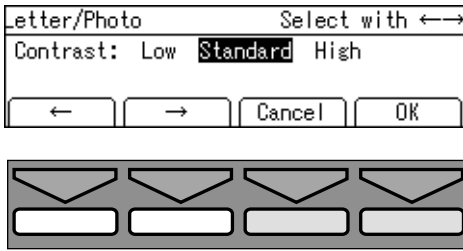

Note

- Use "High" to produce clear prints of people's faces.
- Use "Low" to produce clear prints of landscapes and scenery etc.

- 5** Press the [OK] key.
- 6** Place your original on the exposure glass or in the optional document feeder.
- 7** Press the [Start] key.

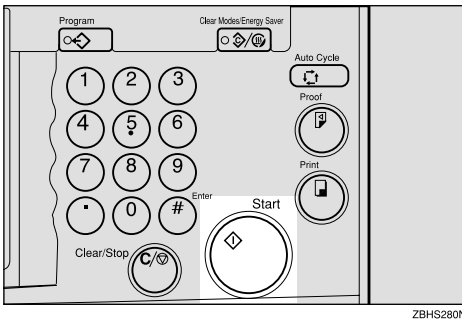

- 8** Check the image position on the trial or proof print.

Note

- If the image position is not correct, adjust it using the [Image ⚙️] key. See p.24 "Adjusting the Position of Printed Images".

- 9** Make your prints.

Photo Mode Printing

- 1** Press the [Original] key.

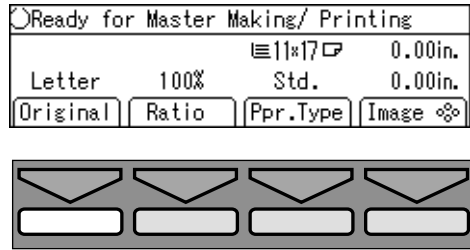

- 2** Select [Photo] with the [→] or [▶] key.

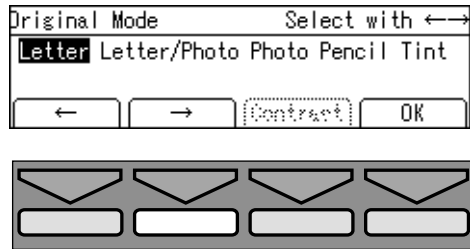

- 3** Press the [OK] key.

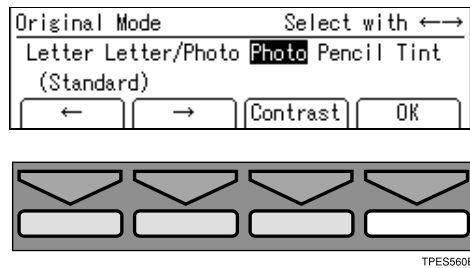

Adjusting the photo mode contrast

- 1** Press the [Contrast] key.

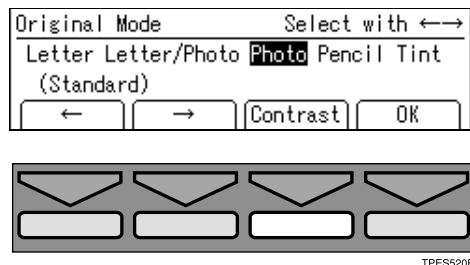

1

2 Adjust the contrast with the [←][→] or [◀][▶] keys.

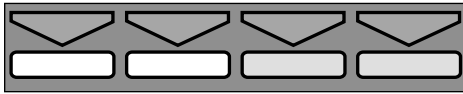
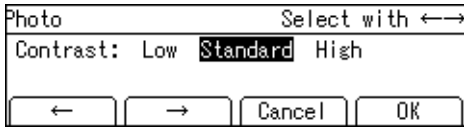

TPES530E

3 Press the [OK] key.

Note

- Use "High" to produce clear prints of people's faces.
- Use "Low" to produce clear prints of landscapes and scenery etc.

4 Select the dot pattern with the [←][→] or [◀][▶] keys.

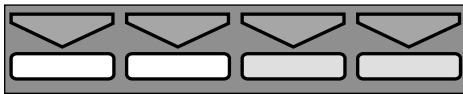
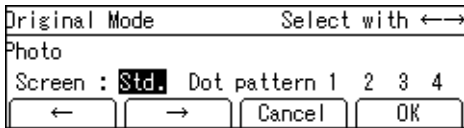

TPES530E

Note

- Four dot patterns are available:
 - Setting 1: clearest
 - Setting 2: clearer than setting 3
 - Setting 3: clearer than setting 4
 - Setting 4: clearer than the standard setting

5 Press the [OK] key.

6 Place your original on the exposure glass or in the optional document feeder.

7 Press the [Start] key.

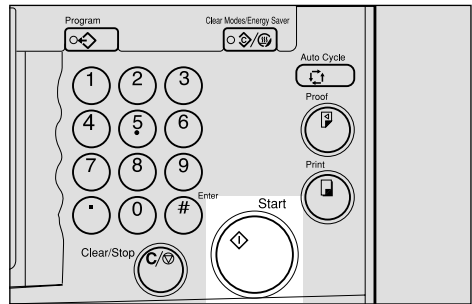

ZBHS280N

8 Check the image position on the trial or proof print.

Note

- If the image position is not correct, adjust it using the [Image] key. See p.24 "Adjusting the Position of Printed Images".

9 Make your prints.

Pencil Mode Printing

Note

- Originals written in pencil should be placed on the exposure glass.

1 Press the [Original] key.

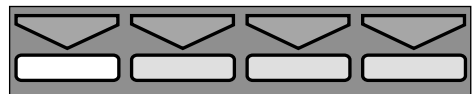
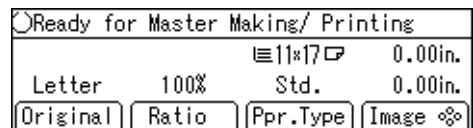

TPES550E

- 2** Select [Pencil] with the [→] or [▷] key.

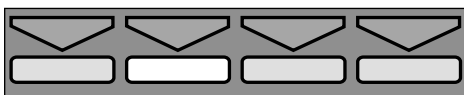

TPES570E

- 3** Press the [OK] key.
- 4** Place your original on the exposure glass.
- 5** Press the [Start] key.

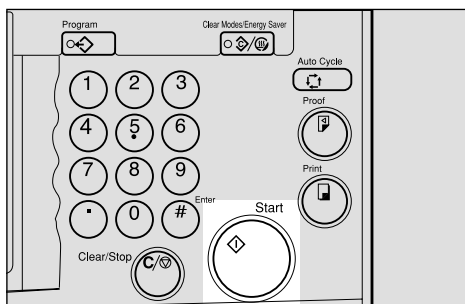

ZBHS280N

- 6** Check the image position on the trial or proof print.

Note

- If the image position is not correct, adjust it using the [Image ❖] key. See p.24 "Adjusting the Position of Printed Images".

- 7** Make your prints.

Economy Mode

When you want to save ink, select Economy mode.

1

Note

Prints will be lighter in this mode.

1 Press the **[Economy Mode]** key.

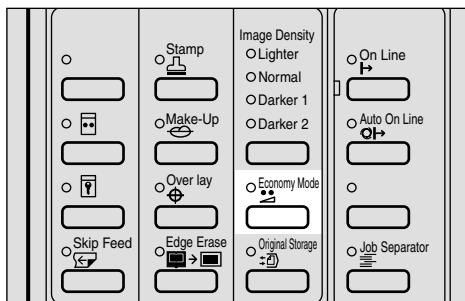

ZDZS020N

2 Place your original on the exposure glass or in the optional document feeder.

3 Press the **[Start]** key.

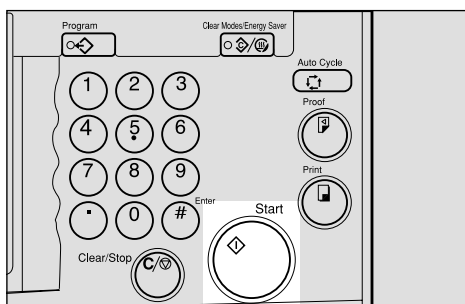

ZBHS280N

4 Check the image position on the trial or proof print.

Note

If the image position is not correct, adjust it using the **[Image ⚙]** key. See p.24 "Adjusting the Position of Printed Images".

5 Make your prints.

Auto Cycle

Use the **[Auto Cycle]** key to process masters and make prints in a single operation.

- 1** If the indicator of **[Auto Cycle]** key is off, press the **[Auto Cycle]** key.

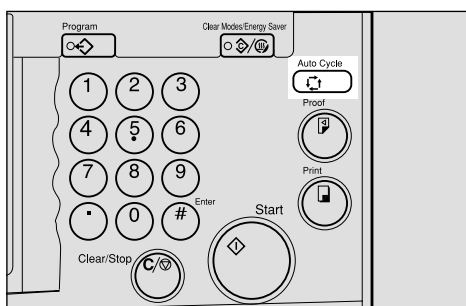

ZBHS490N

- 2** Press the **[Start]** key.

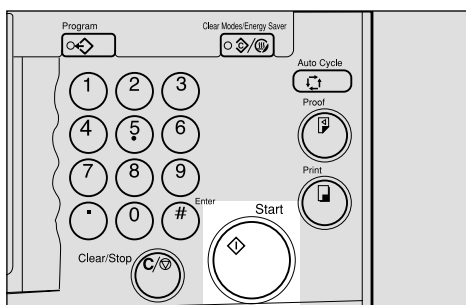

ZBHS280N

All Class Mode

Preparation

You have to store the number of students in each class with the user tools. See p.157 "3-5 Class Enter No."

Use the **[Class]** key to make sets of prints from the same original. All the stored numbers of prints are made for each set.

This feature is useful for teachers who frequently make multiple print sets for classes e.g. notes, handouts, tests etc.

Using a standard print mode, the teacher would have to stand by the machine entering the number of prints and pressing the **[Print]** key for each class. However, All Class mode allows you to store the number of students in each class into the machine memory beforehand with the user tools. Whenever you need to make print sets for all the classes, place your original, select **[ALL]** and press the **[Start]** key. Print sets will be made containing the correct number of prints for each class.

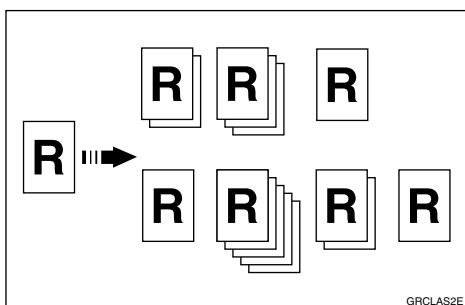

Note

- ❑ When you choose All Class mode, Job Separation mode is automatically turned on. The job separator pulls the top sheet of the each set delivered to the paper delivery tray to mark the end of each printed set. The next cycle begins automatically. See p.79 "Job Separation".
- ❑ You can cancel Job Separation mode in All Class mode with the user tools. See "Auto Separate" on p.146 "4. Mode Setting".

1 Press the **[Class]** key.

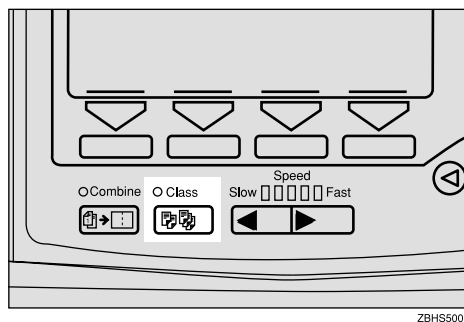

2 Make sure that **[ALL]** is selected.

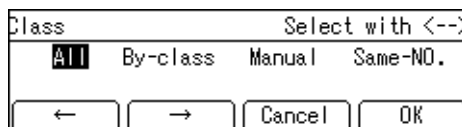

3 Press the **[OK]** key.

4 Place one original on the exposure glass or in the optional document feeder.

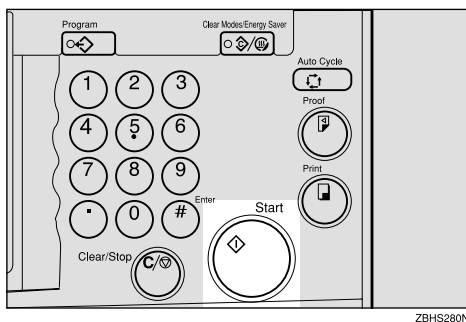
5 Press the **[Start]** key.**6** Check the image position on the trial or proof print.**Note**

- If the image position is not correct, adjust it using the **[Image ⌘]** key. See p.24 "Adjusting the Position of Printed Images".

7 Make your prints.

Auto Class Mode

1

Preparation

You have to store the number of students in each class with the user tools. See p.157 "3-5 Class Enter No."

Use the **[Class]** key to make sets of prints from the same original. The stored numbers of prints are made for each set.

This feature is useful for teachers who frequently make multiple print sets for their classes, e.g. notes, handouts, tests etc.

Using a standard print function, the teacher would have to stand by the machine entering the number of prints and pressing the **[Print]** key for each class. However, Auto Class mode allows you to store the number of students in each class into the machine memory beforehand with the user tools. Then, whenever you need to make print sets for several classes, place your original, select the classes that need prints and press the **[Start]** key. Print sets will be made containing the correct number of prints for each class.

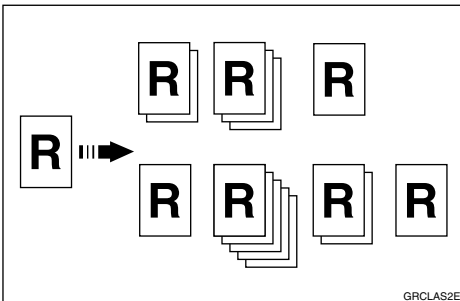

Note

- When you set Auto Class mode, Job Separation mode is automatically turned on. The job separator pulls the top sheet of the each set delivered to the paper delivery tray to mark the end of each printed set. The next cycle begins automatically. See p.79 "Job Separation".
- You can cancel Job Separation mode in Auto Class mode with the user tools. See "Auto Separate" on p.146 "4. Mode Setting".

1 Press the **[Class]** key.

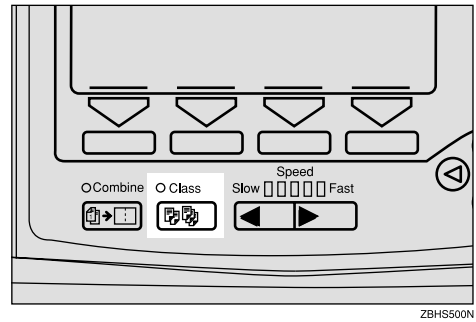

2 Select **[By-class]** with the **[→]** or **[▷]** key.

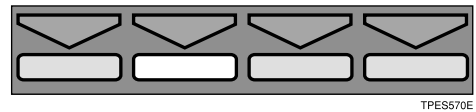
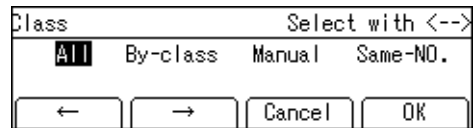

3 Press the **[OK]** key.

4 Select the desired classes for each grade.

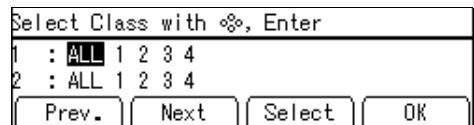

Selecting classes with the [◀], [▶], [△], or [▽] key

- 1 Select the desired class for the 1st grade with the [▶] key.

The number of students is displayed on the counter.

Note

- When you want to select all the classes, select [ALL].

- 2 Press the [Select] key.

Note

- Repeat steps 1 and 2 until you have finished designating classes for the 1st grade.
- To cancel a class selection, select that class with the [◀], [▶], [△], or [▽] key, and then press the [Cancel] key.
- When you want to select many classes for one grade, first select [ALL] and press the [Select] key, and then deselect the unnecessary classes with the [Cancel] key.

- 3 Press the [▽] key.

Now you can select classes for the 2nd grade.

- 4 Select the desired class for the 2nd grade with the [◀], [▶], [△], or [▽] key.

- 5 Press the [Select] key.

Note

- Repeat steps 3 to 5 until you have finished designating all the desired classes.

Selecting classes with the number keys

- 1 Enter the desired grade and class with the number keys.

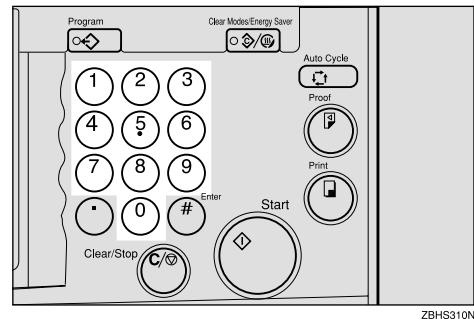

Note

- For example, to select grade 2 class 4, enter 24.
- When you want to select all the classes for one grade, enter the grade number followed by 0.

- 2 Press the [#] key.

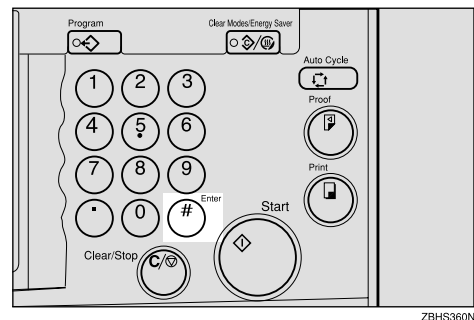

Note

- To cancel a class, select that class with the [◀], [▶], [△], or [▽] key, and then press the [Cancel] key.
- Repeat steps 1 and 2 until you have finished selecting all the desired classes.

- 5 Press the [OK] key.

1

6 Place one original on the exposure glass or in the optional document feeder.

7 Press the **[Start]** key.

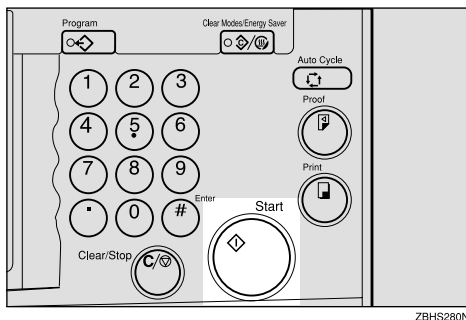

8 Check the image position on the trial or proof print.

Note

- If the image position is not correct, adjust it using the **[Image]** key. See p.24 "Adjusting the Position of Printed Images".

9 Make your prints.

Manual Class Mode with One Original

Use the **[Class]** key to make sets of prints from the same original. Various numbers of prints are made for each set.

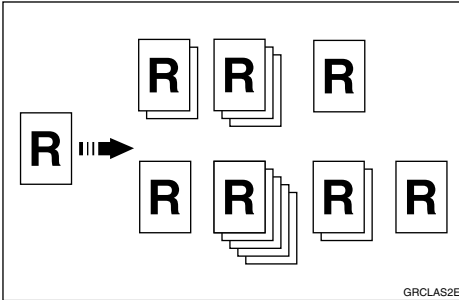

Note

- When you set the Manual Class mode, Job Separation mode is automatically turned on. The job separator pulls the top sheet of each set delivered to the paper delivery tray to mark the end of each printed set. The next cycle begins automatically. See p.79 "Job Separation".
- To stop Job Separation mode from automatically turning on, use the user tools. See "Auto Separate" on p.146 "4. Mode Setting".

1 Press the **[Class]** key.

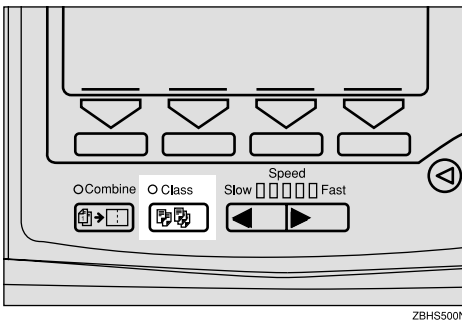

2 Select **[Manual]** with the **[→]** or **[▷]** key.

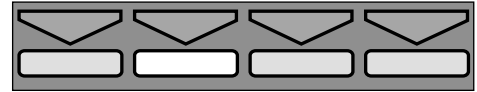
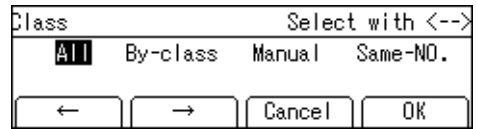

3 Press the **[OK]** key.

4 Enter the desired number of prints for the first set with the number keys.

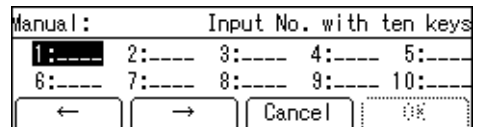

5 Press the **[#]** key.

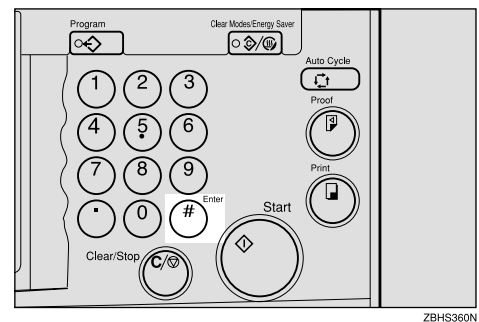

1

6 Enter the desired number of prints for the second set with the number keys.

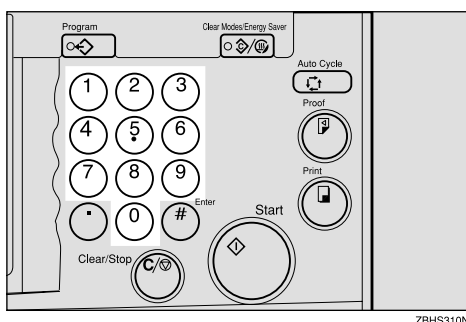

12 Make your prints.

7 Press the [#] key.

Note

- Repeat steps **6** and **7** for each set.
- The maximum number of sets that can be made is 20.

8 Press the [OK] key.

9 Place one original on the exposure glass or in the optional document feeder.

10 Press the [Start] key.

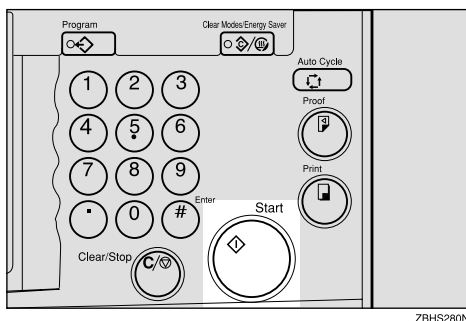

11 Check the image position on the trial or proof print.

Note

- If the image position is not correct, adjust it using the [Image ❄️] key. See p.24 "Adjusting the Position of Printed Images".

Manual Class Mode with two or More Originals

Preparation

To use this function, you have to select "by each original" with the "Class Manual Set" setting in the user tools. See "Class Manual Set" on p.146 "4. Mode Setting".

Use the **[Class]** key to make sets of prints from different originals. Various numbers of prints are made for each set.

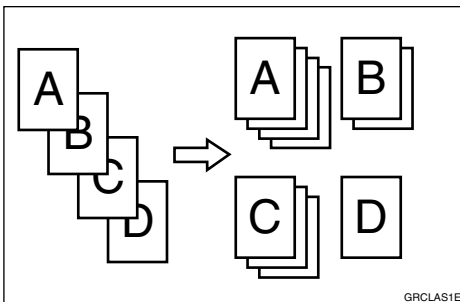

Note

- ❑ When you set Manual Class mode, Job Separation mode is automatically turned on. The job separator pulls the top sheet of each set delivered to the paper delivery tray to mark the end of each printed set. The next cycle begins automatically. See p.79 "Job Separation".
- ❑ You can suspend Job Separation mode whenever you set the Manual Class mode with the user tools. See "Auto Separate" on p.146 "4. Mode Setting".
- ❑ With the optional document feeder, you can place several originals and make prints of all of them at once. See p.130 "Manual Class Mode with Two or More Originals".

1 Press the **[Class]** key.

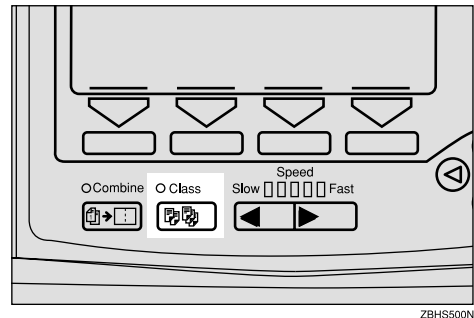

2 Select **[Manual]** with the **[→]** or **[▷]** key.

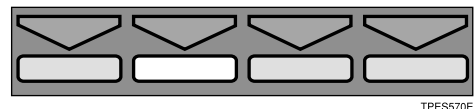
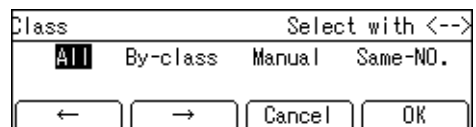

3 Press the **[OK]** key.

4 Enter the desired number of prints for the first original with the number keys.

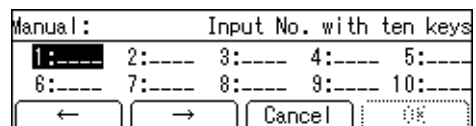

5 Press the **[#]** key.

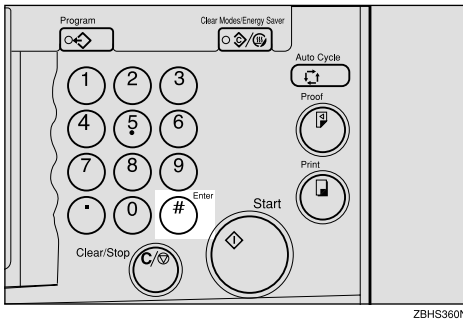

ZBHS360N

10 Press the **[Start]** key.

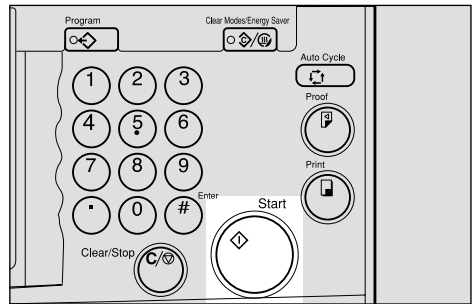

ZBHS280N

6 Enter the desired number of prints for the second original with the number keys.

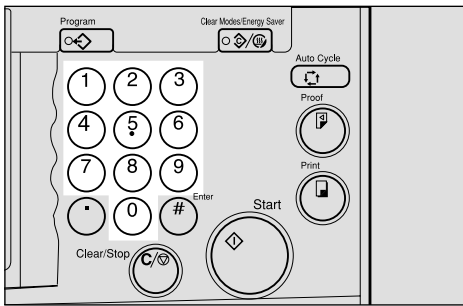

ZBHS310N

11 Check the image position on the trial or proof print.

Note

- If the image position is not correct, adjust it using the **[Image ⚙️]** keys. See p.24 "Adjusting the Position of Printed Images".

12 Press the **[Auto Cycle]** key.

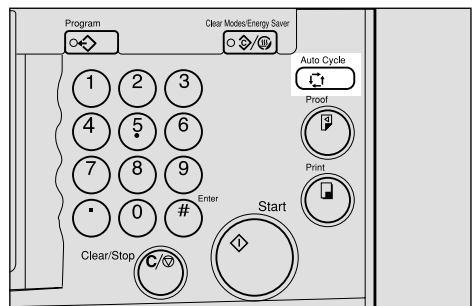

ZBHS490N

7 Press the **[#]** key.

Note

- Repeat steps **6** and **7** for each original.
- Up to 20 classes can be set.

8 Press the **[OK]** key.

9 Place the first original face down on the exposure glass.

13 Press the **[Print]** key.

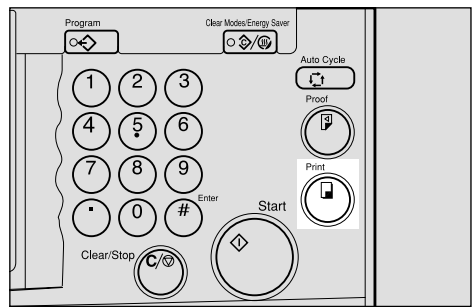

ZBHS320N

- 14** After the first set is completed, place the second original on the exposure glass, and then press the **[Start]** key.

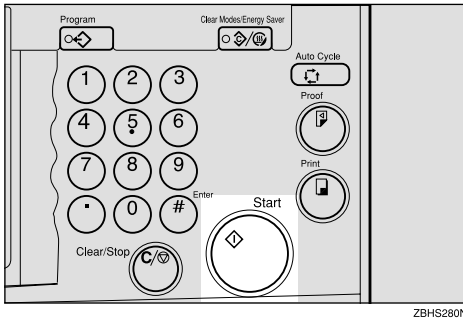

Note

- Repeat step **14** until you have finished printing.

Free Manuals Download Website

<http://myh66.com>

<http://usermanuals.us>

<http://www.somanuals.com>

<http://www.4manuals.cc>

<http://www.manual-lib.com>

<http://www.404manual.com>

<http://www.luxmanual.com>

<http://aubethermostatmanual.com>

Golf course search by state

<http://golfingnear.com>

Email search by domain

<http://emailbydomain.com>

Auto manuals search

<http://auto.somanuals.com>

TV manuals search

<http://tv.somanuals.com>