

---

**3799/3799nf**  
**F9199/F9199nf**  
**LF510/LF515e**  
**5510L/5510NF**

**Operating Instructions**  
**<Advanced Features>**

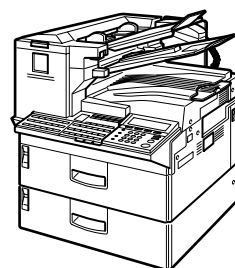

- 
- 1** Transmission Mode
  - 2** Communication Information
  - 3** Other Transmission Features
  - 4** Reception Features
  - 5** Copying
  - 6** Facsimile User Tools
  - 7** Key Operator Settings
  - 8** Solving Operation Problems
  - 9** Maintaining Your Machine
  - 10** Appendix

For safe and correct use of this machine, please be sure to read the Safety Information in the Basic Features manual before you use it.

Type for 3799/F9199/LF510 AG/5510L  
Type for 3799nf/F9199nf/LF515e AG/5510NF  
Printed in Japan  
UE  H310-8700A

## **Introduction**

This manual describes detailed instructions on the operation and notes about the use of this machine. To get maximum versatility from this machine all operators are requested to read this manual carefully and follow the instructions. Please keep this manual in a handy place near the machine.

### **Notes:**

Some illustrations in this manual might be slightly different from the machine.

Certain options might not be available in some countries. For details, please contact your local dealer.

### **Machine Types:**

The model names of the machine do not appear in the following pages. Check the type of your machine before reading this manual. (For details, see p.17 "Machine Types", <*Basic Features*>.)

- Type1: 3799/F9199/LF510/5510L
- Type2: 3799nf/F9199nf/LF515e/5510NF

### **Notes:**

Two kinds of size notation are employed in this manual. With this machine refer to the inch version.

### **Important**

Contents of this manual are subject to change without prior notice. In no event will the company be liable for direct, indirect, special, incidental, or consequential damages as a result of handling or operating the machine.

### **Power Source:**

AC120 V, 60 Hz

Please be sure to connect the power cord to a power source as above. For details about power source, see p.284 "Connecting the Power and Switching On".

In accordance with IEC 60417, this machine uses the following symbols for the main power switch:

**I** means **POWER ON.**

**O** means **POWER OFF.**

# TABLE OF CONTENTS

<b>How to Read this Manual .....</b>	<b>1</b>
Paper Mark.....	2
<b>Manuals for This Machine.....</b>	<b>3</b>
Advanced Features (This Manual).....	3
Basic Features .....	3
NIC FAX Unit Manual (on CD-ROM) (Option for Type1) .....	4
NIC FAX Unit CD-ROM Manual (Option for Type1).....	4

## 1. Transmission Mode

---

<b>Sending at a Specific Time (Send Later) .....</b>	<b>5</b>
<b>Sending Confidential Messages.....</b>	<b>7</b>
<b>User Code Transmission.....</b>	<b>10</b>
Entering a User Code with a Quick Dial Key.....	12
<b>SUB Code Transmission with the Mode Key .....</b>	<b>13</b>
<b>SEP Code Polling Reception .....</b>	<b>16</b>
<b>Polling Reception.....</b>	<b>19</b>
File Reserve Report (Polling Reception).....	21
Communication Result Report (Polling Reception).....	21
<b>Polling Transmission.....</b>	<b>22</b>
Polling Transmission Clear Report.....	25
<b>Reduced Image Transmission .....</b>	<b>26</b>
<b>Transfer Request .....</b>	<b>28</b>
Specifying an End Receiver .....	31
<b>Fax Header Print .....</b>	<b>32</b>

## 2. Communication Information

---

<b>Checking and Canceling Transmission Files.....</b>	<b>35</b>
Canceling a Transmission or Reception .....	35
Printing a Stored Message .....	37
Checking and Editing a File .....	38
<b>Printing a List of Files in Memory (Print TX File List).....</b>	<b>43</b>
<b>Checking the Transmission Result (TX Status).....</b>	<b>44</b>
<b>Checking the Reception Result (RX Status).....</b>	<b>45</b>
<b>Printing a Confidential Message .....</b>	<b>46</b>
Confidential File Report.....	47
<b>Printing a Memory-locked Message.....</b>	<b>48</b>
<b>Printing the Journal .....</b>	<b>50</b>
Printing the Journal .....	53
<b>Displaying the Files in Memory .....</b>	<b>56</b>
<b>TX/RX File Save.....</b>	<b>58</b>
Searching Memory for Sent Faxes.....	59
Searching Memory for Received Faxes .....	62
Disk File Search List/Visual List.....	65
Printing Files .....	65
Deleting Files .....	66

<b>Box File Manager Functions .....</b>	<b>67</b>
Printing Personal Box Messages .....	67
Storing Messages in Information Boxes .....	69
Printing Information Box Messages .....	70
Deleting Information Box Messages .....	71

### **3. Other Transmission Features**

<b>Handy Dialing Functions .....</b>	<b>75</b>
Chain Dial .....	75
Telephone Directory .....	76
Redial .....	77
SUB/SID (SUB Code Transmission) .....	78
SEP/PWD (SEP Code Polling Transmission) .....	80
Sub-address .....	82
UUI .....	83
<b>On Hook Dial .....</b>	<b>85</b>
Using On Hook Dial with ISDN .....	86
<b>Manual Dial .....</b>	<b>88</b>
<b>Selecting the Line .....</b>	<b>89</b>
Auto Discriminate .....	91
How to Select the Line .....	91
<b>Transmission Features .....</b>	<b>93</b>
Stamp .....	93
Auto Reduction .....	93
ID Transmission .....	94
Duplex Original Settings .....	94
If Memory Runs out While Scanning Is in Progress .....	95
Batch Original Documents Transmission .....	96
If Scanning Fails .....	97
If Memory Runs out While Scanning Is in Progress .....	97
Label Insertion .....	98
Inserting a Label Using Auto Document .....	98
Auto Document .....	99
No Document, No Dial .....	100
Blank Sheet Detect .....	101
Scanner Cleaning Message .....	101
Backup File Transmission .....	102
JBIG Transmission .....	102
<b>More Transmission Functions .....</b>	<b>103</b>
If Memory Runs out While Scanning Is in Progress .....	103
Checking the Transmission Result .....	103
Broadcasting Sequence .....	104
Simultaneous Broadcast .....	104
Sending a Fax Message Immediately .....	104
Broadcasting: Checking Progress .....	104
Automatic Redial .....	105
Batch Transmission .....	105
Dual Access .....	105
ECM (Error Correction Mode) .....	105
Parallel Memory Transmission .....	105

<b>Printed Reports</b> .....	<b>107</b>
File Reserve Report (Memory Transmission) .....	107
Communication Result Report (Memory Transmission) .....	107
Communication Failure Report .....	108
Transmission Result Report (Immediate Transmission) .....	108

## **4. Reception Features**

---

<b>General</b> .....	<b>109</b>
Immediate Reception .....	109
Memory Reception .....	110
Substitute Reception .....	111
Screening Out Messages From Anonymous Senders .....	112
<b>Selecting the Reception Mode</b> .....	<b>113</b>
Fax Mode (Auto Receive Mode) .....	113
Telephone Mode .....	113
<b>Reception Functions</b> .....	<b>114</b>
Transfer Station.....	114
Transfer Result Report .....	115
Multi-step Transfer.....	115
Remote Transfer .....	116
How to make a Remote Transfer Request (push signal).....	116
Remote Transfer with UUI.....	118
How to make a Remote Transfer Request (UUI).....	118
ID Reception .....	119
JBIG Reception .....	119
<b>Printing Functions</b> .....	<b>120</b>
Center Mark .....	120
Checkered Mark.....	120
Multi-copy Reception.....	120
Reception Time .....	121
Two In One.....	121
Image Rotation.....	122
Rotate Sort .....	122
Page Separation and Length Reduction .....	123
TSI Print .....	123
CIL Print .....	123
TID Print .....	124
Adjusting the Printing Density .....	124
Output density .....	124
Toner saving.....	124
<b>When There Is No Paper of the Correct Size</b> .....	<b>125</b>

## 5. Copying

---

<b>Copying</b> .....	<b>127</b>
Making Copies on Special Paper .....	129

## 6. Facsimile User Tools

---

<b>Accessing the User Tools</b> .....	<b>131</b>
Counters.....	134
Selecting the Display Language.....	135
<b>Program/Delete Menu</b> .....	<b>136</b>
Multi-step Transfer Group Settings .....	136
Storing and Changing Keystroke Programs .....	139
Using a Keystroke Program.....	142
Deleting a Keystroke Program.....	143
Registering Auto Documents .....	145
Programming and Changing an Auto Document.....	145
Deleting an Auto Document .....	147
<b>Reports/Lists</b> .....	<b>149</b>
<b>Setup</b> .....	<b>151</b>
Adjusting the Display Contrast .....	151
Date/Time.....	151
Fax Reset Timer.....	152
On Hook Timer.....	153
<b>User Function Keys</b> .....	<b>154</b>
Functions You Can Assign to User Function Keys .....	154
Registering/Editing the Contents of a User Function Key .....	156
Programming by Specifying a Function Code with the Number Keys .....	156
Programming a User Function Key on the Job.....	157
Using a User Function Key .....	158
Deleting Functions Stored in User Function Keys.....	158
<b>Fax On Demand</b> .....	<b>160</b>
Registering/Editing Fax On Demand Documents .....	160
Deleting Fax On Demand Documents .....	162
Printing Fax On Demand Documents .....	164
Printing the Fax On Demand List .....	165
Printing the Fax On Demand Access Report .....	165
Fax On Demand Recorded Messages.....	166
Recording the Fax On Demand Recorded Messages.....	167
Checking the Fax On Demand Recorded Messages .....	168
How Callers Use Fax On Demand .....	169
When the Password Is Turned On .....	170
When the Password Is Turned Off .....	170



## 7. Key Operator Settings

<b>Accessing the Key Operator Tools .....</b>	<b>171</b>	
<b>System Settings .....</b>	<b>175</b>	
Economy Transmission .....	175	
Night Timer .....	176	
User Parameters .....	178	
How to Set User Parameters .....	188	
Printing the User Parameter List .....	189	
G3 Analog Line .....	189	
G3 Digital Line .....	192	
G4 Digital Line .....	194	
Fax On Demand Reception .....	197	
Registering ID Codes .....	199	
Registering .....	200	
File Retention .....	201	
Transfer Report .....	202	
Network Settings .....	204	
IP-Fax Parameter Settings .....	204	
System Parameter Transmission .....	204	
Key Layout .....	205	
Print Position .....	206	
Memory File Transfer .....	207	
Deleting Entries .....	209	
Deleting Entries .....	209	
Reset PM Counter .....	211	
RDS (Remote Diagnostic System) .....	212	
<b>Initial Set Up .....</b>	<b>214</b>	
Multi-copy Reception .....	(Printing Multiple Copies of Messages From Certain Senders) .....	214
Setting up Multi-copy Reception .....	214	
Deleting Specified Senders .....	216	
Printing the Specified Sender List .....	217	
Authorized Reception .....	(Blocking Out Messages from Certain Senders) ...	217
Setting up Authorized Reception .....	218	
Deleting Specified Senders .....	219	
Printing the Specified Sender List .....	220	
Specified Tray .....	(Having Messages from Certain Senders Printed on Different Paper) .....	220
Setting up Specified Tray .....	221	
Deleting Specified Senders .....	223	
Printing the Specified Sender List .....	223	
Forwarding .....	(Having Messages From Certain Senders Forwarded) .....	223
Setting up Forwarding .....	225	
Deleting Forwarding Addresses .....	228	
Deleting Specified Senders (Forwarding) .....	229	
Printing the Specified Sender List (Forwarding) .....	231	

Memory Lock.....	(Having Messages from Certain Senders Stored in Memory Instead of Being Printed Out).....	233
Setting up Memory Lock.....		234
Deleting Specified Senders .....		236
Printing the Specified Sender List .....		236
TX/RX File Save Settings.....	(Having Messages from Certain Senders Stored in Memory) .....	236
Setting up TX/RX File Save.....		237
Deleting Specified Senders .....		239
Printing the Specified Sender List .....		239
Deleting Specified Senders.....	(General Procedure for Deleting Specified Senders) .....	239
How to Delete Specified Senders.....		239
Printing the Specified Sender List.....	(General Procedure for Printing a List of Registered Specified Senders) .....	241
How to Print Specified Sender List.....		241
Backup File Transmission Settings ...	(Specifying a Destination to Send Backups of Faxes) .....	243
<b>Box Settings .....</b>		<b>245</b>
Personal Boxes .....		246
Registering/Editing Personal Boxes .....		247
Deleting Personal Boxes .....		250
Information Boxes .....		251
Registering/Editing Information Boxes .....		251
Deleting Information Boxes .....		253
Transfer Boxes.....		254
Registering/Editing Transfer Boxes.....		255
Deleting Transfer Boxes.....		258
Printing the Box List .....		259
 <b>8. Solving Operation Problems</b>		
<hr/>		
<b>Clearing a Paper Jam in the Optional Paper Supply Units .....</b>		<b>261</b>
Clearing a Paper Jam in the Optional Paper Tray Unit.....		261
Clearing a Paper Jam in the Optional Bypass Tray Unit.....		262
<b>Reading Reports .....</b>		<b>264</b>
Error Report .....		264
Power Failure Report .....		264
<b>Error Codes .....</b>		<b>265</b>

## 9. Maintaining Your Machine

---

<b>Loading Paper into the Optional Paper Tray Unit.....</b>	<b>267</b>
<b>Loading Paper into the Optional Bypass Tray Unit.....</b>	<b>268</b>
<b>Changing the Paper Size.....</b>	<b>269</b>
Changing the Paper Size in the Main Paper Tray.....	269
Changing the Paper Size in the Optional Paper Tray Unit.....	271
Changing the Paper Size in the Optional Bypass Tray Unit.....	273
<b>Cleaning.....</b>	<b>275</b>
Cleaning the Document Transport Mechanism.....	275
Cleaning the Copy Paper Transport Mechanism.....	277
Main Paper Tray.....	277
Optional Paper Tray Unit.....	277
Optional Bypass Tray Unit.....	278
Cleaning the Registration Roller.....	279
<b>Replacing the Stamp Cartridge.....</b>	<b>280</b>

## 10. Appendix

---

<b>Installation, Move and Disposal of the Machine.....</b>	<b>281</b>
Machine Environment.....	281
Location.....	283
Connecting the Power and Switching On.....	284
Moving the Machine.....	285
Disposing of the Machine.....	285
<b>Connecting to a Telephone Line.....</b>	<b>286</b>
Connecting the Machine to the Telephone Line.....	286
Connecting to an Additional G3 Line.....	287
ISDN.....	287
Connecting an External Telephone.....	287
Connecting the Optional Handset.....	288
Installing the Optional Handset.....	288
Setting up the Optional Handset.....	288
<b>Supplies.....</b>	<b>289</b>
<b>Options.....</b>	<b>290</b>
40MB Memory Card.....	290
Function Upgrade Unit.....	291
Fax On Demand Unit.....	291
Extra G3 Interface Unit.....	292
ISDN Unit.....	292
Handset.....	292
NIC FAX Unit (Option for Type1).....	292
Printer Interface Unit.....	293
Other Options.....	293

<b>Specifications</b> .....	<b>294</b>
Acceptable Types of Originals .....	296
Acceptable Original Sizes.....	296
Paper Size and Scanned Area .....	297
Paper.....	298
Recommended Paper Sizes and Types .....	298
Non-recommended Paper .....	299
Energy Saving.....	300
Introduction.....	300
Entering Energy Saver Mode .....	301
Exiting Energy Saver Mode.....	302
Selecting the Energy Saver Mode type .....	302
Reception in Energy Saver Mode.....	302
<b>Maximum Values</b> .....	<b>303</b>
<b>INDEX</b> .....	<b>304</b>

# How to Read this Manual

The following set of symbols is used in this manual.

## **WARNING:**

This symbol indicates a potentially hazardous situation that might result in death or serious injury when you misuse the machine without following the instructions under this symbol. Be sure to read the instructions, all of which are described in the Safety Information section in the Basic Features manual.

## **CAUTION:**

This symbol indicates a potentially hazardous situation that might result in minor or moderate injury or property damage that does not involve personal injury when you misuse the machine without following the instructions under this symbol. Be sure to read the instructions, all of which are described in the Safety Information section in the Basic Features manual.

\* The statements above are notes for your safety.

## **Important**

If this instruction is not followed, paper might be misfed, originals might be damaged, or data might be lost. Be sure to read this.

## **Preparation**

This symbol indicates information or preparations required prior to operating.

## **Note**

This symbol indicates precautions for operation, or actions to take after abnormal operation.

## **Limitation**

This symbol indicates numerical limits, functions that cannot be used together, or conditions in which a particular function cannot be used.

## **Reference**

This symbol indicates a reference.

[    ]





Keys that appear on the machine's panel display.

【    】

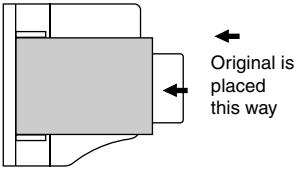
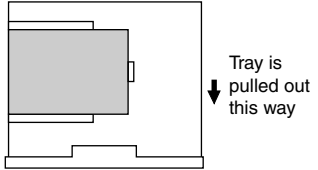

Keys built into the control panel of the machine.

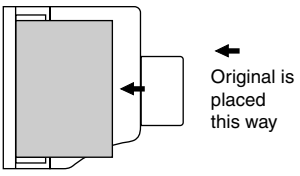
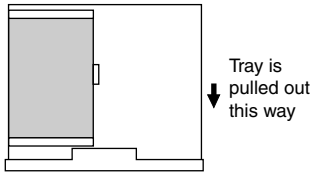

# Paper Mark

Paper Directions are shown as following on this book.



Originals placed on the ADF	Paper loaded in the tray	Paper Direction
 <p>Original is placed this way</p>	 <p>Tray is pulled out this way</p>	
 <p>Original is placed this way</p>	 <p>Tray is pulled out this way</p>	

GFKAM10N

Portrait direction towards originals set direction is shown as , and landscape direction towards original set direction is shown as .

Portrait direction on the paper tray is shown as , and landscape direction on the paper tray is shown as .

## Note

  represents original or paper.

## Reference

For "Auto Document Feeder (ADF)", see p.18 "Guide to Components", <Basic Features>.

# Manuals for This Machine

Two Facsimile Reference manuals are provided, the Basic Features manual and the Advanced Features manual. For Type 2 machines and Type 1 machines with options, NIC FAX Unit manual and NIC FAX Unit CD-ROM manual are also provided. Please refer to the manual that suits your needs.

Instructions for the optional ISDN Unit (ISDN G4 Interface Unit Type510) and the Extra G3 Interface Unit (G3 Interface Unit Type510) are included in the Basic Features and Advanced Features manuals.

---

## Advanced Features (This Manual)

---

The Advanced Features manual describes more advanced functions, and also explains settings for key operators.

---

## Basic Features

---

The Basic Features manual explains the most frequently used fax functions and operations.

### ❖ Chapter 1 Getting Started

Describes part names of the machine and control panel. Also lists symbols and conventions used in this manual.

### ❖ Chapter 2 Faxing

Explains basic transmission. You can also find out about other types of transmissions and how to switch the reception mode.

### ❖ Chapter 3 Programming

Explains how to make initial settings, such as the Own Name and Own Fax Number settings. Also explains the Quick Dial, Speed Dial and Group keys. These functions allow you to store numbers and save time when dialing. This chapter also explains how to enter letters and symbols.

### ❖ Chapter 4 Troubleshooting

Explains clearing document jams, loading paper and changing the volume of audible signals generated by the machine. When the display or indicator lights show unusual information, check the list and take appropriate action.

---

## NIC FAX Unit Manual (on CD-ROM) (Option for Type1)

---

The NIC Fax Unit manual explains about the Internet Fax function, IP-Fax function, LAN FAX function and Scanner function.

### ❖ Chapter 1 Getting Started

Explains names and functions for the control panel and necessary settings. Software on the CD-ROM and how to install it are also explained.

### ❖ Chapter 2 Using Internet Fax Functions

Explains the Internet Fax function. You can send and receive documents by e-mail using the Internet.

### ❖ Chapter 3 Using IP-Fax Functions

Explains the IP-Fax function. You can send and receive documents between fax machines that are connected to the network using TCP/IP.

### ❖ Chapter 4 Using LAN FAX Functions

Explains the LAN Fax function. You can send documents that are created using computer applications. Editing the destinations in the Address Book that are used when sending by LAN Fax is also explained.

### ❖ Chapter 5 Using Scanner Functions

Explains sending scanned data as an image file attached to e-mail. The Network Delivery Scanner is also explained. You can deliver scanned data using the delivery server.

### ❖ Chapter 6 Registering Addresses

Explains how to register the destinations for Internet Fax, IP-Fax and Scanner using Quick Dial and Speed Dial. How to register an Address Template often used when specifying destinations is also explained.

### ❖ Chapter 7 Making Settings through a Web Browser

Explains the items you can check and set using a Web browser on a Network computer. The Help function is also explained.

### ❖ Chapter 8 Troubleshooting

Explains error messages and user parameter settings. When the display shows unusual information, check the list in this chapter and take the appropriate action.

### ❖ Chapter 9 Appendix

Explains important reports and lists that are printed when using Internet Fax function or PC FAX function. Specifications are also in this chapter.

---

## NIC FAX Unit CD-ROM Manual (Option for Type1)

---

Introduces the contents of the NIC FAX CD-ROM and the necessary operating environment for the CD-ROM.

How to access the NIC FAX unit manual in PDF format on the CD-ROM is also explained.



# 1. Transmission Mode

## Sending at a Specific Time (Send Later)

Using the Send Later function, you can delay transmission of your fax message until a specified time. This allows you to take advantage of off-peak telephone line charges without having to be by the machine at the time of transmission.

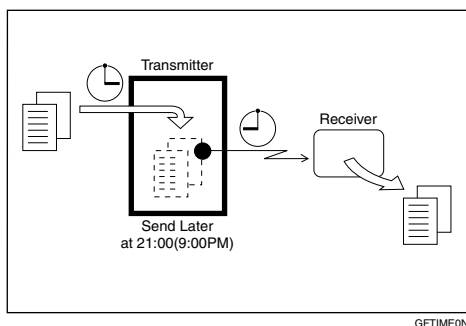

### Important

- ❑ If the Power switch is off for 12 hours or longer, all the stored messages are deleted.

### Limitation

- ❑ This feature is not available with Immediate Transmission. Specify Memory Transmission beforehand.

### Note

- ❑ You cannot specify a time more than 24 hours into the future.
- ❑ If you wish to use Economy Transmission, program the time when your phone charges get cheaper. See p.175 "Economy Transmission".

- 1** Set the original and select any scan settings you require.

- 2** Press [Mode].

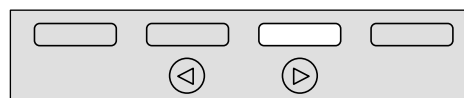
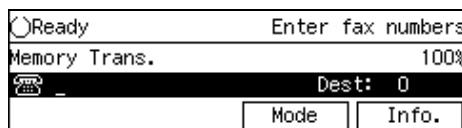

ZGSS210N

The Transmission Mode menu appears.

- 3** Enter the code for "Send Later" with the number keys.

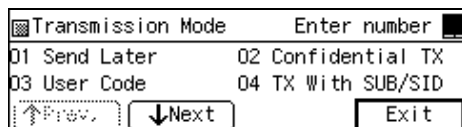

- 4** Enter the time with the number keys. To change AM/PM, press [AM/PM] or press [Economy TX].

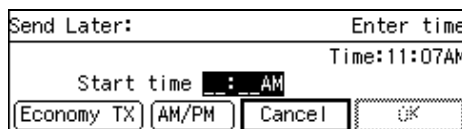

### Note

- ❑ If the current time shown on the display is not correct, adjust it. See p.151 "Date/Time".
- ❑ The current time appears on the right side of the display.
- ❑ When entering numbers smaller than 10, add a leading zero.
- ❑ If you make a mistake, press the [Clear] key or [Stop] key and try again.

**5** Press [OK].

Send Later:	Enter time
	Time: 11:09AM
Start time	11:15PM
Economy TX	AM/PM
Cancel	OK

The Transmission Mode menu is shown on the display. A check mark is added to Send Later.

**Note**

- To cancel Send Later, press **[Cancel]** and the display will return to the Transmission Mode menu.

**6** Press [Exit].

Transmission Mode	Enter number
01 ✓ Send Later	02 Confidential TX
03 User Code	04 TX With SUB/SID
↑ Prev.	↓ Next
	Exit

The standby display is shown.

Ready	Enter fax numbers
Memory Trans.	Send Later 100%
Dest: 0	
Mode	Info.

**Note**

- "Send Later" is shown on the display. If you set up other transmission mode functions (except Polling Reception), "Others" is displayed.

**7** Dial, and then press the **[Start]** key.**Note**

- You can cancel transmission of a message set up for Send Later. See p.35 "Canceling a Transmission or Reception".

# Sending Confidential Messages

This feature is called Confidential Transmission. Use this feature if you do not want your message to be picked up casually by anybody at the other end. The message will be stored in the memory at the other end. It will not be printed until the Confidential ID is entered.

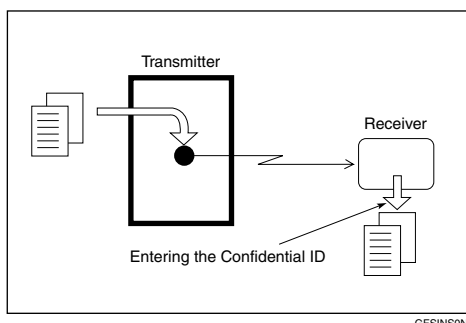

There are two types of Confidential Transmission:

## ❖ Default ID

The other party can print the message by entering the ID that was previously stored in the other party's terminal using the Confidential ID feature.

## ❖ ID Override

If you wish to send a confidential message to a particular person at the other end, you can specify the Confidential ID that person has to enter to see that message. Anybody entering the machine's Confidential ID will not be able to see the message. Before you send the message, do not forget to tell the intended receiver what code must be entered to print the message.

## ! Limitation

- The destination machine must be of the same make and have the Confidential Reception feature.

## ✎ Note

- We recommend that you program the Confidential ID beforehand. See p.199 "Registering ID Codes".
- An ID can be any 4 digit number except 0000.
- The destination machine must have enough memory available.

**1** Set the original and select any scan settings you require.

**2** Press [Mode].

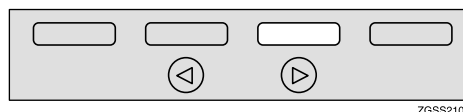
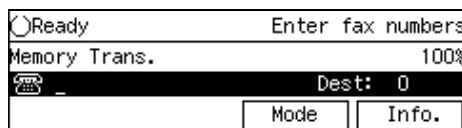

The Transmission Mode menu appears.

**3** Enter the code for "Confidential TX" with the number keys.

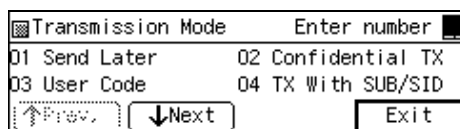

1

- 4** Depending on the Confidential Transmission type, use one of the following procedures:

---

### Default ID

---

- 1** Press **◀** or **▶** key to select "Default ID".

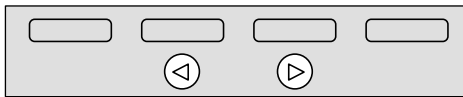
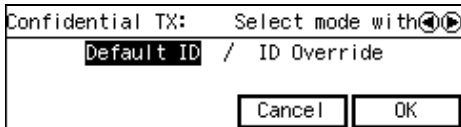

- 2** Press **[OK]**.

The Transmission Mode menu is shown again. A check mark is added to Confidential TX.

**Note**

- To cancel the Confidential Transmission, press **[Cancel]**. The Transmission Mode menu is shown on the display.

---

### ID Override

---

- 1** Press **◀** or **▶** key to select "ID Override".

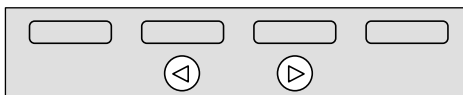
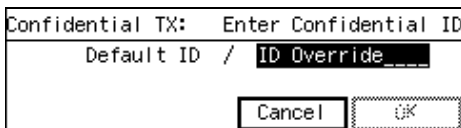

- 2** Enter the Confidential ID (4-digit number) with the number key.

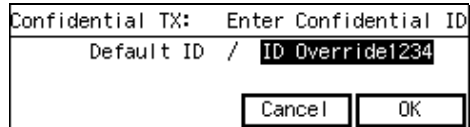

- 3** Press **[OK]**.

The Transmission Mode menu is shown again. A check mark is added to Confidential TX.

**Note**

- To cancel the Confidential Transmission, press **[Cancel]**. The Transmission Mode menu is shown on the display.

- 5** Press **[Exit]**.

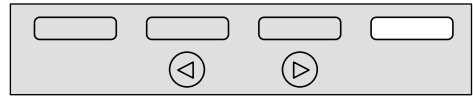
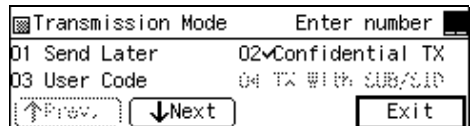

The standby display is shown.

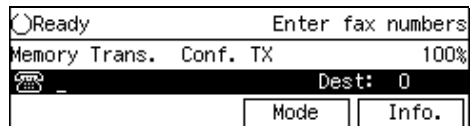

**Note**

- "Conf. TX" is shown on the display. If you set up other transmission mode functions (except Polling Reception), "Others" is displayed.

**6** Dial, and then press the **[Start]** key.

 **Note**

- You can cancel transmission of a message set up for Confidential Transmission. See p.35 “Canceling a Transmission or Reception”.

 **Sending confidential faxes to other makers' machines**

Confidential Transmission is only possible with machines of the same make that have the Confidential Transmission feature. However, if you use the SUB/SID function, you can send and receive confidential faxes to and from other makers' machines that have the SUB/SID feature. See p.13 “SUB Code Transmission with the Mode Key”.

# User Code Transmission

1

User Codes allow you to keep track of machine usage. If everyone uses a User Code when they use the fax machine, the codes or the names programmed for the codes will be printed in the Journal and other reports. This will help you to check who has been using the machine and how often.

## Preparation

To register User Codes, create a Personal Box for each user beforehand. The SUB code you specify will become the user's User Code. See p.247 "Registering/Editing Personal Boxes".

## Note

- ❑ User Codes (the name of the Personal Box) can be printed on the fax, lists or reports printed at the other end.
- ❑ When the user's name is registered into a User Code, and the Label Insertion function is assigned to either a Quick Dial key or Speed Dial, you can have the receiver's name programmed in a Quick Dial key or Speed Dial and the user's name printed on the message when it is received at the other end. See p.98 "Label Insertion".
- ❑ Instead of the Fax Header, you can choose the user's name (the name of the Personal Box) to be printed at the same position on the message. You can turn this function on or off with User Parameters. See p.178 "User Parameters" (switch 20 bit 5).

- 1 Set the original and select any scan settings you require.

- 2 Press [Mode].

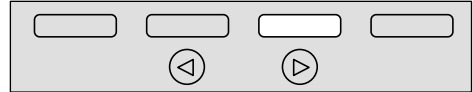
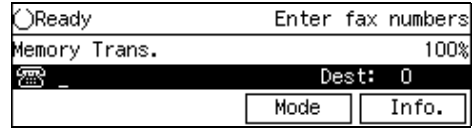

ZGSS210N

The Transmission Mode menu appears.

- 3 Enter the code for "User Code" with the number keys.

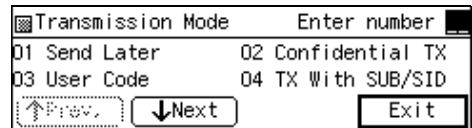

- 4 Enter a User Code/SUB Code (up to 20 digits) with the number keys.

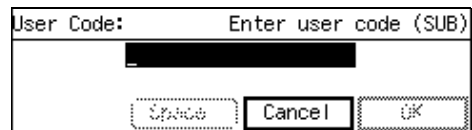

## Note

- ❑ If you incorrectly enter the code, press the **[Clear]** key or **[Stop]** key and try again.

To enter a User Code with a Quick Dial key

- 1 Press the Quick Dial key the User Code has been assigned to.

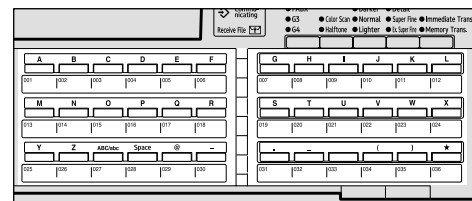

ZGSS280N

**2** Press [Yes].

Do you want to set user code?	
User Code:12345678	
(Name:OPERATIONS)	
No	Yes

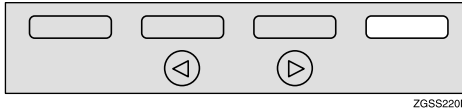

ZGSS220N

Proceed to step **7**.**5** Press [OK].

User Code:	Enter user code (SUB)	
12345678_		
Space	Cancel	OK

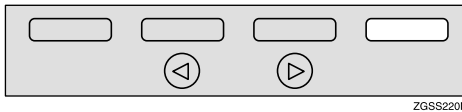

ZGSS220N

The Transmission Mode menu is shown again. A check mark is added to "User Code".

**Note**

- When an unregistered User Code is entered, the following message appears: "Not programmed." then the display in step **4** will reappear.
- To cancel the User Code Transmission, press **[Cancel]**. The Transmission Mode menu is shown on the display.

**6** Press [Exit].

Transmission Mode	Enter number	
01 Send Later	02 Confidential TX	
03 User Code	04 TX With SUB/SID	
Prev.	Next	Exit

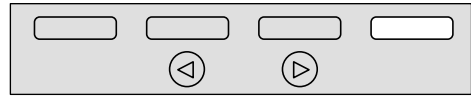

ZGSS220N

The User Code screen appears.

Ready	Enter fax numbers	
Memory Trans.	User Code	100%
Dest: 0	Mode	Info.

**Note**

- "User Code" is shown on the display. If you set up other transmission mode functions (except Polling Reception), "Others" is displayed.

**7** Dial, and then press the [Start] key.**Note**

- You can cancel transmission of a message set up for Personal Transmission. See p.35 "Canceling a Transmission or Reception".

## 1 Entering a User Code with a Quick Dial Key

When a SUB Code (User Code) for a Personal Box has been assigned to a Quick Dial key, you can perform User Code Transmission by just pressing that key.

### Reference

p.247 "Registering/Editing Personal Boxes"

- 1 Set the original and select any scan settings you require.
- 2 Press the Quick Dial key the User Code has been assigned to.

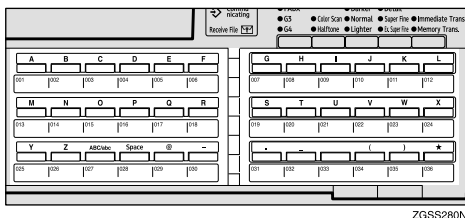

- 3 Press [Yes].

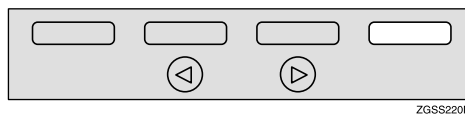
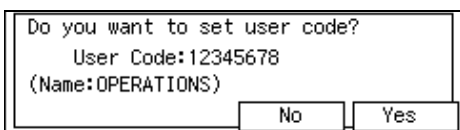

### Note

- "User Code" is shown on the display. If you set up other transmission mode functions (except Polling Reception), "Others" is displayed.

- 4 Dial, and then press the [Start] key.

### Note

- You can cancel transmission of a message set up for Personal Transmission. See p.35 "Canceling a Transmission or Reception".



# SUB Code Transmission with the Mode Key

Confidential Transmission is only possible with machines of the same make that have the Confidential Transmission feature. However, if you use the SUB/SID function, you can send and receive confidential faxes to and from other makers' machines that have the SUB/SID feature. This feature is used when sending faxes to other parties' Personal Boxes or Transfer Boxes.

## Reference

p.78 "SUB/SID (SUB Code Transmission)"

p.246 "Personal Boxes"

p.254 "Transfer Boxes"

**1** Set the original and select any scan settings you require.

**2** Press [Mode].

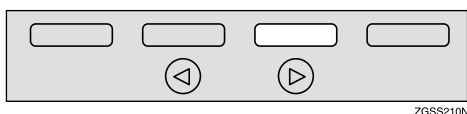
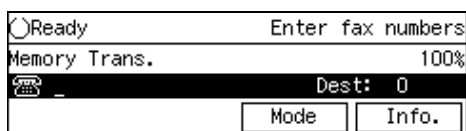

The Transmission Mode menu appears.

**3** Enter the code for "TX With SUB/SID" with the number keys.

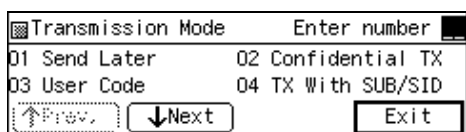

## Note

- If "TX With SUB/SID" is not displayed, press [**↑Prev.**] or [**↓Next**] until it is.

**4** Check the display message, then press [OK].

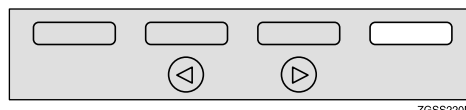
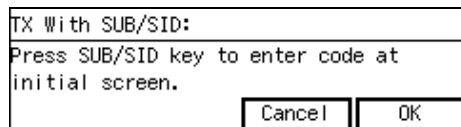

The Transmission Mode menu is shown again. A check mark is added to "TX With SUB/SID".

**5** Press [Exit].

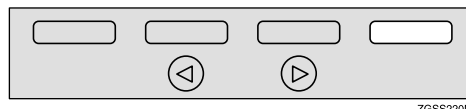
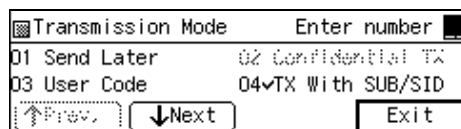

## Note

- "SUB/SID" is displayed. However, if other settings under the Mode menu other than Polling Reception are selected, "Others" is displayed.

**6** Dial the destination fax number.

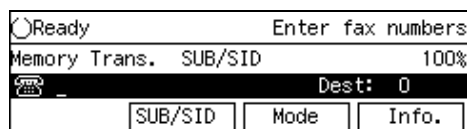

## Note

- If you incorrectly enter the number, press the [**Clear**] key or [**Stop**] key and try again.

**7** Press [SUB/SID].

Ready	Press Start or Clear to cancel
Memory Trans. SUB/SID	100%
9266047131_	Dest: 1
Add	SUB/SID
Mode	Info.

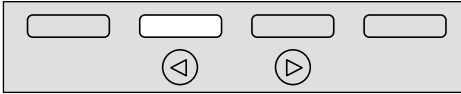

ZGSS200N

**8** Enter the SUB code.

SUB/SID:	Enter code
SUB	
SID	Space
Cancel	OK

**Note**

- You can enter up to 20 characters.
- You can enter digits 0-9, #, \* and spaces. To enter a space, press [Space] (the first character cannot be a space).
- If you incorrectly enter the code, press the [Clear] key or [Stop] key and try again.

---

**When entering the SID (Password) is necessary**

---

You may need to enter the SID (Password) when sending fax messages with the SUB Code Transmission function to other makers' machines. If a password is set for the Transfer Box, enter the SID (Password) in addition to SUB code.

**1** Press [SID].

SUB/SID:	Enter code
SUB	12341234
SID	Space
Cancel	OK

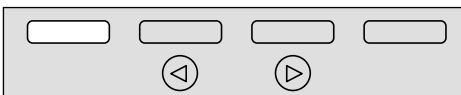

ZGSS190N

**2** Enter the SID code.

SID(Password):	Enter password
SUB	12341234
SID(Password)	
Space	Cancel
	OK

**Note**

- You can enter up to 20 characters.
- You can enter digits 0-9, #, \* and spaces. To enter a space, press [Space] (the first character cannot be a space).
- If you incorrectly enter the code, press the [Clear] key or [Stop] key and try again.

**3** Press [OK].**9** Press [OK].

SUB/SID:	Enter code
SUB	12341234
SID(Password)	9999
SID	Space
Cancel	OK

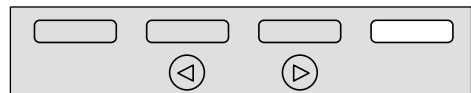

ZGSS220N

---

**If you wish to specify another destination**

---

**1** Press [Add].

Ready	Press Start or Clear to cancel
Memory Trans. SUB/SID	100%
9266047131_	Dest: 1
Add	SUB/SID
Mode	Info.

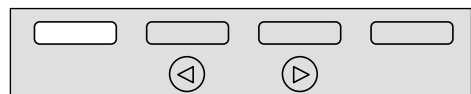

ZGSS190N

**2** Repeat steps 6 to 9.

**10** Press the **[Start]** key.

 **Note**

- You can cancel transmission of a message set up for SUB Code Transmission. See p.35 “Canceling a Transmission or Reception”.

# SEP Code Polling Reception

1

If you wish to receive a message stored in the memory of another party's fax machine, use this feature. The machine will receive the message with the SEP and PWD code that matches the SEP and PWD code you enter in the procedure below.

## Reference

p.80 "SEP/PWD (SEP Code Polling Transmission)"

p.22 "Polling Transmission"

p.251 "Information Boxes"

## 1 Press [Mode].

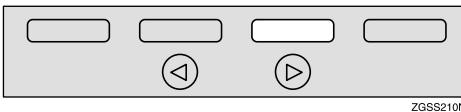
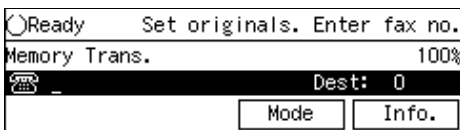

ZGSS210N

The Transmission Mode menu appears.

## 2 Enter the code for "RX With SEP/PWD" with the number keys.

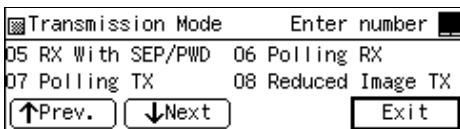

## Note

- If "RX With SEP/PWD" is not displayed, press [**Prev.**] or [**Next**] until it is.

## 3 Check the display message, and then press [OK].

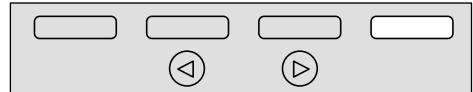
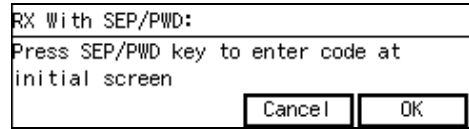

ZGSS220N

The Transmission Mode menu is shown again. A check mark is added to "RX With SEP/PWD".

## 4 Press [Exit].

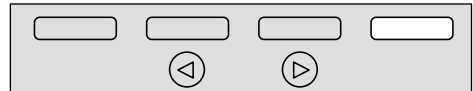
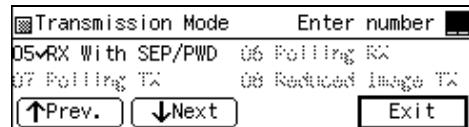

ZGSS220N

## Note

- "SEP/PWD" is displayed. If you set up other transmission mode functions (except Polling Reception), "Others" is displayed.

## 5 Dial the destination fax number.

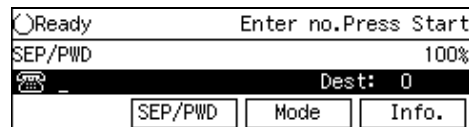

## Note

- If you incorrectly enter the number, press the [**Clear**] key or [**Stop**] key and try again.

**6** Press [SEP/PWD].

○Ready	Press Start or Clear to cancel		
SEP/PWD	100%		
9266047131_	Dest: 1		
Add	SEP/PWD	Mode	Info.

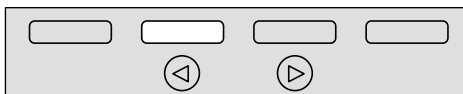

ZGSS200N

**7** Enter the SEP code.

SEP/PWD:	Enter code		
SEP	12341234		
PWD	Space	Cancel	OK

**Note**

- You can enter up to 20 characters.
- You can enter digits 0-9, #, \* and spaces. To enter a space, press [Space] (the first character cannot be a space).
- If you incorrectly enter the code, press the [Clear] key or [Stop] key and try again.

When entering the PWD (Password) is necessary

You may need to enter the PWD (Password) when receiving fax messages with the SEP Code Polling Reception function from other makers' machines. However, the PWD is not necessary when receiving fax messages from a machine of the same make.

**1** Press [PWD].

SEP/PWD:	Enter code		
SEP	12341234		
PWD	Space	Cancel	OK



ZGSS190N

**2** Enter the PWD code.

PWD(Password):	Enter password	
SEP	12341234	
PWD(Password)	9999	
Space	Cancel	OK

**Note**

- You can enter up to 20 characters.
- You can enter digits 0-9, #, \* and spaces. To enter a space, press [Space] (the first character cannot be a space).
- If you incorrectly enter the code, press the [Clear] key or [Stop] key and try again. The [Clear] key deletes one character at a time, and the [Stop] key deletes the whole line.

**3** Press [OK].**8** Press [OK].

SEP/PWD:	Enter code		
SEP	12341234		
PWD(Password)	9999		
PWD	Space	Cancel	OK

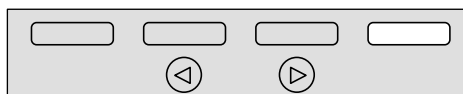

ZGSS220N

1

If you wish to specify another destination

**1 Press [Add].**

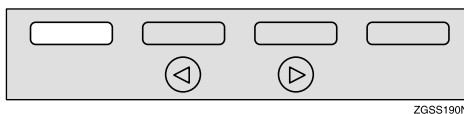
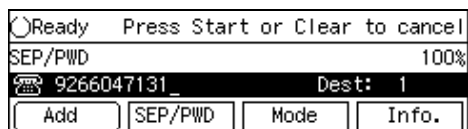

**2 Repeat steps 5 to 8.**

**9 Press the [Start] key.**

**Note**

- You can cancel SUB Code Reception. See p.35 "Canceling a Transmission or Reception".

# Polling Reception

Use this function if you wish to poll a message from another terminal. You can also poll documents from many terminals with only one operation (use Groups and Keystroke programs to fully exploit this feature).

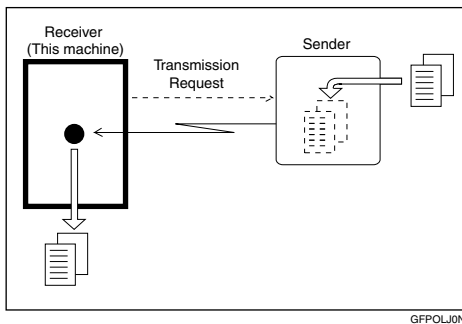

There are two types of Polling Reception.

## ❖ Secured Polling Reception

If the Polling ID is programmed in your machine, any messages waiting in the transmitting machine with the same ID are received. If the other machine does not have any messages waiting with the same Polling ID, any messages that do not require an ID are received (Free Polling).

## ❖ Stored ID Override Polling Reception

You must enter an Override Polling ID unique to this transmission. This ID overrides the Polling ID. Your machine will receive any messages waiting in the transmitting machine with matching IDs. If no IDs match, any messages that does not require an ID are received (Free Polling).

## 📌 Limitation

- ❑ Polling Reception requires that the other machine can perform Polling Transmission.
- ❑ To receive a message sent by any Default ID Polling Transmission or Override ID Polling Transmission, it is necessary to specify the same Polling ID as the sender's.
- ❑ To receive a message sent by Default ID Polling Transmission or Override ID Polling Transmission, the sender must use a machine of the same make that has polling capability. With Free Polling Reception, a message can be also received from other manufacturer's machines as long as they have a polling capability.

## 📝 Note

- ❑ A Polling ID may be any four digits numbers (0 to 9) and characters (A to F) except 0000 and FFFF.

## 🔍 Reference

p.22 "Polling Transmission"

## 1 Press [Mode].

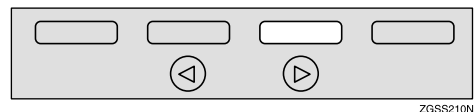
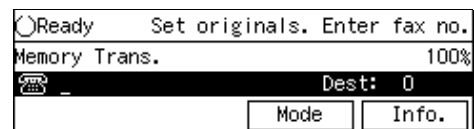

The Transmission Mode menu appears.

**2** Enter the code for "Polling RX" with the number keys.

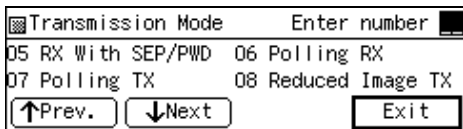

**Note**

❑ If "Polling RX" is not displayed, press [**Prev.**] or [**Next**] until it is.

**3** Depending on which method you are using, choose one of the following procedures:

**Secured Polling Reception**

**1** Press [**Left**] or [**Right**] key to select "Default ID".

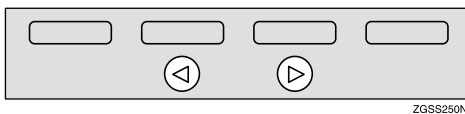
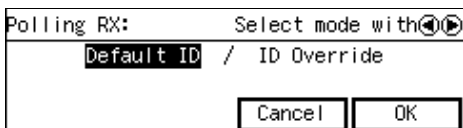

ZGSS250N

**Stored ID Override Polling Reception**

**1** Press [**Left**] or [**Right**] key to select "ID Override".

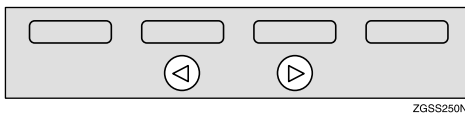
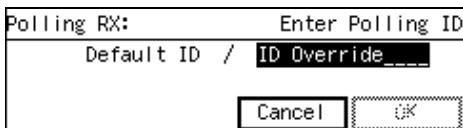

ZGSS250N

**2** Enter a Polling ID (4 characters) with the number keys and Quick Dial keys A-F.

**Note**

❑ If you incorrectly enter the ID, press the [**Clear**] key or [**Stop**] key and try again.

**4** Press [**OK**].

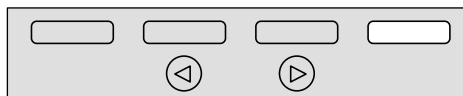
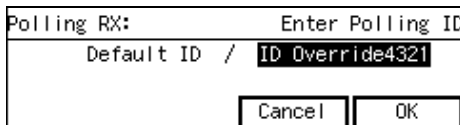

ZGSS220N

The Transmission Mode menu is shown. A check mark is added to Polling Reception.

**Note**

❑ To cancel Polling Reception, press [**Cancel**]. The Transmission Mode menu is shown.

**5** Press [**Exit**].

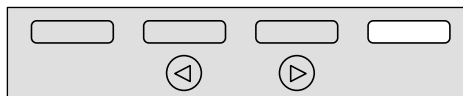
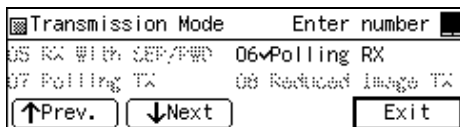

ZGSS220N

The following display is shown.

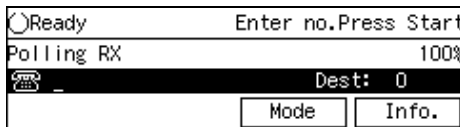

**Note**

❑ "Polling RX" is displayed.



**6** Dial, and then press the **[Start]** key.

 **Note**

- You can cancel Polling Reception. See p.35 “Canceling a Transmission or Reception” .

 **Polling Documents from Other Manufacturers' Fax Machines**

Standard Polling Reception only works with machines of the same make that have the Polling Reception feature. However, if the other party's fax machine supports SEP Transmission, you can receive documents from them using SUB/SEP Reception.

 **Reference**

- p.22 “Polling Transmission”
- p.80 “SEP/PWD (SEP Code Polling Transmission)”
- p.13 “SUB Code Transmission with the Mode Key”

## File Reserve Report (Polling Reception)

This report is printed after Polling Reception has been set up.

 **Note**

- You can turn this function on or off with User Parameters. See p.178 “User Parameters”(switch 03 bit 3).

## Communication Result Report (Polling Reception)

This report is printed after a Polling Reception has been completed and shows the result of the Polling Reception.

 **Note**

- You can also check the result of a Polling Reception with the Journal. See p.50 “Printing the Journal”.
- You can turn this function on or off with User Parameters. See p.178 “User Parameters”(switch 03 bit 4).

# Polling Transmission

1

Use Polling Transmission when you wish to leave a document in the machine's memory for others to pick up. The message will be sent when the other party calls your machine.

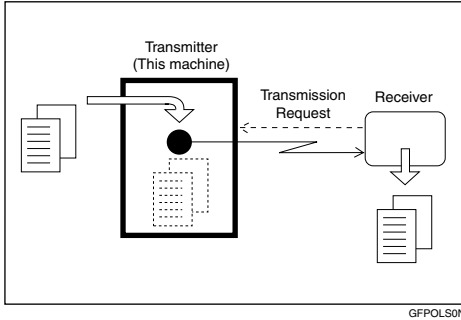

There are three types of Polling Transmission.

## ❖ Secured Polling Transmission

The message will only be sent if the Polling ID of the machine trying to poll your message is the same as the Polling ID stored in your machine. Make sure that both machines' Polling IDs are identical in advance.

## ❖ Free Polling Transmission

Anybody can poll the message from your machine. The machine sends it regardless of whether Polling IDs match.

## ❖ Secured ID Override Polling Transmission

You must enter an Override Polling ID unique to this transmission. This ID overrides in the Polling ID. The user must supply this ID when they poll your machine, and if the IDs match, the message will be sent. Make sure the other party knows the ID you are using in advance.

## 📁 Preparation

Before using Polling Reception, you must store the Polling ID in your machine. See p.199 "Registering ID Codes".

## ⚠️ Limitation

- ❑ Polling Transmission is allowed only if the receiver's machine has the Polling Reception feature.
- ❑ With Free Polling, a message can also be sent to other manufacturer's machines as long as they have the Polling Reception feature. With Default ID and Override ID Polling Transmission, a document can be sent only to a machine of the same make with the Polling Reception feature.

## 📝 Note

- ❑ A Polling ID may be any string of four-digit numbers (0 to 9) and characters (A to F) except 0000 and FFFF.
- ❑ Free Polling and Default ID Polling Transmission allow only one file to be stored in memory each.
- ❑ Override ID Polling Transmission allows a file to be stored in memory for each ID; a total of up to 250 files for varying IDs can be stored.
- ❑ The communication fee is charged to the receiver.
- ❑ Documents that have been stored in memory and are awaiting Polling Transmission can be deleted or printed out. See p.35 "Checking and Canceling Transmission Files".

**1** Set the original and select any scan settings you require.

**2** Press [Mode].

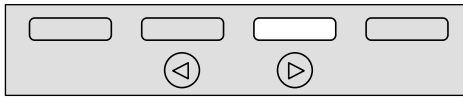
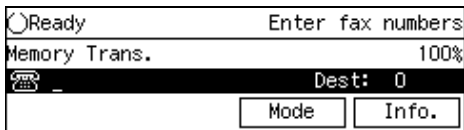

ZGSS210N

The Transmission Mode menu appears.

**3** Enter the code for "Polling TX" with the number keys.

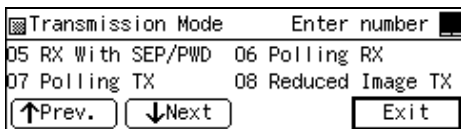

#### Note

- If "Polling TX" is not displayed, press [**Prev.**] or [**Next**] until it is.

**4** Depending on the Polling Transmission type, use one of the following procedures:

#### Secured Polling Transmission

**1** Press **◀** or **▶** key to select "Default ID".

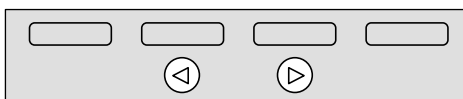
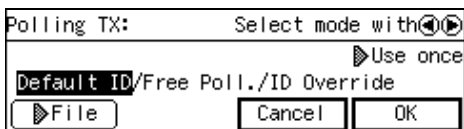

ZGSS250N

#### Free Polling Transmission

**1** Press **◀** or **▶** key to select "Free Poll.".

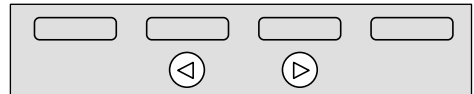
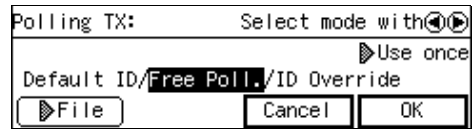

ZGSS250N

#### Stored ID Override Polling Transmission

**1** Press **◀** or **▶** key to select "ID Override".

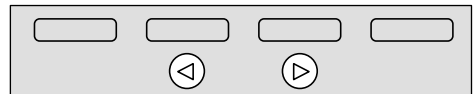
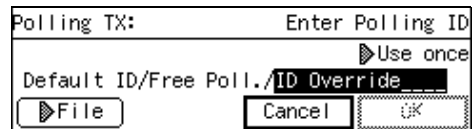

ZGSS250N

**2** Enter the four character Polling ID with the number keys and Quick Dial keys A-F.

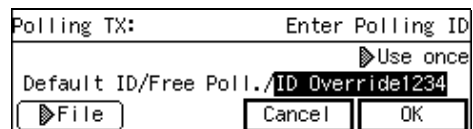

#### Note

- If you incorrectly enter the ID, press the **[Clear]** key or **[Stop]** key and try again.

- 5** Press [▶File] to specify whether to save the stored original or not.

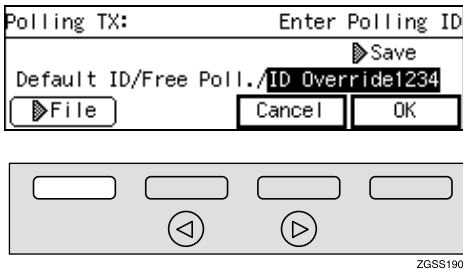

Each time you press the key, the text at the middle right corner of the display switches between "Save" and "Use once".

**Note**

- To delete the document immediately after transmission, select "Use once". To repeatedly send the document, select "Save".
- You can set "Use once" or "Save" to be shown first on the display with User Parameters. See p.178 "User Parameters"(switch 11 bit 7).

- 6** Press [OK].

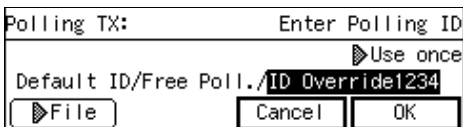

The Transmission Mode menu is shown. A check mark is added to "Polling TX".

**Note**

- To cancel the Polling Transmission, press [Cancel]. The Transmission Mode menu is shown.

- 7** Press [Exit].

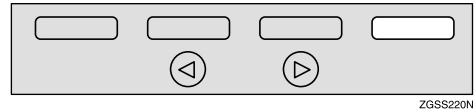
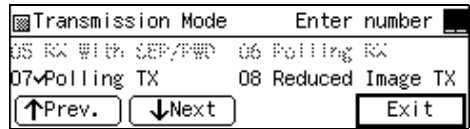

The standby display is shown.

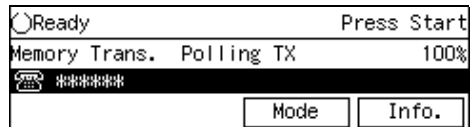

**Note**

- "Polling TX" is displayed. If you set up other transmission mode functions (except Polling Reception), "Others" is displayed.

- 8** Press the [Start] key.

Your document is scanned in.

**Note**

- You can cancel transmission of a message set up for Polling Transmission. See p.35 "Canceling a Transmission or Reception".

## Polling Documents to Other Manufacturers' Fax Machines

Standard Polling Transmission only works with machines of the same make that have the Polling Reception feature. However, if the other party's fax machine supports Polling Reception and SEP Transmission, you can send documents with the Polling ID to them.

### Reference

p.80 "SEP/PWD (SEP Code Polling Transmission)"

p.78 "SUB/SID (SUB Code Transmission)"

- You can also check the result of a Polling Transmission with the Journal. See p.50 "Printing the Journal" .

1

---

## Polling Transmission Clear Report

---

This report allows you to verify whether Polling Transmission has taken place.

### Limitation

- This report is not printed if User Parameters are set to allow the stored documents to be repeatedly sent ("Save"). See p.22 "Polling Transmission" .

### Note

- You can turn this function on or off with User Parameters. See p.178 "User Parameters" (switch 03 bit 6).
- You can set whether a portion of the sent image is printed on the report with User Parameters. See p.178 "User Parameters" (switch 04 bit 7).

# Reduced Image Transmission

1

You can reduce the document image slightly to 93% of the original image by using this feature so that there is extra space on the left edge when the image is printed out by the other party's fax machine. This space is useful when making holes for filing purposes.

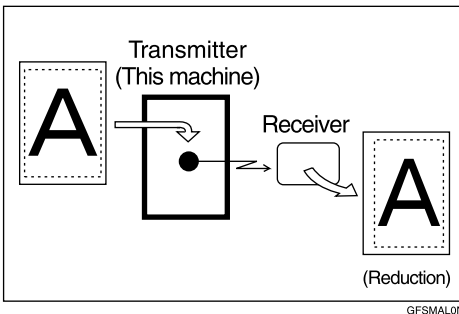

## Limitation

- If you set "Auto Reduction (TX)" off with User Parameters (switch 07 bit 3), the Reduced Image function is not available.

## Note

- The document image is reduced vertically in the direction in which the original is fed into the machine.
- Documents attached to a fax message using the Auto Document function are not reduced.
- The Fax Header or Label Insertion printed out at the other end is not reduced by this function.
- If the Auto Reduction function is specified, the document image is reduced to 93% or less of the original.

## Reference

- p.145 "Registering Auto Documents"
- p.32 "Fax Header Print"
- p.98 "Label Insertion"
- p.93 "Auto Reduction"

**1** Set the original and select any scan settings you require.

**2** Press [Mode].

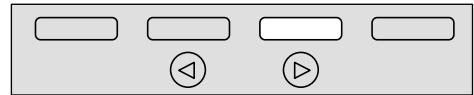
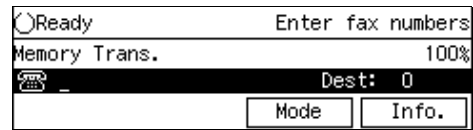

ZGSS210N

The Transmission Mode menu appears.

**3** Enter the code for "Reduced Image TX" with the number keys.

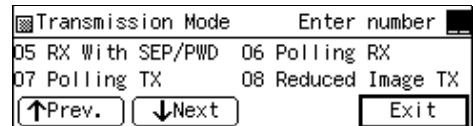

## Note

- If "Reduced Image TX" is not displayed, press [↑Prev.] or [↓Next] until it is.

- 4** Press **◀** or **▶** key to switch Reduced Image on or off.

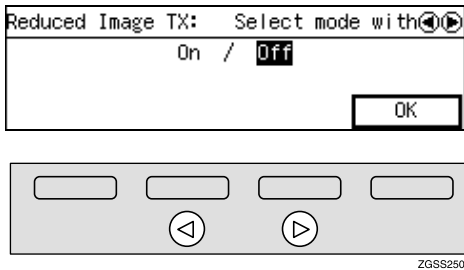

**Note**

- To cancel changes to the Reduced Image setting, press **[OK]** without making changes to the setting. The Transmission Mode menu is shown.

- 5** Press **[OK]**.

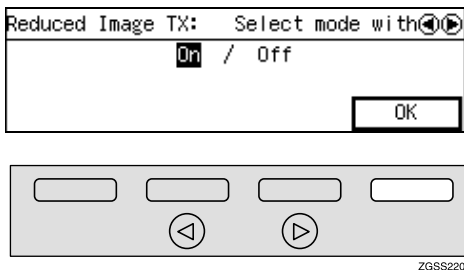

The Transmission Mode menu is shown. A check mark appears next to "Reduced Image TX".

- 6** Press **[Exit]**.

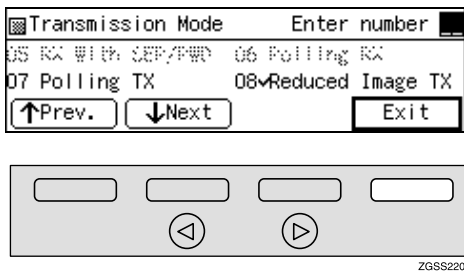

The standby display is shown.

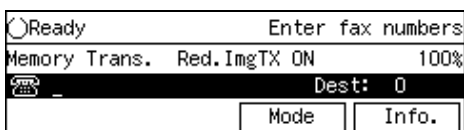

**Note**

- "Red.ImgTX ON" is shown. If you set up other transmission mode functions (except Polling Reception), "Others" is shown.

- 7** Dial, and then press the **[Start]** key.

# Transfer Request

1

Transfer Request allows fax machines to automatically distribute incoming messages to multiple fax destinations. This feature helps you reduce costs when you send the same message to more than one place in a distant area, and saves time since many messages can be sent in a single operation.

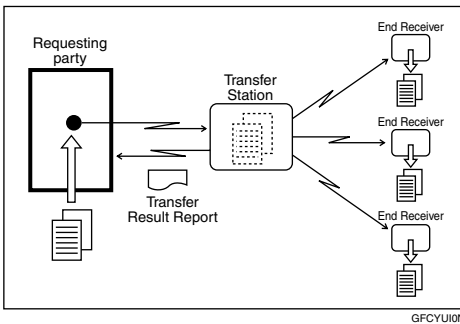

The following terminology is used in this section.

## ❖ Requesting Party

The machine where the message originates from.

## ❖ Transfer Station

The machine that forwards the incoming message to another destination.

## ❖ End Receiver

The final destination of the message.

## 📁 Preparation

Before you can use this feature you must program the Polling ID and set the Transfer Report. See p.199 "Registering ID Codes" and p.202 "Transfer Report".

## 📌 Limitation

- ❑ The Transfer Stations you specify must be machines of the same make as this machine and have the Transfer Station function.
- ❑ This function is not available unless the End Receiver's fax number is stored in either a Quick Dial key or Speed Dial of the Transfer Station.
- ❑ This function is not available unless the Transfer Station's fax number is stored in either a Quick Dial key or Speed Dial of the Requesting Party's machine (this machine).
- ❑ Make sure that the return address is set up correctly in the Transfer Station's machine to use this function.

## 📝 Note

- ❑ You can specify up to 100 Transfer Stations and 30 End Receivers in a Transfer Request.
- ❑ When you specify Group Dials stored in the Transfer Station as receivers, one Group Dial is counted as one End Receiver.
- ❑ Polling IDs of the requesting party (this machine) and Transfer Stations must be identical.

- 1** Set the original and select any scan settings you require.

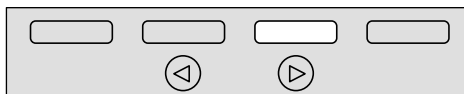
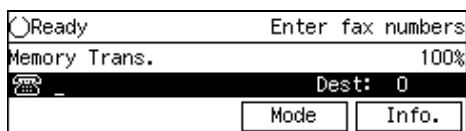

**2** Press [Mode].

ZGSS210N

The Transmission Mode menu appears.

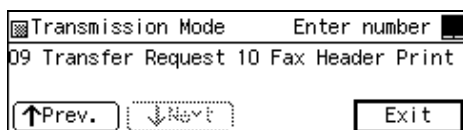
**3** Enter the code for "Transfer Request" with the number keys.**Note**

- If "Transfer Request" is not displayed, press [↑Prev.] or [↓Next] until it is.

**4** Enter a Transfer Station.**Note**

- You cannot specify a Transfer Station and a normal fax destination at the same time.
- Enter the fax numbers of the Transfer Stations with either Quick Dial keys, Speed Dials or the number keys. See p.46 "Dialing", <Basic Features>.
- If you make a mistake, press the **[Clear]** key or **[Stop]** key and try again.
- To cancel the Transfer Request, press **[Cancel]**. The Transmission Mode menu is shown again.

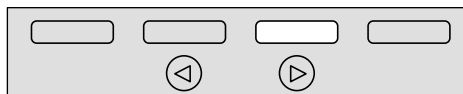
**5** Press [Recv. Stn].

ZGSS210N

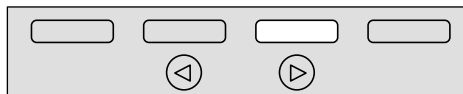
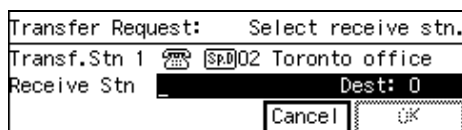
**6** Enter one or more End Receivers.

ZGSS210N

**Note**

- The numbers must be stored in Quick Dial keys, Speed Dials or Groups in the Transfer Station(s).

**Reference**

p.31 "Specifying an End Receiver"

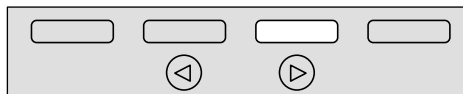
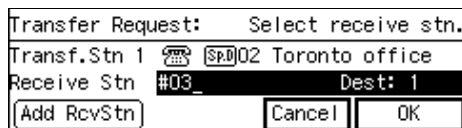
**7** When you have specified all the End Receivers, press [OK].

ZGSS210N

**Note**

- To cancel the Transfer Request, press **[Cancel]**. The Transmission Mode menu is shown again.

1

1

**8** When you have specified all the Transfer Stations, press **[No]**.



**Note**  
 If you wish to enter an additional Transfer Station, press **[Enter]** and repeat steps **4** to **6**.

Transmission Mode menu is shown and a check mark is added to Transfer Request.

**9** Press **[Exit]**.

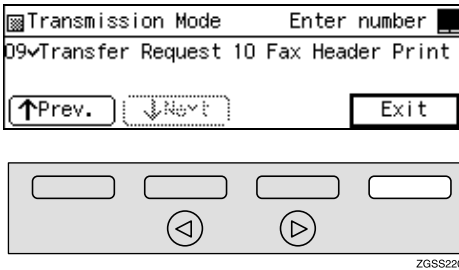

The following display is shown.

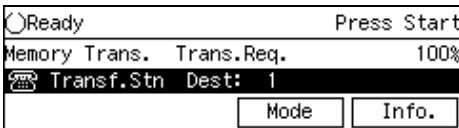

**Note**  
 "Trans.Req." is shown. If you set up other transmission mode functions (except Polling Reception), "Others " is shown.  
 The numbers of Transfer Stations are displayed.

**10** Press the **[Start]** key.

**Note**  
 You can cancel transmission of a message set up for Transfer Request. See p.35 "Canceling a Transmission or Reception" .

### Transfer Request to Other Manufacturers' Fax Machines

Transfer Request only works with machines of the same make that have the Transfer Station function. However, you can specify other manufacturers' fax machines as the Transfer Station if they support a similar function to this, with the SUB Code Transmission function. Make sure the other party supports this function before making a Transfer Request. See p.13 "SUB Code Transmission with the Mode Key".

## Specifying an End Receiver

When you make a Transfer Request, you must specify the final destinations (End Receivers) for your message.

You cannot enter the numbers of the End Receivers directly. Instead, enter a simple code that describes where the numbers are stored in the Transfer Station (in Quick Dial keys, Speed Dials or Groups).

The numbers must first have been stored in Quick Dial keys, Speed Dials or Groups in the Transfer Station(s).

### ❖ Quick Dial

Enter **【#】** followed by the number (3 digits) of the Quick Dial where the End Receiver is stored.

For example, to choose the number stored in Quick Dial 001 in the Transfer Station, enter:

**【#】【0】【0】【1】.**

#### Note

- ❑ If the End Receivers only support 2 digits for the Quick Dials, enter the number with 2 digits like **【#】【0】【1】.**

### ❖ Speed Dial

Enter **【#】**, **【\*】** followed by the Speed Dial code (2 or 3 digits).

For example, to choose the number stored in Speed Dial 012 in the Transfer Station, enter: **【#】【\*】**

**【0】【1】【2】**

#### Note

- ❑ If the End Receivers only support 2 digits for the Speed Dials, enter the number with 2 digits like **【#】【\*】【1】【2】.**

- ❑ You need to install Optional Function Upgrade Unit to enter 3 digits code for the Speed Dial.

### ❖ Group Dial

Enter **【#】**, **【\*】**, **【\*】** followed by the Group number (2 digits).

For example, to choose the number stored in Group 04 in the Transfer Station, enter: **【#】【\*】【\*】【0】**  
**【4】.**

# Fax Header Print

1

Normally, the Fax Header programmed in your machine is printed at the top of each of the pages you transmit when they are received at the other end. The top of the image will be overprinted if there is no margin at the top of the transmitted page.

## Important

- ❑ In the USA, the Fax Header must contain the telephone number of the line your machine is connected to. It will be printed on the header of every page you send. Required in the USA.

## Note

- ❑ In the USA, law requires that your fax number be included in the fax Header. Register the fax number and switch on Fax Header Print with User Parameters. See p.178 "User Parameters".
- ❑ You can turn the Fax Header Print function on or off by pressing the User Function key that this function is assigned to. By default, this function is assigned to **[F2]**. See p.154 "User Function Keys".
- ❑ You can set the machine so that it prints the Fax Header on the message when it is received on the other end with User Parameters. It is handy to set this function to the option more frequently used, then when necessary, you can change the setting back with this feature. See p.178 "User Parameters" (switch 06 bit 0).

- ❑ The Fax Header Print function is intended for G3 communication, however, you can switch this function on for G4 communication as well with User Parameters. See p.178 "User Parameters" (switch 06 bit 3).

- ❑ You can set your machine's internal clock to the current time and date. See p.151 "Date/Time".

**1** Set the original and select any scan settings as necessary.

**2** Press [Mode].

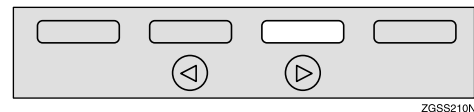
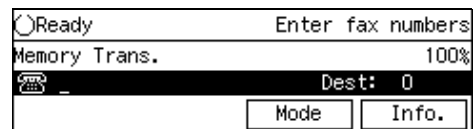

ZGSS210N

The Transmission Mode menu appears.

**3** Enter the code for "Fax Header Print" with the number keys.

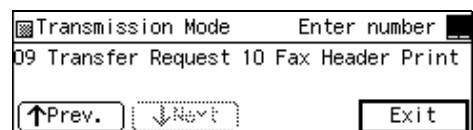

## Note

- ❑ If "Fax Header Print" is not shown, press [**Prev.**] or [**Next**].

- 4** Press **◀** or **▶** key to switch Fax Header Print on or off.

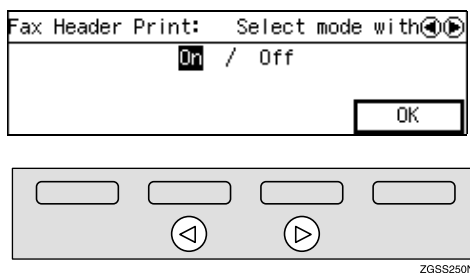

**Note**

- Press **[OK]** to cancel switching the setting and return to the step **3** display.

- 5** Press **[OK]**.

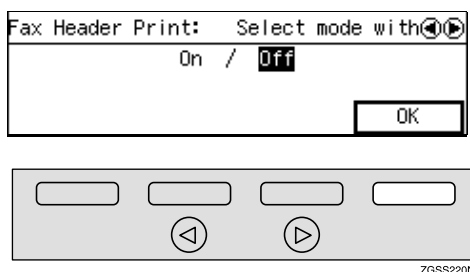

The Transmission Mode menu is shown. A check mark is added to Options.

- 6** Press **[Exit]**.

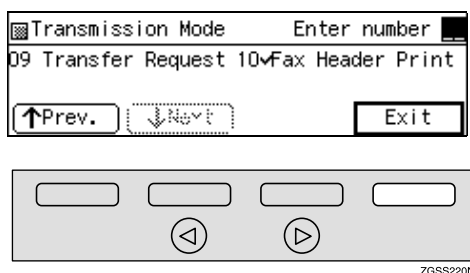

"Header OFF" is shown.

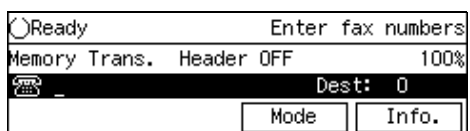

**Note**

- "Header ON" or "Header OFF" is shown when the Fax Header Print function is switched on or off respectively with User Parameters. If you set up other advanced transmissions functions (except Polling Reception), "Others" is shown.

- 7** Dial, and then press the **[Start]** key.



# 2. Communication Information

## Checking and Canceling Transmission Files

You can cancel a transmission or reception that is in progress, or delete the Transmission files that have been stored in memory and are awaiting transmission.

With this feature, you can also print a file (document), check or edit destination(s), and check or alter the transmission time.

This section describes how you can:

### ❖ **Cancel a Transmission**

You can cancel the transmission files that have been stored in memory and are awaiting transmission, or the files that have failed to be transmitted. If you notice an error in the destination specified or the document content after scanning a document into memory, you can cancel transmission of that document. See p.35 "Canceling a Transmission or Reception".

### ❖ **Cancel a Reception**

You can cancel reception in progress. See p.35 "Canceling a Transmission or Reception".

### ❖ **Print a File**

You can print and check the contents of a fax that is stored in memory and has not been sent yet. See p.37 "Printing a Stored Message".

### ❖ **Check and Edit a File**

You can check or edit destination(s), check options selected or alter the transmission time.

You can also resend a fax that has failed to be transmitted. See p.38 "Checking and Editing a File".

---

## Canceling a Transmission or Reception

---

You can cancel the transmission files that have been stored in memory and are awaiting transmission, or the files that have failed to be transmitted. If you notice an error in the destination specified or the document content after scanning a document into memory, you can cancel transmission of that document. This is done by searching for the document in the fax machine's memory and deleting it.

Also, you can cancel a reception in progress.

This function can be performed for Memory Transmission, Confidential Transmission, Transfer Request, Polling Reception, and Polling Transmission.

### **Note**

- If you cancel a file being sent, the communication is immediately stopped and canceled. A page which has already been sent cannot be canceled.
- Files that are produced from Transfer Request or Forwarding cannot be canceled.

**1** Press [Info.].

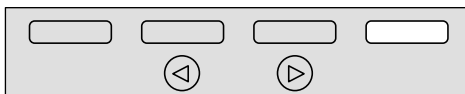
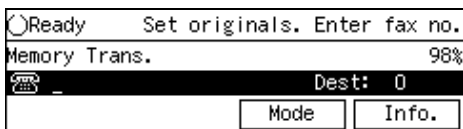

ZGSS220N

The "Information" menu is shown.

**2** Enter the code for "Check/Cancel Files" with the number keys.

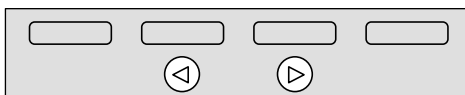

ZGSS250N

**3** Press ◀ or ▶ key until the file you wish to delete is shown.

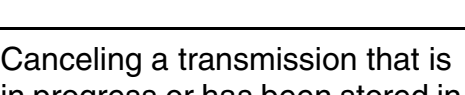
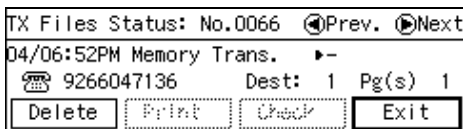

ZGSS190N

Canceling a transmission that is in progress or has been stored in memory

**1** Press [Delete].

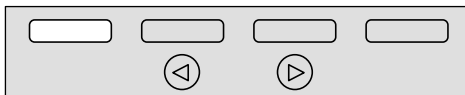
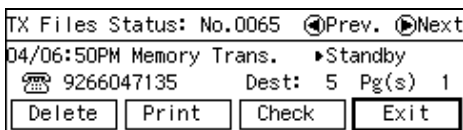

ZGSS190N

**2** Press [Yes].

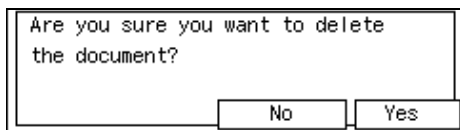

ZGSS220N

The file is erased.

**Note**

- Press [No] to cancel the operation and return to the step 8 display.
- To delete another file, select the file by pressing the ◀ or ▶ key, then repeat the same steps.

Canceling a reception that is in progress

**1** Press [Stop].

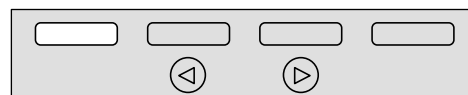
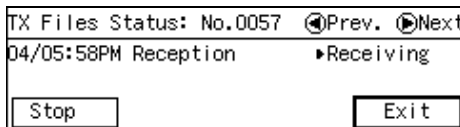

ZGSS190N

**2** Press [Yes].

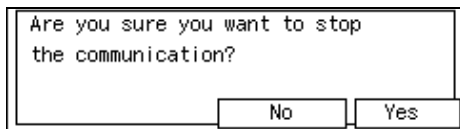

ZGSS220N

Transmission is canceled.



**Note**

- ❑ Press **[No]** to cancel the operation and return to the step **3** display.
- ❑ To delete another file, select the file by pressing the **◀** or **▶** key, then repeat the same steps.

**4** Press **[Exit]**.

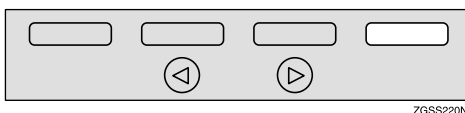

ZGSS220N

The standby display is shown.

## Printing a Stored Message

If you wish to check the contents of a fax stored in memory and not sent yet, use this procedure to print it out.

This function can be performed for files produced by Memory Transmission, Transfer Request, Polling Transmission, files received by Transfer Request from other Requesting Parties, or files awaiting Forwarding.

**1** Press **[Info.]**.

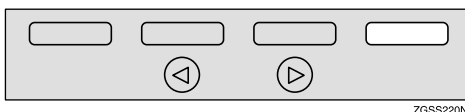
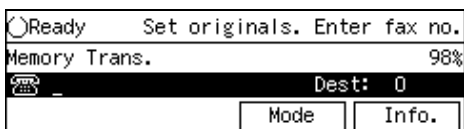

ZGSS220N

The "Information" menu is shown.

**2** Enter the code for "Check/Cancel Files" with the number keys.



**3** Press the **◀** or **▶** key until the file you wish to print is shown.

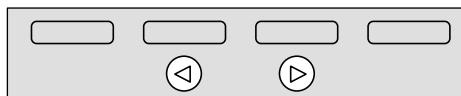
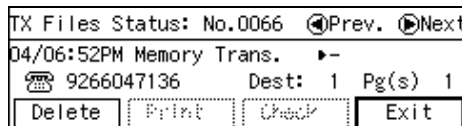

ZGSS250N

**4** Press **[Print]**.

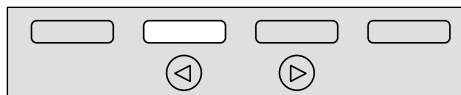
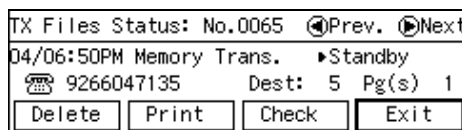

ZGSS200N

**5** Press the **[Start]** key.

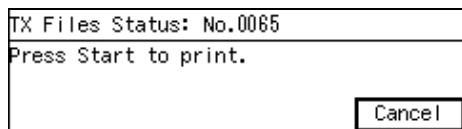

The file is printed.

**Note**

- ❑ Press **[Cancel]** to stop printing the file and return to step **4** display.

**6** Press [Exit].

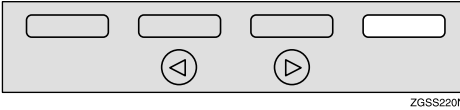
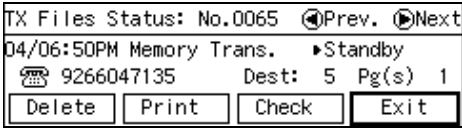

The "Information" menu is shown again.

**Note**

- To print another file, select the file by pressing the ◀ or ▶ key, then repeat the same steps.

**7** Press [Exit].

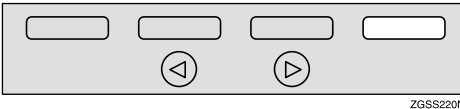

The standby display is shown.

## Checking and Editing a File

Use this procedure to check or edit destination(s), check options selected or alter the transmission time.

This function can be performed for the files produced by Memory Transmission, Confidential Transmission, Transfer Request and Polling Reception.

You can check or change the following items:

- **Destination List**  
This list shows all the destinations specified for the transmission.
- **Changing a destination**  
You can change or edit the destinations of the file. However, you cannot change the destinations of files for Transfer Request or Confidential Transmission.
- **Changing the transmission time/ Re-sending a file**  
You can alter the transmission time. Also, if there are any failed transmission files in Memory Transmission, you can choose to resend them.

**Preparation**

Be sure to set the File Retention function to either "24 hours" or "72 hours" to resend the failed transmission files beforehand. See p.201 "File Retention".

**Note**

- You cannot set or change the transmission time, or delete or add destinations when the file is being sent or received.
- Files that have been received by Transfer Request from other Requesting Parties cannot be viewed or edited.

**1** Press [Info.].

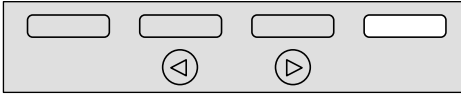
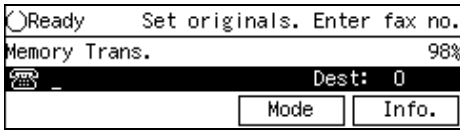

ZGSS220N

The "Information" menu is shown.

**2** Enter the code for "Check/Cancel Files" with the number keys.



**3** Press the ⏪ or ⏩ key until the file you wish to print is shown.

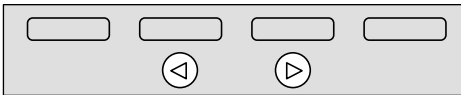
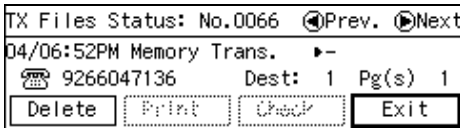

ZGSS250N

**4** Press [Check].

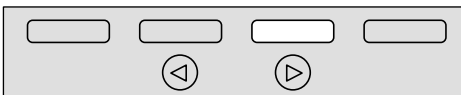
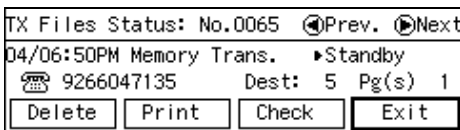

ZGSS210N

**5** Depending on the setting you wish to check or change, use one of the following procedures:

Checking destinations  
(Destination List)

**1** Enter the code for "Destination List" with the number keys.

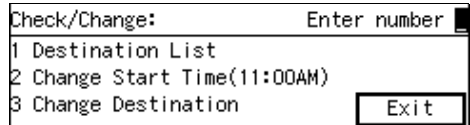

The total number of destinations and the fax number or each destination's name is shown.

**2** Press [Exit].

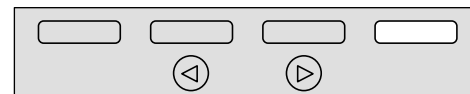
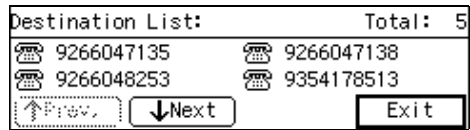

ZGSS220N

**Note**

To see hidden destinations, press [↑Prev.] or [↓Next].

**3** Press [Exit].

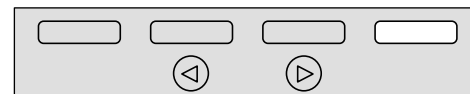
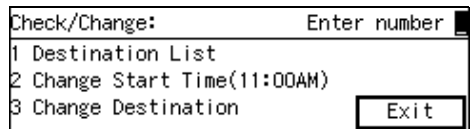

ZGSS220N

2

### Changing the transmission time

1 Enter the code for "Change Start Time" with the number keys.

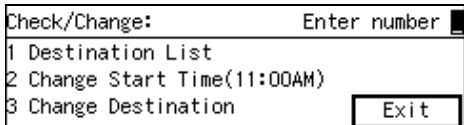

2 Enter the transmission time (four digits) with the number keys.

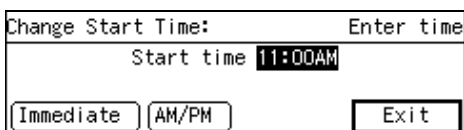

Press [AM/PM] to switch between AM and PM. To clear the entries, press the [Clear] key or [Stop] key.

**Note**

- You cannot specify a start time more than 24 hours into the future.
- The current time does not appear on the display.
- To start transmission immediately, press [Immediate]. If memory contains other files queued for transmission, those files are sent first.

3 Press [Exit].

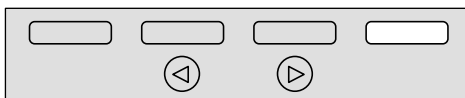
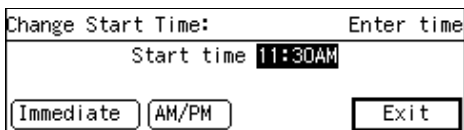

ZGSS220N

4 Press [Exit].

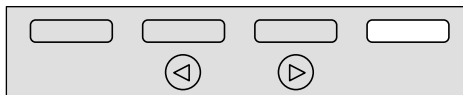
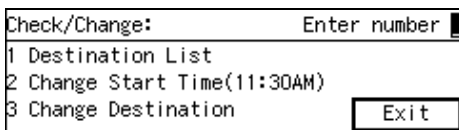

ZGSS220N

### Re-sending a file

1 Enter the code for "Retransmit" with the number keys.

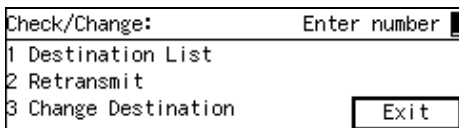

2 Press [Yes].

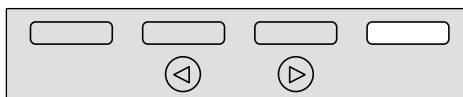
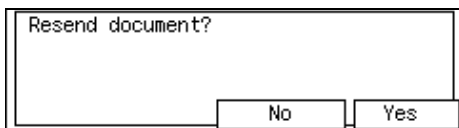

ZGSS220N

**Note**

- If you do not wish to send the file, press [No] to return to step 1.

3 Enter the code for "Change Start Time" with the number keys.

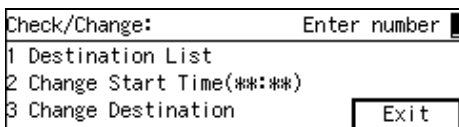

**4 Enter the start time with the number keys.**

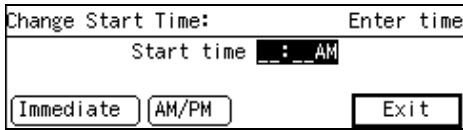

Press **[AM/PM]** to switch between AM and PM.

**Note**

- You cannot specify a start time more than 24 hours into the future.
- To start transmission immediately, press **[Immediate]**. If memory contains other files queued for transmission, those files are sent first.

**5 Press [Exit].**

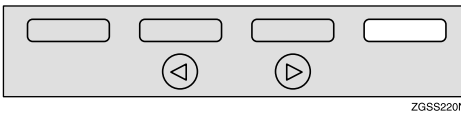
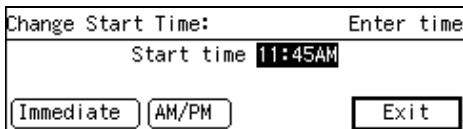

ZGSS220N

**6 Press [Exit].**

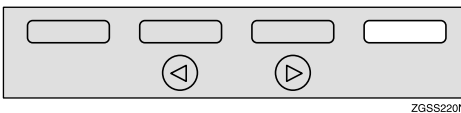
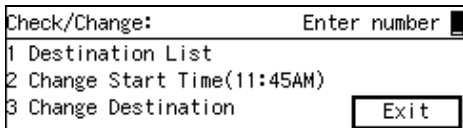

ZGSS220N

**Changing a destination**

You can delete or add destinations.

**1 Enter the code for "Change Destination" with the number keys.**

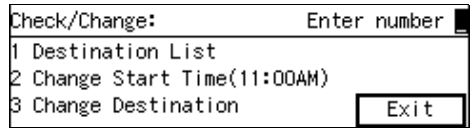

**2 Change the destination.**

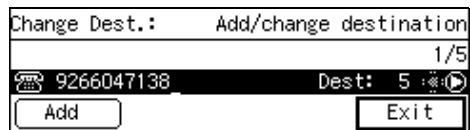

**Note**

- To cancel a destination, press the **[Stop]** key or **[Clear]** key.
- To add a destination, press **[Add]** and enter the fax number with the number keys. Destinations can be specified only by using the number keys.
- The destination is added to the end of the list.
- If you change a destination of a file that is automatically being dialed or awaiting redial, redial is canceled so you will need to resend that file.

**3 Press [Exit].**

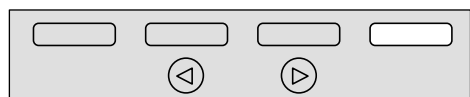
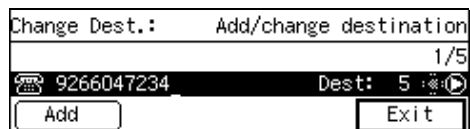

ZGSS220N

**4 Press [Exit].**

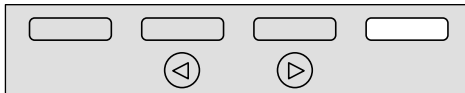
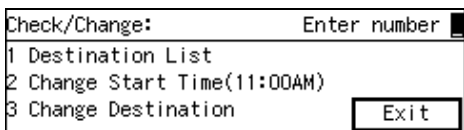

ZGSS220N

**6 Press [Exit].**

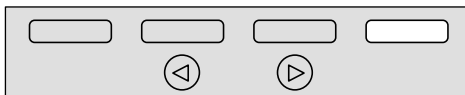
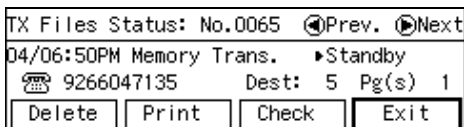

ZGSS220N

The "Information" menu is shown.

**7 Press [Exit].**

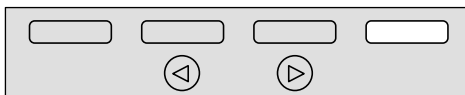

ZGSS220N

The standby display is shown.

# Printing a List of Files in Memory (Print TX File List)

Print this list if you wish to find out which files are stored in memory and what their file numbers are. Knowing the file number can be useful (for example, when erasing files).

**Note**

- You can also print this list with Displaying the Files in Memory function. See p.56 "Displaying the Files in Memory".
- The contents of a document stored in memory can also be printed. See p.37 "Printing a Stored Message".

**1 Press [Info.].**

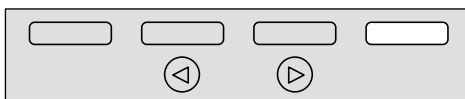
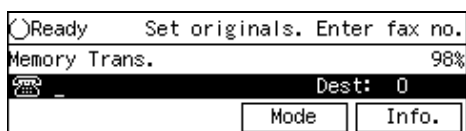

ZGSS220N

The "Information" menu is displayed.

**2 Enter the code for "Print TX File list" with the number keys.**



**3 Press the [Start] key.**

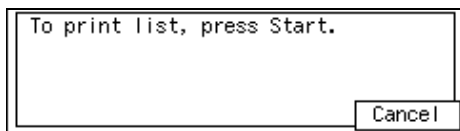

The Transmission File List is printed. When the printing is completed, the "Information" menu is shown.

**Note**

- Press [Cancel] to stop printing the file list and return to the "Information" menu.

**4 Press [Exit].**

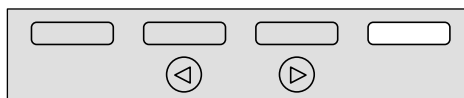

ZGSS220N

The standby display is shown.

# Checking the Transmission Result (TX Status)

If you wish to find out whether a file was sent successfully, you don't have to always print the Journal. With this function you can browse through the last 250 completed transmissions on the display.

### Note

- ❑ If a transmission is completed while you are using this function, the result will not be shown until you exit TX Status and start it again.
- ❑ Only the last 250 transmissions are shown. Earlier transmissions are not available.
- ❑ When the optional Function Upgrade card is installed, you can check up to 1,000 communications.

## 1 Press [Info.].

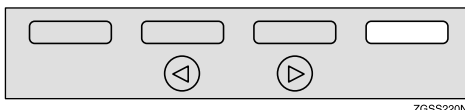
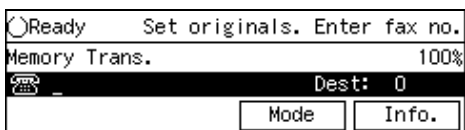

The "Information" menu is shown.

## 2 Enter the code for "TX Files Status" with the number keys.

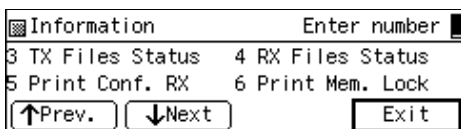

### Note

- ❑ If "TX Files Status" is not shown, press [Prev.] or [Next].

## 3 When you have finished, press [OK].

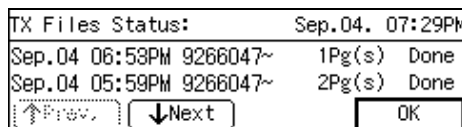

### Note

- ❑ The results are shown two at a time with the most recent above.
- ❑ Press [Prev.] or [Next] to scroll through the list.

## 4 Press [Exit].

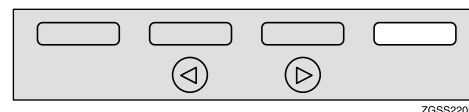
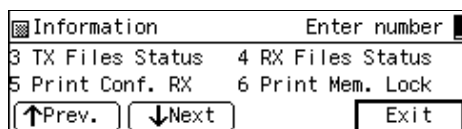

The standby display is shown.



# Checking the Reception Result (RX Status)

This function lets you check the last 250 messages received without having to print the Journal. You can browse through the received messages on the display.

## Note

- ❑ If a message is received while you are using this function, the result will not be shown until you exit RX File Status and start it again.
- ❑ Only the last 250 messages are displayed. Earlier messages are not available.
- ❑ When the optional Function Upgrade card is installed, you can check up to 1,000 communications.

## 1 Press [Info.].

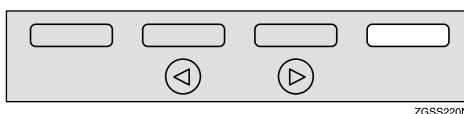
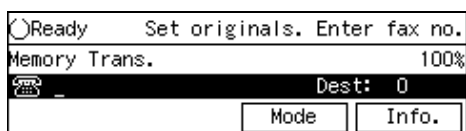

ZGSS220N

The "Information" menu is shown.

## 2 Enter the code for "RX Files Status" with the number keys.

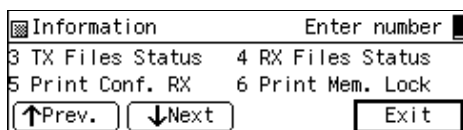

## Note

- ❑ If "RX Files Status" is not shown, press [**Prev.**] or [**Next**].

## 3 When you have finished, press [OK].

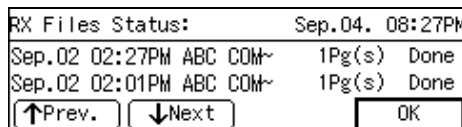

ZGSS220N

## Note

- ❑ The results are shown two at a time with the most recent above.
- ❑ Press [**Prev.**] or [**Next**] to scroll through the messages.

## 4 Press [Exit].

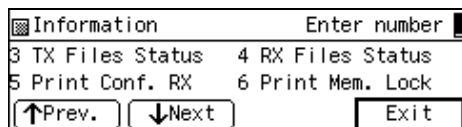

ZGSS220N

The standby display is shown.

## Printing a Confidential Message

This feature is designed to prevent messages being picked up casually by anyone when they are received. If someone sends you a message using Confidential Transmission, it is stored in memory and not automatically printed. To print the message you have to enter the Confidential ID code. When your machine has received a confidential message, the  indicator lights.

### Preparation

Before using this function, program your Confidential ID. See p.199 "Registering ID Codes".

### Important

- If the power switch is off for 12 hours or longer, all Confidential Messages are deleted. In such a case, use the Power Failure Report to identify which messages have been lost. See p.264 "Power Failure Report".

### Note

- When the other party sends you a fax with SUB code, the message is printed by Printing Personal Box Messages function. See p.67 "Printing Personal Box Messages".
- Be sure that the other party enters a SUB code beforehand using up to 20 characters with digits 0-9, #, \* and spaces.

- 1** Make sure that the  indicator is lit.

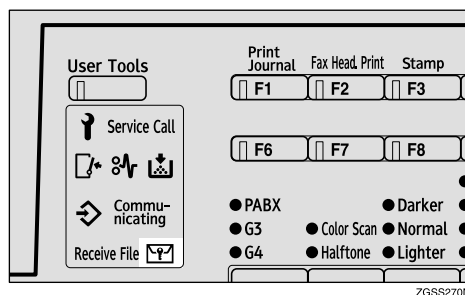

- 2** Press [Info.].

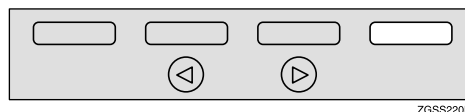
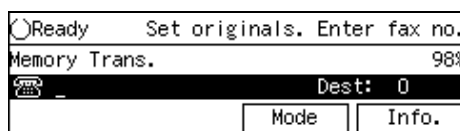

The "Information" menu is shown.

- 3** Enter the code for "Print Conf. RX" with the number keys.

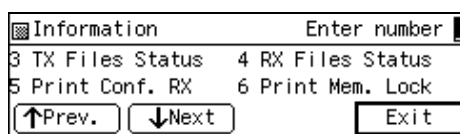

### Note

- If "Print Conf. RX" is not shown, press [**↑**Prev.] or [**↓**Next].

**4** Enter the Confidential ID (4-digit number) with the number keys.

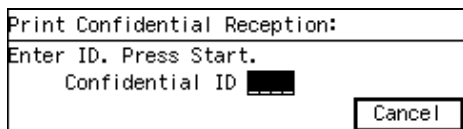

**Note**

- If you receive a fax by Confidential ID Override Reception, enter the override Confidential ID. See p.7 "Sending Confidential Messages".

**5** Press the **[Start]** key.

The received messages are printed. When printing has finished, the "Information" menu is shown.

**Note**

- If no Confidential Messages have been received, the message "No matching file found." is shown.
- If the Confidential IDs or Personal Confidential IDs do not match, the message "No matching file found." is displayed. Press **[Cancel]**, check the Confidential ID or Personal Confidential ID with the other party and try again.

**6** Press **[Exit]**.

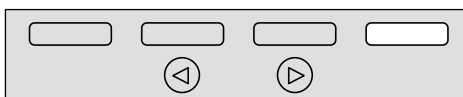
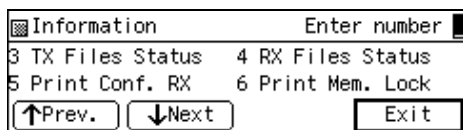

ZGSS220N

The standby display is shown.

## Confidential File Report

You can set whether the machine prints this report whenever your machine receives a Confidential Message.

**Note**

- You can turn this report on or off with User Parameters. See p.178 "User Parameters" (switch 04 bit 0).

# Printing a Memory-locked Message

This is a security feature designed to prevent unauthorized users from reading your messages. If Memory Lock is switched on, all received messages are stored in memory and are not automatically printed. To print the messages, you have to enter the Memory Lock ID code. When your machine has received a message with Memory Lock, the  indicator blinks.

2

## Preparation

Make sure to program your Memory Lock ID beforehand. See p.199 "Registering ID Codes". Also, before you start, turn Memory Lock on with the User Tools. See p.233 "Memory Lock".

## Important

- If the power switch is off for 12 hours or longer, all Confidential Messages are deleted. In such a case, use the Power Failure Report to identify which messages have been lost. See p.264 "Power Failure Report".

## Note

- Messages received by Polling Reception are automatically printed even if this feature is switched on. See p.19 "Polling Reception".
- When your machine does not have enough free memory, you may not be able to receive fax messages with Memory Lock.

- 1** Make sure that the  indicator is blinking.

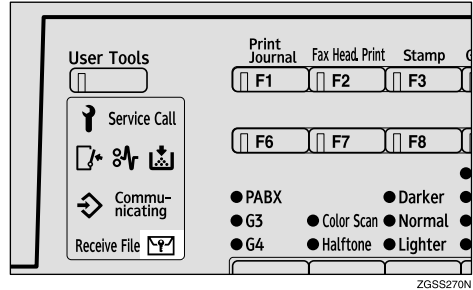

- 2** Press [Info.].

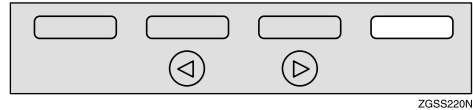
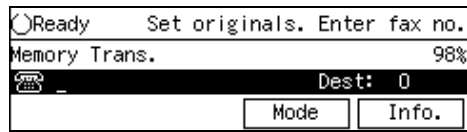

The "Information" menu is shown.

- 3** Enter the code for "Print Mem. Lock" with the number keys.

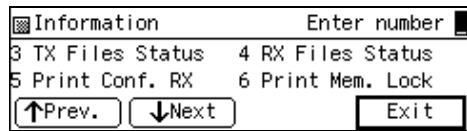

## Note

- If "Print Mem. Lock" is not shown on the display, press [Prev.] or [Next].

- 4** Enter the Memory Lock ID (4-digit number).

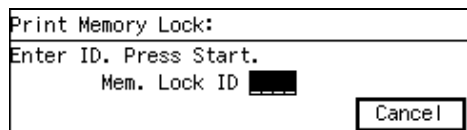

**5** Press the **[Start]** key.

The received messages are printed. When the printing is completed, the "Information" menu is shown.

**Note**

- If no messages have been received, the following message appears: "No matching file found."
- If the Memory Lock IDs do not match, the following message appears: "No matching file found. " Press **[Cancel]** and retry after checking the Memory Lock ID.

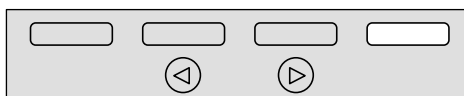
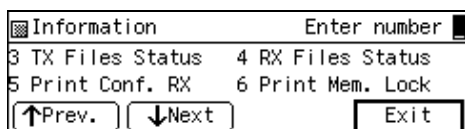
**6** Press **[Exit]** .

ZGSS220N

The standby display is shown.

## Printing the Journal

The Journal contains information on up to 50 of the last communications made by your machine. It is printed automatically after every 50 communications (receptions + transmissions).

You can also print a copy of the Journal at any time by following the procedure below.

### Important

- You cannot re-print the Journal after it has been automatically printed out. We recommend that you keep the Journal printed out automatically to keep track of communication records.

### ❖ All

All communication results are printed in the order of transmission and reception.

### ❖ File No.

Only the communication result of the specified file number is printed.

### ❖ User Code

Only the communication results of the User Code Transmission or the transmission done with the Restricted Access function with the specified User Code (the SUB code of the Personal Box) are printed. See p.10 "User Code Transmission" and p.25 "Restricted Access", <Basic Features>.

### ❖ Date

Only the communication results of the specified date are printed.

### Note

- Only the last 50 transmissions are printed. Earlier transmissions are not available.
- You can browse through up to the last 250 communications on the display. With the optional Function Upgrade Unit installed, you can check up to 1,000 communications.
- The sender's name column of the Journal is useful when you need to register a Specified Sender.
- You can set your machine so that the Journal is printed automatically after every 50 communications (receptions + transmissions) with User Parameters. See p.178 "User Parameters" .
- When the optional Paper Supply Unit is installed, you can specify which tray unit the designated reports or lists are printed out from. However, once a tray unit is specified for the reports or lists printing, that tray will not be able to print any fax messages the machine receives. See p.178 "User Parameters" (switch 19 bits 2, 1, 0).
- You can assign the Printing the Journal function to a User Function key. When shipped, it is assigned to **[F1 Journal]** key.

**1** Press [Info.].

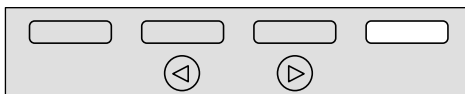
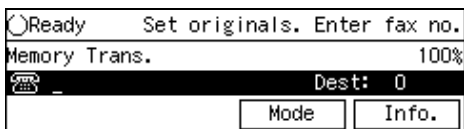

ZGSS220N

The "Information" menu is shown.

**2** Enter the code for "Print Journal" with the number keys.



**Note**

If "Print Journal" is not shown, press [↑Prev.] or [↓Next].

**3** Press [◀] or [▶] key to select the format you require.

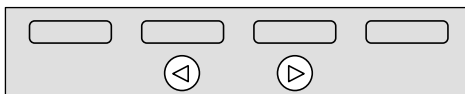
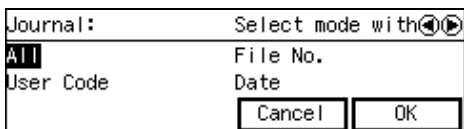

ZGSS250N

When choosing "All"

**1** Press [OK].

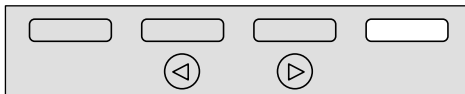
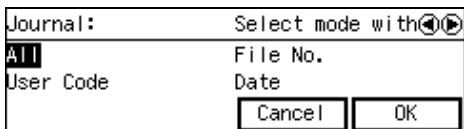

ZGSS220N

When choosing "File No."

**1** Press [OK].

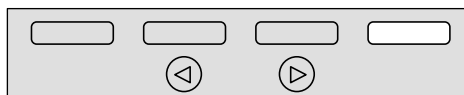
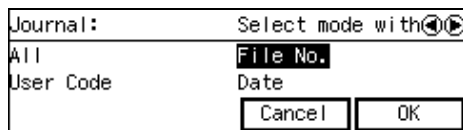

ZGSS220N

**2** Enter a 4-digit file number with the number keys.

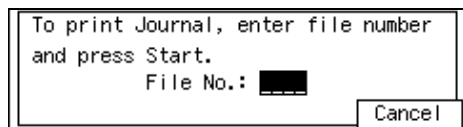

When choosing "User Code"

**1** Press [OK].

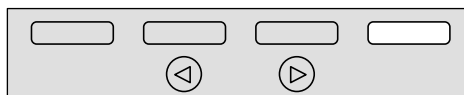
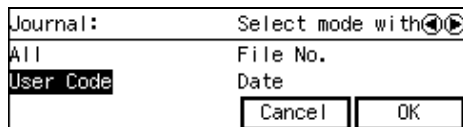

ZGSS220N

**2** Enter a User Code (up to 20 digits) with the number keys.

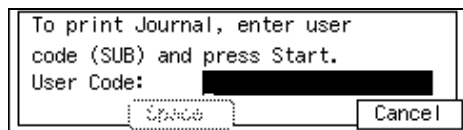

## When choosing "Date"

1 Press [OK].

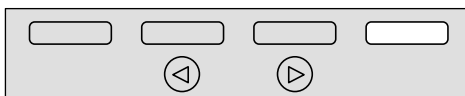
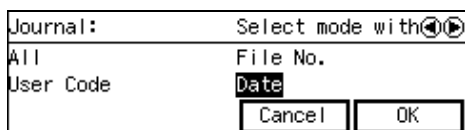

ZGSS220N

2 Select the month using the [↑Month] and [↓Month], press (Right arrow) key, and then enter the date using the number keys.

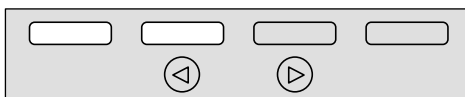
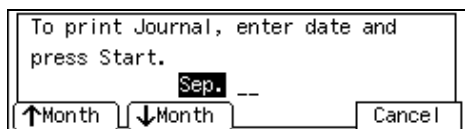

ZGSS230N

4 Press the [Start] key.

The Journal is printed.

**Note**

□ Press [Cancel] to return to step 3.

5 Press [Exit].

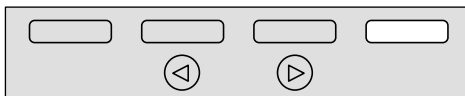
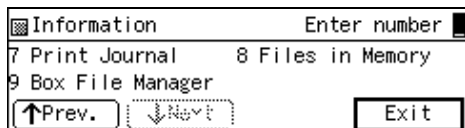

ZGSS220N

The standby display is shown.



## Printing the Journal

You can check the communication results on this report.

 **Note**

- When choosing "File No.", "User Code" or "Date", Personal Journal is printed.
- Communications made after the machine is connected to the line are printed on the Journal.
- You can set the machine to reduce the reports to 91% of the original size when printing with User Parameters. This allows an extra margin which may be useful when filing. See p.178 "User Parameters" (switch 04 bit 5).
- You can select whether or not undelivered messages are to be included on this report with User Parameters. When using the Automatic Redial function, the result of the last dialing is printed.
- Normally, when specifying the destination with a Quick Dial key or Speed Dial, "ADDRESS" on this report shows Own Name or Own Fax Number registered in the receiver's machine. However, you can change the setting with User Parameters so that the name or number of the destination stored in the Quick Dial key or Speed Dial in your machine is printed instead. See p.178 "User Parameters" (switch 04 bit 4).

◆ **All**

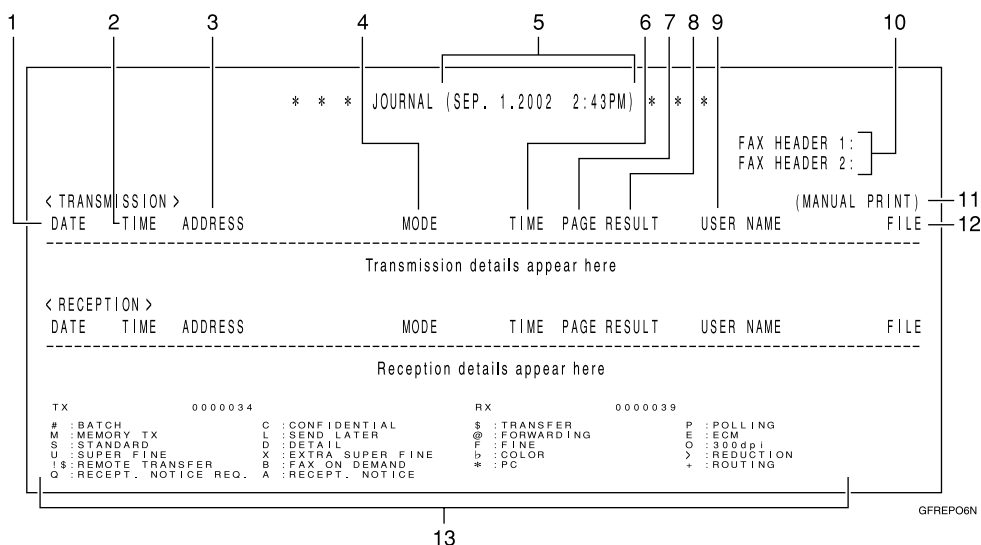

### 1. DATE

The date of the transmission/reception

### 2. TIME

The time when the transmission/reception started

### 3. ADDRESS

The other party's names are printed in the following priority order:

The Priority Order	Address
1	The Own Name registered in the other party's machine <sup>*1</sup>
2	The Own Fax Number registered in the other party's machine <sup>*1</sup>
3	The name stored in the specified Quick Dial key or a Speed Dial
4	The fax number entered manually using the number keys

<sup>\*1</sup> When in the G4 transmission, G4 TID is printed.

When in a transmission, 1 or 2 is printed, however, you can change the priority order to 3, 4, 1, 2 with User Parameters (switch 04 bit 4). See p.178 "User Parameters". When in a reception or a polling transmission, 1 or 2 is printed.

### 4. MODE

The types of the communication mode are printed:

"G3-AT", "G3", "G3-1", "G3-2", "PX-AT", "PX", "PX-1", "PX-2", "I-PX", "I-G3", "G4".

### 5. The time of the output of the Journal

### 6. TIME

The time it took to transmit/receive. When it exceeds 99 minutes 59 seconds, "\*" will be printed instead.

### 7. PAGE

The pages you transmitted or received. When it exceeds 999, "\*\*\*\*" will be printed instead.

### 8. RESULT

OK	Successful communication
E	An error occurred
D	The power was shutdown while the communication. A part of the originals has not been transmitted.

### 9. USER NAME

When in User Code Transmission or the Restricted Access function turned on, the name of the users registered are printed.

### 10. FAX HEADERS

The names or numbers registered under FAX HEADER 1 and FAX HEADER 2 are printed.

### 11. This appears when the Journal was printed manually.

### 12. FILE

The file number of the fax message

### 13. The Footnote on the Journal

Explains the codes printed on the Journal.

◆ Date

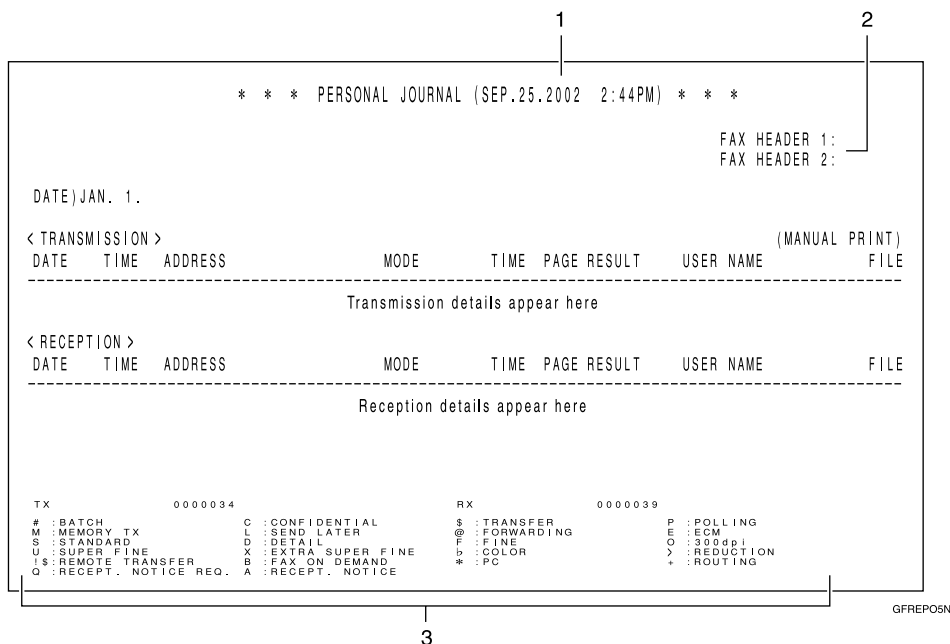

2

**1. The time of the output of the Journal**

**2. FAX HEADERS**

The names or numbers registered under FAX HEADER 1 and FAX HEADER 2 are printed.

**3. The Footnote on the Journal**

Explains the codes printed on the Journal.

# Displaying the Files in Memory

Use this function to display a summary of current memory usage. Items shown are the percentage of free memory space, the number of received confidential messages, the number of files to be sent, and the number of received messages to be printed.

**1** Press [Info.].

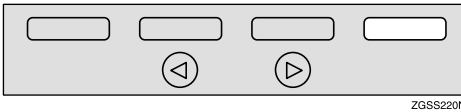
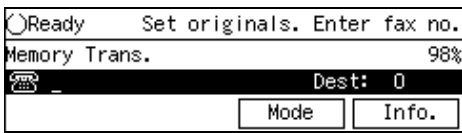

ZGSS220N

The "Information" menu is shown.

**2** Enter the code for "Files in Memory" with the number keys.

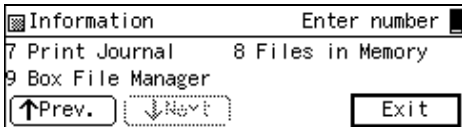

**Note**

□ If "Files in Memory" is not shown, press [↑Prev.] or [↓Next].

**3** The usage is displayed. When you have finished, press [OK].

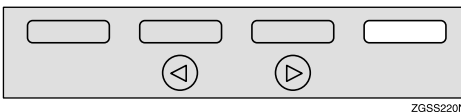
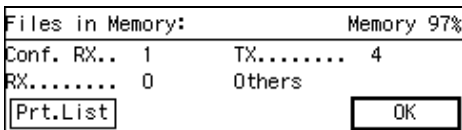

ZGSS220N

**Note**

- "Others" is displayed for the following kinds of files:
  - Auto Documents  
See p.145 "Registering Auto Documents".
  - Incoming messages sent with the Transfer Request feature  
See p.28 "Transfer Request".
  - Messages that have been received into Transfer Boxes  
See p.254 "Transfer Boxes".
  - PC Printing data file (when optional Printer Interface is installed)

## To print the Transmission File List

**1** Press [Prt.List].

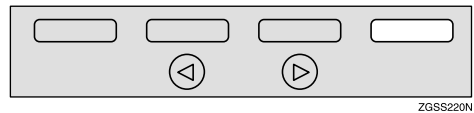
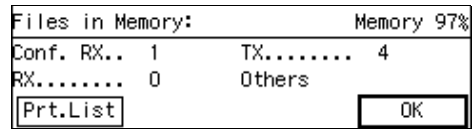

ZGSS220N

**2** Press the [Start] key.

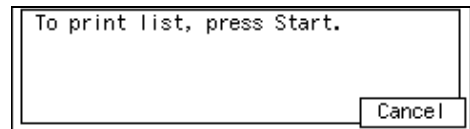

The list is printed, and the display in step 3 reappears.

**Note**

□ Press [Cancel] to stop printing the Transmission File List and return to step 3.

**4** Press [Exit].

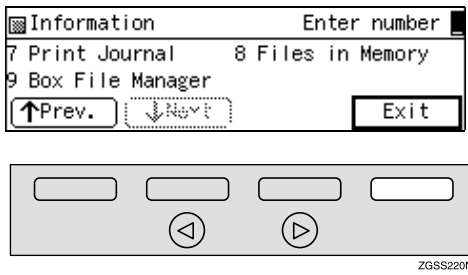

The standby display is shown.

## TX/RX File Save

*This feature requires the optional Function Upgrade Unit and Optional 40MB Memory Card.*

2

When turned on, sent or received messages are automatically saved to memory. Once stored you can then check on previous communications and print them out as necessary. See p.236 "TX/RX File Save Settings".

### Preparation

You can turn this function on or off with TX/RX File Save. See p.236 "TX/RX File Save Settings".

This feature allows you to perform the followings:

#### ❖ Searching Memory for Sent Faxes

You can search the sent faxes in the memory by Sender Name / No., Date/Time, User Code and File Number. You can print out a list of the search result. See p.59 "Searching Memory for Sent Faxes".

#### ❖ Searching Memory for Received Faxes

You can search the received faxes in the memory by Sender Name / No., Date/Time, User Code and File Number. You can print out a list of the search result. See p.62 "Searching Memory for Received Faxes".

#### ❖ Disk File Search List/Visual List

You can print out a list of the search result for "Searching Memory for Sent Faxes" and "Searching Memory for Received Faxes". See p.65 "Disk File Search List/Visual List".

#### ❖ Printing Files

You can print out the fax messages stored in the memory. See p.65 "Printing Files".

#### ❖ Deleting Files

You can delete the fax messages stored in the memory. See p.66 "Deleting Files".

### Important

- If a TX/RX file is saved in memory, it does not guarantee that the communication was successful. Messages that were not delivered, or generated an error are also stored.

### Limitation

- If any of following features are used, messages are not stored in memory:
  - Immediate Transmission
  - Confidential Transmission
  - Polling Transmission
  - Confidential Reception
  - Memory Lock Reception
  - Transfer Request Reception
  - Auto Documents
  - Forwarding
  - Fax On Demand (Option)

- ❑ When "Substitute Reception" is set to "Memory Reception if no Own Name or Own Fax Number received" and the incoming fax does not have either Own Name or Own Fax Number information, you cannot use the TX/RX File Save function. Set the "Substitute Reception" to "Possible", or have the sender of the fax register his/her Own Name or Own Fax Number. See p.178 "User Parameters" (switch 05 bit 1).

### Note

- ❑ When free memory goes below 50%, the oldest stored message is erased.
- ❑ You can set whether or not this function to work only when receiving the messages from Specified Senders. See p.236 "TX/RX File Save Settings".
- ❑ This function stores both transmissions and receptions. Your service representative can change this to one of the following options:
  - Transmissions Only
  - Receptions Only

### Reference

p.55 "Own Name/Fax Header/Own Fax Number", <Basic Features>

## Searching Memory for Sent Faxes

### 1 Press [Info.].

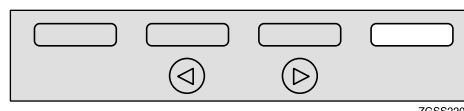
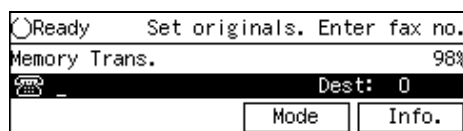

ZGSS220N

The "Information" menu is shown.

### 2 Enter the code for "TX/RX File Save" with the number keys.

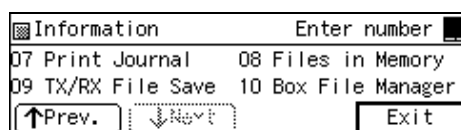

### Note

- ❑ If "TX/RX File Save" is not displayed, press [↑Prev.] or [↓Next] until it is.

### 3 Enter the code for "Search TX File" with the number keys.

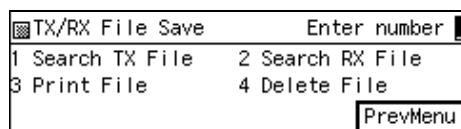

### 4 Press [Search].

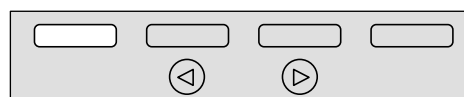
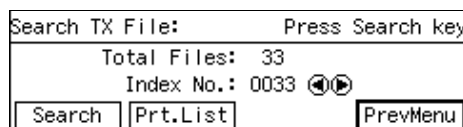

ZGSS190N

**Note**

- To print a list of all the sent faxes, press **[Prt.List]**. The display in step 5 will appear.

**5** Enter the code of the search method you require.

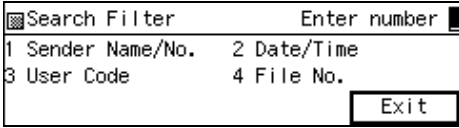

**6** Do one of the following:

**Searching By Sender Name / No.**

**1** Enter the Own Name or Own Fax Number using the Quick Dial keys or number keys.

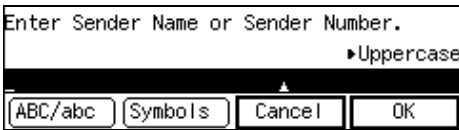

**Note**

- Press **[ABC/abc]** to switch between upper and lower case.
- Press **[Symbols]** if you wish to enter symbols.

**Reference**

See p.98 "Entering Characters", <Basic Features> and p.55 "Own Name/Fax Header/Own Fax Number", <Basic Features>.

**2** Press **[OK]**.

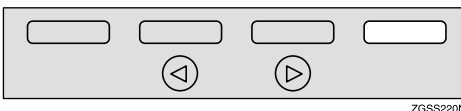
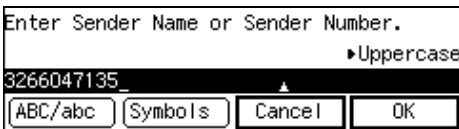

**Searching By Date/Time**

**1** Select the month using the **[↑Month]** and **[↓Month]** and enter the date, year and time using **[⊙]** or **[⊚]** key and the number keys. To change AM/PM, press **[AM/PM]**.

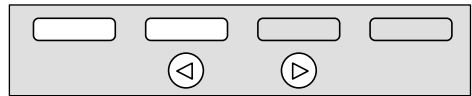
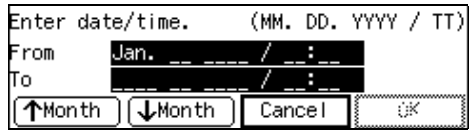

**Note**

- If you make a mistake, press **[Cancel]**, and the display in step 5 appears.

**2** Press **[OK]**.

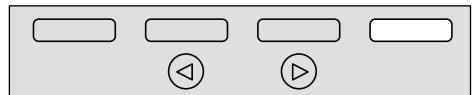
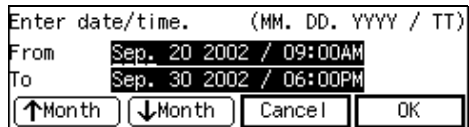

**Searching By User Code (SUB Code)**

**1** Enter the User Code/SUB Code (up to 20 digits) with the number keys.

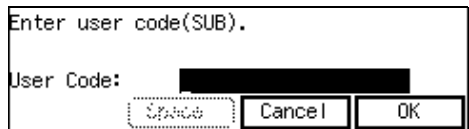

Enter the User Code (the SUB code of the Personal Box).



## Reference

p.10 "User Code Transmission".

### 2 Press [OK].

Enter user code(SUB).

User Code: 12345678

Space Cancel OK

ZGSS220N

## Note

- When an unregistered User Code is entered, the following message appears: "Not programmed.", then the display in step 2 will reappear.

## Searching By File Number

### 1 Enter the file number (four digits) with the number keys.

Enter file number.

File No.:

Cancel OK

### 2 Press [OK].

Enter file number.

File No.: 0012

Cancel OK

ZGSS220N

### 7 Press [Exit].

Search Filter		Enter number	
1 Sender Name/No.	2 Date/Time		
3 User Code	4 File No.		

Exit

ZGSS220N

### 8 Press [Prt.List].

Search TX File: Press Search key

Total Files: 1

Index No.: 0004

Search Prt.List PrevMenu

ZGSS200N

## Note

- If you wish to do a fresh search, press [Search] and return to step 1.
- Press ◀ or ▶ key to check through the file numbers of the search results.

### 9 Press ◀ or ▶ key to choose whether the image is printed on the list.

To print list, select mode then press Start.

Without Image / With Image

Cancel

ZGSS250N

## Note

- To cancel this operation, press [Cancel]. The display in step 3 reappears.

10 Press the [Start] key to print the list.

**Reference**

p.65 "Disk File Search List/Visual List"

11 Press [PrevMenu].

12 Press [Exit] to return to the stand-by mode.

### Searching Memory for Received Faxes

1 Press [Info.].

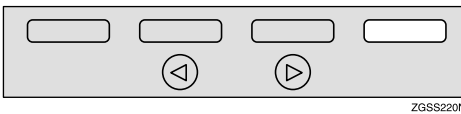
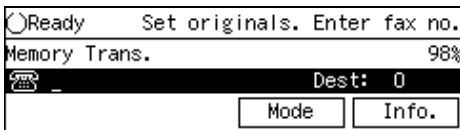

ZGSS220N

The "Information" menu is shown.

2 Enter the code for "TX/RX File Save" with the number keys.

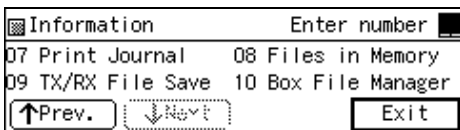

**Note**

If "TX/RX File Save" is not displayed, press [↑Prev.] [↓Next] until it is.

3 Enter the code for "Search RX File" with the number keys.

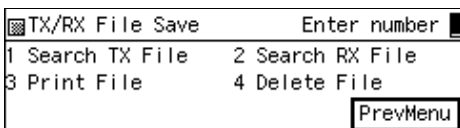

4 Press [Search].

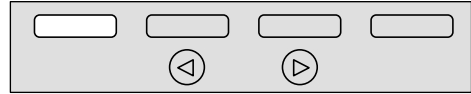
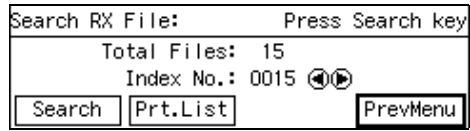

ZGSS190N

**Note**

To print a list of all the received faxes, press [Prt.List]. The display in step 4 will appear.

5 Enter the code of the search method you require.

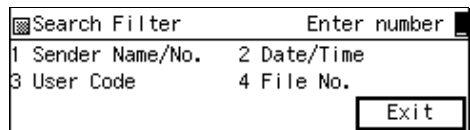

6 Carry out one of the following procedures appropriate to the search method:

#### Searching By Sender Name / No.

1 Enter the Own Name or Own Fax Number using the Quick Dial keys or number keys.

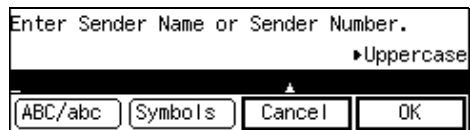

**Note**

Press [ABC/abc] to switch between upper and lower case.  
Press [Symbols] if you wish to enter symbols.

## Reference

See p.98 "Entering Characters", <Basic Features> and p.55 "Own Name/Fax Header/Own Fax Number", <Basic Features>.

### 2 Press [OK].

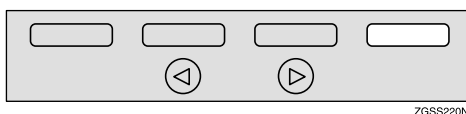

ZGSS220N

## Searching By Date/Time

- 1 Select the month using the [↑Month] and [↓Month] and enter the date, year and time using [◀] or [▶] key and the number keys. To change AM/PM, press [AM/PM].

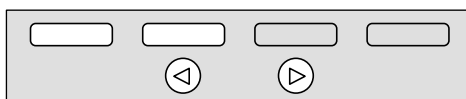

ZGSS220N

### Note

- If you make a mistake, press [Cancel], and the display in step 1 appears.

### 2 Press [OK].

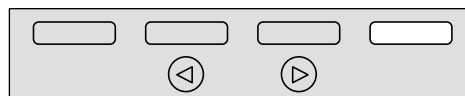

ZGSS220N

## Searching By User Code (SUB Code)

- 1 Enter the User Code/SUB Code (up to 20 digits) with the number keys.

Enter the User Code (the SUB code of the Personal Box).

### Note

- You can search received faxes with the User Codes when those codes have been already registered in your fax machine at the time of the reception with the following conditions:
  - Polling Reception
  - Polling Reception with SEP/PWD (fax messages with IDs or the documents stored in Information Boxes)
  - SEP Code Polling Reception (fax messages sent with Polling Transmission or documents stored in Information Boxes)

**2 Press [OK].**

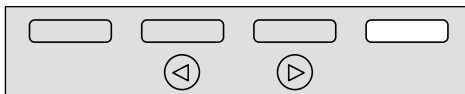
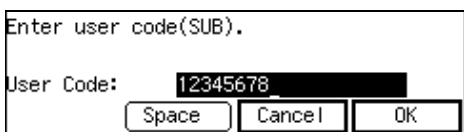

ZGSS220N

**Note**

- When an unregistered User Code is entered, the following message appears: "Not programmed.", then the display in step 2 will reappear.

**Reference**

p.10 "User Code Transmission"

**Searching By File Number**

**1 Enter the file number (four digits) with the number keys.**

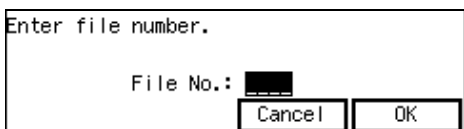

**2 Press [OK].**

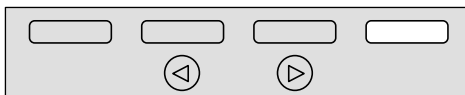
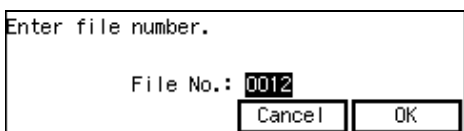

ZGSS220N

**7 Press [Exit].**

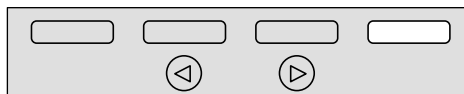
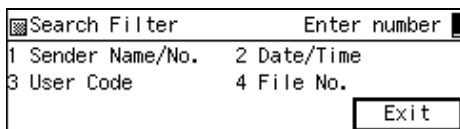

ZGSS220N

**8 Press [Prt.List].**

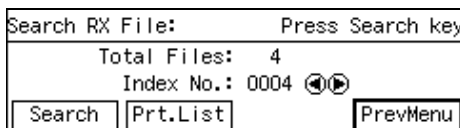

ZGSS200N

**Note**

- If you wish to do a fresh search, press [Search] and return to step 5.
- Press ⏪ or ⏩ key to check through the file numbers of the search results.

**9 Press ⏪ or ⏩ key to choose whether the image is printed.**

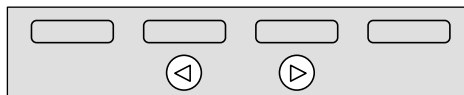
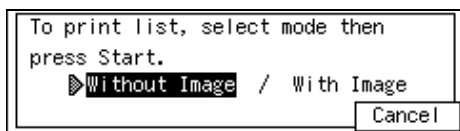

ZGSS250N

**Note**

- To cancel this operation, press [Cancel]. The display in step 9 reappears.

- 10** Press the **[Start]** key to print the list.

 **Reference**

p.65 "Disk File Search List/Visual List"

- 11** Press **[PrevMenu]**.

- 12** Press **[Exit]** to return to the standby mode.

## Disk File Search List/Visual List

Print either of these lists for a hard copy of the search results generated by the Search TX File and Search RX File functions. You can choose to have transmitted and received document images printed on this list.

If you choose "Without Image", the Disk File Search List is printed.

If you choose "With Image" the Disk File Visual List is printed.

 **Note**

- Normally, when specifying the destination with a Quick Dial key or Speed Dial, "ADDRESS" on this report shows Own Name or Own Fax Number registered in the receiver's machine. However, you can change the setting with User Parameters so that the name or number of the destination stored in the Quick Dial key or Speed Dial in your machine is printed instead. See p.178 "User Parameters" (switch 04 bit 4).

 **Reference**

p.44 "Checking the Transmission Result (TX Status)"

p.45 "Checking the Reception Result (RX Status)"

## Printing Files

Follow these steps to print files that have been stored in your machine's memory.

- 1** Press **[Info.]**.

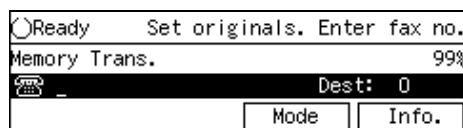

The "Information" menu is shown.

- 2** Enter the code for "TX/RX File Save" with the number keys.

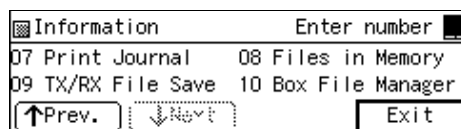

 **Note**

- If "TX/RX File Save" is not displayed, press **[↑Prev.]** or **[↓Next]** until it is.

- 3** Enter the code for "Print File" with the number keys.

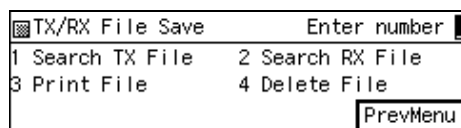

- 4** Enter the file number of the message (four digits) you wish to print with the number keys.

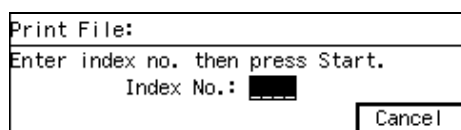

 **Note**

- If there is no matching file, "No matching file found." is displayed.

- 5** Press the **[Start]** key to print the message.
- 6** Press **[PrevMenu]**.
- 7** Press **[Exit]** to return to the stand-by mode.

## Deleting Files

Follow these steps to delete files that have been stored in your machine's memory.

- 1** Press **[Info.]**.

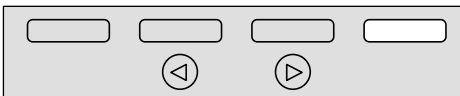
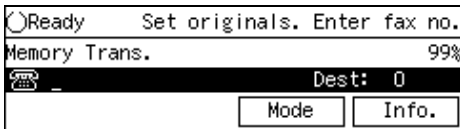

ZGSS220N

The "Information" menu is shown.

- 2** Enter the code for "TX/RX File Save" with the number keys.

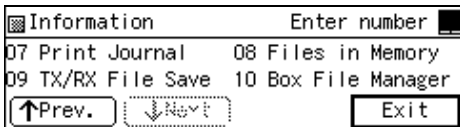

### Note

- If "TX/RX File Save" is not displayed, press **[↑Prev.]** or **[↓Next]** until it is.

- 3** Enter the code for "Delete File" with the number keys.

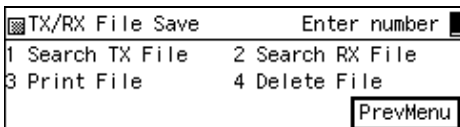

- 4** Enter the file number of the message (four digits) you wish to delete with the number keys.

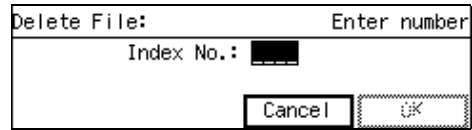

### Note

- If there is no matching file, "No matching file found." is displayed.

- 5** Press **[OK]**.

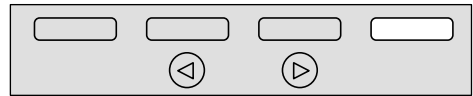
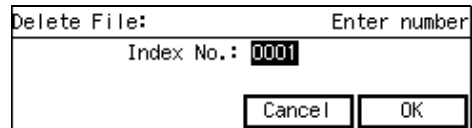

ZGSS220N

- 6** Press **[Yes]**.

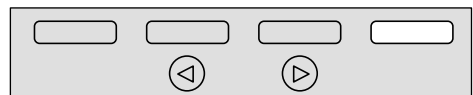
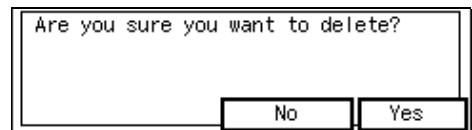

ZGSS220N

### Note

- Press **[No]** to return to the display in step **3**.

- 7** Press **[PrevMenu]**.

- 8** Press **[Exit]** to return to the stand-by mode.

# Box File Manager Functions

See the following pages for how to register, print and delete messages stored in box functions.

## Preparation

In order to use the Personal Boxes function or Information Boxes function, you need to set up Personal Boxes or Information Boxes in the "Box Settings" beforehand. See p.245 "Box Settings".

## ❖ Printing Personal Box Messages

Print a message received in a Personal Box. See p.67 "Printing Personal Box Messages".

## ❖ Storing Messages in Information Boxes

Store a message in an Information Box. See p.69 "Storing Messages in Information Boxes".

## ❖ Printing Information Box Messages

Print a message stored in an Information Box. See p.70 "Printing Information Box Messages".

## ❖ Deleting Information Box Messages

Delete a message stored in an Information Box. See p.71 "Deleting Information Box Messages".

## Reference

p.245 "What is the SUB/SEP Code?"

p.246 "Personal Boxes"

p.251 "Information Boxes"

## Printing Personal Box Messages

Follow these steps to print a message received in a Personal Box.

### Note

- When a message has been received into a Personal Box, the  indicator lights and the Confidential File Report is printed. This report shows the name of the Personal Box in which the message has been received. See p.47 "Confidential File Report".
- If you print a Personal Box message, it is deleted.

### 1 Press [Info.].

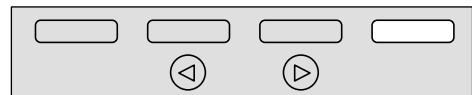
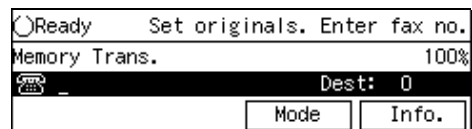

ZGSS220N

The "Information" menu is shown.

### 2 Enter the code for "Box File Manager" with the number keys.

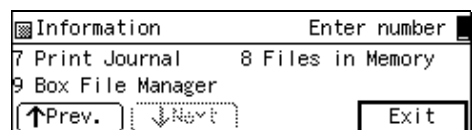

### Note

- If "Box File Manager" is not displayed, press [**↑Prev.**] or [**↓Next**] until it is.

**3** Enter the code for "Print Personal-Box" with the number keys.

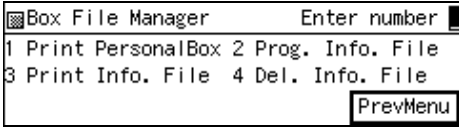

**4** Enter the SUB code of the Personal Box you wish to print.

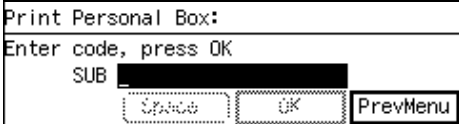

**5** Press [OK].

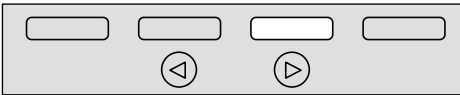
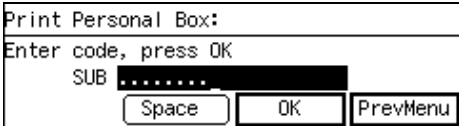

ZGSS210N

**Note**

- ❑ If a password is required, enter the password then press [OK].

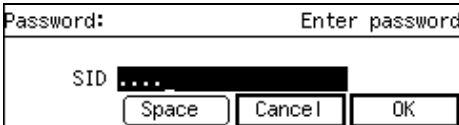

- ❑ If there are no received messages, "No matching file found." is displayed then the screen in step 4 reappears.

**6** Press the [Start] key to print the message.

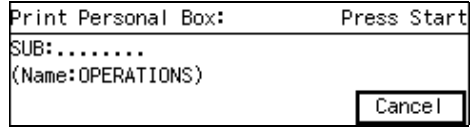

**Note**

- ❑ Press [Cancel] to return to the display in step 4.
- ❑ To stop printing, press the [Stop] key. The display in step 4 will reappear.

**7** Press [PrevMenu].

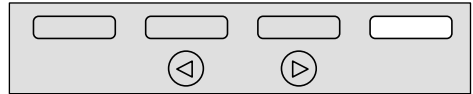
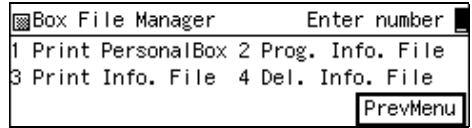

ZGSS220N

**Note**

- ❑ If there are messages in other Personal Boxes, the display in step 4 will reappear, press [PrevMenu] twice.

**8** Press [Exit] to return to the stand-by mode.

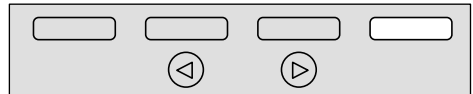
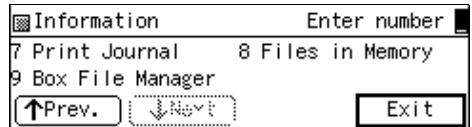

ZGSS220N



## Storing Messages in Information Boxes

Follow these steps to store a message in an Information Box.

### Note

- Only one message can be stored in each Information Box.
- To delete a stored message in Information Box, see p.71 "Deleting Information Box Messages".

### 1 Press [Info.].

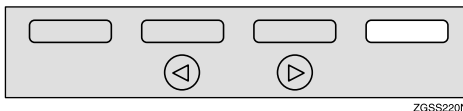
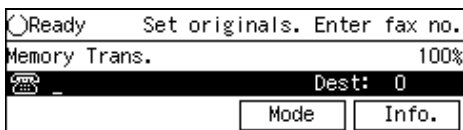

The "Information" menu is shown.

### 2 Enter the code for "Box File Manager" with the number keys.

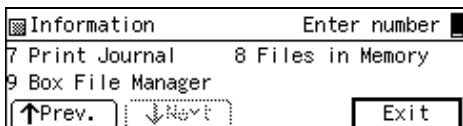

### Note

- If "Box File Manager" is not displayed, press [↑Prev.] or [↓Next] until it is.

### 3 Enter the code for "Prog. Info. File" with the number keys.

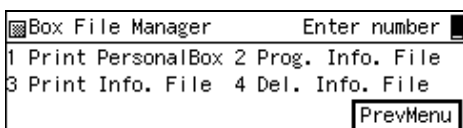

### 4 Enter the SEP code of the Information Box you wish to store the message in.

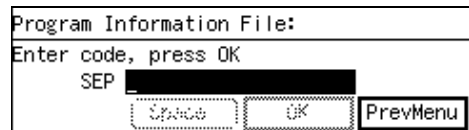

### 5 Press [OK].

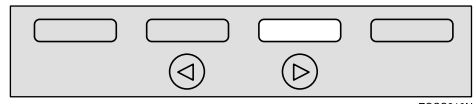
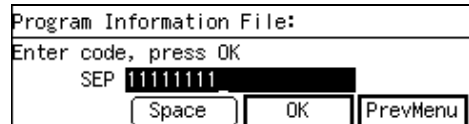

### Note

- If a password is required, enter the password then press [OK].

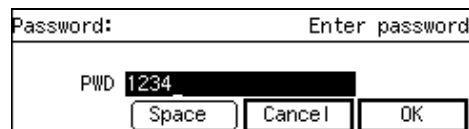

- When there is already a stored message in the selected Information Box, the message below appears. If you wish to overwrite the stored message with the new message, press [Yes]. If you press [No], the display in step 4 reappears.

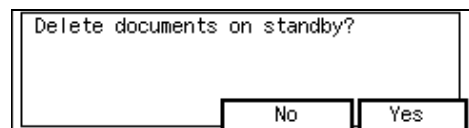

- 6** Set the original you wish to store, and select any scan settings as necessary.

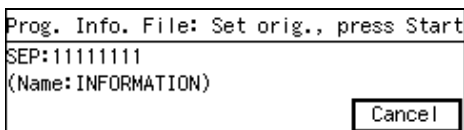

**Note**

- If you press **[Cancel]**, the display in step **4** reappears.

- 7** Press the **[Start]** key.

Your document is scanned in.

To cancel scanning, press the **[Stop]** key. The display in step **4** reappears.

- 8** Press **[PrevMenu]** twice.

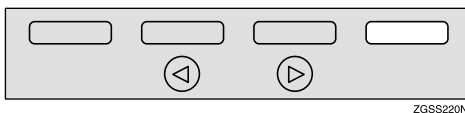
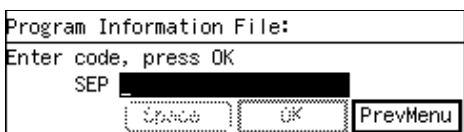

**Note**

- If you wish to continue storing a message in another Information Box, repeat the steps from **4**.

- 9** Press **[Exit]** to return to the stand-by mode.

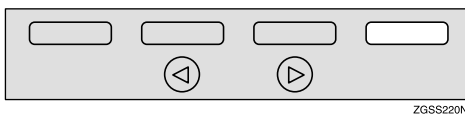
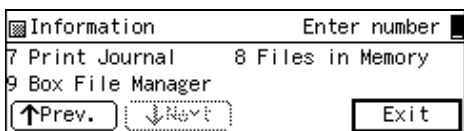

## Printing Information Box Messages

Follow these steps to print a message stored in an Information Box.

- 1** Press **[Info.]**.

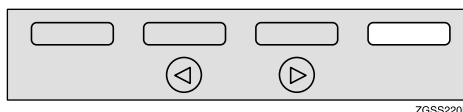
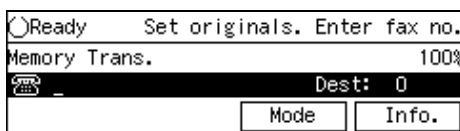

The "Information" menu is shown.

- 2** Enter the code for "Box File Manager" with the number keys.

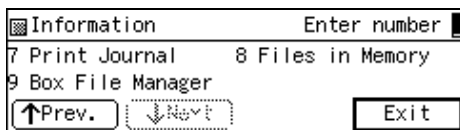

**Note**

- If "Box File Manager" is not displayed, press **[↑Prev.]** or **[↓Next]** until it is.

- 3** Enter the code for "Print Info. File" with the number keys.

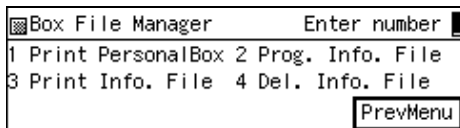

- 4** Enter the SEP code stored for the Information Box.

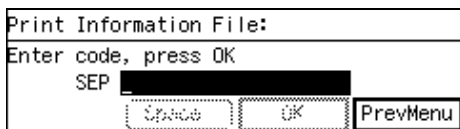

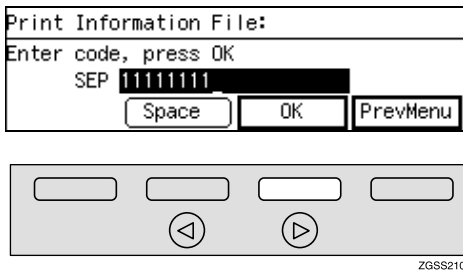
**5** Press [OK].**Note**

- ❑ If a password is required, enter the password then press [OK].

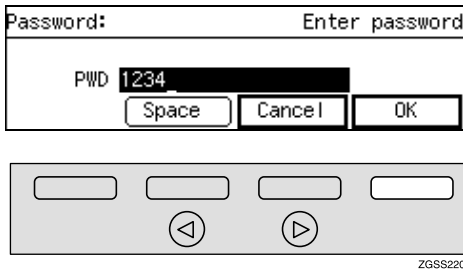

- ❑ If no message is stored, "No matching file found." is displayed and the screen in step 4 reappears.

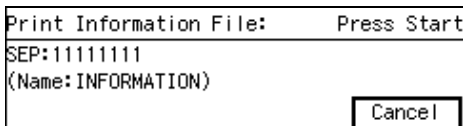
**6** Press the [Start] key.

The message is printed.

**Note**

- ❑ Press [Cancel] to return to the display in step 4.
- ❑ To cancel printing, press the [Stop] key. The display in step 4 reappears.

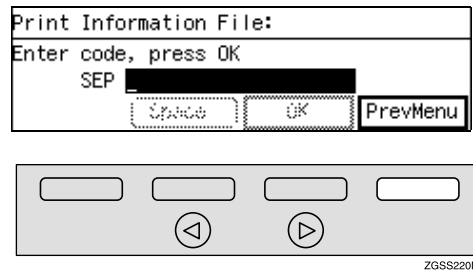
**7** Press [PrevMenu] twice.**Note**

- ❑ To print messages that are stored in other Information Boxes, repeat the steps from the display in step 4.

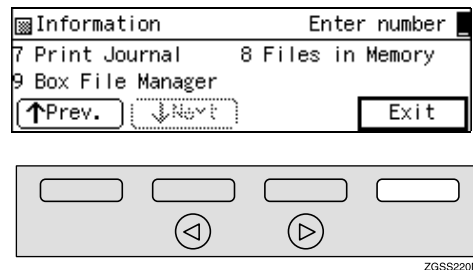
**8** Press [Exit] to return to the standby mode.

## Deleting Information Box Messages

Follow these steps to delete a message stored in an Information Box.

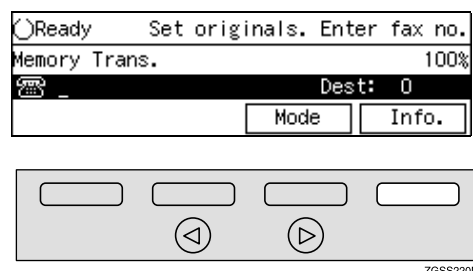
**1** Press [Info.].

The "Information" menu is shown.

**2** Enter the code for "Box File Manager" with the number keys.

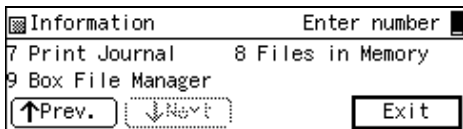

**Note**

- ❑ If "Box File Manager" is not displayed, press [↑Prev.] or [↓Next] until it is.

**3** Enter the code for "Del. Info. File" with the number keys.

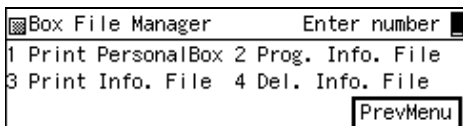

**4** Enter the SEP code of the Information Box you wish to delete.

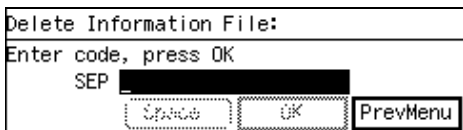

**5** Press [OK].

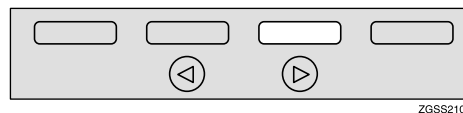

**Note**

- ❑ If a password is required, enter the password then press [OK].

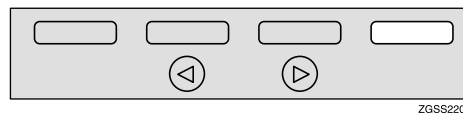
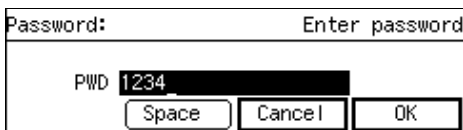

- ❑ If no message is stored, "No matching file found." is displayed and the screen in step 4 reappears.

**6** Press [Yes].

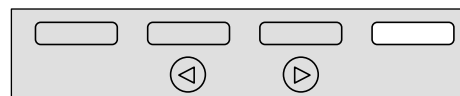
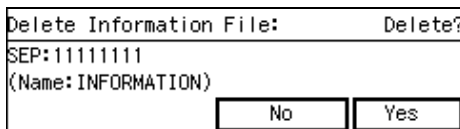

**7** Press [Yes].

The Information Box message is deleted.

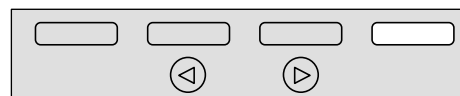
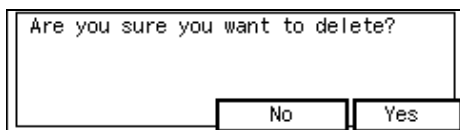

**Note**

- ❑ If you press [No], the message is not deleted and the display in step 4 reappears.

**8** Press [PrevMenu].

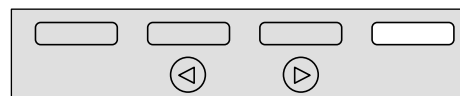
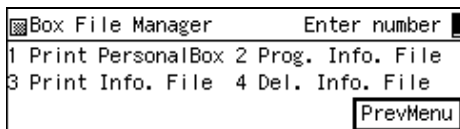

**Note**

- ❑ If messages are stored in other Information Boxes, the display in step 4 appears, press [PrevMenu] twice.

- 9** Press [Exit] to return to the stand-by mode.

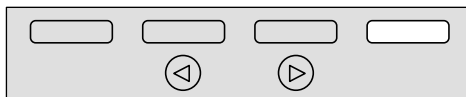
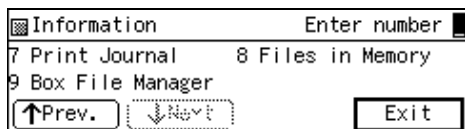

ZGSS220N



# 3. Other Transmission Features

## Handy Dialing Functions

### Chain Dial

This feature allows you to compose a telephone number from various parts, some of which may be stored as Quick Dial keys or Speed Dial codes, and some of which may be entered with the number keys.

You can program commonly used area or country codes into Speed Dial codes or Quick Dial keys.

#### Note

- The maximum number of digits you can enter is 254.
- With Memory Transmission or Immediate Transmission, press the **[Pause/Redial]** key after entering digits using the number keys, a pause will be entered. However, this is not necessary with On Hook Dial and Manual Dial.

Example: 01133-1-5551234 (From the United States to Paris).

Assume that the following Quick Dial and Speed Dial numbers have already been programmed.

- Quick Dial 001 = 01133 (Overseas to France)
- Quick Dial 003 = 1 (Paris)
- Speed Dial 001 = 5551234

**1** Set the original and select any scan settings as necessary.

**2** Press **[Quick Dial 001]**.

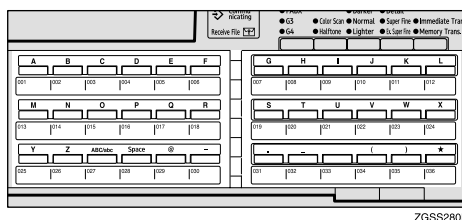

**3** Press the **[Pause/Redial]** key.

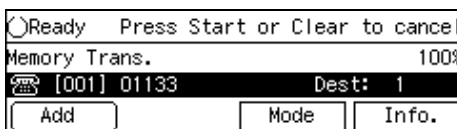

**4** Press the **[Quick Dial 003]** key.

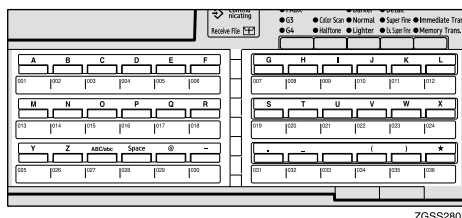

**5** Press the **[Pause/Redial]** key.

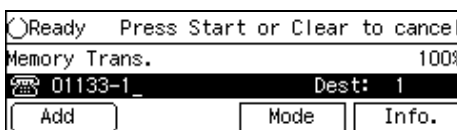

**6** Press the **[Speed Dial]** key.

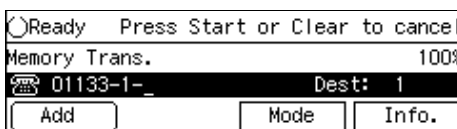

**7** Press **[0][0][1]**.

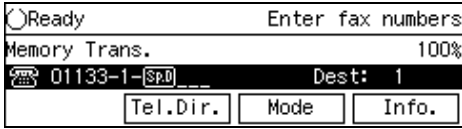

**Note**

- If you wish to specify another destination, press **[Add]**, then repeat steps from **2**.

**8** Press the **[Start]** key.

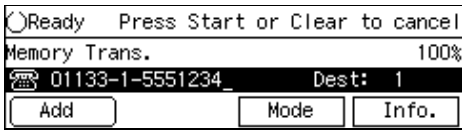

## Telephone Directory

This feature lets you find a stored Speed Dial quickly by just entering a single letter, for example, the first letter of the name stored for that number.

**Limitation**

- Speed Dial codes cannot be searched for by symbol or number.

**1** Set the original and select any scan settings you require.

**2** Press the **[Speed Dial]** key.

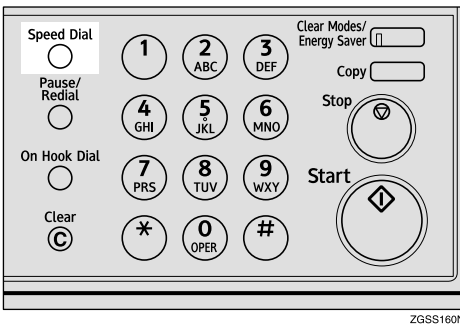

**3** Press **[Tel.Dir.]**.

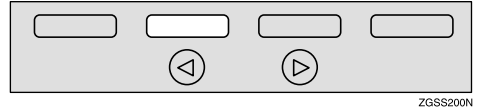
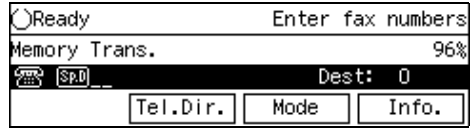

**4** Enter the search letter by pressing one of the Quick Dial keys (A to Z).

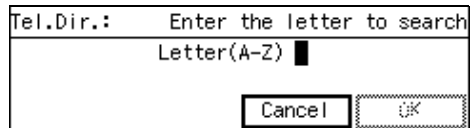

**Note**

- Key layout of the Quick Dial keys are either "QWERTY" or "ABCDE", depending on the settings you made. See p.205 "Key Layout".

**5** Press **[OK]**.

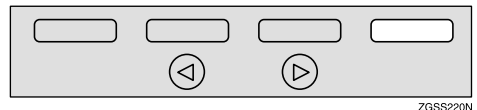
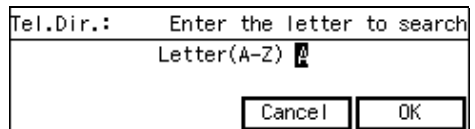

The names or fax numbers registered in Speed Dials are shown in numerical order on the display.

**6** Enter the two-digit code (00 to 99) or three-digit code (000 to 999) of the Speed Dial with the number keys.

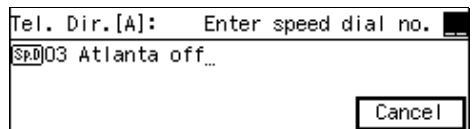



**Note**

- ❑ When the optional Function Upgrade Unit is installed, enter a Speed Dial code in the range 000 to 999.
- ❑ If the list does not contain the desired destination, press [**↑Prev.**] or [**↓Next**].
- ❑ If you incorrectly enter the code, press the [**Clear**] or [**Stop**] key to try again.

**7** Press the [**Start**] key.**Redial**

The machine memorizes the last 10 destinations that have been dialed. If you wish to send a message to a destination which you faxed to recently, the Redial feature saves you finding and entering the number again.

**Note**

- ❑ The following kinds of destinations are not memorized:
  - Group Dials
  - Destinations dialed as End Receivers for Transfer Request
  - Destination of Memory File Transfer
  - Destinations dialed using the external telephone keypad
  - Destinations dialed by Redial (regarded as already memorized)
- ❑ The machine only remembers the most recent single number that was dialed with a Quick Dial key or Speed Dial.
- ❑ When redialing the destination registered in a Quick Dial key or Speed Dial, the registered name appears.

- ❑ The machine only remembers the most recent single number that was dialed with a Quick Dial key or Speed Dial. If a transmission dialed with the number keys takes place after a transmission using a Quick Dial key or Speed Dial, the previous 10 memorized numbers are erased.
- ❑ Even when dialing with the number keys, when the number has Own Name or Own Fax Number registered, the name or number registered appears. See p.55 "Own Name/Fax Header/Own Fax Number", <Basic Features>.
- ❑ The machine remembers the Group Dials in which only one destination is stored.

**1** Set the original and select any scan settings you require.

**2** Press the [**Pause/Redial**] key

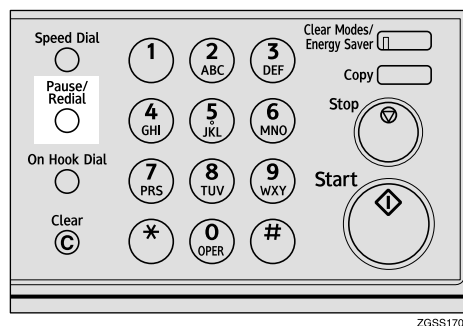

The last number dialed appears.

**3** Enter the code of the number you wish to redial.

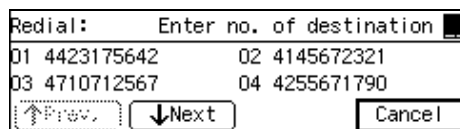
**Note**

- ❑ If the list does not contain the desired destination, press [**↑Prev.**] or [**↓Next**].

**4** Press the [**Start**] key.

# SUB/SID (SUB Code Transmission)

Normally you can only use Confidential Transmission or Transfer Request to send to fax machines of the same make that have the Confidential Reception or the Transfer Request feature. However, if the other machine supports a similar feature called SUB/SID, you can send fax messages to the other party using this method instead.

You can also use SUB code Transmission to send messages to Personal Boxes and Transfer Boxes registered in other fax machines.

## Preparation

You need to assign the Dial Options feature to a User Function key beforehand. See p.154 "User Function Keys".

## Limitation

- ❑ SUB Code Transmission is only available with G3, and is not available with G4.

## Note

- ❑ When specifying Transmission with the Default ID, the SUB Code of the Sub Code Transmission with the Mode key function is not available. See p.13 "SUB Code Transmission with the Mode Key".
- ❑ You can enter numbers up to 20 digits.
- ❑ You can also store the SUB Codes in addition to the other parties names and fax numbers in Quick Dial keys, Speed Dials, or Key Stroke Programs.

- ❑ SUB Codes are printed on the following reports:
  - File Reserve Report (Memory Transmission)  
See p.107 "File Reserve Report (Memory Transmission)".

## Reference

- p.7 "Sending Confidential Messages"
- p.28 "Transfer Request"
- p.246 "Personal Boxes"
- p.254 "Transfer Boxes"
- p.63 "Quick Dial", <Basic Features>
- p.76 "Speed Dial", <Basic Features>
- p.87 "Groups", <Basic Features>
- p.136 "Program/Delete Menu"

**1** Set the original and select any scan settings you require.

**2** Dial the destination fax number with the number key.

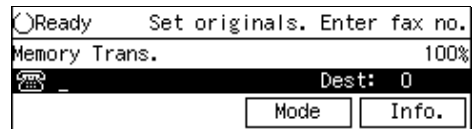

**3** Press the User Function key ([F1] to [F10]) assigned with the Dial Options feature.

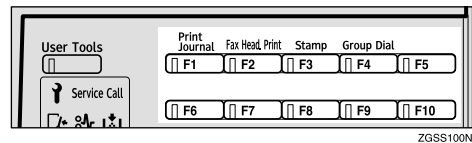

**4** Enter the code for "SUB" with the number key.

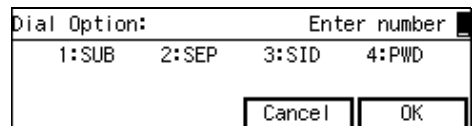

**5** Enter the SUB code, then press [OK].

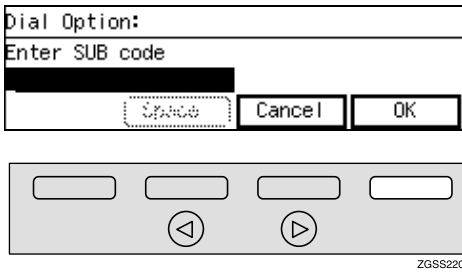

**Note**

- Make sure to enter the same SUB code that is stored in the Personal Box, or the SUB code of the Transfer Box of the other parties'.
- You can enter up to 20 characters.
- You can enter digits 0-9, #, \* and spaces. To enter a space, press [Space] (the first character cannot be a space).
- If you incorrectly enter the code, press the [Clear] key or [Stop] key and try again.
- Make sure that the ID you enter conforms with the specifications of the other party's fax machine.

When entering the SID (Password) is necessary

**1** Enter the code for "SID" with the number key.

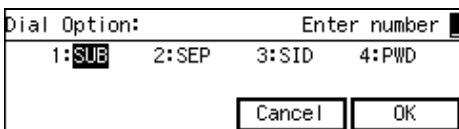

**2** Enter the SID, then press [OK].

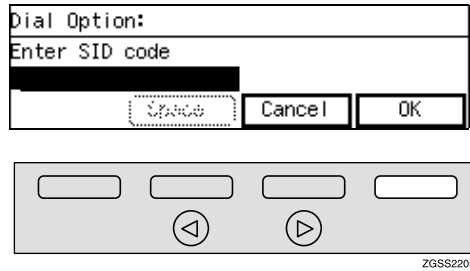

**Note**

- You can enter up to 20 characters.
- You can enter digits 0-9, #, \* and spaces. To enter a space, press [Space] (the first character cannot be a space).
- If you incorrectly enter the code, press the [Clear] key or [Stop] key and try again.
- Make sure that the ID you enter conforms with the specifications of the other party's fax machine.

**3** Press [OK].

**6** Press [OK].

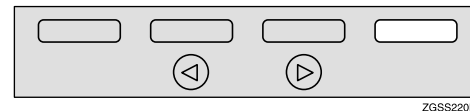
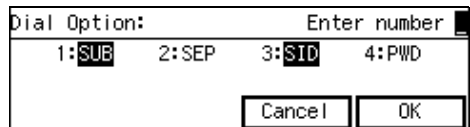

**Note**

- To cancel the operation, press [Cancel] and the display will return to standby mode menu.

**7** Press the **[Start]** key.

**Note**

- ❑ When in Immediate Transmission, if the other party does not support this function, an error message appears on the display.

## SEP/PWD (SEP Code Polling Transmission)

Normally you can only use Polling Transmission/Reception between fax machines of the same make that have the Polling Transmission/Reception feature. However, if the other machine supports a similar feature called SEP/PWD, you can send faxes or receive messages using this polling method instead.

You can also use SEP Code Polling Transmission to retrieve documents stored in information boxes registered in other fax machines.

**Preparation**

You need to assign the Dial Options feature to a User Function key beforehand. See p.154 "User Function Keys".

**Note**

- ❑ The ID can be up to 20 digits long and consist of digits, spaces, \* and #.
- ❑ You can also store the SEP Codes in addition to the other parties names and fax numbers in Quick Dial keys, Speed Dials, or Key Stroke Programs.
- ❑ Messages you send using this feature are marked "SEP" on the reports below:
  - File Reserve Report (Memory Transmission)  
See p.107 "File Reserve Report (Memory Transmission)".

- File Reserve Report (Polling Reception)  
See p.21 "File Reserve Report (Polling Reception)".

- ❑ Make sure that the ID you enter conforms with the specifications of the other party's fax machine.

**Reference**

- p.22 "Polling Transmission"
- p.19 "Polling Reception"
- p.251 "Information Boxes"
- p.63 "Quick Dial", <Basic Features>
- p.76 "Speed Dial", <Basic Features>
- p.87 "Groups", <Basic Features>
- p.136 "Program/Delete Menu"

**1** Press **[Mode]**.

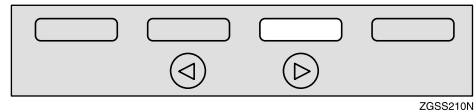
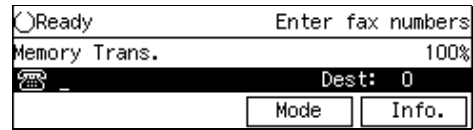

The Transmission Mode menu appears.

**2** Enter the code for "Polling RX" with the number keys.

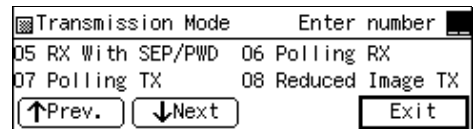

**Note**

- ❑ If "Polling RX" is not displayed, press **[↑Prev.]** or **[↓Next]** until it is.

- 3** Press **◀** or **▶** key to select "Default ID", and then press **[OK]**.

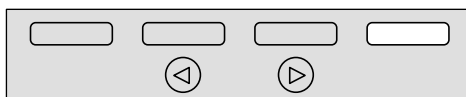

ZGSS220N

The Transmission Mode menu is shown. A check mark is added to Polling Reception.

- 4** Press **[Exit]**.

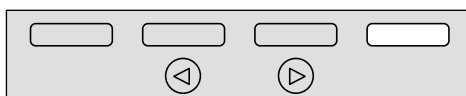

ZGSS220N

The Polling Reception menu is shown.

#### Note

- "Polling RX" appears.

- 5** Dial the destination fax number using the number keys.

- 6** Press the User Function key (**(F1)** to **(F10)**) assigned with the Dial Options feature.

ZGSS100N

- 7** Enter the code for "SEP" with the number keys.

- 8** Enter the SEP code with the number keys, then press **[OK]**.



ZGSS220N

#### Note

- Make sure to enter the same SEP code that is stored in the Information Box of the other parties'.
- You can enter up to 20 characters.
- You can enter digits 0-9, **#**, **\*** and spaces. To enter a space, press **[Space]** (the first character cannot be a space).
- If you incorrectly enter the code, press the **[Clear]** key or **[Stop]** key and try again.
- Make sure that the ID you enter conforms with the specifications of the other party's fax machine.

When a password (PWD) is necessary

- 1** Enter the code for "PWD" with the number keys.

3

**2** Enter the PWD code then press [OK].

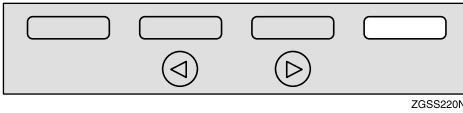
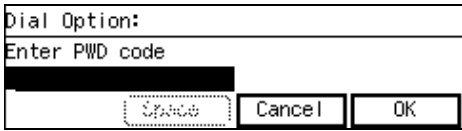

ZGSS220N

**Note**

- You can enter up to 20 characters.
- You can enter digits 0-9, #, \* and spaces. To enter a space, press [Space] (the first character cannot be a space).
- If you incorrectly enter the code, press the [Clear] key or [Stop] key and try again.
- Make sure that the ID you enter conforms with the specifications of the other party's fax machine.

**9** Press [OK].

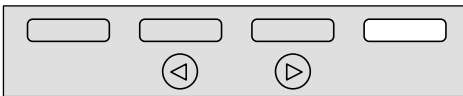
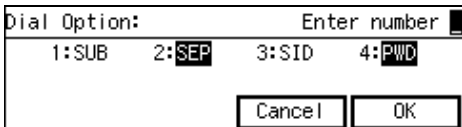

ZGSS220N

**Note**

- To cancel the operation, press [Cancel] and the display will return to standby mode menu.

**10** Press the [Start] key.

The connection is established and the reception starts.

## Sub-address

*The optional ISDN Unit is required to use this function*

ISDN allows two or more terminals (such as a fax and digital telephone) to be connected to a single line. These terminals are identified by their sub-address numbers. If the terminals connected to the line at a destination are assigned sub-addresses, dialing a sub-address allows you to direct your fax message to one or more particular terminals at the destination.

**Preparation**

You need to assign the Sub-address feature to a User Function key beforehand. See p.154 "User Function Keys"

**Limitation**

- Sub-address can only be used with ISDN.

**Note**

- You can program a sub-address number in a Quick Dial key or Speed Dial.

**1** Select G4 or ISDN-G3.

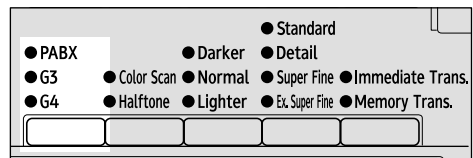

ZGSS080N

**Reference**

p.89 "Selecting the Line"

**2** Set the original and select any scan settings you require.

- 3** Dial the fax number with the number keys.

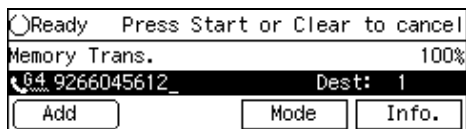

- 4** Press the User Function key (F1 to F10) in which the Sub-address function has been registered.

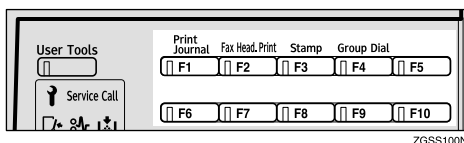

"/" appears on the display.

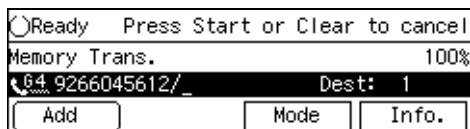

- 5** Enter the destination sub-address with the number keys.

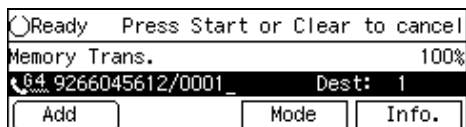

- 6** Press the [Start] key.

## UUI

*This function requires the optional ISDN Unit.*

It allows G4 faxes with the UUI (User-User Information) feature to make Transfer Requests to this machine using UUI instead of a push signal.

### Preparation

You need to store the Tone (UUI) function in a User Function key beforehand. See p.154 "User Function Keys".

### Limitation

- UUI is only available with ISDN.

### Note

- You can store UUI code in a Quick Dial key or Speed Dial.

- 1** Select G4 or I-G3 line.

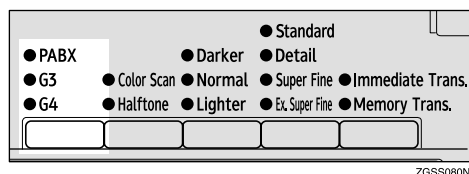

### Reference

p.89 "Selecting the Line"

- 2** Set the original and select any scan settings you require.

- 3** Enter the fax number.

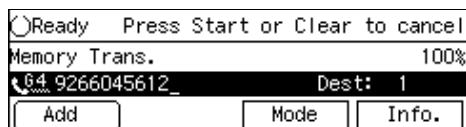

- 4** Press the User Function key (**[F1]** to **[F10]**) in which the Tone function has been registered.

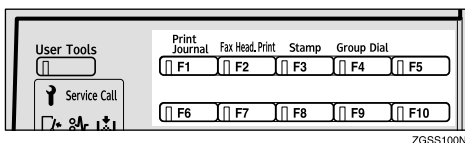

"•" appears after the fax number you entered.

3

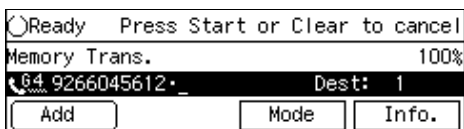

- 5** Enter the UII code with the number keys.

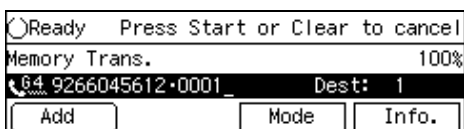

- 6** Press the **[Start]** key.



# On Hook Dial

You can send a fax message without lifting the receiver, while still listening to the dial tone.

When a connection is made to another fax machine (you will hear a high-pitched tone), press the **[Start]** key.

## Note

- You cannot use this feature with the optional Extra G3 Interface Unit.
- You can adjust the volume of the internal speaker. See p.104 "Adjusting Volume", <Basic Features>.
- The On Hook Dial function is also available with ISDN. See p.86 "Using On Hook Dial with ISDN".

**1** Set the original and select any scan settings you require.

**2** Press the **[On Hook Dial]** key.

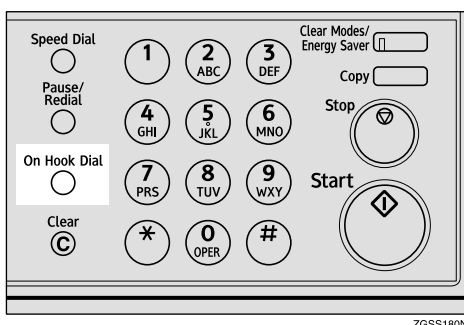

You will hear a dial tone from the machine's internal speaker.

**3** Dial.

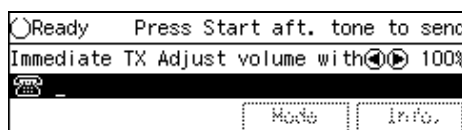

The fax number you enter is dialed immediately.

## Note

- If you misdial the number, press the **[Stop]** key, **[On Hook Dial]** or **[Clear Modes/Energy Saver]** key and return to step 2.
- Press ◀ or ▶ key to adjust the monitor volume.

## Reference

p.46 "Dialing", <Basic Features>

p.75 "Handy Dialing Functions"

**4** When a connection is made to another fax machine (you will hear a high-pitched tone), press the **[Start]** key.

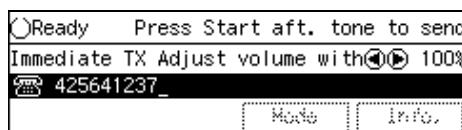

Transmission starts.

After transmission the machine will return to the standby mode.

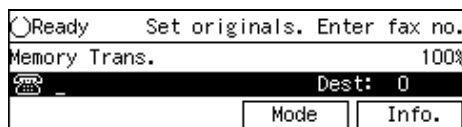

## Note

- If you wish to cancel transmission while it is in progress, press the **[Stop]** key then remove the document.

## Using On Hook Dial with ISDN

This feature requires the optional ISDN Unit.

When only connected to an ISDN line, the On Hook Dial feature becomes available for ISDN.

The following example describes how to use this feature to connect to a fax information service.

3

### Preparation

You need to set the "Selecting the line for On Hook Dial" to "ISDN" with User Parameters. See p.178 "User Parameters" (switch 21 bit 0).

### Note

- When ISDN is selected for the On Hook Dial, the optional handset or an external telephone can only be used for making phone calls. You cannot transmit faxes with the Manual Dial function or receive faxes with the Telephone Mode. See p.88 "Manual Dial" and p.113 "Telephone Mode".

### 1 Press the [On Hook Dial] key.

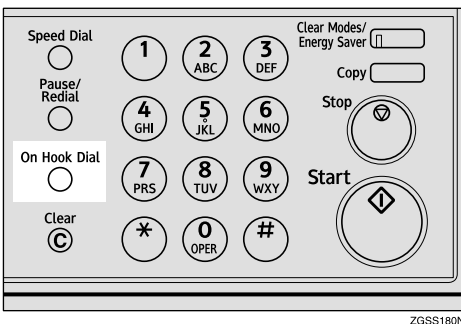

### 2 Dial the fax number.



### Limitation

- Do not pause for more than 5 seconds between dialing digits. If more than 5 seconds passes, transmission will start automatically.

### Note

- If you incorrectly enter the number, press the [On Hook Dial] key, the [Stop] key or the [Clear Modes/Energy Saver] key and perform the operation again.
- You can also enter the sub-address and UUI. The correct input sequence is as follows: "Fax number" "/" "Sub-address" "•" "UUI"
- Press [Left Arrow] to [Right Arrow] key to adjust the monitor volume.

### Reference

p.82 "Sub-address"  
p.83 "UUI"

### 3 Press [Dialing].

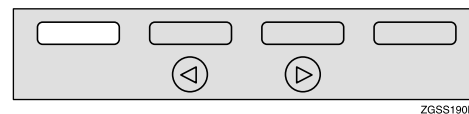

### Note

- Transmission will begin automatically 5 seconds after entering the fax number.

**4** Follow the instructions provided by the other party.

**5** When you hear a message such as "Please press the start button", press the **[Start]** key.

After a while, reception will begin.

When reception has finished, the machine will return to the standby mode.

# Manual Dial

The optional handset or an external telephone is required to use this function.

Pick up the handset or the external telephone and dial. When the line is connected and you hear a high-pitched tone, press the **[Start]** key to send your fax message. If, on the other hand, you hear a voice at the other end, continue your conversation as you would normally over the telephone.

## Note

- Manual Dial does not work with ISDN lines.
- Results of transmissions with this feature are not mentioned in the Transmission Result Report.
- You can specify destination with the number keys, Quick Dial key or Speed Dial.
- While using the optional handset or an external telephone, you can store the fax documents for the Memory Transmission if "Storing fax documents for the Memory Transmission while using the Manual Dial function" is set to "Enable" with User Parameters. However, while this feature is set to "Disable", you cannot transmit faxes using the Manual Dial function. See p.178 "User Parameters" (switch 09 bit 4).
- If you lift the handset immediately after the machine switches to Night Timer mode, there will be no sound for a maximum of 4 seconds. When you can hear sound again, you can continue.

**1** Set the original and select any scan settings you require.

**2** Pick up the external telephone.

You will hear a dial tone.

**3** Dial.

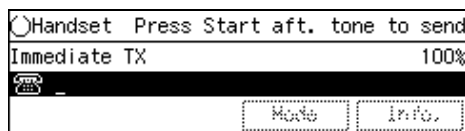

The fax number you enter is dialed immediately.

## Note

- If you incorrectly enter the number, replace the external telephone and try again from step 2.

## Reference

p.46 "Dialing", <Basic Features>

p.75 "Handy Dialing Functions"

**4** When the line is connected and you hear a high-pitched tone, press the **[Start]** key to send your fax message, and replace the handset of the external telephone.

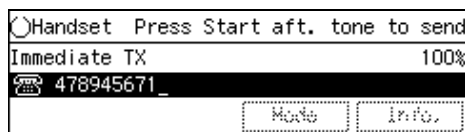

Transmission starts.

After transmission the machine will return to the standby mode.

## Note

- If someone picks up the phone at the other end, ask them to do what is necessary to receive the fax.
- If you wish to cancel transmission while it is in progress, press the **[Stop]** key then remove the original.

# Selecting the Line

*This feature requires the optional Extra G3 Interface Unit or the optional ISDN Unit.*

Installing all of these options expands the machine's line capacity to a maximum of 3 lines.

The optional Extra G3 Interface Unit connects to the PSTN, the optional ISDN Unit to the ISDN.

## Note

- Only one PSTN line is available with the base machine without any options installed.
- Up to three lines can be used simultaneously.
- One ISDN line allows you to communicate with two communication lines, however, if connected through PBX, you may only be able to use one communication line.
- The optional Extra G3 Interface Unit can be connected to a PSTN line.
- The optional Extra G3 Interface Unit can be for reception exclusive use. To change the setups, please contact your service representative.
- The optional ISDN Unit can be connected to an ISDN line.
- When sending a fax and choosing the line, you can only specify destinations with the number keys and the Chain Dial feature.
- The following display is shown when neither the optional Extra G3 Interface Unit or optional ISDN Unit is installed.

Ready	Set originals. Enter fax no.
Memory Trans.	100%
Dest: 0	
Mode	Info.

- You can set the default G3 line or expanded G3 line as the PABX line with User Parameters. See p.178 "User Parameters" (switch 13 bit 0), (switch 13 bit 2).
- The On Hook Dial function is not available with the lines expanded by the optional units. See p.85 "On Hook Dial".
- Your machine may not respond to a transmission received through an ISDN PBX, detecting it as a telephone call, not as a fax message. You can set "Respond to a transmission received through an ISDN PBX unconditionally" to "On" with User Parameters. See p.178 "User Parameters" (switch 13 bit 6).
- The table for the available combination of the connected line type(s) and the communication type(s) is as follows:

Option Component(s)	Connected Line Type(s)	Available Communication Type(s)
Base Machine	PSTN	G3
Base Machine + Optional Extra G3 Interface Unit	PSTN + PSTN (Option)	G3 + G3
Base Machine + Optional ISDN Unit	PSTN + ISDN (Option)	G3 + G4 I-G3 + G4 G3 + G4 + G4 G4 + G4
	ISDN (Option)	I-G3 + G4 G4 + G4

Option Component(s)	Connected Line Type(s)	Available Communication Type(s)
Base Machine + Optional Extra G3 Interface Unit + Optional ISDN Unit	PSTN + PSTN (Option)	G3 + G3
	PSTN + ISDN (Option)	G3 + G4 G3 + I-G3 I-G3 + G4 G3 + G4 + G4 G3 + I-G3 + G4 I-G3 + I-G3
	ISDN (Option)	I-G3 + G4 I-G3 + I-G3 G4 + G4
PSTN + PSTN (Option) + ISDN (Option)		G3 + G3 + G4 G3 + G4 + G4 I-G3 + I-G3 G3 + I-G3 + G4

- I-G3 : G3 communication using ISDN (ISDN-G3)

- When holding more than one communication at one time, the information of the first communication established is shown on the display.
- Up to three communications can be held at one time.
- You can send two faxes and receive one simultaneously.

❖ **G3**

G3 is selected by default after power on and a reset.

If the G3 indicator is not lit, press the **[Line Selection]** key until it is. Depending on the settings, either PSTN or ISDN is selected.

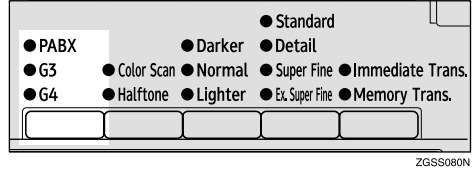

❖ **Auto Display**

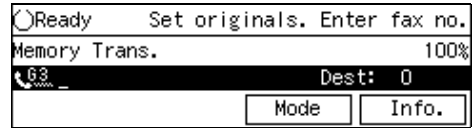

❖ **G3-1 Display**

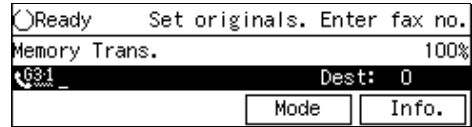

❖ **G3-2 Display**

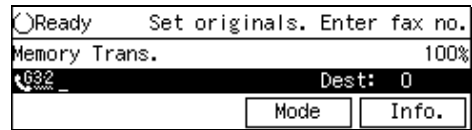

❖ **ISDN-G3 Display**

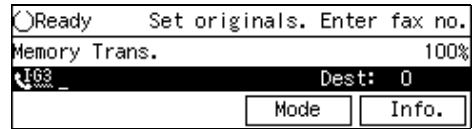

### ❖ G4

Press the **[Line Selection]** key to light the **G4** indicator. ISDN is selected.

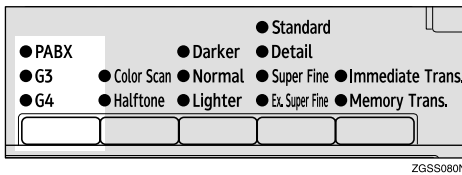

### ❖ G4 Display

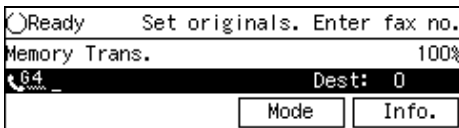

### ❖ PABX

Press the **[Line Selection]** key to light the **PABX** indicator.

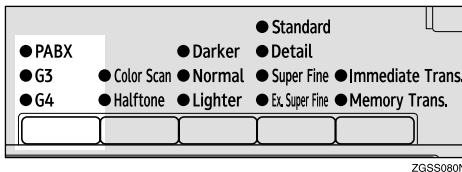

### ❖ G3 Line Selection

G4 communication always uses ISDN, but G3 communication can use either PSTN or ISDN. Therefore, when connected to both PSTN and ISDN and selecting G3, you can choose which line to use.

#### Note

- When the optional ISDN Unit is installed, the line type for "Auto" is set to PSTN by default. If you wish to change the settings, please contact your service representative.
- When using G3 with ISDN, you can use the sub-address and UII.

## Auto Discriminate

This function is for when G4 is selected. The machine first dials using G4, but if the destination is PSTN, it switches automatically to G3.

#### Limitation

- This function requires the optional ISDN Unit.

#### Note

- When the destination G3 uses TA (Terminal Adapter) or is attached to a PBX, and connected to ISDN, it is detected as G4 and the machine does not switch to G3.
- Depending on the signals of the international lines, the Auto Discriminate function cannot detect the correct line type, thus transmissions to overseas destinations may not be made.

## How to Select the Line

When the optional Extra G3 Interface Unit or optional ISDN Unit is installed, you can store the Line Select function in one of the User Function keys (**[F1]** to **[F10]**).

When sending a fax, pressing the User Function key enables you to select the line.

#### Preparation

Store the Line Select function in a User Function key (**[F1]** to **[F10]**). See p.154 "User Function Keys" .

**1** Make sure that the G3 indicator is lit.

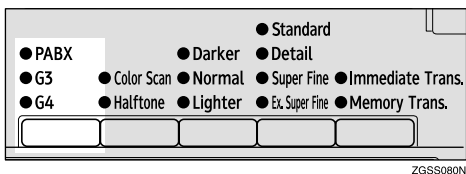

**2** Press the User Function key ([F1] to [F10]) with the Line Select function stored in.

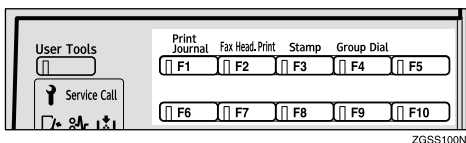

**3** Press ◀ or ▶ key to select the line.

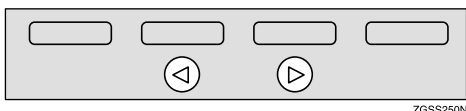
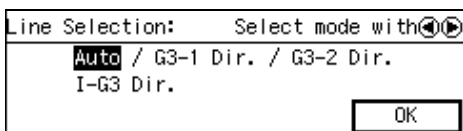

**4** Press [OK].



# Transmission Features

## Stamp

When sending a fax message, the machine can stamp a circle mark at the bottom of the document. This stamp indicates that the document has been successfully stored in memory for Memory Transmission, or that it has been successfully sent for Immediate Transmission.

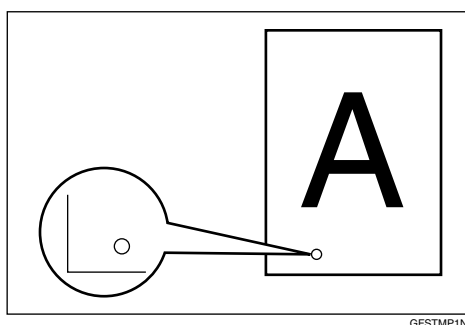

Each time you press the **[F3 Stamp]** key, the indicator light is turned on and off. Turn it on or off if you wish this function to work.

### Note

- If a page was not stamped even though the Stamp feature is turned on, you need to resend that page.
- If you use this feature often, you can adjust User Parameters so that the home setting is on. In this case, Stamp can easily be turned off for any single transmission by pressing the **[F3 Stamp]** key. See p.178 "User Parameters" (switch 00 bit 0).
- When the stamp starts getting lighter, replace the cartridge. See p.234 "Enter the code for "Program Sender" with the number keys."

## Auto Reduction

If the other party's fax machine does not have paper loaded of the same width as your document, use this feature to have your document image reduced to a suitable width during transmission.

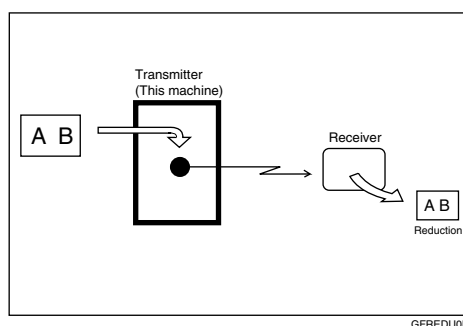

### Important

- If you turn this feature off, the scale of the document is maintained and some parts of the image may be lost when printed at the other end.

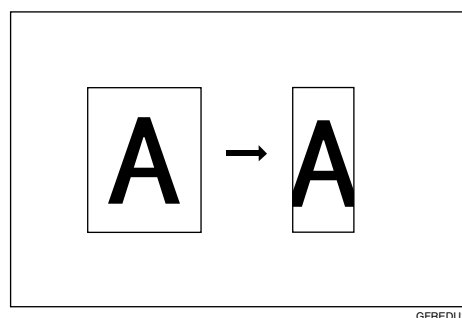

### Note

- You can switch this feature on and off with User Parameters. See p.178 "User Parameters" (switch 07 bit 3).

## ID Transmission

If you use this feature, transmission is limited to destination machines of the same make and with the same stored Polling ID. This is useful when sending documents containing confidential or sensitive information.

### Preparation

You need to program the Polling ID beforehand. See p.199 “Registering ID Codes” .

### Limitation

- ID Transmission is not available with the following functions:
  - Polling Transmission  
See p.22 “Polling Transmission”.
  - Backup File Transmission  
See p.102 “Backup File Transmission” .

### Note

- You can turn this feature on or off with User Parameters. See p.178 “User Parameters” (switch 06 bit 2).

## Duplex Original Settings

This feature lets you scan in each side of a double-sided original, then have both sides sent in a single operation.

### Preparation

You need to store the Duplex Original function in a User Function key beforehand. See p.154 “User Function Keys”.

### Limitation

- This feature is only available with Memory Transmission.
- Document bypass tray is not available with this feature.

### Note

- You cannot send duplex originals using Parallel Memory Transmission.

### 1 Make sure the Memory Transmission indicator is lit.

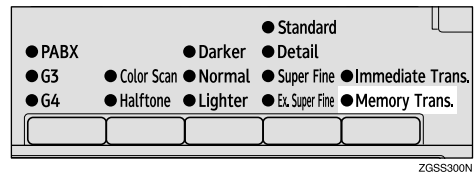

### Note

- If it is not, press the **[Transmission Mode]** key.

### 2 Press the User Function key ([F1] to [F10]) with the Duplex Original function stored in.

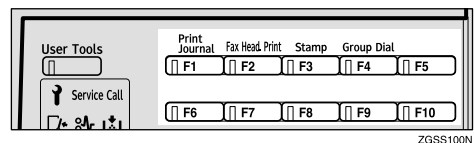

### 3 Set the double-sided original with the front page face-up.

**4** Select any scan settings as necessary.

**5** Dial the destination number.

**6** Press the **[Start]** key.

Scanning the front page will begin.

When scanning has finished, the following display appears:

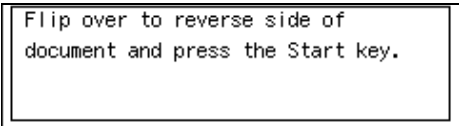

Flip over to reverse side of document and press the Start key.

**7** Set the original with the back page face-up.

 **Note**

- Set the document within 60 seconds. If time runs out, an error will occur and transmission will not take place.

**8** Press the **[Start]** key.

Transmission starts.

### If Memory Runs out While Scanning Is in Progress

Scanning of documents is interrupted if the machine's memory runs out (the remaining amount of memory decreases to 0%) while scanning and storing the documents data is in progress.

**1** When the memory runs out while scanning the back page (the second page), the following display appears.

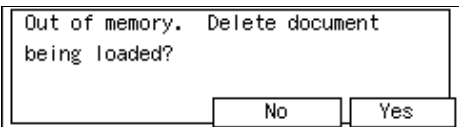

Out of memory. Delete document being loaded?

 **Note**

- If you press **[Yes]**, all scanned data is deleted.
- If you press **[No]**, transmission of the scanned data starts.
- If you do not press either **[Yes]** or **[No]** for a while, the file will be deleted automatically and the following display appears.

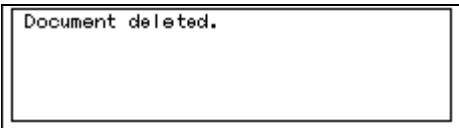

Document deleted.

- When the memory runs out while scanning the front page (the first page), the file will be deleted and the following display appears.

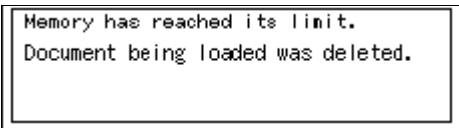

Memory has reached its limit.  
Document being loaded was deleted.

### If a Document Jam Occurs

**1** Check the message on the display, then press **[OK]**.

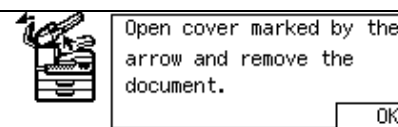

Open cover marked by the arrow and remove the document.

**2** Remove the document.

 **Reference**

p.108 "Clearing Original Jams", <Basic Features>

## Batch Original Documents Transmission

When sending a fax message which has a large number of pages, you can divide and scan the original documents in parts to store in the memory, and then send the whole data in one transmission.

### Preparation

Before you can use the Batch Original Documents Transmission function, you need to program this function into a User Function key ([F1] to [F10]). See p.154 "User Function Keys".

### Limitation

- The Immediate Transmission is not available. Use Memory Transmission.
- You cannot use the Document Bypass Tray to feed the documents when using this function.

### Note

- You cannot send batch document data using Parallel Memory Transmission.

### 1 Make sure the Memory Transmission indicator is lit.

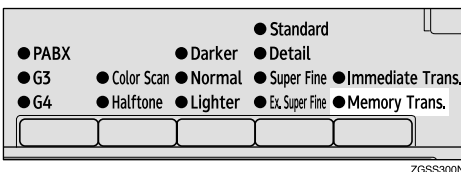

### Note

- If it is not, press the [Transmission Mode] key.

### 2 Press the User Function key ([F1] to [F10]) that the Batch Original Documents Transmission function is stored in.

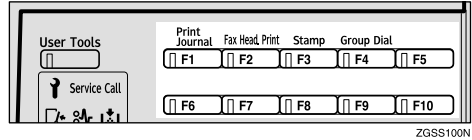

### 3 Set the first stack of documents.

#### Note

- You can set up to 30 pages (11"×17"), 40 pages (8<sup>1</sup>/<sub>2</sub>"×14"), or 75 pages (8<sup>1</sup>/<sub>2</sub>"×11") of documents at one time.

### 4 Select any scan settings as necessary.

### 5 Dial the destination number.

### 6 Press the [Start] key.

The machine starts scanning the documents.

When the scanning of the set documents is complete, the screen below appears.

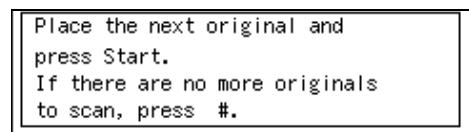

### Important

- Do not attempt to add more documents into the feeder while the scanning is in progress. Doing so may result in a document jam.

### 7 Set the next stack of documents.

**8** Press the **[Start]** key.

When the machine finishes scanning the set documents, the screen below appears.

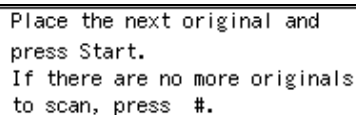

Place the next original and press Start.  
If there are no more originals to scan, press #.

**Note**

- If you have more documents to be scanned, repeat the procedure from **7**.

**9** When you finish scanning all documents, press the **[#]** key.

Transmission starts.

**If Scanning Fails**

Scanning of documents is interrupted if the machine fails to scan some of the documents and store the document data.

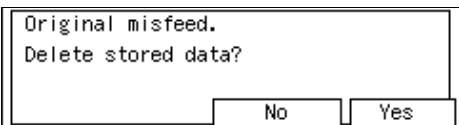
**1** Select whether or not to delete the stored document data.

Original misfeed.  
Delete stored data?

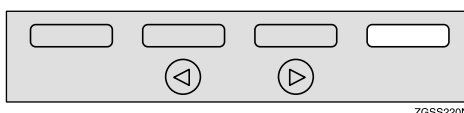

ZGSS220N

**Note**

- If you press **[Yes]**, all scanned data is deleted.
- If you press **[No]**, transmission of the scanned data starts.

**If Memory Runs out While Scanning Is in Progress**

Scanning of documents is interrupted if the machine's memory runs out (the remaining amount of memory decreases to 0%) while scanning and storing the documents data is in progress.

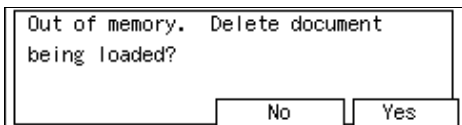
**1** Select whether or not to delete the stored document data.

Out of memory. Delete document being loaded?

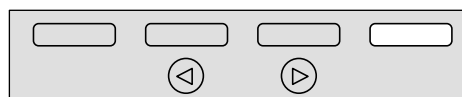

ZGSS220N

**Note**

- If you press **[Yes]**, all scanned data is deleted.
- If you press **[No]**, transmission of the scanned data starts.

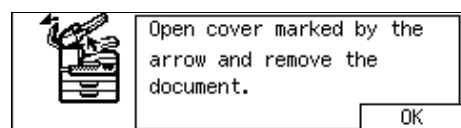
**If a Document Jam Occurs****1** Check the message on the display, then press **[OK]**.**2** Remove the document.**Reference**

p.108 "Clearing Original Jams", <Basic Features>

## Label Insertion

With this feature you can have the receiver's name programmed in Quick Dial key or Speed Dial printed on the message when it is received at the other end. The name will be printed at the top of the page and will be preceded by "TO:".

If you program the Label insertion feature in a Quick Dial key or Speed Dial, the feature is enabled when you select "On". This feature cannot be used if the other party's name is not programmed.

User Code (the name of the Personal Box) will be printed preceded by "FROM:" as well as the name of the receiver when sending faxes with User Code (SUB Code of the Personal Box) using User Code Transmission to receivers whose Label Insertion setting is "On" in your machine.

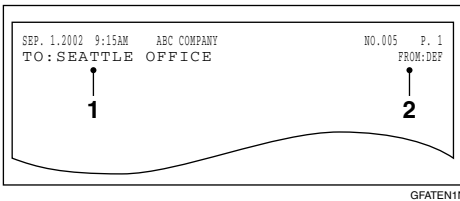

1. The name stored in the Quick Dial key or Speed Dial
2. The name of the user (the name of the Personal Box)

### Important

- ❑ If you turn this function on, any images located where the name of the receiver to be printed will be erased.

### Note

- ❑ This feature does not work with the following function and condition:
  - Transfer Request  
See p.28 "Transfer Request".
  - When transmitting the fax with the Fax Header Print function "Off"  
See p.32 "Fax Header Print".
- ❑ You can set this feature for each destination.

### Reference

- p.10 "User Code Transmission"
- p.246 "Personal Boxes"
- p.63 "Quick Dial", <Basic Features>
- p.76 "Speed Dial", <Basic Features>

## Inserting a Label Using Auto Document

The Label Insertion function is available with the documents stored as Labels with the Auto Document function. See p.145 "Registering Auto Documents".

User Code (the name of the Personal Box) will be printed preceded by "FROM:" as well as the name of the receiver when sending faxes with User Code (SUB Code of the Personal Box) using User Code Transmission to receivers whose Label Insertion setting is "On" in your machine.

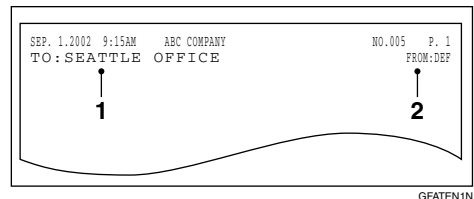

1. The name stored in the Quick Dial key or Speed Dial
2. The name of the user (the name of the Personal Box)

### Preparation

In order to have the receiver's name printed on the Label, store the document in memory and register the name of the receiver beforehand. See p.145 "Registering Auto Documents".

### Note

- Although you can specify scan settings when sending an Auto Document, these settings will only apply to the document you send along with the Auto Document. The settings used when you scanned in and stored the Auto Document will apply to the Auto Document itself.

**1** Set the original you wish to send along with the Label, and select any scan settings as necessary.

**2** Specify the Label to send in one of the following ways:

- Press the Quick Dial key that the Label is stored in.
- Press the **[Speed Dial]** key and enter the code of the Speed Dial that the Label is stored in.

**3** Press **[Yes]**.

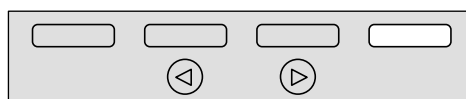
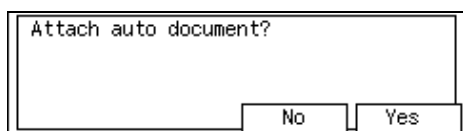

ZGSS220N

**4** Specify the destination fax number with the Label Insertion is "On" in one of the following ways:

- Press the Quick Dial key that the destination fax number is stored in.
- Press the **[Speed Dial]** key and enter the code of the Speed Dial that the destination fax number is stored in.

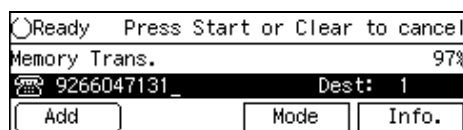

**5** Press the **[Start]** key.

## Auto Document

This feature allows you to automatically attach the registered document as the first page to the original you wish to transmit. It is handy to store Labels or maps beforehand to use this function.

You can send an Auto Document along with another document, or just send it on its own.

### Preparation

You need to register the documents or images to be sent along with the original using this feature in advance. See p.145 "Registering Auto Documents".

**Note**

Although you can specify scan settings when sending an Auto Document, these settings will only apply to the document you send along with the Auto Document. The settings used when you scanned in and stored the Auto Document will apply to the Auto Document itself.

If you send another document with an Auto Document, the Auto Document is sent first.

**Reference**

p.63 "Quick Dial", <Basic Features>

p.76 "Speed Dial", <Basic Features>

**1 Set the original you wish to send along with the Auto Document, and select any scan settings as necessary.**

To send just an Auto Document, start the following procedure from step 2.

**2 Specify the Auto Document to send in one of the following ways:**

- Press the Quick Dial key it is stored in.
- Press the **[Speed Dial]** key and enter the code of the Speed Dial it is stored in.

**3 Press [Yes].**

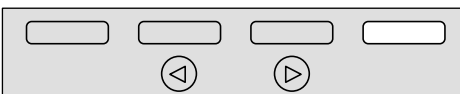
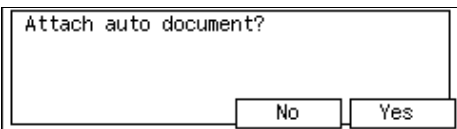

ZGSS220N

**Note**

Proceed to step 5 when you specified the destination using a Quick Dial key or a Speed Dial.

**4 Dial the destination fax number.**

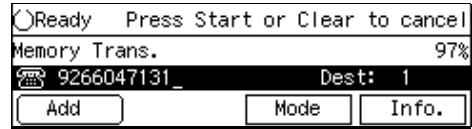

**5 Press the [Start] key.**

**No Document, No Dial**

If you dial a destination fax number and for some reason take your document back to your desk and another person sets a different document, their document could be sent to the wrong destination. To avoid such mistakes, when this feature is turned on, you cannot dial a destination unless your document is set.

**Note**

The standby screen when this feature is turned on:

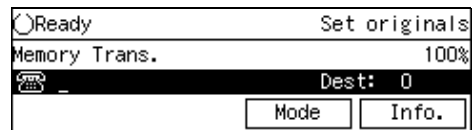

When the machine is shipped, this feature is turned off by default. If you wish to turn this feature on, please contact your service representative.



## Blank Sheet Detect

This feature is designed to help you avoid making mistakes while scanning in documents.

If you try to scan in an almost completely blank document, an alarm sounds after Immediate Transmission, and as soon as the document has been scanned for Memory Transmission.

As the alarm sounds, the screen below appears.

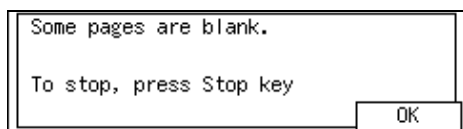

### Limitation

- This feature is not supported in Copy mode.

### Note

- Transmission is not cancelled even if the machine detects the document is blank.
- When in Memory Transmission, you can cancel the transmission by pressing the **[Stop]** key while the message is shown on the display.
- You can turn Blank Sheet Detect on or off with User Parameters. See p.178 "User Parameters" (switch 11 bit 2).

## Scanner Cleaning Message

If dirt is stuck to the scanner, the other party receives fax messages with black lines. When the scanner is dirty, the warning message "Scanner needs cleaning. Clean the exposure glass." is displayed after scanning is complete. If this message is displayed, wipe the exposure glass and white strip to remove the dirt, and then press **[OK]**.

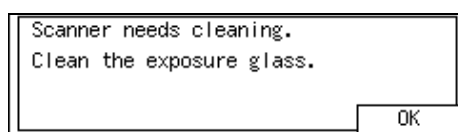

### Note

- You can select whether this message is displayed or not when the machine detects that the scanner is dirty with User Parameters. "On (Displayed)" is selected by default. See p.178 "User Parameters" (switch 20 bit 7).
- If the dirty part of the scanner is small, that is, 0.127 mm (0.005 in.) or smaller, the machine tries to erase the black line made when scanning originals. The black line is less visible on the received message. However, sometimes very small parts of the image might be missing on the received message. You can turn this function on or off with User Parameters. It is turned on by default. See p.178 "User Parameters" (switch 20 bit 4).
- Transmission is not interrupted even if the machine detects that the scanner is dirty.

## Backup File Transmission

When turned on, this feature sends a backup copy of all faxes you send to destinations that you specify.

### Preparation

You must specify the backup destinations beforehand. See p.243 "Backup File Transmission Settings".

### Note

- This function works with the following features:
  - Memory Transmission  
See p.34 "Memory Transmission", <Basic Features>.
  - Transfer Request Transmission  
See p.28 "Transfer Request".
  - Confidential Transmission  
See p.7 "Sending Confidential Messages".
  - SUB Code Transmission  
See p.13 "SUB Code Transmission with the Mode Key".
  - Mail Transmission (NIC FAX Unit (Option for Type1) required)

## JBIG Transmission

If you use JBIG (Joint Bi-level Image Experts Group) compression you can send photographic documents at high speed.

Normally, the JBIG method is used when sending to other fax machines. However, if connected to multiple lines and another JBIG transmission is in progress, transmission takes place without using JBIG.

### Limitation

- This feature requires that the other party's fax machine has both the JBIG function and ECM function (G3 communication only).
- When connected to multiple lines and a JBIG transmission is in progress, JBIG transmission is not possible until that transmission has finished.
- This feature is not available with an e-mail transmission when NIC FAX Unit (Option for Type1) installed.

### Reference

p.42 "Scan Settings", <Basic Features>

# More Transmission Functions

The following functions are useful when transmitting documents.

## If Memory Runs out While Scanning Is in Progress

Scanning of documents is interrupted if the machine's memory runs out (the remaining amount of memory decreases to 0%) while scanning and storing the document data is in progress. However, the documents already scanned in are transmitted.

### Note

- We recommend that you use Immediate Transmission to send a lot of documents when the percentage of free memory space is low.
- When the memory runs out, the following display appears:

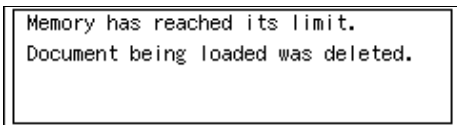

- If a document jam occurs, the following display appears. Check the message on the display, press [OK], then remove the document:

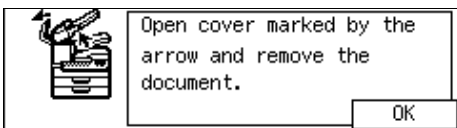

## Checking the Transmission Result

You can confirm successful transmission with the Communication Result Report or the Communication Failure Report for Memory Transmission, and the Immediate Transmission Result Report for Immediate Transmission.

### ❖ Communication Result Report

Turn on the Communication Result Report if you want a report to be printed after every transmission.

### ❖ Communication Failure Report

If you turn the Communication result Report off, the Communication Failure Report will be printed when a communication fails.

### ❖ Immediate Transmission Result Report

Turn on the Immediate Transmission Result Report if you want a report to be printed after every successful Immediate Transmission.

### Note

- You can display the communication result on the display. See p.44 "Checking the Transmission Result (TX Status)" and p.45 "Checking the Reception Result (RX Status)".
- The communication result of Memory Transmission or Immediate Transmission can be printed on the Journal. See p.50 "Printing the Journal".

---

## Broadcasting Sequence

---

If you dial several destinations for the same message (Broadcasting), the messages are sent in the order in which they were dialed. If the document could not be transmitted, the machine redials that destination after the last destination specified for Broadcasting. For example, if you specify four destinations, A through D for Broadcasting, and if the lines to destinations A and C are busy, the machine dials the destinations in the following order: A, B, C, D, A, and C.

### Note

- The dialing order mentioned above does not apply in the Batch Transmission mode.
- For details about Broadcasting, see p.29 "Transmission Modes", <Basic Features>.

---

## Simultaneous Broadcast

---

Normally, if you dial several destinations, the messages are sent in the order in which they were dialed. However, with this feature, you can send messages to more than one destination simultaneously, using separate communication lines.

You can complete the entire transmission in a shorter time with this feature than with Broadcasting.

### Note

- This feature requires the optional Extra G3 Interface Unit or the optional ISDN Unit.
- Up to two lines can be used simultaneously. When the optional Extra G3 Interface Unit is installed, it is more efficient to set the line type of the destination to "Auto" so that the transmission is made with the available G3 line.

---

## Sending a Fax Message Immediately

---

When you wish to send a fax straight away, use Immediate Transmission.

If a Memory Transmission is in progress, the display will switch to transmission standby and as soon as the current transmission has finished, the Immediate Transmission will start automatically.

If you are already sending to more than one destination with Memory Transmission and your document has already been scanned in, Broadcasting is interrupted to allow the Immediate Transmission to be sent.

However, if a transmission other than the current transmission is on standby, that document is sent first causing your Immediate Transmission to take a little longer.

---

## Broadcasting: Checking Progress

---

To check which destinations the fax message has been sent to so far, print the TX File List. See p.43 "Printing a List of Files in Memory (Print TX File List)".

---

## Automatic Redial

---

If a document cannot be transmitted because the line is busy or due to a transmission error, redialing is done twice at 5-minute intervals for Immediate Transmission, and four times at 5-minute intervals for Memory Transmission. (The redialing interval and number of retries may vary according to country.)

If redialing fails, the machine cancels the transmission and prints the Communication Result Report or Communication Failure Report.

---

## Batch Transmission

---

If you send a fax message by Memory Transmission and there is another fax message waiting in memory to be sent to the same destination, that message is sent along with your document. Several fax messages can be sent with a single call, thus eliminating the need for several separate calls. This helps you reduce communication costs and transmission time.

Fax messages for which the transmission time has been set in advance are sent by Batch Transmission when that time is reached.

### Note

- You can switch the Batch Transmission function on or off with User Parameters. See p.178 "User Parameters" (switch 06 bit 4).
- If you store the Batch Transmission function in a User Function key, you can turn it on or off by just pressing that key. The User Function key indicator lights when Batch Transmission is turned on.

---

## Dual Access

---

The machine can scan other messages into memory even while sending a fax message from memory, receiving a message into memory, or automatically printing a report.

Since the machine starts sending the second message immediately after the current transmission terminates, the line will be used efficiently.

Note that during Immediate Transmission, when copying, or when the User Tools menu is open, the machine cannot scan in documents.

---

## ECM (Error Correction Mode)

---

This feature automatically resends data that wasn't transmitted successfully using a system that complies with international standards.

ECM requires that the destination machine has the same feature.

---

## Parallel Memory Transmission

---

With this feature the machine can call destinations while scanning documents. Compared with normal Memory Transmission (where the machine calls once all the documents have been stored), it is quick to verify whether a connection has been made or not.

Additionally, as scanning finishes quicker than in Immediate Transmission, it is useful if you wish to take the document back to your desk immediately. However, if the connection cannot be made (for example if the line is busy), normal Memory Transmission takes place.

 **Limitation**

- ❑ Parallel Memory Transmission is not available with G4.

 **Note**

- ❑ Standard Memory Transmission is used instead of Parallel Memory Transmission in the following cases:

- When the line is busy and could not be connected to
- With Send Later
- When you store a document for Memory Transmission while another communication is in progress
- When you send just an Auto Document
- With Duplex Original
- With Batch Original Documents Transmission

- ❑ When the amount of remaining memory drops below a certain level, the machine switches to ordinary memory transmission and the parallel memory transmission feature is disabled until more memory becomes available.

- ❑ If you press the **[Stop]** key, the document jams, or memory becomes full during Parallel Memory Transmission, the machine stops transmitting and prints the Communication Result Report (Memory Transmission). The file is erased.

- ❑ You can switch the Parallel Memory Transmission function on or off with User Parameters. See p.178 "User Parameters" (switch 07 bit 2).

## Printed Reports

### File Reserve Report (Memory Transmission)

This report is printed after a document is stored in memory. It helps you review the contents and registered destinations of documents stored for transmission.

#### Note

- This report is not printed for messages sent using Parallel Memory Transmission.
- You can turn this report on and off. By default it is not printed. See p.178 "User Parameters" (switch 03 bit 2).
- Even if the machine is set up not to print this report, it is still printed if a document could not be stored.
- You can choose whether to include part of the document image on the report (part of the image is printed by default). This feature is not available for Confidential Transmission. See p.178 "User Parameters" (switch 04 bit 7).
- With User Parameters, you can set the machine to print out this report when scanning documents is interrupted because the machine's memory runs out, or if a document jam occurs. See p.178 "User Parameters" (switch 04 bit 6).

### Communication Result Report (Memory Transmission)

This report is printed when a Memory Transmission is completed, so you can check the result of the transmission. If two or more destinations are specified, the report is printed after the fax message has been sent to all the destinations. If the machine is set up not to print this report and the fax message could not be successfully transmitted, the Communication Failure Report is printed. See p.108 "Communication Failure Report" .

#### Note

- You can print the Journal to check the communication result. See p.50 "Printing the Journal".
- You can turn this report on and off. See p.178 "User Parameters" (switch 03 bit 0).
- You can program a User Function key to switch Communication Result Report printing on or off for each transmission. After the transmission completes, it reverts to the setting with User Parameters. When the User Function key is lit, the report is printed for each transmission. See p.154 "User Function Keys".
- You can choose whether to include part of the document image on the report (part of the image is printed by default). This feature is not available for Confidential Transmission. See p.178 "User Parameters" (switch 04 bit 7).

- 3
- ❑ Normally, when specifying the destination with a Quick Dial key or Speed Dial, "ADDRESS" on this report shows Own Name or Own Fax Number registered in the receiver's machine. However, you can change the setting with User Parameters so that the name or number of the destination stored in the Quick Dial key or Speed Dial in your machine is printed instead. See p.178 "User Parameters" (switch 04 bit 4).

## Communication Failure Report

This report is printed if a memory transmission failure occurs after a job is completed. It is only printed if the Communication Result Report is switched off, and a communication failure occurs.

### Note

- ❑ You can choose whether to include part of the document image on the report. See p.178 "User Parameters" (switch 04 bit 7).

## Transmission Result Report (Immediate Transmission)

If you turn this report on, a report will be printed after every Immediate Transmission so you have a record of whether the transmission was successful or not.

### Note

- ❑ You can switch this report on or off with User Parameters. See p.178 "User Parameters" (switch 03 bit 5).
- ❑ You can program a User Function key to switch Communication Result Report printing on or off for each transmission. After the transmission completes, it reverts to the setting made with User Parameters. When the User Function key is lit, the report is printed for each transmission. See p.154 "User Function Keys".
- ❑ Normally, when specifying the destination with a Quick Dial key or Speed Dial, "ADDRESS" on this report shows Own Name or Own Fax Number registered in the receiver's machine. However, you can change the setting with User Parameters so that the name or number of the destination stored in the Quick Dial key or Speed Dial in your machine is printed instead. See p.178 "User Parameters" (switch 04 bit 4).



# 4. Reception Features

## General

There are two types of reception methods, Immediate Reception and Memory Reception.

Normally, the machine receives all the faxes with Immediate Reception, however, in the case of Confidential Reception (see p.46 "Printing a Confidential Message") receiving Memory-locked messages (see p.48 "Printing a Memory-locked Message") or when you turn on one of the following functions, it receives faxes with Memory Reception.

- Two In One  
See p.121 "Two In One".
- Image Rotation  
See p.122 "Image Rotation".
- Rotate Sort  
See p.122 "Rotate Sort".
- Multi-copy Reception  
See p.120 "Multi-copy Reception".
- Forwarding  
See p.223 "Forwarding".
- TX/RX File Save  
See p.236 "TX/RX File Save Settings".

Apart from the above, when any of the conditions for Substitute Reception occurs, incoming faxes are not printed but stored in memory. See p.111 "Substitute Reception".

---

## Immediate Reception

---

Each page of a received fax message is printed as soon as it is received. This method is used for standard fax messages.

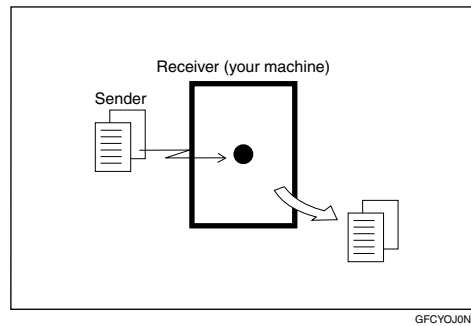

---

### 💡 Display during reception

The sender's Own Name or Own Fax Number appears on the first line.

---

### 🔍 Reference

p.55 "Own Name/Fax Header/Own Fax Number", <Basic Features>

## Memory Reception

The machine waits until all pages of the message have been received into memory before printing the message.

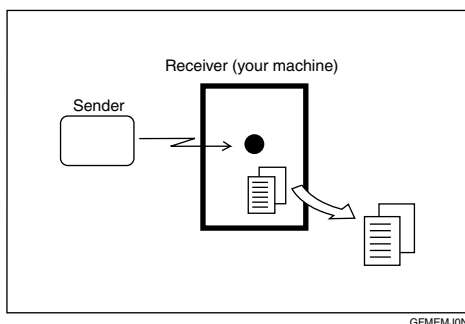

4

### Important

- If the power switch is turned off for 12 hours or longer, documents saved in memory are deleted.
- If this function is turned on, you may not be able to receive very large or detailed faxes. If this happens, we recommend that you turn this function off.

### Limitation

- The machine may not be able to receive fax messages when available memory space becomes less than 3%. However, this limitation does not apply when the Optional 40MB Memory Card is installed.



### Note

- If free memory space reaches 0% during Memory Reception, the machine can no longer receive the current fax message and stops communicating.
- When the Image Rotation function is turned on, the machine receives faxes with Memory Reception.

## Substitute Reception

If any of the conditions listed below are met, the machine automatically switches to Memory Reception mode and stores messages in memory instead of printing them. This reception mode, in which a received fax message is stored in memory and not printed, is called Substitute Reception. Messages received using Substitute Reception are automatically printed when the problem which caused the machine to use Substitute Reception is rectified.

The table below lists some problems that could have caused Substitute Reception to take place and their solutions.

Why Substitute Reception Occurred	Indication/Status	Solution
Paper has run out.	 is lit red.	Add paper. See p.103 "Loading Paper in the Main Paper Tray", <Basic Features>.
Toner has run out.	 is lit red.	Replace the toner cartridge. See p.113 "Replacing the Toner Cartridge", <Basic Features>.
Paper is jammed.	"Open cover marked by the arrow and remove the document." is displayed.	Remove the jammed paper. See p.110 "Clearing Paper Jams", <Basic Features>.
Cover is open.	"Cover open. Please shut the cover marked with the arrow." is displayed.	A cover other than the Auto Document Feeder (ADF) or front cover is open. See p.18 "Guide to Components", <Basic Features>.
The machine is in Energy Saver Mode.	"Energy Saver Mode" indicator and "Receive File" are lit.	Press the <b>【Clear Modes/Energy Saver】</b> key.
Machine is busy printing with another function.	Another function, such as the optional printer function, is currently printing.	The message will be printed after the current job finishes automatically.

### Note

- You can switch this function on or off with User Parameters. See p.178 "User Parameters" (switch 05 bit 0).

---

## Screening Out Messages From Anonymous Senders

---

To help you screen out unwanted messages that may fill up your memory, the machine can be programmed to only use Substitute Reception for messages that arrive with Own Name/Own Fax Number identification.

Two settings are available:

- "When a name or fax number is received"
- "Free"

### Important

- If a sender has not programmed their Own Name or Own Fax Number, the machine may reject an important fax message. We recommend that you ask important senders to register an Own Name or Own Fax Number in advance.

### Note

- If "When a name or fax number is received" is selected, the machine only stores messages when the name or fax number is present. You can change this with User Parameters. See p.178 "User Parameters" (switch 05 bit 1).

### Reference

p.55 "Own Name/Fax Header/Own Fax Number", <Basic Features>

### ❖ When a Name or Fax Number is received

The machine switches to Substitute Reception only when the sender has programmed their Own Name or Own Fax Number. If the power switch is turned off for 12 hours or longer, all the messages received are deleted. In such a case, the Power Failure Report or the Journal can be used to identify which messages are lost so you can ask the senders to transmit them again. You can also use this function to screen out unwanted messages, thus conserving memory.

### ❖ Free

The machine switches to Substitute Reception regardless of whether or not the sender has programmed their Own Name or Own Fax Number.

# Selecting the Reception Mode

There are two ways you can set up your machine to handle incoming calls:

- Fax mode (Auto Receive Mode)
- Tel mode (optional handset or external telephone required)

## Reference

p.53 "Reception Modes", <Basic Features>

---

## Fax Mode (Auto Receive Mode)

---

When a telephone call comes in, the machine receives it automatically as a fax message. Use this setting for a dedicated fax line.

---

## Telephone Mode

---

When a call comes in, you have to pick up the optional handset or external telephone and decide whether the call is a fax message yourself. If you hear a voice, continue your conversation as you would using a normal telephone. If you hear high pitched beeps, instruct the machine to receive the fax by following the procedure below.

Use this setting if you wish to share the line between the fax machine and a telephone.

---

## Receiving a fax in Telephone Mode

---

**1** When the machine rings, pick up the handset.

**2** If you hear beeps, press the **[Start]** key.

### Note

- Remove any originals from the machine before pressing the **[Start]** key.

**3** Replace the handset. The machine will start receiving.

# Reception Functions

## Transfer Station

Transfer Stations allow you to expand the standard features of your fax machine to set up complex networks.

The diagram below may make the concept clearer.

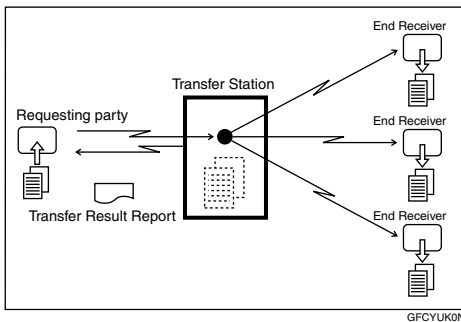

The following terminology is used in this section:

### ◆ Requesting Party

The machine where the message originates from, i.e. the machine making a Transfer Request.

### ◆ Transfer Station

The machine that forwards the incoming message to another destination, i.e. the machine that receives the Transfer Request. In this section this refers to your machine.

### ◆ End Receiver

The final destination of the message, i.e. the machine that the Transfer Station sends to. End Receivers must be programmed into Quick Dial keys, Speed Dials or Groups in the Transfer Station (this machine).

### 📁 Preparation

Store the end receiver fax numbers beforehand in the Transfer Station's Quick Dial keys, Speed Dials or Groups. See p.63 "Quick Dial", <Basic Features>, p.76 "Speed Dial", <Basic Features> and p.87 "Groups", <Basic Features>.

You need to program the Requesting Party's fax number in either a Quick Dial key or Speed Dial of the Transfer Station's machine (this machine) beforehand.

### 💡 Limitation

- Polling IDs of the Requesting Party and Transfer Station must be identical for this feature to work. See p.199 "Registering ID Codes".
- The return address must be registered with Transfer Station(s) beforehand. See p.202 "Transfer Report".
- When programming the Requesting Party's fax number in Speed Dial, only the numbers "000" to "099" are available even though Optional Function Upgrade Unit is installed.

### 📝 Note

- This machine will not receive a Transfer Request unless it has enough free memory to store two or more destinations dialed from the number keys. See p.46 "Entering Numbers Directly", <Basic Features>.
- If one of the specified end receivers is not registered in the Transfer Station, the transfer is halted.

- ❑ If the Requesting Party specifies a Group for the End Receivers and the total number of End Receivers exceeds 250, the Transfer Station cannot transfer the message and sends a Transfer Result Report to the Requesting Party.

### Reference

p.28 "Transfer Request"

---

## Transfer Result Report

---

This reports whether transmission to the End Receivers was successful or not.

When the Transfer Station has transferred the message to all End Receivers, it sends the Transfer Result Report back to the Requesting Party. The machine prints the report if it cannot be sent back to the Requesting Party.

### Preparation

You must program the fax number of the requesting party in a Quick Dial key or Speed Dial in the Transfer Station. Also, the return address of the machine needs to be registered beforehand. See p.202 "Transfer Report".

### Note

- ❑ You can set whether a portion of the document image is printed on this report with User Parameters. See p.178 "User Parameters" (switch 04 bit 7).

## Sending the Transfer Result Report

This machine compares the fax number of the Requesting Party with the Requesting Party's number programmed in a Quick Dial key or Speed Dial, and if the last five digits of the two numbers match, it sends the Transfer Result report to the Requesting Party.

- Requesting Party's own dial number:  
**001813-11112222**
- Transfer Station's Quick Dial:  
**03-11112222**

---

## Multi-step Transfer

---

The principles of Transfer Stations can be used to build up a multi-step facsimile network where messages are passed through several Transfer Stations. By programming the End Receivers in a Transfer Station Group, you can enable this machine to transfer messages onto other Transfer Stations.

For more information, contact your service representative.

### Reference

p.136 "Multi-step Transfer Group Settings"

## Remote Transfer

This feature allows same make or other make fax machines without the Transfer Request function to perform transfer requests to this machine.

### Preparation

In order for this machine to perform this function, you need to register the Remote ID, and the Transfer Result Report return address in the Quick Dial key or Speed Dial. See p.199 "Registering ID Codes", p.63 "Quick Dial", <Basic Features> and p.76 "Speed Dial", <Basic Features>.

### Limitation

- The requesting party's fax machine must be able to send out a push signal.
- The Remote Transfer function only works with the standard and optional G3 line. The optional ISDN Unit and NIC FAX Unit (Option for Type1) are not supported.

### Note

- You can select whether the machine accepts remote transfers or not with User Parameters. See p.178 "User Parameters" (switch 11 bit 0).

### How to make a Remote Transfer Request (push signal)

This procedure describes how to make a Transfer Request to this machine from the requesting party's machine.

### Note

- To cancel the operation in progress, press the **【#】** key twice.

**1** Set the original and select any scan settings you require.

**2** Dial using On Hook Dial, or lift the handset and dial.

**3** When the connected line is a dial line, the machine switches over so it can send a push signal.

**4** When you hear the reception tone, press the **【#】** key.

When the remote transfer is accepted, you will hear a confirmation "peeee" tone.

### Note

- If remote transfer is turned off on the machine at the other end, you will not hear a confirmation tone and the tone mentioned in step **4** will continue.
- If the Transfer Request is not accepted, for example if memory is full or the Remote ID has been wrongly entered 5 times, you will hear five "pee-po" tones and the line will be cut off.

**5** Enter the 4-digit Remote ID stored in the Transfer Station, then press the **【#】** key.

When you enter the correct ID, you will hear a "peeee" tone.

### Note

- If you do not carry out steps **5** to **10** within 30 seconds, the line will be cut off.
- Enter the next tone within 5 seconds. If you wait too long, you will hear a "pee pee pee" tone and you must start the whole procedure again.



- If you enter the wrong Remote ID 5 times, the line will be automatically cut off, and if you do not change this machine's Remote ID, remote transfer will not be accepted. The figure of 5 carries over from previous non-valid attempts.
- If you enter the wrong ID, you will hear a "pee pee pee" tone. If this happens, try again.

**6** Press **[2][4][#]**.

**7** Press the **[\*]** key 3 times. Specify the Transfer Result Report return address stored in the Transfer Station using the procedure below, then press the **[#]** key.

If the return address is correct, you will hear a "peeee" tone.

---

#### When the Return Address is Stored in a Quick Dial Key

---

**1** Enter the number (001-144) of the Quick Dial key.

---

#### When the Return Address is Stored in a Speed Dial

---

**1** Press the **[\*]** key, then enter the Speed Dial code (00-99).

 **Note**

- If you hear a "pee pee pee" tone, press the **[\*]** key 3 times and enter the return address again.
- If you keep getting the error tone, the return address may not be registered in the Quick Dial key or Speed Dial you are specifying.

- When the optional Function Upgrade Unit is installed, enter a Speed Dial code in the range 000 to 999.

**8** Specify the end receiver then press the **[#]** key.

If the end receiver is correct, you will hear a "peeee" tone.

---

#### Specifying the End Receiver with a Quick Dial Key

---

**1** Enter the number (001-144) of the Quick Dial key.

---

#### Specifying the End Receiver with a Speed Dial

---

**1** Press the **[\*]** key, then enter the Speed Dial code (00-99).

 **Note**

- When the optional Function Upgrade Unit is installed, enter a Speed Dial code in the range 000 to 999.

---

#### Specifying the End Receiver with a Group

---

**1** Press the **[\*]** key twice, then enter the Group number (01-09).

 **Note**

- Specify an end receiver that has been stored in a Quick Dial key, Speed Dial or Group.
- If you hear a "pee pee pee" tone, specify the end receiver again.

- If you keep on getting the error tone, the end receiver may not be registered in the Quick Dial key or Speed Dial you are specifying.
- When the optional Function Upgrade Unit is installed, enter a Group number in the range 01 to 30.

**9** Repeat step **8** for all end receivers.

 **Note**

- If you specify 30 end receivers, the Transfer Request is accepted and you will hear a "pee pee pee" tone. In this case, proceed to step **10**.

**10** Press the **[#]** key twice.

The Transfer Request is accepted and you will hear a "pee pee pee" tone.

**11** When you hear the reception tone again, press the **[Start]** key.

Your document will be sent.

---

## Remote Transfer with UUI

---

*This function requires the optional ISDN Unit.*

It allows G4 faxes with the UUI feature to make Transfer Requests to this machine using UUI instead of a push signal with the same code. See p.83 "UUI".

 **Preparation**

You need to store the Tone (UUI) function in a User Function key beforehand. See p.154 "User Function Keys".

 **Note**

- You can specify up to 30 end receivers with UUI.
- You can select whether or not the machine accepts remote transfers with User Parameters. See p.178 "User Parameters" (switch 11 bit 0).

---

## How to make a Remote Transfer Request (UUI)

---

This procedure describes how to make a Transfer Request to this machine from the requesting party's machine.

**1** Set the original and select any scan settings you require.

**2** Select G4 then enter the fax number of the Transfer Station.

**3** Specify the UUI.

 **Note**

- On machines of this type, press the **[User Function]** key assigned to Tone (UUI) then enter the UUI.

#### 4 Press the **[Start]** key.

#### Remote Transfer Example Input

- Destination (Transfer Station) telephone number = 061234567
- Remote ID = 7777
- Transfer Request Result Report return address = Speed Dial 01
- End Receivers = Quick Dial 002, Speed Dial 03, Group 04  
061234567 • **【#】7777【#】24**  
**【#】【\*】【\*】【\*】【\*】01**  
**【#】002【#】【\*】03【#】【\*】**  
**【\*】04【#】【#】【#】**  
(entering the underlined parts as the UUI)

## ID Reception

If you wish to limit reception of messages to those from machines of the same make and with the same Polling ID, contact your service representative to enable this feature.

### Reference

- p.199 "Registering ID Codes"
- p.94 "ID Transmission"

## JBIG Reception

Use this feature to receive messages sent to you using the high compression protocol known as JBIG (Joint Bi-level Image Experts Group).

### Reference

- p.102 "JBIG Transmission"

# Printing Functions

## Center Mark

When this function is turned on, marks are printed halfway down the left side and at the top center of each page received. This makes it easy for you to position the hole puncher correctly when you file received messages.

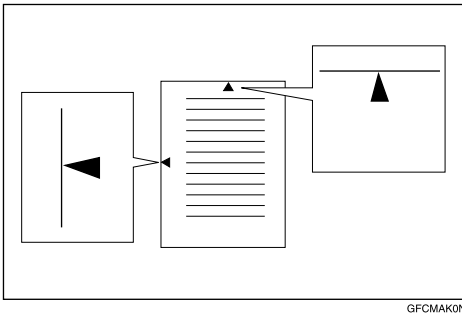

**Note**

- You can turn this feature on or off. See p.178 “User Parameters” (switch 02 bit 1).
- If the size of the image or document is smaller than the upper half of the paper, the left side center mark is not printed.
- The center mark may deviate a little from the exact center of the edge.
- The center mark is not printed when you use the machine for making copies.

## Checkered Mark

When this function is turned on, a checkered mark is printed on the first page of fax messages to help you separate them.

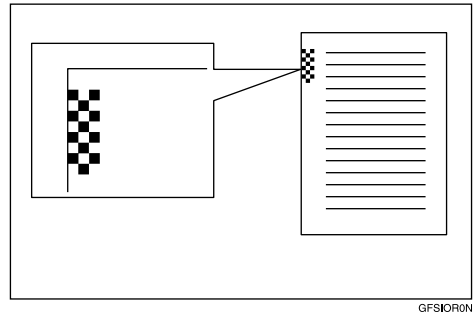

**Note**

- You can turn this feature on or off. See p.178 “User Parameters” (switch 02 bit 4).

## Multi-copy Reception

If you switch this feature on, multiple copies of each incoming fax message will be printed. You can also choose to have multiple copies made of messages from particular senders.

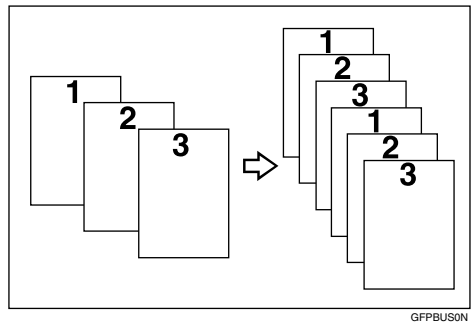

**Note**

- ❑ Only one set of prints is made when using the following features:
  - Confidential Reception
  - Memory Lock Reception
  - Polling Reception
- ❑ You cannot cancel the job in progress by pressing the **[Stop]** key.
- ❑ The maximum number of copies that can be made of each message is 9. If you are using Multi-copy with Specified Senders, the maximum number is 9.
- ❑ You can switch it on and set the number of copies with the Multi-copy Reception. See p.214 "Multi-copy Reception".
- ❑ Note that the machine will use Memory Reception for Multi-copy.

**Reception Time**





You can have the date and time when a message was received printed at the bottom of the received image.

**Note**

- ❑ When a received message is printed on two or more sheets, the date and time is printed on the last page.
- ❑ The date and time of the output is also printed on the message received with Memory Reception.
- ❑ You can turn this feature on or off with User Parameters. See p.178 "User Parameters" (switch 02 bit 2).

**Two In One**

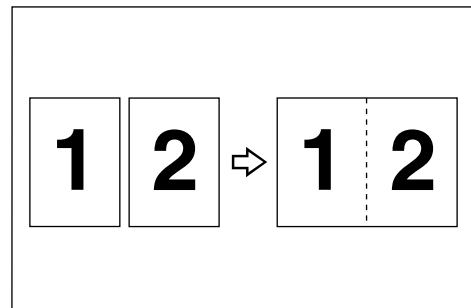

When two messages of the same size and direction are received consecutively, they are printed on a single sheet when you turn this feature on. This can help you economize on paper.

- Two A5  messages are printed side by side on a sheet of A4 .
- Two 8<sup>1</sup>/<sub>2</sub> × 11 "  messages are printed side by side on a sheet of 11 × 17" .



GFSYUION

**Note**

- ❑ This feature does not work with messages larger than A4 , or 8<sup>1</sup>/<sub>2</sub> × 11" . When 8<sup>1</sup>/<sub>2</sub> × 11"  size paper is loaded in the machine, each page of the received message is output onto a single sheet.
- ❑ This feature is not available with Polling Reception or when copying.
- ❑ If the sent pages are of different width, or were sent with different scan settings, this feature is not available.
- ❑ If paper matching the size and direction of a received document is not available, Two In One is not possible.

- ❑ This feature is not available when the Image Rotation function is turned on. See p.122 “Image Rotation”.
- ❑ You can turn this feature on or off with User Parameters. See p.178 “User Parameters” (switch 10 bit 1).
- ❑ This feature uses Memory Reception.

## Image Rotation

4

If you have installed paper in the tray sideways , incoming fax messages will be rotated automatically to fit on the paper.

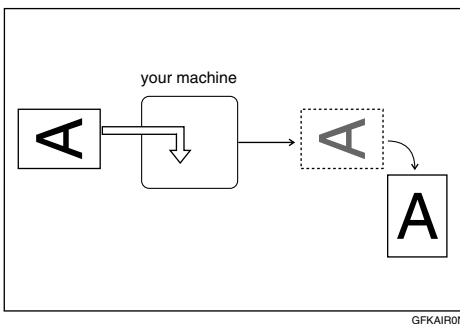





GPKAIRON

### Note





- ❑ This feature is not available with Polling Reception.
- ❑ You can turn this feature on or off with User Parameters. See p.178 “User Parameters” (switch 10 bit 2).
- ❑ Two In One setting is disregarded when this function is turned on. See p.121 “Two In One”.
- ❑ The document may be slightly reduced both vertically and horizontally when printed out.
- ❑ You can choose to have received messages printed from a specified tray. See p.220 “Specified Tray”.

- ❑ This feature uses Memory Reception.

## Rotate Sort

When both  $8\frac{1}{2}'' \times 11''$   and  $8\frac{1}{2}'' \times 11''$   copy paper is loaded, A4 size incoming faxes are delivered alternating by message between  and  directions.

### Note

- ❑ Rotate Sort is available with the following functions:
  - Memory Reception
  - Substitute Reception
  - Confidential Reception
  - Memory Lock Reception
  - Lists and Reports
- ❑ This feature is not available with Polling Reception.
- ❑ If the Specified Tray function is turned on, output may not alternate between  and .
- ❑ Two In One output is not available.
- ❑ If the incoming message is wider than  $8\frac{1}{2}''$  and neither  $8\frac{1}{2}'' \times 11''$   or  $8\frac{1}{2}'' \times 11''$   paper is loaded, this feature is not available.
- ❑ When  $11'' \times 17''$  paper is loaded, if you receive long documents of  $8\frac{1}{2}''$  width, they are printed on  $11'' \times 17''$  size paper.
- ❑ Documents may not be printed with A4  after the machine exited from Energy Saver Standby mode. See p.300 “Energy Saving”.
- ❑ In order to use this function, Image Rotation needs to be switched on with User Parameters. See p.178 “User Parameters” (switch 10 bit 2).

- You can turn this function on or off with User Parameters. See p.178 "User Parameters" (switch 10 bit 4).

## Page Separation and Length Reduction

When the size of a received message is longer than the paper loaded in the machine, each page of the message can be split and printed on several sheets, or reduced and printed on a single sheet. For example, when 8<sup>1</sup>/<sub>2</sub>"×11" paper is loaded, this feature splits the received message if the excess length is about 90mm (3.6 in.) or more, and reduces it if the excess length is within about 90mm (3.6 in.). When a message is split, the split mark (✱) is inserted at the split position and about 10mm (0.4 in.) of the split area is duplicated on the top of the second sheet.

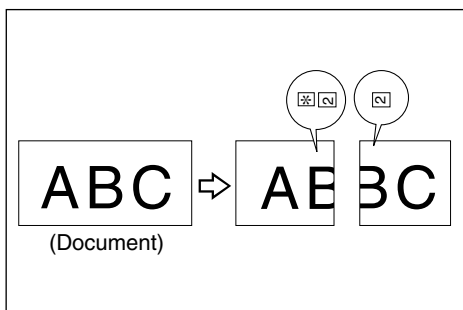

### Note

- Your service representative can customize this feature with the following settings. Bracketed values are defaults.
  - Reduction (on)
  - Print split mark (on)
  - Overprinting (on)
  - Overprinting length (10mm or 0.4 in.)

- Guideline for split (when message is 90mm or 3.6 in. longer than paper)

- You can adjust the overprinting length and length of reduction within the following ranges:

- Guideline for split: 0 - 155mm (0 - 6.1 in.)

## TSI Print

Usually the sender's Fax Header is printed on received messages. If the sender has not programmed their Fax Header, you will not be able to identify them. However, if you turn this feature on, the sender's Own Name or Own Fax Number programmed by the sender is printed instead so you can find out where the message came from.

- TSI = Transmitting Subscriber Identification

### Note

- You can turn this function on or off with User Parameters. See p.178 "User Parameters" (switch 02 bit 3).

## CIL Print

*This function requires the optional ISDN Unit.*

If turned on, this information is printed on every page.

The CIL (Call Identification Line) refers to the combination of the receiver's own fax number, name, the sender's own fax number and name, time, and page number.

**Note**

- You can turn CIL on and off with User Parameters. See p.178 "User Parameters" (switch 02 bit 5).

**TID Print**

*This function requires the optional ISDN Unit.*

If turned on, this information is printed on every page.

The TID (Transmitter ID) refers to the name registered by the sender in their fax header.

**Note**

- You can turn TID on and off with User Parameters. See p.178 "User Parameters" (switch 02 bit 6).

**Reference**

p.55 "Own Name/Fax Header/Own Fax Number", <Basic Features>

**Adjusting the Printing Density**

You can economize on toner by adjusting the image density used when generating all printed output (Output Density), or just for incoming faxes, reports and lists (Toner Saving).

**Output density**

This setting specifies the image density used for printing incoming faxes, reports, lists and copies.

Three levels are available: Dark, Normal, and Light.

**Note**

- When the machine is shipped, the default setting is Normal. You can change this with User Parameters. See p.178 "User Parameters" (switch 12 bits 4,3).

**Toner saving**

Use this feature to save on over 50% of the toner used for printing incoming faxes, reports and lists.

**Limitation**







- This feature does not apply to copies, or prints made with the printer option. However, the optional Printer Interface has its own toner saving function.

**Note**





























































































- If this feature is turned on, it invalidates the Output Density feature and image density is fixed at Normal.
- When receiving faxes sent using Photo (Halftone) mode from this maker's machines, turn Toner Saving off.
- When Toner Saving is turned on, printed images will come out lighter than usual. To check on the image quality, print out the User Parameter List. See p.189 "Printing the User Parameter List".
- If the other party sends you a fax using the Photo (Halftone) mode, the printed fax image may differ from the document image.
- You can turn Toner Saving on or off with User Parameters. See p.178 "User Parameters" (switch 12 bit 2).



# When There Is No Paper of the Correct Size

If there is no paper in your machine that matches the size of a received message, the machine chooses a paper size based upon the paper you have available. For example, if your machine has A4  and 8 1/2"×11"  loaded and you receive a A5  size message, check the A5  column of the table below. The paper size at the top has the highest priority. In this case, since 8 1/2"×11"  is a higher priority than A4 , the message is printed on 8 1/2"×11" .

## ◆ Priority Table

		Reception Size											
		11"×17" 	A3 	B4 	8 1/2"×14" 	8 1/4"×13"  , 8"×13" 	A4 	8 1/2"×11" 	8 1/2"×11" 	A4 	B5 	A5 	
Priority	1	11"×17" 	A3 	B4 	8 1/2"×14" 	8 1/4"×13"  , 8"×13" 	A4 	8 1/2"×11" 	8 1/2"×11" 	A4 	B4 	A5 	
	2	A3  *2	11"×17" 	A3 	8 1/4"×13"  , 8"×13" 	A4  *2	A4  *1	8 1/2"×11"  *1	8 1/2"×11"  *1	A4  *1	A4 	8 1/2"×11" 	
	3	8 1/2"×11"  	8 1/2"×11"  	11"×17" 	A4  *2	A4  *1,2	8 1/2"×11"  *2	A4 	A4 	8 1/2"×11" 	A4  *1	A4 	8 1/2"×11"  *1
	4	8 1/2"×11"   *1	8 1/2"×11"   *1	8 1/2"×11"  	A4  *1,2	8 1/2"×11"  *2	8 1/2"×11"  *1,2	A4  *1	A4  *1	8 1/2"×11"  *1	8 1/2"×11" 	A4 	
	5	A4  	A4  	8 1/2"×11"   *1	8 1/2"×11"  *2	8 1/2"×11"  *1,2	8 1/4"×13"  , 8"×13" 	8 1/4"×13"  , 8"×13" 	A3 	A3 	8 1/2"×11"  *1	A4  *1	
	6	A4  *1	A4  *1	A4  	8 1/2"×11"  *1,2	A3  *1,2	8 1/2"×14" 	8 1/2"×14" 	11"×17" 	11"×17" 	A3 		8 1/4"×13"  , 8"×13" 

		Reception Size										
		11"×17" ☐	A3☐	B4☐	8½"×14" ☐	8¼"×13" ☐, 8"×13" ☐	A4☐	8½"×11" ☐	8½"×11" ☐	A4☐	B5☐	A5☐
Priority	7			A4☐ ☐ *1	A3☐ *1, 2	11"×17" ☐ *1, 2	A3☐ *1	11"×17" ☐ *1, 2			11"×17" ☐	8½"×14" ☐
	8				11"×17" ☐ *1, 2	8½"×14" ☐	11"×17" ☐ *1, 2	A3☐ *1				11"×17" ☐ *1
	9				B4☐	B4☐	B4☐	8½"×11" ☐ *2				A3☐ *1
	10				A3☐	A3☐	A3☐	B4☐				A4☐
	11				11"×17" ☐	11"×17" ☐	11"×17" ☐	A3☐				8½"×11" ☐
	12				A5☐☐	A5☐☐	A5☐☐	11"×17" ☐				B4☐
	13				8½"×11" ☐☐	8½"×11" ☐☐	8½"×11" ☐☐	A5☐☐				A3☐
	14				A4☐☐	A4☐☐	A4☐☐	A4☐☐				11"×17" ☐

\*1 The printed image is rotated by the Image Rotation function.

\*2 The printed image is reduced in size.

**Important**

☐ The width of document that fax machines can receive is that of 8½"×11", 8½"×14", 11"×17", A4, B4 or A3 size. Any document whose width is less than 8½"×11" or A4 width is sent as 8½"×11" or A4 with the length unchanged.

**Note**

- ☐ The paper size used to print a received message may be different from the size of the sent original.
- ☐ ☐☐ and ☐☐ indicate that the message is split over two pages of paper with the orientation and size shown (Page Separation).

**Reference**

- p.123 "Page Separation and Length Reduction"
- p.122 "Image Rotation"

## Copying

This section describes how to make copies.

### Important

- ❑ When making multiple copy sets, copying starts once all originals have been scanned into memory. If memory runs out (free memory reaches 0%) while scanning in, the copy job is canceled and the scanned data is deleted from memory. However, copying the scanned original is possible if you select Stack as the output order for multiple copying.

### Note

- ❑ Recommended originals are the same as recommended documents for fax transmission. Set the original and select any scan settings in the same way as for fax transmission.
- ❑ You cannot set the Resolution to Super Fine in Copy mode. However, you can do so by installing the Optional 40MB Memory Card and enabling Super Fine resolution in Copy mode with User Parameters. See p.178 "User Parameters" (switch 20 bit 1).
- ❑ When turning the "EXTRA SUPER FINE IN TRANSMISSION MODE" on with User Parameters (switch 20 bit 1), the machine may not be able to send or receive fax messages using multiple lines, or copy or print received messages.
- ❑ In order to use copy paper that you cannot load in the main paper tray or optional Paper Tray Unit(s), you need to install the optional Bypass Tray Unit. See p.129 "Making Copies on Special Paper".
- ❑ You can set the output order of multiple sets of copies to Sort (1,2,3,1,2,3) or Stack (1,1,2,2,3,3) with User Parameters. See p.178 "User Parameters" (switch 09 bit 7).
- ❑ If you wish to prevent passersby from freely making copies, you can disable the copy feature with User Parameters. See p.178 "User Parameters" (switch 12 bit 7).
- ❑ There may be slight difference in the size and quality of printed image between fax transmission and copy feature.
- ❑ The margins of error when copying at 100% magnification are as follows:
  - Horizontal: +2.0%, -2.5%
  - Vertical: +1.5%, -2.0%
- ❑ The copying feature is available only in standby mode. If the machine is in another operation mode, make it return to standby mode. See p.25 "Standby Display", <Basic Features>.

**1** Press the **[Copy]** key.

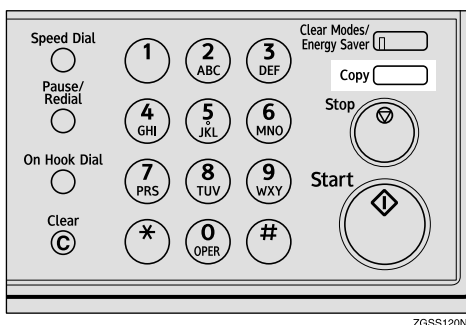

The Resolution automatically changes to Super Fine.

**Note**

- If you press the **[Copy]** key again, the machine returns to standby mode.

5

**2** Set the original.

**Note**

- If the optional Paper Tray Unit(s) is installed, the machine searches the paper sources for copy paper that has the same width as your original in the following order, and selects the paper source: main paper tray, optional Paper Tray Unit(s), optional Bypass Tray Unit. You can also select which paper source to be searched first with User Parameters. See p.178 "User Parameters"(switch 19 bits 7,6,5).

**3** Select any scan settings as necessary.

**4** Press **◀** or **▶** key to select the copy paper size.

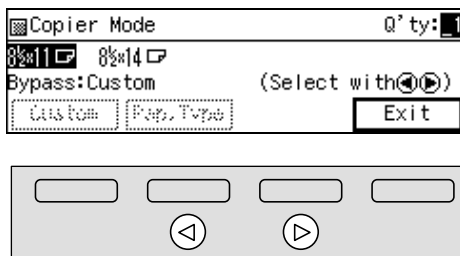

**Note**

- You cannot select the paper size if the optional Paper Tray Unit(s) or optional Bypass Tray Unit is not installed.
- If you choose copy paper smaller than the originals in width, copied images will be reduced in size.
- If your original is larger in length than the copy paper you select, the excess part of the original image will not be copied.

**5** If you are making multiple copies, enter the number of copies with the number keys.

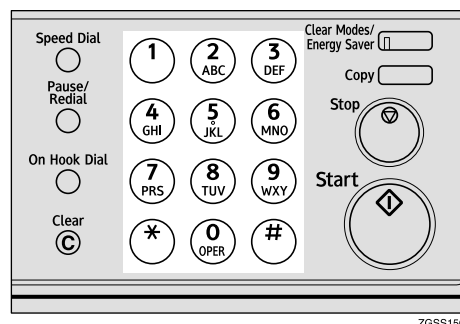

**Note**

- You can specify between 1 and 99 copies.
- If you incorrectly enter the number, press the **[Clear]** key or **[Stop]** key and try again.

## 6 Press the **[Start]** key to start copying.

When copying is complete, standby display reappears.

### Note

- ❑ To stop copying while it is in progress, press the **[Stop]** key. Then open the ADF cover and ADF unit and remove any originals that are left inside.

### Reference

p.108 "Clearing Original Jams",  
<Basic Features>

## Making Copies on Special Paper

You can make copies on special paper that cannot be loaded in the main paper tray or optional Paper Tray Unit by using the optional Bypass Tray Unit.

Set the copy paper with the printable side facing down.

You can use the following types of special paper:

- Paper that weighs between 60 and 90 g/m<sup>2</sup> (16 to 24 lb)
- OHP transparencies
- Adhesive labels
- Postcards

### Important

- ❑ If the paper is curled, flatten it before loading in order to avoid paper jams.

### Note

- ❑ You can load paper in the Bypass Tray Unit up to approximately 100 sheets (8<sup>1</sup>/<sub>2</sub>"×11" or smaller size), or 10 sheets (larger than 8<sup>1</sup>/<sub>2</sub>"×11" size). Up to 40 postcards can be loaded.
- ❑ Load OHP transparencies one sheet at a time, and remove them from the paper tray immediately after copying is complete.
- ❑ When making copies on OHP transparencies, an unusual sound may be emitted depending on the type of OHP transparency. To avoid this, place a sheet of quality paper on top of the OHP transparency when loading.
- ❑ Load postcards in the landscape orientation (☐).
- ❑ Postcards that are curled in the center may cause a paper jam. Be sure to flatten them before loading.

## 1 Press the **[Copy]** key.

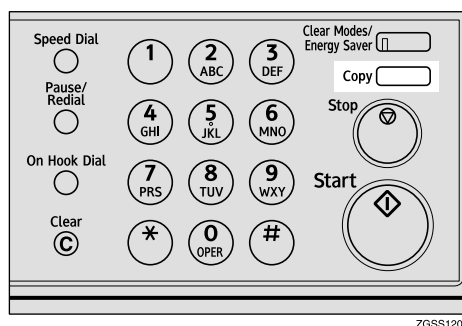

## 2 Set the original, and select any scan settings as necessary.

**3** Press **⏪** or **⏩** key to select the paper size of the optional Bypass Tray Unit.

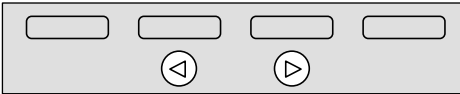
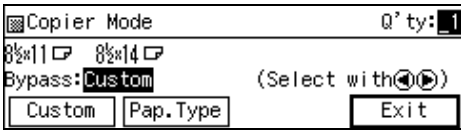

ZGSS250N

**Note**

You can enter the paper size by pressing **[Custom]**. However, this is possible only when **[Custom]** is displayed as the paper size of the optional Bypass Tray Unit (the size mark is located at the "✳" mark).

You can specify the paper thickness by pressing **[Pap.Type]**.

**Specifying the Paper Size**

- 1** Press **[Custom]**.
- 2** Press **⏪** or **⏩** key to select **[Horizontal]** or **Vertical**, and enter the value of the paper size.

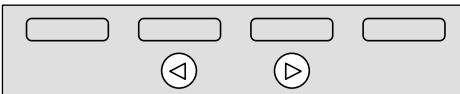
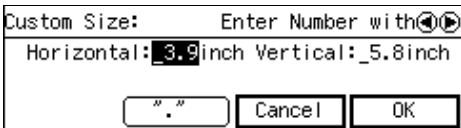

ZGSS250N

**Note**

Press the **[Clear]** key or **[Stop]** key before entering the value.

You can enter the paper size in the following range:

- Width: 100 to 297 mm (3.9 to 11.6 in.)
- Length: 148 to 432 mm (5.8 to 17.0 in.)

**3** Press **[OK]**.

**Specifying the Paper Type**

- 1** Press **[Pap.Type]**.
- 2** Press **⏪** or **⏩** key to select the desired paper type.

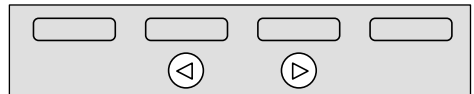
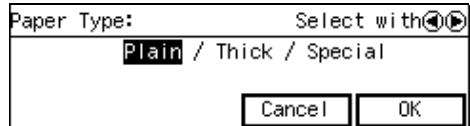

ZGSS250N

**Note**

Select **[Thick]** when making copies on postcards.

**3** Press **[OK]**.

**4** If you are making multiple copies, enter the number of copies with the number keys.

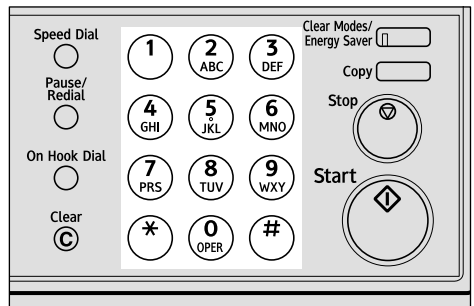

ZGSS150N

**5** Press the **[Start]** key to start copying.

When copying is complete, the machine returns to standby mode.

# 6. Facsimile User Tools

## Accessing the User Tools

You can utilize fax features in full by accessing the User Tools and storing fax numbers of destinations or registering often used functions. You can also enable various functions such as Printing Reports/Lists, User Function Keys or Fax On Demand.

You can make settings for the functions described in the table below.

The following options are necessary for using functions with the corresponding number:

\*1 NIC FAX Unit (Option for Type1)

\*2 Optional Fax On Demand Unit

Function Name		Description	Reference
Program/ Delete Menu	Registering/Editing and Deleting Quick Dials	Allows you to program a fax number into a Quick Dial key so that you may specify the destination simply by pressing the key.	p.63 "Quick Dial", <Basic Features>
	Registering/Editing and Deleting Groups	Allows you to program multiple fax numbers as a group so that you may easily specify multiple fax numbers as destinations.	p.87 "Groups", <Basic Features>
	Registering/Editing and Deleting Speed Dials	Allows you to program a fax number as a Speed Dial destination so that you may specify the fax number as a destination simply by pressing the <b>[Speed Dial]</b> key and then the two-digit or three-digit (when the optional Function Upgrade Unit is installed) Speed Dial number.	p.76 "Speed Dial", <Basic Features>
	Storing/Editing and Deleting Keystroke Programs	Allows you to program a fax number or a series of key operations that you regularly use into a Quick Dial key.	p.139 "Storing and Changing Keystroke Programs"
	Registering/Editing and Deleting Auto Documents	Allows you to store a document that you often use in memory and send or print it when needed by using a Quick Dial key.	p.145 "Registering Auto Documents"
	Address Template *1	Allows you to program a string of text to the <b>[★]</b> key of Quick Dial. You can call out the text when entering texts such as e-mail addresses.	Chapter 6, "Registering Texts" in the NIC FAX Unit manual

Function Name		Description	Reference
Reports/ Lists	Journal	Allows you to print the Journal manually. You can check information about the recent 50 communications (receptions + transmissions).	p.50 "Printing the Journal"
	Quick Dial List/Quick Key Label	Allows you to print the fax numbers programed into Quick Dial keys to check the contents. You can also print labels for Quick Dial keys.	p.73 "Quick Dial Key Label (Dial Label)", <Basic Features>
	Group Dial List	Allows you to print and check destinations registered in Groups.	"Re-ports/Lists"
	Speed Dial List	Allows you to print and check destinations programmed in Speed Dial.	p.149 "Re-ports/Lists"
	Keystroke Program List	Allows you to print and check contents of Keystroke Programs.	p.149 "Re-ports/Lists"
	Auto Document	Allows you to print and check documents stored in Auto Document.	p.149 "Re-ports/Lists"
Setup	Monitor Volume	Allows you to adjust the volume of sounds emitted from the machine's internal speaker such as monitoring sounds, the buzzer, or key sound.	p.104 "Adjusting Volume", <Basic Features>
	Adjusting the Display Contrast	Allows you to adjust the contrast of the control panel display.	p.151 "Adjusting the Display Contrast"
	Date/Time	Allows you to set the machine's internal clock to the current time, which is used for features such as Send Later.	p.151 "Date/Time"
	Summer Time/DST	Allows you to advance the machine's internal clock or set the clock back to observe the Summer Time.	p.151 "Date/Time"
	Registering Own Name and Fax Header	Allows you to register information displayed on the other party's machine or printed on the header of every fax you send. You can register one Own Name (Receive Terminal Identification) and two Fax Headers (TTI).	p.55 "Own Name/Fax Header/Own Fax Number", <Basic Features>
	Adjusting the Scanner RGB <sup>*1</sup>	Allows you to adjust the color balance for scanning color originals using the Network Scanner function.	Chapter 5, "Scanner RGB" in the NIC FAX Unit manual
	Fax Reset Timer	Allows you to set the duration of time before the machine automatically returns to standby mode.	p.152 "Fax Reset Timer"
	On Hook Timer	Allows you to set the duration of time before the On Hook status is cleared when a fax message is sent using On Hook Dial.	p.153 "On Hook Timer"



Function Name		Description	Reference
User Function Keys		Allows you to program each of the User Function keys ( <b>F1</b> ) to <b>F10</b> ) with a desired function. You can also assign a function that you often use, so that multiple key operations may be performed by pressing one key.	p.154 "User Function Keys"
Fax On Demand *2	Registering and Editing Fax On Demand Documents	Allows you to register or edit documents offered for the fax information service.	p.160 "Registering/Editing Fax On Demand Documents"
	Deleting Fax On Demand Documents	Allows you to delete documents registered for Fax On Demand.	p.162 "Deleting Fax On Demand Documents"
	Printing Fax On Demand Documents	Allows you to print documents registered for Fax On Demand.	p.164 "Printing Fax On Demand Documents"
	Printing the Fax On Demand List	Allows you to print the list of documents registered for Fax On Demand.	p.165 "Printing the Fax On Demand List"
	Printing the Fax On Demand Access Report	Allows you to check how many times the Fax On Demand documents have been sent successfully / unsuccessfully.	p.165 "Printing the Fax On Demand Access Report"
	Fax On Demand Recorded Messages	Allows you to record the message that the other party hears when he or she makes a request for the Fax On Demand service.	p.166 "Fax On Demand Recorded Messages"

 **Note**

- The numbers that appear with function names on the display vary depending on which options are installed.
- Access the user tools in standby mode. If the machine is in another operation mode, return it to standby mode. See p.25 "Standby Display", <Basic Features>.

## About the Display

- You can scroll through items by pressing [**↑Prev.**] or [**↓Next**].
- You can return to the previous menu by pressing [**PrevMenu**].
- Items on the display are highlighted when selected.
- Press [**OK**] when you finish making settings. The settings that you made are not stored in the machine if you finish the procedure without pressing [**OK**] when accessing User Tools.
- When you press [**OK**] or [**Cancel**], the settings that you made are stored or canceled, and the machine returns to standby mode.

## Counters

This function allows you to check the total number of transmitted, received, scanned, and printed pages on the display.

- **Transmissions:**  
Total number of transmitted pages
- **Receptions:**  
Total number of received pages
- **Scanning:**  
The combined total number of pages that have been scanned in when copying and sending faxes.
- **Printing:**  
The combined total number of pages that have been printed through fax reception, copying, and PC printing (option).

### 1 Press the [**User Tools**] key.

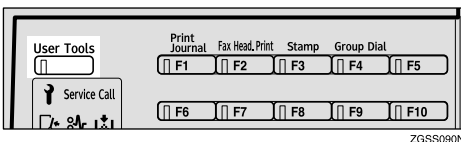

### 2 Press [**Counter**].

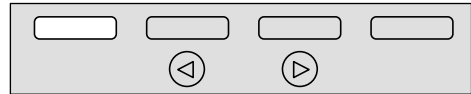
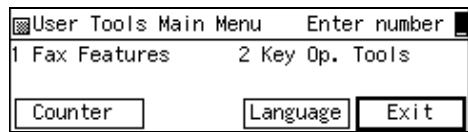

ZGSS190N

### 3 When you have checked the total pages, press [**OK**].

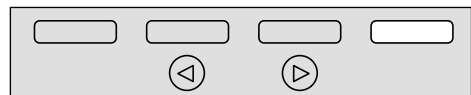
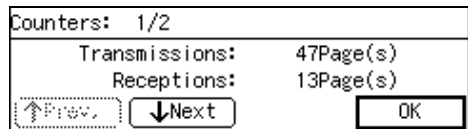

ZGSS220N

The totals are displayed.

Press [**↑Prev.**] or [**↓Next**] to switch between page 1 and 2. Page 1 shows the total number of pages sent and received, page 2 shows the total number of pages scanned and printed.

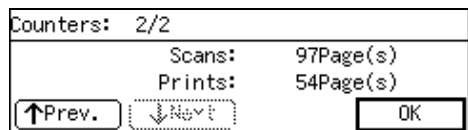

- 4** Press [Exit] to return to the stand-by mode.

## Selecting the Display Language

If your native language is Spanish or French, you can have the messages that appear on displays, lists and reports shown in either of these languages instead of in English. Follow the procedure below to change between the three languages.

- 1** Press the [User Tools] key.

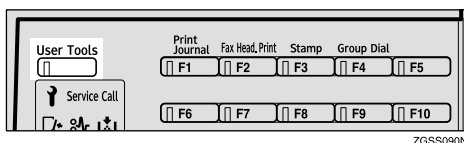

- 2** Press [Language].

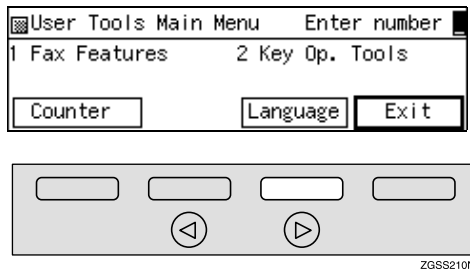

- 3** Press ◀ or ▶ key to select the language you wish to use.

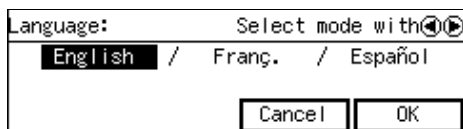

- 4** Press [OK].

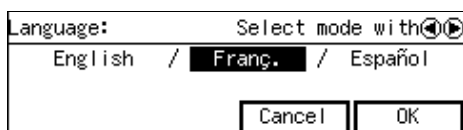

The language is changed.

# Program/Delete Menu

## Multi-step Transfer Group Settings

This procedure describes how to store a Transfer Station in a Group. Once set up, this machine can then forward incoming transfer requests that specify this Group onto the stored Transfer Station. The destination stored in the Group becomes the receiving station (in this case, store 30 or less items in the Group). Messages sent via multiple Transfer Stations further enhance the efficiency of the Transfer Request feature.

**Note**

- For more details, please contact your service representative.

**1** Press the **[User Tools]** key.

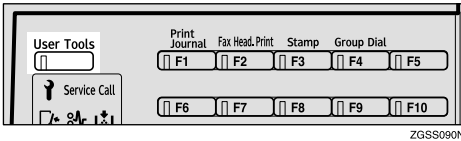

**2** Enter the code for "Fax Features" with the number keys.

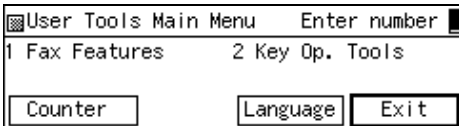

**3** Enter the code for "Program/Delete" with the number keys.

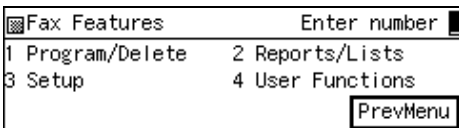

**4** Enter the code for "Prog. Group Dial" with the number keys.

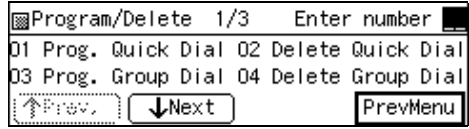

**5** Enter the number of the Group you wish to register or edit with the number keys.

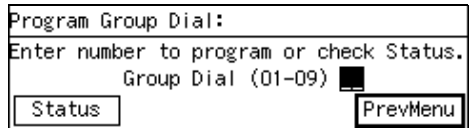

### To Check On Currently Registered Groups

**1** Press **[Status]**.

**2** Enter the number of the Group you wish to register or edit.

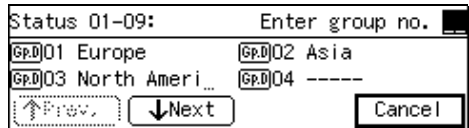

**Note**

- If a free Group is not displayed, press **[↑Prev.]** or **[↓Next]** to search for one.
- If you press **[Cancel]**, the display in step **5** reappears.

- 6** Press **[Left]** or **[Right]** key to select "Multistep Group".

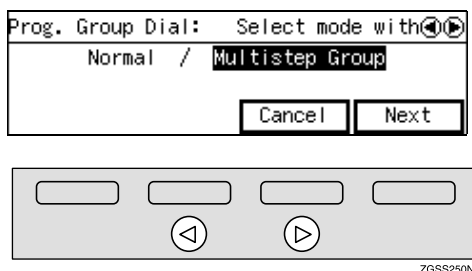

- 7** Press **[Next]**.

- 8** Specify the Transfer Station.



**Note**

- You can enter the Transfer Station fax number using a Quick Dial key, a Speed Dial or the number keys.
- If you make a mistake, press the **[Clear]** or **[Stop]** key and try again.

Choosing the line (the **[Line Selection]** key)

- 1** Press the **[Line Selection]** Key to select the line.

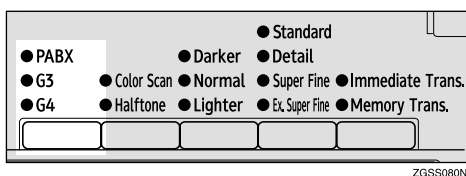

**Note**

- If the optional ISDN Unit or the optional Extra G3 Interface Unit is installed, you can choose which line to use before you enter the fax number by pressing the User Function key (**[F1]** to **[F10]**) which the line selection function is stored in.

- 9** Press **[Recv. Stn]**.

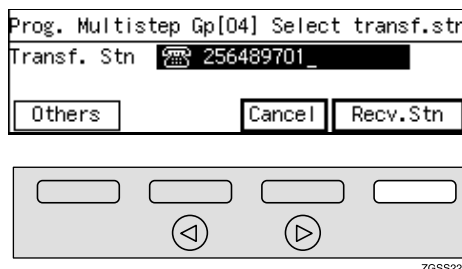

- 10** Specify the end receiver in one of the following ways.

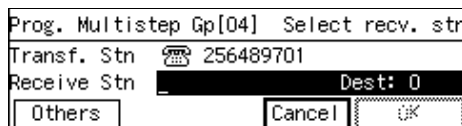

For details about how to specify an end receiver, see p.31 "Specifying an End Receiver".

**Note**

- Specify the end receiver stored in the Transfer Station with the Quick Dial key, Speed Dial or Group.
- The destination specified as the end receiver is passed to the Transfer Station and sent to the number stored in the Transfer Station.

**11** Press [Add RcvStn].

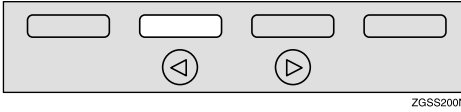
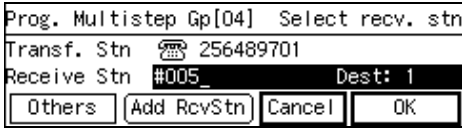

ZGSS200N

**Note**

- If you do not add any end receivers, proceed to step 12.

**12** Specify the remaining end receivers in the same way.

**13** Press [Others].

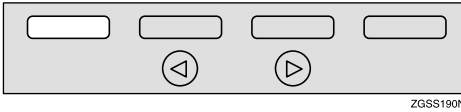
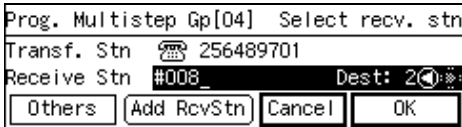

ZGSS190N

Registering/Editing the Group Name

**1** Enter the code for "Group Name" with the number keys.

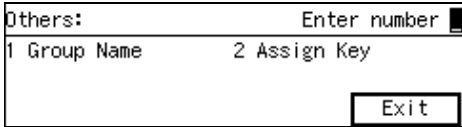

**2** Enter the Group name.

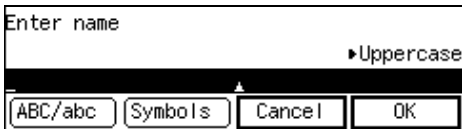

**Note**

- If the name is already stored, it will be shown on the display. To change it, press [Clear] and enter another name.

**Reference**

p.98 "Entering Characters", <Basic Features>

**3** Press [OK].

**4** Press [Exit].

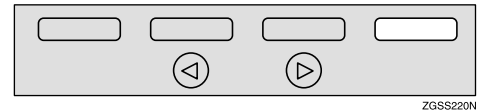
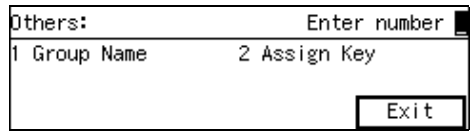

ZGSS220N

Storing the Group in a Quick Dial Key

**1** Enter the code for "Assign Key" with the number keys.

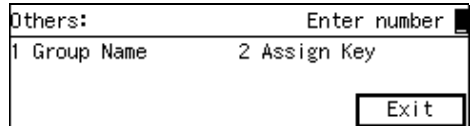

**2** Press the Quick Dial key you wish to store the Group in.

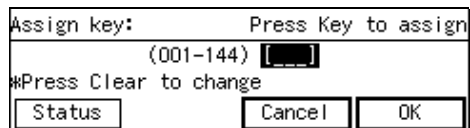

**Note**

- To search for a free Quick Dial key, press [Status].
- If you make a mistake, press the [Clear] key and try again.

**3** Press [OK].

**4** Press [Exit].

Others:	Enter number
1 Group Name	2 Assign Key
Exit	

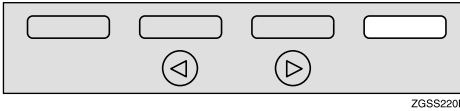

ZGSS220N

**14** Press [OK]

Prog. Multistep Gp[04]	Select recv. stn
Transf. Stn 256489701	[004]
Receive Stn #008_	Dest: 2
Others	Add RcvStn
Cancel	OK

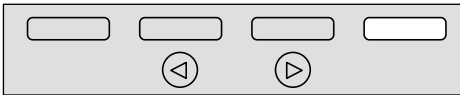

ZGSS220N

**Note**

- If you press ◀ or ▶ key, you can view and check end receivers already stored.
- To delete the displayed end receiver, press the **[Clear]** key.
- To cancel programming this Group, press **[Cancel]**. The display in step **5** will reappear.

**15** Press [PrevMenu] three times.**16** Press [Exit] to return to the standby mode.

## Storing and Changing Keystroke Programs

If you regularly send messages to a particular destination or transmit using the same features, you can save a lot of repetitive keypad operations by storing these settings in a Keystroke Program.

Keystroke Programs can then be recalled by just pressing a Quick Dial key or Speed Dial. The following procedure can be used to program a new Keystroke Program or overwrite an old one.

You can register the following items in Keystroke Programs:

- Memory Transmission, Immediate Transmission, Send Later, Fax Header Print, Confidential Transmission, Transfer Request, Polling Transmission, Free Polling Transmission, Polling Reception, Own Name/Own Fax Number, Transfer Stations, End Receivers, User Codes, Confidential IDs, Polling IDs, SUB Code Transmission with the Mode Key, SEP Code Polling Reception, SEP/SUB/PWD/SID Codes.
- Program name (up to 20 characters)

**Note**

- We recommend that you print the Keystroke Program List and keep it when you register or change a function. See p.149 "Reports/Lists".
- You cannot register a program in a Quick Dial key or Speed Dial already used for another function.
- Keystroke Programs can only be stored in Speed Dials when the optional Function Upgrade Unit is installed.

- ❑ The maximum number of programs you can register is 144 (244 when the optional Function Upgrade Unit is installed).

**1** Press the **[User Tools]** key.

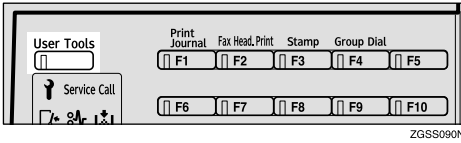

**2** Enter the number of the "Fax Features" with the number keys.

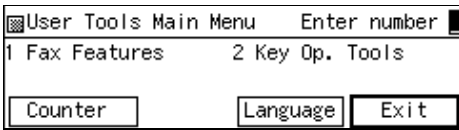

The "Fax Features" main menu appears.

**3** Enter the code for "Program/Delete" using the number keys.

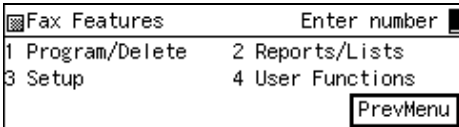

**4** Enter the code for "Store Program" using the number keys.

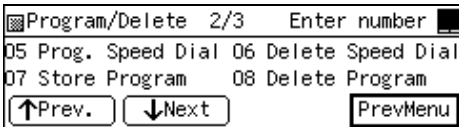

**Note**

- ❑ If "Store Program" is not displayed, press [**↑Prev.**] or [**↓Next**] until it is.

**5** Press a Quick Dial key or enter Speed Dial code you wish to register.

Storing the Program in a Quick Dial Key

**1** Press the Quick Dial key you wish to store or edit the program in.

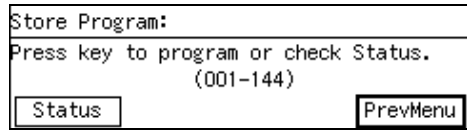

**Note**

- ❑ To check which programs are currently stored, press [**Status**].
- ❑ You can also select the Quick Dial to store the program in from the status screen.

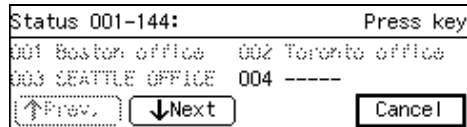

Storing the program in a Speed Dial

**1** Press [**Switch**].

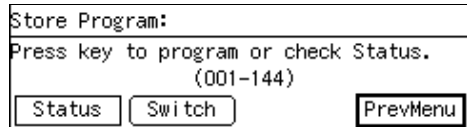

ZGSS190N



- 2** Enter the code of the Speed Dial you wish to store or edit the program in.

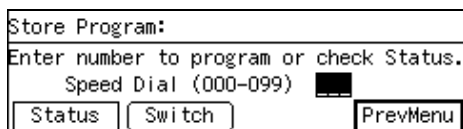

**Note**

- To check which programs are currently stored, press [**Status**].
- You can also select the Speed Dial to store the program in from the status screen.

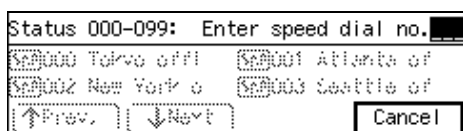

- 6** Press [**Feature**].

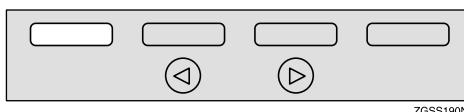
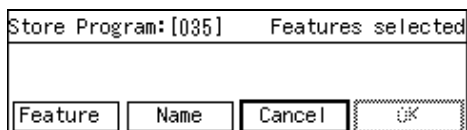

ZGSS190N

- 7** Carry out the operations you wish to store in the program.

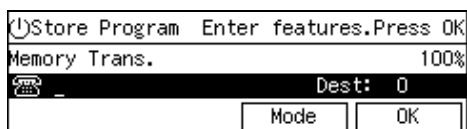

**Note**

- The storing procedure varies depending on the contents of the program.
- If you press the [**Clear Modes/Energy Saver**] key, the whole operation is canceled.

## A Storing Example of Keystroke Program

The following example describes the procedure for storing a Keystroke Program of sending a fax message to a destination whose fax number is 0123456789 by using the Send Later function:

- 1** Press [**0**][**1**][**2**][**3**][**4**][**5**][**6**][**7**][**8**][**9**].
- 2** Press [**Mode**].
- 3** Enter the code for "Send Later" using the number keys.
- 4** Carry out the operations for specifying the Send Later function.

**Note**

- If any program is already stored, the contents of the program is shown. To edit it, press the [**Clear Modes/Energy Saver**] key, and then perform the procedure for storing a new program.

**Reference**

p.5 "Sending at a Specific Time (Send Later)"

- 8** Press [**OK**].

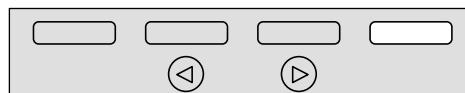
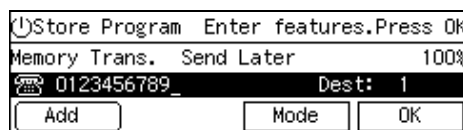

ZGSS220N

**9** Press **[Name]**.

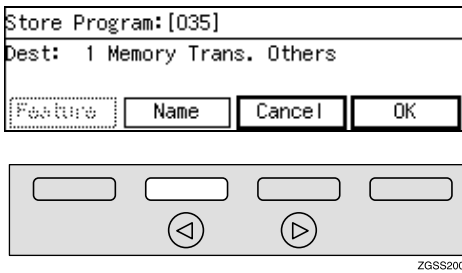

**Note**

- ❑ Storing of program names can be skipped. If you wish to skip it, proceed to step **12**.

**10** Enter the program name.

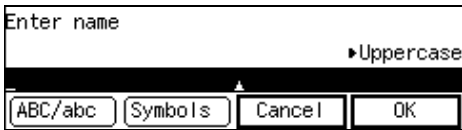

**Note**

- ❑ If a program name is already registered in the Quick Dial key, the name is shown on the display. If you wish to change the program name, press the **[Clear]** key or the **[Stop]** key and enter another name.

**Reference**

p.98 "Entering Characters", <Basic Features>

**11** Press **[OK]**

The function name and program name are shown on the display.

**12** Press **[OK]**.

The program is stored.

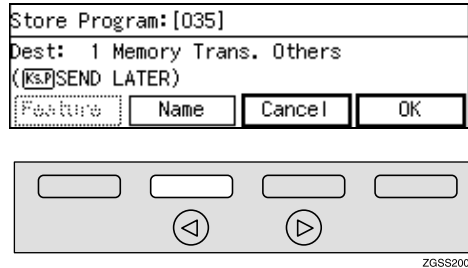

**Note**

- ❑ If you press **[Cancel]**, the Keystroke Program is canceled and the display shown in step **9** appears again.

**13** Press **[PrevMenu]** three times.

**14** Press **[Exit]** to return to the stand-by mode.

**Using a Keystroke Program**

Example: Recalling a program containing fax number "0123456789" and the Send Later function.

**1** Set the original.

**Note**

- ❑ If the destination, resolution, contrast and/or halftone are not registered in the program, carry out these operations now.

- 2 Select the Quick Dial key or Speed Dial with the program stored in by pressing the Quick Dial key, or pressing the Speed Dial key and entering the Speed Dial code.

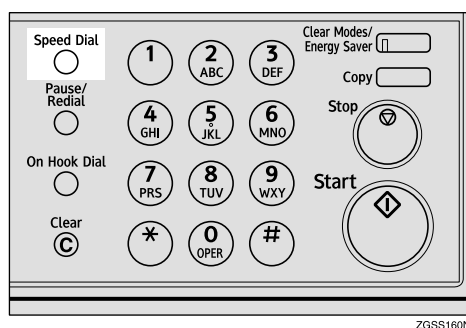
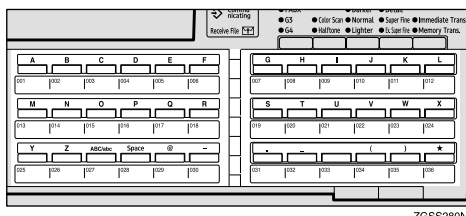

- 3 Press [OK].

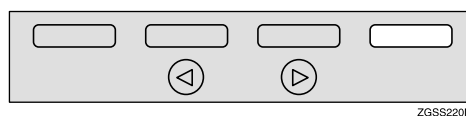
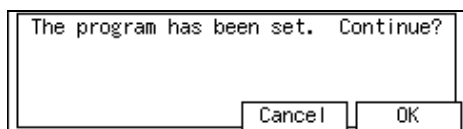

**Note**

- If the step right before pressing the [Start] key is also programmed, you can press the [Start] key to complete the operation without pressing [OK].

- 4 Press the [Start] key.

The machine starts scanning the document.

The message will be sent at the specified time.

## Deleting a Keystroke Program

**Note**

- If you delete a program, the registered program name is also deleted.

- 1 Press the [User Tools] key.

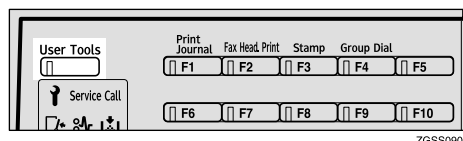

- 2 Enter the code for "Fax Features" with the number keys.

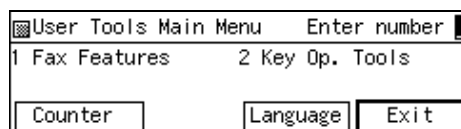

The "Fax Features" main menu appears.

- 3 Enter the code for "Program/Delete" with the number keys.

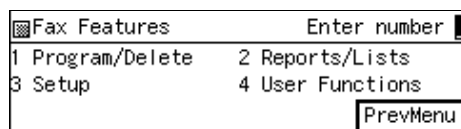

- 4 Enter the code for "Delete Program" with the number keys.

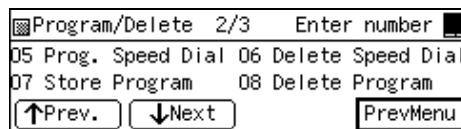

**Note**

- If "Delete Program" is not displayed, press [↑Prev.] or [↓Next] until it is.

**5** Press a Quick Dial key in which the program you wish to delete is stored.

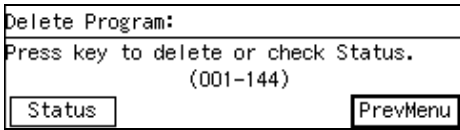

The contents of the program are shown on the display.

**Note**

- If you wish to delete a Keystroke Program stored in a Speed Dial, press **[Switch]**. Then press the **[Speed Dial]** key and enter the Speed Dial code.



6

Checking the Keystroke Programs Currently Programmed

- 1** Press **[Status]**
- 2** Press a Quick Dial key or enter a Speed Dial code.

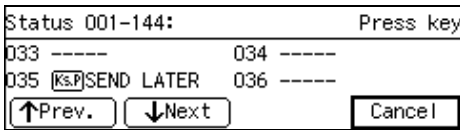

**Note**

- If you press **[Cancel]**, the program is not deleted and the display shown in step **5** appears again.

**6** Press **[Yes]**.

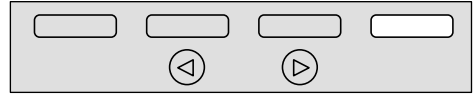
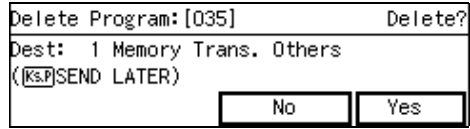

ZGSS220N

**7** Press **[Yes]**.

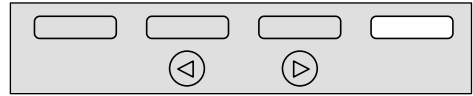
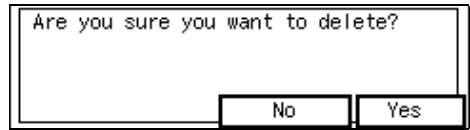

ZGSS220N

The program is deleted.

**Note**

- If you press **[No]**, the program is not deleted and the display shown in step **5** appears again.

**8** Press **[PrevMenu]** three times.

**9** Press **[Exit]** to return to the stand-by mode.

## Registering Auto Documents

If you find that you often have to send a particular page to people (for example, a map, a standard attachment, or a set of instructions), store that page in memory as an Auto Document. This saves re-scanning the document every time you wish to send it.

Use the following procedure to program a new Auto Document or overwrite an existing one.

### Important

- ❑ If the power switch is off more than 12 hours, all Auto Documents stored are deleted. In such a case, use the Power Failure Report to identify which messages have been lost.

## Programming and Changing an Auto Document

You can store the following items in an Auto Document:

- Document image
- Scan settings (Resolution, halftone, and Image Density)
- Document name (up to 20 characters)
- Label Insert Size

### Note

- ❑ Auto Documents can only be stored in Speed Dials when the optional Function Upgrade Unit is installed.
- ❑ You can only send one Auto Document per transmission.

- ❑ You can store up to 144 Auto Documents. (244 when the optional Function Upgrade Unit is installed, and the additional 100 out of 244 are stored in Speed Dial #000 to #099.)

### Reference

p.99 "Auto Document"

#### 1 Press the [User Tools] key.

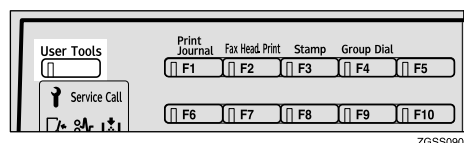

#### 2 Enter the code for "Fax Features" using the number keys.

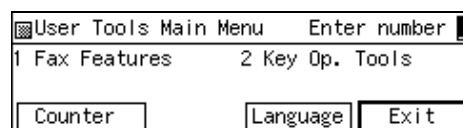

The "Fax Features" main menu appears.

#### 3 Enter the code for "Program/Delete" with the number keys.

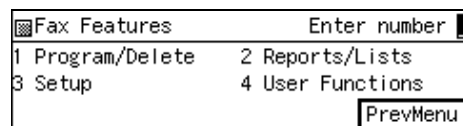

#### 4 Enter the code for "Prog. Auto Doc." with the number keys.

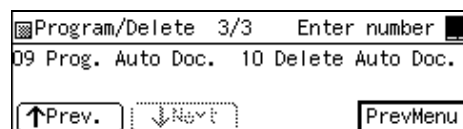

### Note

- ❑ If "Prog. Auto Doc." is not displayed, press [↑Prev.] or [↓Next] until it is.

**5** Press a Quick Dial key or a Speed Dial that the Auto Document you wish to store in.

To store an Auto Document in a Quick Dial key

**1** Press the Quick Dial key that you wish to store the Auto Document in.

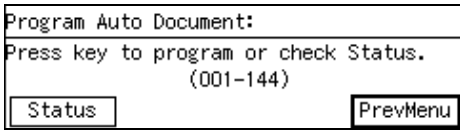

**Note**

- Press **[Status]** to check the documents currently stored.

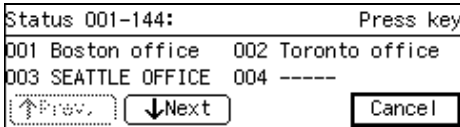

6

To store an Auto Document in a Speed Dial

**1** Press **[Switch]**.

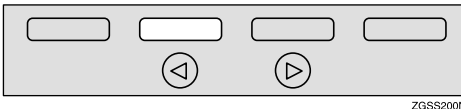
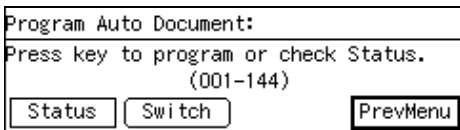

**2** Enter the code of the Speed Dial you wish to store the Auto Document in.

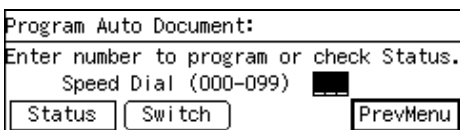

**Note**

- Press **[Status]** to check the documents currently stored.
- You can also select the Speed Dial to store the Auto Document from the status screen.



**6** What you do next depends on whether the Quick Dial key or Speed Dial has a destination already registered. Choose one of the following two procedures:

When the destination is not registered

**1** Press **[Name]**.

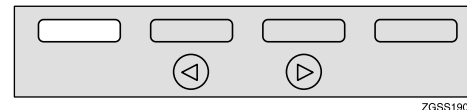
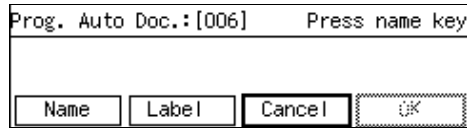

**Note**

- You can skip entering the name of the Auto Document, and proceed to step **4**.

**2** Enter the name.

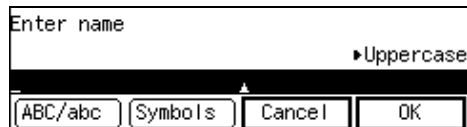

**Reference**

p.98 "Entering Characters", <Basic Features>

**3** Press **[OK]**.

**4** Press [Label].

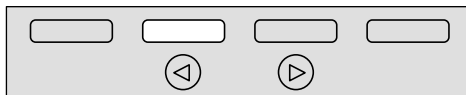
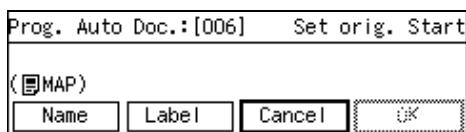

ZGSS200N

**5** Press **⏪** or **⏩** key to select "Large(1x2)" or "Normal".

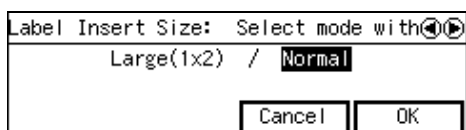

**6** Press [OK].

When the destination is registered

**1** Press [Label].

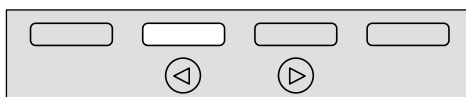
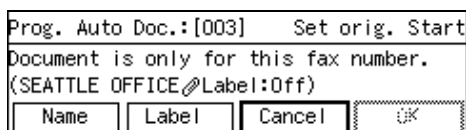

ZGSS200N

**2** Press **⏪** or **⏩** key to select "Large(1x2)" or "Normal".

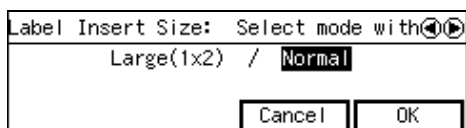

**3** Press [OK].

**7** Set the original.

**8** Press the [Start] key to scan in the original.

When scanning has finished, the Auto Document is stored.

**9** Press [PrevMenu] three times.

**10** Press [Exit] to return to standby mode.

## Deleting an Auto Document

**Note**

- You cannot delete an Auto Document waiting to be transmitted. Delete it after the transmission, or delete the Auto Document after deleting the file waiting to be transmitted.

**1** Press the [User Tools] key.

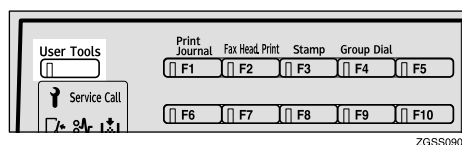

ZGSS090N

**2** Enter the code for "Fax Features" using the number keys.

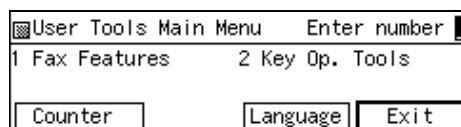

The "Fax Features" main menu appears.

**3** Enter the code for "Program/Delete" with the number keys.

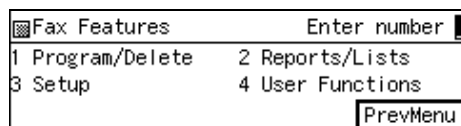

**4** Enter the code for "Delete Auto Doc." with the number keys.

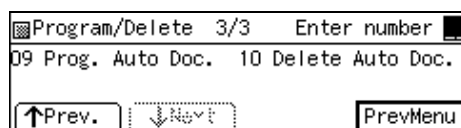

**Note**

- If "Delete Auto Doc." is not displayed, press [↑Prev.] or [↓Next] until it is.

**5** Press a Quick Dial key in which the Auto Document you wish to delete is stored.

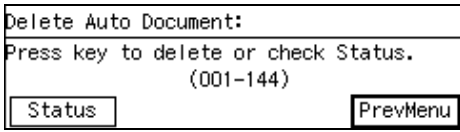

The stored document is shown on the display.

**Note**

- ❑ If you wish to delete an Auto Document stored in a Speed Dial, press **[Switch]**. Then press the **[Speed Dial]** key and enter the Speed Dial code.

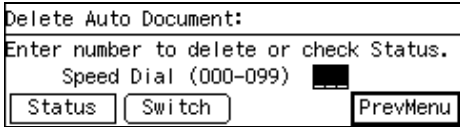

Checking On Stored Auto Documents

- 1** Press **[Status]**.
- 2** Scroll through the list with **[↑Prev.]** or **[↓Next]**.

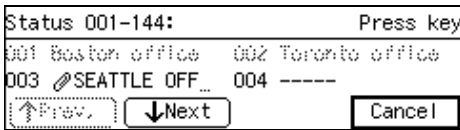

**Note**

- ❑ If you press **[Cancel]**, the display in step **5** appears.

**6** Press **[Yes]**.

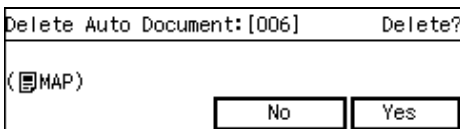

ZGSS220N

**Note**

- ❑ If you select the Quick Dial key or Speed Dial in which a fax number is stored, the following display appears. Even if you press **[Yes]**, only the attached Auto Document will be deleted but not the fax number.

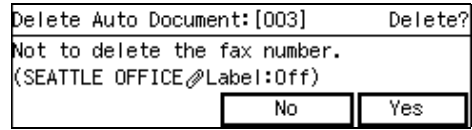

**7** Press **[Yes]** to delete the Auto Document.

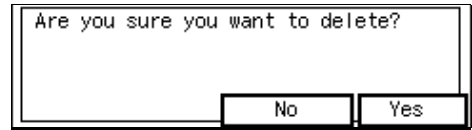

ZGSS220N

**Note**

- ❑ If you press **[No]**, the Auto Document is not deleted and the display shown in step **5** reappears.

**8** Press **[PrevMenu]** three times.

**9** Press **[Exit]** to return to the standby mode.



# Reports/Lists

This function allows you to print the following reports and lists manually. Select a report or list as needed.

- Journal  
See p.50 "Printing the Journal".
- Quick Dial list/Quick Key Label  
See p.73 "Quick Dial Key Label (Dial Label)", <Basic Features>.
- Group Dial List  
See p.87 "Groups", <Basic Features>.
- Speed Dial List  
See p.76 "Speed Dial", <Basic Features>.
- Keystroke Program List  
See p.139 "Storing and Changing Keystroke Programs".
- Auto Document  
See p.145 "Registering Auto Documents".

## Note

- ❑ If the optional Paper Supply Unit is installed, you can set reports and lists to be printed from a specific paper tray with User Parameters. However, once this setting is made, any fax messages received cannot be printed from that paper tray. See p.178 "User Parameters" (switch 19 bits 2,1,0).

## 1 Press the [User Tools] key.

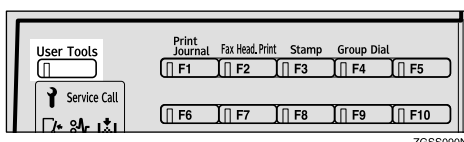

## 2 Enter the number of the "Fax Features" using the number keys.

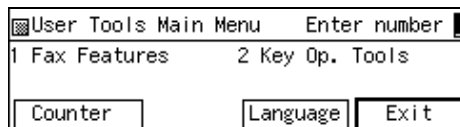

The "Fax Features" main menu appears.

## 3 Enter the code for "Reports/Lists" with the number keys.

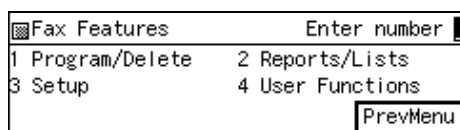

## 4 Enter the code of the report or list you wish to print.

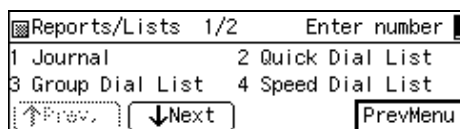

## Note

- ❑ If you cannot see the item you need, press [↑Prev.] or [↓Next].
- ❑ If you incorrectly enter the code, press [Cancel] and enter the correct number.
- ❑ After selecting "Journal", choose "All", "File No.", "User Code" or "Date".
- ❑ After selecting "Quick Dial List" choose "Quick Dial List" or "Dial Label".
- ❑ After selecting "Speed Dial List" choose "Speed Dial Order" or "Alphabetic Order".

**5** Press the **[Start]** key.

When printing is completed, the display shown in step **4** appears again.

 **Note**

- If you press the **[Stop]** key before printing starts, the printing stops and the display shown in step **4** appears again.

**6** Press **[PrevMenu]** twice.

**7** Press **[Exit]** to return to the stand-by mode.

# Setup

## Adjusting the Display Contrast

Follow these steps to adjust the contrast of the control panel display. Eight levels of contrast are available.

- 1 Press the **[User Tools]** key.

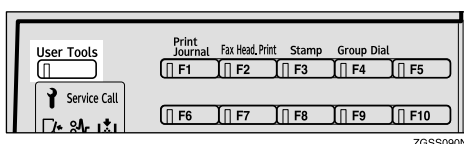

- 2 Enter the code for "Fax Features" with the number keys.

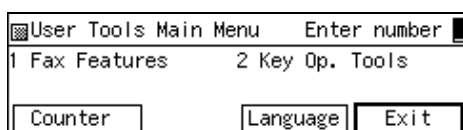

- 3 Enter the code for "Setup" with the number keys.

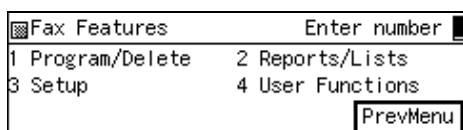

- 4 Enter the code for "Display Contrast" with the number keys.

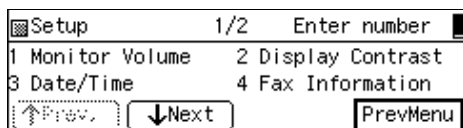

- 5 Press **[Left]** or **[Right]** key to adjust the contrast.

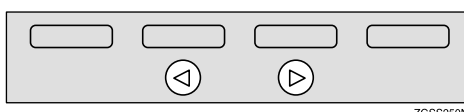

- 6 Press **[OK]**.

### Note

- If you press **[Cancel]**, the display in step 4 reappears.

- 7 Press **[PrevMenu]** twice.

- 8 Press **[Exit]** to return to standby mode.

## Date/Time

Use this function to set your machine's internal clock to the current time and date. This time is shown on the display, printed on pages and used for various features, such as Send Later.

If the current date and time are wrong, use this procedure to correct them.

### Note

- The machine automatically sets the internal clock one hour ahead when daylight saving time begins, and one hour back when it ends.

- 1 Press the **[User Tools]** key.

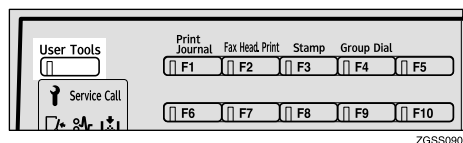

- 2 Enter the code for "Fax Features" with the number keys.

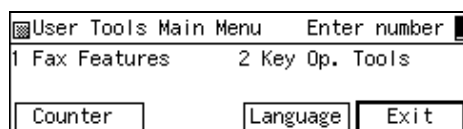

The "Fax Features" main menu appears.

- 3 Enter the code for "Setup" with the number keys.

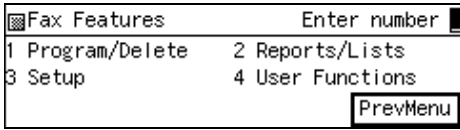

- 4 Enter the code for "Date/Time" using the number keys.

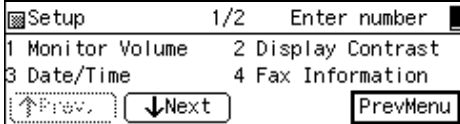

- 5 Select the month you wish to change using the [↑Month] and [↓Month] and enter the correct date or time using [◀] or [▶] key and the number keys.

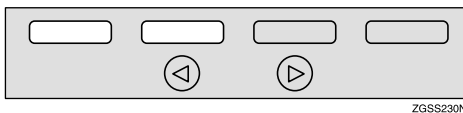
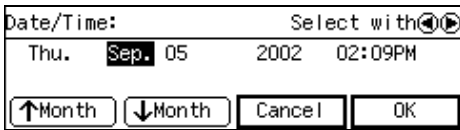

**Note**

- Enter the time in 12-hour format. Press [AM/PM] to select AM or PM.
- When you enter a date, the day is set automatically.
- Your machine accepts the date in 12 hours format.

- 6 Press [OK].
- 7 Press [PrevMenu] twice.
- 8 Press the [Exit] to return to standby display.

## Fax Reset Timer

This machine automatically returns to standby display if you do not use the machine for a certain period of time. You can select this period.

You can select 30 seconds, one minute, three minutes, or five minutes for the period.

- 1 Press the [User Tools] key.

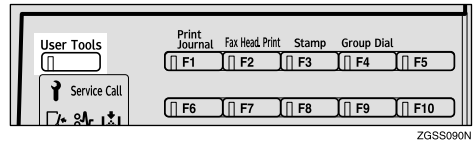

- 2 Enter the code for "Fax Features" with the number keys.

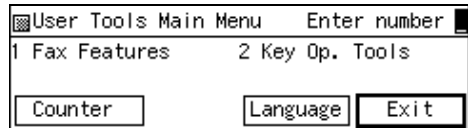

The "Fax Features" main menu appears.

- 3 Enter the code for "Setup" with the number keys.

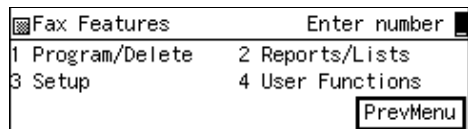

- 4 Enter the code for "Fax Reset Timer" with the number keys.

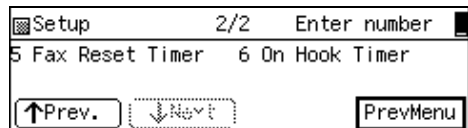

**Note**

- If "Fax Reset Timer" is not displayed, press [↑Prev.] or [↓Next] until it is.

- 5** Press **⏪** or **⏩** key to select a period of time.

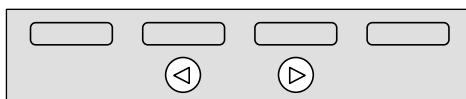
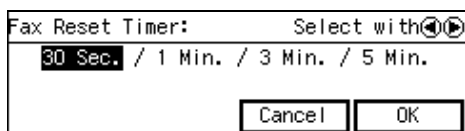

ZGSS250N

- 6** Press **[OK]**.

**Note**

- If you press **[Cancel]**, the display in step **4** reappears.

- 7** Press **[PrevMenu]** twice.

- 8** Press **[Exit]** to return to standby mode.

## On Hook Timer

This machine automatically cancels the On Hook Dial mode if you do not dial a number from the number keys for a certain period of time after pressing the **[On Hook Dial]** key. You can select this period.

You can select one minute, three minutes, five minutes or ten minutes for the period.

- 1** Press the **[User Tools]** key.

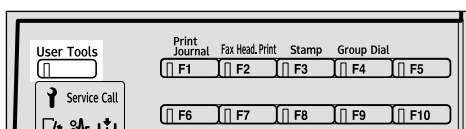

ZGSS090N

- 2** Enter the code for "Fax Features" with the number keys.

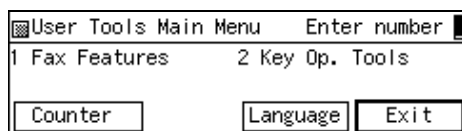

The "Fax Features" main menu appears.

- 3** Enter the code for "Setup" with the number keys.

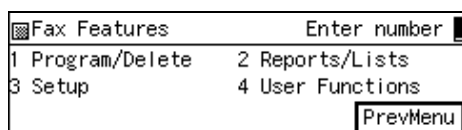

- 4** Enter the code for "On Hook Timer" with the number keys.

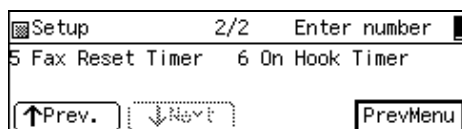

**Note**

- If "On Hook Timer" is not displayed, press **[↑Prev.]** or **[↓Next]** until it is.

- 5** Press **⏪** or **⏩** key to select a period of time.

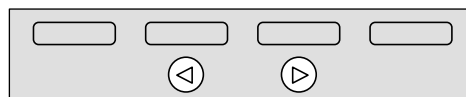
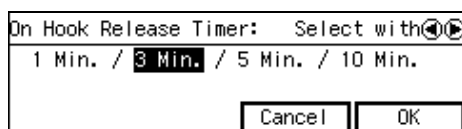

ZGSS250N

- 6** Press **[OK]**.

**Note**

- If you press **[Cancel]**, the display in step **4** reappears.

- 7** Press **[PrevMenu]** twice.

- 8** Press **[Exit]** to return to the standby mode.

## User Function Keys

You can program each of the User Function keys (**[F1]** to **[F10]**) with a function that you use frequently. When you wish to use that function, instead of having to search through several menus to find it, just press the appropriate User Function key. This procedure can be used to edit, delete or change the contents of the User Function keys.

### Functions You Can Assign to User Function Keys

The following table lists the functions you can store in the User Function keys (**[F1]** to **[F10]**).

Function Name	Description	Indicator	Reference
Groups	Allows you to specify the destination using a Group code.	—	p.50 "Using Groups", <Basic Features>
Economy Transmission	Allows you to specify Economy Transmission.	✓	p.175 "Economy Transmission"
Fax Header Print	Allows you to make On/Off setting for Fax Header Print.	✓	p.32 "Fax Header Print"
Tone	Allows you to enter Tone/UUI.	—	p.47 "Tone", <Basic Features>
Batch Transmission	Allows you to make On/Off setting for Batch Transmission.	✓	p.105 "Batch Transmission"
Stamp	Allows you to make On/Off setting for Stamp.	✓	p.93 "Stamp"
Duplex Original	Allows you to scan a duplex original for transmission.	✓	p.94 "Duplex Original Settings"
Forwarding	Allows you to make On/Off setting for Forwarding.	✓	p.223 "Forwarding"
Sub-address *1	Allows you to enter a Sub-address.	—	p.82 "Sub-address"
Dial Option	Allows you to send or receive fax messages with an ID (SUB/SEP/SID/PWD).	✓	p.78 "SUB/SID (SUB Code Transmission)", p.80 "SEP/PWD (SEP Code Polling Transmission)"
Line Selection *1	Allows you to select the telephone line for transmission.	✓	p.89 "Selecting the Line"
Journal	Allows you to print the Journal.	—	p.50 "Printing the Journal"

Function Name	Description	Indicator	Reference
Internet Fax * <sup>1</sup>	Allows you to enter texts such as an e-mail address.	—	Chapter 2, "Transmission," Chapter 3, "Transmission" and Chapter 5, "Using the Scanner Functions" in the NIC FAX Unit manual
Automatic E-mail Reception * <sup>1</sup>	Allows you to make On/Off setting for Automatic E-mail Reception.	✓	Chapter 2, "Automatic E-mail Reception" in the NIC FAX Unit manual
E-mail Reception * <sup>1</sup>	Allows you to receive e-mail manually.	—	Chapter 2, "Manual E-mail Reception" in the NIC FAX Unit manual
Scanner * <sup>1</sup>	Allows you to enter destinations for Internet Fax transmissions using the Scanner function.	✓	Chapter 5, "Using the Scanner Functions" in the NIC FAX Unit manual
Communication Result Report	Allows you to select whether to print the Communication Result Report (Memory Transmission) or Immediate Transmission Result Report (Immediate Transmission).	✓	p.103 "Checking the Transmission Result"
Reception Mode Selection	Allows you to select the Reception Mode.	—	p.53 "Selecting the Reception Mode", <Basic Features>
Batch Original Documents Transmission	Allows you to send a fax message by using the Batch Original Documents Transmission function.	✓	p.96 "Batch Original Documents Transmission"

\*<sup>1</sup> Option(s) required

- "✓" mark in the "Indicator" column indicates that the indicator on the User Function key is lit when the function is selected.
- The following functions are pre-assigned to User Function keys:
  - [F1]**: Journal
  - [F2]**: Fax Header Print
  - [F3]**: Stamp
  - [F4]**: Groups
- The following functions are also pre-assigned to User Function keys if your machine is Type2:
  - [F5]**: Internet Fax
  - [F10]**: Scanner

#### Note

- You can check the functions assigned to the User Function keys on the "Quick Dial Key Label (Dial Label)." See p.73 "Quick Dial Key Label (Dial Label)", <Basic Features>.

## Registering/Editing the Contents of a User Function Key

There are two types of programming methods.

- Programming the contents of a User Function key by specifying a function code with the number keys
- Programming a User Function key on the job

**Note**

- ❑ The function that is already assigned to a User Function key cannot be assigned to another User Function key.

6

### Programming by Specifying a Function Code with the Number Keys

**1** Press the [User Tools] key.

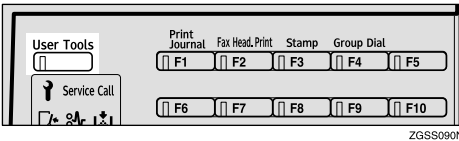

**2** Enter the number of the "Fax Features".

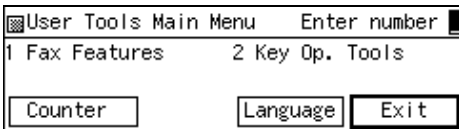

The "Fax Features" main menu appears.

**3** Enter the code for "User Functions" using the number keys.

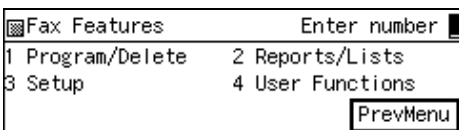

**4** Press the User Function key ([F1] to [F10]) you wish to use.

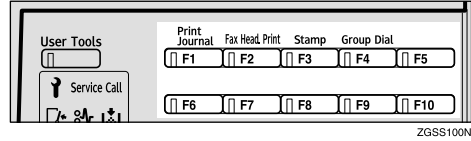
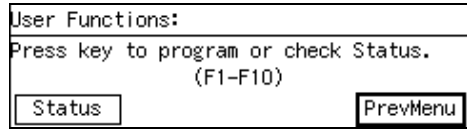

**Note**

- ❑ If you make a mistake, press [Cancel], and then press the correct key.

### Checking the Contents of User Function Keys Currently Programmed

**1** Press [Status].

**2** Press the User Function key ([F1] to [F10]) you wish to register or edit.

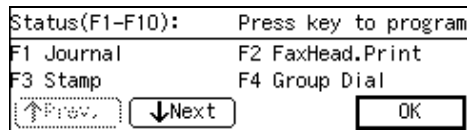

**Note**

- ❑ You can also select the User Function key to store the program in from the status screen.
- ❑ If you press [OK], the display in step 4 appears.

**5** Enter the code you wish to register into the User Function key using the number keys.

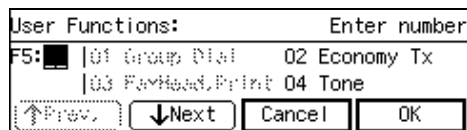



**Note**

- ❑ To see a function number not displayed on the display, press [↑Prev.] or [↓Next].
- ❑ If another function is already registered, press the **[Clear]** key or the **[Stop]** key to delete it.

**6 Press [OK].****Note**

- ❑ If you press **[Cancel]**, the function is not stored and the display shown in step **4** appears again.
- ❑ If you press another User Function key here, you can register or edit another function by following the procedure described above.

**7 Press [PrevMenu] twice.****8 Press [Exit] to return to the standby mode.**

## Programming a User Function Key on the Job

When carrying out an operation from the control panel, you can store the various operations that you have performed so far in a User Function key. Once stored, just press that User Function key when the standby display is shown to carry out those operations.

**Note**

- ❑ You cannot store the following operations in User Function keys:
  - User Function settings
  - Quick Dial, Speed Dial, Group Number, File No, Confidential ID, Memory Lock ID, or Operations carried out after specifying a User Code (SUB code).

The following example procedure describes how to store the time setting for Send Later in User Function key **[F5]**.

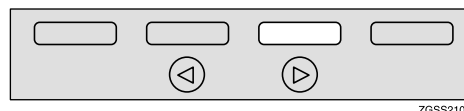
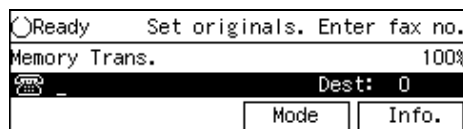
**1 Press [Mode].**

ZGSS210N

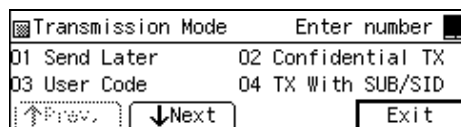
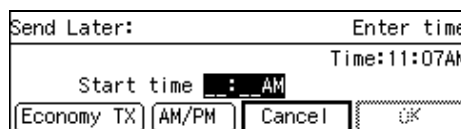
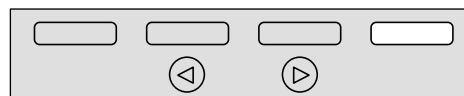
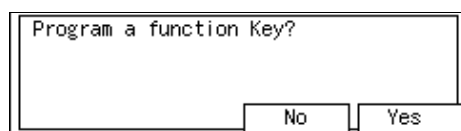
**2 Enter the code for "Send Later" with the number keys.****3 Press [F5].****4 Press [Yes].**

ZGSS220N

**[F5]** is registered and the display showing the operation in progress reappears.

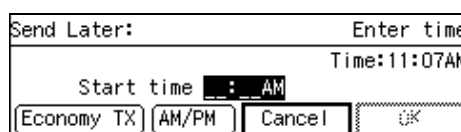

**Note**

- The operation you have stored is shown as "Custom Functions" on the display.

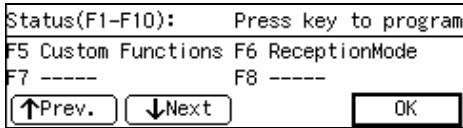

## Using a User Function Key

- Press the User Function key (F1 to F10) in which the function you wish to use is stored.

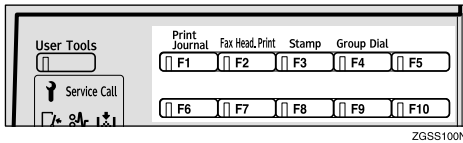

The stored function's display is shown.

❖ **Example: "Journal Print"**

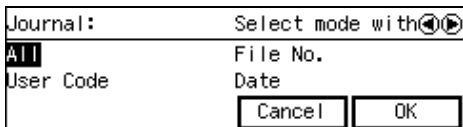

## Deleting Functions Stored in User Function Keys

- Press the [User Tools] key.

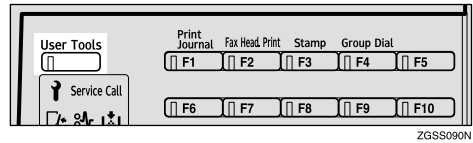

- Enter the code for "Fax Features" with the number keys.

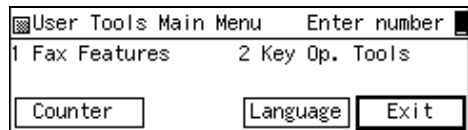

- Enter the code for "User Functions" with the number keys.

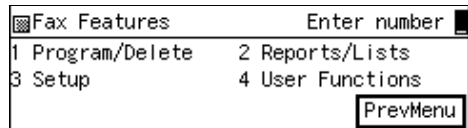

- Press the User Function key (F1 to F10) that you wish to clear.

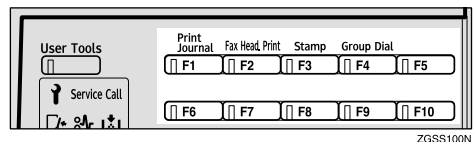
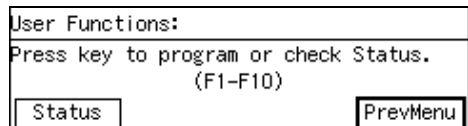

**Note**

- If you make a mistake, press [Cancel] and try again.

### Checking the currently stored function

- Press [Status].

**2** Press the User Function key you wish to clear.

Status(F1-F10):	Press key to program
F1 Journal	F2 FaxHead.Print
F3 Stamp	F4 Group Dial
↑Prev.	↓Next
	OK

 **Note**

- You can also select the User Function key to clear from the status screen.
- If you press **[OK]**, the function is not deleted and the display in step **4** reappears.

**5** Press the **[Stop]** key to clear the User Function.

User Functions:	Enter number
F5:14	13 Batch Orig. 14 Custom
↑Prev.	↓Next
	Cancel
	OK

**6** Press **[OK]**.

 **Note**

- If you press **[Cancel]**, the function is not deleted and the display in step **4** reappears.
- To clear other User Function keys, press the User Function key (**[F1]** to **[F10]**) and proceed as before.

**7** Press **[PrevMenu]** twice.

**8** Press **[Exit]** to return to the stand-by mode.

# Fax On Demand

*This feature requires the optional Fax On Demand unit.*

Fax On Demand lets you store documents in memory with a number attached (the box number). When another party wishes to receive the message, they make a transmission request to your machine specifying the box number containing the document they wish to receive.

 **Preparation**

You can turn this function on or off. See p.197 "Fax On Demand Reception".

 **Note**

- You can also choose whether the requesting party has to specify a password with User Parameters. The password is the Remote ID. See p.178 "User Parameters" and p.199 "Registering ID Codes".

## Registering/Editing Fax On Demand Documents

This procedure describes how to store a document using Fax On Demand and assign it a name.

 **Note**

- After you have registered or edited a document, we recommend that you print the Fax On Demand List to verify the stored contents. See p.165 "Printing the Fax On Demand List".
- You can register up to 99 documents with this feature.
- For how to edit a box name, see step 7.
- If you wish to edit a document, delete it, then register it again. See p.162 "Deleting Fax On Demand Documents".

**1** Press the **[User Tools]** key.

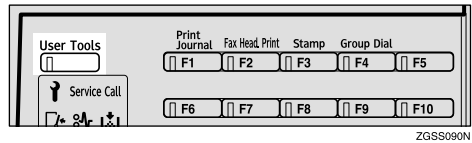

**2** Enter the code for "Fax Features" with the number keys.

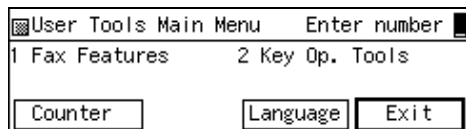

- 3** Enter the code for "Fax On Demand" with the number keys.

Fax Features 2/2 Enter number

5 Fax On Demand

↑Prev. ↓Next PrevMenu

- 4** Enter the code for "Program FOD" with the number keys.

Fax On Demand 1/2 Enter number

1 Program FOD 2 Delete FOD

3 Print File 4 Print List

↑Prev. ↓Next PrevMenu

**Note**

- If "Program FOD" is not displayed, press [↑Prev.] or [↓Next] until it is.

- 5** Enter the box number to store the document in.

Program FOD:

Press number to program or check Status.

Box(01-99)

Status PrevMenu

To Check Currently Registered Documents

- 1** Press [Status].
- 2** Enter the box number to store the document in.

Status 01-99: Enter number

01 ---- 02 ----

03 ---- 04 ----

↑Prev. ↓Next Cancel

**Note**

- You can also specify the box number to program from the status screen.
- If a free box number is not displayed, press [↑Prev.] or [↓Next] until one is.
- If you press [Cancel], the display in step **5** reappears.

- 6** Press [Name].

Program FOD: Enter name

Box 01:

Name Cancel OK

← →

ZGSS190N

- 7** Enter a name for this box, then press [OK].

Enter name

►Uppercase

ABC/abc Symbols Cancel OK

← →

ZGSS220N

**Note**

- If this name is already registered, it is displayed. To change the name, press the [Clear] key or the [Stop] key and enter it again.

**Reference**

p.98 "Entering Characters",  
<Basic Features>

- 8** Set the original.

Program FOD: Set orig., press Start

Box 01:SHOPPING INFORMATION

Name Cancel OK

- 9** Press the [Start] key to scan in your original.

When scanning has finished, the document is stored.

- 10** Press [PrevMenu] three times.

- 11** Press [Exit] to return to the stand-by mode.

## Deleting Fax On Demand Documents

Follow these steps to delete a document stored using Fax On Demand.

**1** Press the **[User Tools]** key.

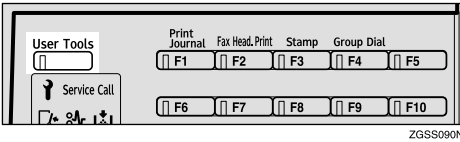

**2** Enter the code for "Fax Features" with the number keys.

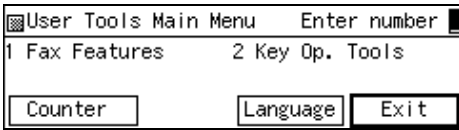

**3** Enter the code for "Fax On Demand" with the number keys.

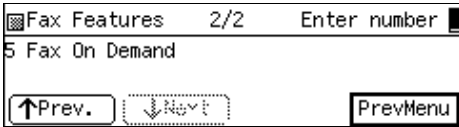

**Note**

- If "Fax On Demand" is not displayed, press **[↑Prev.]** or **[↓Next]** until it is.

**4** Enter the code for "Delete FOD" with the number keys.

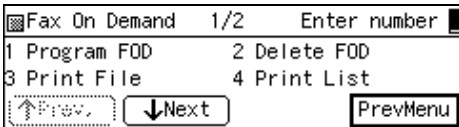

**5** Enter the number of the box you wish to delete.

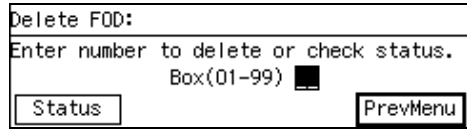

To check currently registered documents

**1** Press **[Status]**.

**2** Enter the number of the box to delete.

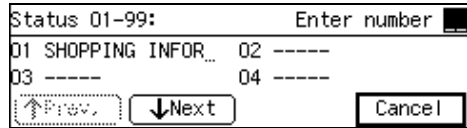

**Note**

- You can also specify the box number to delete from the status screen.
- If a free box number is not displayed, press **[↑Prev.]** or **[↓Next]** until one is.
- If you press **[Cancel]**, the display in step **5** reappears.

If the Box you specified is empty

**1** The display below appears, followed by the display shown in step **5**. Enter the box number again.

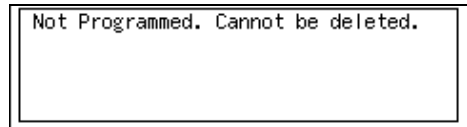

## 6 Choose one of the following procedures.

### Deleting just the document

#### 1 Press [Document].

Delete FOD:
Box 01:SHOPPING INFORMATION
Cancel   Document   Label   Both

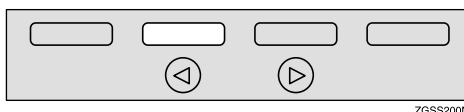

#### 2 Press [Yes].

Delete document?
No   Yes

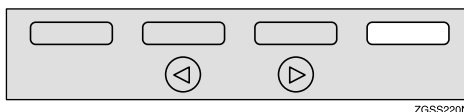

#### Note

- If you press [No], the display in step 5 reappears.

### Deleting just the label

#### 1 Press [Label].

Delete FOD:
Box 01:SHOPPING INFORMATION
Cancel   Document   Label   Both

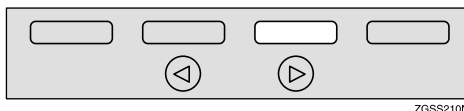

#### 2 Press [Yes].

Delete the name of FOD Box?
No   Yes

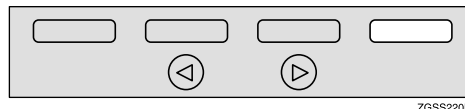

#### Note

- If you press [No], the display in step 5 reappears.

### Deleting both document and label

#### 1 Press [Both].

Delete FOD:
Box 01:SHOPPING INFORMATION
Cancel   Document   Label   Both

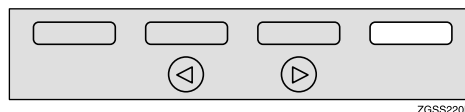

#### 2 Press [Yes].

Delete Document and name of FOD Box?
No   Yes

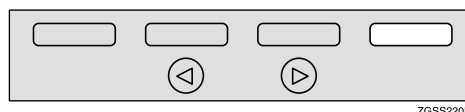

#### Note

- If you press [No], the display in step 5 reappears.

#### 7 Press [PrevMenu] three times.

#### 8 Press [Exit] to return to the stand-by mode.

## Printing Fax On Demand Documents

Follow these steps to print out a document stored using Fax On Demand.

**1** Press the **[User Tools]** key.

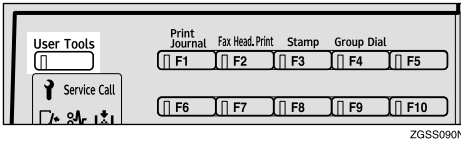

**2** Enter the code for "Fax Features" with the number keys.

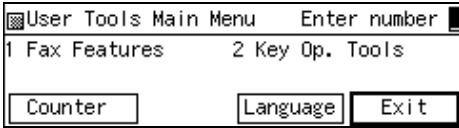

**3** Enter the code for "Fax On Demand" with the number keys.

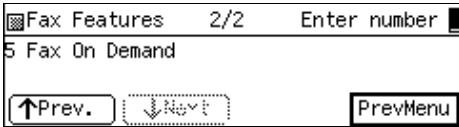

**Note**

If "Fax On Demand" is not displayed, press **[↑Prev.]** or **[↓Next]** until it is.

**4** Enter the code for "Print File" with the number keys.

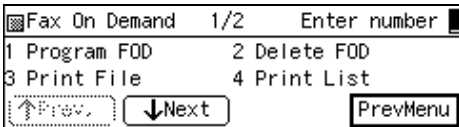

**5** Enter the number of the box you wish to print.

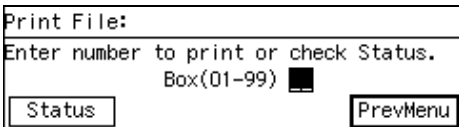

## To Check Currently Registered Documents

- 1** Press **[Status]**.
- 2** Enter the number of the box to delete.

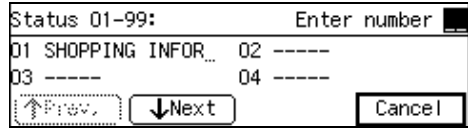

**Note**

- You can also specify the box number to print from the status screen.
- If a free box number is not displayed, press **[↑Prev.]** or **[↓Next]** until one is.
- If you press **[Cancel]**, the display in step **5** reappears.

## If the Box you specified is empty

**1** The display below appears, followed by the display shown in step **5**. Enter the box number again.

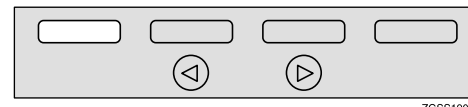
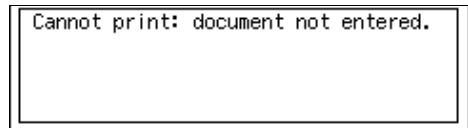

**6** Press the **[Start]** key.

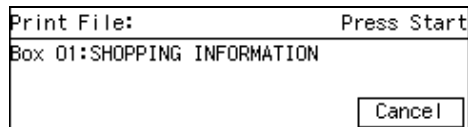

**Note**

If you press **[Cancel]**, the display in step **5** reappears.



- 7** Press [PrevMenu] twice.
- 8** Press [Exit] to return to the stand-by mode.

## Printing the Fax On Demand List

- 1** Press the [User Tools] key.

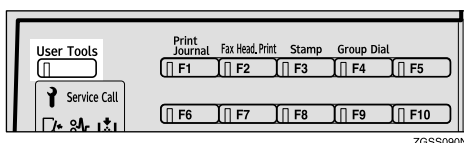

- 2** Enter the code for "Fax Features" with the number keys.

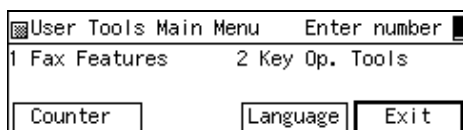

- 3** Enter the code for "Fax On Demand" with the number keys.

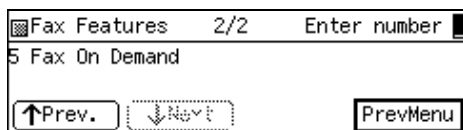

### Note

- If "Fax On Demand" is not displayed, press [↑Prev.] or [↓Next] until it is.

- 4** Enter the code for "Print List" with the number keys.

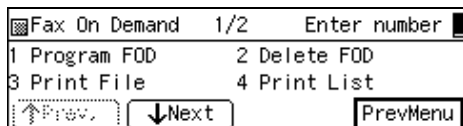

- 5** Press the [Start] key.

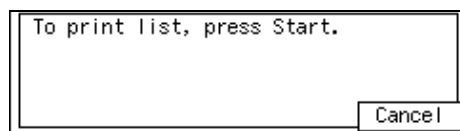

### Note

- If you press [Cancel], the display in step 4 reappears.

- 6** Press [PrevMenu] twice.

- 7** Press [Exit] to return to the stand-by mode.

## Printing the Fax On Demand Access Report

Print this report to find out how many pages have been sent successfully/unsuccessfully with the Fax On Demand feature.

- 1** Press the [User Tools] key.

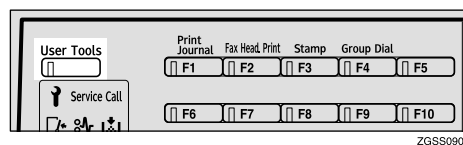

- 2** Enter the code for "Fax Features" with the number keys.

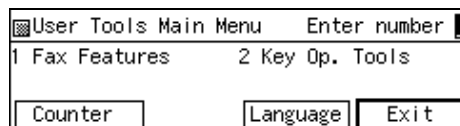

**3** Enter the code for "Fax On Demand" with the number keys.

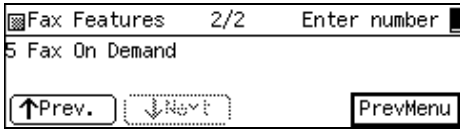

**Note**

- If "Fax On Demand" is not displayed, press [**Prev.**] or [**Next**] until it is.

**4** Enter the code for "Access Report" with the number keys.

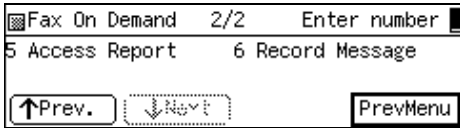

**Note**

- If "Access Report" is not displayed, press [**Prev.**] or [**Next**] until it is.

**5** Press the [**Start**] key.

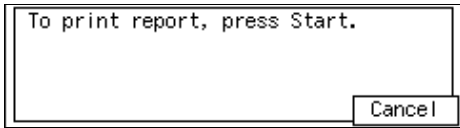

**Note**

- If you press [**Cancel**], the display in step **4** reappears.

**6** Press [**PrevMenu**] twice.

**7** Press [**Exit**] to return to the stand-by mode.

## Fax On Demand Recorded Messages

When a caller requests a Fax On Demand document, the machine plays back appropriate guidance messages. This section describes how to record these messages.

**Note**

- You can record the following seven messages, each of which can be up to 30 seconds long:

Message Number	Message Type	Example
1	Greeting message	"This is the XYZ fax information service."
2	Password input guidance	"Please enter the password followed by a # (pound sign) character."
3	Box number input guidance 1	"Press # twice to get box one, or enter the box number you need followed by a # character."
4	Box number input guidance 2	"If you require another box, enter the number followed by a # character. To finish press # twice."
5	Transmission guidance	"Please press the Start key to begin transmission."
6	Re-enter guidance	"Please enter again."
7	Redial guidance	"Please dial again."

- ❑ By tailoring message 3, you can direct callers to just download the document stored in box 1, or have them choose any of up to five boxes.
- ❑ You can also choose whether a password is required with User Parameters. When turned off, message 2 is skipped.

## Recording the Fax On Demand Recorded Messages

### Preparation

Before you begin, plug the microphone into the socket provided on the right side of the machine.

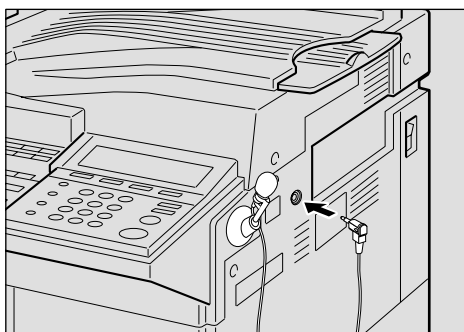

ZGFP250N

- 1** Press the **[User Tools]** key.

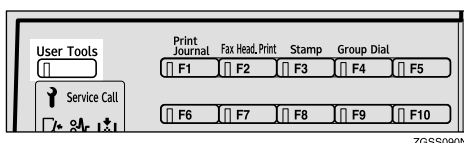

ZGSS090N

- 2** Enter the code for "Fax Features" with the number keys.

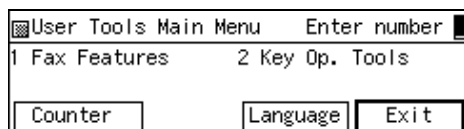

- 3** Enter the code for "Fax On Demand" with the number keys.

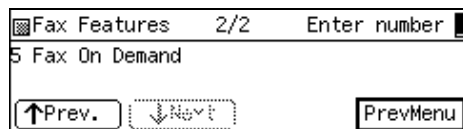

#### Note

- ❑ If "Fax On Demand" is not displayed, press **[↑Prev.]** or **[↓Next]** until it is.

- 4** Enter the code for "Record Message" with the number keys.

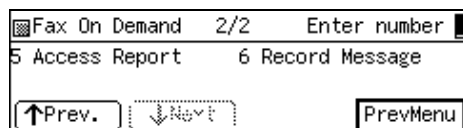

#### Note

- ❑ If "Record Message" is not displayed, press **[↑Prev.]** or **[↓Next]** until it is.

- 5** Enter the code for "Record Guidance" with the number keys.

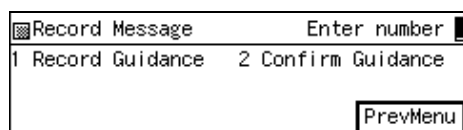

- 6** Enter the number of the message you wish to record with the number keys.

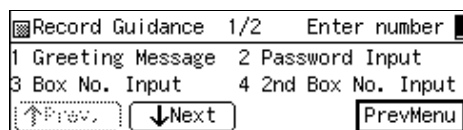

#### Note

- ❑ If the item you require is not displayed, press **[↑Prev.]** or **[↓Next]** until it is.

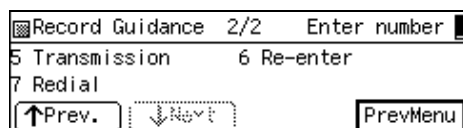

**7** Press **[Start]** then speak the message into the microphone.

As you speak, the remaining time available is shown on the display.

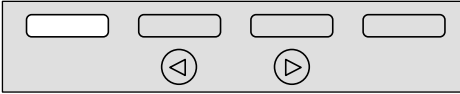
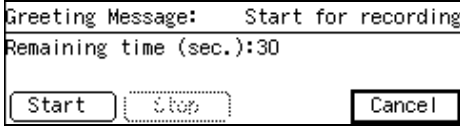

ZGSS190N

**Note**

- Each of the messages can be up to 30 seconds long.
- If there is still time left when you have finished your message, press **[Stop]**.

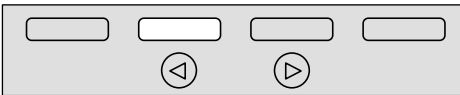
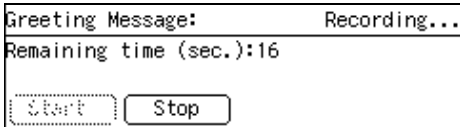

ZGSS200N

**8** Press **[OK]**.

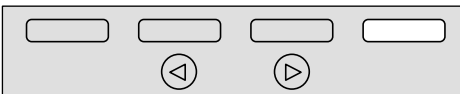
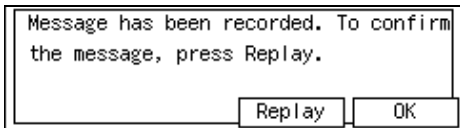

ZGSS220N

**Note**

- Press **[Replay]** to listen to the message you have just recorded.

**9** Press **[PrevMenu]** four times.

**10** Press **[Exit]** to return to the stand-by mode.

**Checking the Fax On Demand Recorded Messages**

**1** Press the **[User Tools]** key.

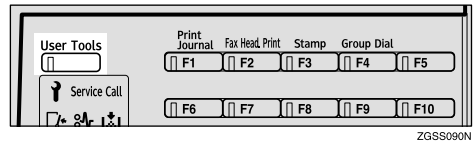

ZGSS090N

**2** Enter the code for "Fax Features" with the number keys.

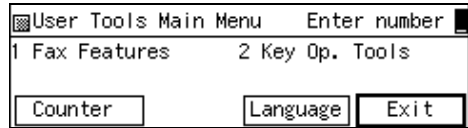

**3** Enter the code for "Fax On Demand" with the number keys.

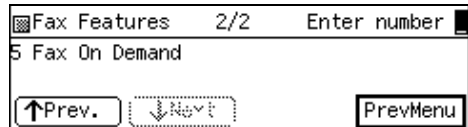

**Note**

- If "Fax On Demand" is not displayed, press **[↑Prev.]** or **[↓Next]** until it is.

**4** Enter the code for "Record Message" with the number keys.

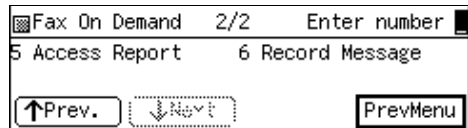

**Note**

- If "Record Message" is not displayed, press **[↑Prev.]** or **[↓Next]** until it is.

- 5** Enter the code for "Confirm Guidance" with the number keys.

Record Message		Enter number
1 Record Guidance	2 Confirm Guidance	
		PrevMenu

- 6** Enter the number of the message you wish to confirm with the number keys.

Confirm Guidance 1/2		Enter number
1 Greeting Message	2 Password Input	
3 Box No. Input	4 2nd Box No. Input	
↑Prev.	↓Next	PrevMenu

**Note**

- If the item you require is not displayed, press [↑Prev.] or [↓Next] until it is.

Confirm Guidance 2/2		Enter number
5 Transmission	6 Re-enter	
7 Redial		
↑Prev.	↓Next	PrevMenu

- 7** Listen to the message.

Replaying...
Cancel

**Note**

- To stop the message being played, press [Cancel].

- 8** Press [PrevMenu] four times.

- 9** Press [Exit] to return to the standby mode.

## How Callers Use Fax On Demand

**Note**

- Callers must wait until messages have completely finished playing before pressing a key.
- If the password option is turned on with User Parameters, you need to inform the calling party of the password beforehand.
- The Remote ID is used as the password.
- Callers can request the contents of up to 5 boxes in one call.
- Message 6 (please enter again) is played when:
  - The box number has not been entered correctly.
  - No key press was detected within 5 seconds after prompting for the box number (message 3).
  - The password has not been entered within 5 seconds.
- Message 7 (please call again) is played when:
  - The wrong password has been entered 3 times in a row.
  - An empty box has been selected 3 times in a row.
  - Message 3 has been played three times because no key press was detected.
  - Message 6 has been played twice because no key press was detected within 5 seconds.

---

### When the Password Is Turned On

---

- 1** Dial using On Hook Dial, or lift the handset and dial.

You will hear message 1, then 2.

- 2** Enter the password with the number keys, then press the **【#】** key.

You will hear message 3.

Now do one of the following:

---

#### To choose one or more boxes

---

- 1** Enter the box number with the number keys, then press the **【#】** key.

You will hear message 4.

#### Note

- To download another box, enter the box number, and then press the **【#】** key.

- 2** Press the **【#】** key twice.

You will hear message 5.

---

#### To choose box 1 only

---

- 1** Press the **【#】** key twice.

You will hear message 5.

- 3** Press the **【Start】** key to begin receiving.

---

### When the Password Is Turned Off

---

- 1** Dial using On Hook Dial, or lift the handset, and then dial.

You will hear message 1.

Now do one of the following:

---

#### To choose one or more boxes

---

- 1** Enter the box number with the number keys, and then press the **【#】** key.

You will hear message 4.

#### Note

- To download another box, enter another box number, and then press the **【#】** key.

- 2** Press the **【#】** key twice.

You will hear message 5.

---

#### To choose box 1 only

---

- 1** Press the **【#】** key twice.

You will hear message 5.

- 2** Press the **【Start】** key to begin receiving.

# 7. Key Operator Settings

## Accessing the Key Operator Tools

This section describes settings of functions that are mainly managed by key operators, such as various types of ID codes, type of telephone line the machine is connected to, User Parameters, or destinations for transmissions.

The functions that are available for setting are listed below. Please see the referenced page for more information.

Necessary Options:

\*1 Extra G3 Interface Unit

\*2 ISDN Unit

\*3 Fax On Demand Unit

\*4 NIC FAX Unit (Option for Type1)

\*5 Paper Tray Unit, or Optional Bypass Tray Unit

\*6 Function Upgrade Unit

\*7 40MB Memory Card

Function Name		Description	Reference
System Settings	Economy Transmission	Allows you to take advantage of off-peak line rates. Register the off-peak hours.	p.175 "Economy Transmission"
	Night Timer	Allows you to register the time for turning on/off the heater of the fusing unit. You can cut costs by turning the power off when nobody uses the machine, such as at night or holidays.	p.176 "Night Timer"
	User Parameters	Allow you to customize various settings to match your needs.	p.178 "User Parameters"
	User Parameter List	Allows you to print and check the details of the User Parameter settings.	p.189 "Printing the User Parameter List"
	G3 Analog Line	<ul style="list-style-type: none"><li>G3-1 Analog Line Allows you to register Own Fax Number, PSTN Line Type, and PSTN Access Number if the machine is connected to a G3 analog line.</li><li>G3-2 Analog Line *1 Allows you to register Own Fax Number, PSTN Line Type, and PSTN Access Number if the optional Extra G3 Interface Unit is installed.</li></ul>	p.189 "G3 Analog Line"

Function Name		Description	Reference
System Settings	G3 Digital Line *2	Allows you to register Own Fax Number, Sub-address, and CSI if the machine is connected to a G3 digital line.	p.192 "G3 Digital Line"
	G4 Digital Line *2	Allows you to register Own Fax Number, Sub-address, and G4 Terminal ID if the machine is connected to a G4 digital line.	p.194 "G4 Digital Line"
	Fax On Demand Reception *3	Allows you to specify on/off setting for Fax On Demand function and the reception conditions.	p.197 "Fax On Demand Reception"
	Registering ID Codes	Allows you to register ID codes for using the following features: Polling Transmission/Reception, Transfer Request, ID Transmission/Reception, Confidential Transmission (Default ID), Confidential Reception, Remote Transfer, and Fax On Demand.	p.199 "Registering ID Codes"
	File Retention	Allows you to specify the duration for which the machine retains the failed transmission data in memory.	p.201 "File Retention"
	Transfer Report	Register your fax number to have the Transfer Result Report sent back from the Transfer Station when making a Transfer Request.	p.202 "Transfer Report"
	Network Settings *4	Allows you to make settings for connecting to a network when the NIC FAX Unit (Option for Type1) is installed.	See Chapter 1, "Network Settings" in the NIC FAX Unit manual.
	IP-Fax Parameters *4	Specify settings for using the IP-Fax function when the NIC FAX Unit (Option for Type1) is installed.	See Chapter 1, "IP-Fax Parameter Settings" in the NIC FAX Unit manual.
	System Parameter Transmission	Allows you to have information about the condition of your machine sent automatically to the nearest service representative.	p.204 "System Parameter Transmission"
	Key Layout	Allows you to select the key layout of characters assigned to Quick Dial keys.	p.205 "Key Layout"
	Print Position	Allows you to make margin adjustments if the image positioning varies depending on the paper tray used when receiving fax messages or making copies.	p.206 "Print Position"
Memory File Transfer	Allows you to specify the fax number of the destination when you wish to transfer all files stored in memory to another fax machine and print the data.	p.207 "Memory File Transfer"	



Function Name		Description	Reference
System Settings	Deleting Entries	Allows you to delete a group of ID codes or destinations programmed into Quick Dial keys by specifying their type.	p.209 "Deleting Entries"
	Reset PM Counter	Allows you to reset the counter for originals and printed paper when replacing the ADF Maintenance Kit or Fusing Maintenance Unit.	p.211 "Reset PM Counter"
Initial Setup	Multi-copy Reception	Allows you to have the machine print multiple copies of messages from specified senders or messages from senders other than those you specify.	p.214 "Multi-copy Reception"
	Authorized Reception	Allows you to block out fax messages from specified senders or messages from senders other than those you specify.	p.217 "Authorized Reception"
	Specified Tray <sup>*5</sup>	Allows you to specify the paper tray used for printing fax messages from specified senders or messages from senders other than those you specify.	p.220 "Specified Tray"
	Forwarding	Allows you to forward incoming fax messages to the registered destinations. You can specify different destinations for each sender.	p.223 "Forwarding"
	Memory Lock	Allows you to have the fax messages from specified senders or messages from senders other than those you specify stored in memory without printing.	p.233 "Memory Lock"
	TX/RX File Save <sup>*6 *7</sup>	Allows you to turn on or off this function. You can also register the sender of fax messages that you wish to receive.	p.236 "TX/RX File Save Settings"
	Backup File Transmission	Allows you to register the destination that the machine automatically sends all messages to for backup purposes.	p.243 "Backup File Transmission Settings"

Function Name		Description	Reference
Box Settings	Registering/ Editing/ Deleting Personal Boxes	Allows you to register, edit, or delete Personal Boxes.	p.246 "Personal Boxes"
	Registering/ Editing/ Deleting Information Boxes	Allows you to register, edit, or delete Information Boxes.	p.251 "Information Boxes"
	Registering/ Editing/ Deleting Transfer Boxes	Allows you to register, edit, or delete Transfer Boxes.	p.254 "Transfer Boxes"
	Printing the Box List	Allows you to print the Box List.	p.259 "Printing the Box List"

 **Note**

- The code for each function that appears on the display varies depending on the installed options or function settings.

# System Settings

## Economy Transmission

Economy Transmission allows you to take advantage of off-peak rates by delaying transmission of messages until a specified time.

Follow the procedure below to specify the Economy Transmission Time when the phone rates are lower.

### Note

- You can specify only one Economy Transmission Time.
- You can change the time setting by entering the new value in step 6 of the procedure described below.

### Reference

p.5 "Sending at a Specific Time (Send Later)"

- 1 Press the **[User Tools]** key.

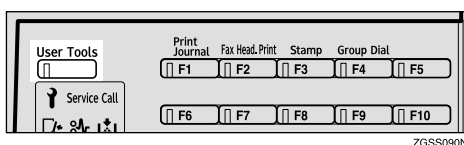

- 2 Enter the code for "Key Op. Tools" with the number keys. Then press the **[#]** key.

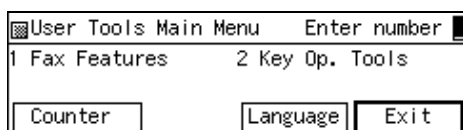

The "Key Op. Tools" main menu appears.

- 3 Enter the code for "System Settings" with the number keys.

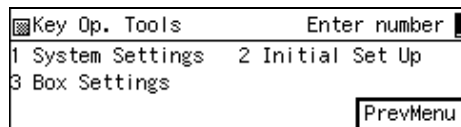

- 4 Enter the code for "Economy TX" with the number keys.

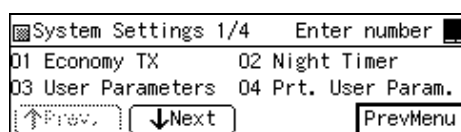

- 5 Press the **[Stop]** key or the **[Clear]** key to clear the current timer setting.

- 6 Enter the Economy Transmission Time with the number keys. To change AM/PM, press **[AM/PM]**.

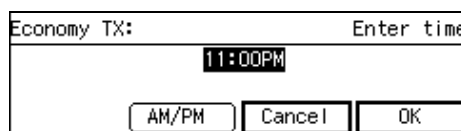

### Note

- You can enter any time between 01:00 and 12:59.
- If you make a mistake, press the **[Clear]** key or **[Stop]** key and enter the correct value.

- 7 Press **[OK]**.

### Note

- If you press **[Cancel]**, the entered time is canceled and the display shown in step 4 appears again.

- 8 Press **[PrevMenu]** twice.

- 9 Press **[Exit]** to return to the stand-by mode.

## Night Timer

Use this feature to have the machine turn its heater on and off automatically at the times that you prescribe. For example, by having the heater turned off during the night, on holidays or at other times when you are absent, you can cut power costs.

**Note**

- ❑ You can program the timer to turn the heater on or off twice daily over a 1-week cycle.
- ❑ Received fax messages are stored in memory (Substitute Reception) while the heater is turned off and not printed until the heater comes back on.
- ❑ You can edit previous settings for this feature by following the procedure described below.
- ❑ You cannot use the PC Printing function (option) while the heater is turned off by the Night Timer.

**1** Press the **[User Tools]** key.

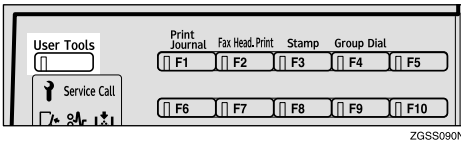

**2** Enter the code for "Key Op. Tools" with the number keys. Then press the **[#]** key.

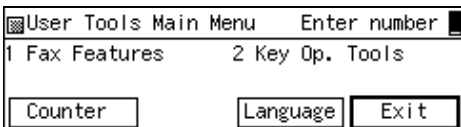

The "Key Op. Tools" main menu appears.

**3** Enter the code for "System Settings" with the number keys.

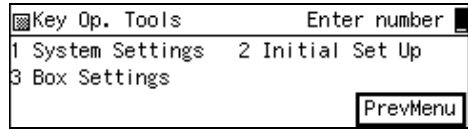

**4** Enter the code for "Night Timer" with the number keys.

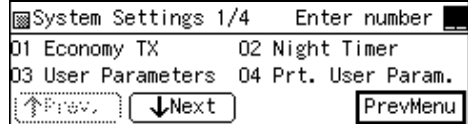

**5** Press **⏪** or **⏩** key to select "On".

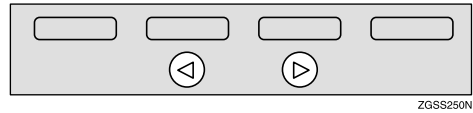
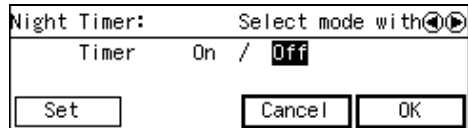

ZGSS250N

To turn the timer Off

**1** Press the arrow key to select "Off".

**2** Press **[OK]**.

**3** Press **[PrevMenu]** twice, then press **[Exit]**.

**6** Press **[Set]**.

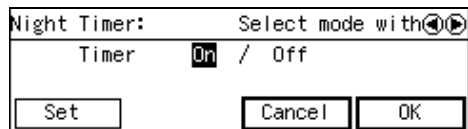

ZGSS190N

- 7** Press [**↓Next**] to scroll through the days of the week and timers (1 or 2).

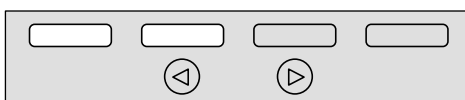
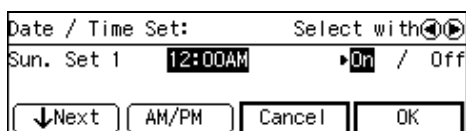

ZGSS230N

**Note**

- The days of the week and timers (1 or 2) are displayed in the following order: Sun. Set 1 → Sun. Set 2 → Mon. Set 1 → Mon. Set 2 → Tue. Set 1 → Tue. Set 2 → Wed. Set 1 → Wed. Set 2 → Thu. Set 1 → Thu. Set 2 → Fri. Set 1 → Fri. Set 2 → Sat. Set 1 → Sat. Set 2.

- 8** Press the [**Stop**] key to clear the current timer setting.

- 9** Enter the time with the number keys. To change AM/PM, press [**AM/PM**]

**Note**

- You can enter any time between 01:00 and 12:59.
- If you make a mistake, press the [**Clear**] key or [**Stop**] key and enter the correct value.

- 10** Press [Left] or [Right] key to select whether to turn the heater on or off at the set time.

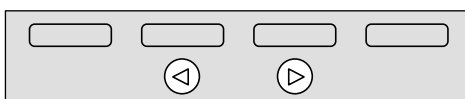
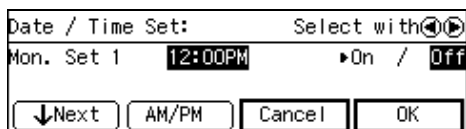

ZGSS250N

**Note**

- If you are programming the other timer also for this day of the week, press [**↓Next**] to display the other timer (for example, "Set 2") and repeat this step.
- To set the other timer for another day of the week, press [**↓Next**] to display the other timer and select the day of the week.

- 11** Press [**OK**].

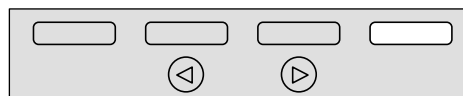
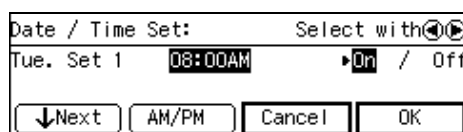

ZGSS220N

- 12** Press [**OK**].

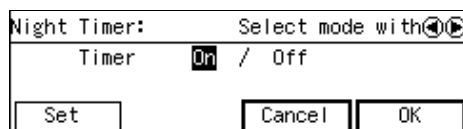

ZGSS220N

- 13** Press [**PrevMenu**] twice.

- 14** Press [**Exit**] to return to the standby mode.

### The Message Displayed While the Heater is Turned Off

While the Night Timer is activated and the heater is turned off, the message "Currently the machine is in Energy Saver Mode. Press [Clear Modes/Energy Saver] key to use functions." appears on the display.

Press **[Clear Modes/Energy Saver]** key to inactivate the Night Timer temporarily and print the received fax messages if there are any.

Then, if no operation is performed for about 5 minutes, the Night Timer turns the heater off again.

## User Parameters

The User Parameters allow you to customize various settings to match your needs.

Set the switches of each parameter to a new value to make changes to the settings.

### Preparation

Some User Parameters require installation of optional equipment or operations such as turning a function on or off before changing the switch values.

### ◆ Switches and Bits

Each User Parameter has a set of switches, and each of the switches consists of eight bits, whose values are "0" or "1". The right most bit is bit 0 and the left most is bit 7. You can adjust the settings to match your needs by switching the value of bits between "0" and "1".

	bit 7	bit 6	bit 5	bit 4	bit 3	bit 2	bit 1	bit 0
Switch 00	0	0	0	0	0	0	0	0
	↓	↓	↓	↓	↓	↓	↓	↓
	0	1	0	0	0	0	0	0

### Note

- The diagram above describes the change of setting for bit 6 of switch 00 from "0" (Memory Transmission) to "1" (Immediate Transmission).

## ◆ User Parameter List

Switch	Bits	Item	Available Settings	Reference
00	0	Stamp home position	1: On 0: Off	p.93 "Stamp"
	3,2,1	Image density adjustment level home position	000: Normal 001: Lighter 010: Darker	p.44 "Image Density", <Basic Features>
	5,4	Resolution home position	00: Standard 01: Detail 10: Super Fine 11: Extra Super Fine	p.42 "Resolution", <Basic Features>
	6	Transmission Mode home position	1: Immediate Transmission 0: Memory Transmission	p.29 "Switching between Memory Transmission and Immediate Transmission", <Basic Features>
	7	Halftone home position	1: On 0: Off	p.44 "Original Type", <Basic Features>
01	6	Emit a beep when a communication is complete	1: On 0: Off	p.104 "Adjusting Volume", <Basic Features>
	7	Return the machine to the home settings after each communication	1: On 0: Off	p.29 "Switching between Memory Transmission and Immediate Transmission", <Basic Features>, p.42 "Resolution", <Basic Features> and p.44 "Original Type", <Basic Features>

Switch	Bits	Item	Available Settings	Reference
02	0	Forwarding Mark	1: On 0: Off	p.223 "Forwarding"
	1	Center Mark	1: On 0: Off	p.120 "Center Mark"
	2	Print RX Time	1: On 0: Off	p.121 "Reception Time"
	3	TSI Print	1: On 0: Off	p.123 "TSI Print"
	4	Checked Mark	1: On 0: Off	p.120 "Checked Mark"
	5 *2	CIL Print	1: On 0: Off	p.123 "CIL Print"
	6 *2	TID Print	1: On 0: Off	p.123 "CIL Print"
03	0	Print Communication Result Report (Memory Transmission) automatically	1: On 0: Off	p.107 "Communication Result Report (Memory Transmission)"
	2	Print File Reserve Report (Memory Transmission) automatically	1: On 0: Off	p.107 "File Reserve Report (Memory Transmission)"
	3	Print File Reserve Report (Polling Reception) automatically	1: On 0: Off	p.21 "File Reserve Report (Polling Reception)"
	4	Print Communication Result Report (Polling Reception) automatically	1: On 0: Off	p.21 "Communication Result Report (Polling Reception)"
	5	Print Immediate Transmission Result Report automatically	1: On 0: Off	p.103 "Checking the Transmission Result"
	6	Print Polling Transmission Clear Report automatically	1: On 0: Off	p.25 "Polling Transmission Clear Report"
	7	Print Journal automatically	1: On 0: Off	p.53 "Printing the Journal"



Switch	Bits	Item	Available Settings	Reference
04	0	Print Confidential File Report automatically	1: On 0: Off	p.47 "Confidential File Report"
	1 *3	Print Fax On Demand Access Report automatically	1: On 0: Off	p.165 "Printing the Fax On Demand Access Report"
	3	Print failed transmission results in the Journal	1: On 0: Off	p.103 "Checking the Transmission Result"
	4	Give priority to the information provided by the receiving party when printing the Receiver's Name on Communication Result Report (Memory Transmission), Immediate Transmission Result Report, Journal, Disk File Search List/Visual List, and Error Report	1: Print the Own Name or Own Fax Number of the receiving fax machine 0: Print destination names programmed into Quick Dial keys or Speed Dials, or the fax number that you entered	p.50 "Printing the Journal" p.65 "Disk File Search List/Visual List" p.107 "Communication Result Report (Memory Transmission)" p.103 "Checking the Transmission Result" p.264 "Error Report"
	5	Reduce the size of the Journal when printing it	1: On 0: Off	p.53 "Printing the Journal"
	6	Print File Reserve Report when memory is full or a paper jam occurred	1: On 0: Off	p.107 "File Reserve Report (Memory Transmission)"
	7	Print a portion of image on File Reserve Report, Communication Result Report, Communication Failure Report, Polling Transmission Clear Report, and Transfer Result Report	1: On 0: Off	p.25 "Polling Transmission Clear Report" p.107 "File Reserve Report (Memory Transmission)" p.107 "Communication Result Report (Memory Transmission)" p.103 "Checking the Transmission Result" p.115 "Transfer Result Report"

Switch	Bits	Item	Available Settings	Reference
05	0	Substitute Reception	1: On 0: Off	p.111 "Substitute Reception"
	1	Condition for Substitute Reception	1: If Own Name or Own Fax Number is received 0: All incoming fax messages	p.111 "Substitute Reception"
	3	High Temperature Standby mode	1: On 0: Off	p.300 "Energy Saving"
	5,4	Restricted Access	00: Off 01: On 10: On when the Night Timer is on	p.25 "Restricted Access", <Basic Features>
	7,6	Energy Saver mode	00: Energy Saver Standby mode 01: Fax Standby mode	p.300 "Energy Saving"
06	0	Print the Fax Header or CIL <sup>*2</sup> on messages at the other end	1: On 0: Off	p.32 "Fax Header Print" p.123 "CIL Print"
	2	ID Transmission	1: On 0: Off	p.94 "ID Transmission"
	3 <sup>*2</sup>	Send the Fax Header with G4 transmission	1: On 0: Off	p.32 "Fax Header Print"
	4	Batch Transmission	1: On 0: Off	p.105 "Batch Transmission"
	6	SPID (Own Fax Number 2)	1: On 0: Off	p.192 "G3 Digital Line" p.194 "G4 Digital Line"
07	2	Parallel Memory Transmission	1: On 0: Off	p.105 "Parallel Memory Transmission"
	3	Auto Reduction	1: On 0: Off	p.93 "Auto Reduction"

Switch	Bits	Item	Available Settings	Reference
08	1,0	Multi-copy Reception	00: Off 01: Copy messages from specified senders 11: Copy messages from senders other than those you specify	p.214 "Multi-copy Reception"
	3,2	Authorized Reception	00: Off 01: Receive messages from specified senders 11: Receive messages from senders other than those you specify	p.217 "Authorized Reception"
	5,4 <sup>*4</sup>	Specified Tray Selection	00: Off 01: Messages from specified senders 11: Messages from senders other than those you specify	p.220 "Specified Tray"
	7,6	Forwarding	00: Off 01: Forward messages from specified senders 11: Forward messages from senders other than those you specify	p.223 "Forwarding"

Switch	Bits	Item	Available Settings	Reference
09	1,0	Memory Lock	00: Off 01: Messages from specified senders 11: Messages from senders other than those you specify	p.233 "Memory Lock"
	3,2 <sup>*6</sup>	TX/RX File Save	00: Off 01: Store messages from specified senders 11: Store messages from senders other than those you specify	p.236 "TX/RX File Save Settings"
	4	Store fax documents for the Memory Transmission while using the Manual Dial function	1: Enable 0: Disable	p.88 "Manual Dial"
	5	Forwarding function for messages intended for Specified Senders (messages intended for receivers other than those you specified if the setting for switch 08 bits 7,6 is "11") that are not registered with a forwarding destination	1: On 0: Off	p.223 "Forwarding"
	6	Requires the user to press <b>[Add]</b> when specifying destinations using Quick Dial keys successively	1: On 0: Off	p.49 "Using Quick Dials", <Basic Features>
	7	The output order of multiple sets of copies when using the Copying feature	1: Stack 0: Sort	p.127 "Copying"
10	1	Two in One	1: On 0: Off	p.121 "Two In One"
	2	Image Rotation	1: On 0: Off	p.122 "Image Rotation"
	4	Rotate Sort	1: On 0: Off	p.122 "Rotate Sort"

Switch	Bits	Item	Available Settings	Reference
10	5 * <sup>5</sup>	Use the optional Bypass Tray Unit exclusively for PC Printing	1: On 0: Off	—
	7	Halftone Mode	1: Speed Mode 0: Standard Mode	p.44 "Original Type", <Basic Features>
11	0	Transfer Request	1: On 0: Off	p.28 "Transfer Request"
	1 * <sup>2</sup>	Selection of tone (PB) or UUI after tone (·)	1: PB 0: UUI	p.47 "Tone", <Basic Features>
	2	Alarm for Blank Sheet Detect function	1: On 0: Off	p.101 "Blank Sheet Detect"
	6	Print Forwarded Messages Locally	1: On 0: Off	p.223 "Forwarding"
	7	Polling Files After Transmission	1: Store in memory 0: Delete after transmission	p.22 "Polling Transmission"
12	2	Toner Saver Mode	1: On 0: Off	p.124 "Toner saving"
	4,3	Print Image Density	00: Normal 01: Lighter 10: Darker	—
	7	Copying	1: Disable 0: Enable	p.127 "Copying"
13	1,0	Use the main G3 line as an internal PABX or an outside line	01: PABX 00: Outside line	p.189 "G3 Analog Line"
	3,2 * <sup>1</sup>	Use the second G3 line as an internal PABX or an outside line	01: PABX 00: Outside line	p.189 "G3 Analog Line"
	5 * <sup>2</sup>	Respond to a transmission without Own Fax Number when your Own Fax Number for ISDN is registered	1: Off 0: On	p.192 "G3 Digital Line" p.194 "G4 Digital Line"
	6 * <sup>2</sup>	Respond to a transmission received through an ISDN PBX unconditionally	1: On 0: Off	p.89 "Selecting the Line"

Switch	Bits	Item	Available Settings	Reference
19	2,1,0 *4 or *5	The paper tray used for printing Reports	000: Not specified 001: Main paper tray 010: Optional Paper Tray Unit (tray 2) 011: Optional Paper Tray Unit (tray 3) 100: Optional Paper Tray Unit (tray 4) 101: Optional Paper Tray Unit (tray 5) 111: Optional Bypass Tray Unit	p.50 "Printing the Journal" p.149 "Reports/Lists"
	7,6,5 *4 or *5	The paper tray selected automatically when an original is set for making copies	001: Main paper tray 010: Optional Paper Tray Unit (tray 2) 011: Optional Paper Tray Unit (tray 3) 100: Optional Paper Tray Unit (tray 4) 101: Optional Paper Tray Unit (tray 5) 111: Optional Bypass Tray Unit	p.127 "Copying"

Switch	Bits	Item	Available Settings	Reference
20	1 <sup>*7</sup>	Selection of "Ex. Super Fine" resolution for Copying	1: Enable 0: Disable	p.127 "Copying"
	2	Selection of "Ex. Super Fine" resolution for transmission	1: Enable 0: Disable	p.42 "Resolution", <Basic Features>
	3 <sup>*7</sup>	Selection of "Ex. Super Fine" resolution for reception	1: Enable 0: Disable	p.42 "Resolution", <Basic Features>
	4	Scanner Cleaning function	1: On 0: Off	p.101 "Scanner Cleaning Message"
	5	Use the User Code (name of the Personal Box) as the Fax Header	1: On 0: Off	p.32 "Fax Header Print"
	7	Scanner Cleaning Message	1: Display 0: Not display	p.101 "Scanner Cleaning Message"
21	0 <sup>*2</sup>	The line selected when you press the <b>【On Hook Dial】</b> key	1: ISDN 0: PSTN	p.86 "Using On Hook Dial with ISDN"
31	7,6	Duration of time before the machine exits High Temperature Standby Mode after a printing job is complete	00: 15 min. 01: 30 min. 10: 60 min. 11: 120 min.	p.300 "Energy Saving"

#### Necessary Options:

\*1 Extra G3 Interface Unit

\*2 ISDN Unit

\*3 Fax On Demand Unit

\*4 Paper Tray Unit

\*5 Bypass Tray Unit

\*6 Function Upgrade Unit and Optional 40MB Memory Card

\*7 40MB Memory Card

#### 📌 Limitation

- When setting User Parameters (switch 20 bits 1, 2, 3) for "Enable", the machine may not be able to send or receive fax messages using multiple lines, or copy or print the received fax messages.

## How to Set User Parameters

This section describes how to set User Parameters, using transmission mode as an example. To change the transmission mode from Memory Transmission to Immediate Transmission, you need to change the bit 6 of switch 00 from 0 to 1.

### Important

- Do not change any bit switches other than those listed in the previous section.

### Note

- You can print the User Parameter List to check the current settings. However, only the items of much importance or the items that you often use are included in the list. See p.189 "Printing the User Parameter List".

7

- Press the **[User Tools]** key.

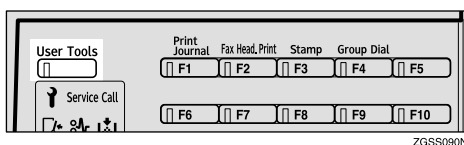

- Enter the code for "Key Op. Tools" with the number keys. Then press the **[#]** key.

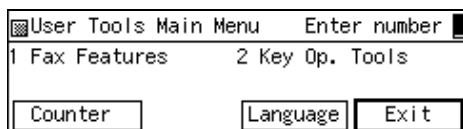

The "Key Op. Tools" main menu appears.

- Enter the code for "System Settings" with the number keys.

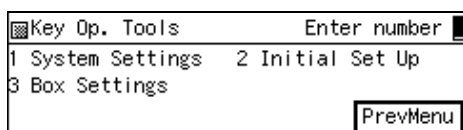

- Enter the code for "User Parameters" with the number keys.

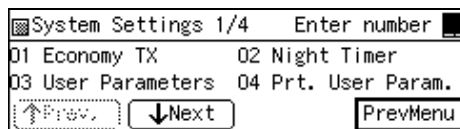

- Make sure that switch 00 is displayed.

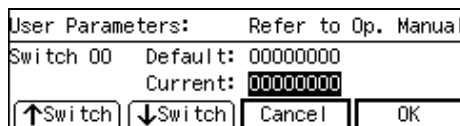

### Note

- To show other switches, press **[Switch]** or **[Switch]**.

- Press number key **[6]** to change the value of bit 6 to 1.

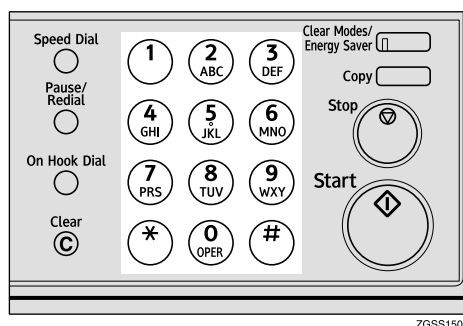

### Note

- Each time you press number key **[6]**, the value switches between 1 and 0.

- Press **[OK]**.

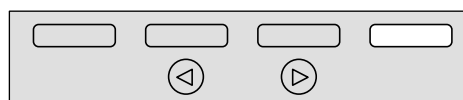
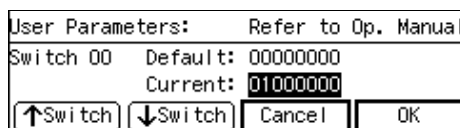



**Note**

- If you press **[Cancel]**, the display in step 4 reappears.
- The bits are displayed in ascending order from right to left, the right most bit being bit 0.
- Some items use multiple bits for their settings such as "Image density adjustment level."

**8** Press **[PrevMenu]** twice.

**9** Press **[Exit]** to return to the stand-by mode.

## Printing the User Parameter List

Print the User Parameter List manually to check the current User Parameter settings.

**1** Press the **[User Tools]** key.

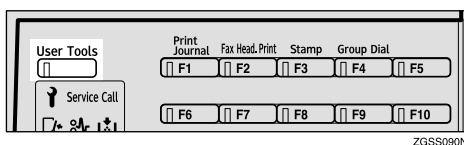

**2** Enter the code for "Key Op. Tools" with the number keys. Then press the **[#]** key.

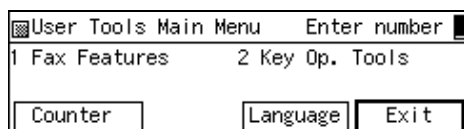

The "Key Op. Tools" main menu appears.

**3** Enter the code for "System Settings" with the number keys.

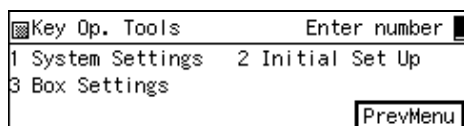

**4** Enter the code for "Prt. User Param." with the number keys.

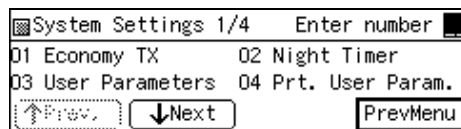

**5** Press the **[Start]** key to print the list.

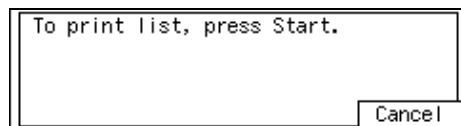
**Note**

- If you press **[Cancel]** before printing starts, the printing stops and the display shown in step 4 appears again.

**6** Press **[PrevMenu]** twice.

**7** Press **[Exit]** to return to the stand-by mode.

## G3 Analog Line

You need to make settings for the G3-1 Analog Line before you connect the machine to a standard G3 analog line, and for the G3-2 Analog Line to connect to a G3 analog line by installing the optional Extra G3 Interface Unit.

### ❖ G3-1 Analog Line

- Own Fax Number (CSI) (up to 20 digits)  
Register an international identification number as your Own Fax Number (Called Station Identification), which is passed to the other party when you send or receive a fax.
- PSTN Line Type  
Select whether the connected line uses tone or pulse dialing.

- **PSTN Access Number**  
Use this setting if your machine is connected to a PBX that requires you to dial certain number such as "0" followed by a pause to connect to the outside line. By registering "0" as the PSTN Access Number, a pause will be inserted automatically after the "0" when dialing.

❖ **G3-2 Analog Line**

- **Own Fax Number (CSI) (up to 20 digits)**  
Register an international identification number as your Own Fax Number (Called Station Identification), which is passed to the other party when you send or receive a fax.
- **PSTN Line Type**  
Select whether the connected line uses tone or pulse dialing.
- **PSTN Access Number**  
Use this setting if your machine is connected to a PBX that requires you to dial certain number such as "0" followed by a pause to connect to the outside line. By registering "0" as the PSTN Access Number, a pause will be inserted automatically after the "0" when dialing.

 **Note**

- ❑ The Own Fax Number (CSI) is passed to the other party when you send or receive a fax. When the Own Fax Number is received, it is shown on the display or printed on reports on the receiver's or sender's machine. The Own Fax Number works even if the receiver or sender uses a different make of machine.

**1** Press the **[User Tools]** key.

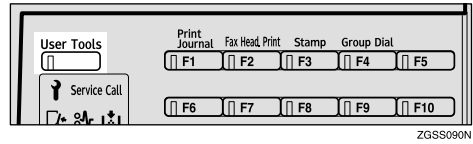

**2** Enter the code for "Key Op. Tools" with the number keys. Then press the **[#]** key.

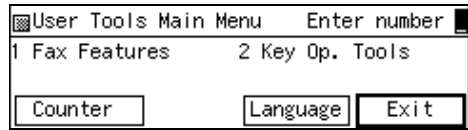

The "Key Op. Tools" main menu appears.

**3** Enter the code for "System Settings" with the number keys.

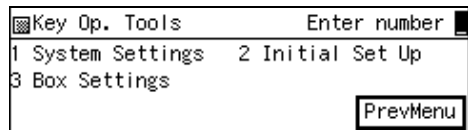

**4** Enter the code for "G3 Analog Line" with the number keys.

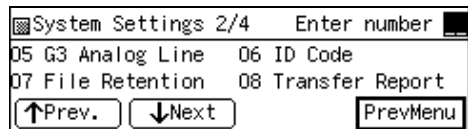

 **Note**

- ❑ If "G3 Analog Line" is not displayed, press [**↑Prev.**] or [**↓Next**] until it is.

**5** Enter the code for either "G3-1 Analog Line" or "G3-2 Analog Line" with the number keys.

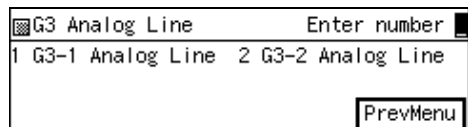

**Note**

- "G3-2 Analog Line" appears only when the optional Extra G3 Interface Unit is installed. The setting procedure is the same for both lines.

- 6** Depending on the setting you wish to register, use one of the following procedures:

---

### Registering Own Fax Number

---

- 1** Enter the code for "Own Fax Number" with the number keys.

G3-1 Analog Line Enter number

1 Own Fax Number 2 PSTN Line Type

3 PSTN Access No.

PrevMenu

- 2** Enter your Own Fax Number.

Own Fax Number(CSI): Enter fax number

+ Space Cancel OK

**Note**

- The Own Fax Number (CSI) can contain a plus sign (+), numbers and spaces. Register your country code, area code (minus the leading zero) and your fax number in that order.

- 3** Press [OK].

---

### Selecting a PSTN Line Type

---

- 1** Enter the code for "PSTN Line Type" with the number keys.

G3-1 Analog Line Enter number

1 Own Fax Number 2 PSTN Line Type

3 PSTN Access No.

PrevMenu

- 2** Press **4** or **2** key to select a PSTN line type.

PSTN Line Type: Select mode with 4/2

1 / DP

Cancel OK

- 3** Press [OK].

---

### Registering a PSTN Access Number

---

- 1** Enter the code for "PSTN Access No." with the number keys.

G3-1 Analog Line Enter number

1 Own Fax Number 2 PSTN Line Type

3 PSTN Access No.

PrevMenu

**Note**

- The PSTN Access Number function is not available for On Hook Dialing, while the optional Handset is off the hook, or when dialing using the external telephone.

- 2** Enter PSTN Access Number with the number key.

PSTN Access No.: Enter number

Cancel OK

**Note**

- You can enter a number between 0 and 9, or 00 and 99.

**3** Press [OK].

**Note**

- If you are making settings for the "G3-1 Analog Line," change the setting for the standard G3 line to PABX with User Parameters after registering the PSTN Access Number. See p.178 "User Parameters" (switch 13 bits 1,0).
- If you are making settings for the "G3-2 Analog Line," change the setting for the second G3 line to PABX with User Parameters after registering the PSTN Access Number. See p.178 "User Parameters" (switch 13 bits 3,2).

**7** Press [PrevMenu] four times.

**8** Press [Exit] to return to the stand-by mode.

**G3 Digital Line**

*This function requires the optional ISDN Unit.*

The following settings are available for G3 communications over ISDN:

- Own Fax Number 1  
Enter the number of the line (PSTN) the machine is connected to.
- SPID (Own Fax Number 2)  
Enter the second fax number if you are using two numbers for one line.
- Sub-address  
See p.82 "Sub-address".
- Own Fax Number (CSI) (maximum 20 characters)  
Enter Own Fax Number (Called Station Identification) that is transferred to the other party during transmission or reception.

**Note**

- Before storing the sub-address, store the Sub-address function in a User Function key. See p.154 "User Function Keys".
- Own Fax Number (CSI) is an international identification number that is transferred to the other party during transmission or reception. This information appears on the display of the other party's fax machine and is printed on their lists and reports. The Own Fax Number (CSI) feature works with other manufacturer's fax machines that support this feature.
- After registering the Own Fax Number 1 or 2, you can make settings so that the machine does not respond to incoming faxes that do not send their Own Fax Numbers with User Parameters. See p.178 "User Parameters" (switch 13 bit 5).

**Reference**

p.89 "Selecting the Line"

**1** Press the [User Tools] key.

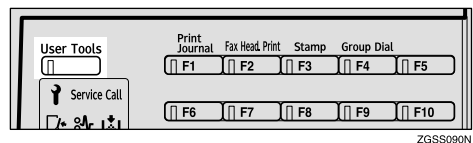

**2** Enter the code for "Key Op. Tools" with the number keys. Then press the [#] key.

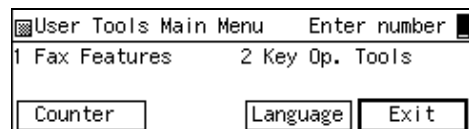

- 3** Enter the code for "System Settings" with the number keys.

Key Op. Tools		Enter number
1 System Settings	2 Initial Set Up	
3 Box Settings		

PrevMenu

- 4** Enter the code for "G3 Digital Line" with the number keys.

System Settings 2/5		Enter number
05 G3 Analog Line	06 G3 Digital Line	
07 G4 Digital Line	08 Fax On Demand	

**Note**

- If "G3 Digital Line" is not displayed, press [] or [] until it is.

- 5** Depending on the setting you wish to register, use one of the following procedures:

#### Registering your Own Fax Number 1

- 1** Enter the code for "Own Fax Number 1" with the number keys.

G3 Digital Line		Enter number
1 Own Fax Number 1	2 SPID	
3 Sub-address	4 Own Fax No.(CSI)	

PrevMenu

- 2** Enter the fax number.

Own Fax Number 1:	Enter own number
<input type="text"/>	

**Note**

- If your fax number is 123-456-7890, enter "1234567890."
- 3** Press [OK].

#### Registering your SPID (Own Fax Number 2)

- 1** Enter the code for "SPID" with the number keys.

G3 Digital Line		Enter number
1 Own Fax Number 1	2 SPID	
3 Sub-address	4 Own Fax No.(CSI)	

PrevMenu

- 2** Enter the fax number.

SPID:	Enter SPID number
<input type="text"/>	

**Note**

- If your fax number is 123-456-7890, enter "1234567890."

- 3** Press [OK].

#### Registering the Sub-address

- 1** Enter the code for "Sub-address" with the number keys.

G3 Digital Line		Enter number
1 Own Fax Number 1	2 SPID	
3 Sub-address	4 Own Fax No.(CSI)	

PrevMenu

- 2** Enter the sub-address (4-digit number).

Sub-address:	Enter 4-digit number
<input type="text"/>	

- 3** Press [OK].

## Registering the Own Fax Number (CSI)

- 1 Enter the code for "Own Fax No.(CSI)" with the number keys.

G3 Digital Line Enter number

1 Own Fax Number 1	2 SPID
3 Sub-address	4 Own Fax No.(CSI)

PrevMenu

- 2 Enter the Own Fax Number (CSI).

Own Fax Number(CSI): Enter fax number

0 1 2 3 4 5 6 7 8 9

+ Space Cancel OK

### Note

- Own Fax Number (CSI) can contain a plus sign (+), numbers and spaces. Register your country code, area code (minus the leading zero) and your fax number in that order.

- 3 Press [OK].

- 6 Press [PrevMenu] three times.

- 7 Press [Exit] to return to the standby mode.

## G4 Digital Line

*This function requires the optional ISDN Unit.*

Register these settings before connecting to the ISDN. You can store the following items:

- Own Fax Number 1  
Enter the number of the line (ISDN) the machine is connected to.
- SPID (Own Fax Number 2)  
Enter the second fax number if you are using two numbers for one line.
- Sub-address  
See p.82 "Sub-address".
- G4 Terminal ID (TID) (maximum 22 characters)  
The G4 Terminal ID (TID) feature is available only when you are subscribed to an ISDN service. TID is printed on the fax message received on the other end when you perform G4 transmission with ISDN.

### Note

- Before storing the sub-address, store the Sub-address function in a User Function key. See p.154 "User Function Keys".
- Contact your service representative when you register or change the sub-address.
- The G4 Terminal ID (TID) consists of your country code, Own Digital Number (fax number) and Terminal Name, and is registered in that order. Company names are normally used as Terminal Names.

- ❑ After registering Own Fax Number 1 or 2, you can make settings so that the machine does not respond to incoming faxes that do not send their Own Fax Numbers with User Parameters. See p.178 "User Parameters" (switch 13 bit 5).

## 🔍 Reference

p.89 "Selecting the Line"

- 1 Press the **[User Tools]** key.

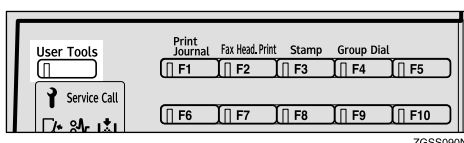

- 2 Enter the code for "Key Op. Tools" with the number keys. Then press the **[#]** key.

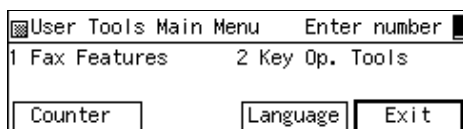

The "Key Op. Tools" main menu appears.

- 3 Enter the code for "System Settings" with the number keys.

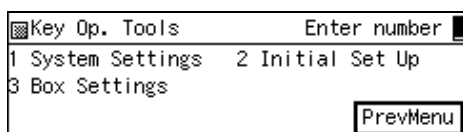

- 4 Enter the code for "G4 Digital Line" with the number keys.

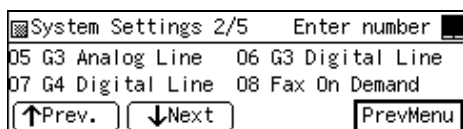

## 📝 Note

- ❑ If "G4 Digital Line" is not displayed, press **[↑Prev.]** or **[↓Next]** until it is.

- 5 Depending on the setting you wish to register, use one of the following procedures:

### Registering your Own Fax Number 1

- 1 Enter the code for "Own Fax Number 1" with the number keys.

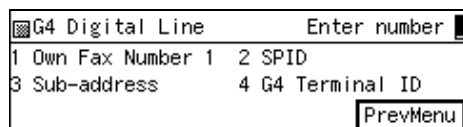

- 2 Enter the fax number.

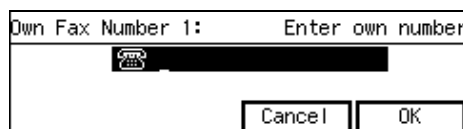

## 📝 Note

- ❑ If your fax number is 123-456-7890, enter "1234567890."

- 3 Press **[OK]**.

### Registering Your SPID (Own Fax Number 2)

- 1 Enter the code for "SPID" with the number keys.

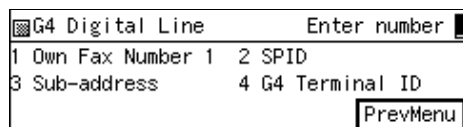

- 2 Enter the fax number.

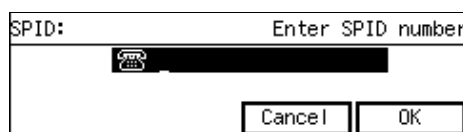

## 📝 Note

- ❑ If your fax number is 123-456-7890, enter "1234567890."

- 3 Press **[OK]**.

### Registering the Sub-address

1 Enter the code for "Sub-address" with the number keys.

G4 Digital Line		Enter number
1 Own Fax Number 1	2 SPID	
3 Sub-address	4 G4 Terminal ID	
		PrevMenu

2 Enter the sub-address (4-digit number).

Sub-address:	Enter 4-digit number
[Redacted]	
Cancel OK	

3 Press [OK].

### Registering the G4 Terminal ID

1 Enter the code for "G4 Terminal ID" with the number keys.

G4 Digital Line		Enter number
1 Own Fax Number 1	2 SPID	
3 Sub-address	4 G4 Terminal ID	
		PrevMenu

2 Enter the code for "Country Code" with the number keys.

G4 Terminal ID		Enter number
1 Country Code	2 Own Digital No.	
3 Terminal Name		
		PrevMenu

3 Enter your country code with the number keys.

G4 Terminal ID Country Code:	Enter code
[Redacted]	
Cancel OK	

4 Press [OK].

5 Enter the code for "Own Digital No." with the number keys.

G4 Terminal ID		Enter number
1 Country Code	2 Own Digital No.	
3 Terminal Name		
		PrevMenu

6 Enter the Own digital Number with the number keys.

G4 Terminal ID Own No.:	Enter fax number
[Redacted]	
Cancel OK	

#### Note

Make sure to store Own Digital Number.

7 Press [OK].

8 Enter the code for "Terminal Name" with the number keys.

G4 Terminal ID		Enter number
1 Country Code	2 Own Digital No.	
3 Terminal Name		
		PrevMenu

9 Enter the Terminal Name.

Enter Terminal Name	Uppercase		
[Redacted]			
ABC/abc	Symbols	Cancel	OK

#### Reference

p.98 "Entering Characters", <Basic Features>

10 Press [OK].

#### Note

If the entered TID's total number of characters (country code + Own Digital Number + Terminal Name) exceeds 22, a message appears asking you to enter the TID in 22 characters or less, and then the screen shown in step 9 is displayed. Enter a new Terminal Name, so that your TID's total number of characters is within the limit.

11 Press [PrevMenu].

6 Press [PrevMenu] three times.

7 Press [Exit] to return to the stand-by mode.



## Fax On Demand Reception

This feature requires the optional Fax On Demand Unit.

You can turn the Fax On Demand function on or off, set the password (whether the calling party needs to specify the password) or select the line type for the reception.

### Note

- ❑ The Remote ID is used as the password. See p.199 "Registering ID Codes".

### Reference

p.160 "Fax On Demand"

- 1 Press the **[User Tools]** key.

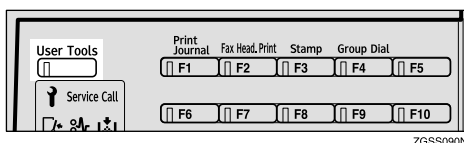

- 2 Enter the code for "Key Op. Tools" with the number keys. Then press the **[#]** key.

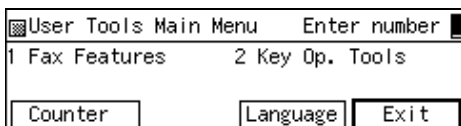

The "Key Op. Tools" main menu appears.

- 3 Enter the code for "System Settings" with the number keys.

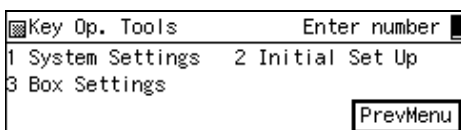

- 4 Enter the code for "Fax On Demand" with the number keys.

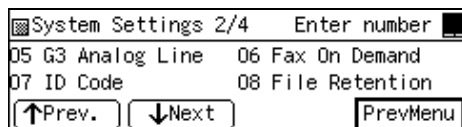

### Note

- ❑ If "Fax On Demand" is not displayed, press **[↑Prev.]** or **[↓Next]** until it is.

- 5 Press **[←]** or **[→]** key to select "On (with ID)," "On (without ID)," or "Off."

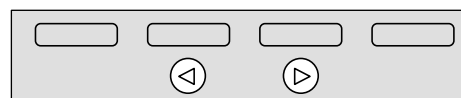
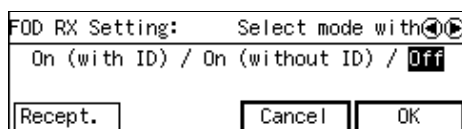

ZGSS250N

### Note

- ❑ To require the calling party to specify the password, select "On (with ID)," and select "On (without ID)" if you do not require a password.
- ❑ The Remote ID is used as the password. See p.199 "Registering ID Codes".

- 6 Press **[Recept.]** if you wish to set the line type for the reception.

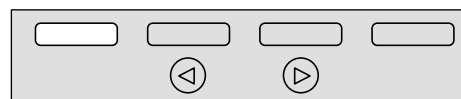
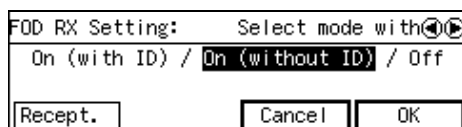

ZGSS190N

Proceed to step **7** if you are not specifying the line type.

7

- 7** Press **◀** or **▶** key to select "By port".

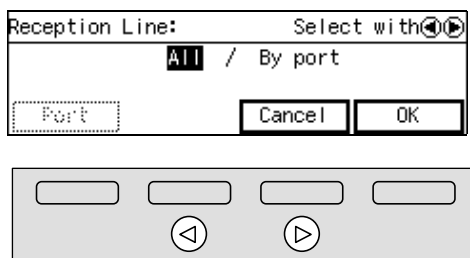

ZGSS250N

- 8** Press **[Port]**.

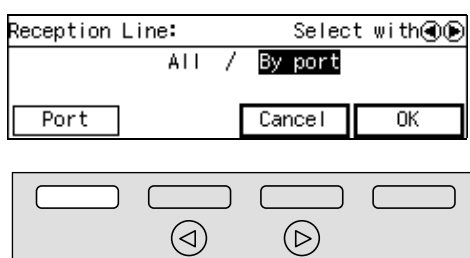

ZGSS190N

- 9** Enter the code for the line type with the number keys.

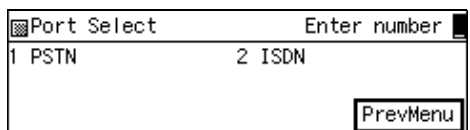

#### Note

- "ISDN" appears only when the optional ISDN Unit is installed.

### Selecting a PSTN Line

- 1** Press **◀** or **▶** key to select the line.

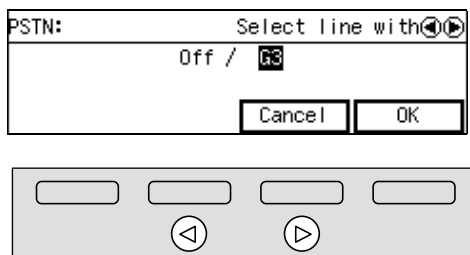

ZGSS250N

#### Note

- The following screen is displayed if the optional Extra G3 Interface Unit is installed:

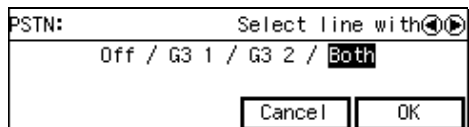

- 2** Press **[OK]**.

### Selecting an ISDN Line

- 1** Press **◀** or **▶** key to select "By line".

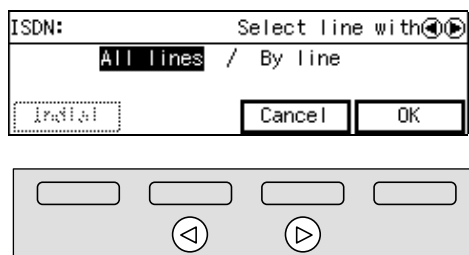

ZGSS250N

- 2** Press **[Indial]**, then select the own fax number.

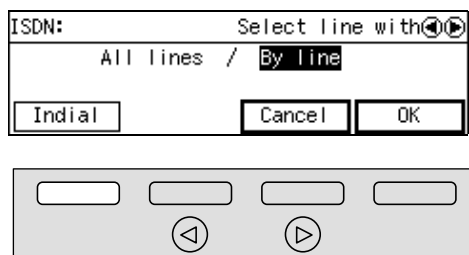

ZGSS190N

#### Note

- To set the fax number for Indial, press **[Indial]** and select the fax number for reception. Then press **[OK]**.

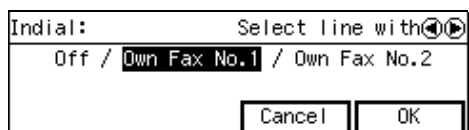

- 3** Press **[OK]**.

- 10** Press [PrevMenu].

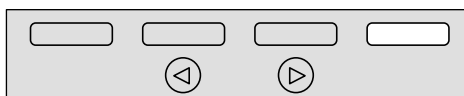
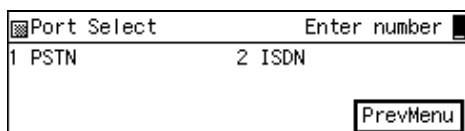

ZGSS220N

- 11** Press [OK].

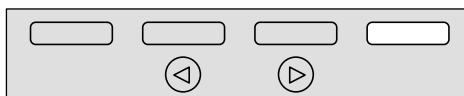
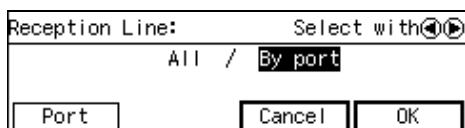

ZGSS220N

- 12** Press [OK].

- 13** Press [PrevMenu] twice.

- 14** Press [Exit] to return to the stand-by mode.

## Registering ID Codes

ID codes are required when using transmission modes such as Polling Transmission or Confidential Messages.

Register the following types of ID code before using the transmission modes:

### ❖ Confidential ID

This ID is usually required for printing a message received with the Confidential Reception feature. See p.46 "Printing a Confidential Message".

### ❖ Polling ID

This ID is required for using the Transfer Request (See p.28 "Transfer Request"), Transfer Station (See p.114 "Transfer Station"), Default ID Polling Transmission (See p.22 "Polling Transmission"), Default ID Polling Reception (See p.19 "Polling Reception"), ID Transmission (See p.94 "ID Transmission"), and the ID Reception (See p.119 "ID Reception") functions. When using the ID Transmission feature, register the same Polling ID as the other party does.

### ❖ Memory Lock ID

This ID is required for printing a message received using the Memory Lock feature. Register this ID when you specify the destinations for Memory Lock. See p.48 "Printing a Memory-locked Message".

### ❖ Remote ID

Register the ID that is used for the Remote Transfer Request and Fax On Demand feature. See p.116 "Remote Transfer" and p.160 "Fax On Demand".

**Note**

- ❑ You can check the registered ID codes on the User Parameter List. It is recommended that you print and keep the list after you register or edit IDs. See p.189 "Printing the User Parameter List".
- ❑ You cannot receive faxes with the Confidential Reception feature without registering the Confidential ID beforehand.
- ❑ A Polling ID can be any combination of four digits (0 - 9) or letters (A - F) except for 0000 and FFFF.
- ❑ A Confidential ID and Memory Lock ID can be any four digit numeric code except for 0000.
- ❑ You can edit the IDs already registered in the machine following the same procedure for registering a new ID. When editing a registered ID, the current ID is displayed on the screen. Press the **[Clear]** key or the **[Stop]** key and enter the new ID.

**Registering**

Follow the procedure described below to register ID codes:

**Example: Registering the Confidential ID**

**1** Press the **[User Tools]** key.

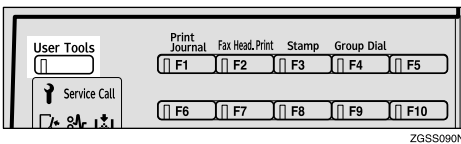

**2** Enter the code for "Key Op. Tools" with the number keys. Then press the **[#]** key.

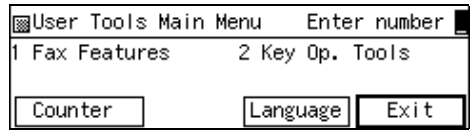

The "Key Op. Tools" main menu appears.

**3** Enter the code for "System Settings" with the number keys.

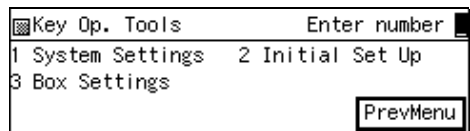

**4** Enter the code for "ID Code" with the number keys.

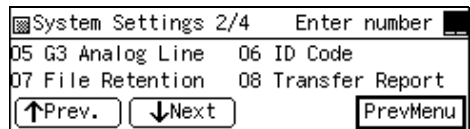

**Note**

- ❑ If "ID Code" is not displayed, press **[↑Prev.]** or **[↓Next]** until it is.

**5** Enter the code for "Confidential ID" with the number keys.

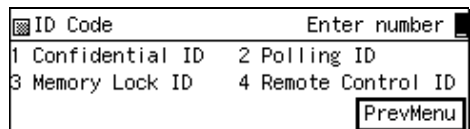

**6** Enter the Confidential ID (4-digit number).

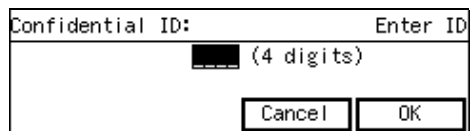

**Note**

- ❑ If you enter the code incorrectly, press the **[Clear]** key or the **[Stop]** key and enter the correct code.

**7** Press [OK].

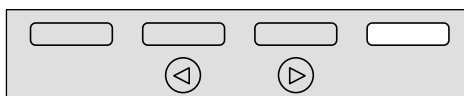

ZGSS220N

**Note**

- To register other ID codes, repeat the procedure from step 5.

**8** Press [PrevMenu] three times.**9** Press [Exit] to return to the standby mode.

## File Retention

The File Retention function allows you to have the fax file/document retained in memory if a connection could not be made to the other party during a Memory Transmission (even though the number was redialed the stipulated number of times). This function is activated when it is set to either "24 hours" or "72 hours."

If a file/document is stored in memory, you can easily send it without having to scan it in again.

**Reference**

p.40 "Re-sending a file"

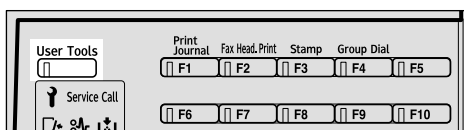
**1** Press the [User Tools] key.

ZGSS090N

**2** Enter the code for "Key Op. Tools" with the number keys. Then press the [#] key.

The "Key Op. Tools" main menu appears.

**3** Enter the code for "System Settings" with the number keys.

**4** Enter the code for "File Retention" with the number keys.

**Note**

- If "File Retention" is not displayed, press [↑Prev.] or [↓Next] until it is.

**5** Press ⏪ or ⏩ key to select the time or turn off this function.



ZGSS250N

**6** Press [OK].**7** Press [PrevMenu] twice.**8** Press [Exit] to return to the standby mode.

## Transfer Report

This section describes the procedure for registering the fax number of the line your machine is connected to as the return address for Transfer Requests.

When you make a Transfer Request from this machine, the registered number is sent to the Transfer Station. The Transfer Station then sends back the Transfer Result Report to this fax number.

You can register a fax number (return address) for each telephone line your machine is connected to, as described below.

- **G3 Direct number**  
The G3 Direct number is usually registered with the International Access Code such as "011," country code, area code (minus the leading zero), "-" (a pause), and the fax number in that order. You can use up to 16 digits.  
Example: If your country code is 1, area code is 222, and fax number is 123-4567, register the G3 Direct number as "0111222-1234567."
- **G3 PABX Number**  
The fax number for a PABX line is usually registered with the PABX Access Number, Department code, "-" (a pause), and the PABX number in that order. You can use up to 16 digits.  
Example: If your PABX Access Number is 8, Department code is 12, and PABX number is 3456, register the G3 PABX Number as "812-3456."

- **G4 Fax Number**  
The G4 Fax Number is usually registered with the International Access Code such as "011," country code, area code (minus the leading zero), "-" (a pause), the fax number, and the sub-address with a "/" (slash) if you are using the sub-address in that order. You can use up to 29 digits.  
Example: If your country code is 1, area code is 222, fax number is 123-4567 and the sub-address is 01, register the G4 Fax Number as "0111222-1234567/01."

**Limitation**

- If the line is being used (i.e. communication is in progress), you cannot register or edit the fax numbers. Perform the procedure after the communication is complete.

**Note**

- The Transfer Request function will not be activated unless the return address is registered. See p.28 "Transfer Request".

**1 Press the [User Tools] key.**

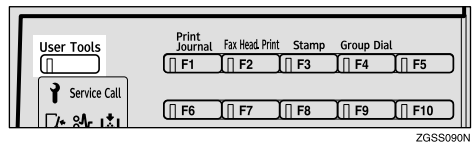

**2 Enter the code for "Key Op. Tools" with the number keys. Then press the [#] key.**

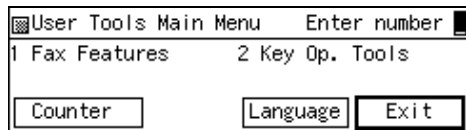

The "Key Op. Tools" main menu appears.

- 3** Enter the code for "System Settings" with the number keys.

Key Op. Tools		Enter number	
1	System Settings	2	Initial Set Up
3	Box Settings		
			PrevMenu

- 4** Enter the code for "Transfer Report" with the number keys.

System Settings 2/4		Enter number	
05	G3 Analog Line	06	ID Code
07	File Retention	08	Transfer Report
↑Prev.		↓Next	
			PrevMenu

**Note**

- If "Transfer Report" is not displayed, press [↑Prev.] or [↓Next] until it is.

- 5** Depending on the setting you wish to register, use one of the following procedures:

#### Registering a G3 Direct Number

- 1** Enter the code for "G3 Direct Number" with the number keys.

Transfer Report		Enter number	
1	G3 Direct Number	2	G3 PABX Number
3	G4 Fax Number		
			PrevMenu

- 2** Enter the fax number to be used as the return address.

G3 Direct Number:	Enter own number
<input type="text"/>	
<input type="button" value="Cancel"/> <input type="button" value="OK"/>	

- 3** Press [OK].

#### Registering a G3 PABX Number

- 1** Enter the code for "G3 PABX Number" with the number keys.

Transfer Report		Enter number	
1	G3 Direct Number	2	G3 PABX Number
3	G4 Fax Number		
			PrevMenu

- 2** Enter the fax number to be used as the return address.

G3 PABX Number:	Enter own number
<input type="text"/>	
<input type="button" value="Cancel"/> <input type="button" value="OK"/>	

- 3** Press [OK].

#### Registering a G4 Fax Number

- 1** Enter the code for "G4 Fax Number" with the number keys.

Transfer Report		Enter number	
1	G3 Direct Number	2	G3 PABX Number
3	G4 Fax Number		
			PrevMenu

- 2** Enter the fax number to use as the return address.

G4 Fax Number:	Enter own number
<input type="text"/>	
<input type="button" value="Cancel"/> <input type="button" value="OK"/>	

- 3** Press [OK].

- 6** Press [PrevMenu] three times.

- 7** Press [Exit] to return to the stand-by mode.

## Network Settings

Use of these settings requires the NIC FAX Unit (Option for Type1).

Adjust these settings to set up the Internet Fax Feature (Option for Type1).

For details, see Chapter 1, "Network Settings" in the NIC FAX Unit manual.

## IP-Fax Parameter Settings

Use of these settings requires the NIC FAX Unit (Option for Type1).

Adjust these settings to set up the IP-Fax Feature (Option for Type1).

For details, see Chapter 1, "IP-Fax Parameter Settings" in the NIC FAX Unit manual.

7

## System Parameter Transmission

This feature sends information about the condition of your machine to your nearest service representative. Follow these steps when your service representative requests you to.

### Note

- This information is sent to the destination registered in your machine by a service representative.
- This information is sent directly from the machine's memory to your service representative.

**1** Press the **[User Tools]** key.

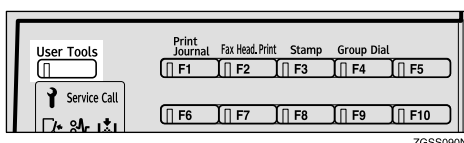

**2** Enter the code for "Key Op. Tools" with the number keys. Then press the **[#]** key.

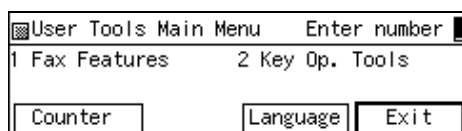

The "Key Op. Tools" main menu appears.

**3** Enter the code for "System Settings" with the number keys.

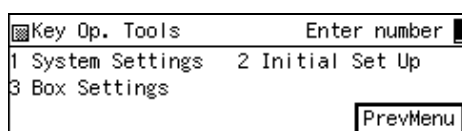

**4** Enter the code for "System Param. TX" with the number keys.

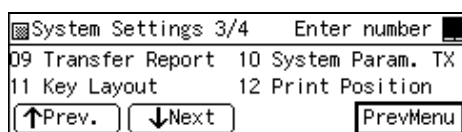

### Note

- If "System Param. TX" is not displayed, press **[↑Prev.]** or **[↓Next]** until it is.

**5** Press the **[Start]** key.

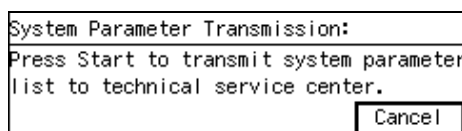

The fax number registered by a service representative appears.

The standby screen is displayed when the transmission is complete.



## Key Layout

You can change the layout of characters assigned to Quick Dial keys, which are used for entering characters. Two types of layout are provided, the QWERTY layout and the ABC layout.

### ❖ QWERTY Layout

Q	W	E	R	T	Y	U	I	O	P	@	-
A	S	D	F	G	H	J	K	L	.	-	
ABC/abc	Space	Z	X	C	V	B	N	M	(	)	★

ZGSS033N

### ❖ ABC Layout

A	B	C	D	E	F	G	H	I	J	K	L
M	N	O	P	Q	R	S	T	U	V	W	X
Y	Z	ABC/abc	Space	@	-	.	-		(	)	★

ZGSS034N

### Note

- ❑ Set one of the keyboard labels that come with the machine on the control panel according to choice.

### 1 Press the [User Tools] key.

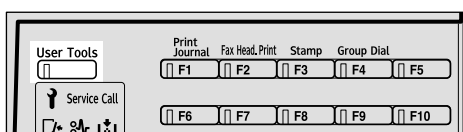

ZGSS090N

### 2 Enter the code for "Key Op. Tools" with the number keys. Then press the [#] key.

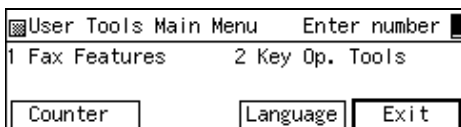

The "Key Op. Tools" main menu appears.

### 3 Enter the code for "System Settings" with the number keys.

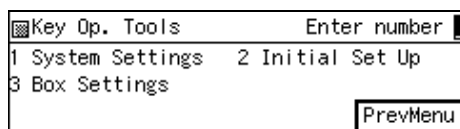

### 4 Enter the code for "Key Layout" with the number keys.

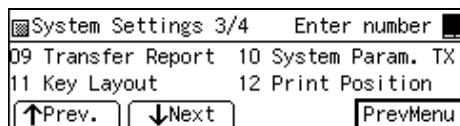

### Note

- ❑ If "Key Layout" is not displayed, press [↑Prev.] or [↓Next] until it is.

### 5 Press [◀] or [▶] key to select "QWERTY" or "ABCDEF".

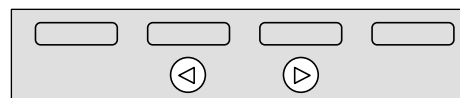
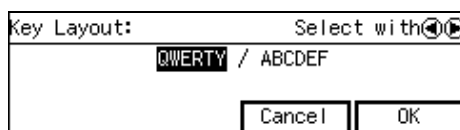

ZGSS250N

### 6 Press [OK].

### 7 Press [PrevMenu] twice.

### 8 Press [Exit] to return to the standby mode.

## Print Position

If image positioning needs to be adjusted slightly, adjust the margins for the appropriate tray (the main paper tray, the optional Paper Tray Units, or the optional Bypass Tray Unit).

### Note

- You can adjust the top and left margins of paper in 9 increments.
- You can adjust the position of the printed image in 0.5mm (0.02 in.) increments.

**1** Press the **[User Tools]** key.

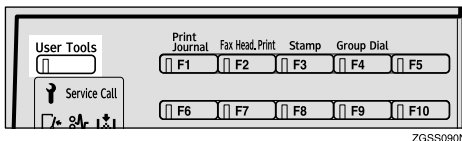

**2** Enter the code for "Key Op. Tools" with the number keys. Then press the **[#]** key.

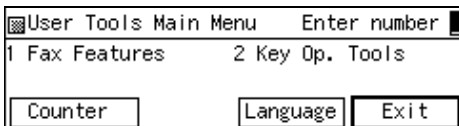

The "Key Op. Tools" main menu appears.

**3** Enter the code for "System Settings" with the number keys.

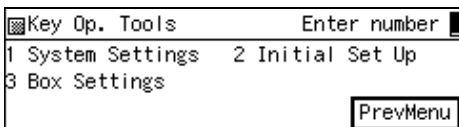

**4** Enter the code for "Print Position" with the number keys.

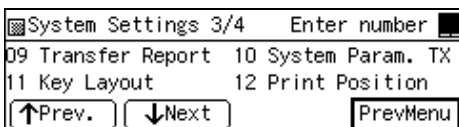

### Note

- If "Print Position" is not displayed, press **[↑Prev.]** or **[↓Next]** until it is.

**5** Enter the code for the tray you wish to adjust the margins for with the number keys.

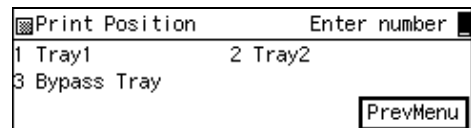

### Note

- The main paper tray is displayed as "Tray1", the optional Paper Tray Units as "Tray2-5", and the optional Bypass Tray Unit as "Bypass Tray".

**6** Enter the code for the margin you wish to adjust with the number keys.

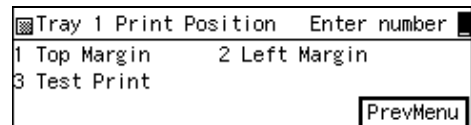

### Note

- You can view the margins by entering the code for "Test Print", then pressing the **[Start]** key.

**7** Press **[Left Arrow]** or **[Right Arrow]** key to adjust the margin.

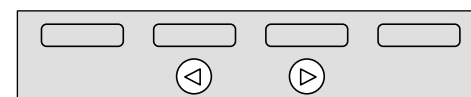
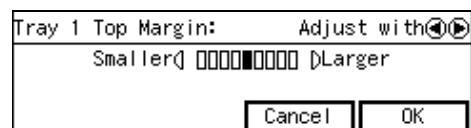

ZGSS250N

**8** Press [OK].

The margins are set.

**Note**

- If you wish to adjust another margin for the same tray, repeat the procedure from step **6**.
- If you wish to adjust a margin for another tray, press [Prev-Menu], then repeat the procedure from step **6**.

**9** Press [PrevMenu] four times.**10** Press [Exit] to return to the stand-by mode.**Note**

- The printed image may not be complete if the margins are excessively increased or decreased depending on the received fax. It is recommended that you check the printed image by printing a sample document when make adjustments.

## Memory File Transfer

The Memory File Transfer function enables you to send all messages currently stored in memory to another fax and have them printed out there, if your machine cannot print because the toner or paper has run out. You need to specify the forwarding destination when using this function.

Note that all files stored in memory including Memory-locked messages are transferred when this function is activated. Use this function only in an emergency.

**Note**

- You cannot specify an e-mail address (NIC FAX Unit (Option for Type1) required) as the forwarding destination.
- The Fax Header is not added to the transferred messages.
- All messages are sent in a single transmission. The Confidential Messages and Memory-locked Messages as well as Auto Documents are transferred and printed at the specified destination.
- All documents are not erased from memory regardless of whether forwarding was successful or not.
- Even if a transmission error occurs, messages are not resent.
- Details of the forwarding operation are not printed in the Journal.

**Reference**

p.98 "Entering Characters", <Basic Features>

p.123 "CIL Print"

p.46 "Printing a Confidential Message"

p.48 "Printing a Memory-locked Message"

p.99 "Auto Document"

- 1** Press the **[User Tools]** key.

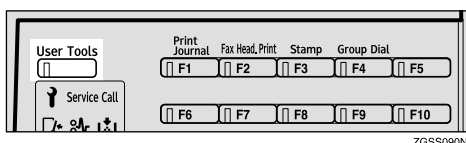

- 2** Enter the code for "Key Op. Tools" with the number keys. Then press the **[#]** key.

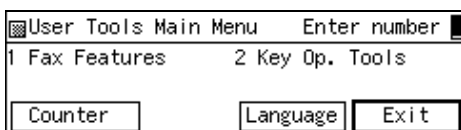

The "Key Op. Tools" main menu appears.

- 3** Enter the code for "System Settings" with the number keys.

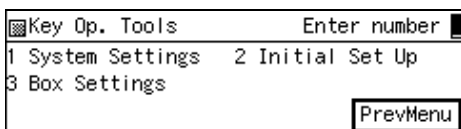

- 4** Enter the code for "Mem. File Transf" with the number keys.

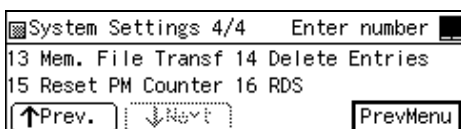

**Note**

- If "Mem. File Transf" is not displayed, press **[↑Prev.]** or **[↓Next]** until it is.
- If no messages are stored in memory, the following message will appear. "No matching file found."

- 5** Enter the number of the fax machine you wish to send to.

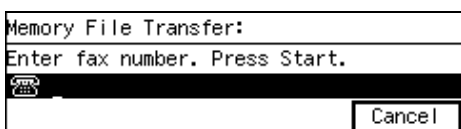

- 6** Press the **[Start]** key.

The transmission to the specified destination begins.

When the transmission has finished, the machine returns to the standby mode.

## Deleting Entries

This feature allows you to delete a group of data stored in the machine such as ID codes or Quick Dials at once. It is a handy tool when you are moving to an office in another location or disposing of the machine. The types of data that you can delete by using this function are listed in the table below.

Item	Data type that you can delete	List that is printed if any part of the data cannot be deleted
Registered ID Code	Own Name, Fax Header, Own Fax Number, destinations for Backup File Transmission, all data stored in the following functions: ID Code Registration, G3 Analog Line, G3 Digital Line, G4 Digital Line	p.189 "Printing the User Parameter List"
Quick Dial	Quick Dial keys that are not specified in the settings for Group, Program, Box or Auto Document	p.149 "Reports/Lists"
Speed Dial	Speed Dials that are not specified in the settings for Group, Program or Box	p.149 "Reports/Lists"
Group Dial	Group Dials that are not specified in the settings for Program or Box	p.149 "Reports/Lists"
Box	Boxes that do not store any received documents	p.259 "Printing the Box List"
Programming	Any programs	p.149 "Reports/Lists"
Image Data	Files stored for the Polling Transmission, Auto Document, Fax On Demand or Information Boxes features	p.43 "Printing a List of Files in Memory (Print TX File List)"

### Note

- ❑ If any part of the data cannot be deleted because it is specified to be transmitted with files stored in memory, the message "Some entries are also programmed in other lists. They could not be deleted." appears and the list of data is printed.

### Deleting Entries

To delete entries, perform the following procedure.

Example: When deleting all ID codes

### 1 Press the [User Tools] key.

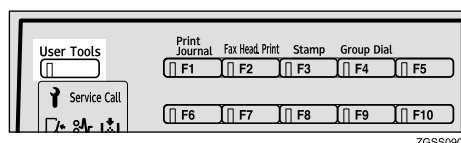

- 2** Enter the code for "Key Op. Tools" with the number keys. Then press the [#] key.

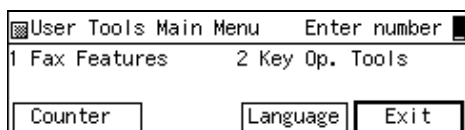

The "Key Op. Tools" main menu appears.

- 3** Enter the code for "System Settings" with the number keys.

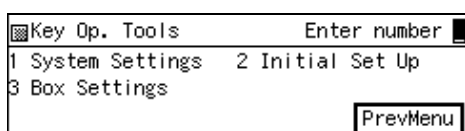

- 4** Enter the code for "Delete Entries" with the number keys.

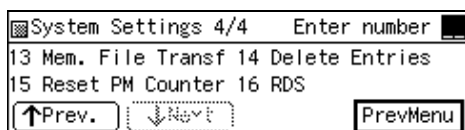

**Note**

- If "Delete Entries" is not displayed, press [Prev.] or [Next] until it is displayed.

- 5** Enter the code for "All IDs" with the number keys.

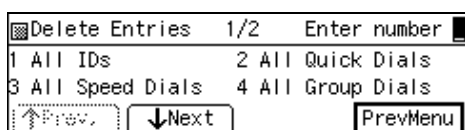

**Note**

- If "All IDs" is not displayed, press [Prev.] or [Next] until it is displayed.

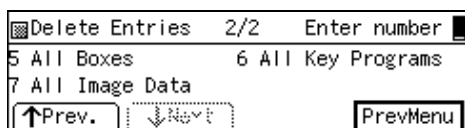

- 6** Press [Yes].

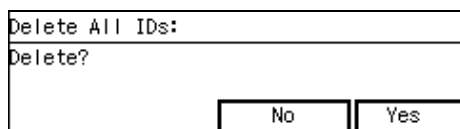

- 7** Press [Yes] to confirm the deletion.

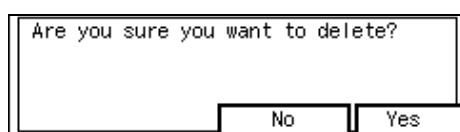

All IDs stored in the machine's memory are deleted.

**Note**

- If you press [No], the deletion is cancelled and the display in step 5 reappears.
- To continue deleting other entries, start the procedure from step 5.

- 8** Press [PrevMenu] three times.

- 9** Press [Exit] to return to the standby mode.

## Reset PM Counter

Follow the procedure described below to clear the counters that count the sheets of documents and printed paper when replacing the ADF Maintenance Kit or Fusing Maintenance Unit.

If the counters are not cleared, it is not possible to notify the right time for the next replacement. Make sure to clear the counters.

### ❖ When replacing the ADF Maintenance Kit

Clear the ADF roller counter. See the Replacing Instructions that come with the ADF Maintenance Kit.

### ❖ When replacing the Fusing Maintenance Unit

Clear the fusing unit counter and the transfer roller counter (clearing one counter will automatically clear the other).

See the Replacing Instructions that come with the Fusing Maintenance Unit.

### 1 Press the [User Tools] key.

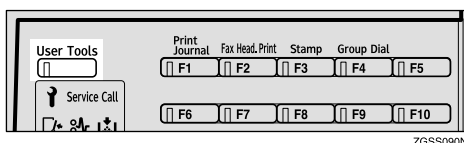

### 2 Enter the code for "Key Op. Tools" with the number keys. Then press the [#] key.

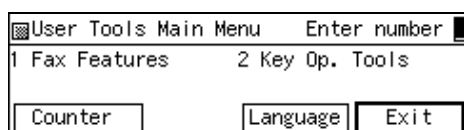

The "Key Op. Tools" main menu appears.

### 3 Enter the code for "System Settings" with the number keys.

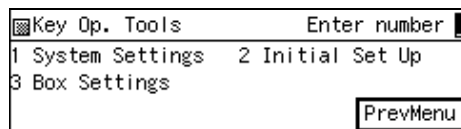

### 4 Enter the code for "Reset PM Counter" with the number keys.

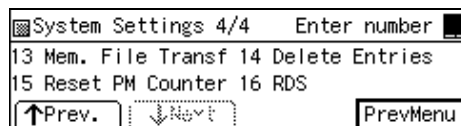

### Note

- If "Reset PM Counter" is not displayed, press [↑Prev.] or [↓Next] until it is.

### 5 Press [↑Prev.] or [↓Next] until the counter you wish to clear is displayed.

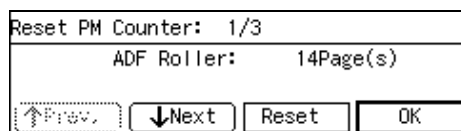

ZGSS230N

### Note

- When changing the ADF Maintenance Kit, clear the ADF roller counter.
- When changing the Fusing Maintenance Unit, clear the fusing unit or transfer roller counter (clearing one counter will automatically clear the other).

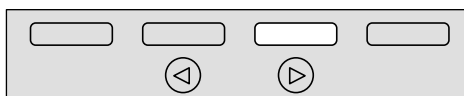
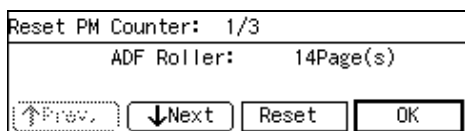
**6** Press [Reset].

ZGSS210N

**Note**

- If you press [OK], the screen in step 4 reappears.

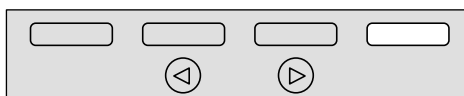
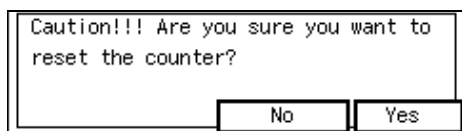
**7** Press [Yes] to clear the counter.

ZGSS220N

**Note**

- If you press [No], the screen in step 6 reappears.

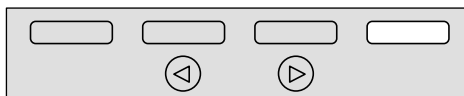
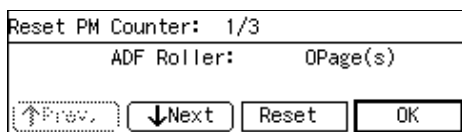
**8** Press [OK].

ZGSS220N

**Note**

- If you wish to clear another counter, press [↑Prev.] or [↓Next] to select the item.

**9** Press [PrevMenu] twice.**10** Press [Exit] to return to the stand-by mode.**RDS (Remote Diagnostic System)**

If your machine has a problem, a service representative can perform various diagnostic tasks over the telephone line from the service station to try to find out what is wrong with your machine. The service representative can also use RDS to change some of your machine's settings, if you request it.

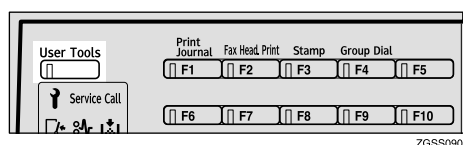
**1** Press the [User Tools] key.

ZGSS090N

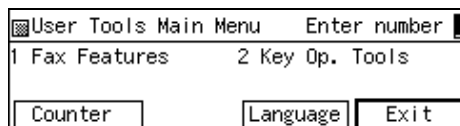
**2** Enter the code for "Key Op. Tools" with the number keys. Then press the [#] key.

The "Key Op. Tools" main menu appears.

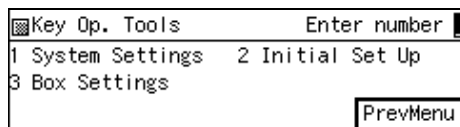
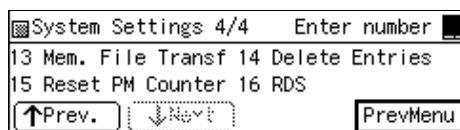
**3** Enter the code for "System Settings" with the number keys.**4** Enter the code for "RDS" with the number keys.**Note**

- If "RDS" is not displayed, press [↑Prev.] or [↓Next] until it is.



- 5** Press ◀ or ▶ key to turn this function on or off.

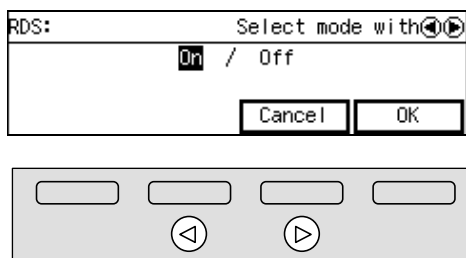

- 6** Press [OK].

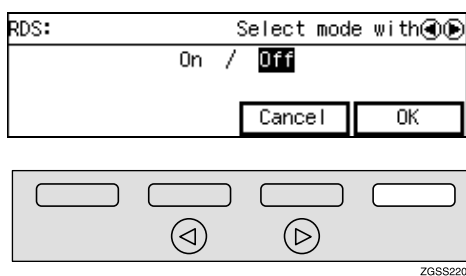

- 7** Press [PrevMenu] twice.

- 8** Press [Exit] to return to the stand-by mode.

# Initial Set Up

## Multi-copy Reception

Use this feature to have the machine print multiple copies of messages from Specified Senders. If no Specified Senders are registered, the machine prints multiple copies of all messages, regardless of sender.

### Note

- ❑ It is recommended that you print the Specified Sender List and keep it after registering or editing settings for this function. See p.217 "Printing the Specified Sender List".
- ❑ Multiple copies cannot be made of messages received using Polling Reception and Free Polling Reception, as well as Confidential Messages and Memory-locked Messages.
- ❑ You can specify the number of copies from 1 to 9.
- ❑ You can choose to print a specified number of copies of messages from Specified Senders, or to print specified number of copies of messages from senders other than Specified Senders with User Parameters. See p.178 "User Parameters"(switch 08 bits 1,0).
- ❑ You can register the Specified Senders for the following six functions: Multi-copy Reception, Authorized Reception, Specified Tray, Forwarding, Memory Lock, TX/RX File Save. The maximum number of Specified Senders is 50 in total.

- ❑ You can use up to 20 characters when registering one item of Specified Senders for the G3 communication, and 24 characters for the G4 communication. You can also specify wildcards. See p.98 "Entering Characters", <Basic Features>.
- ❑ If the Specified Sender's fax machine is of the same make as your machine, register the sender's name registered to their machine. If the Specified Sender's fax machine is of a different make, register the fax number. See p.55 "Own Name/Fax Header/Own Fax Number", <Basic Features>.
- ❑ You can check the sender's name or sender's fax number registered to the fax machines of Specified Senders on the Journal. See p.50 "Printing the Journal".
- ❑ You can change the current setting by following the same procedure for making a new setting. Change the values of settings according to your needs.

## Setting up Multi-copy Reception

- 1 Press the **[User Tools]** key.

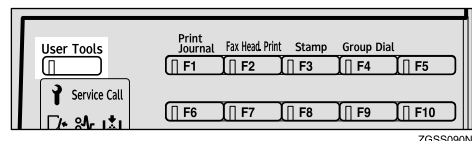

- 2** Enter the code for "Key Op. Tools" with the number keys then press the **[#]** key.

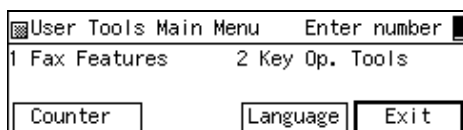

The "Key Op. Tools" main menu appears.

- 3** Enter the code for "Initial Set Up" with the number keys.

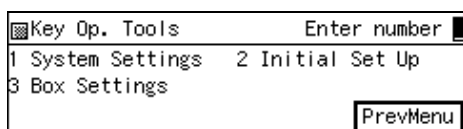

The "Initial Set Up" menu appears.

- 4** Enter the code for "Multi-copy Recp." with the number keys.

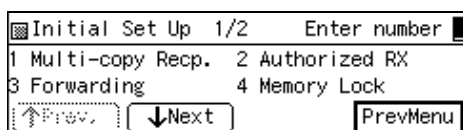

- 5** Press **[Sender]**.

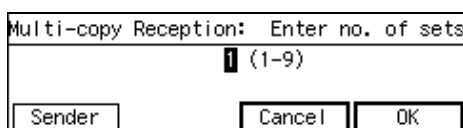

ZGSS190N

**Note**

- If you do not wish to register a Specified Sender, proceed to step 6.
- If there is no registered Specified Senders, multiple copies of all incoming messages are made.

- 6** Enter the code for "Program Sender" with the number keys.

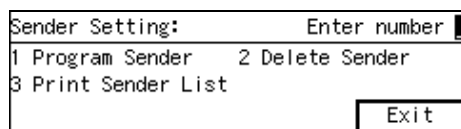

- 7** Enter the 2-digit code of the Specified Sender you wish to register with the number keys.

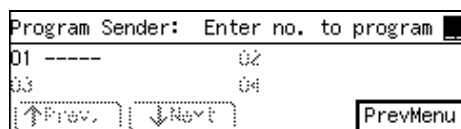

**Note**

- If you enter the first digit of the code incorrectly, press the **[Clear]** key or the **[Stop]** key to clear it and enter the correct code. If you enter the code incorrectly with the two digits, press **[Cancel]** in step 8.

- 8** Press **[Sender]**.

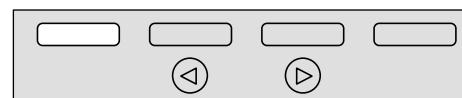
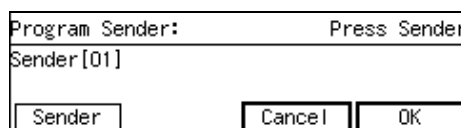

ZGSS190N

- 9** Enter the sender name or sender number of the other party's fax machine you wish to register as a Specified Sender.

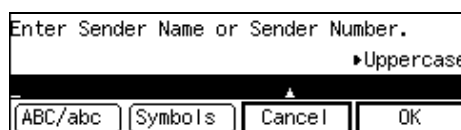

**Note**

- You can use Alphabets, symbols, numbers, or a space when entering the sender name or sender number.

**Reference**

p.98 "Entering Characters",  
<Basic Features>

**10** Press [OK].

**11** Choose whether to store this item as a wildcard.

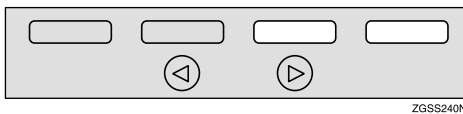
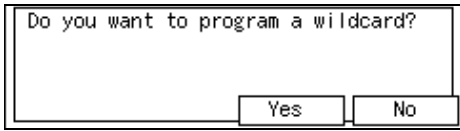

**Reference**

p.98 "Entering Characters",  
<Basic Features>

**12** Press [OK].

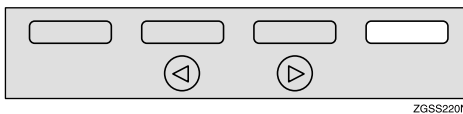
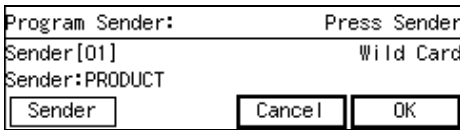

**13** Press [PrevMenu].

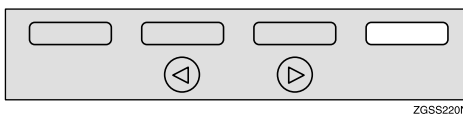
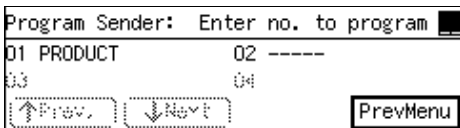

**Note**

- To register another Specified Sender, repeat the procedure from step **7**.

**14** Press [Exit].

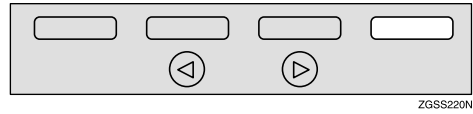
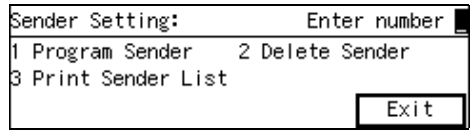

**15** Enter the number of copies to be printed with the number keys.

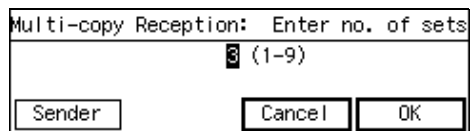

**Note**

- You can specify the number of copies from 1 to 9.
- Multi-copy Reception is activated when the number of copies is set to 2 and above, and inactivated when it is set to 1.

**16** Press [OK].

**17** Press [PrevMenu] twice.

**18** Press [Exit] to return to the stand-by mode.

**Deleting Specified Senders**

You can delete registered Specified Senders as necessary.

**Reference**

p.239 "Deleting Specified Senders".

## Printing the Specified Sender List

You can check the registered Specified Senders by printing out the list of the registered Specified Senders.

### Reference

See p.241 "Printing the Specified Sender List" for the printing procedure.

## Authorized Reception

You can block out unwanted fax messages by registering Specified Senders for Authorized Reception and choosing to receive faxes only from those senders. If a fax machine other than those specified as Specified Senders tries to send you a message, the line is disconnected immediately after the connection is established. This feature is useful, for example, if you wish to block out junk faxes. You can also choose to receive faxes from senders other than those you specify as the Specified Senders.

### Limitation

- If you do not register any Specified Senders, you cannot set up this function.

### Note

- It is recommended that you print the Specified Sender List and keep it after registering or editing settings for this function. See p.217 "Printing the Specified Sender List".
- Authorized Reception is not available for Polling Reception.

- You can choose to receive fax messages from Specified Senders, or from senders other than Specified Senders with User Parameters. See p.178 "User Parameters"(switch 08 bits 3,2).
- You can register the Specified Senders for the following six functions: Multi-copy Reception, Authorized Reception, Specified Tray, Forwarding, Memory Lock, TX/RX File Save. The maximum number of Specified Senders is 50.
- You can use up to 20 characters when registering one item of Specified Senders for the G3 communication, and 24 characters for the G4 communication. You can also specify wildcards. See p.98 "Entering Characters", <Basic Features>.
- If the Specified Sender's fax machine is of the same make as your machine, register the sender's name registered to their machine. If the Specified Sender's fax machine is of a different make, register the fax number.
- You can check the sender's name or sender's fax number registered to the fax machines of Specified Senders on the Journal. See p.50 "Printing the Journal".
- You can change the current setting by following the same procedure for making a new setting. Change the values of settings according to your needs.

## Setting up Authorized Reception

- 1** Press the **[User Tools]** key.

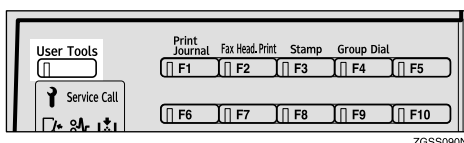

- 2** Enter the code for "Key Op. Tools" with the number keys then press the **[#]** key.

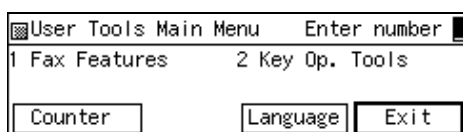

The "Key Op. Tools" main menu appears.

- 3** Enter the code for "Initial Set Up" with the number keys.

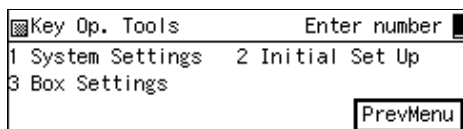

The "Initial Set Up" menu appears.

- 4** Enter the code for "Authorized RX" with the number keys.

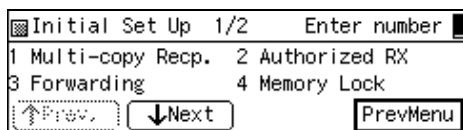

- 5** Press **[Sender]**.

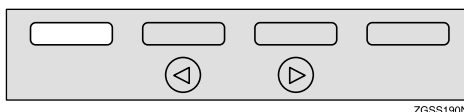
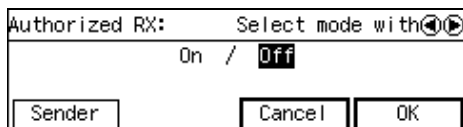

- 6** Enter the code for "Program Sender" with the number keys.

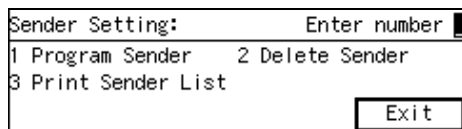

- 7** Enter the 2-digit code of the Specified Sender you wish to register with the number keys.

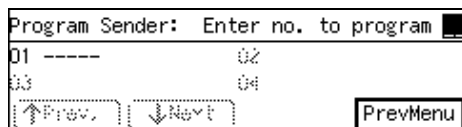

### Note

- If you enter the first digit of the code incorrectly, press the **[Clear]** key or the **[Stop]** key to clear it and enter the correct code. If you enter the code incorrectly with the two digits, press **[Cancel]** in step 8.

- 8** Press **[Sender]**.

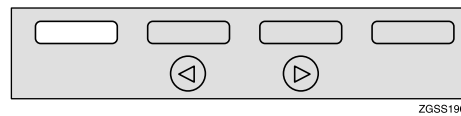
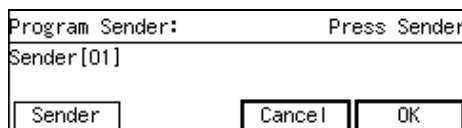

- 9** Enter the sender name or sender number of the other party's fax machine you wish to register as a Specified Sender.

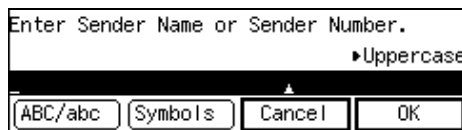

**Note**

- You can use letters, symbols, numbers, or spaces when entering the sender name or sender number.

**Reference**

p.98 "Entering Characters",  
<Basic Features>

**10** Press [OK].

**11** Choose whether to store this item as a wildcard.

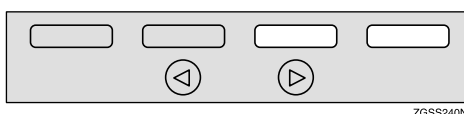
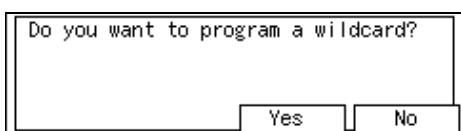

ZGSS240N

**Reference**

p.98 "Entering Characters",  
<Basic Features>

**12** Press [OK].

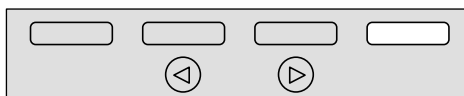
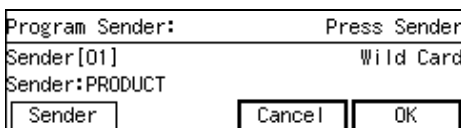

ZGSS220N

**13** Press [PrevMenu].

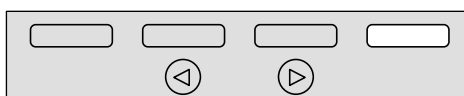
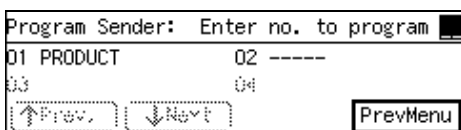

ZGSS220N

**Note**

- To register another Specified Sender, repeat the procedure from step 7.

**14** Press [Exit].

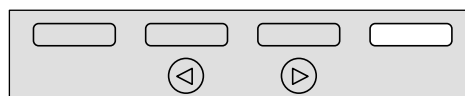
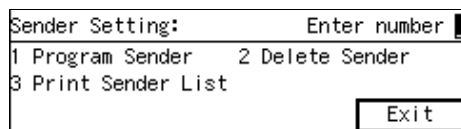

ZGSS220N

**15** Press ◀ or ▶ key to turn this function on or off.

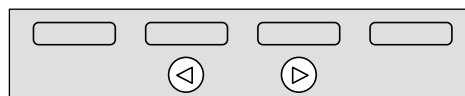
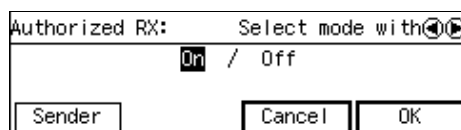

ZGSS250N

**16** Press [OK].

**17** Press [PrevMenu] twice.

**18** Press [Exit] to return to the stand-by mode.

## Deleting Specified Senders

You can delete registered Specified Senders as necessary.

**Reference**

See p.239 "Deleting Specified Senders" for the deleting procedure.

## Printing the Specified Sender List

You can check the registered Specified Senders by printing out the list of the registered Specified Senders.

### Reference

See p.241 "Printing the Specified Sender List" for the printing procedure.

## Specified Tray

*This function requires the optional Paper Supply Unit.*

The Specified Tray function enables you to have messages from Specified Senders printed using one paper tray, and messages from other senders to be printed using another paper tray.

For example, if green paper is set in the main paper tray, and white paper is set in the optional Paper Tray Unit, you can distinguish the senders of the message at a glance by choosing to have messages from Specified Senders printed using the main paper tray and messages from others printed using the optional Paper Tray Unit.

### Note

- It is recommended that you print the Specified Sender List and keep it after registering or editing settings for this function. See p.217 "Printing the Specified Sender List".
- The Specified Tray function is not available for the optional Bypass Tray Unit. You need to have the optional Paper Tray Unit(s). Type1 has two paper tray units as standard.

- The Specified Tray function is not activated when receiving messages with Polling Reception or Free Polling Reception.
- Register the Own Name or Own Fax Number of the other party as the Specified Sender. If the other party has not registered their Own Name or Own Fax Number, you cannot register them as a Specified Sender.
- You can choose to print messages from Specified Senders, or messages from senders other than Specified Senders using the main paper tray with User Parameters. See p.178 "User Parameters"(switch 08 bits 5,4).
- You can register the Specified Senders for the following six functions: Multi-copy Reception, Authorized Reception, Specified Tray, Forwarding, Memory Lock, TX/RX File Save. The maximum number of Specified Senders is 50.
- You can use up to 20 characters when registering one item of Specified Senders for the G3 communication, and 24 characters for the G4 communication. You can also specify wildcards. See p.98 "Entering Characters", <Basic Features>.
- When one optional Paper Tray Unit is installed, load the optional Paper Tray Unit and the main paper tray with paper of the same size. When two optional Paper Tray Units are installed, load the main paper tray with paper of the same width as that of the largest width loaded in the paper supply units.
- If you do not set paper in the way described above, Substitute Reception may take place even if paper is set.



- ❑ If the Specified Sender's fax machine is of the same make as your machine, register the sender's name registered to their machine. If the Specified Sender's fax machine is of a different make, register the fax number.
- ❑ You can check the sender's name or sender's fax number registered to the fax machines of Specified Senders on the Journal. See p.50 "Printing the Journal".
- ❑ You can change the current setting by following the same procedure for making a new setting. Change the values of settings according to your needs.

## Setting up Specified Tray

- 1** Press the **[User Tools]** key.

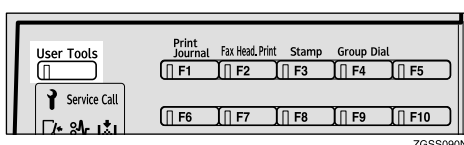

- 2** Enter the code for "Key Op. Tools" with the number keys then press the **[#]** key.

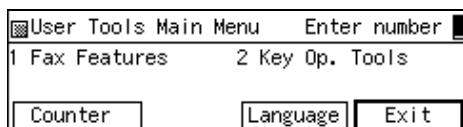

The "Key Op. Tools" main menu appears.

- 3** Enter the code for "Initial Set Up" with the number keys.

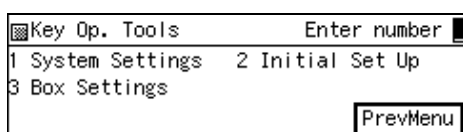

The "Initial Set Up" menu appears.

- 4** Enter the code for "Specified Tray" with the number keys.

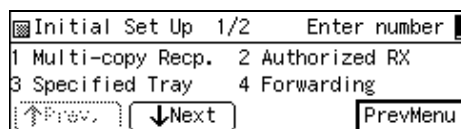

- 5** Press **[Sender]**.

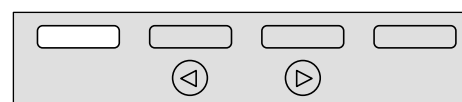
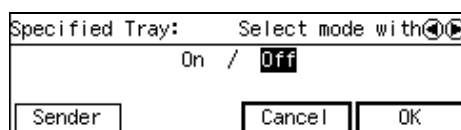

ZGSS190N

### Note

- ❑ If you do not wish to register a Specified Sender, proceed to step 6.
- ❑ If you do not register any Specified Senders, all incoming faxes will be printed using the main paper tray.

- 6** Enter the code for "Program Sender" with the number keys.

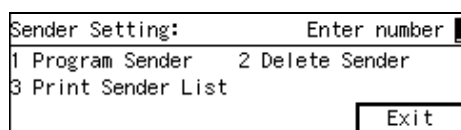

- 7** Enter the 2-digit code of the Specified Sender you wish to register with the number keys.

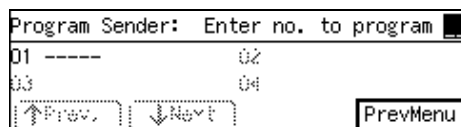

**Note**

- If you enter the first digit of the code incorrectly, press the **[Clear]** key or the **[Stop]** key to clear it and enter the correct code. If you enter the code incorrectly with the two digits, press **[Cancel]** in step 8.

**8** Press **[Sender]**.

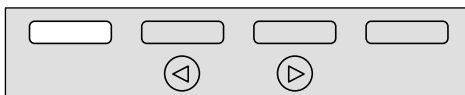
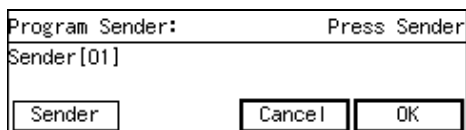

ZGSS190N

**9** Enter the sender name or sender number of the other party's fax machine you wish to register as a Specified Sender.

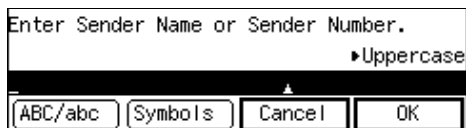

**Note**

- You can use letters, symbols, numbers, or spaces when entering the sender name or sender number.

**Reference**

p.98 "Entering Characters", <Basic Features>

**10** Press **[OK]**.

**11** Choose whether to store this item as a wildcard.

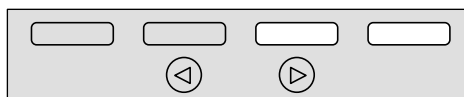
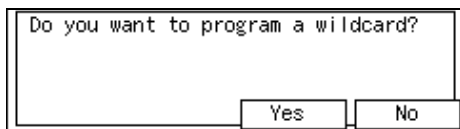

ZGSS240N

**Reference**

p.98 "Entering Characters", <Basic Features>

**12** Press **[OK]**.

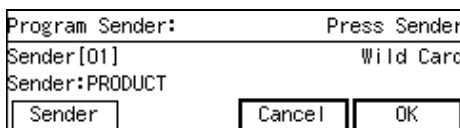

ZGSS220N

**13** Press **[PrevMenu]**.

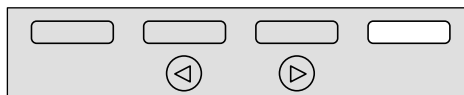
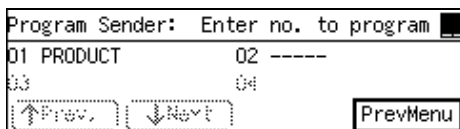

ZGSS220N

**Note**

- To register another Specified Sender, repeat the procedure from step 7.

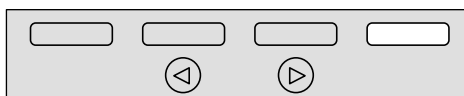
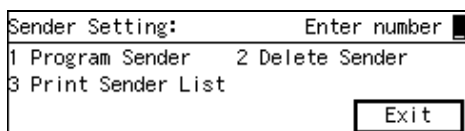
**14** Press [Exit].

ZGSS220N

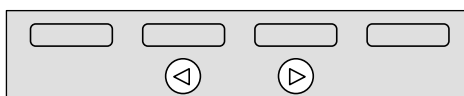
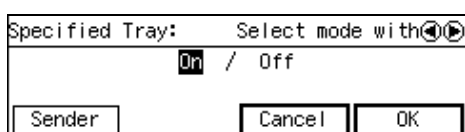
**15** Press ◀ or ▶ key to turn this function on or off.

ZGSS250N

**16** Press [OK].**17** Press [PrevMenu] twice.**18** Press [Exit] to return to the stand-by mode.**Deleting Specified Senders**

You can delete registered Specified Senders as necessary.

**Reference**

See p.239 “Deleting Specified Senders” for the deleting procedure.

**Printing the Specified Sender List**

You can check the registered Specified Senders by printing out the list of the registered Specified Senders.

**Reference**

See p.241 “Printing the Specified Sender List” for the printing procedure.

**Forwarding**

With this feature, messages from Specified Senders are printed then forwarded to a pre-registered destination (Forwarding Address). For example, when you are away on a trip, you can have messages automatically sent to where you are staying.

**Note**

- It is recommended that you print the Specified Sender List and keep it after registering or editing settings for this function. See p.217 “Printing the Specified Sender List”.
- To use the Forwarding function, you need to turn on the function after specifying the Forwarding Address.
- If a sender is specified for both Memory Lock and Forwarding functions and the Memory Lock is turned on, the messages from the sender are not forwarded.
- Messages received with Confidential Reception, Memory Lock, Polling Reception, or Transfer Request are not forwarded.
- Register the Own Name or Own Fax Number of the other party as the Specified Sender. If the other party has not registered their Own Name or Own Fax Number, you cannot register them as a Specified Sender and forwarding is not possible.
- You can choose to forward messages from Specified Senders, or messages from senders other than Specified Senders using the main paper tray with User Parameters. See p.178 “User Parameters”(switch 08 bits 7,6).

- ❑ The messages from the Specified Senders that you registered or messages from the senders other than those you registered are forwarded to the specified addresses. You can choose whether to have these messages forwarded also to the Forwarding Address with no Specified Senders, if there are any, using User Parameters. See p.178 "User Parameters"(switch 09 bit 5).
- ❑ You can choose whether the machine prints out the messages it forwards with User Parameters. See p.178 "User Parameters"(switch 11 bit 6).
- ❑ You can register up to 30 Forwarding Addresses.
- ❑ Each Forwarding Address may be up to 254 digits.
- ❑ You can register up to 10 Specified Senders to each Forwarding Address. The maximum number of Specified Senders is 50, including those registered for Multi-copy Reception, Authorized Reception, Specified Tray, Memory Lock or TX/RX File Save.
- ❑ By programming different Specified Senders to each Forwarding Address, the maximum 50 Specified Senders can be registered.
- ❑ The maximum number of Specified Senders you can register is 50, however, if you program the same Specified Senders to different Forwarding Addresses, up to 300 (30 Forwarding Addresses × 10 Specified Senders per Forwarding Address) of the Specified Senders can be programmed.

- ❑ See the below table for how to count the number of registered Specified Senders:

Forwarding Address 1	Forwarding Address 2	The number of the registered Specified Senders	
Specified Sender A	Specified Sender A	1	Total: 5
Specified Sender B	-	1	
-	Specified Sender C	1	
Specified Sender D	Specified Sender D	1	
Specified Sender F	-	1	
Total: 4	Total: 3		
The total number of the programmed Specified Senders: 7			

- ❑ You can have a forwarding mark stamped on each forwarded documents.
- ❑ You can change the current setting by following the same procedure for making a new setting. Change the values of settings according to your needs.

#### ❖ Forwarding Mark

You can have a mark stamped on documents to indicate that they have been forwarded.

At the forwarding destination this can help distinguish between standard faxes and faxes that have been forwarded.

**Note**

- Turn the Forwarding Mark feature on or off with User Parameters. See p.178 "User Parameters".

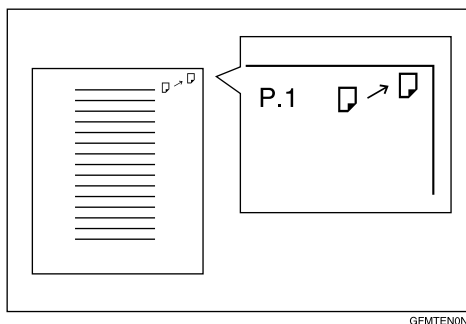

GFMTEN0N

## Setting up Forwarding

- Press the **[User Tools]** key.

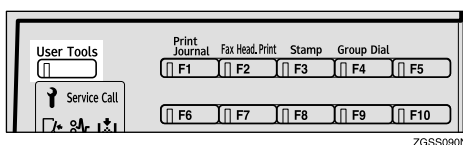

ZGSS090N

- Enter the code for "Key Op. Tools" with the number keys then press the **[#]** key.

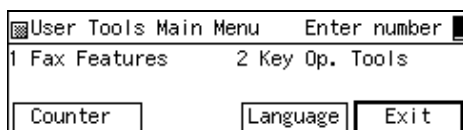

The "Key Op. Tools" main menu appears.

- Enter the code for "Initial Set Up" with the number keys.

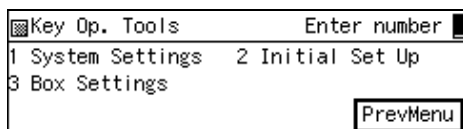

The "Initial Set Up" menu appears.

- Enter the code for "Forwarding" with the number keys.

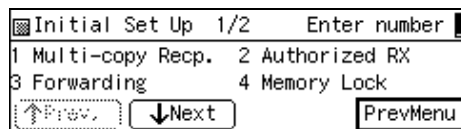

- Press **[Receiver]**.

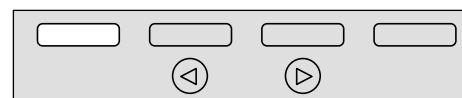
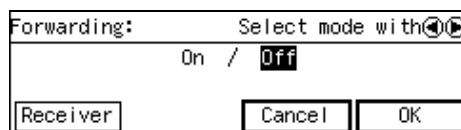

ZGSS190N

- Enter the code for "Prog. Receiver" with the number keys.

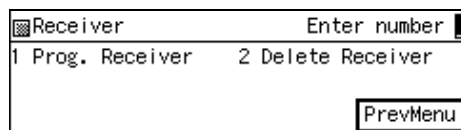

- Enter the item number of the Forwarding Address you wish to register with the number keys.

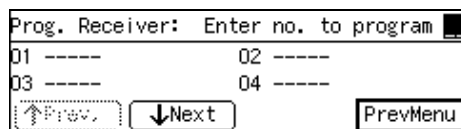
**Note**

- If you enter the number incorrectly, press **[Cancel]** and enter the correct number.
- You can store up to 30 Forwarding Addresses.

- 8** Enter the fax number of the Forwarding Address with the number keys.

**Note**

- If you enter the number incorrectly, press the **[Clear]** key or **[Stop]** key and try again. The **[Clear]** key deletes one character at a time, and the **[Stop]** clears the whole line.
- If the optional ISDN Unit or optional Extra G3 Interface Unit is installed, select the line you wish to use before entering the fax number. See p.89 "Selecting the Line".
- When the NIC FAX Unit (Option for Type1) is installed, you can also enter an e-mail address.

- 9** Press **[Sender]**.

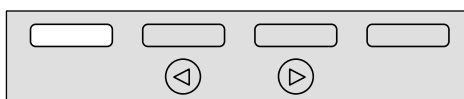

ZGSS190N

**Note**

- If you do not register any Specified Senders, all incoming faxes are forwarded.

- 10** Enter the code for "Program Sender" with the number keys.

- 11** Enter the 2-digit code of the Specified Sender you wish to register with the number keys.

**Note**

- If you enter the first digit of the code incorrectly, press the **[Clear]** key or the **[Stop]** key to clear it and enter the correct code. If you enter the code incorrectly with the two digits, press **[Cancel]** in step 12.

- 12** Press **[Sender]**.



ZGSS190N

- 13** Enter the sender name or sender number of the other party's fax machine you wish to register as a Specified Sender.

**Note**

- You can use letters, symbols, numbers, or spaces when entering the sender name or sender number.

**Reference**

p.98 "Entering Characters",  
<Basic Features>

- 14** Press **[OK]**.

- 15** Choose whether to store this item as a wildcard.

Do you want to program a wildcard?

Yes No

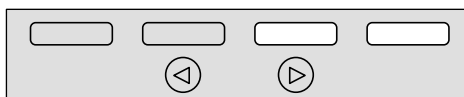

ZGSS240N

### Reference

p.98 "Entering Characters",  
<Basic Features>

- 16** Press [OK].

Program Sender: Press Sender  
Sender [01] Wild Card  
Sender: PRODUCT  
Sender Cancel OK

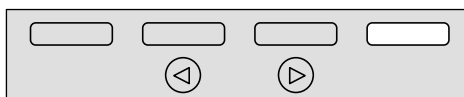

ZGSS220N

- 17** Press [PrevMenu].

Program Sender: Enter no. to program  
01 PRODUCT 02 ----  
03 04  
↑ Prev. ↓ Next PrevMenu



ZGSS220N

### Note

- To register another Specified Sender, repeat the procedure from step 15.

- 18** Press [Exit].

Sender Setting: Enter number  
1 Program Sender 2 Delete Sender  
3 Print Sender List  
Exit

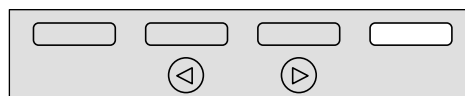

ZGSS220N

- 19** Press [OK].

Prog. Receiver: [01] Enter fax number  
9266047131  
Sender Cancel OK

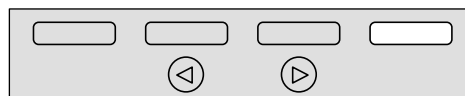

ZGSS220N

- 20** Press [PrevMenu] twice.

- 21** Press ◀ or ▶ key to turn this function on or off.

Forwarding: Select mode with ◀ ▶  
On / Off  
Receiver Cancel OK



ZGSS250N

### Note

- You can choose to forward only messages from Specified Senders, or forward all messages except those from Specified Senders. Adjust this setting with User Parameters. See p.178 "User Parameters" (switch 08 bits 7,6).

- 22** Press [OK].

- 23** Press [PrevMenu] twice.

**24** Press [Exit] to return to the stand-by mode.

### Deleting Forwarding Addresses

**1** Press the [User Tools] key.

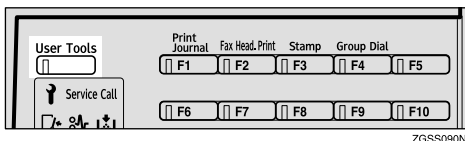

**2** Enter the code for "Key Op. Tools" with the number keys then press the [#] key.

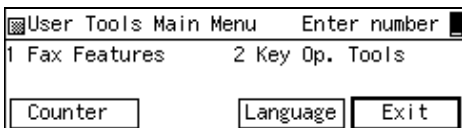

The "Key Op. Tools" main menu appears.

**3** Enter the code for "Initial Set Up" with the number keys.

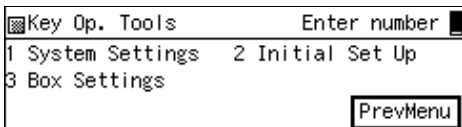

The "Initial Set Up" menu appears.

**4** Enter the code for "Forwarding" with the number keys.

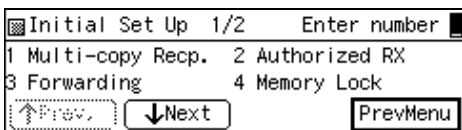

**5** Press [Receiver].

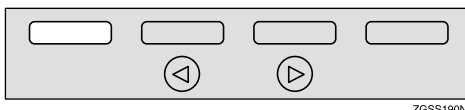
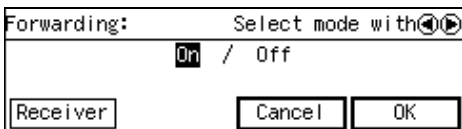

**6** Enter the code for "Delete Receiver" with the number keys.

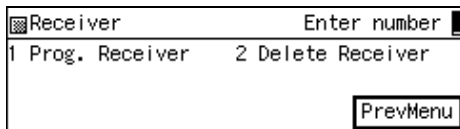

**7** Enter the item number of the Forwarding Address you wish to delete with the number keys.

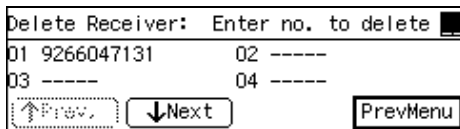

**8** Press [Yes].

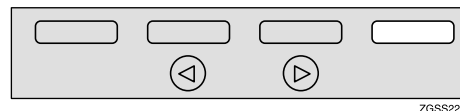
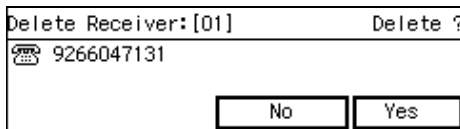

**9** Press [Yes].

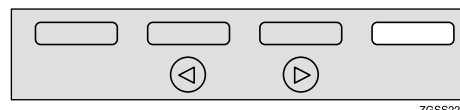
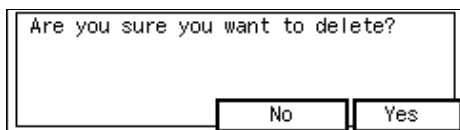

**Note**

❑ If you press [No], the display in step 7 appears again.



- 10** Press [PrevMenu].

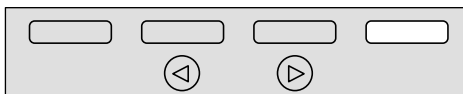
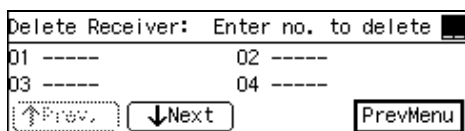

ZGSS220N

- 11** Press [PrevMenu].

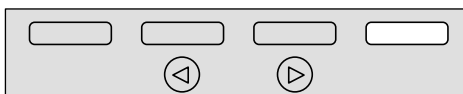
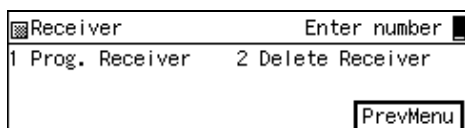

ZGSS220N

- 12** Press [OK].

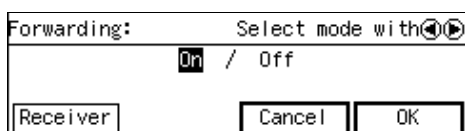

ZGSS220N

### Note

- Select "Off" if you wish to invalidate a setting. If there is no registered Forwarding Address, the setting automatically changes to "Off."

- 13** Press [PrevMenu] twice.

- 14** Press [Exit] to return to the stand-by mode.

## Deleting Specified Senders (Forwarding)

- 1** Press the [User Tools] key.

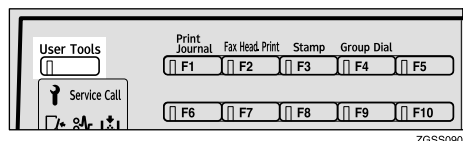

ZGSS090N

- 2** Enter the code for "Key Op. Tools" with the number keys then press the [#] key.

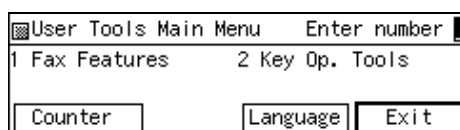

The "Key Op. Tools" main menu appears.

- 3** Enter the code for "Initial Set Up" with the number keys.

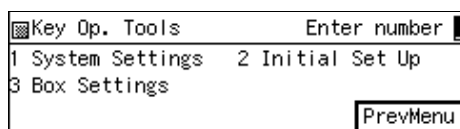

The "Initial Set Up" menu appears.

- 4** Enter the code for "Forwarding" with the number keys.

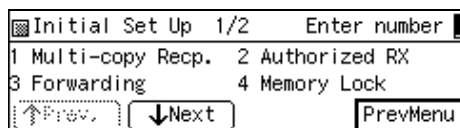

- 5** Press [Receiver].

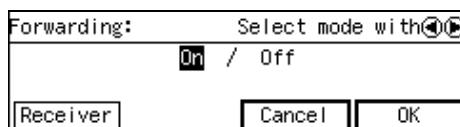

ZGSS190N

7

**6** Enter the code for "Prog. Receiver" with the number keys.

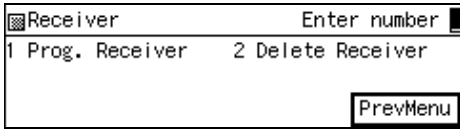

**7** Enter the item number of the Forwarding Address whose Specified Sender you wish to delete with the number keys.

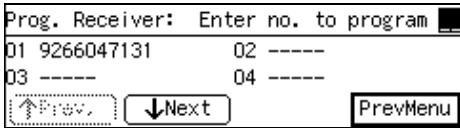

**Note**

- ❑ If you enter the first digit of the code incorrectly, press the **[Clear]** key to clear it and enter the correct code. If you enter the code incorrectly with the two digits, press **[Cancel]** in step **8**.

**8** Press **[Sender]**.

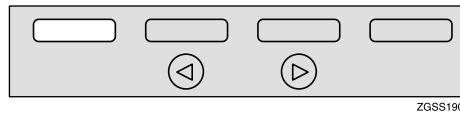
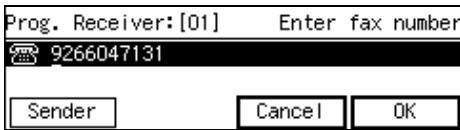

**9** Enter the code for "Delete Sender" with the number keys.

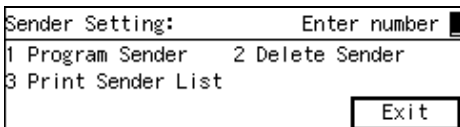

**10** Enter the 2-digit code of the Specified Sender you wish to delete with the number keys.

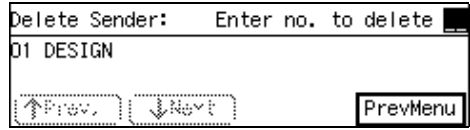

**11** Press **[Yes]**.

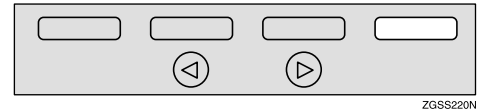
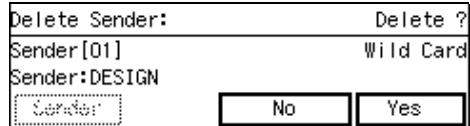

ZGSS220N

**12** Press **[Yes]**.

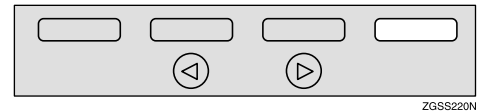
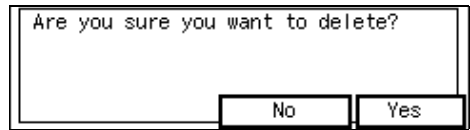

ZGSS220N

**Note**

- ❑ If you press **[No]**, the display in step **10** reappears.

**13** Press **[PrevMenu]**.

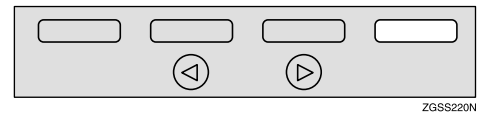
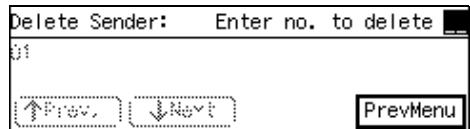

ZGSS220N

**Note**

- ❑ To delete another Specified Sender, repeat the procedure from step **10**.

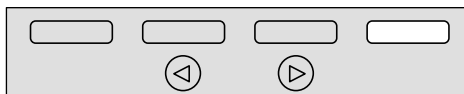
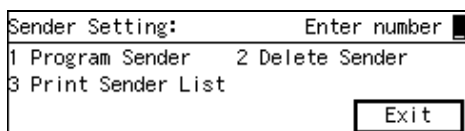
**14** Press [Exit].

ZGSS220N

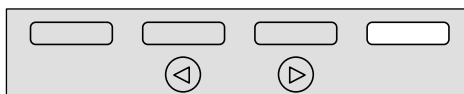
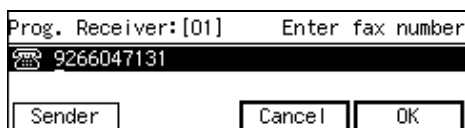
**15** Press [OK].

ZGSS220N

### When No Specified Sender Has Been Registered

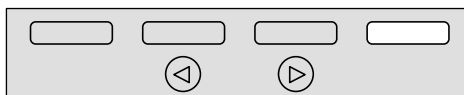
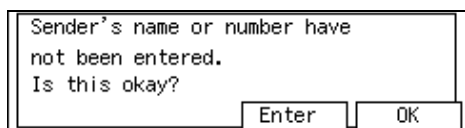
**1** Press [OK].

ZGSS220N

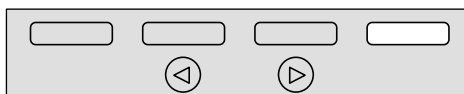
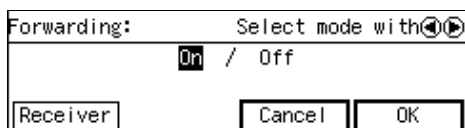
**16** Press [PrevMenu] twice.**17** Press [OK].

ZGSS220N

**Note**

- Select "Off" if you wish to invalidate the setting.

**18** Press [PrevMenu] twice.**19** Press [Exit] to return to the standby mode.

### Printing the Specified Sender List (Forwarding)

You can check which Specified Senders are registered for a Forwarding Address by printing this list.

Follow the steps below to print this list.

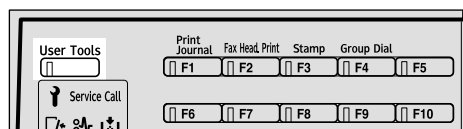
**1** Press the [User Tools] key.

ZGSS090N

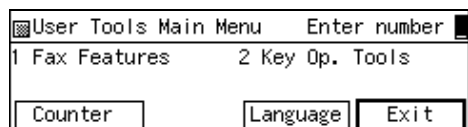
**2** Enter the code for "Key Op. Tools" with the number keys then press the [#] key.

The "Key Op. Tools" main menu appears.

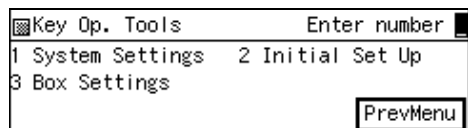
**3** Enter the code for "Initial Set Up" with the number keys.

The "Initial Set Up" menu appears.

- 4** Enter the code for "Forwarding" with the number keys.

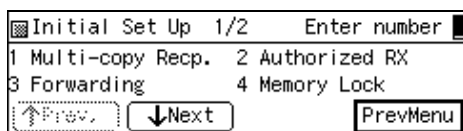

- 5** Press [Receiver].

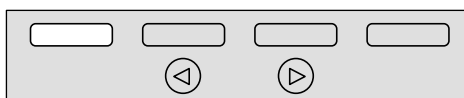
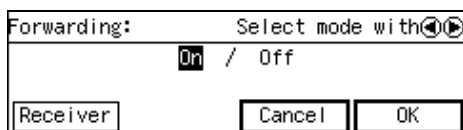

ZGSS190N

- 6** Enter the code for "Prog. Receiver" with the number keys.

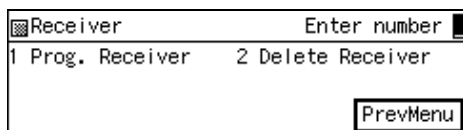

- 7** Enter the item number of the Forwarding Address you wish to print out with the number keys.

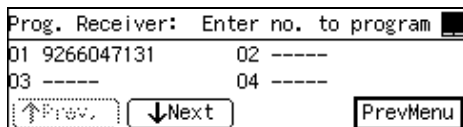

- 8** Press [Sender].

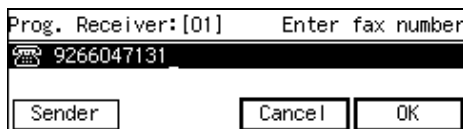

- 9** Enter the code for "Print Sender List" with the number keys.

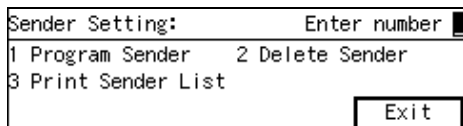

- 10** Press the [Start] key.

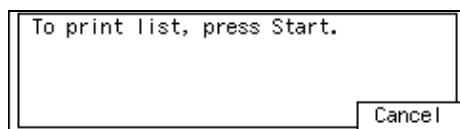

**Note**

- To stop the list being printed, press [Cancel]. The display in step 9 reappears.

- 11** Press [Exit].

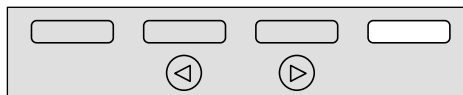
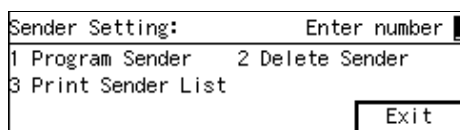

ZGSS220N

- 12** Press [OK].

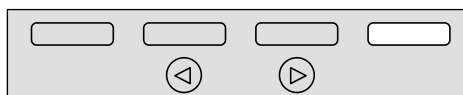
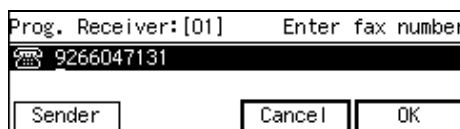

ZGSS220N

- 13** Press [PrevMenu] twice.

- 14** Press [OK].

- 15** Press [PrevMenu] twice.

- 16** Press [Exit] to return to the stand-by mode.

## Memory Lock

You can have messages from Specified Senders stored in memory without printing by using the Memory Lock function. A password is required when printing the Memory-locked messages in order to keep them confidential and private. If you do not register any Specified Senders, all incoming messages are received using Memory Lock.

### Preparation

Be sure to register the Memory Lock ID before using this function. See p.199 "Registering ID Codes".

### Limitation

- Memory Lock is not activated if there is no Memory Lock ID registered.

### Note

- It is recommended that you print the Specified Sender List and keep it after registering or editing settings for this function. See p.217 "Printing the Specified Sender List".
- If a sender is specified for both Memory Lock and Forwarding functions and the Memory Lock is turned on, the messages from the sender are not forwarded.
- You can choose to only lock messages from Specified Senders, or lock all messages except those from Specified Senders with User Parameters. See p.178 "User Parameters" (switch 09 bits 1,0).
- You can register the Specified Senders for the following six functions: Multi-copy Reception, Authorized Reception, Specified Tray, Forwarding, Memory Lock, TX/RX File Save. The maximum number of Specified Senders is 50.
- You can use up to 20 characters when registering one item of Specified Senders for the G3 communication, and 24 characters for the G4 communication. You can also specify wildcards. See p.98 "Entering Characters", <Basic Features>.
- If the Specified Sender's fax machine is of the same make as your machine, register the sender's name registered to their machine. If the Specified Sender's fax machine is of a different make, register the fax number.
- You can print out Memory-locked messages. See p.48 "Printing a Memory-locked Message".
- You can check the sender's name or sender's fax number registered to the fax machines of Specified Senders on the Journal. See p.50 "Printing the Journal".
- You can change the current setting by following the same procedure for making a new setting. Change the values of settings according to your needs.

## Setting up Memory Lock

**1** Press the **[User Tools]** key.

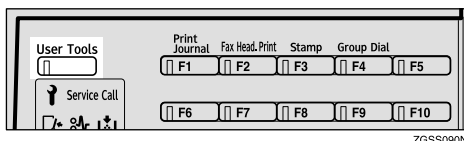

**2** Enter the code for "Key Op. Tools" with the number keys then press the **[#]** key.

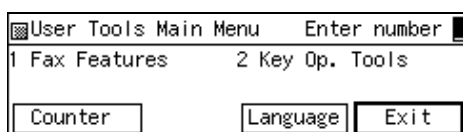

The "Key Op. Tools" main menu appears.

**3** Enter the code for "Initial Set Up" with the number keys.

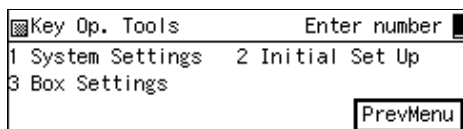

The "Initial Set Up" menu appears.

**4** Enter the code for "Memory Lock" with the number keys.

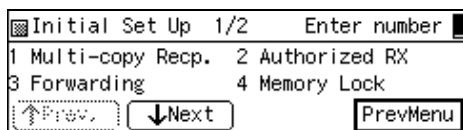

### Note

- If "Memory Lock" is not shown, press **[↑Prev.]** or **[↓Next]** until it is.

**5** Press **[Sender]**

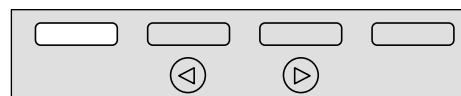
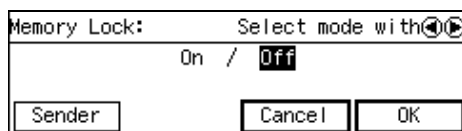

### Note

- If you do not wish to register a Specified Sender, proceed to step **6**.
- If you do not register any Specified Senders, all incoming faxes are locked in memory.

**6** Enter the code for "Program Sender" with the number keys.

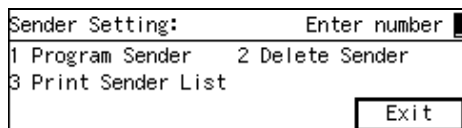

**7** Enter the 2-digit code of the Specified Sender you wish to register with the number keys.

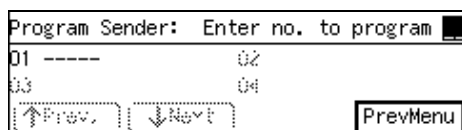

### Note

- If you enter the first digit of the code incorrectly, press the **[Clear]** key or the **[Stop]** key to clear it and enter the correct code. If you enter the code incorrectly with the two digits, press **[Cancel]** in step **3**.

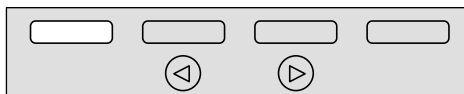
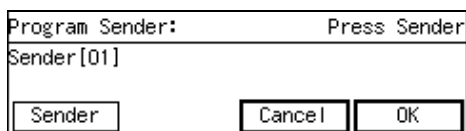
**8** Press [Sender].

ZGSS190N

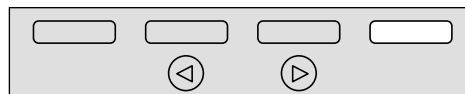
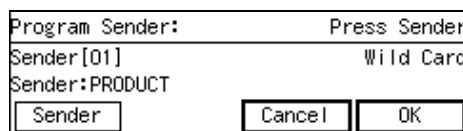
**12** Press [OK].

ZGSS220N

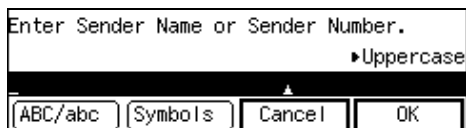
**9** Enter the sender name or sender number of the other party's fax machine you wish to register as a Specified Sender.**Note**

- You can use letters, symbols, numbers, or spaces when entering the sender name or sender number.

**Reference**

p.98 "Entering Characters",  
<Basic Features>

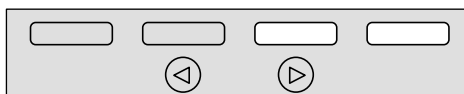
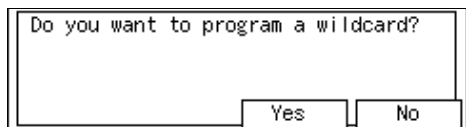
**10** Press [OK].**11** Choose whether to store this item as a wildcard.

ZGSS240N

**Reference**

p.98 "Entering Characters",  
<Basic Features>

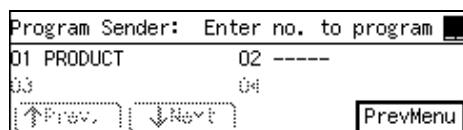
**13** Press [PrevMenu].

ZGSS220N

**Note**

- To register another Specified Sender, repeat the procedure from step **7**.

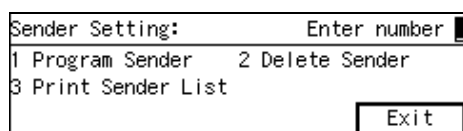
**14** Press [Exit].

ZGSS220N

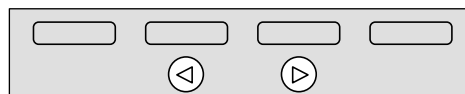
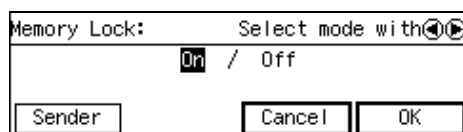
**15** Press **◀** or **▶** key to turn this function on or off.

ZGSS250N

 **Note**

- You can choose to only lock messages from Specified Senders, or lock all messages except those from Specified Senders. Adjust this setting with User Parameters. See p.178 "User Parameters"(switch 09 bits 1, 0).

**16** Press [OK].

**17** Press [PrevMenu] twice.

**18** Press [Exit] to return to the stand-by mode.

---

### Deleting Specified Senders

---

You can delete registered Specified Senders as necessary.

 **Reference**

See p.239 "Deleting Specified Senders" for the deleting procedure.

---

### Printing the Specified Sender List

---

You can check the registered Specified Senders by printing out the list of the registered Specified Senders.

 **Reference**

See p.241 "Printing the Specified Sender List" for the printing procedure.

---

## TX/RX File Save Settings

---

*This function requires the optional Function Upgrade Unit and Optional 40MB Memory Card.*

Use this function to have messages from Specified Senders received using the TX/RX File Save function. If you do not register any Specified Senders, all messages will be received using the TX/RX File Save function.

 **Note**

- It is recommended that you print the Specified Sender List and keep it after registering or editing settings for this function. See p.217 "Printing the Specified Sender List".
- Register the Own Name or Own Fax Number of the other party as the Specified Sender. If the other party has not registered their Own Name or Own Fax Number, you cannot register them as a Specified Sender.
- You can choose to save only messages from Specified Senders, or save all messages except those from Specified Senders with User Parameters. See p.178 "User Parameters" (switch 09 bits 3,2).
- You can register the Specified Senders for the following six functions: Multi-copy Reception, Authorized Reception, Specified Tray, Forwarding, Memory Lock, TX/RX File Save. The maximum number of Specified Senders is 50.



- ❑ You can use up to 20 characters when registering one item of Specified Senders for the G3 communication, and 24 characters for the G4 communication. You can also specify wildcards. See p.98 "Entering Characters", <Basic Features>.
- ❑ If the Specified Sender's fax machine is of the same make as your machine, register the sender's name registered to their machine. If the Specified Sender's fax machine is of a different make, register the fax number.
- ❑ You can check the sender's name or sender's fax number registered to the fax machines of Specified Senders on the Journal. See p.50 "Printing the Journal".
- ❑ You can change the current setting by following the same procedure for making a new setting. Change the values of settings according to your needs.

## Reference

p.58 "TX/RX File Save"

## Setting up TX/RX File Save

- 1** Press the **[User Tools]** key.

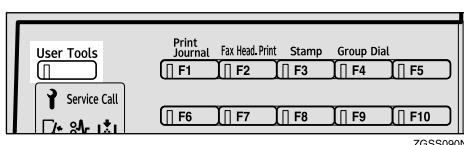

- 2** Enter the code for "Key Op. Tools" with the number keys then press the **[#]** key.

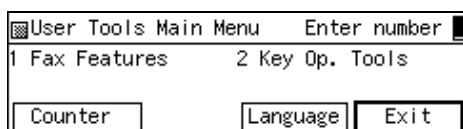

The "Key Op. Tools" main menu appears.

- 3** Enter the code for "Initial Set Up" with the number keys.

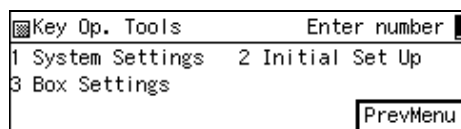

The "Initial Set Up" menu appears.

- 4** Enter the code for "TX/RX File Save" with the number keys.

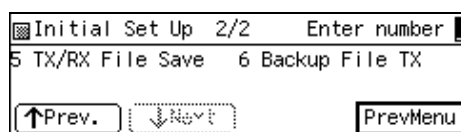

## Note

- ❑ If "TX/RX File Save" is not shown, press **[↑Prev.]** or **[↓Next]** until it is.

- 5** Press **[Sender]**.

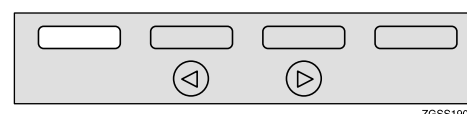
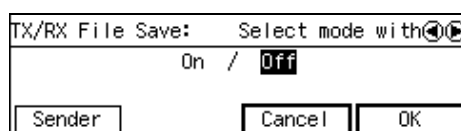

ZGSS190N

## Note

- ❑ If you do not wish to register a Specified Sender, proceed to step 6.
- ❑ If you do not register any Specified Senders, all incoming faxes are received using TX/RX File Save.

- 6** Enter the code for "Program Sender" with the number keys.

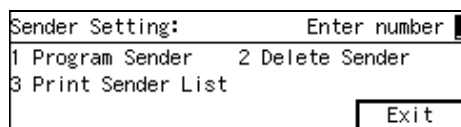

**7** Enter the 2-digit code of the Specified Sender you wish to register with the number keys.

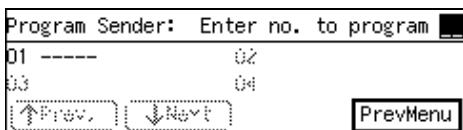

**Note**

- ❑ If you enter the first digit of the code incorrectly, press the **[Clear]** key to clear it and enter the correct code. If you enter the code incorrectly with the two digits, press **[Cancel]** in step **8**.

**8** Press **[Sender]**.

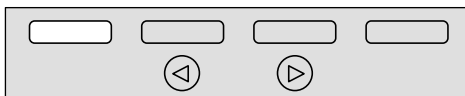
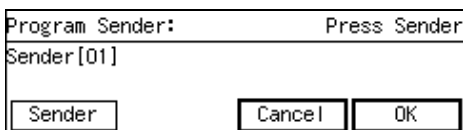

ZGSS190N

**9** Enter the sender name or sender number of the other party's fax machine you wish to register as a Specified Sender.

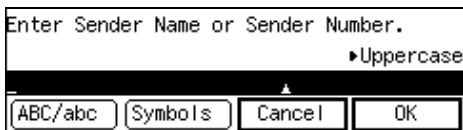

**Reference**

p.98 "Entering Characters", <Basic Features>

**10** Press **[OK]**.

**11** Choose whether to store this item as a wildcard.

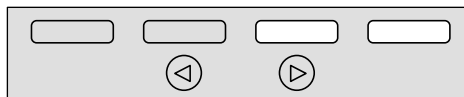
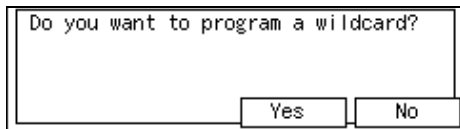

ZGSS240N

**Reference**

p.98 "Entering Characters", <Basic Features>

**12** Press **[OK]**.

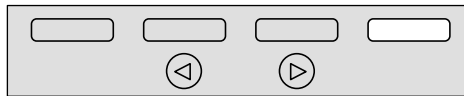
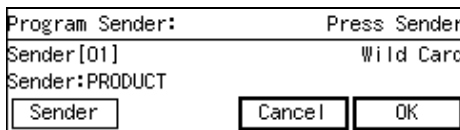

ZGSS220N

**13** Press **[PrevMenu]**.

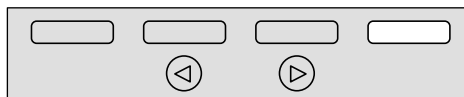
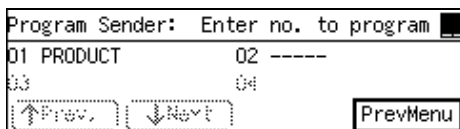

ZGSS220N

**Note**

- ❑ To register another Specified Sender, repeat the procedure from step **7**.

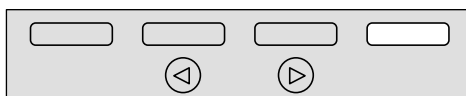
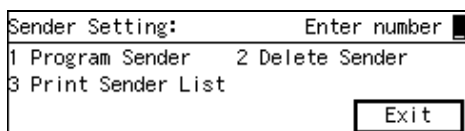
**14** Press [Exit].

ZGSS220N

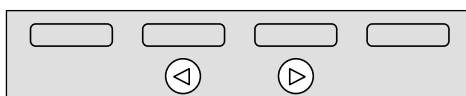
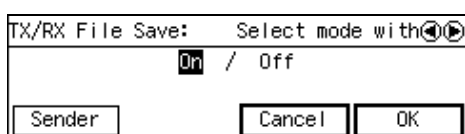
**15** Press ◀ or ▶ key to turn this function on or off.

ZGSS250N

**Note**

- You can choose to save only messages from Specified Senders, or save all messages except those from Specified Senders. Adjust this setting with User Parameters. See p.178 "User Parameters"(switch 09 bits 3, 2).

**16** Press [OK].**17** Press [PrevMenu] twice.**18** Press [Exit] to return to the stand-by mode.**Deleting Specified Senders**

You can delete registered Specified Senders as necessary.

**Reference**

See p.239 "Deleting Specified Senders" for the deleting procedure.

**Printing the Specified Sender List**

You can check the registered Specified Senders by printing out the list of the registered Specified Senders.

**Reference**

See p.241 "Printing the Specified Sender List" for the printing procedure.

**Deleting Specified Senders**

Use this procedure to delete Specified Senders for the following features:

**Reference**

- p.214 "Multi-copy Reception"
- p.217 "Authorized Reception"
- p.220 "Specified Tray"
- p.223 "Forwarding"
- p.233 "Memory Lock"
- p.236 "TX/RX File Save Settings"

**How to Delete Specified Senders****Note**

- For information about how to delete Specified Senders for the Forwarding function, see p.229 "Deleting Specified Senders (Forwarding)".

The example below describes how to delete Specified Senders for the Multi-copy Reception feature. The procedure for other functions is identical except for steps **5** and **10**.

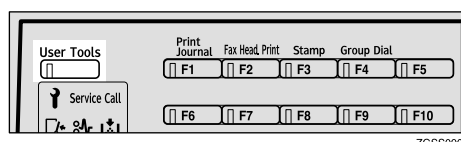
**1** Press the [User Tools] key.

ZGSS090N

**2** Enter the code for "Key Op. Tools" with the number keys then press the **[#]** key.

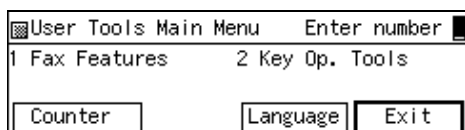

The "Key Op. Tools" main menu appears.

**3** Enter the code for "Initial Set Up" with the number keys.

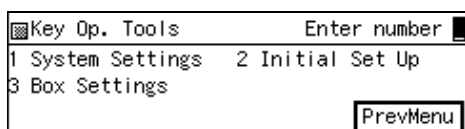

The "Initial Set Up" menu appears.

**4** Enter the code for "Multi-copy Recp." with the number keys.

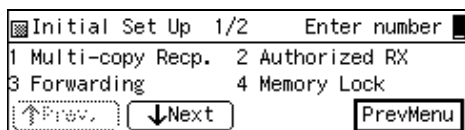

**5** Press **[Sender]**.

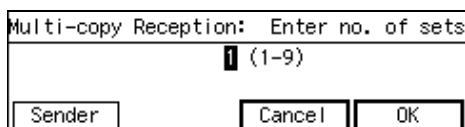

ZGSS190N

**6** Enter the code for "Delete Sender" with the number keys.

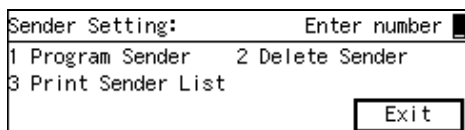

**7** Enter the 2-digit code of the Specified Sender you wish to delete with the number keys.

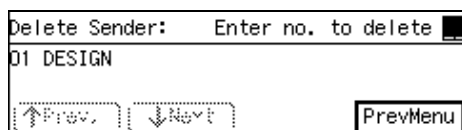

**Note**

- ❑ If you enter the code incorrectly, press the **[Clear]** key and try again.

**8** Press **[Yes]**.

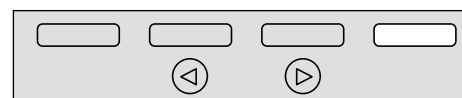
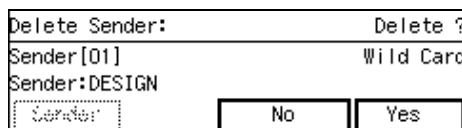

ZGSS220N

**9** Press **[Yes]**.

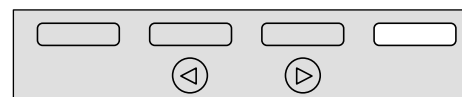
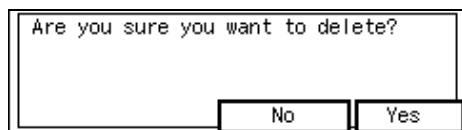

ZGSS220N

**Note**

- ❑ If you press **[No]**, the display in step **7** reappears.

**10** Press **[PrevMenu]**.

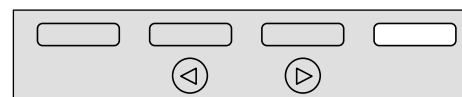
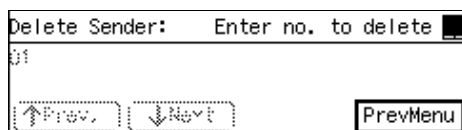

ZGSS220N

**Note**

- To delete another Specified Sender, repeat the procedure from step 7.

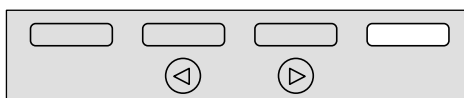
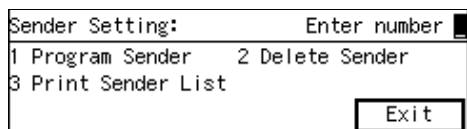
**11** Press [Exit].

ZGSS220N

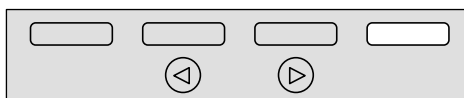
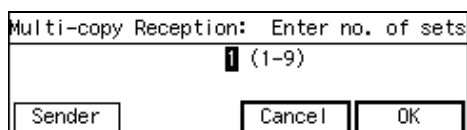
**12** Press [OK].

ZGSS220N

**Note**

- Enter "1" if you wish to invalidate the setting.

**13** Press [PrevMenu] twice.**14** Press [Exit] to return the standby mode.

## Printing the Specified Sender List

Follow the steps below to print a single-page list of Specified Senders registered for each of the following features:

**Reference**

- p.214 "Multi-copy Reception"
- p.217 "Authorized Reception"
- p.220 "Specified Tray"
- p.223 "Forwarding"
- p.233 "Memory Lock"
- p.236 "TX/RX File Save Settings"

## How to Print Specified Sender List

**Note**

- For information about how to print Specified Sender List for the Forwarding function, see p.231 "Printing the Specified Sender List (Forwarding)".

The example below describes how to print Specified Senders List for the Multi-copy Reception feature. The procedure for other functions is identical except for steps 5 and 9.

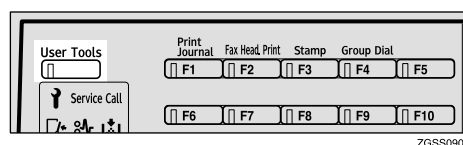
**1** Press the [User Tools] key.

ZGSS090N

- 2** Enter the code for "Key Op. Tools" with the number keys then press the **[#]** key.

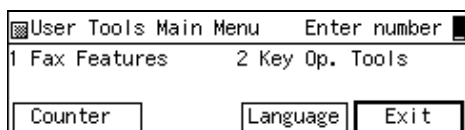

The "Key Op. Tools" main menu appears.

- 3** Enter the code for "Initial Set Up" with the number keys.

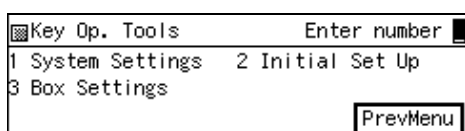

The "Initial Set Up" menu appears.

- 4** Enter the code for "Multi-copy Recp." with the number keys.

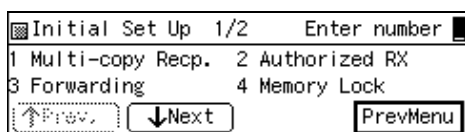

- 5** Press **[Sender]**.

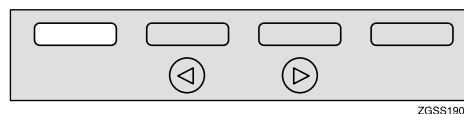
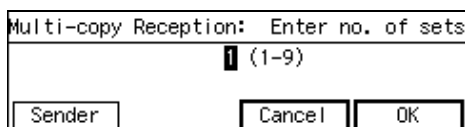

- 6** Enter the code for "Print Sender List" with the number keys.

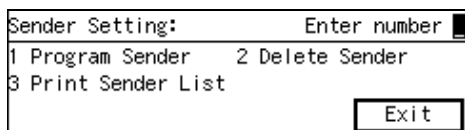

- 7** Press the **[Start]** key.

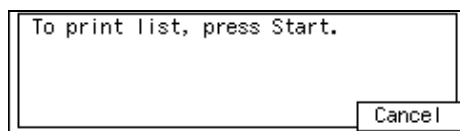

**Note**

- To cancel printing, press **[Cancel]**. The display in step **6** reappears.

- 8** Press **[Exit]**.

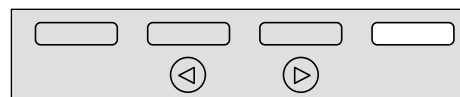
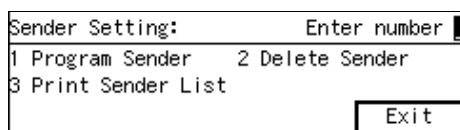

ZGSS220N

- 9** Press **[OK]**.

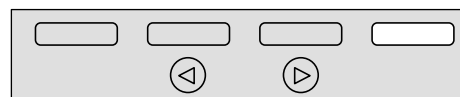
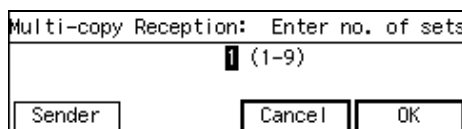

ZGSS220N

- 10** Press **[PrevMenu]** twice.

- 11** Press **[Exit]** to return to the stand-by mode.

## Backup File Transmission Settings

By registering a destination for administrative use, you can automatically have backups made of all sent faxes.

You can register the following items:

- Administrator's Address (2 destinations can be registered).  
Store a single fax number, or an e-mail address (NIC FAX Unit (Option for Type1) required).

- Administrator Name

Backup File Transmission applies to the following features:

- Memory Transmission  
p.34 "Memory Transmission", <Basic Features>
- Transfer Request Transmission  
p.28 "Transfer Request"
- Confidential Transmission  
p.7 "Sending Confidential Messages"
- SUB Code Transmission  
p.13 "SUB Code Transmission with the Mode Key"
- E-mail Transmission (NIC FAX Unit (Option for Type1) required)

### Limitation

- ❑ If memory runs out due to keeping too many standby messages or failed messages, transmission cannot take place.

### Note

- ❑ You cannot register the administrator's address to a Quick Dial key or Speed Dial.
- ❑ Immediate Transmission is not available when Backup File Transmission is turned on.

- ❑ You can check the result of a Backup File Transmission by reading the Memory Communication Result Report (Memory Transmission).

### Reference

p.102 "Backup File Transmission"

### 1 Press the [User Tools] key.

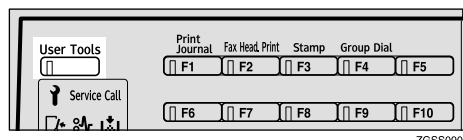

### 2 Enter the code for "Key Op. Tools" with the number keys then press the [#] key.

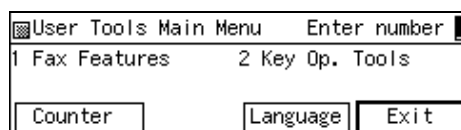

The "Key Op. Tools" main menu appears.

### 3 Enter the code for "Initial Set Up" with the number keys.

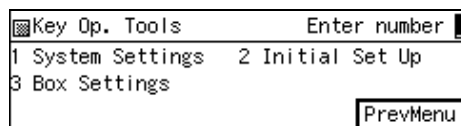

The "Initial Set Up" menu appears.

### 4 Enter the code for "Backup File TX" with the number keys.

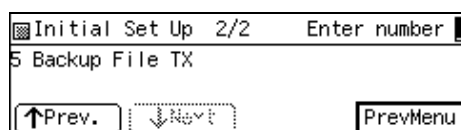

### Note

- ❑ If "Backup File TX" is not shown, press [↑Prev.] or [↓Next] until it is.

**5** Press **◀** or **▶** key to turn this function on or off.

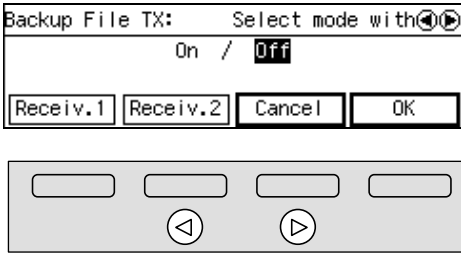

ZGSS250N

**6** Press **[Receiv.1]** or **[Receiv.2]**.

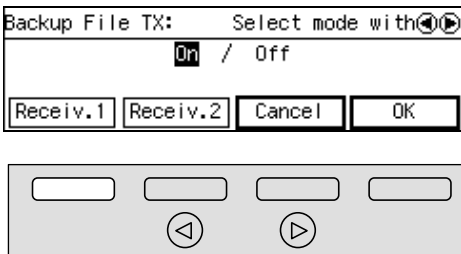

ZGSS190N

**7** Enter the fax number of the back-up destination (Administrator Address).

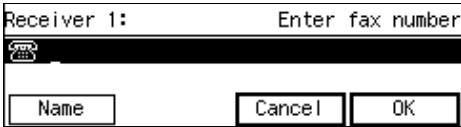

**Note**

❑ If the NIC FAX Unit (Option for Type1) is installed, you can enter an e-mail address by pressing the User Function key (**[F1]** to **[F10]**) which the Internet Fax function is assigned to. See NIC FAX Unit manual.

Registering/Editing the administrator name

**1** Press **[Name]**.

**2** Enter a name for the administrator address.

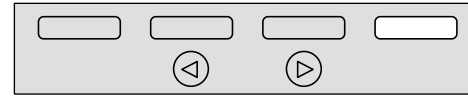
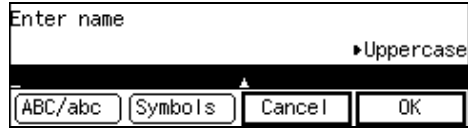

ZGSS220N

**Reference**  
p.98 "Entering Characters", <Basic Features>

**3** Press **[OK]**.

**8** Press **[OK]**.

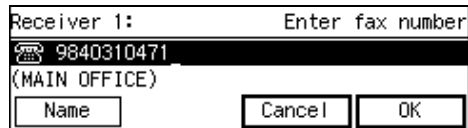

ZGSS220N

**9** Press **[OK]**.

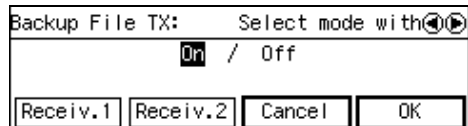

ZGSS220N

**10** Press **[PrevMenu]** twice.

**11** Press **[Exit]** to return to the stand-by mode.



# Box Settings

See the following pages for how to set up and delete Personal Boxes, Information Boxes and Transfer Boxes. This feature provides the following functions:

- ❖ **Registering/Editing Personal Boxes**  
Registering or editing Personal Boxes  
See p.247 "Registering/Editing Personal Boxes".
- ❖ **Deleting Personal Boxes**  
Deleting Personal Boxes  
See p.250 "Deleting Personal Boxes".
- ❖ **Registering/Editing Information Boxes**  
Registering or editing Information Boxes  
See p.251 "Registering/Editing Information Boxes".
- ❖ **Deleting Information Boxes**  
Deleting Information Boxes  
See p.253 "Deleting Information Boxes".
- ❖ **Registering/Editing Transfer Boxes**  
Registering or editing Transfer Boxes  
See p.255 "Registering/Editing Transfer Boxes".
- ❖ **Deleting Transfer Boxes**  
Deleting Transfer Boxes  
See p.258 "Deleting Transfer Boxes".
- ❖ **Printing the Box List**  
Print this list to view the contents of Personal Boxes, Information Boxes, and Transfer Boxes. See p.259 "Printing the Box List".

## Note

- SUB or SEP codes registered in Personal Boxes, Information Boxes or Transfer Boxes cannot be identical.
- If memory runs out, you may not be able to receive messages or register settings. The available memory capacity depends on installed options.
- The combined maximum number of Personal Boxes, Information Boxes, and Transfer Boxes that you can store is 150 (400 when the optional Function Upgrade Unit is installed).
- You can deliver documents in an e-mail format to destinations such as End Receivers by making Box settings with specified Sub-addresses for ISDN. (Optional ISDN Unit and NIC FAX Unit (Option for Type1) required)

## Reference

p.67 "Box File Manager Functions"

## What is the SUB/SEP Code?

The SUB code or SEP code has a similar function to a password. It is a combination of numbers (0 to 9), symbols ("#" and "✖") and spaces. You can use up to 20 characters when registering a SUB/SEP code.

SUB/SEP codes are used when making Box settings so that the users of Boxes may send messages to a Box or retrieve one from a Box by specifying the SUB/SEP code for the Box.

## Personal Boxes

This feature lets you set up the machine so that incoming messages addressed to certain users are stored in memory instead of being printed out immediately. Each user must be assigned a SUB Code (User Code) that has been designated as a Personal Box beforehand. When the other party sends their message, they specify the SUB code of the user they are sending to. When the message is received, it is stored in the Personal Box with the matching SUB Code. In order to print a message received into a Personal Box, you must enter the SUB code assigned to that Personal Box. This enables several individuals or departments to share a single fax machine yet be able to differentiate between messages. Furthermore, if you specify a receiver for the Personal Box, instead of being stored in memory, incoming messages with this SUB code appended are forwarded directly to the destination you specify.

### Note

- ❑ To be able to receive messages into a Personal Box, you must inform the sender of the SUB code registered for that Personal Box, and ask them to send the message using SUB Code Transmission with that SUB code. See p.78 "SUB/SID (SUB Code Transmission)" and p.13 "SUB Code Transmission with the Mode Key".
- ❑ When messages have been received into Personal Boxes, the Confidential Reception/Memory Lock indicator lights and the Confidential File Report is printed. See p.47 "Confidential File Report".
- ❑ If a Personal Box is assigned to a receiver, incoming messages are transferred to that receiver. If a receiver is not assigned, see p.67 "Printing Personal Box Messages" for how to print these messages out.

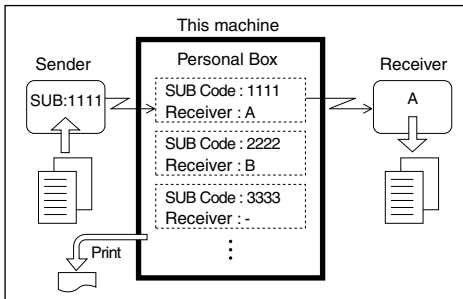

GFSINB0N

## Registering/Editing Personal Boxes

This section describes how to register Personal Boxes.

You can store the following items:

- **SUB Code (required)**  
Up to 20 characters long and can be composed of digits 0-9, "#", "\*" and spaces (the first character cannot be a space).
- **Name (required)**  
Up to 20 characters long.
- **Password (optional)**  
Up to 20 characters long and can be composed of digits 0-9, "#", "\*" and spaces (the first character cannot be a space). By programming the password, no one without the password can print out the received messages in the Personal Box. It is recommended to program the password if you receive confidential messages.
- **Receiver (optional)**  
You can register one delivery destination for each Personal Box. Specify the Quick Dial key or Speed Dial that the delivery destination is stored in.
- **Quick Dial key (optional)**  
If you assign this SUB Code to a Quick Dial key, press this key to enter the associated User Code (Personal Box SUB Code) with a single key press.

### Note

- When using the following functions, you can use SUB codes registered in Personal Boxes in place of User Codes.
  - **Restricted Access**  
See p.25 "Restricted Access", <Basic Features>.

- **User Code Transmission**  
See p.10 "User Code Transmission".
- **Printing the Journal**  
See p.50 "Printing the Journal".
- **Searching By User Code of TX/RX File Save**  
See p.59 "Searching Memory for Sent Faxes" and p.62 "Searching Memory for Received Faxes".
- The Fax Header is not printed on delivered messages. See p.56 "Programming Own Name / Fax Header", <Basic Features>.
- If a message cannot be delivered, a Communication Failure Report is printed and the message is saved as a Confidential Reception document.
- You can specify a Quick Dial key or Speed Dial containing an e-mail address as the receiver when the NIC FAX Unit (Option for Type1) is installed.
- You can edit boxes in the same way as registering them. However, to change the SUB Code itself, you must delete it then register a new SUB Code.

### Reference

p.246 "Personal Boxes"

### 1 Press the [User Tools] key.

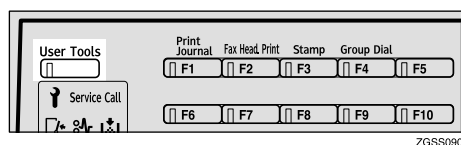

- 2** Enter the code for "Key Op. Tools" with the number keys. Then press the [#] key.

The "Key Op. Tools" main menu appears.

- 3** Enter the code for "Box Settings" with the number keys.

- 4** Enter the code for "Personal Box" with the number keys.

- 5** Enter the SUB Code you wish to register as a Personal Box.

**Note**

- If you enter the code incorrectly, press the [Clear] key or the [Stop] key and try again.

- 6** Press [OK].

**Note**

- If a password is already registered, enter the password, then press [OK].

- 7** Press [Name].

ZGSS190N

- 8** Enter the name of the box.

**Note**

- To change a previously stored name, press the [Clear] key or the [Stop] key, then enter a new one.

**Reference**

p.98 "Entering Characters", <Basic Features>

- 9** Press [OK].

- 10** Press [Others].

ZGSS200N

## Registering a Password (SID)

- 1** Enter the code for "Program Password" with the number keys.

- 2** Enter the password you wish to register.

Program Password:	Enter password
SID	[REDACTED]
[Stop]	Cancel OK

**Note**

- If you incorrectly enter the password, press the **[Clear]** key or the **[Stop]** key, then try again.

- 3** Press **[OK]**.

### Registering a Receiver

- 1** Enter the code for "Program Receiver" with the number keys.

Others:	Enter number
1 Program Password	2 Program Receiver
3 Assign Key	
	Exit

- 2** Specify the Quick Dial key or Speed Dial in which the delivery destination is stored.

Program Receiver:	Enter with quick dial/speed dial.
[REDACTED]	
	Cancel OK

- 3** Press **[OK]**.

### Assigning a Quick Dial Key

- 1** Enter the code for "Assign Key" with the number keys.

Others:	Enter number
1 Program Password	2 Program Receiver
3 Assign Key	
	Exit

- 2** Press the Quick Dial key you wish to assign the box to.

Assign key:	Press Key to assign
(001-144)	[REDACTED]
*Press Clear to change	
Status	Cancel OK

**Note**

- To check the current contents of Quick Dial keys, press **[Status]**.

- 3** Press **[OK]**.

- 11** Press **[Exit]**.

Others:	Enter number
1 Program Password	2 Program Receiver
3 Assign Key	
	Exit

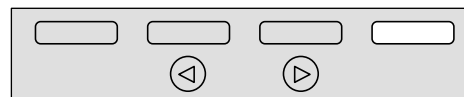

ZGSS220N

- 12** Press **[OK]**.

Personal Box:	Enter name
SUB:12345678	[007]
(Name:PERSONAL)	
Name	Others Cancel OK

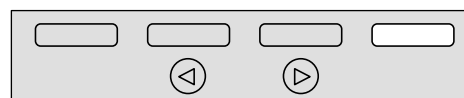

ZGSS220N

- 13** Press **[PrevMenu]** three times.

- 14** Press **[Exit]** to return to the stand-by mode.

## Deleting Personal Boxes

This section describes how to delete Personal Boxes.

### ! Limitation

- ❑ If the specified SUB Code is not registered as a Personal Box, or the messages of the box are registered, you cannot delete it.

#### 1 Press the **[User Tools]** key.

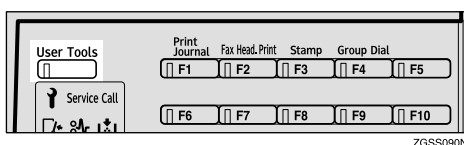

#### 2 Enter the code for "Key Op. Tools" with the number keys. Then press the **[#]** key.

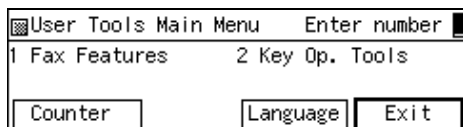

The "Key Op. Tools" main menu appears.

#### 3 Enter the code for "Box Settings" with the number keys.

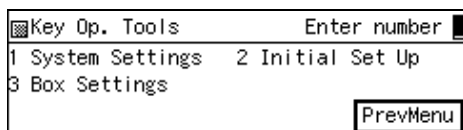

#### 4 Enter the code for "Del. Personal Box" with the number keys.

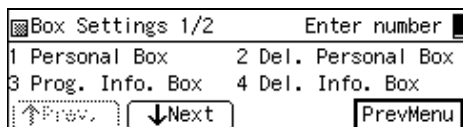

#### 5 Enter the SUB Code of the Personal Box you wish to delete.

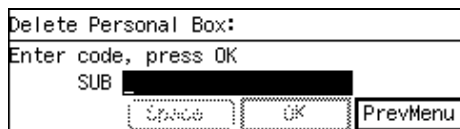

### ✎ Note

- ❑ If you incorrectly enter the code, press the **[Clear]** key or the **[Stop]** key, then try again.

#### 6 Press **[OK]**.

### ✎ Note

- ❑ If a password is already registered, enter the password, then press **[OK]**.

#### 7 Press **[Yes]**.

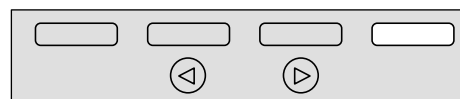
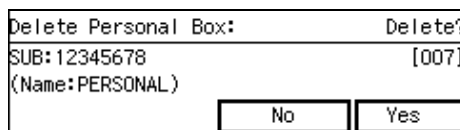

ZGSS220N

### ✎ Note

- ❑ If you press **[No]**, the box is not deleted and the display in step 5 reappears.

#### 8 Press **[Yes]**.

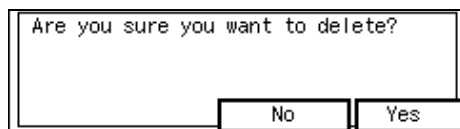

ZGSS220N

### ✎ Note

- ❑ If you press **[No]**, the box is not deleted and the display in step 5 reappears.

- 9 Press [PrevMenu] three times.
- 10 Press [Exit] to return to the stand-by mode.

## Information Boxes

Use the Information Box feature to set up the machine as a fax information service or document server. By scanning documents into Information Boxes, other parties can receive these messages whenever they request them. To check on the contents of Information Boxes, use the Print Information File function .

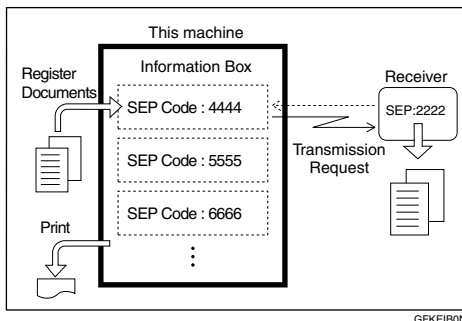

### Note

- ❑ Register documents for this feature using the Box File Manager function. See p.69 “Storing Messages in Information Boxes”.
- ❑ For the other party to be able to retrieve a message registered in an Information Box, you need to inform them of the SEP code assigned to that Information Box.
- ❑ When a SEP Code Polling Reception request is made by another party, the SEP code they specify is compared with the SEP code registered in that Information Box. If the codes match, the message stored in the Information Box is sent to the other party automatically. See p.16 “SEP Code Polling Reception” and p.80 “SEP/PWD (SEP Code Polling Transmission)”.

- ❑ You can print and check the contents of Information Boxes. See p.70 “Printing Information Box Messages” .

## Registering/Editing Information Boxes

This section describes how to set up an Information Box.

You can store the following items:

- SEP Code (required)  
Up to 20 characters long and can be composed of digits 0-9, “#”, “\*” and spaces (the first character cannot be a space).
- Password (optional)  
Up to 20 characters long and can be composed of digits 0-9, “#”, “\*” and spaces (the first character cannot be a space). By programming the password, you will required to enter the password when registering documents or printing the registered documents. See p.69 “Storing Messages in Information Boxes”, p.70 “Printing Information Box Messages” and p.80 “SEP/PWD (SEP Code Polling Transmission)”. However, when in SEP Code Polling Reception, the other party does not have to enter the password. See p.16 “SEP Code Polling Reception”.
- Name (required)  
Up to 20 characters long.

### Note

- ❑ You can edit boxes in the same way as registering them. However, to change the SEP Code itself, you must delete it then register a new SEP Code.

### Reference

p.251 “Information Boxes”

**1** Press the **[User Tools]** key.

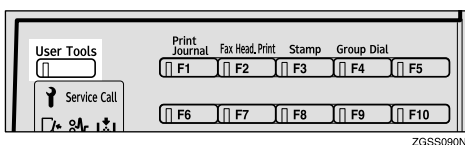

**2** Enter the code for "Key Op. Tools" with the number keys. Then press the **[#]** key.

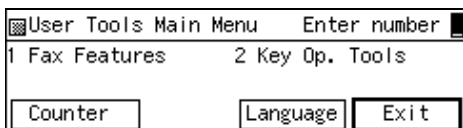

The "Key Op. Tools" main menu appears.

**3** Enter the code for "Box Settings" with the number keys.

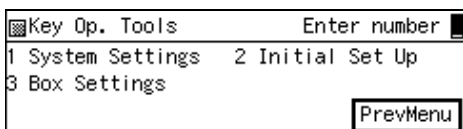

**4** Enter the code for "Prog. Info. Box" with the number keys.

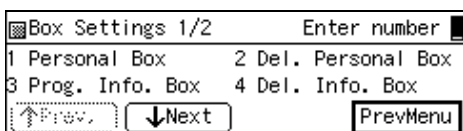

**5** Enter the SEP code you wish to register as an Information Box.

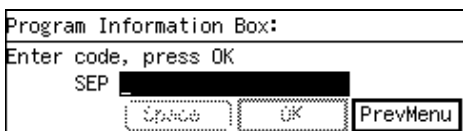

**Note**

- ❑ If you incorrectly enter the code, press the **[Clear]** key or the **[Stop]** key, then try again.

**6** Press **[OK]**.

**Note**

- ❑ If a password is already registered, enter the password, then press **[OK]**.

**7** Press **[Name]**.

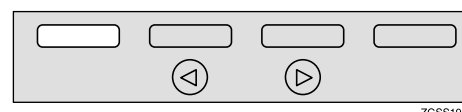
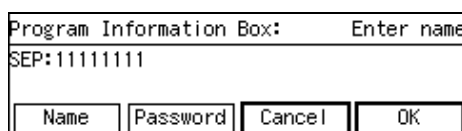

**8** Enter the name of the box.

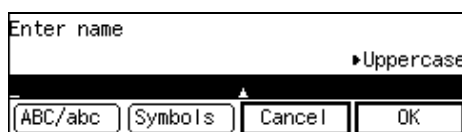

**Note**

- ❑ To change a previously stored name, press the **[Clear]** key or the **[Stop]** key, then enter a new one.

**Reference**

p.98 "Entering Characters", <Basic Features>

**9** Press **[OK]**.



**10** Press [Password].

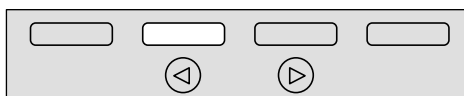

ZGSS200N

**Note**

- If you do not wish to register a password, proceed to step **13**.

**11** Enter the password you wish to register.

**Note**

- If you enter the password incorrectly, press the [Clear] key or the [Stop] key, then try again.

**12** Press [OK].

**13** Press [OK].

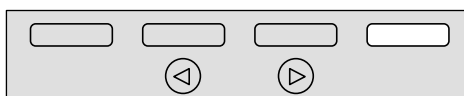

ZGSS220N

**14** Press [PrevMenu] three times.

**15** Press [Exit] to return to the stand-by mode.

## Deleting Information Boxes

This section describes how to delete Information Boxes.

### Limitation

- If the specified SEP Code is not registered as an Information Box or the messages of the box are registered, you cannot delete it.

**1** Press the [User Tools] key.

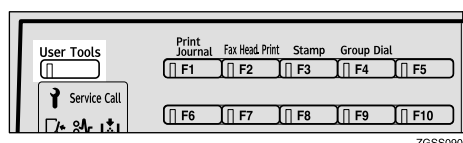

ZGSS090N

**2** Enter the code for "Key Op. Tools" with the number keys. Then press the [#] key.

The "Key Op. Tools" main menu appears.

**3** Enter the code for "Box Settings" with the number keys.

**4** Enter the code for "Del. Info. Box" with the number keys.

**5** Enter the SEP Code of the Information box you wish to delete.

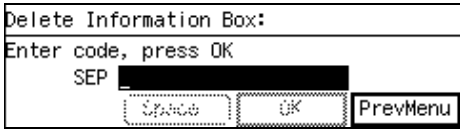

**Note**

- ❑ If you enter the code incorrectly, press the **[Clear]** key or the **[Stop]** key, then try again.

**6** Press **[OK]**.

**Note**

- ❑ If a password is already registered, enter the password, then press **[OK]**.

**7** Press **[Yes]**.

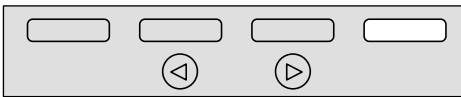
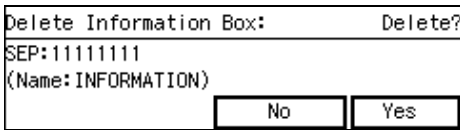

ZGSS220N

**8** Press **[Yes]**.

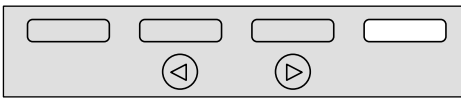
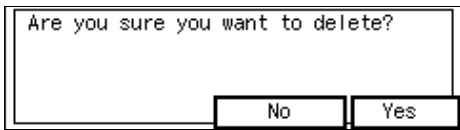

ZGSS220N

**Note**

- ❑ If you press **[No]**, the box is not deleted and the display in step **5** reappears.

**9** Press **[PrevMenu]** three times.

**10** Press **[Exit]** to return to the stand-by mode.

## Transfer Boxes

This feature turns your machine into a fax relay station. Documents sent with a SUB Code that matches the SUB Code registered as a Transfer Box are received then relayed to the registered receiver.

Since documents can be sent to multiple destinations in a single transfer request, you can economize on communication costs when sending to remote destinations.

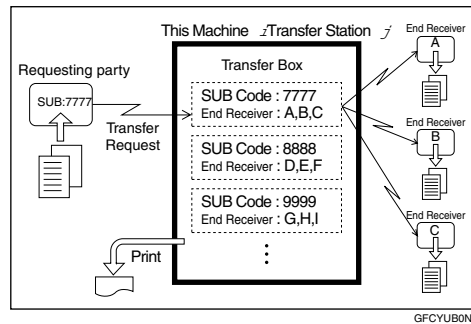

GFCYUB0N

**Note**

- ❑ Inform the requesting party of the SUB code assigned to the Transfer Box. When they wish to have a message transferred by your machine, ask them to send the message using SUB Code Transmission and specifying this SUB code. If a password is also registered, inform them of this too and ask them to enter it for the SID code. See p.78 "SUB/SID (SUB Code Transmission)" and p.13 "SUB Code Transmission with the Mode Key".

## Registering/Editing Transfer Boxes

This section describes how to set up a Transfer Box for forwarding incoming SUB transfer request messages onto end receivers.

You can store the following items:

- SUB Code (required)  
Up to 20 characters long and can be composed of digits 0-9, "#", "\*" and spaces (the first character cannot be a space).
- Name (required)  
Up to 20 characters long.
- Password (optional)  
Up to 20 characters long and can be composed of digits 0-9, "#", "\*" and spaces (the first character cannot be a space). By programming the password, no one without the password can access the Transfer Box. It is recommended to program the password if you wish to restrict the access to the Transfer Box.
- End Receiver (required)  
You can store 5 end receivers (destinations to which messages will be forwarded) for each box. Specify end receivers with Quick Dial keys, Speed Dials, or Groups assigned to Quick Dial keys that have been registered beforehand.

### Limitation

- ❑ After messages are transferred, a Transfer Result Report is not sent back to the sender.

### Note

- ❑ After messages are transferred they are deleted.

- ❑ By default, the machine prints out received messages and the Transfer Result Report that it transfers after the transfer has finished. If you wish to turn this feature off, please contact your service representative.
- ❑ You can have received messages sent using Economy Transmission. Please contact your service representative for details.
- ❑ When the registered receiver is a Multi-step Transfer Group Dial, Multi-step Transfer takes place. See p.115 "Multi-step Transfer" and p.87 "Groups", <Basic Features>.
- ❑ You can specify a Quick Dial key or Speed Dial containing an e-mail address as the receiver when the NIC FAX Unit (Option for Type1) is installed.
- ❑ You can edit boxes in the same way as registering them. However, to change the SUB Code itself, you must delete it then register a new SUB Code.

### Reference

p.254 "Transfer Boxes"

### 1 Press the [User Tools] key.

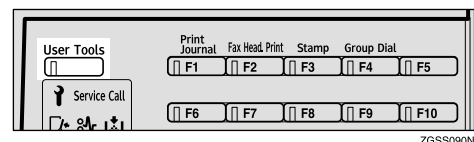

### 2 Enter the code for "Key Op. Tools" with the number keys. Then press the [#] key.

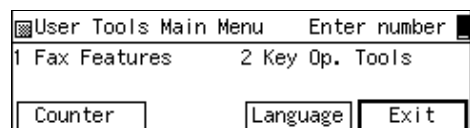

The "Key Op. Tools" main menu appears.

**3** Enter the code for "Box Settings" with the number keys.

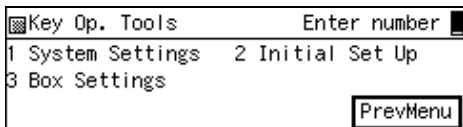

**4** Enter the code for "Prog. Transf. Box" with the number keys.

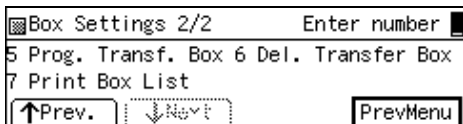

**Note**

- ❑ If "Prog. Transf. Box" is not displayed, press [↑Prev.] or [↓Next] until it is.

**5** Enter the SUB code you wish to register as a Transfer Box.

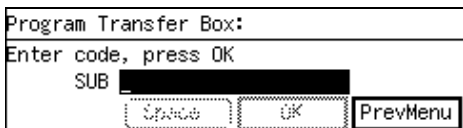

**Note**

- ❑ If you incorrectly enter the code, press the [Clear] key or the [Stop] key, then try again.

**6** Press [OK].

**Note**

- ❑ If a password is already registered, enter the password, then press [OK].

**7** Press [Name].

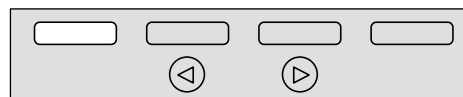
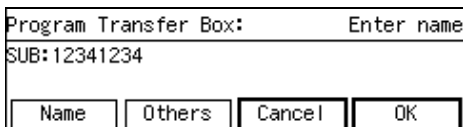

**8** Enter the name for the Transfer Box.

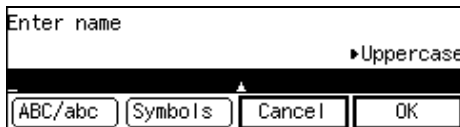

**Note**

- ❑ To change a previously stored name, press the [Clear] key or the [Stop] key, then enter a new one.

**Reference**

p.98 "Entering Characters", <Basic Features>

**9** Press [OK].

**10** Press [Others].

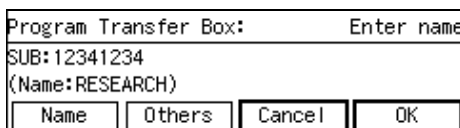

Registering a Password (SID)

**1** Enter the code for "Program Password" with the number keys.

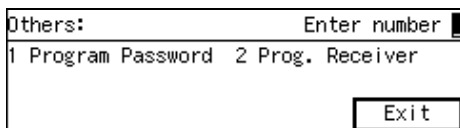

- 2** Enter the password you wish to register.

**Note**

- If you enter the password incorrectly, press the **[Clear]** key or the **[Stop]** key and try again.

- 3** Press **[OK]**.

## Registering End Receivers

- 1** Enter the code for "Prog. Receiver" with the number keys.

- 2** Enter the number of the end receiver you wish to register with the number keys.

**Note**

- You can register up to 5 end receivers.

- 3** Specify the Quick Dial key, Speed Dial or Group in which the end receiver is stored.

- 4** Press **[OK]**.

- 5** Press **[PrevMenu]**.

- 11** Press **[Exit]**.

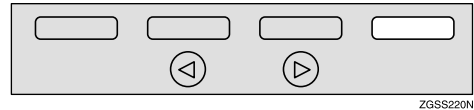

- 12** Press **[OK]**.

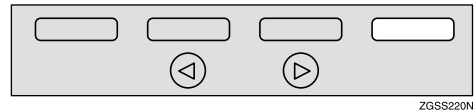

- 13** Press **[PrevMenu]** three times.

- 14** Press **[Exit]** to return to the standby mode.

## Deleting Transfer Boxes

This section describes how to delete Transfer Boxes.

### Limitation

- If the specified SUB Code is not registered as a Transfer Box, or the messages of the box are registered you cannot delete it.

**1** Press the **[User Tools]** key.

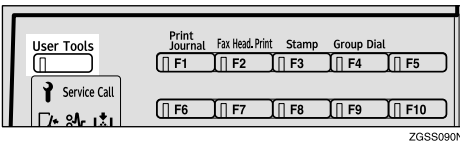

**2** Enter the code for "Key Op. Tools" with the number keys. Then press the **[#]** key.

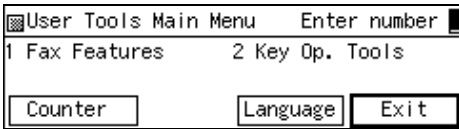

The "Key Op. Tools" main menu appears.

**3** Enter the code for "Box Settings" with the number keys.

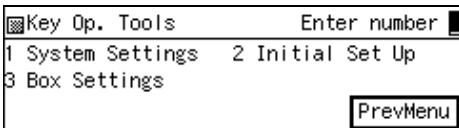

**4** Enter the code for "Del. Transfer Box" with the number keys.

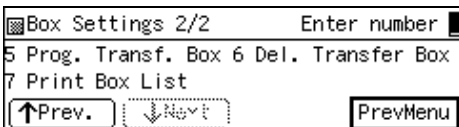

### Note

- If "Del. Transfer Box" is not displayed, press **[↑Prev.]** or **[↓Next]** until it is.

**5** Enter the SUB code of the Transfer Box you wish to delete.

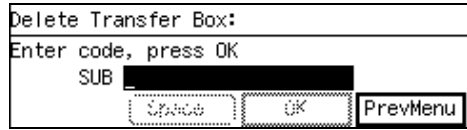

### Note

- If you enter the code incorrectly, press the **[Clear]** key or the **[Stop]** key and try again.

**6** Press **[OK]**.

### Note

- If a password is already registered, enter the password, then press **[OK]**.

**7** Press **[Yes]**.

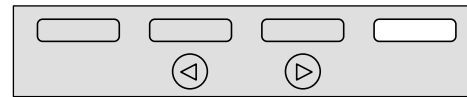
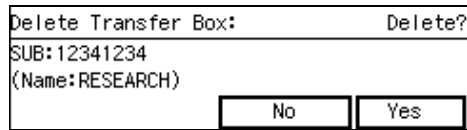

**8** Press **[Yes]**.

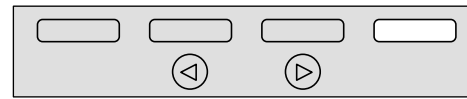
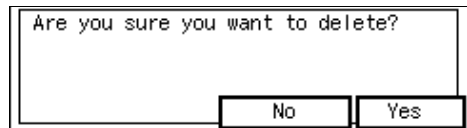

### Note

- If you press **[No]**, the box is not deleted and the display in step **5** reappears.

**9** Press **[PrevMenu]** three times.

**10** Press **[Exit]** to return to the stand-by mode.

## Printing the Box List

Follow the procedure below to print a list showing the currently registered Personal Boxes, Information Boxes and Transfer Boxes.

- 1 Press the **[User Tools]** key.

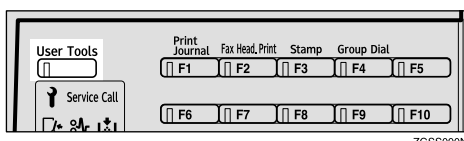

- 2 Enter the code for "Key Op. Tools" with the number keys. Then press the **[#]** key.

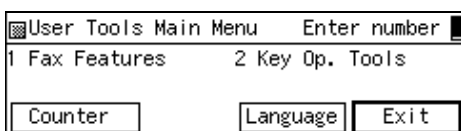

The "Key Op. Tools" main menu appears.

- 3 Enter the code for "Box Settings" with the number keys.

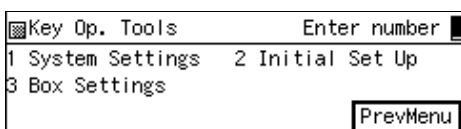

- 4 Enter the code for "Print Box List" with the number keys.

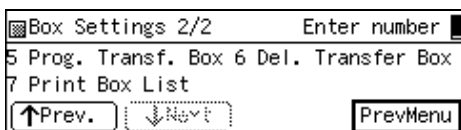

### Note

- If "Print Box List" is not displayed, press **[↑Prev.]** or **[↓Next]** until it is.

- 5 Press the **[Start]** key.

The list is printed.

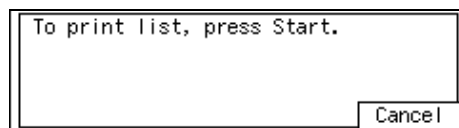

### Note

- To cancel printing, press **[Cancel]**. The display in step 4 will reappear.

- 6 Press **[PrevMenu]** twice.

- 7 Press **[Exit]** to return to the standby mode.





# 8. Solving Operation Problems

## Clearing a Paper Jam in the Optional Paper Supply Units

### Clearing a Paper Jam in the Optional Paper Tray Unit

The Fusing Unit and its surrounding areas may be very hot. Do not touch areas other than those indicated in this manual when clearing a paper jam. Doing so may result in burns.

#### Important

- ❑ Do not attempt to pull out jammed paper with excessive force. Doing so may rip the paper or cause the machine to malfunction.

#### Note

- ❑ For instructions on clearing paper jams in the main paper tray, see p.108 "Clearing Original Jams", <Basic Features>.

- 1** Open the side cover of the optional Paper Tray Unit in the direction of the arrow.

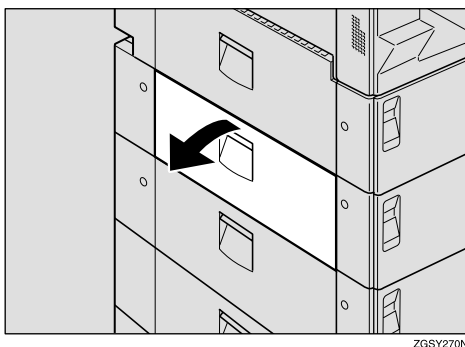

- 2** Remove any jammed paper slowly.

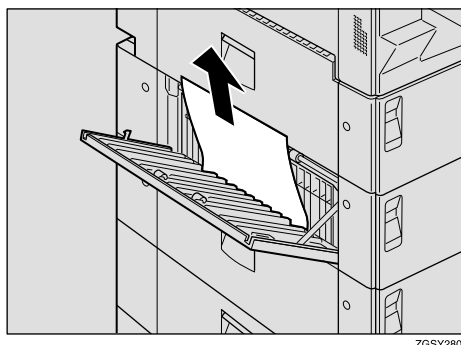

- 3** Push the side cover closed until you hear it click into place.

- 4** Pull out the optional Paper Tray Unit in the direction of the arrow.

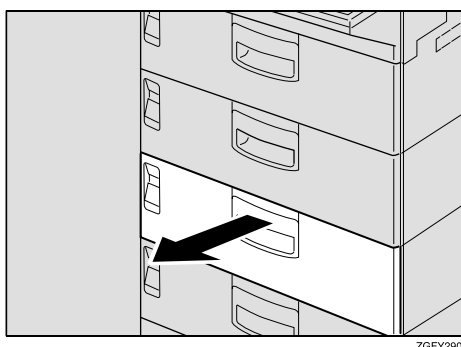

**5** Remove any jammed paper slowly.

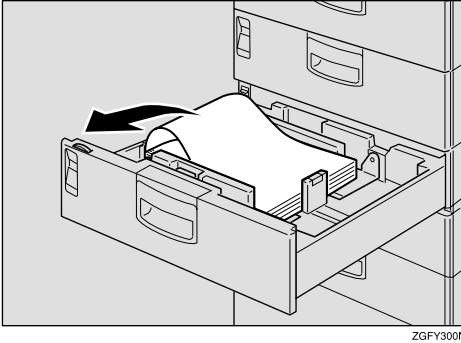

**2** Remove any remaining paper.

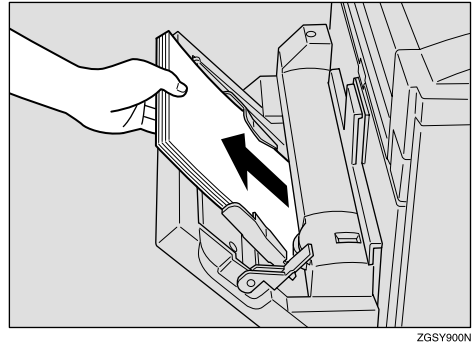

**6** Push in the optional Paper Tray Unit until it clicks into place.

## Clearing a Paper Jam in the Optional Bypass Tray Unit

### Important

Do not attempt to pull out the jammed paper with excessive force. Doing so may rip the paper or cause the machine to malfunction.

**1** Shift the paper stop lever toward the machine.

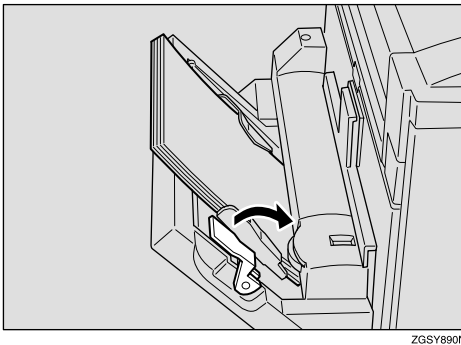

**3** Hold both ends of the Bypass Tray Unit firmly, and lift it up slightly to remove it.

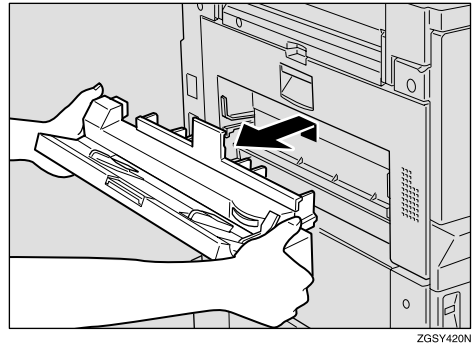

**4** Remove any jammed paper slowly.

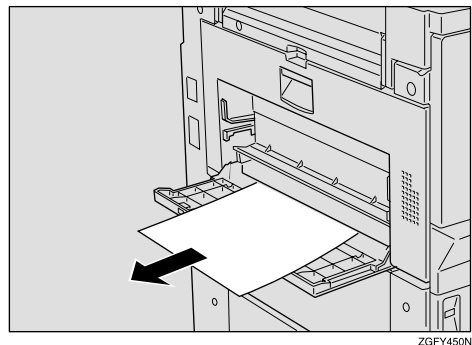

### Note

If you find any paper jammed in the Fusing Unit area, remove it following the procedure described under p.110 "Clearing Paper Jams in the Fusing Unit", <Basic Features>.

- 5** Hold the Bypass Tray Unit at both ends, and reattach it to the machine.

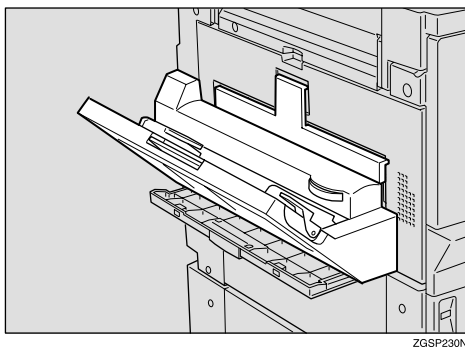
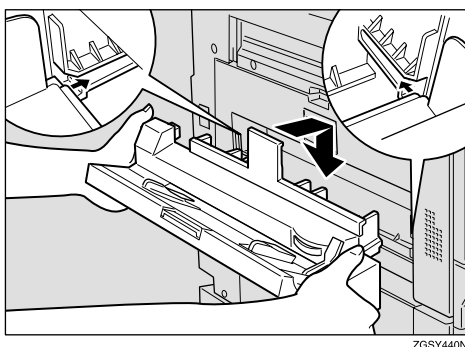

**Note**

- Make sure that the unit is properly attached to the machine. It should not be tilted, nor should there be any gap between the unit and machine.

- 6** Even the edges of a stack of paper and load it into the unit with the printable surface facing down.

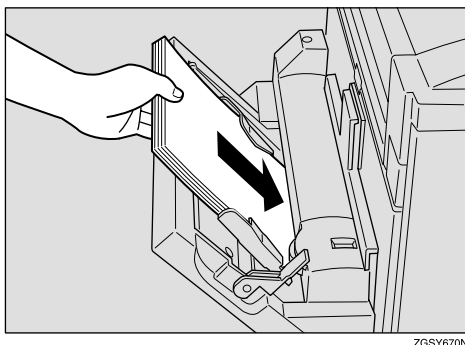

- 7** Shift the paper stop lever back to its original position.

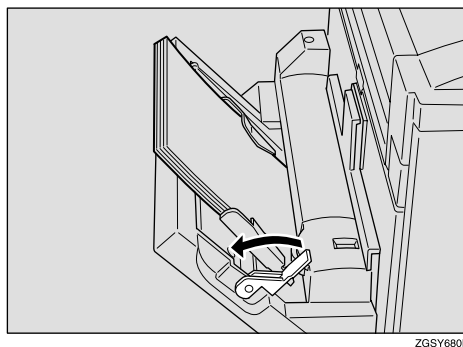

# Reading Reports

## Error Report

The error report is printed after each unsuccessful communication (both transmission and reception). The communication failure may normally be caused either by your machine, or the fax machine on the other end. Noise on the telephone line may also be one of the causes. If the error report is printed after sending a fax message, try sending it again. If the report is printed after a fax message came in, contact the sender and request them to send it again.

### Note

- If the machine continues to print error reports after retrials, contact your service representative.
- Normally, when specifying the destination with a Quick Dial key or Speed Dial, "ADDRESS" on this report shows Own Name or Own Fax Number registered in the receiver's machine. However, you can change the setting with User Parameters so that the name or number of the destination stored in the Quick Dial key or Speed Dial in your machine is printed instead. See p.178 "User Parameters" (switch 04 bit 4).

### Reference

p.265 "Error Codes"

## Power Failure Report

Turning the power off does not erase the data stored into the machine such as fax numbers programmed in a Quick Dial key. However, if the machine is left turned off for 12 hours or longer, the data stored in the machine's memory with functions such as Memory Transmission/Reception, Substitute Reception or Auto Document, or data of other standby documents is deleted. Once the data stored in memory is deleted, the machine automatically prints out the power failure report when you turn it on again, so that you may check the deleted data.

If the deleted fax message was for Memory Transmission, check the receiver's information and send it. If it was stored in Memory Reception or Substitute Reception functions, contact the sender and request them to send it again. If it was an Auto Document, register the document once more.

### Important

- Make sure that the available memory level which appears on the display is 100% before turning the power off.

## Error Codes

Fax machines use a telephone line. The same types of problems you experience while making phone calls (such as noisy lines, crosstalk, disconnection during conversation, and weak signals) also occur with faxing. Telephone callers can deal with the problems themselves (for example, by speaking a bit louder), but fax machines cannot. Therefore some errors and line failures are to be expected.

When an error occurs, an error report is printed. This report includes an error code. The following table lists common error codes and a few of the possible causes. If any of these or any other error codes persistently appear and the machine does not work properly, contact your service representative.

### Note

- When an error occurs, it does not necessarily mean that you are doing anything wrong or that your machine needs service. Only if the problem persists should you call your service representative.

Code	Possible Cause
0-01	Printer empty or jammed at the other end
0-04	Faulty machine at the other end Poor line condition
0-05	Poor line condition
0-06	Incompatible or faulty terminal at the other end Poor line condition
0-07	The facsimile machine that you were sending to was disconnected during the call, either due to noisy phone lines, a paper jam or because it ran out of paper. Resend the page.
0-08	The machine at the other end received the page that you sent but it had errors on the page. You may wish to resend the page in question. The other party's memory could also be full. Contact the other party and ask them to make room in their memory for your message.
0-14	Same as for code 0-06
0-15	The other party does not have the confidential or transfer function. The other party's memory may be full.
0-16	Same as for code 0-04
0-20	Poor line condition
0-21	Same as for code 0-04
0-22	You have just received a fax message, but there were problems because of poor line condition. Ask the other party to resend.
0-23	Same as for code 0-22
0-24 0-25	The memory may be full, and there may be a problem with your printer, such as a jam or lack of paper or toner. Wait for some space to appear in the memory, and then solve the problem with your printer. If the memory was not full, substitute reception may have been disabled; switch substitute reception on with User Parameters.

Code	Possible Cause
0-80~88	Poor line condition Incompatible or faulty terminal at the other end
1-00	Document jam Improperly inserted document
1-01	Document length exceeded the maximum limit Same as for code 1-00
2-xx	Possible fault in your machine
3-xx	There is a problem with the ISDN network. Check the ISDN line connection. Faulty terminal at the other end.
4-10	ID codes did not match. Co-ordinate ID codes with the other party.
5-20 5-21 5-22 5-23	Insufficient memory to receive the message. When the pages in memory have been printed, ask the other party to resend.
5-25 5-30	Your machine has a problem.
6-00 6-01 6-02 6-04	Poor line condition or a problem with your machine
6-05	Poor line condition, a problem with the machine at the other end, or a problem with your machine
6-06	A problem with the machine at the other end, or a problem with your machine
6-08	A problem with the machine at the other end
6-09 6-10	A problem with the machine at the other end, or a problem with your machine
9-07	Copy jam at the tray entrance (first, or top, paper feed station)
9-08	Copy jam inside the machine (first, or top, paper feed station)
9-09	Copy jam at the feed-out area
9-10	Toner end. Replace the toner cartridge.
9-17 9-20 9-22 9-23 9-24	There is a problem with your printer.
9-3x	There is a problem with the hard disk option.

# 9. Maintaining Your Machine

## Loading Paper into the Optional Paper Tray Unit

The following procedure describes how to load paper in the optional Paper Tray Unit.

- 1** Pull out the optional Paper Tray Unit.

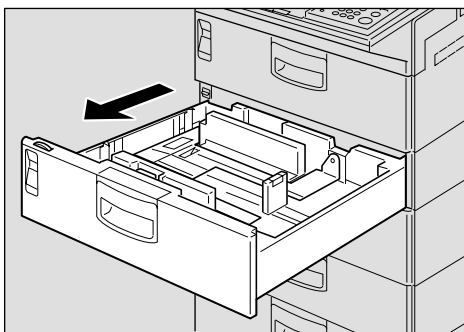

ZGSY490N

- 2** Adjust the size mark to the size of the paper that you are loading.

Turn the dial to adjust it, so that the desired paper size appears.

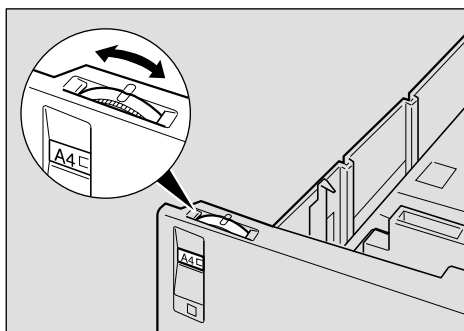

ZGSY500N

### **Important**

- Make sure that the size of paper loaded in the unit matches the size indicated by the size mark. If not, the size of the loaded paper is not recognized correctly and the printed images may be incomplete or paper jams may occur.

- 3** Fan a stack of paper and even the edges, then load it in the Paper Tray Unit with the printable surface facing down. Make sure that the top of the paper is under the notches in the corner of the unit.

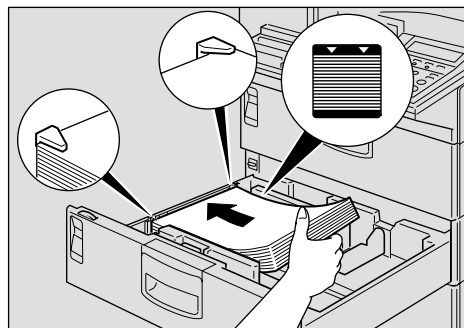

ZGSY090N

### **Important**

- Make sure not to load paper over the limit mark.

### **Note**

- You can load up to 500 sheets of copy paper.

- 4** Replace the Paper Tray Unit carefully.

# Loading Paper into the Optional Bypass Tray Unit

## Note

- You can load paper in the optional Bypass Tray Unit up to approximately 100 sheets (8<sup>1</sup>/<sub>2</sub>"×11" or smaller size), 10 sheet (larger than 8<sup>1</sup>/<sub>2</sub>"×11" size) or 40 postcards ( only).

- 1** Shift the paper hold lever toward the machine.

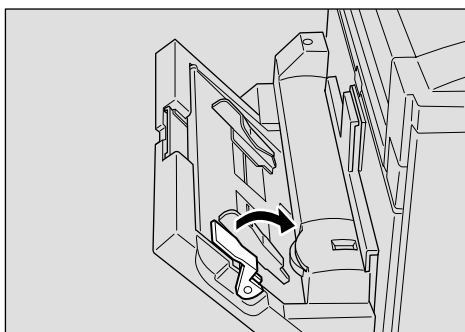

ZGSY660N

- 2** Even the edges of a stack of paper and load it into the unit with the printable surface facing down.

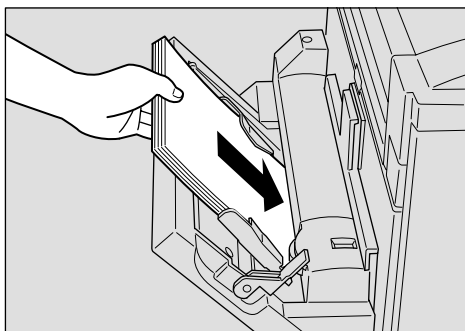

ZGSY670N

- 3** Shift the paper hold lever back to its original position.

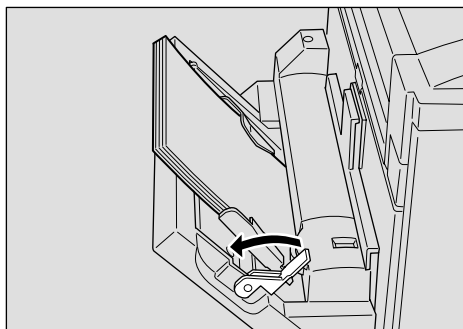

ZGSY680N

## Important

- Make sure not to load paper over the limit mark.



# Changing the Paper Size

This section describes how to change the paper size in the main paper tray, optional Paper Tray Unit and optional Bypass Tray Unit to a desired paper size.

Do not use paper with staples or conductive paper such as aluminum foil or paper that contains carbon. Doing so may cause fire.

Be careful not to injure your fingers when changing copy paper.

## Changing the Paper Size in the Main Paper Tray

The following example explains how to switch to A4 size paper. To switch to other paper sizes, follow the same steps but move the end plate and side rails to the appropriate size mark on the tray.

### ⚠ Important

- ❑ Make sure that copying or printing of received fax messages is not in progress.

### 📝 Note

- ❑ You can load up to 500 sheets of copy paper in the main paper tray.
- ❑ For information on the size and orientation of copy paper that you can load in the paper tray, see p.298 "Paper"

- 1 Pull out the main paper tray until it comes to a complete stop.**

Make sure to keep the paper tray horizontal when pulling it out.

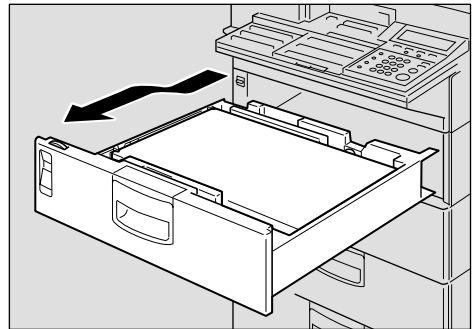

ZGSY690N

- 2 Remove any remaining paper.**

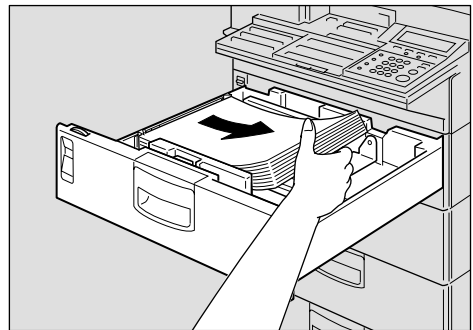

ZGSY710N

- 3 Adjust the size mark to the size of the paper that you are loading.**

Turn the dial to adjust it, so that the desired paper size appears.

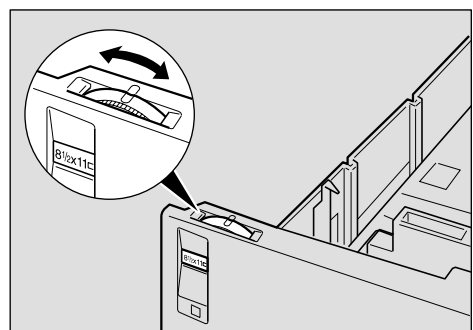

ZGSY080N

**Important**

- ❑ Make sure that the size of paper loaded in the unit matches the size indicated by the size mark. If not, the size of the loaded paper is not recognized and printed images may be incomplete or paper jams may occur.

- 4** Adjust the side rail nearest to you to the size of the paper that you are loading while squeezing the green tray extension release tab.

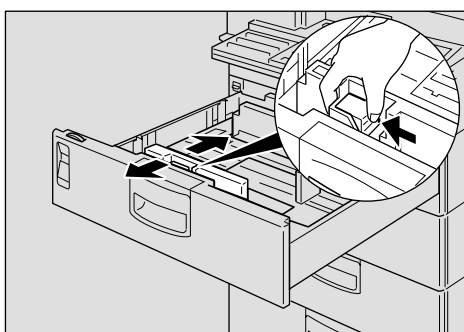

ZGSY730N

To Change to Legal or Letter Size

- 1** First set the side rail to a size smaller than Legal (8 1/2 x 14 in.) or Letter (8 1/2 x 11 in.) to peel off the sticker at the bottom as shown below, then adjust the side rail to the desired paper size.

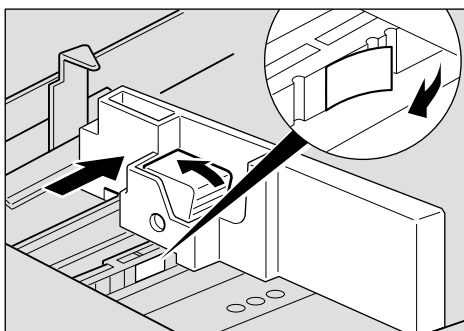

ZGSY520N

- 5** Make sure that the side rail is set correctly to the desired paper size indicated at the bottom of the paper tray.

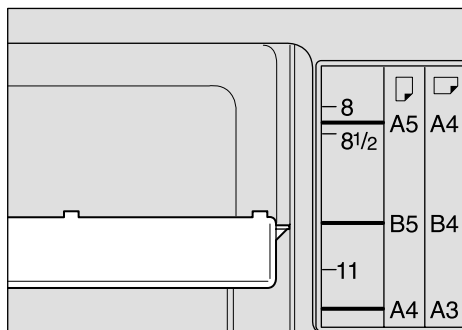

ZGSY740N

- 6** Remove the end plate by squeezing in at both sides and lifting it up.

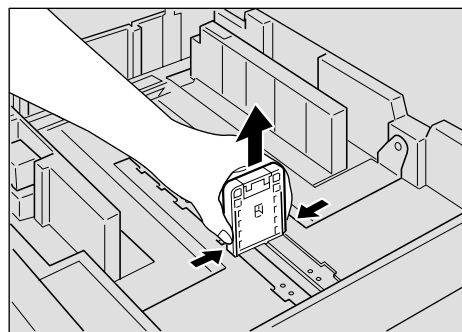

ZGSY860N

- 7** Insert the end plate into the slot for the desired paper size.

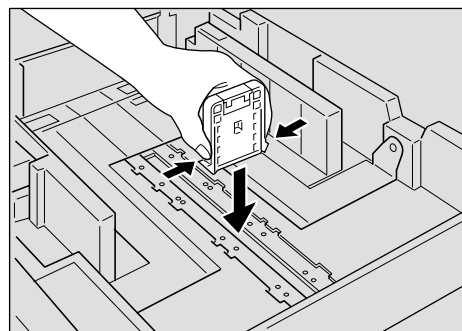

ZGSY870N

**Important**

- Make sure that the end plate is properly inserted so that the tabs at the lower end of the plate are securely fastened to the bottom plate of the tray.

- 8** Fan a stack of paper and even the edges, then load it in the main paper tray with the printable surface facing down. Make sure that the top of the paper is under the notches in the corner of the tray.

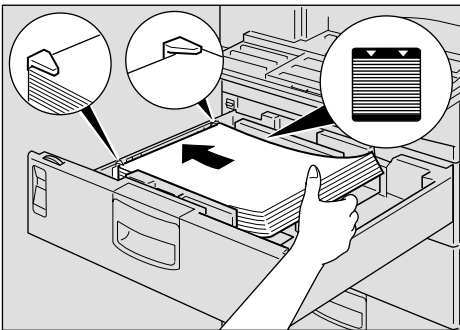

ZGSY810N

**Important**

- Make sure not to load paper over the limit mark.

- 9** Replace the main paper tray carefully.

## Changing the Paper Size in the Optional Paper Tray Unit

**Important**

- Make sure that copying or printing of received fax messages is not in progress.

**Note**

- You can load up to 500 sheets of copy paper in the optional Paper Tray Unit.
- For information on the size and orientation of copy paper that you can load in the unit, see p.298 "Paper".

- 1** Pull out the Paper Tray Unit until it comes to a complete stop.

Make sure to keep the unit horizontal when pulling it out.

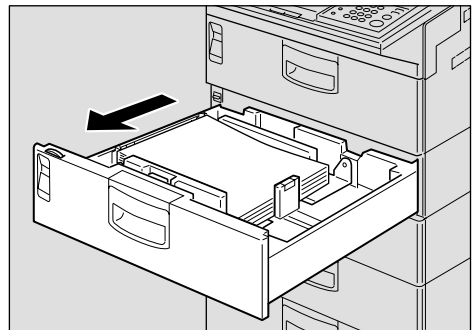

ZGSY820N

- 2** Remove any remaining paper.

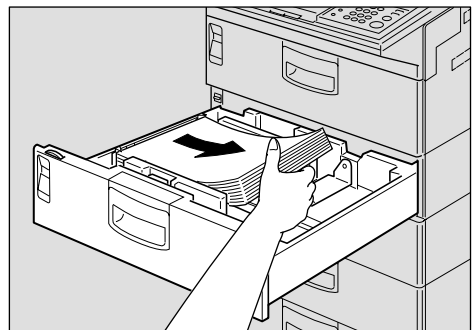

ZGSY830N

- 3** Adjust the size mark to the size of the paper that you are loading.

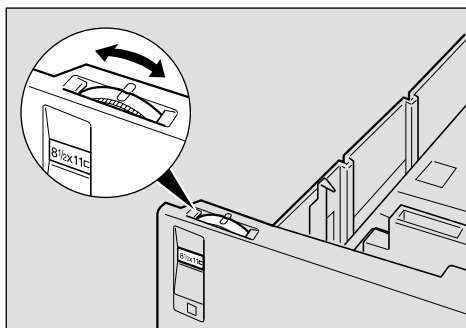

ZGSY080N

**Important**

- Make sure that the size of paper loaded in the unit matches the size indicated by the size mark. If not, the size of the loaded paper is not recognized and printed images may be incomplete or paper jams may occur.

- 4** Adjust the side rail that is nearer to you to the size of the paper that you are loading while squeezing in the green tray extension release tab.

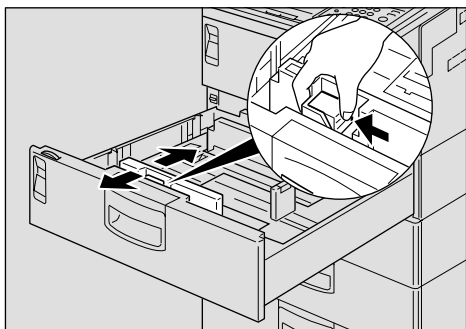

ZGSY850N

To Change to Legal or Letter Size

- 1** First set the side rail to a size smaller than Legal (8 1/2 x 14 in.) or Letter (8 1/2 x 11 in.) to peel off the sticker at the bottom as shown below, then adjust the side rail to the desired paper size.

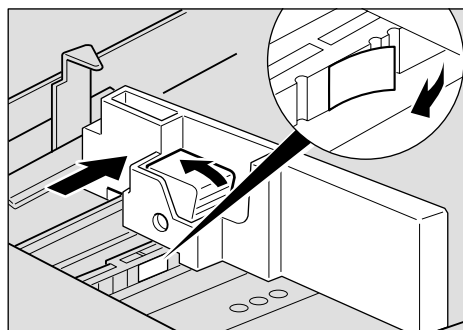

ZGSY520N

- 5** Make sure that the side rail is set correctly to the desired paper size indicated at the bottom of the unit.

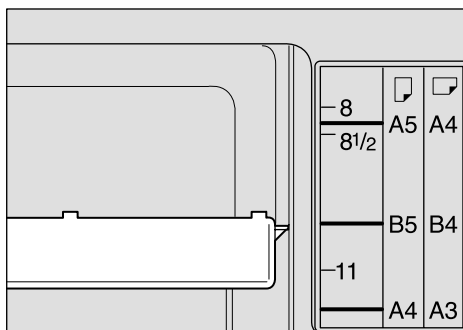

ZGSY740N

- 6** Remove the end plate by squeezing in at both sides and lifting it up.

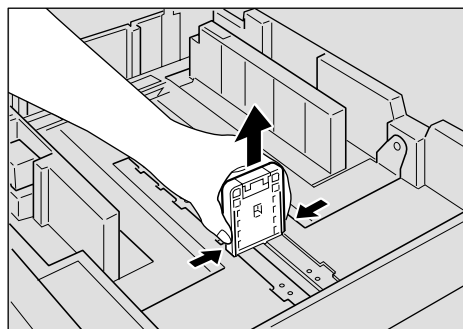

ZGSY860N

- 7** Insert the end plate into the slot for the desired paper size.

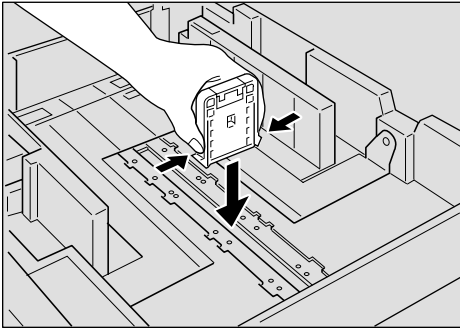

ZGSY870N

### Important

- Make sure that the end plate is properly inserted so that the tabs at the lower end of the plate are securely fastened to the bottom plate of the unit.

- 8** Fan a stack of paper and even the edges, then load it in the unit with the printable surface facing down. Make sure that the top of the paper is under the notches in the corner of the unit.

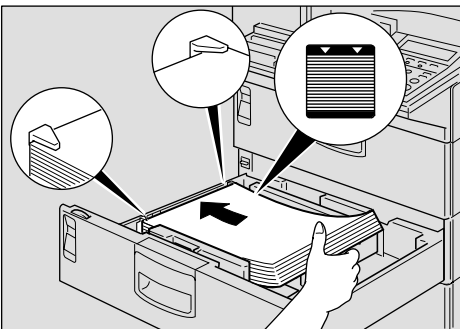

ZGSY880N

### Important

- Make sure not to load paper over the limit mark.

- 9** Replace the optional Paper Tray Unit carefully.

## Changing the Paper Size in the Optional Bypass Tray Unit

### Important

- Make sure that copying or printing of received fax messages is not in progress.

### Note

- You can load up to approximately 100 sheets (8<sup>1</sup>/<sub>2</sub>"×11" or smaller size), 10 sheets (larger than 8<sup>1</sup>/<sub>2</sub>"×11" size) or 40 postcards (☐ only) in the optional Bypass Tray Unit.
- For information on the size and orientation of copy paper that you can load in the unit, see p.298 "Paper".

- 1** Shift the paper hold lever toward the machine.

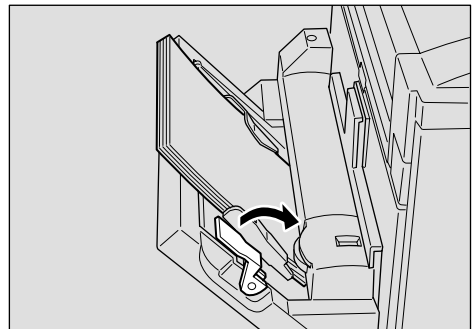

ZGSY890N

- 2** Remove any remaining paper.

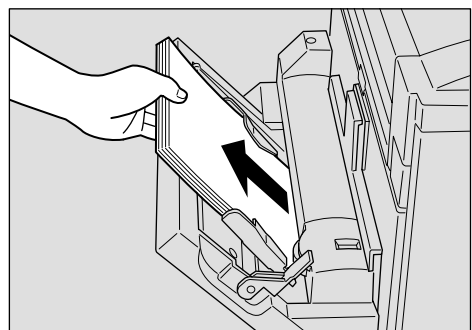

ZGSY900N

- 3** Adjust the paper size mark to the size of the paper that you are loading.

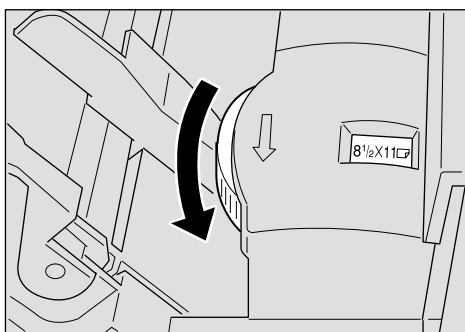

ZGSY910N

 **Note**

- To load custom size paper, set the paper size to the "✖" mark.
- You can use custom size paper only for making copies or PC Printing (option).

- 4** Adjust the paper guide to the size of the paper that you are loading.

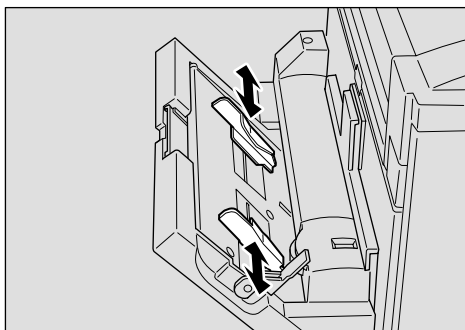

ZGSY920N

- 5** Even the edges of a stack of paper and load it into the unit with the printable surface facing down.

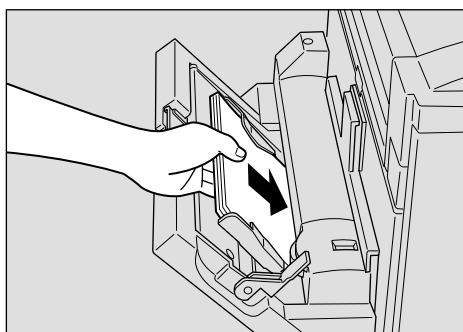

ZGSY930N

 **Important**

- Make sure not to load paper over the limit mark.

- 6** Shift the paper hold lever back to its original position.

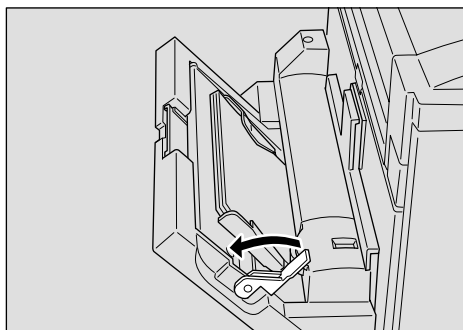

ZGSY940N

# Cleaning

You may not have satisfactory copying or printing results if the parts of the machine are not clean. Clean your machine regularly so that you may always use it in the best condition.

The parts that need to be cleaned regularly are listed below.

- Document transport mechanism
- Copy paper transport mechanism of the optional Paper Tray Unit

## ⚠ Important

- Do not use thinner, benzene, alcohol or detergent for cleaning. Doing so may cause the plastic parts to change shape or color.

## Cleaning the Document Transport Mechanism

- 1** Open the ADF cover.

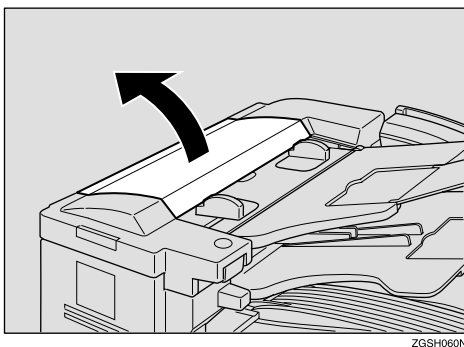

- 2** Remove the feed unit by first pushing it in the direction of the arrow and then lifting up the end of the unit that is nearest to you.

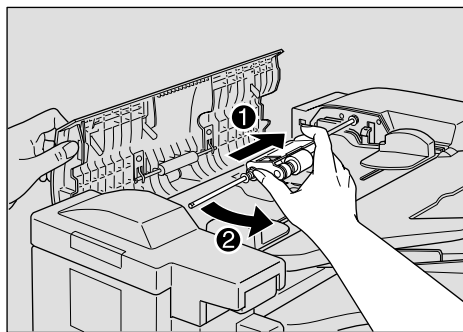

## 📌 Note

- You may remove the feed unit only when you are cleaning it or replacing it with a new one.

- 3** Wipe the entire surface of the separation roller as well as the rollers of the feed unit while rotating them.

Use a soft cloth that has been dampened with water and wrung out.

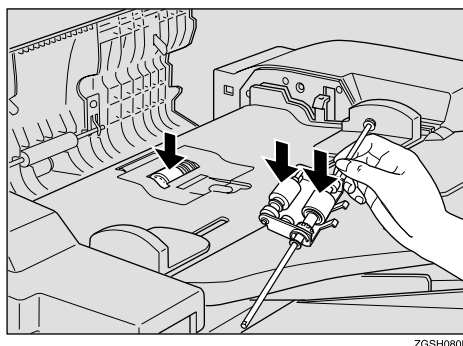

- 4** Replace the feed unit to its original position by first pushing the far end, and then pushing the near end into their places.

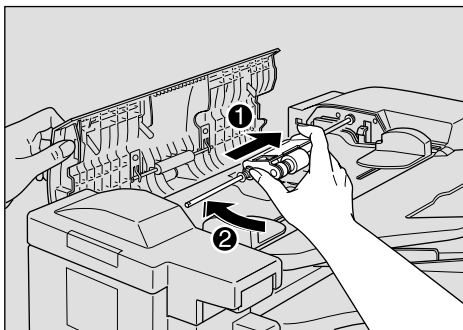

ZGSH090N

- 5** Close the ADF cover, making sure that it clicks firmly into place.

- 6** While pushing the release lever, open the ADF unit.

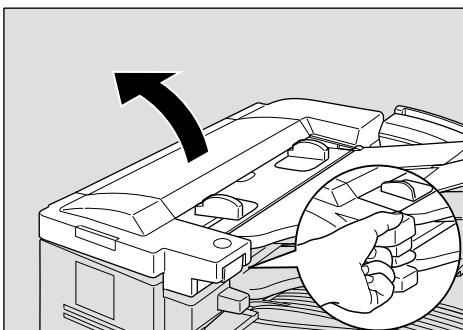

ZGSY140N

- 7** Wipe the exposure glass, the white strip under the exposure glass cover, and the six rollers.

Use a dry, soft cloth. If it is very dirty, wipe with a soft cloth that has been dampened with water and wrung out, then wipe the surface with a dry cloth.

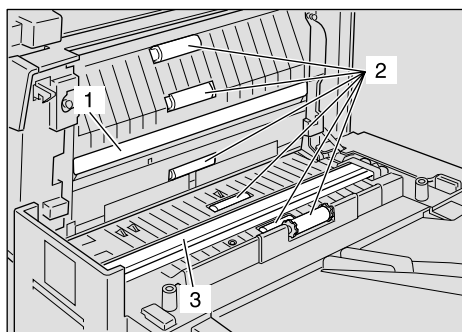

ZGSH120N

1. White strip
2. Roller
3. Exposure glass

- 8** Close the ADF unit, making sure that it clicks firmly into place.



## Cleaning the Copy Paper Transport Mechanism

### Main Paper Tray

- 1 Open the side cover of the main paper tray.

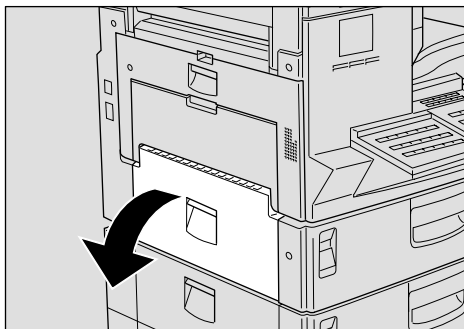

ZGSY220N

#### Note

- You cannot open the paper tray side cover when the optional Bypass Tray Unit is installed. Remove the optional Bypass Tray Unit first, and then open the paper tray side cover. See p.278 "Optional Bypass Tray Unit".

- 2 Wipe the two rollers with a soft cloth that has been dampened with water and wrung out.

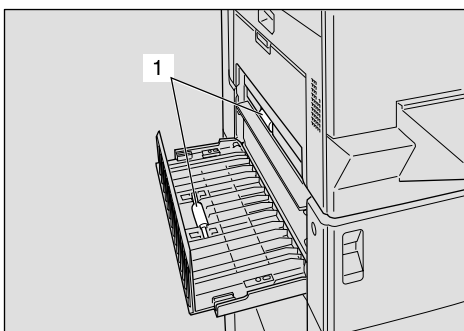

ZGSH140N

### 1. Roller

- 3 Close the side cover of the main paper tray, making sure that it locks firmly into place.

### Optional Paper Tray Unit

- 1 Open the side cover of the Paper Tray Unit.

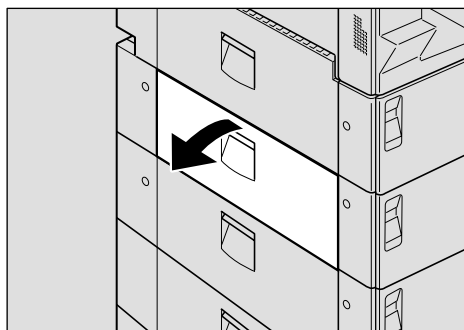

ZGSP270N

- 2 Wipe the five rollers with a soft cloth that has been dampened with water and wrung out.

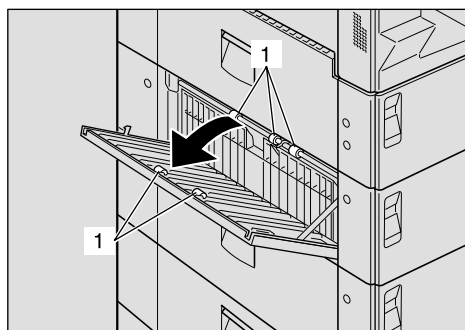

ZGSP030N

### 1. Roller

- 3 Close the unit's side cover making sure it locks firmly into place.

## Optional Bypass Tray Unit

- 1 Shift the paper stop lever toward the machine.

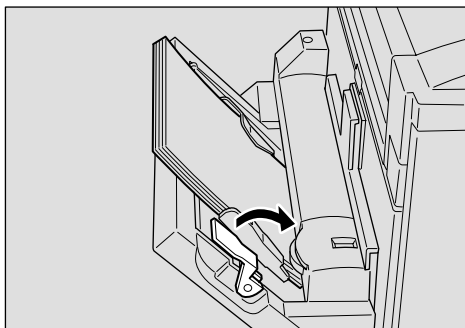

ZGSY890N

- 2 Remove any remaining paper.

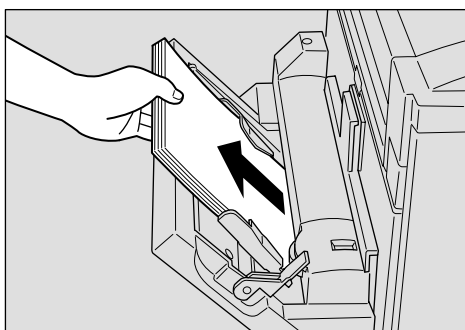

ZGSY900N

- 3 Hold both ends of the Bypass Tray Unit firmly, and lift it up slightly to remove it.

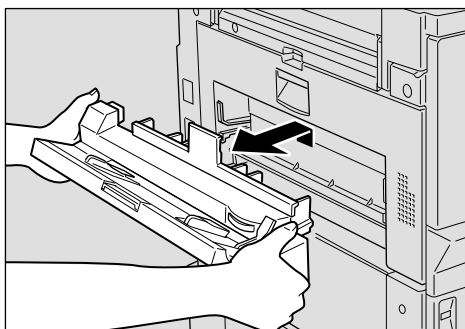

ZGSY420N

- 4 Wipe the entire surface of the roller while rotating it.

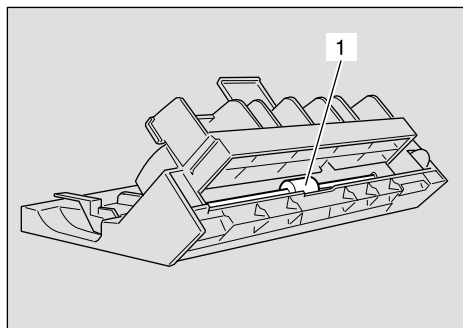

ZGSP110N

### 1. Roller

- 5 Hold the Bypass Tray Unit at both ends, and reattach it to the machine.

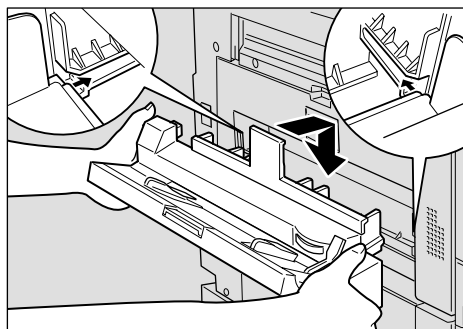

ZGSY440N

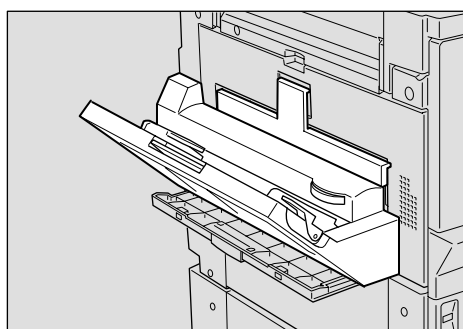

ZGSP230N

### Note

- Make sure that the unit is properly attached to the machine. It should not be tilted, nor should there be a gap between the unit and machine.

- 6** Even the edges of a stack of paper and load it into the unit with the printable surface facing down.

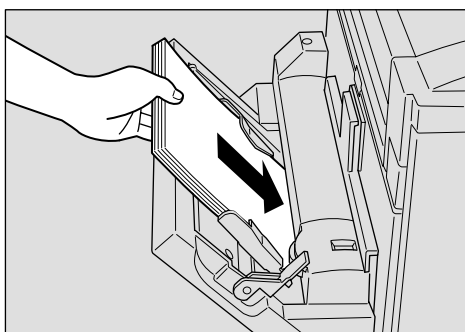

ZGSY670N

- 7** Shift the paper stop lever back to its original position.

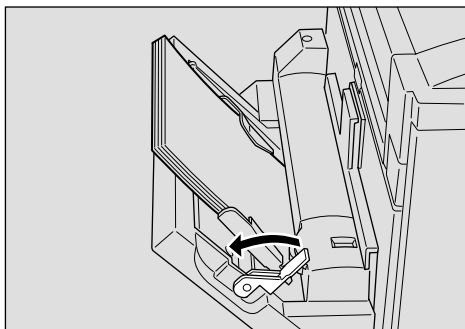

ZGSY680N

## Cleaning the Registration Roller

Some parts of the machine may be very hot. Do not touch the areas labelled "Caution! Hot surface." Doing so may result in a burn.

### ! Limitation

- Cleaning the registration roller while the power is turned on may result in a burn. Make sure to turn the power off before cleaning the registration roller.

- 1** Open the main side cover.

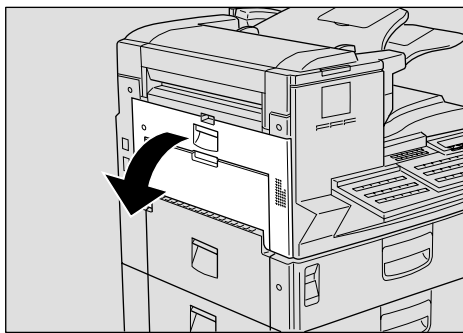

ZGSY160N

- 2** While rotating the rubber part of the registration roller, wipe it with a soft cloth that has been dampened with water and wrung out.

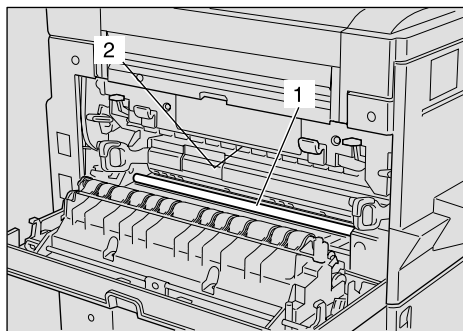

ZGSU030N

**1.** Registration roller

**2.** ⚠ Caution / Hot surface

- 3** Close the main side cover, making sure it locks firmly into place.

# Replacing the Stamp Cartridge

When the stamp mark begins to fade, it is time to replace the stamp cartridge.

## Note

- Only use stamp cartridges designed specifically for this machine.
- One stamp cartridge can stamp approximately 3,000 times.

**1** Open the ADF unit while pushing the release lever.

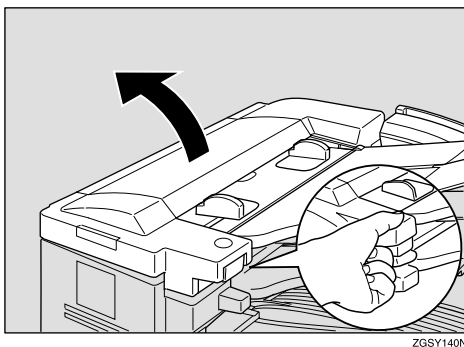

**2** Pull out the old stamp cartridge.

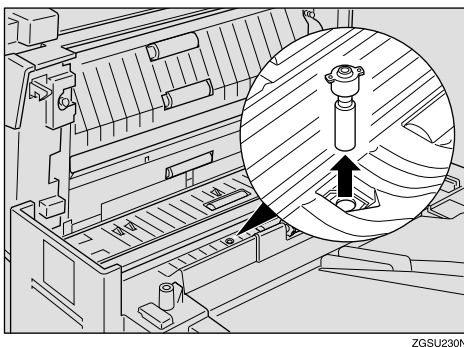

## Note

- Remove the stamp cartridge with pincers, or carefully ease out the end of the stamp head with your fingernails.

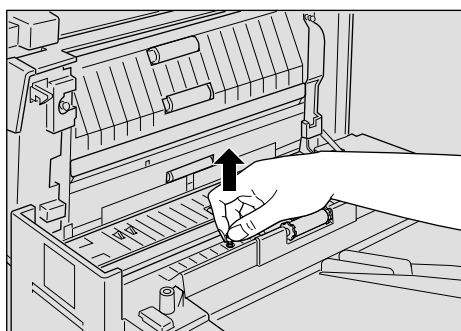

**3** Insert the new stamp cartridge.

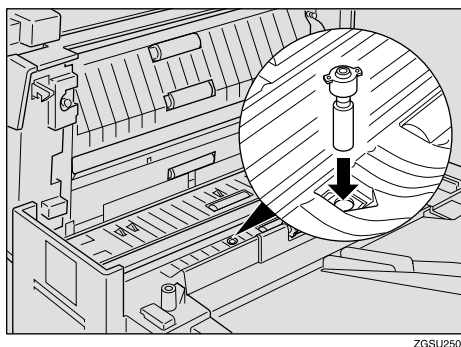

**4** Close the ADF unit, making sure that it clicks firmly into place.

## Installation, Move and Disposal of the Machine

This section provides you with information about installation, move and disposal of this machine.

### Important

- Installation of this machine must be performed by an authorized dealer or service representative. Never attempt to install the machine by yourself.

---

### Machine Environment

---

If the machine is installed in an inappropriate location, you may not be able to make copies or send or receive fax messages properly. Doing so may also cause the machine to malfunction.

#### **WARNING:**

- **Connect the power cord directly into a wall outlet and never use an extension cord.**
- **Turn off the power and disconnect the power plug (by pulling the plug, not the cable) if any of the following occurs:**
  - **You spill something into the machine.**
  - **You suspect that your machine needs service or repair.**
  - **The external housing of your machine has been damaged.**

#### **CAUTION:**

- *Protect the machine from dampness or wet weather, such as rain and snow.*
- *Do not allow paper clips, staples, or other small metallic objects to fall inside the machine.*

#### Note

- Install the machine on a level surface. Make sure that the difference in height is less than 2mm (0.08 in.) between the four corners of the machine.
- Install the machine on a stable surface. If you need to place it on a table, prepare a sturdy table larger than the size of the machine exclusively for the machine.
- To avoid possible build-up of ozone, be sure to locate this machine in a large well ventilated room that has an air turnover of more than 30m<sup>3</sup>/hr/person.

- ❖ Use this machine in an environment that satisfies the conditions described in the diagram below.

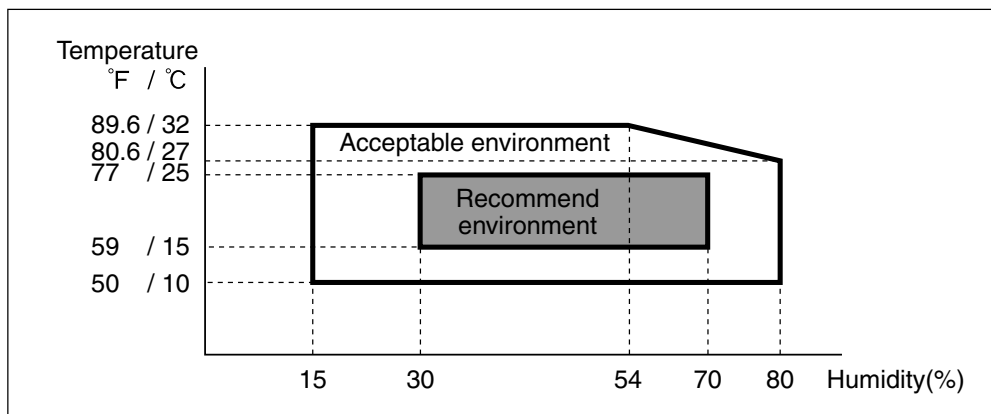

#### Note

- ☐ When the machine is subject to a sudden and drastic change in temperature or humidity, condensation in the machine may affect the printing quality of the copied images or received messages. If this should occur, wait momentarily, and copy the images again, or ask the sender of the message to resend.

#### ❖ Recommended Environment

- Temperature 15 – 25°C (59 – 77°F)
- Humidity 30 – 70% RH (do not install near a humidifier)

#### ❖ Acceptable Environment

- Temperature 10 – 32°C (50 – 89.6°F)
- Humidity 15 – 80% RH (do not install near a humidifier)

## Location

Allow enough space around the machine for smooth fax or copy operation, and servicing by a service representative.

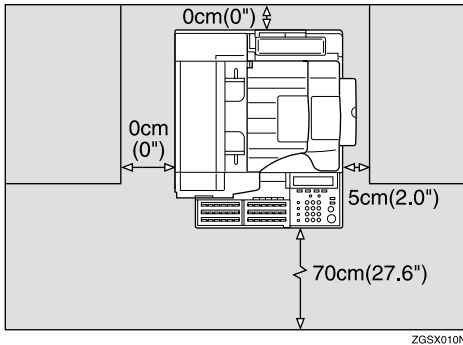

ZGSX010N

- Front: 70cm (2.3ft.)
- Back: 0cm (0.0 in.)
- Left side: 0cm (0.0 in.)

### Note

- A working space of at least 30cm (1.0ft.) is necessary to install the optional Bypass Tray Unit, clear jammed paper, or replace the toner cartridge.

- Right: 5cm (2.0 in.)

### Note

- A working space of at least 5cm (2.0 in.) is necessary to send 11"×17" size documents by fax or install the optional Printer Interface.

## Connecting the Power and Switching On

### ⚠ **WARNING:**

- **Connect the power cord directly into a wall outlet and never use an extension cord.**
- **Disconnect the power plug (by pulling the plug, not the cable) if the power cable or plug becomes frayed or otherwise damaged.**
- **Turn off the power and disconnect the power plug (by pulling the plug, not the cable) if any of the following occurs:**
  - **You spill something into the machine.**
  - **You suspect that your machine needs service or repair.**
  - **The external housing of your machine has been damaged.**

### ⚠ **CAUTION:**

- **When you disconnect the power plug from the wall outlet, always pull the plug (not the cable).**

**1** Plug in the cable to the outlet.

**2** Turn the power switch on.

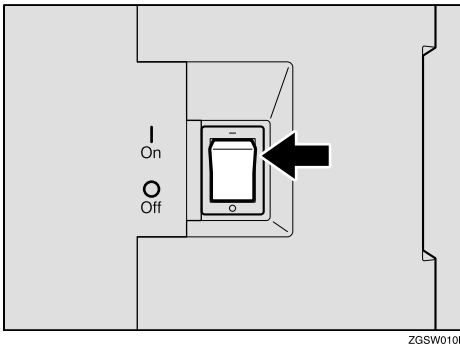

### ⚡ **Important**

- Voltage must not fluctuate more than 10%.
- The supply from the outlet must not fluctuate more than 12V above or below 120V.
- The power cord should not be laid where it might trip somebody.
- Do not place anything on the power cord.
- If you must use an extension cord, make sure that it is capable of carrying 120V / 8A, and that your facsimile terminal is the only piece of equipment connected to that cord.



## Moving the Machine

### **⚠ CAUTION:**

- *Unplug the power cord from the wall outlet before you move the machine. While moving the machine, you should take care that the power cord will not be damaged under the machine.*
- If you are moving the machine to a distant location such as another floor or building, contact your service representative. Note that the moving service is a paid service.
- If the distance to the new location is short, move the machine yourself, following the precautions described below.
  - Make sure that the memory level indicated on the display is 100% before unplugging the power cord.
  - Make sure to unplug the power cord from the electrical outlet by holding the power plug.
  - Make sure to close the ADF cover, ADF unit, and side cover.
  - Make sure to move the machine carefully, keeping the machine horizontal at all times. Shaking the machine or tilting it to a large degree may cause the machine to malfunction.
- After changing the location of the machine, check the contents of the following information registered to the machine. If any of the information is incorrect, register the correct information again.
  - If the fax number is changed  
Own Fax Number See p.55 "Own Name/Fax Header/Own Fax Number", <Basic Features>, p.189 "G3 Analog Line", and p.202 "Transfer Report".
  - If the Own Name such as company name is changed  
Fax Header See p.55 "Own Name/Fax Header/Own Fax Number", <Basic Features>.

## Disposing of the Machine

Contact your service representative when you wish to dispose of the machine.

### **⚠ WARNING:**

- ***Disposal can take place at our authorized dealer.***

### **⚠ CAUTION:**

- *For environmental reasons, do not dispose of the machine or expended supply waste at household waste collection points. Disposal can take place at an authorized dealer.*

# Connecting to a Telephone Line

## Connecting the Machine to the Telephone Line

### ⚠ CAUTION:

- To reduce the risk of fire, use only No. 26 AWG or larger telecommunication line cord.

### ⚠ ATTENTION:

- Pour réduire le risque d'incendie, utiliser uniquement des conducteurs de télécommunications 26 AWG ou de section supérieure.

To connect the machine to a telephone line, use a snap-in modular type connector.

### ❖ Connector Location

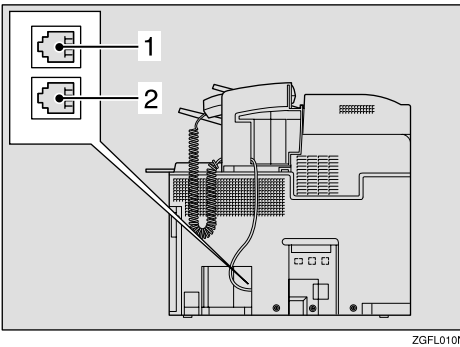

**1. LINE1: Telephone line connection**

**2. TEL1: For the optional handset or external telephone**

### ❖ Connecting to the Telephone Line

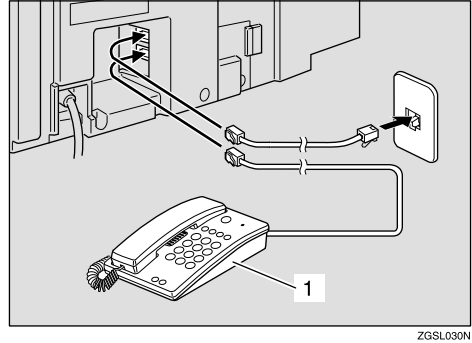

### 1. Or the optional Handset

#### ⚠ Important

- By law in the United States, you must program your phone number identification (your Own Fax Number) into your machine before you can connect the public phone system. See p.55 "Own Name/Fax Header/Own Fax Number", <Basic Features>.
- Do not connect the G3 analog line to the G4 socket.

#### 📝 Note

- Connect the optional Handset or external telephone to the "TEL1" socket.

## Connecting to an Additional G3 Line

You can connect the machine to two G3 lines by installing the optional Extra G3 Interface Unit. Connect the additional G3 line to the "LINE2" socket.

### Important

- Contact your service representative when connecting to the additional G3 line.

### Connecting Location

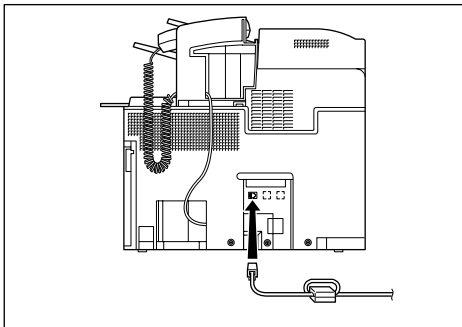

ZGFP210N

## ISDN

You can connect to ISDN by installing the optional ISDN Unit. Connect the ISDN cable that comes with the ISDN Unit to the "ISDN" socket.

### Important

- Contact your local service representative when connecting to ISDN.

### Connecting Location

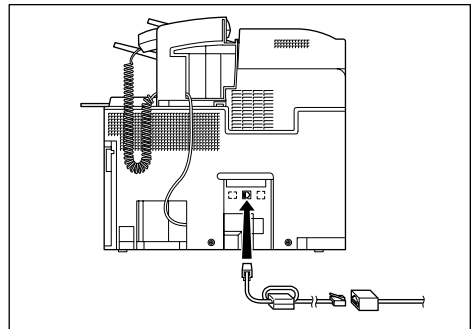

ZGFP220N

## Connecting an External Telephone

You can connect an external telephone as well as the optional Handset to the machine to make or receive calls.

### Note

- Depending on the type of external telephone, it cannot be connected or some of its functions are not available.

## Connecting the Optional Handset

### Installing the Optional Handset

**1** Fix the handset holder to the manual pocket using an item such as a small coin.

**Important**

Do not screw in screws too tightly. Doing so may damage the handset holder or manual pocket.

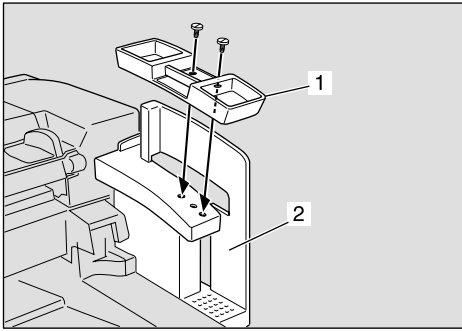

- 1. Handset holder
- 2. Manual pocket

**2** Place the handset on the handset holder, and feed the handset cord through the center of the manual pocket.

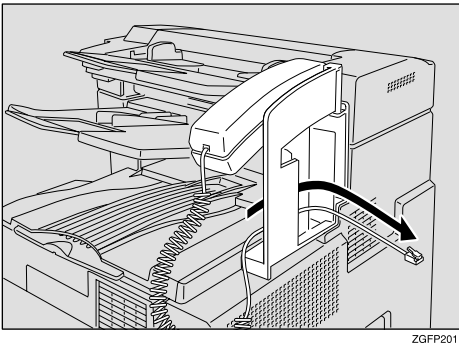

**3** Plug the handset jack into the "TEL1" socket.

## Setting up the Optional Handset

❖ **Selecting the line type**

Set the line type switch to the appropriate position.  
Tone Dialing: TT  
Pulse Dialing: DP

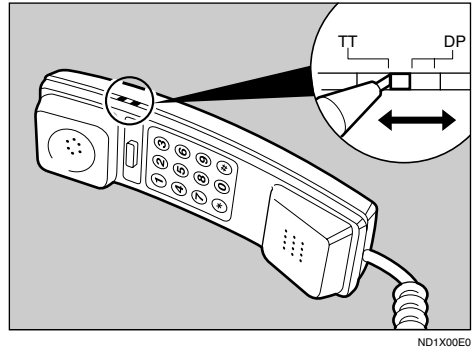

❖ **Adjusting the ringing tone volume**

Adjust the ringing tone volume using the volume switch on the handset as shown below.

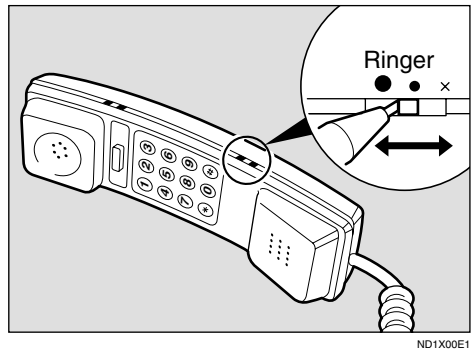

❖ **Adjusting the receiver volume**

Adjust the receiver volume with the volume switch on the handset as shown below.

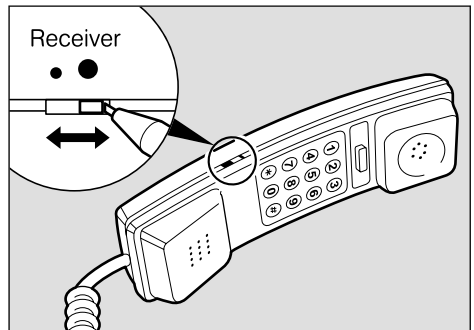

# Supplies

## ❖ Toner Cartridge

One toner cartridge can print approximately 10,000 sheets (ITU-T #1Chart).

Product Name	Color	Purchase Unit
Toner Cartridge	Black	1 pack

## ❖ Maintenance Units

The ADF maintenance kit should be replaced after feeding approximately 30,000 sheets of originals.

The fusing maintenance unit should be replaced after printing approximately 60,000 sheets of paper.

Product Name	Content	Purchase Unit
ADF Maintenance Kit	<ul style="list-style-type: none"> <li>• Feed unit</li> <li>• Separation corona</li> </ul>	1 box
Fusing Maintenance Unit	<ul style="list-style-type: none"> <li>• Fusing unit</li> <li>• Transfer roller</li> <li>• Gloves</li> </ul>	1 box

## ❖ Stamp Cartridge

One stamp cartridge can stamp approximately 3,000 times.

Product Name	Color	Purchase Unit
Stamp Cartridge	Pink	1 pack (4 pieces)

# Options

---

## 40MB Memory Card

---

Following features are enhanced when you install the Optional 40MB Memory Card:

- Increasing the number of documents that you can store in the machine's memory
- Using the TX/RX File Save function (necessary to install Optional Function Upgrade Unit)
- Setting the Resolution to Extra Super Fine when copying, and printing the received messages

### ❖ Optional 40MB Memory Card

You can expand the memory size from the standard 7MB to 40MB. The number of documents that you can store in the machine's memory increases to approximately 1,200 sheets. <sup>\*1</sup>

<sup>\*1</sup> Assuming that the standard originals are stored with the following settings: Resolution "Standard", Density "Standard", Halftone "OFF".

### ! Limitation

- You cannot install the Optional 40MB Memory Card and optional Fax On Demand Unit at the same time.

### 📝 Note

- The Optional 40MB Memory Card must be installed by a service representative.

## Function Upgrade Unit

Optional Function Upgrade Unit enables you to use the TX/RX File Save function. (It is necessary to install the Optional 40MB Memory Card at the same time.) The unit also expands the functions listed below.

Function	Without Function Upgrade Unit	Function Upgrade Unit Installed
Box	150 Boxes	400 Boxes
Group	9 Groups	30 Groups
Memory Transmission	1,200 Sheets of Originals* <sup>1</sup>	3,000 Sheets of Originals* <sup>1</sup>
Auto Document	144 Documents	244 Documents
Programming	144	244
Communication Record in Memory	250	1,000
Speed Dial	100 Destinations	1,000 Destinations
TX/RX File Save	Not Available	Available* <sup>1</sup>

The Optional 40MB Memory Card is necessary.\*<sup>1</sup>

## Fax On Demand Unit

The optional Fax On Demand Unit enables you to use the fax information service.

### Limitation

- You cannot install the optional Fax On Demand Unit and Optional 40MB Memory Card at the same time. You cannot use the two options alternately by replacing one with the other.

### Note

- The optional Fax On Demand Unit must be installed by a service representative.

---

## Extra G3 Interface Unit

---

The optional Extra G3 Interface Unit enables you to connect the machine to another G3 line in addition to the standard connection to a G3 line.

---

## ISDN Unit

---

You can connect to ISDN and use the functions listed below by installing the optional ISDN Unit.

Function	Reference
Sub-address	p.82 "Sub-address"
UUI	p.83 "UUI"

---

## Handset

---

### ❖ Handset

You can make or receive calls by installing the optional Handset and dialing manually (See p.88 "Manual Dial").

---

## NIC FAX Unit (Option for Type1)

---

The NIC FAX Unit (Option for Type1) enables you to send fax messages as e-mail to another fax machine or send them to a personal computer. You can also receive such e-mail from another fax machine.

The NIC FAX Unit (Option for Type1) enables you to connect the machine to a LAN environment and use the following functions:

- **Internet Fax Function**  
Enables you to send or receive fax messages as e-mail through the Internet. The other end must be a fax machine of the same model or compatible to TIFF-F format. Your machine can also receive fax messages sent as e-mail, or send them to a personal computer.
- **IP-Fax Function**  
Enables message transmission and reception between fax machines that are directly connected to a network that uses TCP/IP.
- **LAN FAX Function**  
Enables you to send a document made using a PC application software from your machine to other fax machines through a telephone line. Your machine must be connected to a PC through a LAN network.
- **Scanner Function**  
Enables you to scan documents and send them to a folder in a network server such as ScanRouter V2 Lite server or send it as an attachment to an e-mail. Scanning in color is also possible.



**Note**

- ❑ Type2 is equipped with the NIC FAX Unit in standard.

**Reference**

See NIC FAX Unit manual for detailed information.

---

## Printer Interface Unit

---

The Printer Interface enables you to connect the machine to a personal computer and use it as a printer. It also enables you to connect the machine to a LAN environment and use it as a network printer.

**Reference**







See the Optional Printer Interface Unit manual for detailed information.

---







## Other Options

---

**❖ Optional Paper Tray Unit**

You can load up to 500 sheets of 8<sup>1</sup>/<sub>2</sub>"×11"   or 8<sup>1</sup>/<sub>2</sub>"×14"  size paper (Adjustable to A3 , A4  , and A5 ). You can use the Specified Tray function by installing the optional Paper Tray Unit. See p.220 "Specified Tray").

**❖ Optional Bypass Tray Unit**

You can load paper of standard sizes such as A3 , B4 , A4 , 11"×17" , 8<sup>1</sup>/<sub>2</sub>"×14" , and 8<sup>1</sup>/<sub>2</sub>"×11"  .

You can also use custom size paper of 100 to 297mm (3.9 to 11.7 in.) in width and 148 to 432mm (5.8 to 17.0 in.) in length when making copies or using the machine as a printer.

You can load paper up to 100 sheets (8<sup>1</sup>/<sub>2</sub>"×11" or smaller size) or 10 sheets (larger than 8<sup>1</sup>/<sub>2</sub>"×11" size).

**❖ Optional Counter Unit**

This is a tamper-proof mechanical counter whose reading cannot be changed by the user.

# Specifications

## ❖ Power supply:

120V, 60Hz

## ❖ Power consumption \*1:

Energy Saver Mode:	Average 2W or less (Type1)
	Average 6W or less (Type2)
Standby Mode:	Average 30W or less
Transmission:	Average 45W or less
Reception:	Average 450W or less
	Maximum 1000W
Copying:	Average 400W or less
	Maximum 1000W

\*1 When no Option is installed.

## ❖ Noise Emission

### Sound Power Level

	Mainframe Only
During Printing	63 db(A) or less
During Copying	64 db(A) or less
Standby	40 db(A) or less

### Sound Pressure Level \*1

	Mainframe Only
During Printing	57 db(A) or less

The above measurements made in accordance with ISO 7779 are actual values.

\*1 It is measured at the position of the operator.

## ❖ Protocol:

G3, G4 (optional ISDN Unit required)

### ❖ Transmission time:

G3: Less than 3 seconds at 33,600 bps (JBIG coding)

G4: Less than 2 seconds at 64 kbps (MMR coding)

#### Note

- The values above are measured when sending an A4 size original with standard resolution (G3: 8×3.85 lines/mm (200×100dpi) with JBIG coding, G4: 200×100dpi with MMR coding) with Memory Transmission. They indicate the time spent on transmission, and do not include the time spent on communication control. The actual transmission time varies depending on the type of original, make of fax machine on the other end, and condition of the telephone line.

### ❖ Data compression:

MH, MR, MMR, JBIG

### ❖ Modulation method

Message Modem	V.34, V.17, V.29, V.27ter (G3), V.33 (G3 non-standard)
Protocol Modem	V.21, V.8 (G3)

### ❖ Transmission speed:

G3:

33,600/31,200/28,800/26,400/24,000/21,600/19,200/16,800/14,400/12,000/  
9,600/7,200/4,800/2,400 bps.

G4: 64 kbps/56 kbps

### ❖ Scanning resolution:

G3

- Standard: 8×3.85 lines/mm (200×100dpi)
- Detail: 8×7.7 lines/mm (200×200dpi)
- Fine: 8×15.4 lines/mm (200×400dpi)
- Super Fine: 16×15.4 lines/mm (400×400dpi)
- Extra Super Fine: 24×23.1 lines/mm (600×600dpi) (Optional 40MB Memory Card required when in reception)

G4

- Standard: 200×100dpi
- Detail: 200×200dpi
- Super Fine: 400×400dpi
- Extra Super Fine: 600×600dpi (Optional 40MB Memory Card required when in reception)

## Copying

- Standard: 200×100dpi
- Detail: 200×200dpi
- Super Fine: 400×400dpi
- Extra Super Fine: 600×600dpi (Optional 40MB Memory Card required)

## Reference

Chapter 9, "Specifications" in the NIC FAX Unit manual

### ❖ Print Process

Printing on standard paper using the laser

### ❖ Dimensions (Width×Depth×Height):

Type1: 505×609×615mm (19.9×24.0×24.2 in.)

Type2: 505×609×480mm (19.9×24.0×18.9 in.)

### ❖ Weight:

Type1: 40.5kg (89.2 lb.) or less

Type2: 28.6kg (63.0 lb.) or less

## Acceptable Types of Originals

Make sure your originals are completely dry before placing them in the machine. Originals containing wet ink or correcting fluid will mark the scanner and affect the resulting image.

### Acceptable Original Sizes

Where Original is Placed	Acceptable Original Size	Maximum Number of Sheets	Paper Thickness
Automatic Document Feeder (ADF)	<ul style="list-style-type: none"> <li>• Maximum: 304×600mm (12.0×23.6 in.)</li> <li>• Minimum: 148×105mm (5.8×4.1 in.)</li> </ul>	<ul style="list-style-type: none"> <li>• 11"×17" 30 sheets</li> <li>• 8<sup>1</sup>/<sub>2</sub>"×14" 40 sheets</li> <li>• 8<sup>1</sup>/<sub>2</sub>"×11" 75 sheets</li> </ul>	60–90g/m <sup>2</sup> , 16 to 24 lb. paper (0.05 to 0.2mm)
Original Bypass Tray	<ul style="list-style-type: none"> <li>• Maximum: 304×1200mm (12.0×47.2 in.)</li> <li>• Minimum: 148×105mm (5.8×4.1 in.)</li> </ul>	1 sheet	50–120g/m <sup>2</sup> , 13 to 32 lb. paper (0.05–0.3mm)

### Note

- ❑ When making a copy or sending a fax message of an original whose length exceeds 11"×17" size, set the original on the original bypass tray one sheet at a time, supporting it with your hand.

## Paper Size and Scanned Area

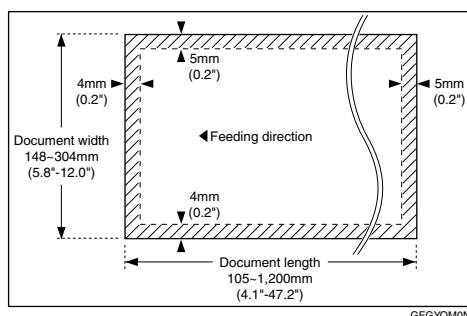

The part shaded will not be scanned, because it is outside the maximum scanning width range.

### Note

- ❑ Images at the edges of the original document (top 5mm (0.2 in.), bottom 4mm (0.2 in.), left 4mm (0.2 in.), right 5mm (0.2 in.)) may not be scanned even if you set a standard sized original properly.
- ❑ There may be some difference in size between the image scanned by your machine and the image printed at the receiving end.
- ❑ If the width of paper loaded in the other party's fax machine is smaller than that of your original, your document image is automatically reduced to fit the loaded paper at the time of transmission. See p.93 "Auto Reduction"
- ❑ When scanning an original, the machine detects the size of the original in the following manner. When the original is set on the automatic document feeder (ADF), the machine scans the original and if that original's width is less than approximately 230mm (9.1 in.), it assumes that the original is 8<sup>1</sup>/<sub>2</sub>"×11" or 8<sup>1</sup>/<sub>2</sub>"×14" size width. And if the width is between 242mm (9.5 in.) and 261mm (10.3 in.), it assumes the original to be B4 size, and 274mm (10.8 in.) or more, 11"×17" size width. The length of scanning range varies depending on this size judgement, and the maximum is 600mm (23.6 in.).

## Paper

It is recommended that you use your supplier's paper for the best printing results.























- You can use paper of equivalent thickness to your supplier's paper.

### Recommended Paper Sizes and Types

The recommended sizes, types and sheets of paper that you can load in the machine are described below.

#### Important

- Follow the precautions listed below when storing paper.
  - Avoid storing it in direct sunlight.
  - Store it in a dry place (humidity 70% or lower).
  - Store it on a level surface.
  - Once you open a package, store the remaining sheets in a plastic bag so that the paper does not absorb moisture.
- Paper that has absorbed moisture is often curled and may cause paper jams. Load this kind of paper face down.

Where Paper is Loaded	Paper Sizes	Paper Capacity	Paper Type
Main Paper Tray	8 <sup>1</sup> / <sub>2</sub> "×11"   or 8 <sup>1</sup> / <sub>2</sub> "×14"  (Adjustable to A3  , A4  , 11"×17"  8 <sup>1</sup> / <sub>4</sub> "×13"  , 8"×13"  )	500 sheets 250 sheets (11"×17"  )	Ordinary high quality paper (60–90g/m <sup>2</sup> , 16 to 24lb.)
Optional Paper Tray Unit	8 <sup>1</sup> / <sub>2</sub> "×11"   or 8 <sup>1</sup> / <sub>2</sub> "×14"  (Adjustable to A3  , A4  , and A5  )	500 sheets	
Optional Bypass Tray Unit	Standard size: A3  , B4  , A4  , 11"×17"  , 8 <sup>1</sup> / <sub>2</sub> "×14"  , and 8 <sup>1</sup> / <sub>2</sub> "×11"   Custom size: Width 100 to 297mm (3.9 to 11.7 in.), Length 148 to 432mm (5.8 to 17.0 in.)	<ul style="list-style-type: none"> <li>• 8<sup>1</sup>/<sub>2</sub>"×11" or smaller: 100 sheets</li> <li>• Larger than 8<sup>1</sup>/<sub>2</sub>"×11": 10 sheets</li> <li>• Postcard: 40 sheets</li> </ul>	<ul style="list-style-type: none"> <li>• Ordinary high quality paper (60–90g/m<sup>2</sup>, 16 to 24 lb.)</li> <li>• OHP transparencies</li> <li>• Adhesive label</li> <li>• Postcards</li> </ul>

 **Note**

- You can load only custom sized paper to the optional Bypass Tray Unit when making copies or using the PC Printing function (option).
- Load OHP transparencies to the optional Bypass Tray Unit one sheet at a time, and remove it from the paper tray immediately after the copying is complete.
- Load postcards in landscape orientation () in the optional Bypass Tray Unit.

---

**Non-recommended Paper**

---

Do not use the paper listed below. Using these kinds of paper may cause paper jams.

- Curled, wavy, creased or dog-eared paper
- Torn paper
- Paper with holes
- Paper with an unsmooth surface
- Paper with an slippery surface
- Thin and soft paper

 **Important**

- The printed image may not be clear if the surface of the paper is rough.
- Do not use any paper with coating, such as thermo-sensitive paper, art paper, aluminum foil, carbon paper, or conductive paper. Using such paper may result in malfunction.

## Energy Saving

### Introduction

When your fax machine prints fax messages, it uses heat to fix the image on paper. This heat is generated using a heating roller which must be hot enough to fuse toner to the paper properly. Because keeping the roller hot all the time consumes electricity, this machine is provided with an Energy Saver Mode in which the heating roller is heated to full temperature only when a message needs to be printed.

Two available types of Energy Saver Mode are described in the table below.

Energy Saver Mode	Machine status in Energy Saver Mode	How long before you can print after exiting Energy Saver Mode	Power consumption in Energy Saver Mode <sup>*1</sup>
Fax Standby (Heater half-cool)	The message "Currently the machine is in Energy Saver Mode." appears on the display. The machine maintains the heater in the preheated mode.	Within about 35 seconds	Type1: 30W Type2: 30W
Energy Saving Standby (Heater off)	The message "Currently the machine is in Energy Saver Mode." appears on the display. The power of the heater is turned off.	Within about 52 seconds	Type1: 2W <sup>*2</sup> Type2: 6W <sup>*3</sup>

<sup>\*1</sup> When options are not installed.

<sup>\*2</sup> 3.5W when the Optional ISDN Unit is installed. 6W when the NIC FAX Unit (Option for Type1) is installed.

<sup>\*3</sup> 7.5W when Optional ISDN Unit is installed.

Values vary according to options installed and settings of User Parameters.

In Energy Saving Standby mode, letting the heating roller cool to room temperature will reduce the amount of electricity the fax machine consumes. However, the fax machine will not print incoming messages right away, it will store them in memory and print them out after the roller warms up.

In Fax Standby mode, letting the heating roller cool halfway reduces the amount of electricity the fax machine consumes, but not as much as letting it cool to room temperature. On the other hand, since warming up takes only a short time, incoming fax messages can be printed right away.



 **Note**

- ❑ You can still send fax messages stored in memory while the machine is in Energy Saver Mode.
- ❑ Even in Energy Saving Standby mode, indicators that blink or light during communication or reception still work. When the Substitute Reception, Memory Lock or Confidential message indicator lights, exit Energy Saver Mode and take appropriate action.
- ❑ You can specify High Temperature Standby mode in combination with either Energy Saver Standby mode or Fax Standby mode. If High Temperature Standby mode is turned on, the machine starts a new print job in less time than the wait time described in the table above, provided it is initiated within the time specified with User Parameters (switch 31 bits 7,6) after the previous print job is complete. You can make necessary settings with User Parameters. See p.178 “User Parameters” (switch 05 bit 3).
- ❑ You can specify the duration of time before the machine exits High Temperature Standby mode with User Parameters. See p.178 “User Parameters” (switch 31 bits 7,6).
- ❑ While the Night Timer is activated, the machine stays in the Energy Saver Standby mode. If a fax message comes in while the heater is turned off, it is stored in the machine's memory (Substitute Reception), and printed after the specified time is reached. See p.176 “Night Timer”.

---

**Entering Energy Saver Mode**

---

The machine enters Energy Saver Mode when:

- Nobody uses the machine for about 5 minutes.
- The user holds down the **[Clear Modes/Energy Saver]** key for about 2 seconds.

 **Note**

- ❑ If you wish to change the five minute period to one or three minutes, or if you do not want your machine to enter the Energy Saver Mode automatically, please contact your service representative.

**When the machine does not enter Energy Saver Mode**

The machine does not enter Energy Saver Mode when:

- The optional Handset is not placed correctly
- The main paper tray is not loaded into the machine
- Either the ADF unit, ADF cover or the side cover is open.
- An original is jammed
- The machine is out of order
- There is no paper loaded into either the main paper tray or the optional Paper Tray Unit

---

## Exiting Energy Saver Mode

---

Your machine exits Energy Saver Mode when a fax is received.

To exit Energy Saver Mode manually:

- In Energy Saving Standby mode, press the **【Clear Modes/Energy Saver】** key.
- In Fax Standby mode, press any key.
- Place an original.
- Pick up the optional Handset.
- Pull out the main paper tray.
- Open the ADF unit or ADF cover.
- Open the side cover.

---

## Selecting the Energy Saver Mode type

---

To select the Energy Saver Mode type, adjust the bit switch below with User Parameters. See p.178 “User Parameters” (switch 05 bit 6).

### ❖ Switch 05 Bit 6

- Energy Saving Standby: To let the heating roller cool to room temperature, set bit 6 to 0.
- Fax Standby: To let the heating roller cool halfway set bit 6 to 1.

---

## Reception in Energy Saver Mode

---

Once in Energy Saver Mode, you can still receive messages. When a message is received, the machine prints it and returns to Energy Saver Mode.

# Maximum Values

The following table describes the maximum value for each item.

Item	Standard	With options installed
Memory	7MB	40MB
The number of pages that you can store in memory (Using ITU-T #1Chart, Resolution: Standard, Original Type: Halftone Off)	approximately 560 pages	approximately 1,200 <sup>*1</sup> /3,000 pages <sup>*2</sup>
Total number of Memory Transmission files	500	
The number of destinations you can specify for one file	250	
Total number of destinations that you can specify for all files	500	2,000
The number of Quick Dials you can register	144	
The number of Speed Dials you can register	100	1,000 <sup>*3</sup>
The number of Group Dials you can register	9	30 <sup>*3</sup>
The number of destinations you can specify by the number keys	100	1,000 <sup>*3</sup>
The number of destinations you can register in a Group	250	
The number of programs you can register	144	244 <sup>*3</sup> (100 files are registered to Speed Dial codes.)
The number of User Codes you can register	150	400 <sup>*3</sup>
The number of digits for Dials	254	
The number of Auto Document files	144	244 <sup>*3</sup> (100 files are registered to Speed Dial codes.)
The number of communication results that can be displayed	250	1,000
The number of communication records that you can store in memory	250	1,000
The number of Specified Senders you can register or add	50	

\*1 When the Optional 40MB Memory Card is installed

\*2 When the Optional 40MB Memory Card and optional Function Upgrade Unit are installed

\*3 When the optional Function Upgrade Unit is installed

# INDEX

## A

---

Accessing the Key Operator Tools, 171  
Adjusting the Display Contrast, 151  
Adjusting the Printing Density, 124  
Authorized Reception, 217  
Authorized Reception, Setup, 218  
Auto Discriminate, 91  
Auto Document, 99  
Automatic Redial, 105  
Auto Reduction, 93

## B

---

Backup File Transmission, 102  
Backup File Transmission Settings, 243  
Batch Original Documents Transmission, 96  
Batch Transmission, 105  
Blank Sheet Detect, 101  
Box File Manager Functions, 67  
Box Settings, 245  
Broadcasting  
    *Checking Progress*, 104  
Broadcasting Sequence, 104

## C

---

Canceling a Transmission or Reception, 35  
Center Mark, 120  
Chain Dial, 75  
Changing  
    *Paper Size*, 269, 271, 273  
Changing a destination, 41  
Changing the Transmission Time, 40  
Checkered Mark, 120  
Checking and Canceling Transmission Files, 35  
Checking and Editing a File, 38  
Checking Destinations (Destination List), 39  
Checking the Reception Result (RX Status), 45  
Checking the Transmission Result, 103  
Checking the Transmission Result  
    (TX Status), 44  
Cleaning the Copy Paper Transport  
    Mechanism, 277  
Cleaning the Document Transport  
    Mechanism, 275

Cleaning the Registration Roller, 279  
Communication Failure Report, 103, 108  
Communication Information, 35  
Communication Result Report  
    (Memory Transmission), 107  
Communication Result Report  
    (Polling Reception), 21  
Confidential File Report, 47  
Confidential ID, 199  
Connecting the Power and Switching On, 284  
Connecting to a Telephone Line, 286  
Copying, 127  
Counters, 134

## D

---

Date/Time, 151  
Deleting a Keystroke Program, 143  
Deleting an Auto Document, 147  
Deleting Entries, 209  
Deleting Fax On Demand Documents, 162  
Deleting Files, 66  
Deleting forwarding addresses, 228  
Deleting Information Boxes, 253  
Deleting Information Box Messages, 71  
Deleting Personal Boxes, 250  
Deleting Specified Senders, 216, 219, 223,  
    236, 239  
Deleting Transfer Boxes, 258  
Disk File Search List, 65  
Disk File Visual List, 65  
Displaying the Files in Memory, 56  
Display Language, 135  
Document Feeder  
    *Acceptable originals*, 296  
Dual Access, 105  
Duplex Original Settings, 94

## E

---

ECM (Error Correction Mode), 105  
Economy Transmission, 175  
End Receiver, 28, 114  
Energy Saving, 300  
Error Codes, 265

## F

---

- Fax Header, 32
- Fax Mode (Auto Receive Mode), 113
- Fax On Demand, 160
- Fax On Demand Recorded Messages, 166
- Fax Reset Timer, 152
- File Reserve Report
  - (Memory Transmission), 107
- File Reserve Report (Polling Reception), 21
- File Retention, 201
- Forwarding, 223
- Forwarding Mark, 224
- Free Polling Transmission, 22, 23

## G

---

- G3, 90
- G3 Analog Line, 189
- G3 Digital Line, 192
- G4, 91
- G4 Digital Line, 194
- General, 109
- Group Dial List, 149

## H

---

- Handset
  - Installation*, 288
- Handy Dialing Functions, 75

## I

---

- ID Override Polling Transmission, 23
- ID Reception, 119
- ID Transmission, 94
- Image Rotation, 122
- Immediate Reception, 109
- Immediate Transmission Result Report, 103
- Information Boxes, 251
- IP-Fax Parameter Settings, 204

## J

---

- Jams, Clearing, 261
- JBIG Reception, 119
- JBIG Transmission, 102
- Journal, 50, 53, 149

## K

---

- Key Layout, 205
- Key Operator Settings, 171
- Keystroke Program, 139
- Keystroke Program List, 149

## L

---

- Label, 98
- Label Insertion, 98
- Language Selection, 135
- Loading Paper, 267

## M

---

- Machine Environment, 281
- Maintaining, 267
- Manual Dial, 88
- Manuals for This Machine, 3
- Memory Card, 290
- Memory File Transfer, 207
- Memory Lock, 233
- Memory Lock ID, 199
- Memory Reception, 110
- More Transmission Functions, 103
- Multi-copy Reception, 120, 214
- Multi-step Transfer, 115
- Multi-step Transfer Group Settings, 136

## N

---

- Network Settings, 204
- Night Timer, 176
- No Document, No Dial, 100
- Noise Emission, 294

## O

---

- On Hook Dial, 85
- On Hook Timer, 153
- Other Transmission Features, 75
- Output density, 124

## P

---

- PABX, 91
- Page Separation and Length Reduction, 123
- Paper, 267, 268
- Paper Specifications, 298
- Parallel Memory Transmission, 105
- Personal Boxes, 246
- Polling ID, 199
- Polling Reception, 19
- Polling Transmission, 22
- Polling Transmission Clear Report, 25
- Power, 284
- Printed Reports, 107
- Printing
  - Center Mark*, 120
  - Checked Mark*, 120
- Printing a Confidential Message, 46
- Printing a List of Files in Memory (Print TX File List), 43
- Printing a Memory-locked Message, 48
- Printing a Stored Message, 37
- Printing Fax On Demand Documents, 164
- Printing Files, 65
- Printing Functions, 120
- Printing Information Box Messages, 70
- Printing Options
  - Center Mark*, 120
  - Checked Mark*, 120
  - CIL Print*, 123
  - TID Print*, 124
  - TSI Print*, 123
- Printing Personal Box Messages, 67
- Printing the Box List, 259
- Printing the Fax On Demand Access Report, 165
- Printing the Fax On Demand List, 165
- Printing the Journal, 50, 53
- Printing the Specified Sender List, 217, 220, 223, 236, 239, 241
- Print Position, 206
- Program/Delete, 136
- Programming and Changing an Auto Document, 145

## Q

---

- Quick Dial List, 149

## R

---

- RDS (Remote Diagnostic System), 212
- Reception Features, 109
- Reception Functions, 114
- Reception Time, 121
- Redial, 77
- Reduced Image Transmission, 26
- Registering Auto Document, 145
- Registering/Editing Fax On Demand Documents, 160
- Registering/Editing Information Boxes, 251
- Registering/Editing Personal Boxes, 247
- Registering/Editing Transfer Boxes, 255
- Registering ID Codes, 199
- Remote Transfer, 116
- Remote Transfer with UUI, 118
- Replacing the Stamp Cartridge, 280
- Reports, 103
  - Error Report*, 264
  - Power Failure Report*, 264
  - Reading Reports*, 264
- Reports/Lists, 149
- Requesting Party, 28, 114
- Re-sending a file, 40
- Reset PM Counter, 211
- Rotate Sort, 122

## S

---

- Scanner Cleaning Message, 101
- Scanning area, 297
- Searching Memory for Received Faxes, 62
- Searching Memory for Sent Faxes, 59
- Secured ID Override Polling
  - Transmission, 22
- Secured Polling Reception, 19, 20
- Secured Polling Transmission, 22, 23
- Selecting the Line, 89
- Selecting the Reception Mode, 113
- Sending a Fax Immediately, 104
- Sending Confidential Messages, 7
- Send Later, 5
- SEP Code Polling Reception, 16
- SEP Code Polling Transmission, 80
- Setting up Forwarding, 225
- Setting up Memory Lock, 234
- Setting up Multi-copy Reception, 214
- Setting up Specified Tray, 221
- Setting up TX/RX File Save, 237
- Setup, 151
- Simultaneous Broadcast, 104
- Solving Operation Problems, 261
- Specifications, 294
- Specified Tray, 220
- Specifying an End Receiver, 31
- Speed Dial List, 149
- Stamp, 93
- Stored ID Override Polling Reception, 19, 20
- Storing and Changing Keystroke
  - Programs, 139
- Storing Messages in Information Boxes, 69
- Sub-address, 82
- SUB Code Transmission, 78
- SUB Code Transmission with the Mode Key, 13
- Substitute Reception, 111
- Switches and Bits, 178
- System Parameter Transmission, 204
- System Settings, 175

## T

---

- Telephone Directory, 76
- Telephone Mode, 113
- Toner saving, 124
- Transfer Boxes, 254
- Transfer Report, 202
- Transfer Request, 28
- Transfer Result Report, 115
- Transfer Station, 28, 114
- Transmission Features, 93
- Transmission Mode, 5
- Transmission Result Report, 108
- TTI → Fax Header Print, 32
- Two In One, 121
- TX/RX File Save, 58
- TX/RX File Save Settings, 236

## U

---

- User Code Transmission, 10
- User Function Keys, 154
- User Parameter List, 179
- User Parameters, 178
- UUI, 83

MEMO



## Free Manuals Download Website

<http://myh66.com>

<http://usermanuals.us>

<http://www.somanuals.com>

<http://www.4manuals.cc>

<http://www.manual-lib.com>

<http://www.404manual.com>

<http://www.luxmanual.com>

<http://aubethermostatmanual.com>

Golf course search by state

<http://golfingnear.com>

Email search by domain

<http://emailbydomain.com>

Auto manuals search

<http://auto.somanuals.com>

TV manuals search

<http://tv.somanuals.com>