

4022/4027
Dsm622/Dsm627
LD122/LD127
Aficio™ 2022/2027

Operating Instructions General Settings Guide

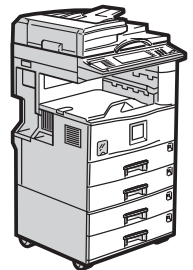

-
- 1** Getting Started
 - 2** Combined Function Operations
 - 3** Document Server
 - 4** User Tools (System Settings)
 - 5** Troubleshooting
 - 6** Remarks
 - 7** Entering Text
 - 8** Security
 - 9** Specifications

For safe and correct use of this machine, please be sure to read the Safety Information in this manual before you use it.

Download from [Www.Somanuals.com](http://www.Somanuals.com). All Manuals Search And Download.

Introduction

This manual describes detailed instructions on the operation and notes about the use of this machine. To get maximum versatility from this machine all operators are requested to read this manual carefully and follow the instructions. Please keep this manual in a handy place near the machine.

Important

Contents of this manual are subject to change without prior notice. In no event will the company be liable for direct, indirect, special, incidental, or consequential damages as a result of handling or operating the machine.



Notes:

Some illustrations in this manual might be slightly different from the machine.

Certain options might not be available in some countries. For details, please contact your local dealer.



Laser Safety:

CDRH Regulations

This equipment complies with requirements of 21 CFR subchapter J for class 1 laser products. This equipment contains two 5- milliwatt, 760-800 nanometer wavelength, two GaAIAs laser diodes. This equipment does not emit hazardous light, since the beam is totally enclosed during all customer modes of operation and maintenance.

Warning:

Use of controls or adjustment or performance of procedures other than those specified in this manual might result in hazardous radiation exposure.

Notes:

The model names of the machines do not appear in the following pages. Check the type of your machine before reading this manual. (For details, see P.15 "*Machine Types*".)

- Type 1: 4022/DSm622/LD122/Aficio 2022
- Type 2: 4027/DSm627/LD127/Aficio 2027
- Type 3: not available

Certain types might not be available in some countries. For details, please contact your local dealer.

Two kinds of size notation are employed in this manual. With this machine refer to the inch version.

For good copy quality, the supplier recommends that you use genuine toner from the supplier.

The supplier shall not be responsible for any damage or expense that might result from the use of parts other than genuine parts from the supplier with your office products.

Power Source

120V, 60Hz, 12A or more

Please be sure to connect the power cord to a power source as above. For details about power source, see P.134 "*Power Connection*".

Manuals for This Machine

The following manuals describe the operational procedures of this machine. For particular functions, see the relevant parts of the manual.

Note

- Manuals provided are specific to machine type.
- Adobe Acrobat Reader is necessary to view the manuals as a PDF file.
- Two CD-ROMs are provided:
 - CD-ROM 1 "Operating Instructions for Printer/Scanner"
 - CD-ROM 2 "Scanner Driver & Document Management Utilities"

❖ **General Settings Guide (this manual)**

Provides an overview of the machine and describes System Settings (paper trays, Key Operator Tools, etc.), Document Server functions, and troubleshooting.

Refer to this manual for Address Book procedures such as registering fax numbers, e-mail addresses, and user codes.

❖ **Network Guide (PDF file - CD-ROM1)**

Describes procedures for configuring the machine and computers in a network environment.

❖ **Copy Reference**

Describes operations, functions, and troubleshooting for the machine's copier function.

❖ **Facsimile Reference <Basic Features>**

Describes operations, functions, and troubleshooting for the machine's facsimile function.

❖ **Facsimile Reference <Advanced Features>**

Describes advanced functions and settings for key operators.

❖ **Printer Reference 1**

Describes system settings and operations for the machine's printer function.

❖ **Printer Reference 2 (PDF file - CD-ROM1)**

Describes operations, functions, and troubleshooting for the machine's printer function.

❖ **Scanner Reference (PDF file - CD-ROM1)**

Describes operations, functions, and troubleshooting for the machine's scanner function.

❖ **Manuals for DeskTopBinder V2 Lite**

DeskTopBinder V2 Lite is a utility included on the CD-ROM labeled "Scanner Driver & Document Management Utilities".

- DeskTopBinder V2 Lite Setup Guide (PDF file - CD-ROM2)
Describes installation of, and the operating environment for DeskTopBinder V2 Lite in detail. This guide can be displayed from the **[Setup]** display when DeskTopBinder V2 Lite is installed.
- DeskTopBinder V2 Lite Introduction Guide (PDF file - CD-ROM2)
Describes operations of DeskTopBinder V2 Lite and provides an overview of its functions. This guide is added to the **[Start]** menu when DeskTopBinder V2 Lite is installed.
- Auto Document Link Guide (PDF file - CD-ROM2)
Describes operations and functions of Auto Document Link installed with DeskTopBinder V2 Lite. This guide is added to the **[Start]** menu when DeskTopBinder V2 Lite is installed.

❖ **Manuals for ScanRouter V2 Lite**

ScanRouter V2 Lite is a utility included on the CD-ROM labeled "Scanner Driver & Document Management Utilities".

- ScanRouter V2 Lite Setup Guide (PDF file - CD-ROM2)
Describes installation of, settings, and the operating environment for ScanRouter V2 Lite in detail. This guide can be displayed from the **[Setup]** display when ScanRouter V2 Lite is installed.
- ScanRouter V2 Lite Management Guide (PDF file - CD-ROM2)
Describes delivery server management and operations, and provides an overview of ScanRouter V2 Lite functions. This guide is added to the **[Start]** menu when ScanRouter V2 Lite is installed.

❖ **Other manuals**

- PS3 Supplement (PDF file - CD-ROM1)
- Unix Supplement (Available from an authorized dealer, or as a PDF file on our Web site.)

What You Can Do with This Machine

The following introduces the functions of this machine, and the relevant manuals containing detailed information about them.

Products marked with * are optional. For details about optional products, see p.156 "Options", or contact your local dealer.

Copier, Facsimile, Printer, and Scanner Functions

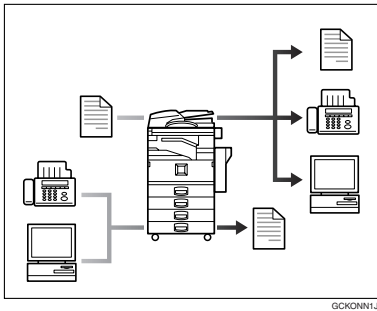

This machine provides copier, facsimile*, printer*, and scanner* functions.

- You can make copies of originals. With a finisher*, you can sort and staple copies. See *Copy Reference*.
- You can send originals by fax and receive faxes from other parties. See *Facsimile Reference <Basic Features>*, and *Facsimile Reference <Advanced Features>*.
- You can print documents created using applications. See *Printer Reference 1*, *Printer Reference 2*.
- You can scan originals and send the scan file to a computer. See *Scanner Reference*.

Utilizing Stored Documents

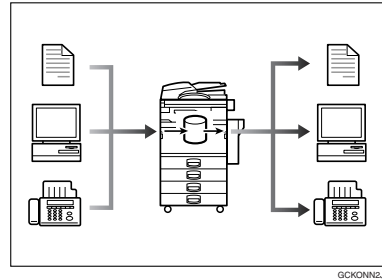

- You can store file from originals scanned by this machine, or file sent from other computers, into the machine's hard disk. You can print and fax stored documents as required. You can also change print settings and print multiple documents (Document Server). See p.35 "Using the Document Server".
- With DeskTopBinder V2 Professional*/Lite, you can search, check, print, and delete stored documents using your computer. You can also retrieve stored documents scanned in scanner mode. With File Format Converter*, you can even download documents stored in copy and printer functions to your computer. See *Network Guide*.

Paperless Fax Transmission and Reception

Reception

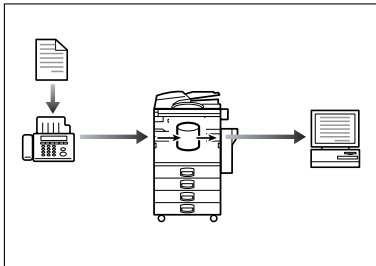

GCKONNSJ

- You can store received fax messages on the machine's hard disk, instead of printing them onto paper. You can use DeskTopBinder V2 Professional*/Lite or a Web browser to check, print, delete, retrieve, or download documents using your computer (Storing received documents). See *Facsimile Reference <Advanced Features>*.

Transmission

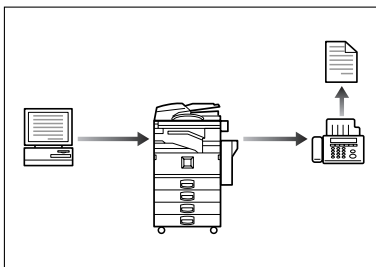

GCKONNSJ

- You can send documents created using applications to another party's fax machine directly, without performing a print job (LAN-Fax). See *Facsimile Reference <Advanced Features>*.

Fax Transmission and Reception Through the Internet

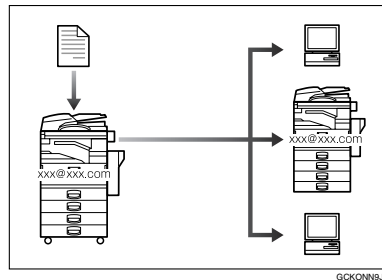

GCKONNSJ

You can send fax documents through e-mail by specifying the recipient's e-mail address (Internet Fax Transmission).

You can receive sent documents via Internet Fax, or from computers (Internet Fax Reception). See *Facsimile Reference <Basic Features>*

Using the Scanner in a Network Environment

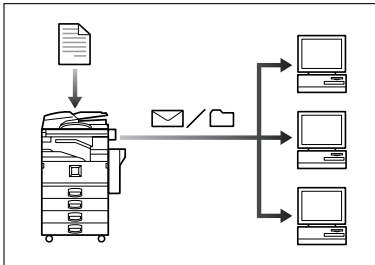

GCKONNSJ

- You can send scanned documents to other network computers using e-mail (Sending stored scan file by e-mail). See *Scanner Reference*.
- With ScanRouter V2 Professional*/Lite, you can save scanned documents in specified destinations on network computers (File storage). See *Scanner Reference*.
- You can send scanned documents to other network folders (Scan to Folder). See *Scanner Reference*

Administrating the Machine/Protecting Documents (Security Functions)

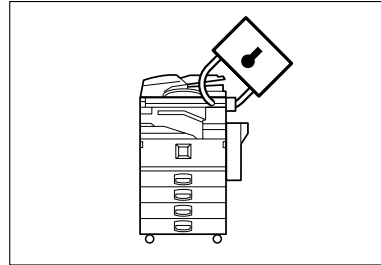

GCKONNSJ

The security functions protect documents from being copied without permission or unauthorized access via the network. See p.145 "Security".

◆ Security Functions

- Protecting stored documents (setting passwords)
- Protecting file remaining in memory
- Protecting against unauthorized access via phone line
- Authenticating administrator (setting the key operator code). See p.60 "Key Operator Code".

◆ Extended Security Function

By setting a password, documents are protected against unauthorized access. See p.60 "Extended Security".

Monitoring the Machine Via Computer

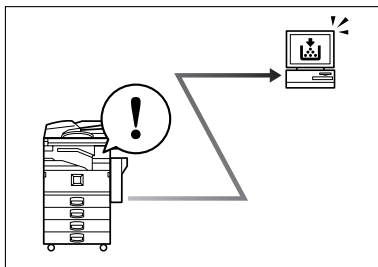

You can monitor machine status and change settings using a computer.

- Using SmartNetMonitor for Admin, SmartNetMonitor for Client, or a Web browser, you can use a computer to view the machine's status, such as to check on paper quantities, or misfeeds, etc. See *Network Guide*.
- You can also use a Web browser to make network settings. See *Network Guide*.
- You can also use a Web browser to register and manage items such as user codes, fax numbers, e-mail addresses, and folders in the Address Book. See the Web browser's Help.

TABLE OF CONTENTS

Manuals for This Machine	i
What You Can Do with This Machine	iii
Copier, Facsimile, Printer, and Scanner Functions	iii
Utilizing Stored Documents	iii
Paperless Fax Transmission and Reception	iv
Fax Transmission and Reception Through the Internet	iv
Using the Scanner in a Network Environment	v
Administrating the Machine/Protecting Documents (Security Functions)	v
Monitoring the Machine Via Computer	vi
Notice	1
Copyrights and Trademarks	3
Trademarks	3
Information about Installed Software	4
How to Read This Manual	9
Safety Information	10
Safety During Operation	10
Positions of Labels and Hallmarks for ⚠WARNING and ⚠CAUTION	12
ENERGY STAR Program	13
Machine Types	15

1. Getting Started

Guide to Components	17
External Options	19
Internal Options	20
Control Panel	21
Display Panel	23
Turning On the Power	24
Turning On the Main Power	24
Turning On the Power	24
Turning Off the Power	25
Turning Off the Main Power	25
Saving Energy	26

2. Combined Function Operations

Changing Modes	27
Multi-Access	29

3. Document Server





Relationship between Document Server and Other Functions	33
Document Server Display	34
Using the Document Server	35
Storing Data	35
Changing a Stored Document's File Name, User Name, or Password	38
Selecting a Document	38
Searching for Stored Documents	39
Printing Stored Documents	40
Deleting Stored Documents	43
Viewing Stored Documents Using a Web Browser	44
Downloading Stored Documents	44
Settings for the Document Server	45

4. User Tools (System Settings)

User Tools Menu (System Settings)	47
Accessing User Tools (System Settings)	50
Changing Default Settings	50
Exiting User Tools	50
Settings You Can Change with User Tools	51
General Features	51
Tray Paper Settings	55
Timer Settings	58
Key Operator Tools	59
Address Book	67
Registering Destination Information	68
Registering Sender Information	69
User Codes	70
Registering a New User Code	70
Changing a User Code	72
Deleting a User Code	73
Displaying the Counter for Each User Code	73
Printing the Counter for Each User Code	74
Clearing the Number of Prints	75
Fax Destination	76
Registering a Fax Destination	77
Changing a Registered Fax Destination	79
Deleting a Registered Fax Destination	81
E-mail Destination	82
Registering an E-mail Destination	82
Changing a Registered E-mail Destination	84
Deleting a Registered E-mail Destination	84
Registering Folders	85
Using SMB to Connect	85
Using FTP to Connect	89
Registering a Protection Code	93
Registering a Protection Code To a Single User	93
Registering a Protection Code To a Group User	94

Registering Destinations to a Group	95
Registering a New Group	95
Registering Destinations to a Group	96
Removing a Destination from a Group	96
Displaying Destinations Registered in Groups	97
Changing a Group Name	97
Deleting a Group	98
Registering the Transfer Request	99
Registering a Transfer Station/Receiving Station	99
Changing a Registered Transfer Station/Receiving Station	101
Deleting a Registered Transfer Station/Receiving Station	102
Programming/Changing LDAP Server	103
Programming an LDAP Server	103
Changing an LDAP Server	105

5. Troubleshooting

If Your Machine Does Not Operate As You Want.....	107
General	107
Document Server	109
 Loading Paper	110
Loading Paper into Paper Trays	110
Loading Paper into Large Capacity Tray (optional).....	111
 Adding Toner.....	113
Removing Toner.....	114
Inserting Toner.....	115
 Clearing Misfeeds	116
Changing the Paper Size.....	122
Changing the Paper Size of the Paper Tray	122
 Adding Staples.....	125
500-Sheet Finisher	125
1000-Sheet Finisher.....	126
Removing Jammed Staples	128
500-Sheet Finisher	128
1000-Sheet Finisher.....	129

6. Remarks

Dos and Don'ts.....	131
Toner	132
Handling Toner.....	132
Toner Storage	132
Used Toner	132
Where to Put Your Machine	133
Machine Environment	133
Moving.....	134
Power Connection	134
Access to the Machine	135

Maintaining Your Machine	136
Cleaning the Exposure Glass.....	136
Cleaning the Exposure Glass Cover.....	136
Cleaning the Auto Document Feeder.....	136
Replacing the Photo Conductor Unit (PCU)	137
Other Functions	140
Inquiry	140
Changing the Display Language.....	140
Counter	141
Displaying the Total Counter	141

7. Entering Text

Entering Text	143
Available Characters	143
Keys	143
How to Enter Text	144

8. Security

Security.....	145
Primary Security Functions	145
Extended Security Function	145
Temporarily Disabling Document Security	147
Operating Environment and Notes.....	148
Operating Environment	148
For Administrator.....	148
For User	149

9. Specifications

Main Unit.....	151
Options	156
Exposure Glass Cover	156
Auto Document Feeder	156
500-Sheet Finisher.....	157
1000-Sheet Finisher.....	158
Shift Sort Tray	159
Duplex Unit.....	159
Bypass Tray	160
Bridge Unit	160
Internal Tray 2 (1 bin tray).....	160
Large Capacity Tray.....	161
Paper Tray Unit.....	161
Copy Paper	163
Recommended Paper Sizes and Types.....	163
Envelopes	166
Unusable Paper	169
Paper Storage.....	169

INDEX.....	170
-------------------	------------

Notice

Notice To Wireless LAN Interface (option) Users

Notes to users in the United States of America

Notice:

This equipment has been tested and found to comply with the limits for a Class B digital device, pursuant to Part 15 of the FCC Rules. These limits are designed to provide reasonable protection against harmful interference in a residential installation. This equipment generates, uses and can radiate radio frequency energy and, if not installed and used in accordance with the instructions, may cause harmful interference to radio communications. However, there is no guarantee that interference will not occur in a particular installation. If this equipment does cause harmful interference to radio or television reception, which can be determined by turning the equipment off and on, the user is encouraged to try to correct the interference by one more of the following measures:

- Reorient or relocate the receiving antenna.
- Increase the separation between the equipment and receiver.
- Connect the equipment into an outlet on a circuit different from that to which the receiver is connected.
- Consult the dealer or an experienced radio/TV technician for help.

This device complies with part 15 of the FCC Rules.

Operation is subject to the following two conditions:

(1) This device may not cause harmful interference, and (2) this device must accept any interference received, including interference that may cause undesired operation.

Warning

Changes or modifications not expressly approved by the party responsible for compliance could void the user's authority to operate the equipment.

Note to users in Canada

Note:

This Class B digital apparatus complies with Canadian ICES-003.

Operation is subject to the following two conditions:

(1) This device may not cause interference, and (2) this device must accept any interference, including interference that may cause undesired operation of the device.

IEEE 802.11b Interface Kit Type B:

This device complies with RSS-210 of Industry Canada.

The term "IC:" before the certification/registration number only signifies that the Industry Canada technical specifications were met.

To prevent radio interference to the licensed service, this device is intended to be operated indoors and away from windows to provide maximum shielding. Equipment (or its transmit antenna) that is installed outdoors is subject to licensing.

To reduce potential radio interference to other users, the antenna type and its gain should be so chosen that the equivalent isotropically radiated power (EIRP) is not more than that required for successful communication.

This device has been designed to operate with an antenna having a maximum gain of [0.45] dBi. Antenna having a higher gain is strictly prohibited per regulations of Industry Canada. The required antenna impedance is [50] ohms.

Remarque concernant les utilisateurs au Canada

Avertissement:

Cet appareil numérique de la classe B est conforme à la norme NMB-003 du Canada.

L'utilisation de ce dispositif est autorisée seulement aux conditions suivantes: (1) il ne doit pas produire de brouillage et (2) l'utilisateur du dispositif doit être prêt à accepter tout brouillage radioélectrique reçu, même si ce brouillage est susceptible de compromettre le fonctionnement du dispositif.

IEEE 802.11b Interface Kit Type B:

Ce dispositif est conforme à la norme CNR-210 d'Industrie Canada.

L'expression «IC:» avant le numéro d'homologation/enregistrement signifie seulement que les spécifications techniques d'Industrie Canada ont été respectées.

Pour empêcher que cet appareil cause du brouillage au service faisant l'objet d'une licence, il doit être utilisé à l'intérieur et devrait être placé loin des fenêtres afin de fournir un écran de blindage maximal.

Si le matériel (ou son antenne d'émission) est installé à l'extérieur, il doit faire l'objet d'une licence.

Afin de réduire le risque d'interférence aux autres utilisateurs, le type d'antenne et son gain doivent être choisis de façon à ce que la puissance isotrope rayonnée équivalente (p.i.r.e.) ne soit pas supérieure au niveau requis pour obtenir une communication satisfaisante.

Ce dispositif a été conçu pour fonctionner avec une antenne ayant un gain maximal de [0.45] dBi. Une antenne ayant un gain plus élevé est strictement interdite par les règlements d'Industrie Canada. L'impédance d'antenne requise est [50] ohms.

Copyrights and Trademarks

Trademarks

Microsoft®, Windows® and Windows NT® are registered trademarks of Microsoft Corporation in the United States and/or other countries.

Acrobat® is a registered trademark of Adobe Systems Incorporated.

Bluetooth™ is a trademark of the Bluetooth SIG, Inc. (Special Interest Group) and is used by RICOH Company Limited under license.

Copyright ©2001 Bluetooth SIG, Inc.

The Bluetooth Trademarks are owned by Bluetooth SIG, Inc. USA

Other product names used herein are for identification purposes only and might be trademarks of their respective companies. We disclaim any and all right in those marks.

Other product names used herein are for identification purposes only and might be trademarks of their respective companies. We disclaim any and all right in those marks.

The proper names of the Windows operating systems are as follows:

- The product name of Windows® 95 is Microsoft® Windows® 95
- The product name of Windows® 98 is Microsoft® Windows® 98
- The product name of Windows® Me is Microsoft® Windows® Millennium Edition (Windows Me)
- The product names of Windows® 2000 are as follows:
Microsoft® Windows® 2000 Advanced Server
Microsoft® Windows® 2000 Server
Microsoft® Windows® 2000 Professional
- The product names of Windows® XP are as follows:
Microsoft® Windows® XP Professional
Microsoft® Windows® XP Home Edition
- The product names of Windows Server™ 2003 are as follows:
Microsoft® Windows Server™ 2003 Standard Edition
Microsoft® Windows Server™ 2003 Enterprise Edition
Microsoft® Windows Server™ 2003 Web Edition
- The product names of Windows® NT are as follows:
Microsoft® Windows NT® Server 4.0
Microsoft® Windows NT® Workstation 4.0

Information about Installed Software

Expat

- The software including controller, etc. (hereinafter "software") installed on this product uses the expat Version 1.95.2 (hereinafter "expat") under the conditions mentioned below.
- The product manufacturer provides warranty and support to the software of the product including the expat, and the product manufacturer makes the initial developer and copyright holder of the expat, free from these obligations.
- Information relating to the expat is available at:
<http://expat.sourceforge.net/>

Copyright © 1998, 1999, 2000 Thai Open Source Software Center, Ltd. and Clark Cooper.

Permission is hereby granted, free of charge, to any person obtaining a copy of this software and associated documentation files (the "Software"), to deal in the Software without restriction, including without limitation the rights to use, copy, modify, merge, publish, distribute, sublicense, and/or sell copies of the Software, and to permit persons to whom the Software is furnished to do so, subject to the following conditions:

The above copyright notice and this permission notice shall be included in all copies or substantial portions of the Software.

THE SOFTWARE IS PROVIDED "AS IS", WITHOUT WARRANTY OF ANY KIND, EXPRESS OR IMPLIED, INCLUDING BUT NOT LIMITED TO THE WARRANTIES OF MERCHANTABILITY, FITNESS FOR A PARTICULAR PURPOSE AND NONINFRINGEMENT. IN NO EVENT SHALL THE AUTHORS OR COPYRIGHT HOLDERS BE LIABLE FOR ANY CLAIM, DAMAGES OR OTHER LIABILITY, WHETHER IN AN ACTION OF CONTRACT, TORT OR OTHERWISE, ARISING FROM, OUT OF OR IN CONNECTION WITH THE SOFTWARE OR THE USE OR OTHER DEALINGS IN THE SOFTWARE.

NetBSD

1. Copyright Notice of NetBSD

For all users to use this product:

This product contains NetBSD operating system:

For the most part, the software constituting the NetBSD operating system is not in the public domain; its authors retain their copyright.

The following text shows the copyright notice used for many of the NetBSD source code. For exact copyright notice applicable for each of the files/binaries, the source code tree must be consulted.

A full source code can be found at <http://www.netbsd.org/>.

Copyright © 1999, 2000 The NetBSD Foundation, Inc.

All rights reserved.

Redistribution and use in source and binary forms, with or without modification, are permitted provided that the following conditions are met:

- ① Redistributions of source code must retain the above copyright notice, this list of conditions and the following disclaimer.
- ② Redistributions in binary form must reproduce the above copyright notice, this list of conditions and the following disclaimer in the documentation and/or other materials provided with the distribution.
- ③ All advertising materials mentioning features or use of this software must display the following acknowledgment:
This product includes software developed by The NetBSD Foundation, Inc. and its contributors.
- ④ Neither the name of The NetBSD Foundation nor the names of its contributors may be used to endorse or promote products derived from this software without specific prior written permission.

THIS SOFTWARE IS PROVIDED BY THE NETBSD FOUNDATION, INC. AND CONTRIBUTORS "AS IS" AND ANY EXPRESS OR IMPLIED WARRANTIES, INCLUDING, BUT NOT LIMITED TO, THE IMPLIED WARRANTIES OF MERCHANTABILITY AND FITNESS FOR A PARTICULAR PURPOSE ARE DISCLAIMED. IN NO EVENT SHALL THE FOUNDATION OR CONTRIBUTORS BE LIABLE FOR ANY DIRECT, INDIRECT, INCIDENTAL, SPECIAL, EXEMPLARY, OR CONSEQUENTIAL DAMAGES (INCLUDING, BUT NOT LIMITED TO, PROCUREMENT OF SUBSTITUTE GOODS OR SERVICES; LOSS OF USE, DATA, OR PROFITS; OR BUSINESS INTERRUPTION) HOWEVER CAUSED AND ON ANY THEORY OF LIABILITY, WHETHER IN CONTRACT, STRICT LIABILITY, OR TORT (INCLUDING NEGLIGENCE OR OTHERWISE) ARISING IN ANY WAY OUT OF THE USE OF THIS SOFTWARE, EVEN IF ADVISED OF THE POSSIBILITY OF SUCH DAMAGE.

Sablotron

Sablotron (Version 0.82) Copyright © 2000 Ginger Alliance Ltd. All Rights Reserved

a) The application software installed on this product includes the Sablotron software Version 0.82 (hereinafter, "Sablotron 0.82"), with modifications made by the product manufacturer. The original code of the Sablotron 0.82 is provided by Ginger Alliance Ltd., the initial developer, and the modified code of the Sablotron 0.82 has been derived from such original code provided by Ginger Alliance Ltd.

b) The product manufacturer provides warranty and support to the application software of this product including the Sablotron 0.82 as modified, and the product manufacturer makes Ginger Alliance Ltd., the initial developer of the Sablotron 0.82, free from these obligations.

c) The Sablotron 0.82 and the modifications thereof are made available under the terms of Mozilla Public License Version 1.1 (hereinafter, "MPL 1.1"), and the application software of this product constitutes the "Larger Work" as defined in MPL 1.1. The application software of this product except for the Sablotron 0.82 as modified is licensed by the product manufacturer under separate agreement(s).

d) The source code of the modified code of the Sablotron 0.82 is available at: <http://support-download.com/services/device/sablot/notice082.html>

e) The source code of the Sablotron software is available at: <http://www.ginger-all.com>

f) MPL 1.1 is available at: <http://www.mozilla.org/MPL/MPL-1.1.html>

Authors Name List

All product names mentioned herein are trademarks of their respective owners. The following notices are required to satisfy the license terms of the software that we have mentioned in this document:

- This product includes software developed by the University of California, Berkeley and its contributors.
- This product includes software developed by Jonathan R. Stone for the NetBSD Project.
- This product includes software developed by the NetBSD Foundation, Inc. and its contributors.
- This product includes software developed by Manuel Bouyer.
- This product includes software developed by Charles Hannum.
- This product includes software developed by Charles M. Hannum.
- This product includes software developed by Christopher G. Demetriou.
- This product includes software developed by Tools GmbH.
- This product includes software developed by Terrence R. Lambert.
- This product includes software developed by Adam Glass and Charles Hannum.
- This product includes software developed by Theo de Raadt.
- This product includes software developed by Jonathan Stone and Jason R. Thorpe for the NetBSD Project.
- This product includes software developed by the University of California, Lawrence Berkeley Laboratory and its contributors.
- This product includes software developed by Christos Zoulas.
- This product includes software developed by Christopher G. Demetriou for the NetBSD Project.
- This product includes software developed by Paul Kranenburg.
- This product includes software developed by Adam Glass.
- This product includes software developed by Jonathan Stone.
- This product includes software developed by Jonathan Stone for the NetBSD Project.
- This product includes software developed by Winning Strategies, Inc.
- This product includes software developed by Frank van der Linden for the NetBSD Project.
- This product includes software developed for the NetBSD Project by Frank van der Linden

- This product includes software developed for the NetBSD Project by Jason R. Thorpe.
- The software was developed by the University of California, Berkeley.
- This product includes software developed by Chris Provenzano, the University of California, Berkeley, and contributors.

JPEG LIBRARY

- The software installed on this product is based in part on the work of the Independent JPEG Group.

SASL

CMU libsas

Tim Martin

Rob Earhart

Rob Siemborski

Copyright © 2001 Carnegie Mellon University. All rights reserved.

Redistribution and use in source and binary forms, with or without modification, are permitted provided that the following conditions are met:

- ① Redistributions of source code must retain the above copyright notice, this list of conditions and the following disclaimer.
- ② Redistributions in binary form must reproduce the above copyright notice, this list of conditions and the following disclaimer in the documentation and/or other materials provided with the distribution.
- ③ The name "Carnegie Mellon University" must not be used to endorse or promote products derived from this software without prior written permission. For permission or any other legal details, please contact:

Office of Technology Transfer
Carnegie Mellon University
5000 Forbes Avenue
Pittsburgh, PA 15213-3890
(412) 268-4387, fax: (412) 268-7395
tech-transfer@andrew.cmu.edu

- ④ Redistributions of any form whatsoever must retain the following acknowledgment:

"This product includes software developed by Computing Services at Carnegie Mellon University (<http://www.cmu.edu/computing/>)."

CARNEGIE MELLON UNIVERSITY DISCLAIMS ALL WARRANTIES WITH REGARD TO THIS SOFTWARE, INCLUDING ALL IMPLIED WARRANTIES OF MERCHANTABILITY AND FITNESS, IN NO EVENT SHALL CARNEGIE MELLON UNIVERSITY BE LIABLE FOR ANY SPECIAL, INDIRECT OR CONSEQUENTIAL DAMAGES OR ANY DAMAGES WHATSOEVER RESULTING FROM LOSS OF USE, DATA OR PROFITS, WHETHER IN AN ACTION OF CONTRACT, NEGLIGENCE OR OTHER TORTIOUS ACTION, ARISING OUT OF OR IN CONNECTION WITH THE USE OR PERFORMANCE OF THIS SOFTWARE.

MD4

Copyright © 1990-2, RSA Data Security, Inc. All rights reserved.

License to copy and use this software is granted provided that it is identified as the "RSA Data Security, Inc. MD4 Message-Digest Algorithm" in all material mentioning or referencing this software or this function.

License is also granted to make and use derivative works provided that such works are identified as "derived from the RSA Data Security, Inc. MD4 Message-Digest Algorithm" in all material mentioning or referencing the derived work.

RSA Data Security, Inc. makes no representations concerning either the merchantability of this software or the suitability of this software for any particular purpose. It is provided "as is" without express or implied warranty of any kind.

These notices must be retained in any copies of any part of this documentation and/or software.

MD5

Copyright © 1991-2, RSA Data Security, Inc. Created 1991. All rights reserved.

License to copy and use this software is granted provided that it is identified as the "RSA Data Security, Inc. MD5 Message-Digest Algorithm" in all material mentioning or referencing this software or this function.

License is also granted to make and use derivative works provided that such works are identified as "derived from the RSA Data Security, Inc. MD5 Message-Digest Algorithm" in all material mentioning or referencing the derived work.

RSA Data Security, Inc. makes no representations concerning either the merchantability of this software or the suitability of this software for any particular purpose. It is provided "as is" without express or implied warranty of any kind.

These notices must be retained in any copies of any part of this documentation and/or software.

How to Read This Manual

Symbols

This manual uses the following symbols:

WARNING:

This symbol indicates a potentially hazardous situation that might result in death or serious injury if you misuse the machine by not following these instructions under this symbol. Be sure to read these instructions, all of which are included in the Safety Information section in the *General Settings Guide*.

CAUTION:

This symbol indicates a potentially hazardous situation that might result in minor or moderate injury or property damage not involving bodily injury, if you misuse the machine by not following these instructions under this symbol. Be sure to read the instructions, all of which are included in the Safety Information section in the *General Settings Guide*.

* The above statements are for your safety.

Important

If this instruction is not followed, paper might be misfed, originals damaged, or data lost. Be sure to read this.

Preparation

This symbol indicates the prior knowledge or preparation required before operation.

Note

This symbol indicates precautions for operation, or actions to take following mal-operation.

Limitation

This symbol indicates numerical limits, functions that cannot be used together, or conditions under which a particular function cannot be used.

Reference

This symbol indicates where further relevant information can be found.

[]

Keys that appear on the machine's display panel.

[]

Keys built into the machine's control panel.

Safety Information

When using this machine, the following safety precautions should always be followed.

Safety During Operation

In this manual, the following important symbols are used:

⚠ WARNING:
Indicates a potentially hazardous situation which, if instructions are not followed, could result in death or serious injury.

⚠ CAUTION:
Indicates a potentially hazardous situation which, if instructions are not followed, may result in minor or moderate injury or damage to property.

⚠ WARNING:

- **Connect the power cord directly into a wall outlet and never use an extension cord.**
- **Disconnect the power plug (by pulling the plug, not the cable) if the power cable or plug becomes frayed or otherwise damaged.**
- **To avoid hazardous electric shock or laser radiation exposure, do not remove any covers or screws other than those specified in this manual.**
- **Turn off the power and disconnect the power plug (by pulling the plug, not the cable) if any of the following occurs:**
 - **You spill something into the machine.**
 - **You suspect that your machine needs service or repair.**
 - **The external housing of your machine has been damaged.**
- **Do not incinerate spilled toner or used toner. Toner dust might ignite when exposed to an open flame.**
- **Disposal can take place at our authorized dealer.**
- **Dispose of the used toner bottle in accordance with the local regulations.**

 **CAUTION:**

- *Protect the machine from dampness or wet weather, such as rain and snow.*
- *Unplug the power cord from the wall outlet before you move the machine. While moving the machine, you should take care that the power cord will not be damaged under the machine.*
- *When you disconnect the power plug from the wall outlet, always pull the plug (not the cable).*
- *Do not allow paper clips, staples, or other small metallic objects to fall inside the machine.*
- *Keep toner (used or unused) and toner bottle out of the reach of children.*
- *For environmental reasons, do not dispose of the machine or expended supply waste at household waste collection points. Disposal can take place at an authorized dealer.*
- *The inside of the machine could be very hot. Do not touch the parts with a label indicating the "hot surface". Otherwise, an injury might occur.*

Positions of Labels and Hallmarks for ⚠️WARNING and ⚠️CAUTION

This machine has labels for ⚠️WARNING and ⚠️CAUTION at the positions shown below. For safety, please follow the instructions and handle the machine as indicated.

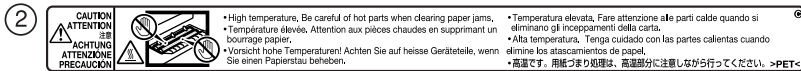
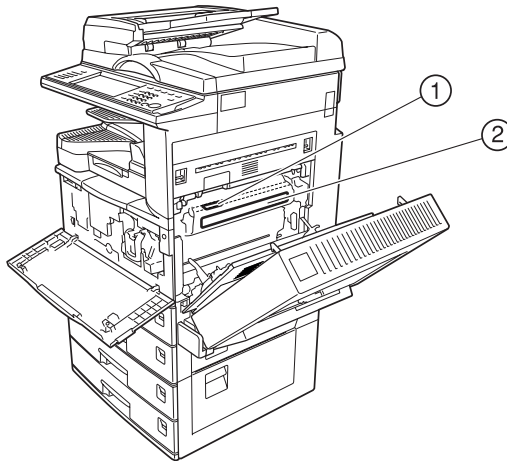

ZLEH010J

ENERGY STAR Program

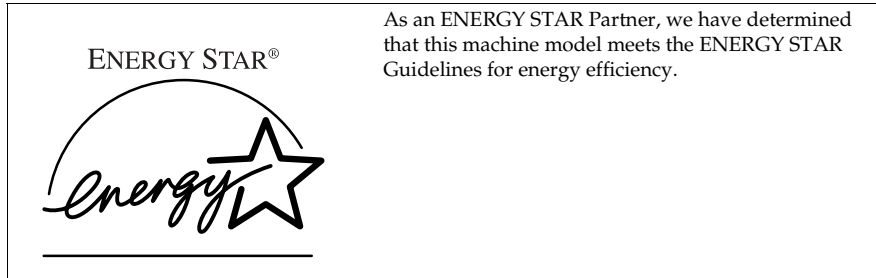

The ENERGY STAR Guidelines intend to establish an international energy-saving system for developing and introducing energy-efficient office equipment to deal with environmental issues, such as global warming.

When a product meets the ENERGY STAR Guidelines for energy efficiency, the Partner shall place the ENERGY STAR logo onto the machine model.

This product was designed to reduce the environmental impact associated with office equipment by means of energy-saving features, such as Low-power mode.

❖ **Low-Power mode and Off mode or Sleep mode**

This product automatically lowers its power consumption when it is not operated for a fixed time (standard setting time: 1 minute). This is called "Off mode" on a single function copying machine, and "Sleep mode" on a multiple function machine equipped with optional facsimile and printing functions.

- Off mode: Same as the condition when the operation switch is turned off.
- Sleep mode: Same as the condition when the operation switch is turned off. Receiving fax messages and printing from a computer are possible.

If you want to operate this product while it is in either of these modes, do one of the following:

- Turn on the operation switch.
- Place an original in the Auto Document Feeder (ADF).
- Lift and lower the exposure glass cover or the ADF.

The default interval before entering Off mode or Sleep mode can be adjusted. To change it, see p.58 "Auto Off Timer".

The ENERGY STAR Program establishes two modes which lower the power consumption of the product when it is not operated for a fixed time. These modes are the Low-power mode and the Off mode or Sleep mode. This product has only one mode, the Off mode or Sleep mode. This mode meets the requirements of both the Low-power mode and Off mode or Sleep mode. In this manual, the Off mode is called the Auto Off mode.

❖ Duplex Priority

The ENERGY STAR Program recommends the duplex function. By conserving paper resources this function is less of a burden to the environment. For applicable machines, duplex function (one-sided originals→ two-sided copies) is selected preferentially when the operation switch or the main power switch is turned on, the **[Energy Saver]** key is pressed, or the machine resets automatically.

🔍 Reference

To change the settings of the Duplex Priority mode, see “Duplex Mode Priority” in “General Features 2/4”, *Copy Reference*.

Specifications

Low- Power mode, Off Mode	Power consumption	6 W
	Default interval	1 minute
	Recovery time	10 seconds or less

Duplex Priority	1 Sided→2 Sided
-----------------	-----------------

❖ Recycled Paper

In accordance with the ENERGY STAR Program, we recommend use of environmentally friendly recycled paper. Please contact your sales representative for recommended paper.

Machine Types

This machine comes in three models which vary in copy speed. To ascertain which model you have, see the inside front cover.

	Type 1	Type 2	Type 3
Copy speed	22 copies/minute (A4, 8 ¹ / ₂ " × 11")	27 copies/minute (A4, 8 ¹ / ₂ " × 11")	32 copies/minute (A4, 8 ¹ / ₂ " × 11")

1. Getting Started

Guide to Components

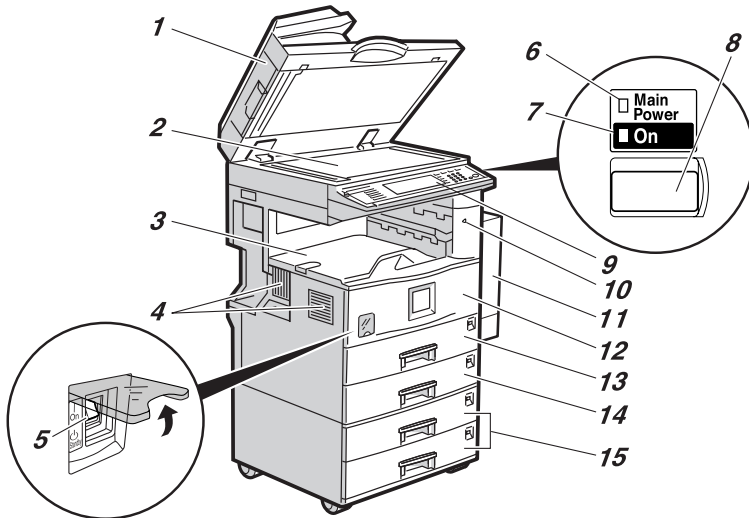

ZEWH010N

1. Exposure glass cover (optional) or Auto Document Feeder (ADF) (optional)

Lower the exposure glass cover over originals placed on the exposure glass. If you have the ADF, load a stack of originals here. They will be fed automatically, one by one.

(The illustration shows the ADF.)

2. Exposure glass

Place originals face down.

3. Internal tray

Copied, printed paper or fax messages are delivered here.

4. Ventilation holes

Prevents overheating. Do not obstruct the ventilation holes by placing anything near it or leaning objects against it. If the machine overheats, a fault might occur.

5. Main power switch

If the machine does not operate after turning on the operation switch, check the main power switch is turned on. If it is off, turn it on.

6. Main power indicator

This indicator lights when the main power switch is turned on, and goes off when the switch is turned off.

7. On indicator

This indicator lights when the operation switch is turned on, and goes off when the switch is turned off.

8. Operation switch

Press this switch to turn the power on (the **On** indicator lights up). To turn the power off, press this switch again (the **On** indicator goes off).

9. Control panel

See p.21 "Control Panel".

10. Remove Paper Indicator

The indicator lights when paper is delivered to the internal tray 2 (1 bin tray). When paper is removed from the internal tray 2, the indicator goes off.

Note

Internal tray 2 (1 bin tray) is optional.

11. Duplex unit (Unit for two-sided copies) (optional)

Makes two-sided copies.

See p.19 "External Options"

12. Front cover

Open to access the inside of the machine.

13. Paper tray

Load paper. See p.110 " Loading Paper".

14. Paper tray 2

Use when copying onto OHP transparencies, label paper (adhesive labels), translucent paper, postcards, envelopes and custom size paper. See p.110 " Loading Paper".

15. Paper tray unit (optional)

Load paper. See p.110 " Loading Paper", p.19 "External Options".

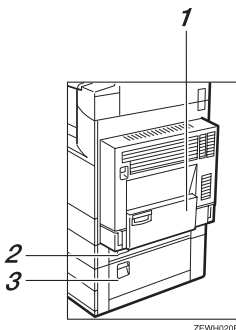

1. Bypass tray (optional)

See p.19 "External Options"

2. Paper tray cover

Open this cover to remove jammed paper.

3. Lower right cover

Open this cover to remove jammed paper.

External Options

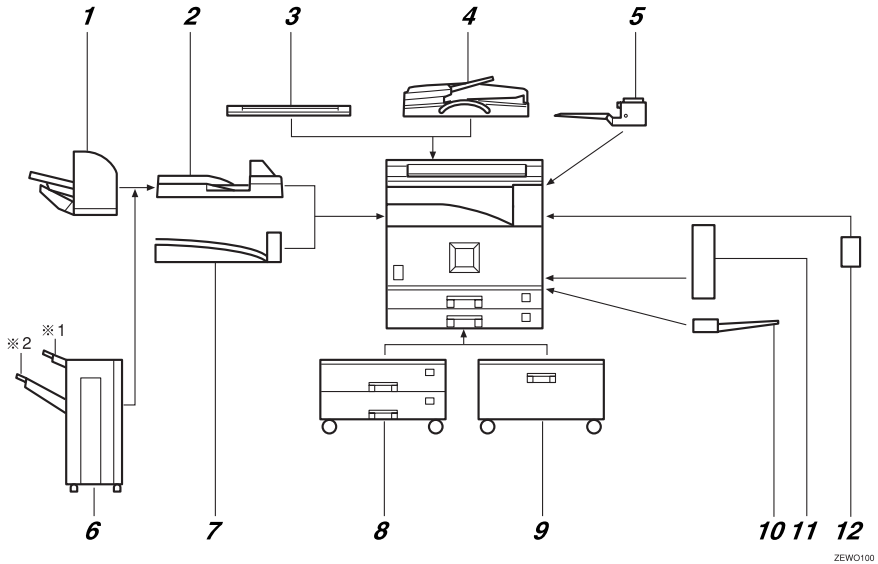

1. 500-sheet finisher ^{*1}

Sorts, stacks and staples copies.

2. Bridge unit

Relays copies to the finisher.

3. Exposure glass cover

Lower this cover over originals.

4. ADF

Load a stack of originals. They will feed in automatically.

5. Internal tray 2 (1 bin tray)

If you select this as the output tray, copies are delivered face down.

6. 1000-sheet finisher ^{*1}

Sorts, stacks and staples copies.

^{*1} : Finisher upper tray

^{*2} : Finisher shift tray

7. Shift sort tray

Sorts and stacks copies.

8. Paper tray unit

Consists of two paper trays.

9. Large Capacity Tray (LCT)

Holds up to 2000 sheets of paper.

10. Bypass tray

Use when copying onto OHP transparencies, label paper (adhesive labels), translucent paper, postcards, envelopes and custom size paper. See "Copying from the Bypass tray", *Copy Reference*.

11. Duplex unit

Use to make two-sided copies.

12. Inter change unit

Required when installing the internal tray 2 (1 bin tray) and duplex unit.

Internal Options

1

- ① HDD
Allows you to use the Document Server function.
- ② Fax unit
Allows you to use the facsimile function.
- ③ Printer/Scanner unit *²
Allows you to use the printer and scanner functions.
- ④ IEEE 1394 interface board *³
Connects to an IEEE 1394 cable.
- ⑤ Bluetooth *³
Allows you to expand the interface.
- ⑥ File Format Converter *³
Allows you to download documents from the Document Server stored by copier and printer functions. See p.44 "Downloading Stored Documents".
- ⑦ IEEE 802.1b Wireless LAN Board *³
You can install a wireless LAN interface.
- ⑧ USB 2.0 Interface Board *³
Allows you to connect a variety of external devices.
- ⑨ User account enhance unit
Allows you to increase the number of user codes.

 **Note**

You can install only one interface board from items ④ to ⑧.

*¹ You cannot install two finishers simultaneously.

*² The 128 MB memory and network board are included.

*³ You cannot install two or more of the options below:
IEEE 1394 interface board, IEEE 802.1b wireless LAN board, USB 2.0 Interface Board, Bluetooth, file format converter.

Control Panel

This illustration shows the control panel of a machine that has all options fully installed.

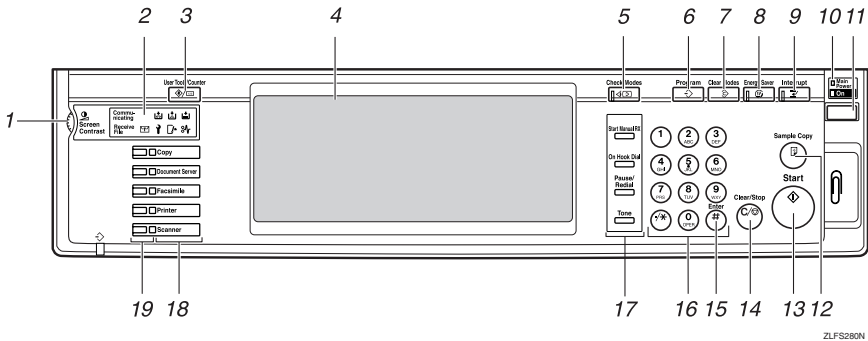

1. Screen contrast knob

Adjusts display panel brightness.

2. Indicators

Show errors and machine status.

- : Add Staple indicator. See p.125 "Adding Staples".
- : Add Toner indicator. See p.113 "Adding Toner".
- : Load Paper indicator. See p.110 "Loading Paper".
- : Service Call indicator
- : Open Cover indicator
- : Misfeed indicator. See p.116 "Clearing Misfeeds".
- : Data In indicator. See "Control Panel", *Printer Reference 1*.
- Communicating: Communicating indicator. See "Control Panel", *Facsimile Reference <Basic Features>*.
- : Confidential File indicator. See "Control Panel", *Facsimile Reference <Basic Features>*.
- Receiving File: Receiving File indicator. See "Control Panel", *Facsimile Reference <Basic Features>*.

3. [User Tools/Counter] key

- User Tools
Press to change defaults and conditions to meet your requirements. See p.50 "Accessing User Tools (System Settings)".
- Counter
Press to check or print the counter value. See p.141 "Counter".
- Inquiry
Press to check where to contact for machine repairs and ordering toner. See p.140 "Inquiry"

4. Display panel

Displays operation status, error messages, and function menus.

5. [Check Modes] key

Press to check settings.

6. [Program] key (copier/facsimile/scanner mode)

Press to register frequently used settings, or recall registered settings.

7. [Clear Modes] key

Press to clear previous copy job settings.

8. [Energy Saver] key

Press to switch to and from Energy Saver mode. See p.26 "Energy Saver Mode".

9. [Interrupt] key (copier/scanner mode)

Press to make interrupt copies during copying or scanning. See "Interrupt Copy", *Copy Reference*.

10. Main power indicator and On indicator

The main power indicator goes on when you turn on the main power switch.

The On indicator lights when the power is on.

Important

- Do not turn off the main power switch while the power indicator is lit or blinking. Doing so may damage the hard disk.

11. Operation switch

Press to turn the power on (the **On** indicator goes on). To turn the power off, press again (the **On** indicator goes off).

12. [Sample Copy] key

Press to make a single set of copies or prints to check print quality before making multiple sets.

13. [Start] key

Press to start copying. Start scanning or printing documents stored using the Document Server function.

14. [Clear/Stop] key

- Clear
Press to delete a number entered.
- Stop
Press to stop a job in progress, such as scanning, faxing, or printing.

15. [#] key

Press to enter after a numerical value.

16. Number keys

Use to enter the numbers for copies, fax numbers and data for the selected function.

17. [Start Manual RX] key, [On Hook Dial] key, [Pause/Redial] key, and [Tone] key**Reference**

Facsimile Reference <Basic Features>
and *Facsimile Reference <Advanced Features>*

18. Function keys

Press to select one of the following functions:

- Copy: 
- Document Server: 
- Facsimile: 
- Printer: 
- Scanner: 

19. Function status indicators.

These show the status of the above functions:

- Yellow: selected.
- Green: active.
- Red: interrupted.

Display Panel

The display panel shows machine status, error messages, and function menus.

Important

- A force or impact of more than 30 N (about 3 kgf) will damage the display panel.

The copying screen is displayed as default after power on.

The following display shows a machine with options fully installed.

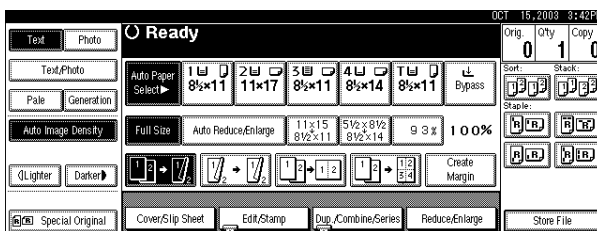

The function items displayed serve as selector keys. You can select or specify an item by lightly pressing them.

When you select or specify an item on the display panel, it is highlighted thus **Full Size**. Keys appearing as **OK** cannot be used.

Common key operations

The following keys are common to all screens:

◆ Key list

[OK]	Acknowledges a selected function or entered values, and then returns to the previous display.
[Cancel]	Deletes a selected function or entered values, and then returns to the previous display.
[▲Prev.] [▼Next]	Moves to the previous or next display when all items cannot be shown on the same display.
[OK] [Yes]	Closes displayed messages.
[Clear]	Cancels entered values but does not change the settings.
[Exit]	Returns to the previous display.

Turning On the Power

This machine has two power switches.

❖ Operation switch (right side of the control panel)

Press to activate the machine. When the machine has finished warming up, you can make copies.

❖ Main power switch (left side of the machine)

Turning off this switch makes the main power indicator on the right side of the control panel go off. When this is done, machine power is completely off.

When the fax unit (optional) is installed, fax files in memory may be lost if you turn this switch off. Use this switch only when necessary.

Note

- ❑ This machine automatically enters Energy Saver mode or turns itself off if you do not use it for a while. See p.58 "Auto Off Timer".

Turning On the Main Power

1 Make sure that the power cord is firmly plugged into the wall outlet.

2 Open the switch cover, and then turn on the main power switch.

The main power indicator goes on.

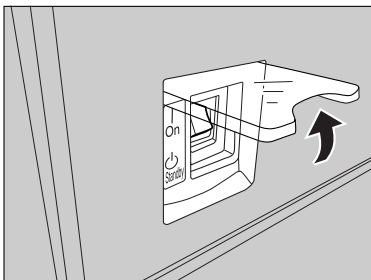

ZFFH250E

Important

- ❑ Do not turn off the main power switch immediately after turning it on. Doing so may result in damage to the hard disk or memory, leading to malfunctions.

Turning On the Power

1 Press the operation switch.

The **On** indicator goes on.

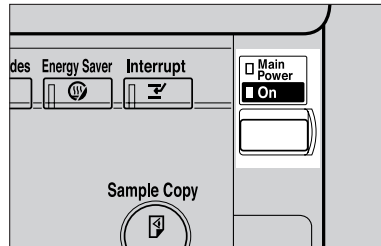

Note

- ❑ If the power does not come on when the operation switch is pressed, check the main power switch is on. If it is off, turn it on.

Turning Off the Power

- 1 Make sure the exposure glass cover or the ADF is in the right position.
- 2 Press the operation switch.
The On indicator goes out.

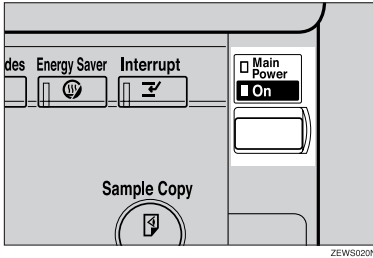

Note

- Even if you press the operation switch, the indicator does not go out, the blinks in the following cases:
 - When the exposure glass cover or ADF is open.
 - During communication with external equipment.
 - When the hard disk is active.

Turning Off the Main Power

Important

- Do not turn off the main power switch when the **On** indicator is lit or blinking. Doing so may result in damage to the hard disk or memory.
- Be sure to turn off the main power switch before pulling out the power plug. Not doing this may result in damage to the hard disk or memory.

- 1 Make sure the On indicator is not lit.
- 2 Open the switch cover, and then turn off the main power switch.
The main power indicator goes out.

When the fax unit (optional) is installed

When the main power switch is turned off while using the facsimile function, waiting fax and print jobs may be canceled, and incoming fax documents not received. If you have to turn off this switch for some reason, follow the procedure below.

Important

- Make sure 100% is shown as available memory on the display before turning off the main power switch or unplugging the power cord. Fax files in memory are deleted an hour after you turn off the main power switch or unplug the power cord. See "Power Failure Report", *Facsimile Reference <Advanced Features>*.
- The **On** indicator does not go out, but blinks in dial-in mode even if you press the operation switch. When this happens, check the explanations below, and turn off the main power switch.
 - The computer is not controlling the machine.
 - The machine is not receiving a fax.

Saving Energy

1

Energy Saver Mode

If you do not use the machine for a certain period after an operation, or when you press the **[Energy Saver]** key, the display disappears and the machine goes into Energy Saver mode. When you press the **[Energy Saver]** key again, the machine returns to the ready condition. The machine uses less electricity in Energy Saver mode.

Note

- You can change the amount of time the machine waits before switching to Energy Saver mode after copying has finished or the last operation is performed. See p.58 "Panel Off Timer".

Auto Off

The machine automatically turns itself off when the job is finished, after a certain period of time has elapsed. This function is called "Auto Off".

Note

- You can change the Auto Off time. See p.58 "Auto Off Timer".
- The Auto Off Timer function will not operate in the following cases:
 - When a warning message appears
 - When the service call message appears
 - When paper is jammed
 - When the cover is open
 - When the "Add Toner" message appears
 - When toner is being replenished
 - When the User Tools/Counter screen is displayed
 - When fixed warm-up is in progress
 - When the facsimile, printer, or other functions are active
 - When operations were suspended during printing
 - When the handset is in use
 - When the On-hook dialing function is in use
 - When a recipient is being registered in the address list or group dial list
 - When the Data In indicator is on or blinking
 - When the sample print or locked print screen is displayed

2. Combined Function Operations

Changing Modes

Note

- You cannot switch modes in any of the following situations:
 - When scanning in a fax message for transmission
 - During immediate transmission
 - When accessing User Tools
 - During interrupt copying
 - During On hook dialing for fax transmission
 - While scanning an original

- ❑ The copying screen is displayed as default after power on. You can change this default setting. See p.51 “Function Priority”.

2

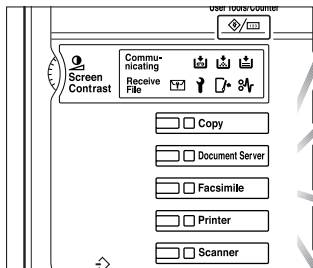

Copy Mode

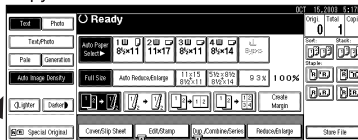

Document Server Mode

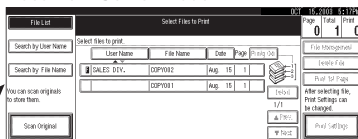

Facsimile Mode

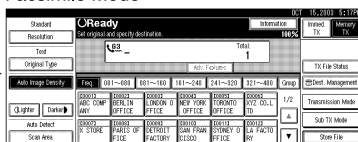

Printer Mode

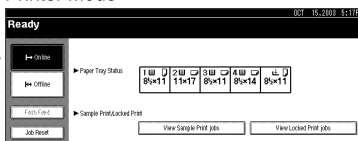

Scanner Mode



ZL-F5290N

System Reset

The machine returns automatically to its initial condition when the job is finished, after a certain period of time has elapsed. This function is called "System Reset".

Note

- ❑ You can change the System Reset time. See p.58 “System Auto Reset Timer”.

Multi-Access

You can carry out another job using a different function while the current job is being performed. Performing multiple functions simultaneously like this is called "Multi-accessing".

This allows you to handle jobs efficiently, regardless of how the machine is being used. For example:

- While making copies, you can scan documents to store in the Document Server.
- While printing documents stored in the Document Server, the machine can receive print data.
- You can make copies while receiving fax data.
- While printing print data, you can make operations for copying.

Note

- See p.52 "Print Priority" for setting function priority. As default, **[Display mode]** is set to first priority.
- When the Internal Tray 2 (1 bin tray), Shift Sort Tray, 500-sheet finisher, or 1000-sheet finisher is installed on the machine, you can specify the output tray where documents are delivered. For details about how to specify the output tray for each function, see the following descriptions:
 - p.53 "Output: Copier (copier)"
 - p.53 "Output: Document Server (Document Server)"
 - p.53 "Output: Facsimile (facsimile)"
 - p.53 "Output: Printer (printer)"

Function Compatibility

The chart shows Function Compatibility when print priority is set to "Interleave". See p.52 "Print Priority".

△: Simultaneous operations are possible.

●: Operation is enabled when the relevant function key is pressed and remote switching (of the scanner) is done.

○: Operation is enabled when the **[Interrupt]** key is pressed to interrupt the preceding operation.

→: Operation is performed automatically once the preceding operation ends.

×: The operation must be started once the preceding operation ends. (Simultaneous operations are not possible.)

Mode after you select		Copy			Interrupt Copying			Facsimile			Printer			Scanner			Document Server			DeskTopBinder V2 Professional/Lite			Web-Document Server		
		Operations for Copying	Stapling	Sort	Operations for Copying	Copying	Transmission Operation/Manual Reception Operation	Transmission	Memory Transmission	Immediate Transmission	Memory Reception	Printing Received Data	Data Reception	Printing	Stapling	Operations for Scanning	Scanning	Operations for Document Server	Scanning a Document to Store in Document Server	Printing from Document Server	Printing from Document Server	Sending a Facsimile from Document Server	Printing		
Copy	Operations for Copying	×	×	×	○	○	●	●	△	△	△	△	△	△	●	●	●	●	△	△	△	△	△	△	
	Stapling	△	→	→	○	○	●	●	△	●	△	△	△	△	→	●	●	●	●	→	△	△	△	△	
	Sort	△	→	→	○	○	●	●	△	●	△	△	△	△	●	●	●	●	→	△	△	△	△	△	
Interrupt Copying	Operations for Copying	○	○	○	×	×	×	×	×	×	△	△	△	△	×	×	×	×	×	×	△	△	△	△	
	Copying	○	○	○	×	×	×	×	×	×	△	△	△	△	→	△	△	△	△	△	△	△	△	△	
Facsimile	Transmission Operation/Manual Reception Operation	●	●	●	○	○	×	×	×	×	×	△	△	△	△	△	△	△	△	△	△	△	△	△	
	Scanning an original for Memory Transmission	×	×	×	×	×	×	×	△	×	△	△	△	△	△	×	×	×	×	×	×	△	△	△	
	Memory Transmission	△	△	△	△	△	△	△	△	△	△	△	△	△	△	△	△	△	△	△	△	△	△	△	
	Immediate Transmission	×	×	×	×	×	×	×	△	△	△	△	△	△	×	×	×	×	×	×	△	△	△	△	
	Memory Reception	△	△	△	△	△	△	△	△	△	△	△	△	△	△	△	△	△	△	△	△	△	△	△	
	Printing Received Data	△	△	△	△	△	△	△	△	△	△	△	△	△	△	△	△	△	△	△	△	△	△	△	
Printer	Data Reception	△	△	△	△	△	△	△	△	△	△	△	△	△	→	→	→	→	→	→	→	→	→	→	
	Sort Print	△	△	△	○	○	△	△	△	△	△	△	△	△	→	→	→	→	→	→	→	→	→	→	
	Stapling	△	→	△	○	○	△	△	△	△	△	△	△	△	→	→	→	→	→	→	→	→	→	→	
Scanner	Operations for scanning	●	●	●	○	○	●	●	△	●	△	△	△	△	△	×	×	●	●	●	△	△	△	△	
	Scanning	×	×	×	×	×	×	×	△	×	△	△	△	△	△	×	×	×	×	×	×	△	△	△	

Mode after you select		Copy			Interrupt Copying			Facsimile			Printer			
		Operations for Copying	Stapling	Sort	Operations for Copying	Copying	Transmission Operation/Manual Reception Operation	Transmission	Reception	Print	Scanner	Document Server	DeskTopBinder V2 Professional/Lite	Web-Document Server
Mode before you select		Operations for Copying	●	●	●	○	●	●	●	●	●	●	●	●
Document Server	Operations for Document Server	●	●	●	○	●	●	●	●	●	●	●	●	●
	Scanning a Document to Store in Document Server	●	×	×	○	●	×	△	×	△	△	△	△	△
	Printing from Document Server	●	→	→	○	△	△	△	△	△	△	△	△	△
DeskTopBinder V2 Professional/Lite	Printing from Document Server	△	△	△	△	△	△	△	△	△	△	△	△	△
	Sending a Facsimile from Document Server	△	△	△	△	△	△	△	△	△	△	△	△	△
WebDocument Server	Printing	△	△	△	△	△	△	△	△	△	△	△	△	→

*1 Simultaneous operations are only possible after the preceding job documents are all scanned and the **[Next Job]** key appears.

*2 You can scan a document after the preceding job documents are all scanned.

*3 When multiple lines are available, select a line which is currently not in use. Otherwise, operation will not be possible.

*4 During stapling, printing automatically starts after the current job.

*5 Stapling is not available.

*6 Simultaneous operations become possible after you press the **[Next Job]** key.

*7 During parallel receptions, any subsequent job is suspended until the receptions are completed.

● Limitation

- Stapling cannot be used at the same time for multiple functions.

 **Note**

- A machine with the 500-sheet finisher installed cannot accept other jobs while printing with the stapling operation.
- A machine with the 1000-sheet finisher installed, that is printing with the stapling operation on paper larger than A4 size, starts the subsequent job (for which Shift Sort Tray is specified as the output tray) only after the current print job finishes.
- While printing is in progress, scanning using another function may take more time.



3. Document Server

Relationship between Document Server and Other Functions

The following table describes the relationship between the Document Server and other functions.

function	Where to store documents	Displaying a list	Printing stored documents	Sending documents
Copy	Copy/Document Server	Available	Available	Not Available
Printer	Document Server	Available	Available	Not Available
Facsimile	Facsimile	Available	Available	Available ^{*1}
Scanner	Scanner	Not Available ^{*2}	Not Available	Available ^{*3}

^{*1} You can send stored documents using the facsimile function. See "Sending a Stored File", *Facsimile Reference <Advanced Features>*.

^{*2} You can display stored documents using the scanner function. See *Scanner Reference*.

^{*3} You can send stored documents using the scanner function. See *Scanner Reference*.

Note

□ The following table shows the capacity of the Document Server.

	Number of pages for each file	Number of files	Number of pages in total
Copy	1,000 pages	3,000 files	9,000 pages
Printer			
Scanner			
Facsimile			

Document Server Display

◆ Document Server Main Display

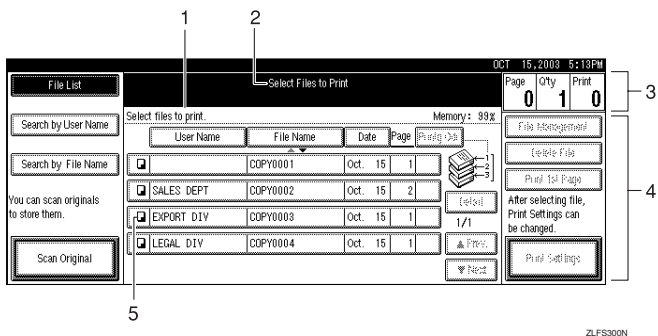

1. Operating status and messages.

2. The title of the currently selected screen.

3. The numbers of originals, copies, and printed pages.

4. The operation keys.

5. The functions under which the documents were stored.

The icons below show the functions active when the documents were stored in the Document Server.

Function	Copier	Facsimile	Printer	Scanner
Icon				--

Using the Document Server

Storing Data

❖ File name

Stored documents are automatically named "COPY0001", "COPY0002". You can change assigned file names.

❖ User name

You can register a user name to identify the user or user group that stored the documents. To assign it, you can register the user name using the name assigned to the user code, or by entering the name directly.

🔍 Reference

For details about user codes, see p.70 "User Codes".

❖ Password

You can set a password for stored documents, and use it to prevent others printing them. When a password is set for the documents,  appears next to the documents.

🔍 Reference

To store documents without using Document Server function, see the manuals for those modes.

⚠ Important

- ❑ Data stored in the machine might be lost if some kind of failure occurs. The manufacture shall not be responsible for any damage resulting from loss of data.

📝 Note

- ❑ Data stored in the Document Server is set to be deleted after three days (72 hours) by default. You can specify the period after which stored data is automatically deleted. See p.65 "Auto Delete File".
- ❑ If you do not want stored data to be automatically deleted, select **[No]** in Auto Delete File before storing a document. If you select **[Yes]** later, data stored after will be automatically deleted.

1 Press the **[Document Server]** key.

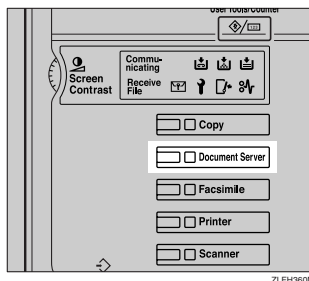

2 Press **[Scan Original]**.

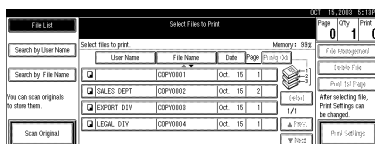

3 Enter a user name, file name, or password if necessary.

Note

If you do not enter a file name, one is automatically assigned.

Reference

p.36 "To register or change a user name"

p.37 "To change a file name"

p.37 "To set or change a password"

4 Place originals either on the exposure glass or in the ADF.

Reference

For information about types of originals and how to place them, see *Copy Reference*.

5 Make any required settings.

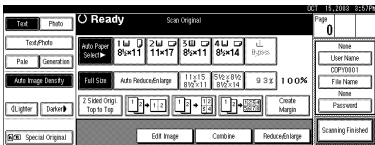

Reference

For details, see *Copy Reference*.

6 Press the **[Start]** key.

The document is stored in the Document Server.

Note

To stop scanning, press the **[Clear/Stop]** key. To restart a paused scanning job, press **[Continue]** in the confirmation display. To delete saved images and cancel the job, press the **[Stop]** key.

When a password is set, **1** appears on the left side of the file name.

If you placed originals on the exposure glass, press **[Scanning Finished]** after all the originals have been scanned. The Select Files to Print display appears.

To register or change a user name

1 Press **[Scan Original]**.

The scan original display appears.

2 Press **[User Name]**.

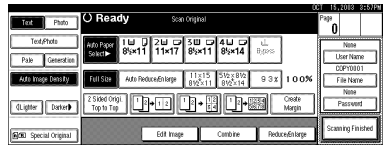

If user names are already registered, the Change User Name display appears. To use an unregistered user name, press **[Non-programed Name]**.

When no user name are registered in the Address Book, the User (Destination) Name entry display appears.

Reference

p.70 "User Codes"

When using a registered user name in the Address Book

1 Select a registered user name from the list, and then press **[OK]**.

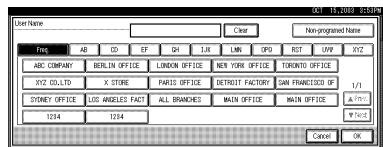

To change your user name to an unregistered user name, proceed to the next step.

Reference

p.70 "Registering a New User Code"

When using an unregistered user name in the Address Book

- 1 To enter an unregistered user name, press [**Non-programed Name**].
- 2 Enter a new user name, and then press [**OK**].

 **Reference**
p.143 "Entering Text"

When no user name has been registered in the Address Book

- 1 Enter a new user name, and then press [**OK**].

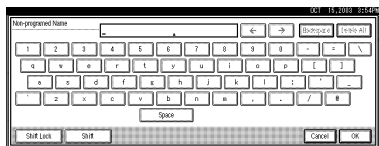

 **Reference**
p.143 "Entering Text"

To change a file name

- 1 Press [**Scan Original**].
The Scan Original display appears.

- 2 Press [**File Name**].

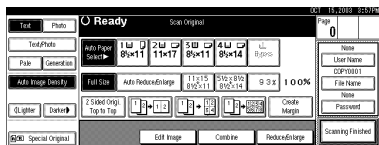

The Change File Name display appears.

- 3 Press [**Delete All**] to delete the old file name.

 **Note**
 You can also use [**Backspace**] to delete unnecessary characters.

- 4 Enter a new file name, and then press [**OK**].

 **Note**
 Up to 20 characters can be entered as a file name. Note that only 16 characters of each file name appear in the document list.

 **Reference**
p.143 "Entering Text"

To set or change a password

- 1 Press [**Scan Original**].
The Scan Original display appears.

- 2 Press [**Password**].

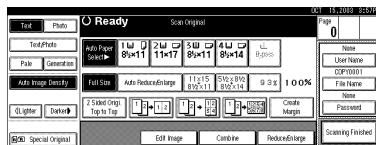

- 3 Enter a password using the number keys (four digits), and then press the [**#**] key.

- 4 Reenter the password (four digits) for verification, and then press the [**#**] key.

- 5 Press [**OK**].

Changing a Stored Document's File Name, User Name, or Password

- 1 Press the **[Document Server]** key.
- 2 Select the document with the user name, file name, or password you want to change.

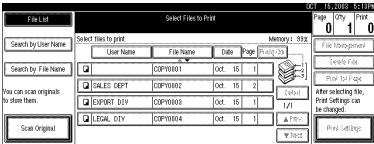

Note

- If a password is already set for the document, enter that password, and then press **[OK]**.

- 3 Press **[File Management]**.

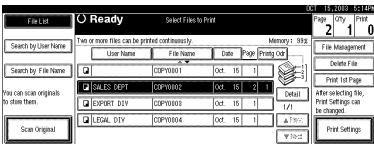

- 4 Press **[Change User Name]**, **[Change File Name]**, or **[Change Password]**.

- 5 Enter the new user name, file name, or password using the letter keys or number keys, and then press **[OK]**.

Reference

- p.36 "To register or change a user name"
- p.37 "To change a file name"
- p.37 "To set or change a password"

- 6 Press **[OK]**.

Selecting a Document

- 1 Press the **[Document Server]** key.
- 2 Select a document you want to print.

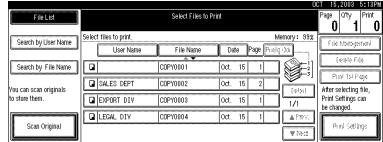

Note

- If a password is already set for the document, enter that password, and then press **[OK]**.
- You can search for the document using **[Search by User Name]** or **[Search by File Name]** at the left top of the display. See p.39 "Searching for Stored Documents".
- You can sort document names in the list by user name, file name, or date. To sort documents, press **[User Name]**, **[File Name]**, or **[Date]**.
- If you cannot determine document content from the file name, you can print just the first page of the document for checking purposes. See p.42 "Printing first page".
- To cancel document selection, press it again.

- 3** To print multiple documents, repeat step 2 in the order you want to print.

Note

- You can select up to 30 documents.
- If the sizes or resolution of selected documents are not the same, it may not be possible to print them.
- If you want to change the printing order, cancel the selection, and select documents again, this time in the order you want.
- If you press the **[Clear Modes]** key, selection of all documents will be canceled.
- If you press **[Printg Odr]**, the documents in print order.

To check the details of stored documents

- 1** Select a document to display its detailed information.

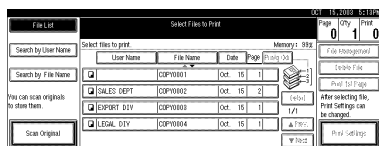

Note

- If a password is already set for the document, enter that password, and then press **[OK]**.

- 2** Press **[Detail]**.

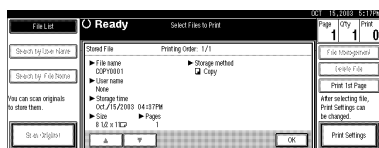

Detailed information about the document appears.

Note

- If you selected several documents, use **[▲]** and **[▼]** to view the details of each.
- Press **[OK]**. The Select Files to Print display reappears.

Searching for Stored Documents

You can use either **[Search by File Name]** or **[Search by User Name]** to search for documents stored in the Document Server. You can also list stored documents in a preferred order.

Note

- If you install DeskTopBinder V2 Professional or DeskTopBinder V2 Lite on your computer, you can search for and rearrange documents using your computer.

Reference

Manuals for DeskTopBinder V2 Professional/Lite or Help

To search by file name

- 1** Press the **[Document Server]** key.

- 2** Press **[Search by File Name]**.

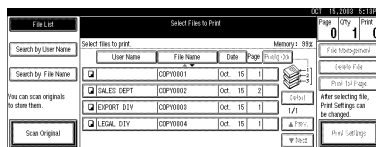

3 Enter the file name using the letter keys, and then press **[OK]**.

Only files beginning with the name entered appear in the Select Files to Print display.

Reference

p.143 "Entering Text".

Note

- To display all files stored in the Document Server, press **[File List]**.

5 Press **[OK]**.

Only files beginning with the name entered appear in the Select Files to Print display.

Note

- To display all files stored in the Document Server, press **[File List]**.

3

To search by user name

1 Press the **[Document Server]** key.

2 Press **[Search by User Name]**.

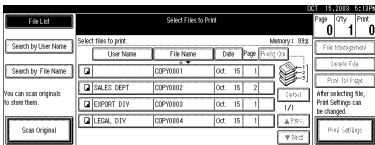

3 To specify a registered user name, select the user name from the displayed list, and then press **[OK]**.

Note

- To specify an unregistered user name, follow the procedure below.

4 To specify an unregistered user name, press **[Non-programed Name]**. Enter a user name, and then press **[OK]**.

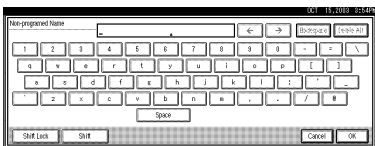

Reference

p.143 "Entering Text"

Note

- You can print stored documents from a network computer using a Web browser. For details about how to start the Web browser, see *Network Guide*.

1 Select a document you want to print.

Note

- If a password is already set for the document, enter that password, and then press **[OK]**.
- You can print multiple documents. See p.38 "Selecting a Document".

2 If you need to change print settings, press **[Print Settings]**.

The Print Settings display appears. User names, file names, and print order of documents appear.

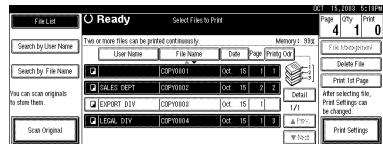

Note

- ❑ Print settings made for printing in copier or printer function remain after printing and applied to the next job. Print settings made in facsimile mode, however, do not remain.
- ❑ If you select multiple documents, print settings remain applied to the first document, but not to other documents.
- ❑ Print setting items are listed below. For details about print results of each setting, see *Copy Reference*.

❖ Binding format

- 2 Sided Copy Top to Top
- 2 Sided Copy Top to Bottom
- Booklet
- Magazine

❖ Cover handling

- Cover/Slip sheet
- Edit/Stamp

❖ Finish

- Sort
- Stack
- Staple
- ❑ If you print more than one set using the Sort function, you can check the print result by printing out only the first set. See p.42 "Sample copy".
- ❑ When multiple documents are printed at the same time, you can combine them into a single set by adjusting the print order.

- ❑ When multiple documents are printed at the same time, print settings made for the document printed first are applied to all other documents.
- ❑ If you select multiple files, you can check file names or print order selected in step 1 by scrolling the list using [▼] and [▲].
- ❑ Press **[Select File]** to return to the Select Files to Print display.
- ❑ "Booklet", "Magazine", and "Stamp" cannot be set for documents saved in facsimile mode.
- ❑ "Booklet" and "Magazine" cannot be set for documents saved under multiple functions.

3 Enter the required number of prints using the number keys.

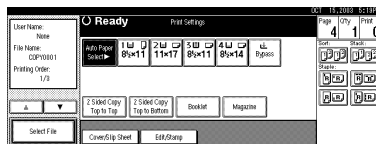

Note

- ❑ Up to 99 can be entered.

4 Press the **[Start]** key.

Printing starts.

To stop printing

1 Press the **[Clear/Stop]** key.

2 Press **[Stop]**.

Changing the number of copies during printing

⚠ Limitation

- ❑ The number of copies can only be changed when the Sort function is selected in the print settings.

- 1 Press the **[Clear/Stop]** key.
- 2 Press **[Change Quantity]**.
- 3 Enter a new number of copies using the number key.
- 4 Press the **[#]** key.
- 5 Press **[Continue]**.
Printing restarts.

Sample copy

If you print multiple sets using the Sort function, you can check the print order or print settings are correct by printing only the first set using the **[Sample Copy]** key.

⚠ Limitation

- ❑ This function can only be used when the Sort function is selected.

- 1 Select the document.

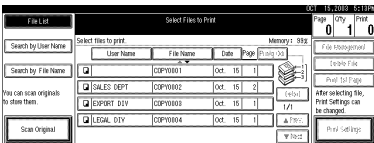

📎 Note

- ❑ If a password is already set for the document, enter that password, and then press **[OK]**.
- ❑ You can search for the document by using **[Search by User Name]** or **[Search by File Name]** at the left top of the display. See p.39 “Searching for Stored Documents”

- ❑ You can sort document names in the list by user name, file name, or date. To sort documents, press **[User Name]**, **[File Name]**, or **[Date]**.
- ❑ To cancel a document selection, press it again.

- 2 Press the **[Sample Copy]** key.

The first set prints out.

- 3 If the sample is acceptable, press **[Print]**.

📎 Note

- ❑ Press **[Suspend]** to cancel printing and return to the Print Settings menu to change settings.

Printing first page

You can print the first page of the document selected in the Select Files to Print display to check its content.

If more than one document selected, the first page of each is printed.

- 1 Select the document.

📎 Note

- ❑ If a password is already set for the document, enter that password, and then press **[OK]**.
- ❑ You can search for the document by using **[Search by User Name]** or **[Search by File Name]** at the left top of the display. See p.39 “Searching for Stored Documents”.

- ❑ You can sort document names in the list by user name, file name, or date. To sort documents, press **[User Name]**, **[File Name]**, or **[Date]**.
- ❑ To cancel a document selection, press it again.

2 Press [Print 1st Page].

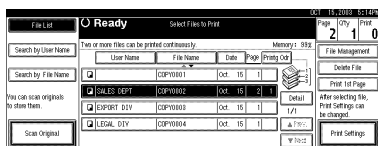

3 Press the [Start] key.

Deleting Stored Documents

Important

- You can store up to 3,000 documents in the Document Server. No more documents can be stored when the total is 3,000. You should delete unnecessary documents to increase available memory.

Note

- You can delete all stored documents at once with User Tools. See p.66 “Delete All Files”.
- You can delete stored documents from a network computer using the Web browser. For details about how to start the Web browser, see *Network Guide*.

1 Press the [Document Server] key.

2 Select the document to delete.

Note

- If a password is already set for the document, enter that password, and then press [OK].
- You can delete multiple documents at once. See p.38 “Selecting a Document”.
- You can search for a document by using [Search by User Name] or [Search by File Name] at the left top of the display. See p.39 “Searching for Stored Documents”.

- You can sort document names in the list by the user name, file name, or date. To sort documents, press [User Name], [File Name], or [Date].

- If you cannot find the document by name, you can print the first page of a document to check its contents. See p.42 “Printing first page”.

- Press the selected line again to cancel the print job.

3 Press [Delete File].

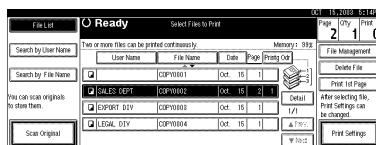

4 Press [Delete] to delete the document.

Viewing Stored Documents Using a Web Browser

Reference

The Web browser's Help

- 1** Start a Web browser.
- 2** Enter "http:// (IP address of this machine) /" in the [Address] box.

The top page appears on the Web browser.

- 3** Click [Document Server].

The [Document Server File List] appears.

Note

- To switch the display format, click [Details], [Thumbnails] or [Icons] from the [Display method] list.

- 4** Click the properties button of the document you want to check.

Information about that document appears.

- 5** Check the document's content.

Note

- To enlarge the document preview, click [Enlarge Image].

Downloading Stored Documents

Note

- File Format Converter is required when downloading documents stored in copier or printer mode.

- 1** Start a Web browser.

- 2** Enter "http:// (IP address of this machine) /" in the [Address] box.

The top page appears on the Web browser.

- 3** Click [Document Server].

The [Document Server File List] appears.

Note

- To switch the display format, click [Details], [Thumbnails] or [Icons] from the [Display method] list.

- 4** Click the properties button of the document you want to download.

- 5** Select [PDF], [JPEG], or [Multi-page TIFF] in the [File format] list.

Note

- [JPEG] can only be selected for documents stored in scanner mode.
- [Multi-page TIFF] is available when file Format Converter is installed.

- 6** Click [Download].

- 7** Click [OK].

Settings for the Document Server

❖ Copier/Document Server Features (See "General Features 4/4", *Copy Reference*.)

Items	Default	
General Features	Document Server Storage Key: F1	<i>2 Sided Original Top to top</i>
	Document Server Storage Key: F2	<i>1 Sided→1 Sided Combine</i>
	Document Server Storage Key: F3	<i>1 Sided→1 Sided Combine: 4 originals</i>
	Document Server Storage Key: F4	<i>1 Sided→1 Sided Combine: 8 originals</i>
	Document Server Storage Key: F5	<i>Create Margin</i>

❖ System Settings (See p.51 "General Features", p.55 "Tray Paper Settings", p.58 "Timer Settings", and p.59 "Key Operator Tools".)

	Items	Default
General Features	Warm Up Notice	<i>ON</i>
	Copy Count Display	<i>Up</i>
	Output: Document Server	<i>Internal tray 1</i>
Tray Paper Settings	Paper Tray Priority: Copier	<i>Tray 1</i>
	Cover Sheet Tray	<i>Off</i>
	Slip Sheet Tray	<i>Off</i>
Timer Settings	Copier/Document Server Auto Reset Timer	<i>60 seconds</i>
Key Operator Tools	Auto Delete File	<i>Yes After 3 day(s)</i>
	Delete All Files	<i>--</i>
	Password Management for Stored Files	<i>Do not Unlock</i>

4. User Tools (System Settings)

User Tools Menu (System Settings)

Reference

For details about Interface Settings and File Transfer, see “User Tools Menu (System Settings)”, *Network Guide*.

For details about parallel interface, see “System Settings (Parallel Connection)”, *Printer Reference 2*.

◆ General Features (See p.51 “General Features”.)

	Default
Panel Tone	ON
Warm Up Notice	ON
Copy Count Display	Up
Function Priority	Copier
Print Priority	Display mode
Function Reset Timer	Set Time
Output: Copier	Internal tray 1
Output: Document Server	Internal tray 1
Output: Facsimile	Internal tray 2
Output: Printer	Internal tray 1
<F/F4> Size Setting	8 ¹ / ₂ " × 13" 

❖ Tray Paper Settings (See p.55 “Tray Paper Settings”.)

	Default
Paper Tray Priority: Copier	Tray 1
Paper Tray Priority: Facsimile	Tray 1
Paper Tray Priority: Printer	Tray 1
Tray Paper Size: Tray 1	A4 <input type="checkbox"/> , 8 ¹ / ₂ " × 11" <input type="checkbox"/>
Tray Paper Size: Tray 2	A3 <input type="checkbox"/> , 11" × 17" <input type="checkbox"/>
Tray Paper Size: Tray 3	A4 <input type="checkbox"/> , 8 ¹ / ₂ " × 11" <input type="checkbox"/>
Tray Paper Size: Tray 4	A4 <input type="checkbox"/> , 8 ¹ / ₂ " × 14" <input type="checkbox"/>
Paper Type: Bypass tray	No display
Paper Type: Tray 1	No display/2 Sided Copy/Auto Paper Select on
Paper Type: Tray 2	No display/2 Sided Copy/Auto Paper Select on
Paper Type: Tray 3	No display/2 Sided Copy/Auto Paper Select on
Paper Type: Tray 4	No display/2 Sided Copy/Auto Paper Select on
Cover Sheet Tray	Off
Slip Sheet Tray	Off

❖ Timer Settings (See p.58 “Timer Settings”.)

	Default
Auto Off Timer	1 minute(s)
Panel Off Timer	1 minute(s)
System Auto Reset Timer	60 seconds
Copier/Document Server Auto Reset Timer	60 seconds
Facsimile Auto Reset Timer	30 seconds
Scanner Auto Reset Timer	60 seconds
Set Date	--
Set Time	--

❖ Interface Settings

- For details about network settings, see “User Tools Menu (System Settings)”, *Network Guide*.
- For details about parallel interface, see “System Settings (Parallel Collection)”, *Printer Reference 2*.

❖ File Transfer

- For details about network settings, see “User Tools Menu (System Settings)”, *Network Guide*.

❖ **Key Operator Tools (See p.59 “Key Operator Tools”).**

		Default
User Code Management	Copier	<i>OFF</i>
	Document Server	<i>OFF</i>
	Facsimile	<i>OFF</i>
	Scanner	<i>OFF</i>
	Printer	<i>Auto Program</i>
Key Counter Management		<i>All OFF</i>
External Charge Unit Management		<i>--</i>
Key Operator Code		<i>OFF</i>
Extended Security		<i>OFF</i>
Display/Print Counter		<i>--</i>
Display/Clear/Print Counter per User Code		<i>--</i>
Print Address Book: Destination List		<i>--</i>
Address Book Management		<i>--</i>
Address Book: Program/Change/Delete Group		<i>--</i>
Address Book: Program/Change/Delete Transfer Request		<i>--</i>
Address Book: Change Order		<i>--</i>
Address Book: Edit Title		<i>--</i>
Address Book: Select Title		<i>Title 1</i>
Auto Delete File		<i>After 3 day(s)</i>
Delete All Files		<i>--</i>
Password Management for Stored Files		<i>Do not Unlock</i>
AOF (Always ON)		<i>ON</i>
Program/Change LDAP Server		<i>--</i>
Use LDAP Server		<i>OFF</i>

Accessing User Tools (System Settings)

This section is for key operators in charge of this machine.

User Tools allow you to change or set defaults.

Note

- Operations for system settings differ from normal operations. Always quit User Tools when you have finished. See p.50 "Exiting User Tools".
- Any changes you make with User Tools remain in effect even if the main power switch or operation switch is turned off, or the **[Energy Saver]** or **[Clear Modes]** key is pressed.

Changing Default Settings

Note

- If a key operator code is already set, the key operator code entry display appears. Enter the key operator code, and then press **[OK]**. See p.60 "Key Operator Code".

1 Press the **[User Tools/Counter]** key.

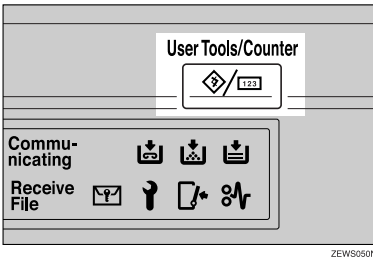

2 Press **[System Settings]**.

3 Select the menu, and then press the appropriate key.

Reference

p.47 "User Tools Menu (System Settings)"

4 Change settings by following instructions on the display panel, and then press **[OK]**.

Note

- To cancel changes made to settings and return to the initial display, press the **[User Tools/Counter]** key.

Exiting User Tools

1 Press the **[User Tools/Counter]** key.

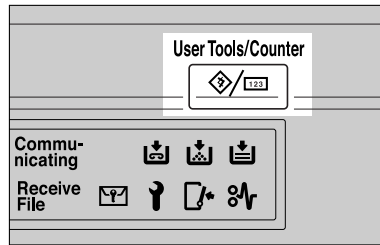

ZEWIS050N

Note

- You can also exit User Tools by pressing **[Exit]**.

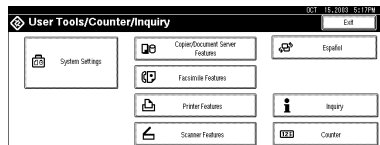

Settings You Can Change with User Tools

Reference

To access User Tools, see p.50 “Accessing User Tools (System Settings)”.

General Features

❖ Panel Tone

The beeper (key tone) sounds when a key is pressed.

Note

Default: *ON*

❖ Warm Up Notice (copier/Document Server)

You can have the beeper sound when the machine becomes ready to copy after leaving Energy Saver mode, or when the power is turned on.

Note

If the Panel Tone setting is “OFF”, the beeper does not sound, whatever the Warm Up Notice setting.

Default: *ON*

❖ Copy Count Display (copier/Document Server)

The copy counter can be set to show the number of copies made (count up) or the number of copies yet to be made (count down).

Note

Default: *Up (count up)*

❖ Function Priority

You can specify the mode to be displayed immediately after the operation switch is turned on, or when System Reset mode is turned on.

Note

Default: *Copier*

❖ Print Priority

Print Priority is given to the mode selected.

Reference

p.29 "Multi-Access"

Note

- Default: *Display mode*
- When **[Interleave]** is selected, the current print job will be interrupted after a maximum of five sheets.
- When the Internal Tray 2 (1 bin tray), Shift Sort Tray, 500-sheet finisher, or 1000-sheet finisher is installed on the machine, you can specify an output tray for each documents are delivered. For details about how to specify an output tray for each function, see the following sections:
 - p.53 "Output: Copier (copier)"
 - p.53 "Output: Document Server (Document Server)"
 - p.53 "Output: Facsimile (facsimile)"
 - p.53 "Output: Printer (printer)"

❖ Function Reset Timer

You can set the length of time the machine waits before changing modes when using the multi-access function (see p.29 "Multi-Access"). This is useful if you are making many copies and have to change settings for each copy. If you set a longer reset period, you can prevent interruption from other functions.

Note

- Default: *Set Time*
- The Function Reset Timer setting is ignored if **[Interleave]** is set for Print Priority (see p.52 "Print Priority").
- When you select **[Set Time]**, enter the time (3–30 seconds, in 1 second increments) using the number keys.
- The default time is three seconds.

❖ Output: Copier (copier)

You can specify a tray to which documents are delivered.

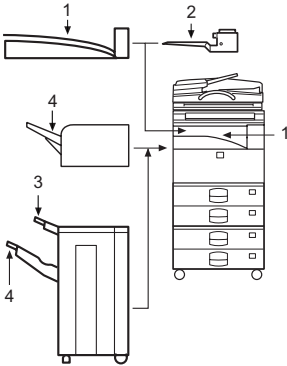

ZLPH150E

1. Internal Tray 1

2. Internal Tray 2

3. Finisher Upper Tray

4. Finisher Shift Tray

Note

- Default: *Internal Tray 1*

❖ Output: Document Server (Document Server)

You can specify a tray to which documents are delivered.

Note

- Default: *Internal Tray 1*
- For details about output trays, see p.53 “Output: Copier (copier)”.

❖ Output: Facsimile (facsimile)

You can specify a tray to which documents are delivered.

Note

- Default: *Internal Tray 2*
- For details about output trays, see p.53 “Output: Copier (copier)”.

❖ Output: Printer (printer)

You can specify a tray to which documents are delivered.

Note

- Default: *Internal Tray 1*
- The output trays set on the printer driver have priority over the output tray specified above.
- For details about output trays, see p.53 “Output: Copier (copier)”.

❖ <F/F4> Size Setting

Currently three types of F size are available; 8¹/₂"×13"☐, 8¹/₄"×13"☐ and 8"×13"☐. The ADF or exposure glass cover sensor cannot distinguish these three types of originals. This function sets the F size from the ADF or exposure glass cover sensor. Auto Paper Select or Auto Reduce/Enlarge can be used for F size originals based on this setting.

 Note

☐ Default: 8¹/₂"×13"☐

Output tray settings

 Limitation

- ☐ You cannot interrupt the current job with a different function job that specifies stapling or sorting.
- ☐ You can interrupt the current job with an ordinary copy job or facsimile reception. The output tray used when the job is interrupted varies depending on the type of finisher shift tray and output tray specified for interruption.

❖ When 500-sheet finisher is the finisher shift tray:

- When the output tray specified for the interrupting job is the finisher tray, the interrupting job will be delivered to internal tray 1.
- When the output tray specified for the interrupting job is not the finisher tray, the interrupting job will be delivered to the specified output tray.

❖ When 1000-sheet finisher is the finisher shift tray:

- When the output tray specified for the interrupting job is the finisher tray, the interrupting job will be delivered to the finisher upper tray.
 - When the output tray specified for the interrupting job is not the finisher tray, the interrupting job will be delivered to the specified output tray.
- ☐ When the 500-sheet finisher or 1000-sheet finisher is installed and stapling is specified for a job, the job will be delivered to the finisher shift tray, regardless of the output tray specified.

Tray Paper Settings

❖ Paper Tray Priority: Copier (copier/Document Server)

You can specify the tray to supply paper for output.

Note

Default: *Tray 1*

❖ Paper Tray Priority: Facsimile (facsimile)

You can specify the tray to supply paper for output.

Note

Default: *Tray 1*

❖ Paper Tray Priority: Printer (printer)

You can specify the tray to supply paper for output.



















Note

Default: *Tray 1*





















❖ Tray Paper Size: Tray 1–4

Select the size of the paper loaded in the paper tray.

❖ The paper sizes you can set for trays 1, 3 and 4 are as follows:

- A3 , B4 JIS , A4 , A4 , B5 JIS , B5 JIS , A5 , 8K , 16K , 16K 
- 11"×17" , 8¹/₂"×14" , 8¹/₂"×11" , 8¹/₂"×11" , 5¹/₂"×8¹/₂" , 7¹/₄"×10¹/₂" , 8"×13" , 8¹/₂"×13" , 8¹/₄"×13" , 11"×14" , 8¹/₄"×14" , 8"×10¹/₂" , 8"×10¹/₂" , custom size (140-297 mm (5.52"-11.69") wide x 182-432 mm (7.17"-17.00") long)

❖ The paper sizes you can set for tray 2 are as follows:

- A3 , B4 JIS , A4 , A4 , B5 JIS , B5 JIS , A5 , B6 JIS , A6 , Postcard , 8K , 16K , 16K
- 11"×17" , 8¹/₂"×14" , 8¹/₂"×11" , 8¹/₂"×11" , 5¹/₂"×8¹/₂" , 7¹/₄"×10¹/₂" , 7¹/₄"×10¹/₂" , 8"×13" , 8¹/₂"×13" , 8¹/₄"×13" , 11"×14" , 11"×15" , 10"×14" , 10"×15" , 8¹/₄"×14" , 8"×10¹/₂" , 8"×10¹/₂" , 8"×10" , 8"×10" , C5 , C6 , DL Env , 4¹/₈"×9¹/₂" , 3⁷/₈"×7¹/₂" , custom size (100-297 mm (3.97"-11.69") wide x 148-432 mm (5.83"-17.00") long)











Reference

p.122 "Changing the Paper Size"

Important

- If the specified paper size differs from the actual size of the paper loaded in the paper tray, a misfeed might occur because the correct paper size was not detected.

Note

- The paper guide for the optional LCT is fixed for A4 , 8¹/₂"×11"  size paper. Contact your service representative if you need to change the paper size.
- If the paper size set for the selector in paper tray is different to the paper size for this setting, the paper size of the dial has priority.
- If you load paper of a size not indicated on the paper size selector in the paper tray, set the dial to "*".
- Default:
 - Tray 1: A4 , 8¹/₂" × 11" 
 - Tray 2: A3 , 11" × 17" 
 - Tray 3: A4 , 8¹/₂" × 11" 
 - Tray 4: A4 , 8¹/₂" × 14" 

Reference

p.122 "Changing the Paper Size"

❖ Paper Type: Bypass tray

Sets the display so you can see what type of paper is loaded in the bypass tray.

❖ The paper types you can set for the bypass tray are as follows:

- No Display, Recycled Paper, Special Paper, Color Paper, Letterhead, Preprinted Paper, Label Paper, Bond Paper, Thick Paper, OHP, Thin Paper, Cardstock

Note

- Default: *No display*

❖ Paper Type: Tray 1–4

Sets the display so you can see what type of paper is loaded in each paper tray. The print function uses this information to automatically select the paper tray.

❖ The paper types you can set for trays 1, 3 and 4 are as follows:

- No Display, Recycled Paper, Special Paper, Color Paper, Letterhead, Preprinted Paper, Bond Paper, Cardstock

❖ The paper types you can set for tray 2 are as follows:

- No Display, Recycled Paper, Special Paper, Color Paper, Letterhead, Preprinted Paper, Label Paper, Bond Paper, Thick Paper, OHP, Thin Paper, Cardstock

Note

- Default:
 - Paper Type: *No Display*
 - Copying Method in Duplex: *2 Sided Copy*
 - Apply Auto Paper Select: *Yes*

- When paper of the same type and size is loaded in two different paper trays and you want to specify tray for 2 Sided Copy and tray for 1 Sided Copy, specify the upper tray for 2 Sided Copy. If one of the trays is specified as the default in Paper Tray Priority, assign 2 Sided Copy to that tray.

- A  appears next to the paper tray if **[No]** is selected in Auto Paper Select.



Limitation

- [Auto Paper Select]** can only be selected for the copier function if **[No display]** and **[Recycled paper]** are selected. If **[No]** is selected, Auto Paper Select is not valid for the tray.

❖ Cover Sheet Tray

Allows you to specify and display the paper tray that is setting cover sheets. After selecting the paper tray, you can also specify the display timing and copy method for two-sided copying.



Note

- Default:
 - Tray to Program: *Off*
- Functions using the cover sheet tray setting are the front cover function and front/back cover function.
- When **[At Mode Selected]** is selected, cover sheet tray settings only appear when the cover function or slip sheet function is selected.
- When **[Full Time]** is selected, the cover sheet tray is always displayed.
- You can set Copying Method in Duplex only when **[At Mode Selected]** is selected.



Reference

"Covers", *Copy Reference*

❖ Slip Sheet Tray

Allows you to specify and display the paper tray that is inserting slip sheets. After selecting the paper tray, you can also specify the display timing and copy method for two-sided copying.



Note

- Default:
 - Tray to Program: *Off*
- When **[At Mode Selected]** is selected, slip sheet tray settings only appear when the cover function or slip sheet function is selected.



Reference

"Slip Sheets", *Copy Reference*

Timer Settings

❖ Auto Off Timer

After a specified period has passed, following job completion, the machine automatically turns off, in order to conserve energy. This function is called "Auto Off".

The machine status after the Auto Off operation is referred to as "Off mode", or "Sleep mode". For the Auto Off Timer, specify the time to elapse before Auto Off.

Note

- Default: 1 minute
- Enter a time interval between 10 seconds and 240 minutes, using the number keys
- From "Off mode" or "Sleep mode", the machine is ready to use within 10 seconds.
- Auto Off may not work when error messages appear.

❖ Panel Off Timer

Set the amount of time the machine waits before switching the panel off after copying has finished or performing the last operation.

Note

- Default: 1 minute
- Enter a time interval between 10 seconds and 240 minutes, using the number keys.

❖ System Auto Reset Timer

The System Reset setting automatically switches the screen to that of the function set in Function Priority. When no operations are in progress, or when an interrupted job is cleared. This setting determines the system reset interval. See p.51 "Function Priority".

Note

- Default: ON, 60 seconds
- The time can be set from 10 to 999 seconds, using the number keys.

❖ Copier/Document Server Auto Reset Timer (copier/Document Server)

Specifies the time to elapse before copier and Document Server modes reset.

Note

- If [OFF] is selected, the machine does not automatically switch to the user code entry screen.
- Default: ON, 60 seconds
- The time can be set from 10 to 999 seconds, using the number keys.

❖ Facsimile Auto Reset Timer (facsimile)

Specifies the time to elapse before the facsimile mode resets.

Note

- Default: *30 seconds*
- The time can be set from 30 to 999 seconds, using the number keys.

❖ Scanner Auto Reset Timer (scanner)

Specifies the time to elapse before the scanner function resets.

Note

- If **[OFF]** is selected, the machine does not automatically switch to the user code entry screen.
- Default: *ON, 60 seconds*
- The time can be set from 10 to 999 seconds, using the number keys.

❖ Set Date

Set the date for the copier's internal clock using the number keys.

Note

- To change between year, month, and day, press **[←]** and **[→]**.

❖ Set Time

Set the time for the copier's internal clock using the number keys.

Note

- To change between hours, minutes and seconds, press **[←]** and **[→]**.
- Enter the time using the 24-hour format (in 1 second increments).

Key Operator Tools

The key operator must set the following items. For settings or more information, contact the key operator.

The key operator is recommended to program an key operator code when performing the settings. See p.60 "Key Operator Code".

❖ User Code Management

Allows you to control who uses the machine by setting codes for users.

User codes must be registered for user code management. See p.70 "User Codes".

Note

- Default: *Copier/OFF, Document Server/OFF, Facsimile/OFF, Scanner/OFF, Printer/Auto Program*
- By using Auto Program for the printer, you can keep a print log for each user code entered from the driver.

❖ Key Counter Management

Use the key counter to specify whether users are restricted or not.

Note

- Default: *Copier/OFF, Document Server/OFF, Facsimile/OFF, Scanner/OFF, Printer/OFF*

❖ External Charge Unit Management

Use the external charge unit to manage usage charges.

Note

- Default: *Copier/OFF, Document Server/OFF, Facsimile/OFF, Scanner/OFF, Printer/OFF*

❖ Key Operator Code

Specifies whether or not to use passwords (max. eight digits) to control Key Operator Tools settings for key operator codes.

Note

- Default: *OFF*
- If you select **[ON]**, enter the key operator code (max. eight digits) using the number keys, and then select **[Partial]** or **[All Initial Settings]** to set the access limit.
 - If you selected **[Partial]**
An key operator code is only required for the Timer Setting, Key Operator Tools for System Settings, and Key Operator Tools for Facsimile Features. **[Menu Protect]** can be set for **[Maintenance]** in Printer Features. If you set **[Menu Protect]**, you can set the key operator code for some Printer Features. See "Printer Features Parameters", *Printer Reference 2*.
 - If you selected **[All Initial Settings]**:
An key operator code is required to access all items in System Settings, Copier/Document Server Features, Facsimile Features, Printer Features, and Scanner Features.
- If you select **[All Initial Settings]**, you must enter an key operator code to access the Key Operator Code display.

❖ Extended Security

Specify whether or not to use the security function.

Note

- Default : *OFF*
- You have to set a 6-digit key operator code to enable Extended Security. See p.60 "Key Operator Code".
- When the Extended Security function is on, a security mark  appears on the left side of the date, in the upper right of the display panel.

Reference

For details about security, see p.145 "Security".

❖ Display/Print Counter

Allows you to view and print the number of prints.

- Display/Print Counter
Displays the number of prints for each function (Total, Copier, Facsimile, Printer, A3/DLT, Duplex, and Staple).
- Print Counter List
Prints out a list of the number of prints made under each function.
- To print the counter list:
 - ① Press the **[User Tools/Counter]** key.
 - ② Press **[System Settings]**.
 - ③ Press **[Key Operator Tools]**.
 - ④ Press **[Display/Print Counter]**.
 - ⑤ Press **[Print Counter List]**.

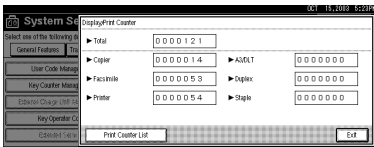

- ⑥ Press the **[Start]** key.
- ⑦ Press **[Exit]**.

❖ Display/Clear/Print Counter per User Code

Allows you to view and print the numbers of prints accessed with user codes, and to set those values to 0.

Note

- Press **[▲]** and **[▼]** to show all the numbers of prints.
- The number of prints may differ from the counter value shown in Display/Print Counter.
 - Print counter per user code
Prints the number of prints made under each user code
 - Clear counter per user code
Sets the number of prints made under each user code to 0.

Note

- Print list for each user code, see p.74 “Printing the Counter for Each User Code”.
 - Print counter for all user codes
Prints the number of prints made under all user codes.
 - Clear counter for all user codes
Sets the number of prints made under all user codes to 0.

❖ **Print Address Book: Destination List**

You can print the destination list registered in the Address Book.

- **Print in Title 1 Order**
Prints the Address Book in Title 1 order.
- **Print in Title 2 Order**
Prints the Address Book in Title 2 order.
- **Print in Title 3 Order**
Prints the Address Book in Title 3 order.
- **Print Group Dial List**
Prints the group Address Book.

- ① Select the print format.
- ② To print the list on two-sided pages, select **[Print on 2 Sides]**.
- ③ Press the **[Start]** key.
The list prints out.

❖ **Address Book Management**

You can add, change, or delete user information in the Address Book, and facsimile/scanner functions destinations.

For details about these operations, see p.70 “User Codes”, p.76 “Fax Destination”, and p.82 “E-mail Destination”, p.85 “Registering Folders”, p.93 “Registering a Protection Code”.

- **[Program/Change]**
This registers new user codes. You can register and change the items below:
 - **User Name**
User (destination) name, key display, registration number, title selection
 - **User Code**
User code, available functions
 - **Fax Dest.**
Fax number, international TX mode, fax header, label insertion
 - **E-mail**
E-mail address, sender registration
 - **Folder**
Protocol, path, user name, password, port no., server name
 - **Protect Dest.**
Sender's name, folder, protection code
 - **Group**
- **[Delete]**
Deletes a user.

Note

- You can register up to 100 user codes. If you add the optional User Account Enhance Unit, you can register up to 500 user codes.
- You can also register user codes using SmartNetMonitor for Admin (printer option required).
- You can also register user codes using a Web browser.

❖ Address Book: Program/Change/Delete Group

You can register multiple users in a group.

This allows you to easily control registered users in each group.

For details about operations, see p.95 “Registering Destinations to a Group”.

- **[Program/Change]**

This registers new groups, or changes the group name, key display, title selection, registration number or protection code. You can also protect e-mail destinations and folders.

- **[Delete]**

Deletes a group.

- **[Protect Dest.]**

Note

You can register up to 100 groups.

You can also group users (destinations) using a Web browser. See the Web browser's Help.

❖ Address Book: Program/Change/Delete Transfer Request

You can register fax destinations for the Transfer Request function in facsimile mode.

For details about operations, see p.99 “Registering the Transfer Request”.

- **[Program/Change]**

This registers new transfer requests and receiving stations, or changes the transfer request name, key name, title selection, registration number, fax destination or e-mail address.

- **[Delete]**

Deletes a transfer request.

Note

You can register up to 100 transfer requests.

❖ Address Book: Change Order

Changes the order of registered users (destinations).

Note

You can rearrange the order of items on the same page, but you cannot move items to another page. For example, you cannot move an item from "PLANNING" (IOPQ) to "DAILY" (CDJ).

- ① Press the **[User Tools/Counter]** key.
- ② Press **[System Settings]**.
- ③ Press **[Key Operator Tools]**, and then press **[▼Next]**.
- ④ Press **[Address Book: Change Order]**.

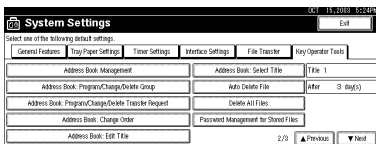

- ⑤ Press the user (destination) key you want to move.

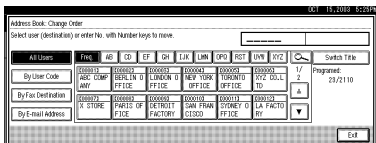

Note

You can select a user using the number key.

- ⑥ Press the user (destination) key that is in the place you want to move to.

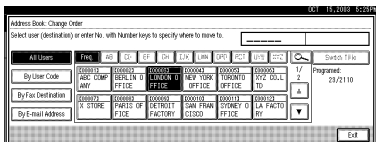

The user (destination) moves to the selected place, and the other users' keys will shift also.

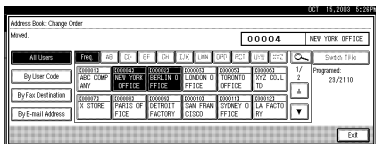

Note

You can select a user using the number key.

❖ Address Book: Edit Title

You can edit the title to easily find a user.

- ① Press the **[User Tools/Counter]** key.
- ② Press **[System Settings]**.
- ③ Press **[Key Operator Tools]**, and then press **[▼Next]**.
- ④ Press **[Address Book: Edit Title]**.

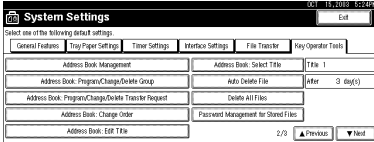

- ⑤ Press the title key you want to change.

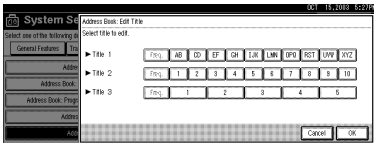

- ⑥ Enter the new name, and then press **[OK]**.
- ⑦ Press **[OK]**.
- ⑧ Press **[Exit]**.

❖ Address Book: Select Title

Specifies the title to select a user.

Note

- Default: *Title 1*

❖ Auto Delete File

Specifies whether documents stored in the Document Server are to be deleted or not after a specified period of time elapses.

Note

- Default: *Yes After 3 days*
- If you select **[Yes]**, documents stored subsequently are deleted after the specified period.
- If you select **[No]**, documents are not automatically deleted.
- If you select **[Yes]**, enter a number of days from of 1 to 180 (in 1 day increments).
- The default is three days, this means documents are deleted three days (72 hours) after they are stored.

❖ Delete All Files

Deletes all documents stored in the Document Server.

 Note

- Even if a password is already set, all documents are deleted.
- A confirmation message appears. To delete all documents, select **[Yes]**.

❖ Password Management for Stored Files

- Unlocking a locked document
When a document is locked due to a wrong password being entered, this function unlocks the document, allowing access.
- Temporarily disabling document security
Password-protected documents can be temporarily accessed, without entering the password.

 Note

- Default: *Do not Unlock*
- Select **[Unlock]** only when you forget the password. After accessing the document, be sure to select **[Do not Unlock]**.

 Reference

p.147 "Unlocking a locked document"

p.147 "Temporarily Disabling Document Security"

❖ AOF (Always ON)

Specify whether or not to use Auto Off.

 Note

- Default: *ON*

❖ Program/Change LDAP Server

Programming an LDAP server allows you to look up e-mail destinations from the LDAP server Address Book directly. This function is available when you send scan files by e-mail in scanner mode.

You can program and change the identification name, server name, search base, port no., authentication, user name, password, and search options.

 Reference

For details about these operations, see p.103 "Programming/Changing LDAP Server".

❖ Use LDAP Server

Specify whether or not to use the LDAP server.

 Note

- Default: *OFF*
- If you select **[OFF]**, **[Search LDAP]** will not appear on the searching display.

Address Book

Registering user information, such as fax number and e-mail address, in the Address Book allows you to manage them together.

Important

- ❑ Address Book data is stored on the hard disk. It can be lost if there is some kind of hard disk failure. The manufacturer shall not be responsible for any damage resulting from data loss.

Note

- ❑ Using **[Address Management Tool]** in SmartNetMonitor for Admin, you can backup Address Book data. We recommend backing up data when using the Address Book.

Reference

For details about SmartNetMonitor for Admin and how to install it, see *Printer Reference 1*.

For operating instructions, see SmartNetMonitor for Admin Help.

You can register and manage the following items in the Address Book:

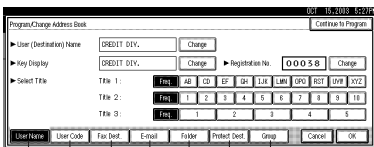

ZKZS030E

❖ To manage registered items

1. User Code

Register user codes to restrict particular functions to certain users, and check their use of each function.

🔍 Reference

p.70 "User Codes"

2. Protect Dest.

🔍 Reference

p.69 "When using the scanner function"

p.69 "Registering Sender Information"

3. Group

Use this to display the group that the selected user (destination) belongs to.

You can group registered fax destinations, e-mail destinations, and folders to manage them better. For details about operations, see p.95 "Registering Destinations to a Group".

❖ Items to register

4. User Name

🔍 Reference

p.68 "Registering the destination name and key display"

p.69 "Registering Sender Information"

5. Fax Dest.

🔍 Reference

p.68 "When using the fax function"

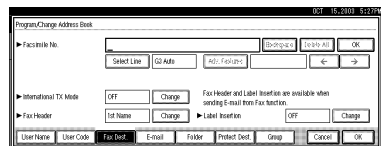

6. E-mail

Reference

p.68 "When using the fax function"

p.69 "When using the scanner function"

p.69 "Registering Sender Information"

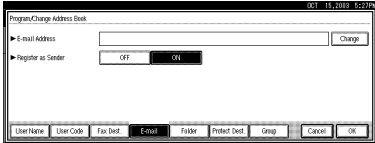

7. Folder

Reference

p.69 "When using the scanner function"

- SMB



- FTP

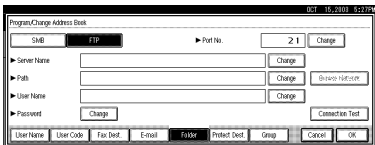

Registering Destination Information

❖ Registering the destination name and key display

- User Name
Register the destination name and key display name. This is the basic information required for managing destinations.

Reference

p.70 "User Codes"

❖ When using the fax function

- Fax Dest.
Register fax numbers in the Address Book. To send a fax, select the destination key as it appears on the initial fax function display, so you can specify the fax number. When you set Label Insertion to ON, the registered destination name, preceded by "To", is printed at the top of the page when it is received at the other end.

Reference

p.76 "Fax Destination"

- E-mail
Register e-mail addresses in the Address Book. To send an Internet Fax, select the destination key as it appears on the initial fax function display, so you can specify the e-mail address.

Reference

p.82 "E-mail Destination"

❖ When using the scanner function

- E-mail
Register e-mail addresses in the Address Book. To send a scan file by e-mail, select the destination key as it appears on the initial scanner function display, so you can specify the e-mail address.

Reference

p.82 "E-mail Destination"

- Folder
Register the path name, user name, and password. To send files directly to shared folders, select the destination key as it appears on the initial scanner function display, so you can specify the folder. Select SMB when sending files to shared Windows folders. Select FTP when uploading files to an FTP server.

Reference

p.85 "Registering Folders"

You can stop unauthorized users accessing folders from the machine by setting a protection code.

Reference

p.93 "Registering a Protection Code"

Registering Sender Information

❖ When using the scanner function

You can set Register as Sender to ON for an e-mail address. If you do this, you can use it as the sender address when sending scan files by e-mail.

- User Name
Register the user name and key display name. This is useful when selecting the sender from the Attach Sender's Name list. Register the user name so it will be recorded under Sender in Scanned Files Status. Also, the user name automatically appears in the From field of the e-mail.

Reference

p.70 "User Codes"

- E-mail
Register the e-mail address. You can use it as the sender address when sending scan files by e-mail using the scanner function. Also, the sender address automatically appears in the From field of the e-mail. To display a user key on the Attach Sender's Name list, you must register an e-mail address to it.

Reference

p.82 "E-mail Destination"

You can prevent misuse of sender name by setting a protection code on the e-mail address.

Reference

p.93 "Registering a Protection Code"

User Codes

Register user codes to limit users to the following functions and check their use of each function:

- Copier
- Document Server
- Facsimile
- Scanner
- Printer

Note

- ❑ The number of copies made of documents stored in the Documents Server using the facsimile function is counted for each user code. This allows you to check each user's usage.
- ❑ The number of copies scanned using the scanner function is counted for each user code. This allows you to check each user's usage.
- ❑ To automatically register the printer driver user code, select **[Auto Program]** for the printer in User Code Management. To use the user code set in User Tools, select **[ON]**. Set the user codes registered in User Tools for the printer driver. See p.59 "User Code Management".

Reference

For details about setting user codes for the printer driver, see *Printer Reference 1* or the printer driver Help.

Important

- ❑ The functions associated with each user code are the same. If you change or delete user codes, management data and limits associated with that code become invalid.

Registering a New User Code

1 Press the **[User Tools/Counter]** key.

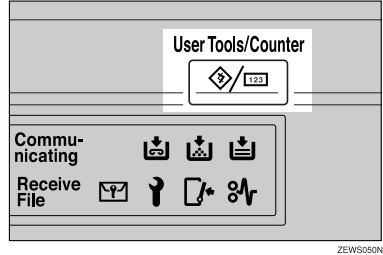

2 Press **[System Settings]**.

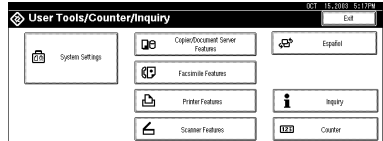

3 Press **[Key Operator Tools]**, and then press **[▼Next]**.

4 Press **[Address Book Management]**.

5 Press **[New Program]**.

Note

- ❑ To assign a user code to a registered user, press the user (destination) key whose user code is to be registered, or enter the registered number using the number keys.

6 Set the user information.

Note

- ❑ To register a user code to a registered user, proceed to step **7**.

To register the user name and key display

- 1 Press **[Change]** on the right of the user name or key display.

The user name or key display entry display appears.

- 2 Enter the user name or key display, and then press **[OK]**.

Note

- You can use the same user name as that assigned to the documents using the Document Server function. For this, the user code is not necessary. p.33 "Document Server"

Reference

p.143 "Entering Text"

To select the title

- 1 Press the key for the classification you want to use under Select Title.

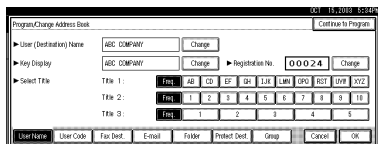

Note

- The keys you can select are as follows:
 - **[Freq.]**... Added to the page that is displayed first.
 - **[AB],[CD],[EF],[GH],[IJK],[LMN],[OPQ],[RST],[UVW],[XYZ],[1] to [10]**... Added to the list of items in the title selected.
- You can select **[Freq.]** and one more page for each title.

- 7 Press **[User Code]**.

- 8 Enter the user code using the number keys, and then press **[#]**.

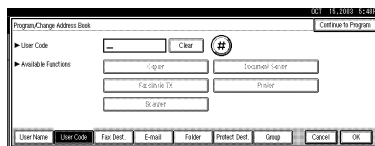

Note

- If you make a mistake, press **[Clear]** or the **[Clear/Stop]** key, and then enter the code again.

- 9 Select the functions to be used with the user code from Available Functions.

- 10 To continue registering user codes, press **[Continue to Program]**, and then repeat the procedure from step 6.

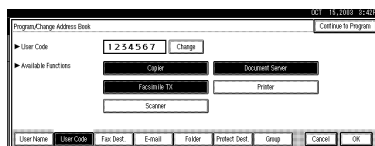

- 11 Press **[OK]**.

- 12 Press **[Exit]**.

- 13 Press the **[User Tools/Counter]** key.

Changing a User Code

Note

- Even if you change a user code, the counter value will not be cleared.

- 1 Press the **[User Tools/Counter]** key.
- 2 Press **[System Settings]**.
- 3 Press **[Key Operator Tools]**, and then press **[▼Next]**.

- 4 Press **[Address Book Management]**.

- 5 Select the registered user code you want to change.

Press the user (destination) key, or enter the registered number using the number keys.

Note

- If you press **[🔍]**, you can search for a user by user name/index, user code, fax destination, or e-mail address.

- 6 Enter the new information for the item you want to change.

To change the user (destination) name or key display

- 1 Press **[Change]** on the right of the user (destination) name or key display.
- 2 Enter the user (destination) name, and then press **[OK]**.

Reference

p.143 "Entering Text"

To change the title

- 1 Press the key for the classification you want to use from **Select Title**.

Changing the user code

- 1 Press **[User Code]**.
- 2 Press **[Change]**, and then enter the new user code using the number keys.

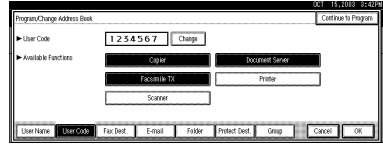

- 3 Press **[#]**.

To change the available functions

- 1 Press **[User Code]**.
- 2 Press the key to select the functions to enable.

Note

- Press the key to highlight it, and then the function is enabled.

- 7 Press **[OK]**.
- 8 Press **[Exit]**.
- 9 Press the **[User Tools/Counter]** key.

Deleting a User Code

Important

- This operation also deletes user codes registered to multiple functions. User control via the deleted user code is disabled.

- 1** Press the **[User Tools/Counter]** key.
- 2** Press **[System Settings]**.
- 3** Press **[Key Operator Tools]**, and then press **[▼Next]**.
- 4** Press **[Address Book Management]**.

To delete the user code

- 1** Select the user (destination) whose code is to be deleted.
Press the user (destination) key, or enter the registered code using the number keys.
- 2** Press **[User Code]**.
- 3** Press **[Change]** to delete the user code, and then press **[#]**.

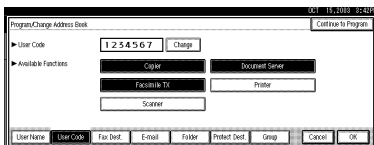

- 4** Press **[OK]**.

To delete a user (destination)

- 1** Press **[Delete]**.
- 2** Select the user (destination) you want to delete.

Press the user (destination) key, or enter the registered code using the number keys.

Note

- If you press , you can search for a user by user name/index, user code, fax destination, or e-mail address.

- 3** Press **[Yes]** in the confirmation screen.

- 5** Press **[Exit]**.

- 6** Press the **[User Tools/Counter]** key.

Displaying the Counter for Each User Code

You can check the number of prints made under each function's user code.

- 1** Press the **[User Tools/Counter]** key.
- 2** Press **[System Settings]**.
- 3** Press **[Key Operator Tools]**.
- 4** Press **[Display/Clear/Print Counter per User Code]**.
- 5** Select **[Print Counter]**, **[Transmission Counter]** or **[Scanner Counter]**.

Counters for individual function usage under each user code appear.

Printing the Counter for Each User Code

You can print out the number of prints made under each user code using [Print Counter], [Transmission Counter], and [Scanner Counter].

To print the number of prints made under each user code

4

- 1 Press the [User Tools/Counter] key.
- 2 Press [System Settings].
- 3 Press [Key Operator Tools].
- 4 Press [Display/Clear/Print Counter per User Code].
- 5 Select a user code from the left side of the display.

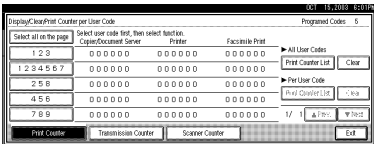

Note

- Press [Select all on the page] to select all user codes on the page.

- 6 Press [Print Counter List] under Per User Code.

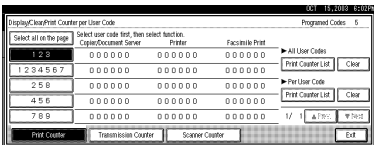

Note

- Enter the user code, and then press [#] if the user code is registered.

- 7 Select the function usage you want to print from [Print Counter], [Transmission Counter], and [Scanner Counter].

- 8 Press [Print].

To print the number of prints for all user codes

- 1 Press the [User Tools/Counter] key.
- 2 Press [System Settings].
- 3 Press [Key Operator Tools].
- 4 Press [Display/Clear/Print Counter per User Code].
- 5 Press [Print Counter List] under All User Codes.

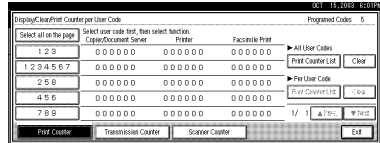

Note

- Enter the user code, and then press [#] if the user code is registered.

- 6 Select the function usage you want to print from [Print Counter], [Transmission Counter], and [Scanner Counter].

- 7 Press [Print].

Clearing the Number of Prints

- 1 Press the **[User Tools/Counter]** key.
- 2 Press **[System Settings]**.
- 3 Press **[Key Operator Tools]**.
- 4 Press **[Display/Clear/Print Counter per User Code]**.
- 5 Select the user code to clear.

To clear the number of prints made under a user code

- 1 Select the user code from the left side of the display.

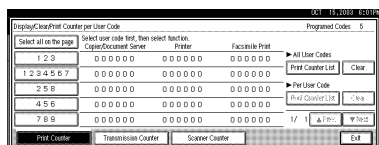

Note

- Press **[Select all on the page]** to select all user codes on the page.
- 2 Press **[Clear]** under Per User Codes.

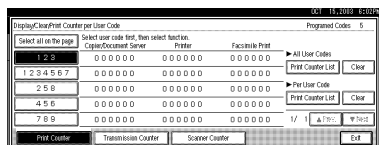

- 3 Select the function usage you want to clear from **[Print Counter]**, **[Transmission Counter]**, and **[Scanner Counter]**.
- 4 Press **[OK]**.

To clear the number of prints for all user codes

- 1 Press **[Clear]** under All User Codes.

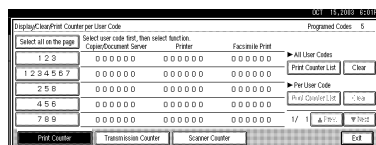

- 2 Select the function usage you want to clear from **[Print Counter]**, **[Transmission Counter]**, and **[Scanner Counter]**.
- 3 Press **[OK]**.

Fax Destination

Register a fax destination so you do not need to enter fax numbers each time, and can send documents scanned in using the facsimile function.

- It is easy to select the fax destination if you register a “User (Destination) Name” and “Key Display” for the fax destination.
- You can register fax destinations as a group.

You can program the following items in a fax destination:

❖ Fax number

Registers the destination's fax number. You can enter a fax number using up to 128 digits. You must include every digit in the number.

❖ SUB Code

Registering a SUB Code allows you to use Confidential Transmission to send messages to the other fax machines which support a similar function called “SUB Code”. You can also program an SID Code (Sender ID) under this function. A code can be up to 20 digits long.

❖ SEP Code

Registering a SEP Code allows you to use Polling Reception to receive faxes from the other fax machines which support Polling Reception. You can also program a PWD Code when you want to use a password under this function. A code can be up to 20 digits long.

❖ Line

If the optional extra G3 interface unit is installed, you can select the line type per destination.

❖ Fax header

You can select to print a fax header on fax messages the other party receives. The default is “1st Name”. See *Facsimile Reference <Advanced Features>*.

❖ Label insertion

With this function you can have the receiver's name printed on the message when it is received at the other end. The name is printed at the top of the page and will be preceded by “To”. You can also have a standard message stamped on the second and third lines after that.

Note

- Fax header and label insertion are also printed when sending by e-mail using fax functions.
- You can program a standard message apart from one of those registered in the machine. See “Programming, Changing, and Deleting Standard Messages”, *Facsimile Reference <Advanced Features>*.

❖ International TX mode

When setting the International TX mode to **[ON]**, the machine transmits more carefully by lowering transmission speed. However, communication times increase.

Registering a Fax Destination

- 1 Press the **[User Tools/Counter]** key.

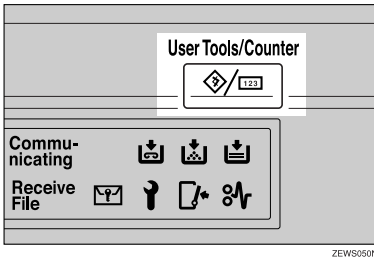

- 2 Press **[System Settings]**.

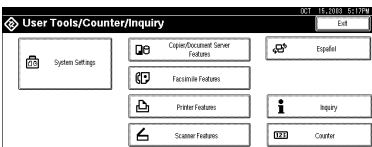

- 3 Press **[Key Operator Tools]**, and then press **[▼Next]**.

- 4 Press **[Address Book Management]**.

- 5 Press **[New Program]**.

Note

- To register a fax destination to a registered user, press the user (destination) key, or enter the registered number using the number keys.

- 6 Set the user's information.

Note

- To register a fax destination to a registered user, proceed to step 7.

To register the user (destination) name and key display

- 1 Press **[Change]** under **User (Destination) Name or Key Display**.

The user (destination) name or key display entry display appears.

- 2 Enter the user (destination) name or key display, and then press **[OK]**.

Note

- You can use the user name when selecting a fax destination.
- You can register the user code after the user name. For details, see p.70 "User Codes".

Reference

p.143 "Entering Text"

To select the title

- 1 To associate a user with a title, press the title key under **Select Title**.

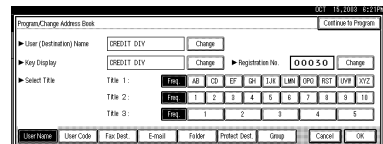

Note

- The keys you can select are as follows:
 - **[Freq.]**... Added to the page that is displayed first.
 - **[AB], [CD], [EF], [GH], [IJ], [LMN], [OPQ], [RST], [UVW], [XYZ], [1]** to [10]... Added to the list of items in the selected title.
- You can select **[Freq.]**, and one more page for each title.

- 7 Press **[Fax Dest.]**.
- 8 Enter the fax number using the number keys, and then press **[OK]**.

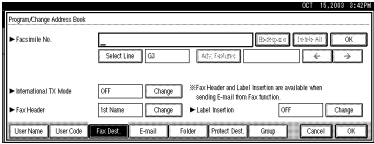

To select the line

- 1 Press **[Select Line]**.

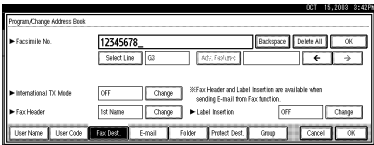

- 2 Select the line, and then press **[OK]**.

To program the SUB Code

- 1 Press **[Adv. Features]**, and then select **[SUB Code]**.
- 2 Press **[Change]** under TX SUB Code.
- 3 Enter a SUB Code using the number keys, and then press **[OK]**.
- 4 To enter a password, press **[Change]** under Password (SID).
- 5 Enter a password using the number keys, and then press **[OK]**.
- 6 Press **[OK]**.

To program the SEP Code

- 1 Press **[Adv. Features]**, and then select **[SEP Code]**.
- 2 Press **[Change]** under RX SEP Code.
- 3 Enter a SEP Code using the number keys, and then press **[OK]**.
- 4 To enter a password, press **[Change]** under Password (PWD).
- 5 Enter a password using the number keys, and then press **[OK]**.
- 6 Press **[OK]**.

To set the International TX mode

- 1 Press **[Change]** under International TX Mode.
- 2 Select **[OFF]** or **[ON]**, and then press **[OK]**.

To select the fax header

Note

You can register the fax header name in Program Fax Information under the system settings of Facsimile Features. See *Facsimile Reference <Advanced Features>*.

- 1 Press **[Change]** under Fax Header.
- 2 Select **[1st Name]** or **[2nd Name]**, and then press **[OK]**.

To set label insertion

When Label Insertion is set to ON, the receiver's name and standard messages are printed on the fax message when it is received at the other end.

- 1 Press **[Change]** under Label Insertion.
- 2 Select **[ON]**.
- 3 Press **[Change]** under Line 2.
- 4 Select a standard message to print on the second line. To stamp a customized message, press **[Custom Message]**.

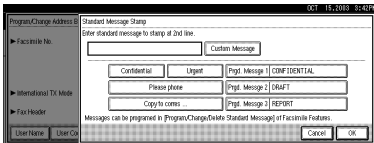

- 5 Enter a message, and then press **[OK]**.

Reference
p.143 "Entering Text"

- 6 Press **[OK]**.
- 7 Press **[Change]** under Line 3.
- 8 Select a standard message, and then press **[OK]**.
- 9 Press **[OK]**.

Note

- When a group is registered, you can add this fax destination to the group. See p.95 "Registering Destinations to a Group".

Changing a Registered Fax Destination

- 1 Press the **[User Tools/Counter]** key.
- 2 Press **[System Settings]**.
- 3 Press **[Key Operator Tools]**, and then press **[▼Next]**.
- 4 Press **[Address Book Management]**.
- 5 Select the registered fax destination user you want to change.

Press the user (destination) key, or enter the registered number using the number keys.

Note

- If you press , you can search for a user by user name/index, user code, fax destination, or e-mail address.

- 6 Press **[Fax Dest.]**.
- 7 Enter the items.

To change the fax number

- 1 Press **[Change]** under Facsimile No..



- 2 Enter the new fax number using the number keys, and then press **[OK]**.

To change the line

- 1 Press **[Select Line]**.

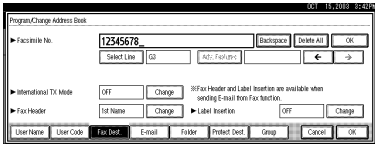

- 2 Select the line type.
- 3 Press **[OK]**.

To change the SUB Code

- 1 Press **[Adv. Features]**.
- 2 Press **[SUB Code]**.
- 3 Press **[Change]** under TX SUB Code.
- 4 Enter the new SUB Code, and then press **[OK]**.
- 5 To change the password, press **[Change]** under Password (SID).
- 6 Enter the new password, and then press **[OK]**.
- 7 Press **[OK]**.

To change the SEP Code

- 1 Press **[Adv. Features]**.
- 2 Press **[SEP Code]**.
- 3 Press **[Change]** under RX SEP Code.
- 4 Enter the new SEP Code, and then press **[OK]**.
- 5 To change the password, press **[Change]** under Password (PWD).
- 6 Enter the new password, and then press **[OK]**.
- 7 Press **[OK]**.

To change the fax header

- 1 Press **[Change]** under Fax Header.
- 2 Select the fax header, and then press **[OK]**.

To change the label insertion

- 1 Press **[Change]** under Label Insertion.
- 2 Press **[Change]** under Line 2.
- 3 Select the new standard message, or press **[Custom Message]** to enter the new message.
- 4 Press **[OK]**.
- 5 Press **[Change]** under Line 3.
- 6 Select the new standard message, and then press **[OK]**.
- 7 Press **[OK]**.
- 8 Press **[OK]**.

 **Note**

- To change the user name, see p.72 "To change the user (destination) name or key display".

Deleting a Registered Fax Destination

Note

- If you delete a destination that is a specified delivery destination, messages to its registered Personal Box, for example, cannot be delivered. Be sure to check the settings in the fax function before deleting any destinations.

- 1** Press the **[User Tools/Counter]** key.
- 2** Press **[System Settings]**.
- 3** Press **[Key Operator Tools]**, and then press **[▼Next]**.
- 4** Press **[Address Book Management]**.

To delete only the fax number

- 1** Select the fax destination user you want to delete.
Press the user (destination) key, or enter the registered number using the number keys.
- 2** Press **[Fax Dest.]**.
- 3** Press **[Change]** under Facsimile No..
- 4** Press **[Delete All]**, and then press **[OK]**.

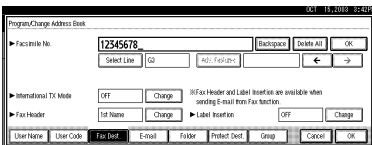

- 5** Press **[OK]**.

To delete all user information

- 1** Press **[Delete]**.
- 2** Select a user you want to delete.

Press the user (destination) key, or enter the registered number using the number keys.

- 3** Press **[Yes]**.

- 5** Press **[Exit]**.

Note

- To delete user codes together, see p.73 "Deleting a User Code".

- 6** Press the **[User Tools/Counter]** key.

E-mail Destination

Register e-mail destinations so you do not need to enter an e-mail address every time, and can send scan files from scanner or fax function by e-mail.

- It is easy to select the e-mail destination if you register “User (Destination) Name” and “Key Display” as the e-mail destination.
- You can register e-mail destinations as a group.
- You can use the e-mail address as the sender’s address when sending scan files in scanner mode. If you do this, set a protection code on the sender address to prevent use by unauthorized people. See p.93 “Registering a Protection Code”.
- You can select an e-mail address from an LDAP server, and then register it in the Address Book. For details about programming an LDAP server, See p.103 “Programming/Changing LDAP Server”. For details about searching an e-mail address from an LDAP server, See “Sending Scan File by E-mail”, *Scanner Reference*.

4

Registering an E-mail Destination

- 1 Press the **[User Tools/Counter]** key.

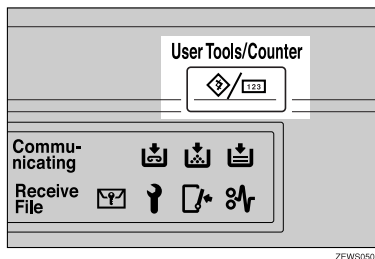

- 2 Press **[System Settings]**.

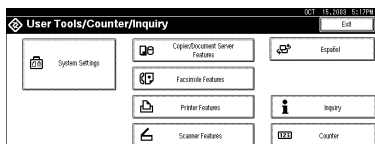

- 3 Press **[Key Operator Tools]**, and then press **[▼Next]**.

- 4 Press **[Address Book Management]**.

- 5 Press **[New Program]**.

Note

- To register an e-mail address to a registered user, press the user (destination) key, or enter the registered number using the number keys.

- 6 Set the user's information.

Note

- To register an e-mail address to a registered user, proceed to step 7.

To register the user (destination) name and key display

1 Press **[Change]** under **User (Destination) Name** or **Key Display**.

The user (destination) name or key display entry display appears.

2 Enter the user (destination) name or key display, and then press **[OK]**.

Note

- You can use the user name when selecting an address to send an e-mail to.
- You can register the user code after the user name. For details, see p.70 "User Codes".

Reference

p.143 "Entering Text"

To select the title

1 To associate a user with a title, press the title key under **Select Title**.

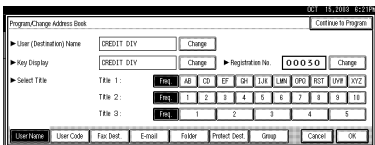

Note

- The keys you can select are as follows:
 - **[Freq.]**... Added to the page that is displayed first.
 - **[AB], [CD], [EF], [GH], [IJK], [LMN], [OPQ], [RST], [UVW], [XYZ], [1] to [10]**... Added to the list of items in the selected title.
- You can select **[Freq.]** and one more page for each title.

7 Press **[E-mail]**.

8 Press **[Change]** under **E-mail Address**.

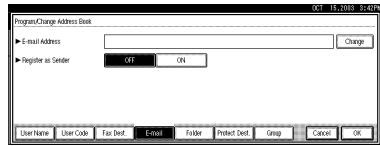

9 Enter the e-mail address.

Entering the e-mail address

1 Enter the e-mail address.

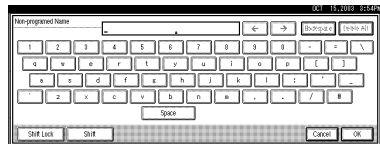

2 Press **[OK]**.

Using the e-mail address as the sender

1 Press **[ON]** under **Register as Sender**.

10 Press **[OK]**.

Note

- When a group is registered, other e-mail destinations can be added to the group. See p.95 "Registering Destinations to a Group".

Changing a Registered E-mail Destination

- 1** Press the **[User Tools/Counter]** key.
- 2** Press **[System Settings]**.
- 3** Press **[Key Operator Tools]**, and then press **[▼Next]**.
- 4** Press **[Address Book Management]**.
- 5** Select the registered e-mail address user you want to change.
Press the user (destination) key, or enter the registered number using the number keys.

 **Note**

- If you press , you can search for a user by user name/index, user code, fax destination, or e-mail address.

- 6** Press **[E-mail]**.
- 7** Enter the items.

To change the e-mail address

- 1** Press **[Change]** under **E-mail Address**.



- 2** Enter the e-mail address, and then press **[OK]**.

 **Reference**
p.143 "Entering Text"

- 8** Press **[OK]**.

 **Note**

- To change the user name, see p.72 "To change the user (destination) name or key display".

Deleting a Registered E-mail Destination

- 1** Press the **[User Tools/Counter]** key.
- 2** Press **[System Settings]**.
- 3** Press **[Key Operator Tools]**, and then press **[▼Next]**.
- 4** Press **[Address Book Management]**.

To delete only the e-mail address

- 1** Select the e-mail address user you want to delete.
Press the user (destination) key, or enter the registered number using the number keys.
- 2** Press **[E-mail]**.
- 3** Press **[Change]** under **E-mail Address**.
- 4** Press **[Delete All]**, and then press **[OK]**.
- 5** Press **[OK]**.

To delete all user information

- 1** Press **[Delete]**.
- 2** Select a user you want to delete.
Press the user (destination) key, or enter the registered number using the number keys.
- 3** Press **[Yes]**.
- 5** Press **[Exit]**.

Registering Folders

By registering a shared folder, you can send scan files to it directly.

There are two types of protocol you can use:

- **SMB**
For sending files to shared Windows folders
- **FTP**
Use when sending files to an FTP server.

Note

- For details about protocols, server names, and folder levels, ask your network administrator.
- You can stop unauthorized users accessing folders from the machine. See p.93 “Registering a Protection Code”.
- You can only select either SMB or FTP. If you change protocol after finishing your settings, all previous entries are cleared.
- You can register up to 50 folders per group. Files cannot be sent to a group with over 50 folders registered.

Reference

For details about network settings, see *Network Guide*.

For details about Scan to Folder, see *Scanner Reference*.

Using SMB to Connect

Note

- To register a folder in an FTP server, see p.89 “Using FTP to Connect”.

To register an SMB folder

- 1 Press the **[User Tools/Counter]** key.

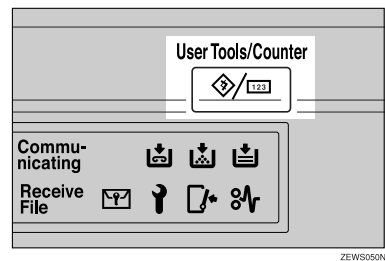

ZEWS050N

- 2 Press **[System Settings]**.

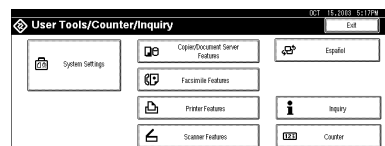

- 3 Press **[Key Operator Tools]**, and then press **[▼Next]**.

- 4 Press **[Address Book Management]**.

- 5 Press **[New Program]**.

Note

- To register a folder to a registered user, press the user (destination) key, or enter the registered number using the number keys.

6 Set the user's information.

Note

- To register a folder to a registered user, proceed to step 7.

To register the user (destination) name and key display

1 Press [Change] under User (Destination) Name or Key Display.

The user (destination) name or key display entry display appears.

2 Enter the user (destination) name or key display, and then press [OK].

Note

- You can use the user name as the folder name.
- You can register the user code after the user name. For details, see p.70 "User Codes".

Reference

p.143 "Entering Text"

To select the title

1 To associate a user with a title, press the title key under Select Title.

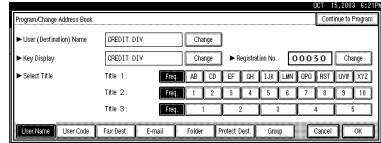

Note

- The keys you can select are as follows:
 - [Freq]... Added to the page that is displayed first.
 - [AB], [CD], [EF], [GH], [IJK], [LMN], [OPQ], [RST], [UVW], [XYZ], [1] to [10]... Added to the list of items in the selected title.
- You can select [Freq.] and one more page for each title.

7 Press [Folder].

8 Press [SMB].

Note

- To specify a folder, you can either enter the path manually, or locate the folder by browsing the network.

Reference

p.87 "To locate the folder manually"

p.87 "Using Browse Network to locate the folder"

To locate the folder manually

1 Press [Change] under Path.

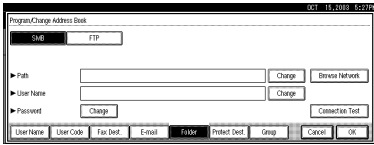

2 Enter the path where the folder is located.

Note

- Enter the path using this format: "\\ServerName\ShareName\PathName".
- You can also enter an IP address.
- You can enter a path using up to 128 characters.

3 Press [OK].

Note

- If the format of the entered path is not correct, a message appears. Press [Exit], and then enter the path again.

4 Press [Change] under User Name.

5 Enter the user name, and then press [OK].

Note

- This is a user name which is authorized to access the folder.

6 Press [Change] under Password.

7 Enter the user's password, and then press [OK].

Using Browse Network to locate the folder

1 Press [Browse Network].

The client computers sharing the same network as the machine appear.

Note

- You can enter your user name and password before pressing [Browse Network]. If you do, the Browse Network display only lists client computers you are authorized to access.

2 Select a client computer.



Shared folders under it appear.

Note

- You can press [Up One Level] to switch between levels.

3 Select the folder you want to register.

The Logon display appears.

Note

- If you have already entered an authorized user name and password, the Logon display will not appear. Proceed to step 6.

4 Enter the user name.

Note

- This is a user name which is authorized to access the folder.

- 5 Enter the user's password, and then press [OK].

The Browse Network display reappears.

Note

- If the entered user name or password is not correct, a message appears. Press [Exit], and then enter the user name and password again.

- 6 Press [OK].

- 9 Press [Connection Test] to check the path is set correctly.

- 10 Press [Exit].

Note

- If the connection test fails, check the settings, and then try again.

- 11 Press [OK].

Changing a registered SMB folder

- 1 Press the [User Tools/Counter] key.

- 2 Press [System Settings].

- 3 Press [Key Operator Tools], and then press [▼Next].

- 4 Press [Address Book Management].

- 5 Select the user of the registered folder you want to change.

Press the user (destination) key, or enter the registered number using the number keys.

Note

- If you press [Search], you can search for a user by user name/index, user code, fax destination, or e-mail address.

- 6 Press [Folder].

- 7 Select the items you want to change.

To change the protocol

- 1 Press [FTP].

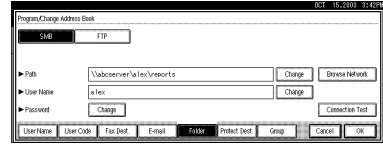

- 2 A confirmation message appears. Press [Yes].

Note

- Changing the protocol will clear all settings made under the previous protocol.

- 3 Enter each item again.

Reference

See steps 9 to 11 on p.89 "To register an FTP folder".

Changing items under SMB

- 1 Press [Change] under Path.

- 2 Enter the new path where the folder is located, and then press [OK].

Note

- You can also use Browse Network to specify a new folder. For details, see p.87 "Using Browse Network to locate the folder".

- 3 Press [Change] under User Name.

- 4 Enter the new user name, and then press [OK].

This is a user name which is authorized to access the folder.

- 5 Press [Change] under Password.

- 6 Enter the new password, and then press [OK].

8 Press [**Connection Test**] to check the path is set correctly.

9 Press [**Exit**].

 **Note**

- If the connection test fails, check the settings, and then try again.

10 Press [**OK**].

 **Note**

- To change the user (destination) name, see p.72 “Changing a User Code”.

Deleting a registered SMB folder

1 Press the [**User Tools/Counter**] key.

2 Press [**System Settings**].

3 Press [**Key Operator Tools**], and then press [**▼Next**].

4 Press [**Address Book Management**].

To delete only the registered folder

1 Select a user of the folder you want to delete.

Press the user (destination) key, or enter the registered number using the number keys.

2 Press [**Folder**].

3 Press [**FTP**].

A confirmation message appears.

4 Press [**Yes**].

5 Press [**OK**].

Settings under SMB are all cleared.

To delete all user information

1 Press [**Delete**].

2 Select a user you want to delete.

Press the user (destination) key, or enter the registered number using the number keys.

3 Press [**Yes**].

5 Press [**Exit**].

Using FTP to Connect

 **Note**

- To register a shared folder configured in Windows, see p.85 “Using SMB to Connect”.

To register an FTP folder

1 Press the [**User Tools/Counter**] key.

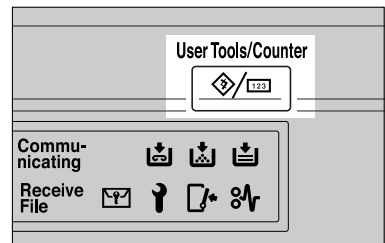

ZEWSS050N

2 Press [**System Settings**].

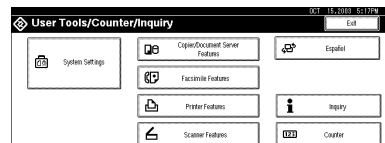

3 Press [**Key Operator Tools**], and then press [**▼Next**].

4 Press [**Address Book Management**].

5 Press **[New Program]**.

Note

- To register a folder to a registered user, press the user (destination) key, or enter the registered number using the number keys.

6 Set the user's information.

Note

- To register a folder to a registered user, proceed to step **7**.

To register the user (destination) name and key display

1 Press **[Change]** under **User (Destination) Name** or **Key Display**.

The user (destination) name or key display entry display appears.

2 Enter the user (destination) name or key display, and then press **[OK]**.

Note

- You can use the user name as the folder name.
- You can register the user code after the user name. For details, see p.70 "User Codes".

Reference

p.143 "Entering Text"

To select the title

1 To associate a user with a title, press the title key under **Select Title**.

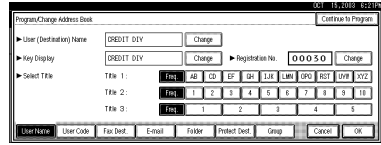

Note

- The keys you can select are as follows:
 - [Freq.]...** Added to the page that is displayed first.
 - [AB], [CD], [EF], [GH], [IJK], [LMN], [OPQ], [RST], [UVW], [XYZ], [1]** to **[10]**... Added to the list of items in the selected title.
- You can select **[Freq.]** and one more page for each title.

7 Press **[Folder]**.

8 Press **[FTP]**.

9 Press **[Change]** under **Server Name**.

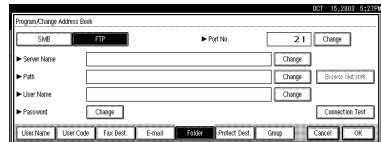

10 Enter the server name.

Note

- You can enter a server name using up to 64 characters.

11 Press **[Change]** under **Path**.

12 Enter the path.

Note

- You can enter an absolute path, using this format: “/user/home/username”; or a relative path, using this format: “directory/sub-directory”.
- If you leave the path blank, the login directory is assumed to be the current working directory.
- You can also enter an IP address.
- You can enter a path using up to 128 characters.

13 Press [OK].**Note**

- To change the port number, press [Change] under Port No.. Enter the port number using the number keys, and then press [#]. You can enter 1 to 65535.

14 Press [Change] under User Name.**15** Enter the user name, and then press [OK].**Note**

- This is a user name which is authorized to access the folder.

16 Press [Change] under Password.**17** Enter the user's password, and then press [OK].**18** Press [Connection Test] to check the path is set correctly.**19** Press [Exit].**Note**

- If the connection test fails, check the settings, and then try again.

20 Press [OK].**Changing a registered FTP folder****1** Press the [User Tools/Counter] key.**2** Press [System Settings].**3** Press [Key Operator Tools], and then press [▼Next].**4** Press [Address Book Management].**5** Select the user of the registered folder you want to change.

Press the user (destination) key, or enter the registered number using the number keys.

Note

- If you press , you can search for a user by user name/index, user code, fax destination, or e-mail address.

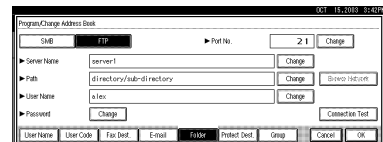
6 Press [Folder].**7** Select the items you want to change.**To change the protocol****1** Press [SMB].**2** A confirmation message appears. Press [Yes].**Note**

- Changing the protocol will clear all settings made under the previous protocol.

3 Enter each item again.**Reference**

See steps **3** to **11** on p.85 “To register an SMB folder”.

Changing items under FTP

- ❶ Press **[Change]** under **Server Name**.
 - ❷ Enter the new server name, and then press **[OK]**.
 - ❸ Press **[Change]** under **Path**.
 - ❹ Enter the new path, and then press **[OK]**.
 - ❺ Press **[Change]** under **User Name**.
 - ❻ Enter the new user name, and then press **[OK]**.
- This is a user name which is authorized to access the folder.
- ❼ Press **[Change]** under **Password**.
 - ❽ Enter the new password, and then press **[OK]**.

 **Note**

- To change the port number, press **[Change]** under **Port No.**. Enter the new port number using the number keys, and then press **[#]**.

- ❸ Press **[Connection Test]** to check the path is set correctly.

- ❹ Press **[Exit]**.

 **Note**

- If the connection test fails, check the settings, and then try again.

- ❺ Press **[OK]**.

 **Note**

- To change the user (destination) name, see p.72 "Changing a User Code".

Deleting a registered FTP folder

- ❶ Press the **[User Tools/Counter]** key.
- ❷ Press **[System Settings]**.
- ❸ Press **[Key Operator Tools]**, and then press **[▼Next]**.
- ❹ Press **[Address Book Management]**.

To delete only the registered folder

- ❶ Select a user of the folder you want to delete.

Press the user (destination) key, or enter the registered number using the number keys.

- ❷ Press **[Folder]**.
- ❸ Press **[SMB]**.

A confirmation message appears.

- ❹ Press **[Yes]**.
- ❺ Press **[OK]**.

Settings under FTP are all cleared.

To delete all user information

- ❶ Press **[Delete]**.
- ❷ Select a user you want to delete.

Press the user (destination) key, or enter the registered number using the number keys.

- ❸ Press **[Yes]**.
- ❹ Press **[Exit]**.

Registering a Protection Code

You can stop sender's names or folders being accessed by setting a protection code.

You can use this function to protect the following:

- Folders
You can prevent unauthorized access to folders.
- Sender's names (when sending e-mails)
You can prevent misuse of sender's names.

Note

- This function is not available when using Internet Fax to send e-mails.

Registering a Protection Code To a Single User

1 Press the **[User Tools/Counter]** key.

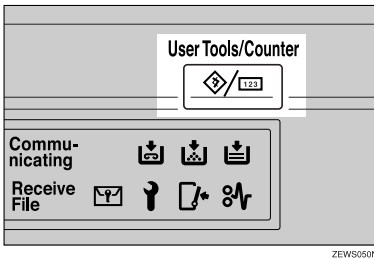

2 Press **[System Settings]**.

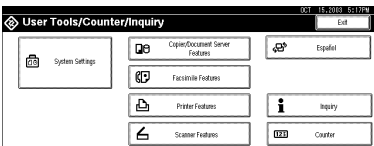

3 Press **[Key Operator Tools]**, and then press **[▼Next]**.

4 Press **[Address Book Management]**.

5 Press the user (destination) key you want to register a protection code to.

6 Press **[Protect Dest.]**.

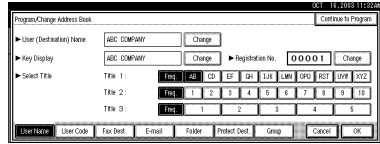

To protect the sender name

1 Press **[Protect]** under Sender's Name.

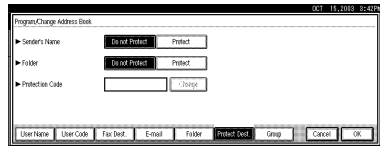

To protect the folder

1 Press **[Protect]** under Folder.

7 Press **[Change]** under Protection Code.

8 Enter a protection code using the number keys, and then press **[#]**.

Note

- You can enter up to eight digits.

9 Press **[OK]**.

10 Press **[Exit]**.

Registering a Protection Code To a Group User

- 1** Press the **[User Tools/Counter]** key.
- 2** Press **[System Settings]**.
- 3** Press **[Key Operator Tools]**, and then press **[▼Next]**.
- 4** Press **[Address Book: Program/Change/Delete Group]**.
- 5** Press the group key you want to register a protection code to.
- 6** Press **[Protect Dest.]**.

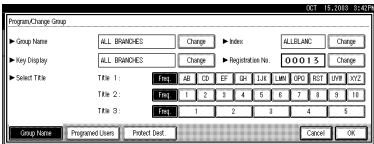

- 7** Press **[Protect]** under Folder.
- 8** Press **[Change]** under Protection Code.
- 9** Enter a protection code using the number keys, and then press **[#]**.

 **Note**

- You can enter up to eight digits.

- 10** Press **[OK]**.
- 11** Press **[Exit]**.

Registering Destinations to a Group

Register destinations to a group to easily control registered fax, e-mail and folders for each group.

To group destinations, the groups must be registered beforehand.

Note

- You can register up to 500 groups.
- When using Scan to Folder function, you cannot send scan files to a group with over 50 folders registered.
- You can set a protection code to prevent unauthorized access to the folders registered in a group. For details, see p.63 "Address Book: Program/Change/Delete Transfer Request".

Registering a New Group

- 1** Press the **[User Tools/Counter]** key.

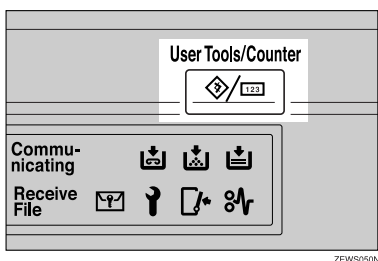

- 2** Press **[System Settings]**.

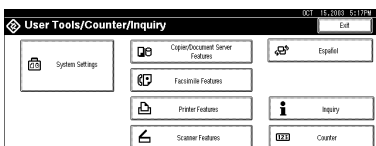

- 3** Press **[Key Operator Tools]**, and then press **[▼Next]**.

- 4** Press **[Address Book: Program/Change/Delete Group]**.

- 5** Press **[New Program]**.

- 6** Press **[Change]** under **Group Name**.

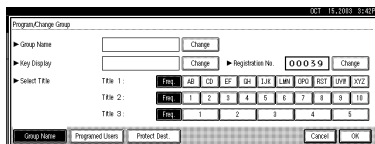

- 7** Enter the group name, and then press **[OK]**.

The Key Display name sets automatically.

Reference

p.143 "Entering Text"

- 8** Press the title key under **Select Title**, if necessary.

Note

- The keys you can select are as follows:
 - **[Freq.]**... Added to the page that is displayed first.
 - **[AB], [CD], [EF], [GH], [IJK], [LMN], [OPQ], [RST], [UVW], [XYZ], [1] to [10]**... Added to the list of items in the selected title.
- You can select **[Freq.]** and one more page for each title.

- 9** When you want to change the key display, press **[Change]** under **Key Display**. Enter the key display, and then press **[OK]**.

- 10** Press **[OK]**.

Registering Destinations to a Group

You can register destinations to a group.

When registering new destinations, you can also register groups at the same time.

- 1** Press the **[User Tools/Counter]** key.
- 2** Press **[System Settings]**.
- 3** Press **[Key Operator Tools]**, and then press **[▼Next]**.
- 4** Press **[Address Book Management]**.
- 5** Select the user (destination) to register in a group.

Press the user (destination) key, or enter the registered number using the number keys.

Note

- If you press **[🔍]**, you can search for a user by user name/index, user code, fax destination, or e-mail address.

- 6** Press **[Group]**.
- 7** Select a group to which you want to register the destinations.

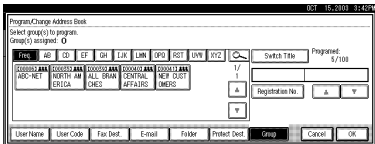

Note

- If you press **[🔍]**, you can search for a group by entering the group name.

- 8** Press **[OK]**.

Removing a Destination from a Group

- 1** Press the **[User Tools/Counter]** key.
- 2** Press **[System Settings]**.
- 3** Press **[Key Operator Tools]**, and then press **[▼Next]**.
- 4** Press **[Address Book Management]**.
- 5** Select the user (destination) to remove from a group.
Press the user (destination) key, or enter the registered number using the number keys.
- 6** Press **[Group]**.
- 7** Press the highlighted group key.

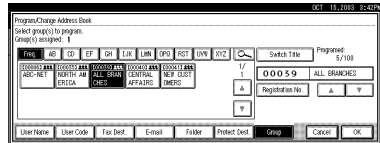

- 8** Press **[OK]**.

Displaying Destinations Registered in Groups

You can check the user (destination) of each group.

- 1** Press the **[User Tools/Counter]** key.
- 2** Press **[System Settings]**.
- 3** Press **[Key Operator Tools]**, and then press **[▼Next]**.
- 4** Press **[Address Book: Program/Change/Delete Group]**.
- 5** Select the group where the data you want to check is registered.

- 6** Press **[Programed Users]**.

All the user (destination) names appear.

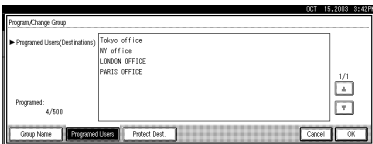

- 7** Press **[OK]**.

Changing a Group Name

- 1** Press the **[User Tools/Counter]** key.
- 2** Press **[System Settings]**.
- 3** Press **[Key Operator Tools]**, and then press **[▼Next]**.
- 4** Press **[Address Book: Program/Change/Delete Group]**.
- 5** Press the group key you want to change.
- 6** Enter the items.

To change the group name and key display

- 1** Press **[Change]** under **Group Name** or **Key Display**.

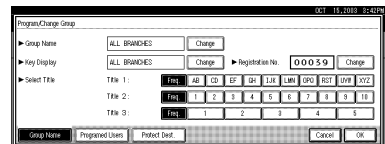

- 2** Enter the new group name or key display, and then press **[OK]**.

To change the title

- 1** Press the title key under **Select Title**.

To change the registration number

- 1** Press **[Change]** under **Registration No.**
- 2** Enter the new registration number using the number keys.
- 3** Press **[#]**.
- 7** Press **[OK]**.

Deleting a Group

- 1** Press the **[User Tools/Counter]** key.
- 2** Press **[System Settings]**.
- 3** Press **[Key Operator Tools]**, and then press **[▼Next]**.
- 4** Press **[Address Book: Program/Change/Delete Group]**.
- 5** Press **[Delete]**.
- 6** Press a group key you want to delete.
- 7** Press **[Yes]**.

Registering the Transfer Request

This section describes how to register the Transfer Station and Receiving Station used in the fax function's Transfer Request.

Note

- ❑ Before you can use Transfer Request, you must program the Polling ID and set the Transfer Report. See “Programming a Polling ID” and “Transfer Report”, *Facsimile Reference <Advanced Features>*.

Transfer Station

This is the machine that receives the Transfer Request to forward incoming messages to another destination.

Receiving Station

The facsimile or computer that receives messages from the Transfer Station.

Limitation

- ❑ When messages are transferred by fax, Transfer Stations must be machines of the same make as this, and have the Transfer Station function.
- ❑ When messages are transferred by e-mail, Transfer Stations must be machines of the same make as this, and have both the Transfer Station and Internet Fax functions.
- ❑ You cannot use Transfer Request without programming the fax number or e-mail address of the Requesting Party in the Address Book (Quick Dial or Speed Dial) of the Transfer Stations.

Note

- ❑ Polling ID's of the Requesting Party (this machine) and Transfer Stations must be identical.
- ❑ You can have up to 30 Receiving Stations per Transfer Station. If you specify a Transfer Station Group, the Group counts as a single receiver.

Registering a Transfer Station/Receiving Station

- 1 Press the **[User Tools/Counter]** key.

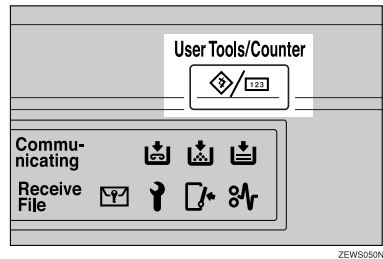

- 2 Press **[System Settings]**.



- 3 Press **[Key Operator Tools]**, and then press **[▼Next]**.
- 4 Press **[Address Book: Program/Change/Delete Transfer Request]**.
- 5 Press **[New Program]**.
- 6 Set the Transfer Request's information.

To register the Transfer Request name and key display

1 Press [Change] under Transfer Request Name or Key Display.

The user (destination) name or key display entry display appears.

2 Enter the Transfer Request name or key display, and then press [OK].

Reference
p.143 "Entering Text"

To select the title

1 To associate a Transfer Request name with a title, press the title key under Select Title.

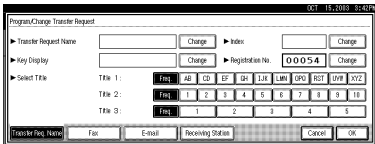

Note
 The keys you can select are as follows:

- [Freq.]... Added to the page that is displayed first.
- [AB], [CD], [EF], [GH], [IJK], [LMN], [OPQ], [RST], [UVW], [XYZ], [1] to [10]... Added to the list of items in the selected title.

You can select [Freq.] and one more page for each title.

7 Press [Fax].

8 Enter the items. See steps 8 and 9 on p.77 "Registering a Fax Destination".

9 Press [E-mail].

10 Enter the items. See steps 8 and 9 on p.82 "Registering an E-mail Destination".

11 Press [Receiving Station].

12 Specify the Receiving Stations.

Note

When specifying the Receiving Stations, use the numbers stored in Quick Dial keys, Speed Dials or Groups in the Transfer Station.

Quick Dial

1 Press [#Quick Dial].

2 Enter the number stored in the Quick Dial of the Transfer Station using the number keys.

For example, to select the destination stored in Quick Dial 01 of the Transfer Station, enter [0][1].

3 To specify an additional Receiving Station, press [Add].

Speed Dial

1 Press [#*Speed Dial].

2 Enter the Speed Dial using the number keys.

For example, to select the destination stored in Speed Dial 12 of the Transfer Station, enter [1][2].

3 To specify an additional Receiving Station, press [Add].

Group Dial

- ❶ Press [**#**][**X**][**X**Group Dial].
- ❷ Enter the Group number using the number keys.
For example, to select the destinations stored in Group 04 of the Transfer Station, enter [**0**][**4**].
- ❸ To specify an additional Receiving Station, press [**Add**].

❶ When you have specified all the Receiving Stations, press [**OK**].

❷ Press [**Exit**].

Changing a Registered Transfer Station/Receiving Station

- ❶ Press the [**User Tools/Counter**] key.
- ❷ Press [**System Settings**].
- ❸ Press [**Key Operator Tools**], and then press [**▼Next**].
- ❹ Press [**Address Book: Program/Change/Delete Transfer Request**].
- ❺ Select the registered Transfer Station/Receiving Station user you want to change.

Press the user (destination) key, or enter the registered number using the number keys.

 **Note**

- If you press , you can search for a user by Transfer Request name, fax destination, or e-mail address.

❻ Enter the items.

To change the Transfer Request name and key display

- ❶ Press [**Change**] under Transfer Request Name or Key Display.
- ❷ Enter the new Transfer Request name or key display, and then press [**OK**].

To change the title

- ❶ Press the title key under Select Title.

To change the Transfer Station

- ❶ Press [**Fax**].
Proceed to step ❸ when messages are transferred by e-mail.
- ❷ Change the Transfer Station's information. See steps ❷ and ❸ on p.79 "Changing a Registered Fax Destination".
- ❸ Press [**E-mail**].
- ❹ Change the Transfer Station's information. See steps ❷ and ❸ on p.84 "Changing a Registered E-mail Destination".

To change the Receiving Station

- ❶ Press [**Receiving Station**].
- ❷ Select the Receiving Station you want to change.
- ❸ Press [**Clear**] to clear the number, and then enter the new number using the number keys.
- ❹ Press [**OK**].
- ❺ Press [**Exit**].

Deleting a Registered Transfer Station/Receiving Station

- 1** Press the **[User Tools/Counter]** key.
- 2** Press **[System Settings]**.
- 3** Press **[Key Operator Tools]**, and then press **[▼Next]**.
- 4** Press **[Address Book: Program/Change/Delete Transfer Request]**.
- 5** Press **[Delete]**.
- 6** Select a **Transfer Request** you want to delete.
Press the **Transfer Request** key, or enter the registered number using the number keys.
- 7** Press **[Yes]**.
- 8** Press **[Exit]**.

4

Programming/Changing LDAP Server

Programming an LDAP server allows you to look up e-mail destinations from the LDAP server Address Book directly. This function is available when you send scan files by e-mail using scanner function.

Note

- Select **[ON]** in the Use LDAP Server setting to use this function. See p.66 "Use LDAP Server".
- This function supports LDAP Version 2 and 3.
- To ensure successful searching, make sure the server name and port number are entered correctly. For details, ask your network administrator.

Programming an LDAP Server

- 1** Press the **[User Tools/Counter]** key.

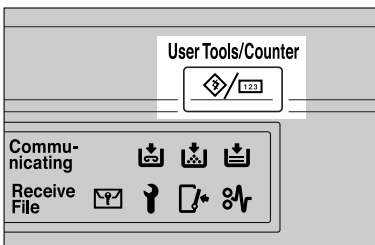

- 2** Press **[System Settings]**.

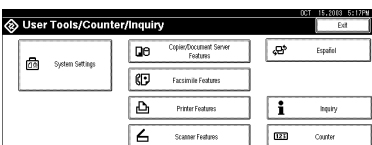

- 3** Press **[Key Operator Tools]**, and then press **[▼Next]** twice.

- 4** Press **[Program/Change LDAP Server]**.

- 5** Enter the items.

To enter an identification name

- 1** Press **[Change]** under Identification Name.

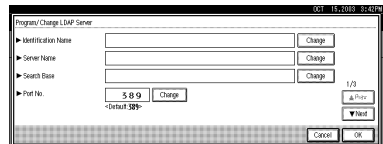

- 2** Enter the server's identification name.

- 3** Press **[OK]**.

To enter a server name

- 1** Press **[Change]** under Server Name.

- 2** Enter the LDAP server name.

- 3** Press **[OK]**.

To enter the search base

- 1** Press **[Change]** under Search Base.

- 2** Enter the search base.

Note

- For example, if you enter "ou=sales department, o=ABC", searching will start below the sales department level of ABC company (here, "ou" stands for organization unit, and "o" stands for company).

- 3** Press **[OK]**.

To enter a port number

- 1 Press **[Change]** under Port No..
- 2 Enter the port number using the number keys, and then press **[#]**.

To set authentication

- 1 Press **[Next]**.
- 2 Press **[ON]** or **[High Security]** under Authentication.



- Note**
- [High Security]** is not available with LDAP Version 2.
 - When **[ON]** or **[High Security]** is selected, the administrator account name and password is required to access the LDAP server.
 - When **[High Security]** is selected, you can use a generic password unique to the network. If you do this, the server also requires the same setting. For details, ask your network administrator.

To enter the user name and password

- Note**
- To use the administrator account for authentication, enter the account name and password here.
 - If you leave the user name and password blank, users will be prompted for the password every time they attempt to connect to the LDAP server.

- 1 Press **[Next]**.
- 2 Press **[Change]** under User Name.
- 3 Enter the user name, and then press **[OK]**.
- 4 Press **[Change]** under Password.
- 5 Enter the password, and then press **[OK]**.

To test the connection

- 1 Press **[Connection Test]**.
A connection test is carried out.
 - 2 Press **[Exit]**.
- Note**
- If the connection test fails, check your settings, and then try again.

To set search options

Note

- You can search the LDAP server data using keywords below: Name, E-mail Address, Fax Destination, Company Name, Department Name. You can specify an additional keyword. This must be predefined in your LDAP database.

- 1** Press [Next] twice.
- 2** Press [Change] under Attribute.
- 3** Enter the attribute you want to use for searching e-mail addresses, and then press [OK].
- 4** Press [Change] under Key Display.
- 5** Enter the attribute's display name, and then press [OK].

Note

- For example, if you want to sort e-mail addresses by employees' number, enter "employeeNo" in the Attribute field, and "Employee No." in the Key Display field.

- 6** Press [OK].
- 7** Press [Exit].
- 8** Press the [User Tools/Counter] key.

Changing an LDAP Server

- 1** Press the [User Tools/Counter] key.
- 2** Press [System Settings].
- 3** Press [Key Operator Tools], and then press [▼Next] twice.
- 4** Press [Program/Change LDAP Server].
- 5** Change the items.

To change an identification name

- 1** Press [Change] under Identification Name.

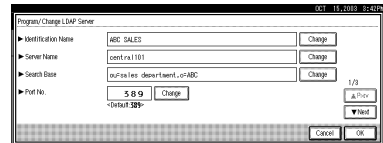

- 2** Enter a new identification name for the server.
- 3** Press [OK].

To change the server name

- 1** Press [Change] under Server Name.
- 2** Enter the new LDAP server name.
- 3** Press [OK].

To change the search base

- 1** Press [Change] under Search Base.
- 2** Enter the new search base.
- 3** Press [OK].

To change a port number

- 1 Press **[Change]** under Port No..
- 2 Enter the new port number using the number keys, and then press **[#]**.

To change authentication

- 1 Press **[Next]**.
- 2 Select **[ON]** or **[High Security]** if you want to activate authentication. Select **[OFF]** to cancel it.

 **Note**

- [High Security]** is not available when the LDAP Version is 2.
- When **[ON]** or **[High Security]** is selected, the administrator account name and password is required to access the LDAP server.
- When **[High Security]** is selected, you can use a generic password unique to the network. If you do this, the server also requires the same setting. For details, ask your network administrator.

To change the user name and password

- 1 Press **[Next]**.
- 2 Press **[Change]** under User Name.
- 3 Enter the new user name, and then press **[OK]**.
- 4 Press **[Change]** under Password.
- 5 Enter the new password, and then press **[OK]**.

 **Note**

- The user name and password are of a user who is authorized to access the LDAP server.
- You can press **[Connection Test]** to check if the new settings work.

To change search options

- 1 Press **[Next]** twice.
- 2 Press **[Change]** under Attribute.
- 3 Enter a new attribute, and then press **[OK]**.
- 4 Press **[Change]** under Key Display.
- 5 Enter the attribute's new display name, and then press **[OK]**.
- 6 Press **[OK]**.
- 7 Press **[Exit]**.
- 8 Press the **[User Tools/Counter]** key.

5. Troubleshooting

If Your Machine Does Not Operate As You Want

The following chart gives explanations of common problems and messages. If other messages appear, follow the instructions displayed.

Note

- ❑ If you cannot make copies as you want because of the paper type, paper size or paper capacity problems, use recommended paper. See p.163 "Copy Paper".

General

Problem	Causes	Solutions
"Please wait." appears	This message appears when you turn on the operation switch or change the toner bottle.	Wait for the machine to get ready.
The display is off.	The screen contrast knob is turned to the dark position.	Set the screen contrast knob to the light position to see the display panel properly.
	The machine is in Energy Saver mode.	Press the [Energy Saver] key to cancel Energy Saver mode.
	The operation switch is turned off.	Turn on the operation switch.
Nothing happens when the operation switch is turned on.	The main power switch is turned off.	Turn on the main power switch.
Memory is full.	There are too many scanned pages or stored files: hard disk capacity is exceeded.	Press [Delete File] to delete unnecessary documents.
The function status indicator is red.	The function associated with the red indicator was interrupted.	Press the function key corresponding to the indicator. Follow the instructions that appear on the control panel.
The user code entry display appears.	Users are restricted by user management.	Enter the user code (up to 8 digits), and then press [#] .

Problem	Causes	Solutions
The main power indicator continues blinking and does not turn off when pressed.	This occurs in the following cases: <ul style="list-style-type: none"> • The exposure glass cover or the ADF is open. • The machine is communicating with external equipment. • The hard disk is active. 	Close the exposure glass cover or ADF, and check if the machine communicating with a computer.
Original images are printed on the reverse side of the paper.	You may have loaded the paper incorrectly.	Load paper correctly. Load paper into Tray 1-4 with the print side up, and into the LCT or bypass tray with the print side down. See p.112 "Orientation-Fixed Paper or Two-Sided Paper".
Misfeeds occur frequently.	The tray's side guides may not be locked.	Check the side guides are locked. See p.122 "Changing the Paper Size".
	The tray's end guide may not be set properly.	Check the end guide is set properly. See p.122 "Changing the Paper Size".
	You may have loaded paper of a size not shown on the paper size selector.	When using paper of a size that cannot be detected automatically, use Tray Paper Settings to set the paper size. See p.55 "Tray Paper Size: Tray 1-4" and p.163 "Copy Paper".
An error message remains, even if misfed paper is removed.	When a misfeed message appears, it remains until you open and close the cover, as required.	Clear misfed paper, and then open and close the front cover. See p.116 "Clearing Misfeeds".
An error message remains, even if consumables are replaced and/or misfed paper is removed.	This may occur if the HDD is not installed.	Press the [Start] key.
Cannot print in duplex mode.	You cannot use paper in the bypass tray for duplex printing.	For duplex printing, select Tray 1-4 in copier mode or with the printer driver.
	[1 Sided Copy] is selected for Paper Type: Tray 1-4.	Select [2 Sided Copy] for Paper Type: Tray 1-4. See p.56 "Paper Type: Tray 1-4"
You forgot your key operator code	—	Contact your service representative.

Document Server

Problem	Solutions
"Scanned pages exceeded max. number. Do you want to store the scanned pages as a file?" appears.	<p>The number of scanned pages exceeds the capacity per file of the Document Server.</p> <p>To store scanned pages as a file, press [Store File]. Scanned data is stored as a file in the Document Server. If you do not want to store scanned pages, press [No]. Scanned data is deleted.</p>
You forgot your password.	<p>You can temporarily access password-protected files. Press [Unlock] in Password Management for Stored Files in User Tools. See p.147 "Temporarily Disabling Document Security" .</p> <p>You can delete all stored documents at once with User Tools. See p.66 "Delete All Files" .</p> <p>Make sure no important documents are stored in the Document Server before deleting all stored documents.</p>
You cannot find out what is stored in a file.	Check the date or time column in the Document Server: Select Files to Print display.
	Check document content by printing it's first page. Press the line of the document in the Document Server: Select Files to Print display, and then press [Print 1st Page] followed by the [Start] key.
Memory frequently becomes full.	<ul style="list-style-type: none"> • Press [Delete File] to delete selected documents to increase available memory. • Delete documents stored using the scanner function. See <i>Scanner Reference</i>.
You want to check print quality before making a large print run.	Check print quality by printing out only the first set using the [Sample Copy] key.
"Original is being scanned by another function." appears.	The copier or scanner function is in use. To cancel a job in progress, first press [Exit] , and then press the [Copy] key or [Scanner] key. Next, press the [Clear/Stop] key. When the message "[Stop] key was pressed. Stop printing?" appears, press [Stop] .

Loading Paper

Reference

For paper types and sizes, see p.163 "Copy Paper".

Loading Paper into Paper Trays

Note

- You can change the paper size, see p.122 "Changing the Paper Size".

1 Pull out the paper tray until it stops.

2 Square the paper and load it in the tray with the copying face up.

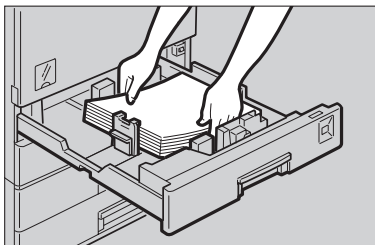

ZEWY100E

Important

- If you add paper to a paper tray with paper left inside, a misfeed might occur.
- Do not stack paper over the limit mark.
- When loading small quantities of paper, be careful not to squeeze the side guide in too tightly, as the paper will not feed properly.

Setting special paper in the paper tray 2

1 Load the special paper below the limit mark of the tray.

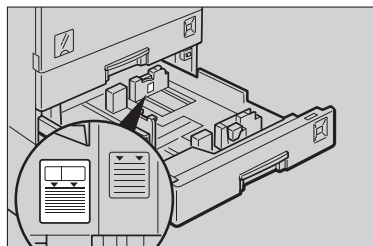

ZEWY110E

Note

- Fan the paper before loading.
- When using paper such as translucent paper, straighten curled or warped paper before loading.

3 Push the paper tray in until it stops.

Loading Paper into Large Capacity Tray (optional)

Note

- Load copy paper of the same size and orientation in both left and right side trays.

1 Pull out the LCT.

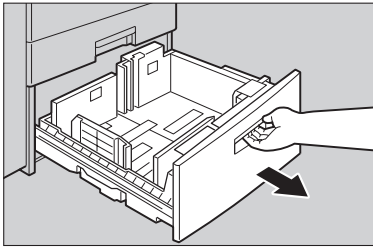

ZEWY010E

2 Square the paper, and then load it in the tray with the copying face up.

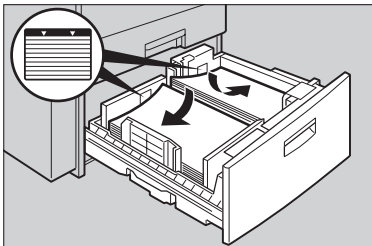

ZEWY020E

Important

- Align the right edge of the right copy paper stack with the right edge of the tray.
- Align the left edge of the left copy paper stack with the left edge of the tray.
- Do not stack paper over the limit mark.













Note

- Fan the paper before loading.
- Straighten curled or warped paper before loading.

3 Push the paper tray in until it stops.

Orientation-Fixed Paper or Two-Sided Paper

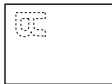
Orientation-fixed (top to bottom) or two-sided paper (for example, letterhead paper, punched paper, or copied paper) might not print correctly, depending on how the originals and paper are placed. Select **[Yes]** in Letterhead Setting under Copier/Document Server Features, and then place the original and paper as shown below (see *Copy Reference*). When printing with the printer function, placing orientation is the same.

Copy Mode		Paper Tray	LCT	Bypass Tray	
				Original on the exposure glass	Original on the ADF
Paper placing direction 	1 Sided				
	2 Sided			—	—
Paper placing direction 	1 Sided		—		
	2 Sided		—	—	—

GEWH100E

Adding Toner

When  appears, it is time to add toner.

WARNING:

- ***Do not incinerate used toner or toner containers. Toner dust might ignite when exposed to an open flame. Dispose of used toner containers in accordance with local regulations.***

CAUTION:

- *Keep toner (used or unused) and toner containers out of reach of children.*

Important

- Fault may occur if you use toner other than the recommended type.
- When adding toner, do not turn off the operation switch. If you do, settings will be lost.
- Always add toner when the machine instructs you.
- Do not repeatedly install and remove toner bottles. This will result in toner leakage.
- Do not shake the removed toner bottle. Remaining toner might scatter.

Note

- You can make about 50 copies even after the " Toner is almost empty." and "Replace Toner Bottle." messages appear, but replace toner early to prevent poor copy quality.

Reference

For details about toner storage, see p.132 "Toner Storage".

Removing Toner

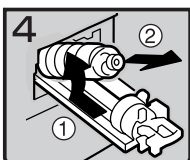
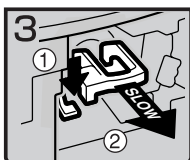
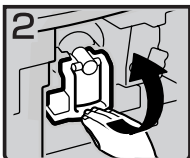

- 1: Open the front cover of the machine.
- 2: Lift the green lever.
- 3: Push the green lever, and then gently pull out the holder.
- 4: Push the toner bottle back to raise its top, and then gently pull out the bottle.

5

Inserting Toner

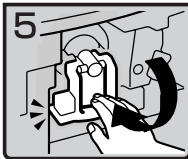
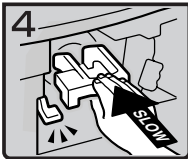
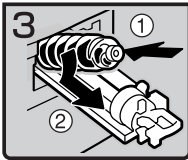
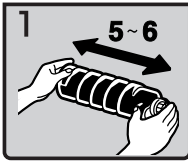

- 1: Hold the new bottle horizontally and shake it from side to side five or six times.

 **Note**

- Do not remove the black cap before shaking.

- 2: Remove the black cap.

 **Note**

- Do not remove the inner cap.

- 3: Put the toner bottle on the holder, and then pull its top forward.

- 4: Push in the green lever until it clicks.

- 5: Press down the green lever.
- 6: Close the machine's front cover.

Clearing Misfeeds

CAUTION:

- *The fusing section of this machine might be very hot. Caution should be taken when removing misfed paper.*

Important

- When clearing misfeeds, do not turn off the operation switch. If you do, your copy settings will be lost.
- To prevent misfeeds, do not leave any torn scraps of paper inside the machine.
- If paper misfeeds occur frequently, contact your service representative.

Note

- More than one misfed area may be indicated. When this happens, check all the areas indicated. See the following charts: A, B, C, D, P, R, Y, Z
- Inside the finisher, or inside the front cover, there is a sticker explaining how to remove misfed paper.

■ When D is lit

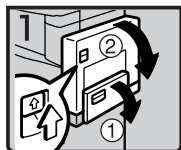

1. Open the bypass tray, and then open the duplex unit.

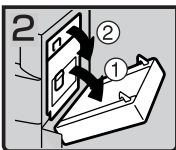

2. Open the right cover, and then open the upper right cover.

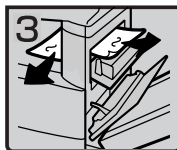

3. Remove the misfed paper.

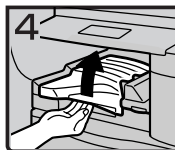

4. If you cannot remove the misfed paper, open the top cover of the bridge unit.

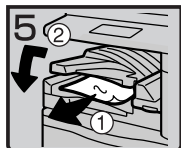

5. Remove the misfed paper.
6. Close the cover.

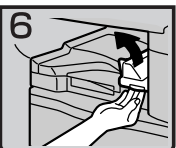

7. If you cannot remove the misfed paper, open the right cover of the bridge unit.

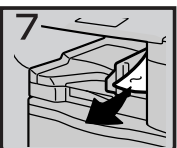

8. Remove the misfed paper.
9. Close the cover.

5

■ When B is lit

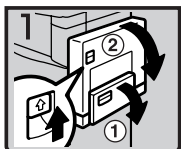

1. Open the bypass tray, and then open the duplex unit.

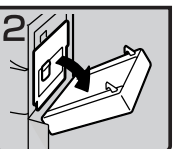

2. Open the right cover, and then open the upper right cover.

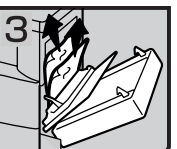

3. Remove the misfed paper.

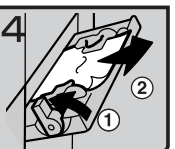

4. Push up the paper guide release lever, and then remove the misfed paper.
5. Pull down the paper guide release lever, and then close the bypass tray.

■ When A is lit

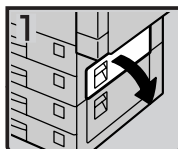

1. Open the upper right cover.

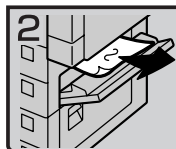

2. Remove the misfed paper.

■ When C is lit

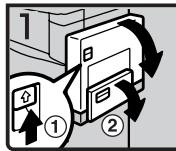

1. Open the bypass tray, and then open the duplex unit.

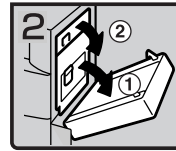

2. Open the right cover, and then open the upper right cover

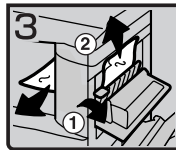

3. Remove the misfed paper.

! Important
A paper jam warning will not be cleared until the covers ①, ② are opened and the operation switch is set to ON.

4. Close the cover.

5. Close the duplex unit and front cover.

If you still cannot remove misfed paper Contact your service representative.

5

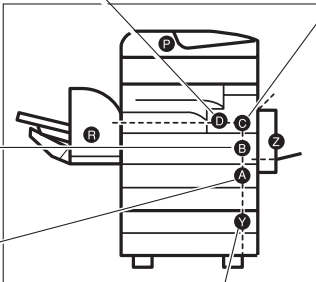

■ When Y is lit

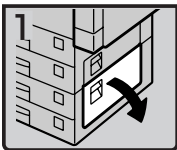

1. Open the right cover.

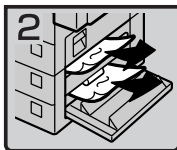

2. Remove the misfed paper.
3. Close the cover.

You can make an enlarged copy of this page and stick it on walls in the proximity of the machine.

ZLFX260E

■ When P is lit



1. Open the cover of the auto document feeder (ADF), and then remove the misfed original.

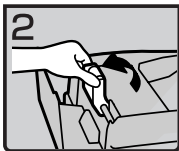

2. Lift the lever.

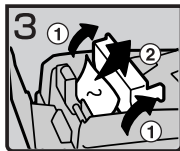

3. Open the cover, and then remove the misfed original.



4. If you cannot remove the misfed original, open the ADF external cover, and then remove the misfed original.

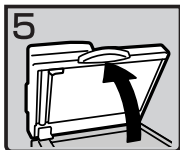

5. Open the auto document feeder (ADF).

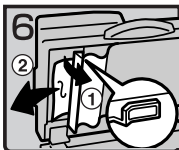

6. Pull the green lever in the upper left corner, and then remove the misfed original.

5

■ When R is lit

1000-sheet finisher

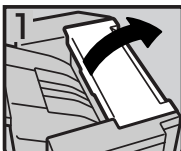

1. Open the upper cover.

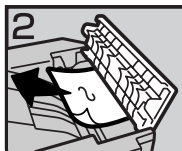

2. Remove the misfed paper.

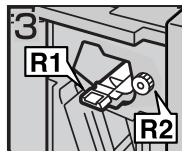

3. Open the front cover.

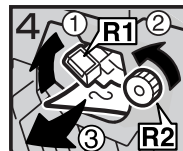

4. Hold up lever R1, turn knob R2, and then remove the misfed paper.

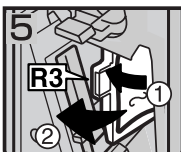

5. Open lever R3 to the left, and then remove the misfed paper.

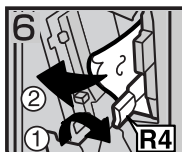

6. Push lever R4 to the right, and then remove the misfed paper.

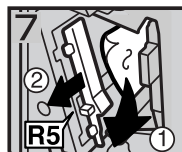

7. Pull lever R5, and then remove the misfed paper.

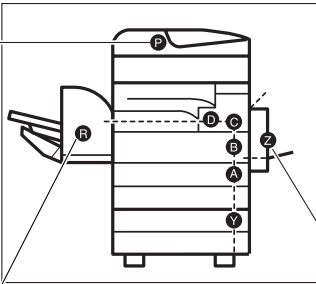

■ When Z is lit

1. Open the duplex unit.
2. Raise cover Z1, and then remove the misfed paper.
3. If you cannot remove the misfed paper, raise cover Z2, and then remove any that is there.
4. Close the unit.

500-sheet finisher

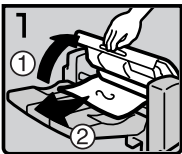

1. Open the upper cover, and then remove the misfed paper.

You can make an enlarged copy of this page and stick it on walls in the proximity of the machine

ZLFXZ70E

Changing the Paper Size

Preparation

Be sure to select the paper size with User Tools and the paper size selector. If you do not, misfeeds might occur. See p.55 "Tray Paper Size: Tray 1-4".

Important

- If you want to change the paper size set in the LCT, contact your service representative.

Reference

For details about paper sizes and types, see p.163 "Copy Paper".

5

Changing the Paper Size of the Paper Tray

1 Make sure the paper tray is not in use. Then, pull the paper tray out slowly.

2 If paper is loaded in the tray, remove it.

3 While pressing the release lever, adjust the back guide.

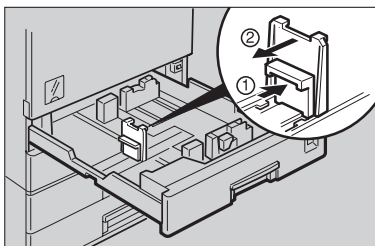

ZEWY150E

4 Release the side lever.

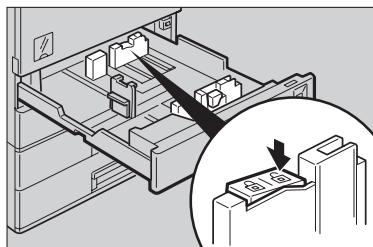

ZEWY160E

5 While pressing the release lever, adjust the side guides.

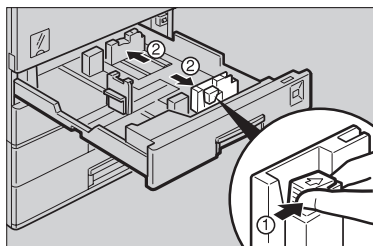

ZEWY170E

6 Square the paper, and then load it in the tray with the copying face up.

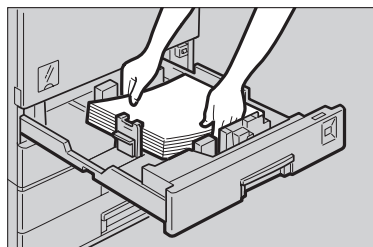

ZEWY180E

Important

- Do not stack paper over the limit mark.
- Make sure the paper stack is flush against the right side guide.

Note

- Fan the paper before loading.
- Straighten curled or warped paper before loading.

7 While pressing the release lever, adjust the side guides to the new paper size.

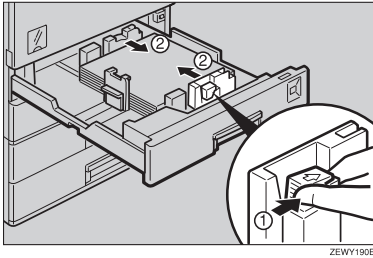

Important

- When loading small quantities of paper, be careful not to squeeze the side guide in too tightly, as the paper will not feed properly.

8 Lock the side lever.

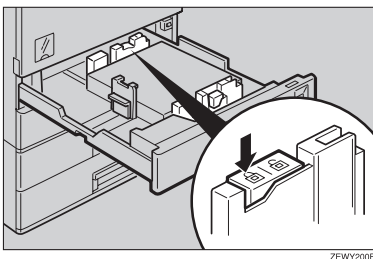

9 While pressing the release lever, adjust the back guide to the new paper size.

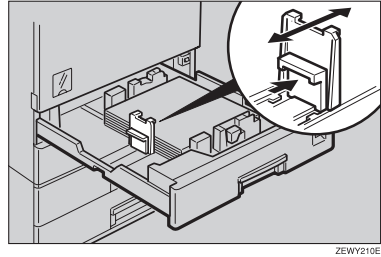

10 Adjust the paper size selector to the new paper size.

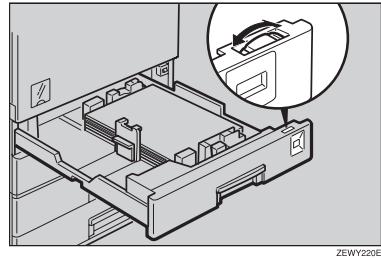

5

To adjust the paper size to a size not indicated on the paper size selector

- 1** Set the paper size selector to the * mark.
- 2** Press the [User Tools/Counter] key.
- 3** Press [System Settings].
- 4** Press [Tray Paper Settings].
- 5** Press [Tray Paper Size: Tray 1], [Tray Paper Size: Tray 2], [Tray Paper Size: Tray 3] or [Tray Paper Size: Tray 4].
- 6** Select the required size, and then press [OK].

- 7 Press **[Exit]** or the **[User Tools/Counter]** key to exit User Tools.

 **Reference**

p.55 "Tray Paper Size: Tray 1-4"

- 11 Gently push the paper tray in until it stops.
- 12 Check the paper size shown on the display panel.

Adding Staples

Important

- ❑ Stapling failures or jams may occur if you use a staple cartridge other than that recommended.

Reference

For details about the type of finisher, see p.19 “External Options”.

500-Sheet Finisher

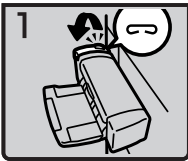

ZEWJ000E

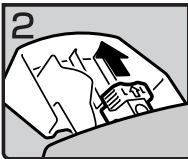

ZEWJ010E

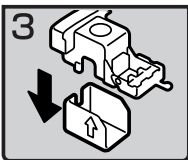

ZEWJ020E

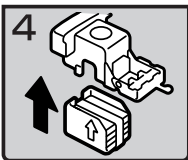

ZEWJ030E

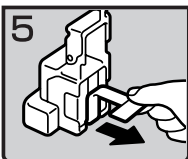

ZEWJ040E

- 1: Open the side cover.
- 2: Remove the cartridge.
- 3: Take out the empty refill in the direction of the arrow.
- 4: Push in the new refill until it clicks.
- 5: Pull out the ribbon.

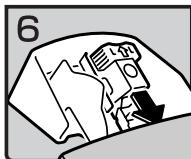

ZEWJ050E

- 6: Reinstall the cartridge.
- 7: Close the side cover.

1000-Sheet Finisher

5

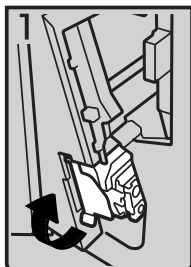

ZGJS801E

- 1: Open the front cover of the finisher, and then pull out the staple unit.

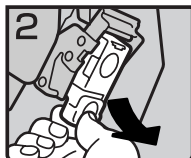

ZGJS802E

- 2: Hold the green lever, and then gently pull out the cartridge.

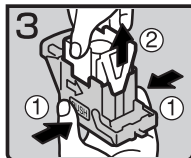

ZGJS803E

- 3: Hold both sides of the cartridge.
- 4: Pull up the upper unit of the cartridge.

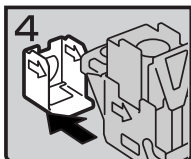

ZGJS804E

- 5: Take out the empty refill in the arrow direction.

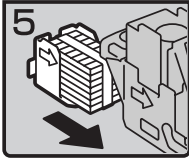

ZGJS805E

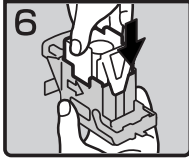

ZGJS806E

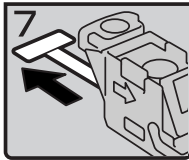

ZGJS807E

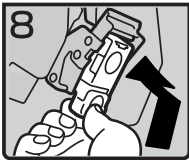

ZGJS808E

- 6: Align the arrows on the new refill with those on the cartridge, and then push in the refill until it clicks.
- 7: Gently push down the upper unit into the cartridge.
- 8: Pull out the ribbon.
- 9: Hold the green lever while pushing in the cartridge until it clicks.
- 10: Push back the staple unit, and then close the front cover of the finisher.

Removing Jammed Staples

Note

- ❑ Curled paper may cause staples to jam. To avoid this, turn copy paper over in the tray. If there is no improvement, change to a stiffer copy paper.
- ❑ When the 500-sheet finisher is installed, after removing jammed staples, staples will not be ejected the first few times you try to use the stapler.

Reference

For types of finisher, see p.19 “External Options”.

500-Sheet Finisher

5

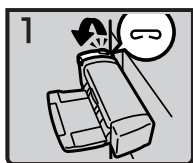

ZEWJ000E

- 1: Open the side cover.



ZEWJ010E

- 2: Remove the cartridge.

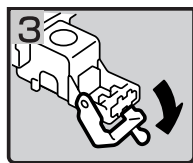

ZEWJ100E

- 3: Open the face plate.

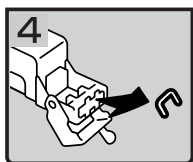

ZEWJ107E

- 4: Remove the jammed staples.

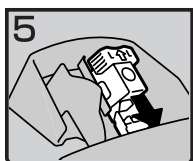

ZEWJ107E

- 5: Reinstall the cartridge.
- 6: Close the side cover.

1000-Sheet Finisher

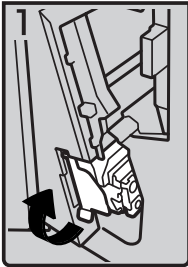

ZGJS801E

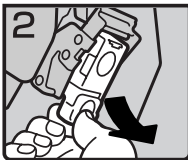

ZGJS802E

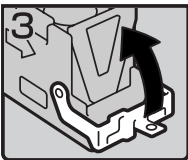

ZGJS813E

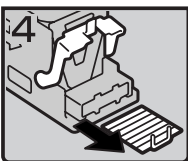

ZGJS814E

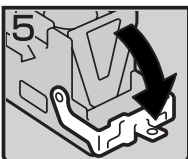

ZGJS815E

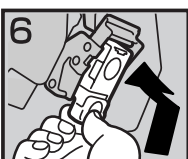

ZGJS864E

- 1: Open the front cover of the finisher, and then pull out the staple unit.

- 2: Hold the green lever while gently pulling out the cartridge.

- 3: Open the cartridge's face plate.

- 4: Remove any jammed staples.

- 5: Pull down the cartridge's face plate until it clicks.

- 6: Hold the green lever while pushing in the cartridge until it clicks.
- 7: Push back the staple unit, and then close the front cover of the finisher.

Dos and Don'ts

CAUTION:

- *Unplug the power cord from the wall outlet before you move the machine. While moving the machine, you should take care that the power cord will not be damaged under the machine.*

Important

- Do not turn the power off while the On indicator is lit or blinking. Doing so may damage the hard disk.
- Before unplugging the power cord or turning off the main power switch, make sure remaining memory space is at 100%, as shown on the display. See p.25 "Turning Off the Power" and p.25 "Turning Off the Main Power".
- When you use this machine for a long time in a confined space without good ventilation, you may detect an odd smell. To keep the workplace comfortable, we recommend that you keep it well ventilated.
- Do not touch areas on or around the fusing unit. These areas get hot.
- After making copies continuously, the exposure glass may become warm—this is not a malfunction.
- The area around the ventilation hole might feel warm. This is caused by exhaust air and is not a malfunction.
- When the machine is not in use and in stand-by mode, you may hear a small noise inside. This is caused by the image stabilization process and is not a malfunction.
- Do not turn off the operation switch while copying or printing. Make sure all copying or printing has finished first.
- The machine might not produce good copy images if condensation forms inside as a result of rapid temperature change.
- Do not open the covers of the machine while copying or printing. If you do, misfeeds might occur.
- Do not move the machine during copying or printing.
- If you operate the machine improperly or a machine failure occurs, settings might be lost. Be sure to make a note of your machine settings.
- The supplier shall not be liable for any loss or damage resulting from mechanical failure, loss of settings, or use of the machine.

Toner

Handling Toner

 **WARNING:**

- *Do not incinerate used toner or toner containers. Toner dust might ignite when exposed to an open flame. Dispose of used toner containers in accordance with local regulations.*

 **CAUTION:**

- *Keep toner (used or unused) and toner containers out of reach of children.*

 **Important**

- Fault may occur if you use toner other than the recommended type.

 **Reference**

To add toner, see p.113 " Adding Toner".

6

Toner Storage

When storing toner, the following precautions should always be followed:

- Store toner containers in a cool, dry place free from direct sunlight.
- Store on a flat surface.

Used Toner

 **Note**

- Toner cannot be re-used.

Where to Put Your Machine

Machine Environment

Choose your machine's location carefully. Environmental conditions greatly affect its performance.

Optimum environmental conditions

⚠ CAUTION:

- *Keep the machine away from humidity and dust. Otherwise a fire or an electric shock might occur.*
- *Do not place the machine on an unstable or tilted surface. If it topples over, an injury might occur.*

⚠ CAUTION:

- *If you use the machine in a confined space, make sure there is a continuous air turnover.*

- Temperature: 10-32 °C (50-89.6 °F) (humidity to be 54% at 32 °C, 89.6 °F)
- Humidity: 15-80% (temperature to be 27 °C, 80.6 °F at 80%)
- A strong and level base.
- The machine must be level within 5 mm, 0.2 inches: both front to rear and left to right.
- To avoid possible buildup of ozone, be sure to locate this machine in a large well ventilated room that has an air turnover of more than 30 m³/hr/person.

Environments to avoid

- Locations exposed to direct sunlight or other sources of strong light (more than 1,500 lux).
- Locations directly exposed to cool air from an air conditioner or heated air from a heater. (Sudden temperature changes can cause condensation to form inside the machine.)
- Locations close to machines generating ammonia, such as a diazo copy machine.
- Places where the machine will be subject to frequent strong vibration.
- Dusty areas.
- Areas with corrosive gases.

Moving

CAUTION:

- *Unplug the power cord from the wall outlet before you move the machine. While moving the machine, you should take care that the power cord will not be damaged under the machine.*

Important

- Be careful when moving the machine. Take the following precautions:
 - Turn off the main power. See p.25 "Turning Off the Main Power".
 - Unplug the power cord from the wall outlet. When you pull out the plug from the socket, grip the plug to avoid damaging the cord, thereby reducing the risk of fire or electric shock.
 - Close all covers and trays, including the front cover and bypass tray.
- Move the machine carefully. If you do not, it could be damaged and stored files might be lost.
- Do not take off the holding stand.
- Protect the machine from strong shocks. Impact can damage the hard disk and cause stored files to be lost. As a precautionary measure, files should be copied to another computer.

Power Connection

WARNING:

- **Connect the machine only to the power source described on the inside front cover of this manual. Connect the power cord directly into a wall outlet and do not use an extension cord.**
- **Do not damage, break or make any modifications to the power cord. Do not place heavy objects on it. Do not pull it hard nor bend it more than necessary. These actions could cause an electric shock or fire.**

CAUTION:

- *Unplug the power cord from the wall outlet before you move the machine. While moving the machine, you should take care that the power cord will not be damaged under the machine.*

CAUTION:

- *When you disconnect the power plug from the wall outlet, always pull the plug (not the cable).*
- When the main power switch is in the stand-by position, the optional anti-condensation heaters are on. In an emergency, unplug the machine's power cord.
- When you unplug the power cord, the anti-condensation heaters turn off.
- Make sure the plug is inserted firmly in the wall outlet.
- Voltage must not fluctuate by more than 10%.
- The wall outlet shall be installed near the machine and shall be easily accessible.

Access to the Machine

Place the machine near the power source, providing the clearance areas shown.

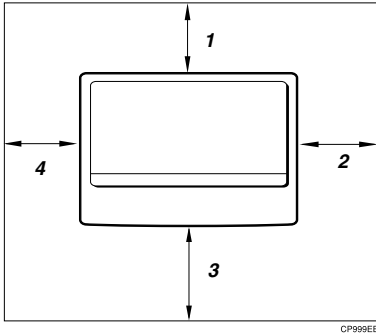

1. Rear: more than 1 cm (4")
2. Right: more than 1 cm (4")
3. Front: more than 75 cm (29.6")
4. Left: more than 1 cm (4")

Note

- For the required space when options are installed, contact your service representative.

Maintaining Your Machine

If the exposure glass, exposure glass cover, or ADF belt is dirty, copy clarity may be reduced. Clean these parts if they are dirty.

◆ Cleaning the machine

Wipe the machine with a soft, damp cloth, and then wipe it with a dry cloth to remove the water.

⚠ Important

- ❑ Do not use chemical cleaners or organic solvents, such as thinner or benzene. If such substances get inside the machine or melt plastic parts, a failure might occur.
- ❑ Do not clean parts other than those explicitly specified in this manual. Other parts should only be cleaned by your service representative.

Cleaning the Exposure Glass



Clean 1 and 2.

Cleaning the Exposure Glass Cover

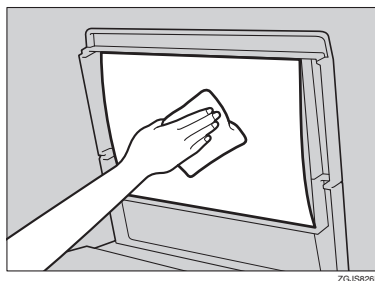

ZGJSB26E

Cleaning the Auto Document Feeder

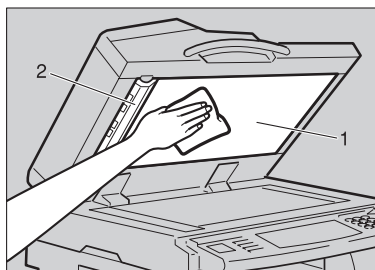

GDSH130J

Clean 1 and 2.

Replacing the Photo Conductor Unit (PCU)

When the “Replace photoconductor unit” message appears on the display panel, it is time to replace the PCU panel.

⚠ WARNING:

- **Do not incinerate the photoconductor unit. Toner dust might ignite when exposed to an open flame. Dispose of the used photoconductor unit in accordance with local regulations.**

⚠ Important

- ❑ Do not tilt the used PCU after taking it out of the machine. If you do, toner might leak out.
- ❑ Do not hold the developer cartridge while taking out the used PCU. If you do, the cartridge might unlock and fall.
- ❑ Do not touch the PCU. If you do, copy quality might be reduced.
- ❑ Before you take out the used PCU, wait until the machine has completely stopped and is making no sound. Not taking this precaution could result in a fault.
- ❑ If there are misfeeds, remove the misfed paper before taking out the used PCU.
- ❑ Be sure to remove the sealing tape before installing the new PCU. Leaving it attached could result in a fault.
- ❑ After installing the new PCU, the machine takes about one minute to initialize. During this period, do not open the front cover or turn off the main power switch. If you do, a fault might occur.

- 1 If the duplex unit is installed, open it by pushing up the catch.

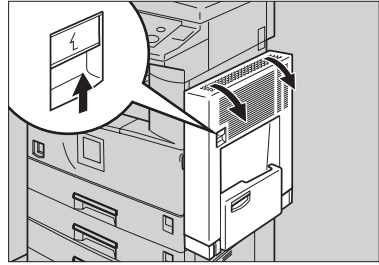

ZEWH300E

- 2 Open the machine's right cover by pushing up the catch.

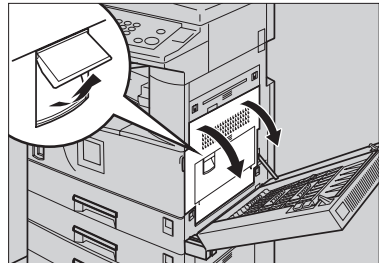

ZEWH310E

- 3 Open the front cover.

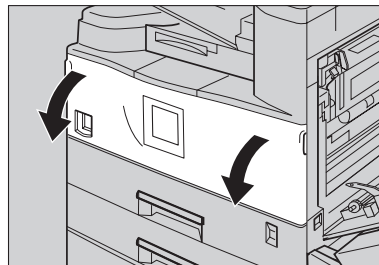

ZEWH550E

- 4** While pressing the button, slide out the PCU, until it stops.

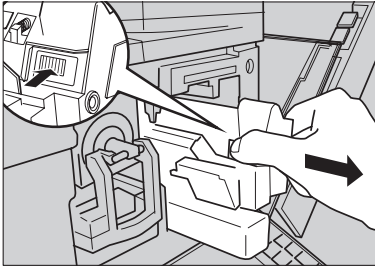

ZEWH360E

- 5** Raise the green handle and slide out the PCU toward you.

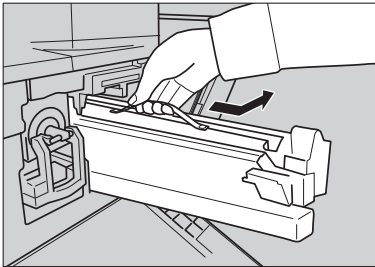

ZEWH370E

Important

- Do not tilt or drop the removed PCU. Moving it suddenly can cause toner leakage.
- Do not change the toner when there is no PCU installed.

- 6** Take the new PCU from the box and, while holding the handle, remove the plastic bag.

Important

- Do not drop or mishandle the removed PCU.
- Do not touch the side of the PCU.

- 7** Put the old PCU (removed in step 5) into the plastic bag from step 6, keeping it at the same angle as it was when installed. Then, zip up the plastic bag.

Note

- Do not tilt the used PCU after taking it out of the machine. If you do, toner might leak out.

- 8** Remove the two red sheets from the PCU in the order shown.

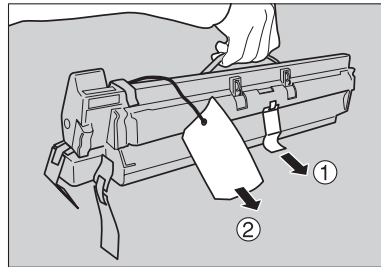

ZEWH380E

Important

- Remove the PCU keeping it level as shown. Otherwise, the toner inside might leak out.
- After removing the black protection sheet, do not touch the inside of the unit or the green parts.

- 9** Align the new PCU with the rail inside the machine. Slide the unit all the way in.

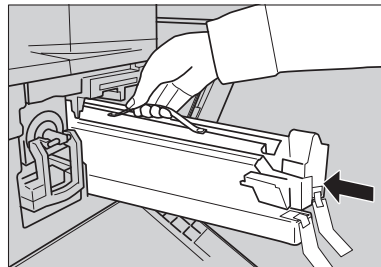

ZEWH390E

- 10** Push the unit into the machine until it clicks into place.

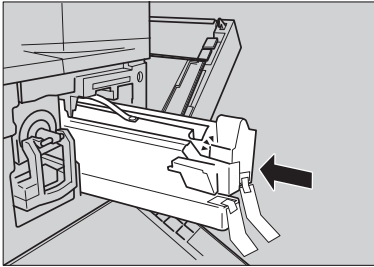

ZEVH4400E

- 11** Remove the red sheet from the PCU, and then remove the two strips of tape.

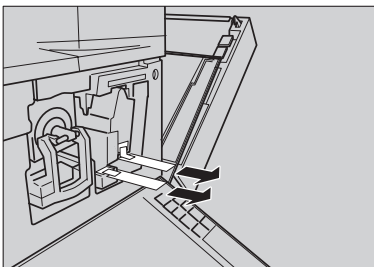

ZEVH410E

- 12** Close the machine's right cover.



ZEVH330E

Note

- If you cannot close the machine's right cover, the PCU is not installed properly. Slide the PCU out and push it in again until it clicks into place.

- 13** Close the front cover.

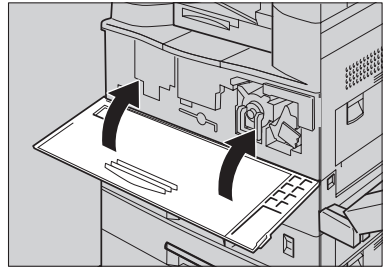

ZEVH420E

- 14** If the duplex unit is installed, close it by pushing up the catch.

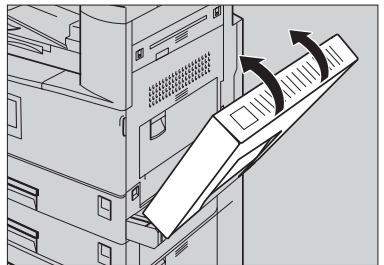

ZEVH340E

Note

- Check the "Replace PCU" message does not appear on the display panel.

Other Functions

Inquiry

The inquiry function lets you check the telephone numbers to contact for repairs or ordering toner. Be sure to contact your service engineer to verify the following:

❖ Consumables

- Telephone No. to order
- Toner
- Staple
- TX Stamp Name

❖ Machine Maintenance/Repair

- Telephone No.
- Serial No. of Machine

❖ Sales Representative

- Telephone No.

1 Press the [User Tools/Counter] key.

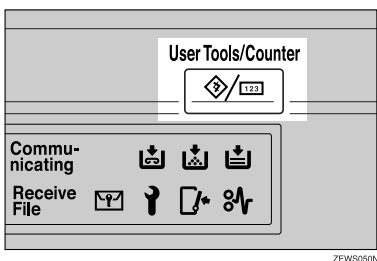

ZEWS090N

2 Press [Inquiry].

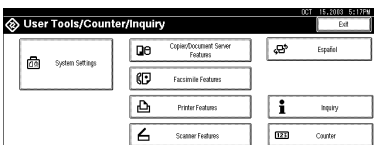

Inquiry information appears.

Printing inquiry information

1 Press [Print Inquiry List].

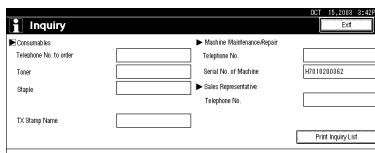

2 Press the [Start] key.

Inquiry information is printed.

3 Press [Exit].

4 Press [Exit].

Changing the Display Language

You can change the language used on the display. English is set as default.

1 Press the [User Tools/Counter] key.

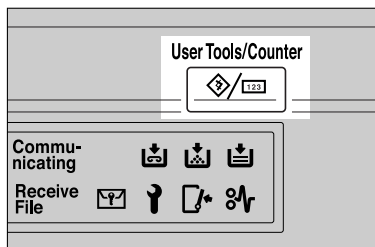

ZEWS090N

2 Press [Español].

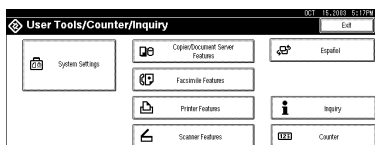

The language is changed to Spanish.

3 Press [Exit].

The menu appears in Spanish.

Counter

Displaying the Total Counter

You can display the total counter value used for all functions.

- 1 Press the **[User Tools/Counter]** key.

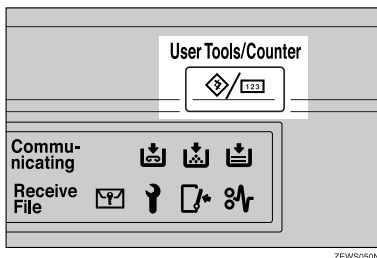

ZEWS050N

- 2 Press **[Counter]**.

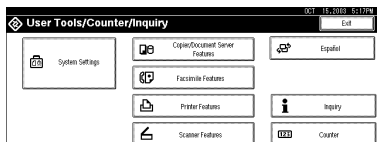

- 3 To print a counter list, press **[Print Counter List]**.

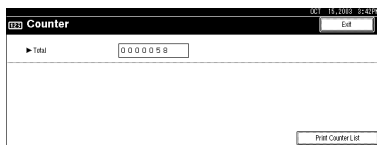

- 4 Press the **[Start]** key.

A counter list prints out.

7. Entering Text

Entering Text

This section describes how to enter characters. When you enter a character, it appears at the position of the cursor. If there is a character already at the cursor position, the entered character appears before that.

Available Characters

- Alphabetic characters
ABCDEFGHIJKLMNOPQRSTUVWXYZabcdefghijklmnopqrstuvwxyz
- Symbols
- Numerals
0123456789

Keys

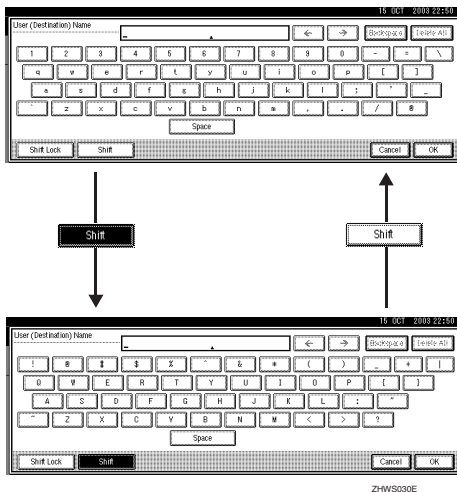

Note

- When entering uppercase or lowercase letters continuously, use **[Shift Lock]** to lock the case.

How to Enter Text

Entering letters

- 1** Press [Shift] to switch between uppercase and lowercase.
 - 2** Press the letters you want to enter.
-

Deleting characters

- 1** Press [Backspace] or [Delete All] to delete characters.

Security

Confidential information is always at risk of being copied without permission or subject to unauthorized access through the network. To protect documents from such intrusion, not only can passwords be set, but also the Extended Security function can be used to strengthen security.

For those who require increased document protection, we recommend using the Extended Security function.

Primary Security Functions

❖ **Protecting Stored Documents**

Protects documents with a password when using Document Server or Locked Print. Furthermore, the Extended Security function can protect against password-generating cracking. See p.145 "Extended Security Function".

❖ **Protecting Image Data Remaining in Memory**

Protects image data remaining in memory. When a copy or print job is completed, or a job is canceled, the data is secure.

❖ **Protecting against Unauthorized Access Via Phone Line**

Accepts only facsimile calls.

❖ **Authenticating Administrator**

Protects essential functions for administrating document security using an access code. See p.60 "Key Operator Code".

Extended Security Function

By setting a password, document operations such as printing, deleting, or delivering can be restricted to authorized users and denied to others. However, passwords can be cracked. When the Extended Security function is used, entering the wrong password 10 times will lock that document, protecting it from unauthorized access.

To unlock documents, see p.147 "Unlocking a locked document".

Documents that can be protected by the Extended Security function are as follows (all documents must be set with a password to be protected using this function):

❖ Documents stored in the Document Server by the following functions

- Document Server
- Copier function
- Fax transmission
- Scanner function
- Printer driver

❖ Documents stored from the printer driver using the Locked Print function

 **Reference**

For information about Document Server, see p.33 “Document Server”.

For information about Locked Print, see “Locked Print”, *Printer Reference*, or the printer driver Help.

 **Note**

- Once a document is locked, it will reject the correct password until it is unlocked.
- When the Extended Security function is on, delivery server settings cannot be changed. Turn the function off to change the settings.

Setting Extended Security

 **Preparation**

The Extended Security setting is not available unless the key operator code set in the Key Operator Code settings of the System Settings has six or more digits. See p.60 “Key Operator Code”.

 **Note**

- To ensure increased document protection under the Extended Security setting, we recommend you select **[All Initial Settings]** when programming a key operator code.

1 Press the **[User Tools/Counter]** key.

2 On the display panel, press **[System Settings]**, and then press **[Key Operator Tools]**.

3 Press **[Extended Security]**. Press **[On]**, and then **[OK]**.

The Extended Security function is enabled, and the security mark  appears in the upper right of the display panel.

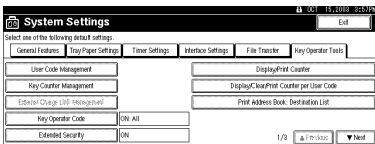

4 Press the **[User Tools/Counter]** key to finish.

Unlocking a locked document

Unlock a document that was locked because a wrong password was entered multiple times, making it available for authorized users to access again.

- 1** Press the **[User Tools/Counter]** key.
- 2** On the display panel, press **[System Settings]**, **[Key Operator Tools]**, **[▼Next]** and then press **[Password Management for Stored Files]**.
- 3** Press **[OK]** under **Unlock Files**.
The document is unlocked.
- 4** Press the **[User Tools/Counter]** key to finish.

Temporarily Disabling Document Security

If you forget a password, document protection can be temporarily disabled, making documents available for operations such as setting new passwords or deleting.

Important

- When operations are complete, be sure to press **[Do not Unlock]** under **Temporarily Unlock Files**, protecting the document by password again.

Note

- For a document stored using **Locked Print**, only document deletion is available when protection is disabled.

- 1** Press the **[User Tools/Counter]** key.
- 2** On the display panel, press **[System Settings]**, **[Key Operator Tools]**, **[▼Next]** and then press **[Password Management for Stored Files]**.
- 3** Press **[Unlock]** under **Temporarily Unlock Files**.

Note

- Protection can be disabled for only three minutes. Access the document, set a new password, and perform any other necessary operations to the document within that time. Documents will automatically return to the password-protected condition after three minutes.

- 4** Press the **[User Tools/Counter]** key to finish.

Operating Environment and Notes

Security for this machine is assured on the premises that the machine is used under the following conditions:

Operating Environment

- The condition of the machine is normal. (For example, it is not damaged, modified, or lacking components.)
- When the machine is connected to a network, the machine is protected from illegitimate access including unauthorized packet sniffing.
- The machine is managed by an administrator with thorough knowledge of the machine and capable of providing the proper conditions under which users can use the machine safely.

For Administrator

- This machine does not protect against illegitimate actions on the network. To avoid any risks on the network, further security is required.
- Security of this machine cannot be assured if any hardware component is detached or replaced with an inappropriate component. If these things have the possibility of occurring, other security measures are necessary.
- Regularly check that the Extended Security function is on. While the machine is in this mode, the security mark  is displayed at the upper right of the display panel. Be sure to check it particularly after the machine is moved or a power failure occurs. See p.146 "Setting Extended Security".
- Avoid using a single number or consecutive numbers for an key operator code such as "00000000" or "12345678". Since the numbers like this are easy to guess, using them will not provide the appropriate level of security.
- Remote document management using SmartNetMonitor for AdminSmartNetMonitor for Admin is not available when the Extended Security function is on.
- User code is a function to help manage the use of the machine. It is not to protect confidential documents from others. See p.70 "User Codes".
- As for using the delivery function, the security of this machine can assure only the protection of documents having a password set and stored in the Document Server. Be sure to select the destination correctly when delivering documents.

For User

- Be careful not to let anyone know your password, especially when entering a password or recording it. Keep any record of your password in a safe place.
- Avoid using a single number or consecutive numbers for a password such as "0000" or "1234", since the numbers like this are easy to guess, so using them will not provide a worthwhile level of security.
- A document accessed with a correct password remains selected even after operations are complete, and it can be accessed by other users. To stop this, be sure to press the **[Clear Modes]** key to cancel the document selection.
- The user name used when adding a document to the Document Server is to identify the document creator and type. It is not to protect confidential documents from others.
- Before scanning documents using the scanner function, make sure all other operations are complete.

9. Specifications

Main Unit

- ❖ **Configuration:**
Desktop
- ❖ **Photosensitivity type:**
OPC drum (ø30)
- ❖ **Original scanning:**
One-dimensional solid scanning system through CCD
- ❖ **Copy process:**
Dry electrostatic transfer system
- ❖ **Development:**
Dry two-component magnetic brush development system
- ❖ **Fusing:**
Heating roll pressure system
- ❖ **Resolution:**
600 dpi
- ❖ **Exposure glass:**
Stationary original exposure type
- ❖ **Original reference position:**
Rear left corner
- ❖ **Warm-up time:**
 - Main power switch: 15 seconds or less (20 °C, 68 °F)
 - Operation switch: 10 seconds or less (20 °C, 68 °F)
- ❖ **Originals:**
Sheet/book/objects
- ❖ **Maximum original size:**
A3☐, 11" × 17"☐

❖ Copy paper size:

- Tray 1: A3 \square – A5 \square , 11" \times 17" \square – 5¹/₂" \times 8¹/₂" \square
- Tray 2: A3 \square – A6 \square , 11" \times 17" \square – 5¹/₂" \times 8¹/₂" \square
- Bypass: A3 \square – A6 \square , 11" \times 17" \square – 5¹/₂" \times 8¹/₂" \square
- Tray 2 (custom size):
Vertical: 100 – 297 mm, 4.0" – 11.7"
Horizontal: 148 – 432 mm, 5.9" – 17.0"
- Bypass (custom size):
Vertical: 90 – 305 mm, 3.6" – 12.0"
Horizontal: 148 – 600 mm, 5.9" – 23.6"
- Duplex: A3 \square – A5 \square , 11" \times 17" \square – 5¹/₂" \times 8¹/₂" \square (impossible on A5 \square , 5¹/₂" \times 8¹/₂" \square)
- LCT: A4 \square , 8¹/₂" \times 11" \square

❖ Copy paper weight:

- Paper tray 1: 60 – 90 g/m², 16 – 24 lb.
- Paper tray 2: 52 – 157 g/m², 14 – 42 lb.
- Bypass tray: 52 – 157 g/m², 14 – 42 lb.

❖ Non-reproduction area:

- Leading edge: 3 \pm 2 mm or less
- Trailing edge: 0.5 mm or more
- Left edge: 2 \pm 1.5 mm or less
- Right edge: 2 + 2.5/-1.5 mm or less

❖ First copy time:

Type 1, 2: 5.0 seconds or less

Type 3: 4.5 seconds or less

(A4 \square , 8¹/₂" \times 11" \square , 100%, feeding from the tray 1, on the exposure glass, Text mode, Auto Image Density)





❖ Copying speed: (Type 1)

- 13 copies/minute (A3 \square , 11" \times 17" \square)
- 15 copies/minute (B4 JIS \square)
- 22 copies/minute (A4 \square , 8¹/₂" \times 11" \square)

❖ Copying speed: (Type 2)

- 15 copies/minute (A3 \square , 11" \times 17" \square)
- 17 copies/minute (B4 JIS \square)
- 27 copies/minute (A4 \square , 8¹/₂" \times 11" \square)

❖ **Copying speed: (Type 3)**

- 18 copies/minute (A3 , 11" × 17" )
- 21 copies/minute (B4 JIS )
- 32 copies/minute (A4 , 8¹/₂" × 11" )

❖ **Reproduction ratio:**

Preset reproduction ratios:

	Metric version	Inch version
Enlargement	400%	400%
	200%	200%
	141%	155%
	122%	129%
	115%	121%
Full size	100%	100%
Reduction	93%	93%
	82%	85%
	75%	78%
	71%	73%
	65%	65%
	50%	50%
	25%	25%

Zoom: From 25 to 400% in 1% steps (from 25 to 200% in 1% step, when setting originals in the ADF).

❖ **Maximum continuous copy run:**

99 sheets

❖ **Paper capacity:**

- Tray 1, 2: 500 sheets (80 g/m², 20 lb.)
- Bypass tray: 100 sheets (80 g/m², 20 lb.)

❖ **Power consumption:**

- Main unit only

	Type 1/Type 2	Type 3
Warm-up	less than 1.44 kW	less than 1.44 kW
Stand-by	about 150 W *2	about 150 W *2
During printing	about 650 W *2	about 770 W *2
Maximum	less than 1.44 kW	less than 1.44 kW

- Complete system *1

	Type 1/Type 2	Type 3
Warm-up	less than 1.44 kW	less than 1.44kW
Stand-by	about 160 W *2	about 160 W *2
During printing	about 680 W *2	about 800 W *2
Maximum	less than 1.44 kW	less than 1.44 kW

*1 The Complete system consists of the main unit, ADF, 1000-sheet finisher, duplex unit, internal tray 2, paper tray unit, fax unit, ISDN, extra G3 interface unit, expansion memory, JBIG function upgrade unit, printer unit, HDD, PHY and memory unit.

*2 The measurements are actual values.

❖ **Dimensions (W × D × H up to exposure glass):**

Type 1, 2, 3: 550 × 604 × 709 mm, 21.7" × 23.8" × 28.0"

❖ **Space for main unit (W × D):**

Type 1, 2, 3: 550 × 604 mm, 21.7" × 23.8"

❖ **Noise Emission *1:**

Sound Power Level:

- Main unit only

	Type 1/Type 2	Type 3
Stand-by	Less than 40 dB (A)	Less than 40 dB (A)
Copying	Less than 63 dB (A)	Less than 66 dB (A)

- Complete system *3

	Type 1/Type 2	Type 3
Stand-by	Less than 44 dB (A)	Less than 44 dB (A)
Copying	Less than 68.5 dB (A)	Less than 70 dB (A)

Sound Pressure Level *2:

- Main unit only

	Type 1/Type 2	Type 3
Stand-by	Less than 34 dB (A)	Less than 34 dB (A)
Copying	Less than 57 dB (A)	Less than 60 dB (A)

- Complete system ^{*3}

	Type 1/Type 2	Type 3
Stand-by	Less than 38 dB (A)	Less than 38 dB (A)
Copying	Less than 61 dB (A)	Less than 64 dB (A)

^{*1} The above measurements, made in accordance with ISO 7779, are actual values.

^{*2} Measured at the position of the bystander.

^{*3} The Complete System consists of the main unit, ADF, 1000-sheet finisher, duplex unit, internal tray 2 and paper tray unit.

- ❖ **Weight:**

Type 1, 2, 3: Approx. 55 kg, 121.3 lb.

- ❖ **HDD:**

20 GB or more







- Capacity for Document Server
3.6 GB
- Capacity for memory sorting
3.2 GB
- Capacity for others
1.32 GB or more

Options

Exposure Glass Cover

Lower this over originals for copying.

Auto Document Feeder

- ❖ **Mode:**
ADF mode, Batch mode, SADP mode, Mixed Size mode, Custom Size originals mode
- ❖ **Original size:**
 - A3  – A5  
 - 11" × 17"  – 5¹/₂" × 8¹/₂"  
- ❖ **Original weight:**
 - One-sided originals: 40 – 128 g/m² (11 – 34 lb.)
 - Two-sided originals: 52 – 105 g/m² (14 – 28 lb.) (Duplex)
- ❖ **Maximum number of originals:**
50 sheets (80 g/m², 20 lb.) or less than 11 mm, 0.43"
- ❖ **Maximum power consumption:**
Less than 50 W (power is supplied from the main unit)
- ❖ **Dimensions (WxDxH):**
550 × 470 × 130 mm, 21.7" × 18.6" × 5.2"
- ❖ **Weight:**
Approx. 10 kg, 22.1 lb.
- 📖 **Note**
 Specifications are subject to change without notice.

500-Sheet Finisher

❖ Paper size:

A3☐, B4 JIS☐, A4☐, B5 JIS☐, 11" × 17"☐, 11" × 14"☐, 8¹/₂" × 14"☐, 8¹/₂" × 11"☐, 8¹/₂" × 13"☐, 8" × 10¹/₂"☐

❖ Paper weight:

60 – 128 g/m², 16 – 34 lb.

❖ Stack capacity:

- 500 sheets (A4☐, 8¹/₂" × 11"☐ or smaller) (80 g/m², 20 lb.)
- 250 sheets (B4 JIS☐, 8¹/₂" × 14"☐ or larger) (80 g/m², 20 lb.)

❖ Staple capacity:

- 30 sheets (A4☐, 8¹/₂" × 11"☐ or smaller) (80 g/m², 20 lb.)
- 20 sheets (B4 JIS☐, 8¹/₂" × 14"☐ or larger) (80 g/m², 20 lb.)

❖ Staple paper size:

A3☐, B4 JIS☐, A4☐, B5 JIS☐, 11" × 17"☐, 11" × 15"☐, 11" × 14"☐, 10" × 14"☐, 10" × 15"☐, 8¹/₂" × 14"☐, 8¹/₂" × 13"☐, 8¹/₂" × 11"☐, 8" × 10¹/₂"☐, 8" × 10"☐, 10¹/₂" × 7¹/₄"☐

❖ Staple paper weight:

64 – 90 g/m², 17 – 24 lb.

❖ Staple position:

1 position (upper left)

❖ Power consumption:

48 W (power is supplied from the main unit)

❖ Dimensions (W × D × H):

350 × 490 × 230 mm, 13.8" × 19.3" × 9.1"

❖ Weight:

Approx. 10 kg, 22.1 lb.

1000-Sheet Finisher

Finisher Upper Tray:

❖ Paper size:

A3, B4 JIS, A4, B5 JIS, A5, B6 JIS, A6, Postcard, 11" × 17", 11" × 15", 11" × 14", 10" × 14", 10" × 15", 8¹/₂" × 14", 8¹/₂" × 11", 10¹/₂" × 7¹/₄", 8" × 13", 8¹/₂" × 13", 8¹/₄" × 13", 8" × 10¹/₂", 8" × 10", 8¹/₄" × 14", 5¹/₂" × 8¹/₂"

❖ Paper weight:

60 – 157 g/m², 16 – 42 lb.

❖ Stack capacity:

- 250 sheets (A4, 8¹/₂" × 11" or smaller) (80 g/m², 20 lb.)
- 50 sheets (B4 JIS, 8¹/₂" × 14" or larger) (80 g/m², 20 lb.)

Finisher Shift Tray:

❖ Paper size:

A3, B4 JIS, A4, B5 JIS, 11" × 17", 11" × 14", 8¹/₂" × 14", 8¹/₂" × 11", 10¹/₂" × 7¹/₄", 8" × 10¹/₂", 8" × 13", 8¹/₂" × 13", 8¹/₄" × 13", 8¹/₄" × 14", 5¹/₂" × 8¹/₂"

❖ Paper weight:

60 – 157 g/m², 16 – 42 lb.

❖ Stack capacity:

- 1,000 sheets (A4, 8¹/₂" × 11" or smaller) (80 g/m², 20 lb.)
- 500 sheets (B4 JIS, 8¹/₂" × 14" or larger) (80 g/m², 20 lb.)

❖ Staple capacity:

- 50 sheets (A4, 8¹/₂" × 11" or smaller) (80 g/m², 20 lb.)
- 30 sheets (B4 JIS, 8¹/₂" × 14" or larger) (80 g/m², 20 lb.)

❖ Staple paper size:

A3, B4 JIS, A4, B5 JIS, 11" × 17", 11" × 15", 11" × 14", 10" × 14", 10" × 15", 8¹/₂" × 14", 8¹/₂" × 11", 10¹/₂" × 7¹/₄", 8" × 13", 8¹/₂" × 13", 8¹/₄" × 13", 8" × 10¹/₂", 8" × 10", 8¹/₄" × 14"

❖ Staple paper weight:

64 – 90 g/m², 17 – 24 lb.

❖ Staple position:

- 1 staple – 2 positions
- 2 staples – 2 positions

❖ **Power consumption:**

Less than 50 W (power is supplied from the main unit)

❖ **Dimensions (W × D × H):**



527 × 520 × 790 mm, 20.8" × 20.5" × 31.1"

❖ **Weight:**

Approx. 25 kg, 55.2 lb.

Shift Sort Tray

❖ **Paper capacity:**

250 sheets (A4 , 8 1/2" × 11"  or smaller) (80 g/m², 20 lb.)
125 sheets (B4 JIS , 8 1/2" × 14" or larger) (80 g/m², 20 lb.)

❖ **Power consumption:**

3.6 W (power is supplied from the main unit)

❖ **Dimensions (W × D × H)**



















430 × 372 × 148 mm, 17" × 15" × 6"

❖ **Weight:**

Approx. 1.6 kg, 3.5 lb.

Duplex Unit

❖ **Paper size:**

A3 , B4 JIS , A4  , B5 JIS  , A5 , 5 1/2" × 8 1/2" , 7 1/4" × 10 1/2"  ,
8" × 10"  , 8 1/2" × 11"  , 8" × 13" , 8 1/2" × 13" , 8 1/2" × 14" , 8 1/4" ×
13" , 11" × 17" 

❖ **Paper weight:**

64 – 90 g/m², 20 – 24 lb.

❖ **Power consumption (Max):**

35 W (power is supplied from the main unit)

❖ **Dimensions (W × D × H):**





90 × 495 × 455 mm, 3.6" × 19.5" × 17.9"

❖ **Weight:**

Approx. 6 kg, 13.3 lb.

Bypass Tray

❖ **Paper size:**

- Standard size: A3  – A6 , 11" × 17"  – 5¹/₂" × 8¹/₂" 
- Custom size: Vertical (100 – 297 mm, 4.0" – 11.7"), Horizontal (148 – 432 mm, 5.9" – 17.0")

❖ **Paper weight:**

52 – 157 g/m², 14 – 42 lb.

❖ **Dimensions (W × D × H):**

296 × 495 × 163 mm, 11.7" × 19.5" × 6.5"

❖ **Paper capacity:**

52 – 90 g/m², 16 – 20 lb: 100 sheets

❖ **Weight:**

Approx. 2.5 kg, 5.6 lb.

Bridge Unit

❖ **Dimensions:**

413 × 435 × 126 mm, 16.3" × 17.1" × 5.0"

❖ **Weight:**



























3.6 kg, 7.9 lb.

Internal Tray 2 (1 bin tray)

❖ **Number of bins:**

1

❖ **Available paper size:**

A3 , B4 JIS , A4  , B5 JIS  , A5 , 11" × 17" , 8¹/₄" × 14" , 8¹/₂" × 14" , 11" × 15" , 11" × 14" , 10" × 14" , 10" × 15" , 8¹/₂" × 11"  , 10¹/₂" × 7¹/₄"  , 8" × 13" , 8¹/₂" × 13" , 8¹/₄" × 13" , 8" × 10¹/₂"  , 8" × 10"  , 5¹/₂" × 8¹/₂" 

❖ **Paper capacity:**

125 sheets (80 g/m², 20 lb.)

❖ **Paper weight:**

60 – 90 g/m² (16 – 24 lb.)

❖ **Maximum power consumption:**

Less than 15 W (power is supplied from the main unit)

❖ **Dimensions (W × D × H):**

530 × 410 × 120 mm, 20.9" × 16.2" × 4.7"

❖ **Weight:**

Approx. 1.1 kg, 2.5 lb.

 **Note**

Specifications are subject to change without notice.

Large Capacity Tray

❖ **Paper size:**

A4 , 8¹/₂" × 11"

❖ **Paper weight:**

60 – 90 g/m², 16 – 24 lb.

❖ **Paper capacity:**

2,000 sheets (80 g/m², 20 lb.)

❖ **Power consumption**

Maximum. 40 W (power is supplied from the main unit)

❖ **Dimensions (W × D × H, option unit):**

550 × 520 × 271 mm, 21.7" × 20.5" × 10.7"

❖ **Weight:**

Approx. 25 kg, 55.2 lb.

 **Note**

Specifications are subject to change without notice.

Paper Tray Unit

❖ **Paper weight:**

60 – 90 g/m² (16 – 24 lb.)

❖ **Available paper size:**

A3 , B4 JIS , A4 , B5 JIS , A5 , 11" × 17" , 8¹/₂" × 14" , 8¹/₂" × 11" , 5¹/₂" × 8¹/₂" , 8¹/₄" × 14" , 11" × 14" , 7¹/₄" × 10¹/₂" , 8" × 13" , 8" × 10¹/₂" , 8¹/₂" × 13" , 8¹/₄" × 13"

❖ **Maximum power consumption:**

Less than 30 W (power is supplied from the main unit)

❖ **Paper capacity:**

500 sheets (80 g/m², 20 lb.) × 2 trays

❖ **Dimensions (W × D × H):**

550 × 520 × 271 mm, 21.7" × 20.5" × 10.7"

❖ **Weight:**

Approx. 25 kg, 55.2 lb.

 **Note**

Specifications are subject to change without notice.

Copy Paper

Recommended Paper Sizes and Types

The following limitations apply to each tray:





Tray Type	Paper Type and Weight	Metric Version	Inch Version	Paper Capacity
Tray 1 ^{*10}	60-90 g/m ² (16-24 lb.)	A3☐, B4 JIS☐, A4☐☐, B5 JIS☐☐, A5☐		500 sheets
Paper Tray Unit ^{*10} (optional)		*1 11" × 17"☐, 8 ¹ / ₂ " × 14"☐, 8 ¹ / ₂ " × 11"☐☐, 8" × 13"☐, 8 ¹ / ₂ " × 13"☐, 8 ¹ / ₄ " × 13"☐, 8 ¹ / ₄ " × 14"☐, 11" × 14"☐, 7 ¹ / ₄ " × 10 ¹ / ₂ "☐, 8" × 10 ¹ / ₂ "☐☐, 5 ¹ / ₂ " × 8 ¹ / ₂ "☐, 8K☐, 16K☐☐		
		*2 Custom size Vertical: 140-297 mm Horizontal: 182-600 mm	*2 Custom size Vertical: 5.6"-11.7" Horizontal: 7.3"-23.6"	
Tray 2 ^{*10}	60-90 g/m ² (16-24 lb.) Thin paper 52-60 g/m ² (14-16 lb.)	A3☐, B4 JIS☐, A4☐☐, B5 JIS☐☐, A5☐		500 sheets
		*1 B6 JIS☐, A6☐, 11" × 17"☐, 8 ¹ / ₂ " × 14"☐, 8 ¹ / ₂ " × 11"☐☐, 5 ¹ / ₂ " × 8 ¹ / ₂ "☐, 7 ¹ / ₄ " × 10 ¹ / ₂ "☐☐, 8" × 13"☐, 8 ¹ / ₂ " × 13"☐, 8 ¹ / ₄ " × 13"☐, 8" × 10"☐☐, 8 ¹ / ₄ " × 14"☐, 11" × 14"☐, 8" × 10 ¹ / ₂ "☐☐, 11" × 15"☐, 10" × 14"☐, 10" × 15"☐, 8K☐, 16K☐☐		
		*2 Custom size Vertical: 100-297 mm Horizontal: 148-600 mm	*2 Custom size Vertical: 4.0"-11.7" Horizontal: 5.9"-23.6"	
	Thick paper ^{*11} 105-157 g/m ² (28-42 lb.)	A3☐, B4 JIS☐, A4☐☐, B5 JIS☐☐, A5☐		*7
	*1 B6 JIS☐, A6☐, 11" × 17"☐, 8 ¹ / ₂ " × 14"☐, 8 ¹ / ₂ " × 11"☐☐, 5 ¹ / ₂ " × 8 ¹ / ₂ "☐, 7 ¹ / ₄ " × 10 ¹ / ₂ "☐☐, 8" × 13"☐, 8 ¹ / ₂ " × 13"☐, 8 ¹ / ₄ " × 13"☐, 8" × 10"☐☐, 8 ¹ / ₄ " × 14"☐, 11" × 14"☐, 8" × 10 ¹ / ₂ "☐☐, 11" × 15"☐, 10" × 14"☐, 10" × 15"☐, 8K☐, 16K☐☐			
	*2 Custom size Vertical: 100-297 mm Horizontal: 148-432 mm	*2 Custom size Vertical: 4.0"-11.7" Horizontal: 5.9"-17.0"		
	Translucent paper	A3☐, B4 JIS☐, A4☐☐, B5 JIS☐☐		
	OHP transparencies	A4☐☐		
	Postcards	100 × 148 mm		
	Label paper (adhesive labels)	B4 JIS☐, A4☐		
	Envelope	3 ⁷ / ₈ " × 7 ¹ / ₂ "☐, 4 ¹ / ₈ " × 9 ¹ / ₂ "☐, C5 Env☐, C6 Env☐, DL Env☐		–

Tray Type	Paper Type and Weight	Metric Version	Inch Version	Paper Capacity
Bypass Tray ^{*10} (optional)	Thin paper 52-90 g/m ² (14-24 lb.)	A3□, B4 JIS□, 11" × 17"□, 8 ¹ / ₂ " × 14"□, 8" × 13"□, 8 ¹ / ₂ " × 13"□, 8 ¹ / ₄ " × 13"□, 8 ¹ / ₄ " × 14"□, 11" × 14"□, 11" × 15"□, 10" × 14"□, 10" × 15"□, 8K□		10 sheets
		A4□□, B5 JIS□□, A5□□, B6 JIS□		100 sheets
		^{*3} A6□, 8 ¹ / ₂ " × 11"□□, 5 ¹ / ₂ " × 8 ¹ / ₂ "□, 7 ¹ / ₄ " × 10 ¹ / ₂ "□□, 8" × 10"□□, 8" × 10 ¹ / ₂ "□□, 16K□□		
		^{*4} Custom size Vertical: 90-305 mm Horizontal: 148-432 mm ^{*12}	^{*4} Custom size Vertical: 3.6"-12.0" Horizontal: 5.9"-17.0" ^{*12}	^{*8}
	Thick paper ^{*11} 105-157 g/m ² (28-42 lb.)	A3□, B4 JIS□, 11" × 17"□, 8 ¹ / ₂ " × 14"□, 8" × 13"□, 8 ¹ / ₂ " × 13"□, 8 ¹ / ₄ " × 13"□, 8 ¹ / ₄ " × 14"□, 11" × 14"□, 11" × 15"□, 10" × 14"□, 10" × 15"□, 8K□		10 sheets
		A4□□, B5 JIS□□, A5□□, B6 JIS□		40 sheets
		^{*3} A6□, 8 ¹ / ₂ " × 11"□□, 5 ¹ / ₂ " × 8 ¹ / ₂ "□, 7 ¹ / ₄ " × 10 ¹ / ₂ "□□, 8" × 10"□□, 8" × 10 ¹ / ₂ "□□, 16K□□		
		^{*4} Custom size Vertical: 90-305 mm Horizontal: 148-432 mm ^{*12}	^{*4} Custom size Vertical: 3.6"-12.0" Horizontal: 5.9"-17.0" ^{*12}	^{*9}
	Translucent paper	A3□, B4 JIS□		10 sheets
		A4□□, B5 JIS□□		40 sheets ^{*5}
OHP transparencies	A4□□		10 sheets ^{*5}	
Postcards	100 × 148 mm		40 sheets ^{*5}	
Label paper (adhesive labels)	B4 JIS□, A4□		1 sheet	
Envelope	3 ⁷ / ₈ " × 7 ¹ / ₂ "□, 4 ¹ / ₈ " × 9 ¹ / ₂ "□, C5 Env□, C6 Env□, DL Env□		–	
LCT ^{*10} (optional)	60-90 g/m ² (16-24lb.)	A4□, 8 ¹ / ₂ " × 11"□ ^{*6}		2000 (1000 + 1000) sheets

^{*1} Set the paper size selector to the ✖ mark, and then select the paper size in System Settings. See "Paper Type".

^{*2} Set the paper size selector to the ✖ mark, and then specify the paper size. See "Copying from the paper tray 2", *Copy Reference*

^{*3} Place the paper in the bypass tray, and select the paper size. See "When copying onto standard size paper", *Copy Reference*

- *4 Place the paper in the bypass tray, and specify the paper size. See “When copying onto custom size paper”, *Copy Reference*
When paper larger than 433 mm is used, it is likely to jam, crease or not feed in properly. Make sure the paper is placed correctly so that feeds in straight.
- *5 Placing one sheet at a time is recommended.
- *6 The paper tray guide is fixed. If you want to change the size of paper placed in this tray, contact your service representative.
- *7 When loading paper, make sure the stack height does not exceed the lower limit mark of the paper tray 2. See p.110 “Setting special paper in the paper tray 2”.
- *8 When the paper size is larger than A4 , you can load 10 sheets.
When the paper size is smaller than A4 , you can load 100 sheets.
- *9 When the thick paper size is larger than A4 , you can load 10 sheets. When the thick paper size is smaller than A4 , you can load 40 sheets.
- *10 When loading copy paper, make sure the stack height does not exceed the limit mark. The maximum number of sheets you can load at a time depends on the paper thickness and condition.
- *11 If you want to copy onto thick (105 g/m², 28 lb or heavier) paper, select Thick Paper mode. See “Copying from the Paper Tray 2”, *Copy Reference*.
- *12 Paper size up to 600 mm (23.6”) is available when the optional HDD is installed.

Important

- Damp or curled paper may cause misfeeds.



Note

- When loading paper in the paper tray 1-4 and the LCT, place the copy side of the paper face up.
- When loading paper in the bypass tray, place the copy side of the paper face down.
- When using the bypass tray, it is recommended to set the paper orientation to .
- If you load paper of the same size in the same orientation in two or more trays, the machine automatically shifts to the other tray when the first tray in use runs out of paper. This function is called Auto Tray Switching. (However, if the Paper Type of one tray is recycled or special paper, the settings of the other trays must be the same for Auto Tray Switching to work.) This saves interrupting a copy run to replenish paper when making a large number of copies. See “Selecting Copy Paper”, “Auto Tray Switching”, *Copy Reference*
- The paper types you can select in System Settings are only general classifications. Copy quality for every kind of paper in a classification is not guaranteed. See p.169 “Unusable Paper” for more information.

Envelopes

Note

- Postcards and envelopes should be fed from paper tray 2 or the bypass tray.
- Some kinds of envelopes might cause misfeeds or wrinkle. If this happens, push down the green lever of the fusing unit. See p.166 "When copying onto envelopes".
- Envelopes with large flaps should be fed from paper tray 2 to prevent misfeeds. See the illustration below.

Envelope Type \ Paper Tray	Paper Tray2	Bypass Tray
Envelope Type 	○	○
	○	×

GEWH110E

When copying onto envelopes

- 1** If the duplex unit is installed, open it by lifting the catch.

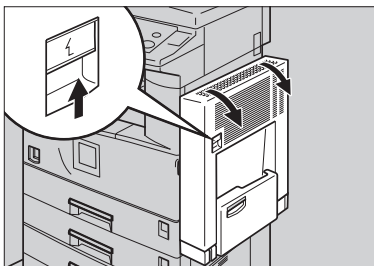

ZEW4300E

2 Open the right cover by lifting the catch.

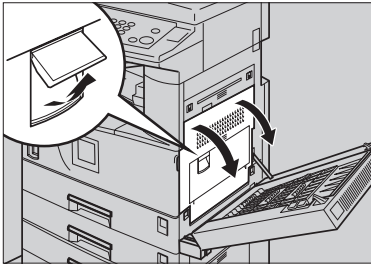

ZEW4310E

3 Push down the green fusing unit's lever, as shown.

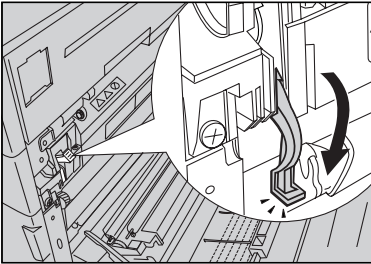

ZEW4320E

Important

- Be sure to return the lever to its original position after you have finished copying onto envelopes.
- If you copy onto plain paper without returning the lever to its original position, the copy quality might be reduced.

4 Close the right cover.

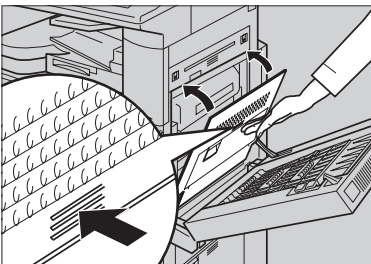

ZEW4330E

5 If the duplex unit is installed, close it.

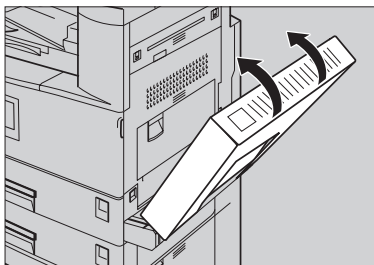

ZEWHS40E

6 Press the **[#]** key.

7 Select the paper size, and then select **[Thick Paper]** for the paper type.

8 Press **[OK]**.

9 Place your originals, and then press the **[Start]** key.

 **Note**

- When copying onto OHP transparencies, remove copies one by one.
- When setting OHP transparencies, thin paper or label paper (adhesive labels), Staple, Shift or Sort function may not be used.

10 When your copy job is finished, press the **[Clear Modes]** key to clear the settings.

Unusable Paper

CAUTION:

- *Do not use aluminum foil, carbon paper, or similar conductive paper to avoid a fire or machine failure.*

Important

- To prevent faults, do not use any of the following kinds of paper:
 - Thermal fax paper
 - Art paper
 - Aluminum foil
 - Carbon paper
 - Conductive paper
 - OHP transparencies for color copying
 - Paper with perforated lines
 - Hemmed paper
- Do not use copy paper that has been already copied onto, fault could occur if you do.

Note

- To prevent misfeeds, do not use the following kinds of paper:
 - Bent, folded, or creased paper
 - Torn paper
 - Slippery paper
 - Perforated paper
 - Rough paper
 - Thin paper with little stiffness
 - Paper with a dusty surface
- If you copy onto rough grain paper, the image might be blurred.

Paper Storage

Note

- When storing paper, the following precautions should always be followed:
 - Do not store paper where it will be exposed to direct sunlight.
 - Avoid storing paper in humid areas (humidity: 70% or less).
 - Store on a flat surface.
- Do not store paper vertically.
- Under high temperature and humidity conditions, or low temperature and humidity conditions, store paper in vinyl bags.

INDEX

1000-Sheet Finisher, 158
1000-sheet finisher, 19
500-Sheet Finisher, 19

A

Adding staples, 125
Adding toner, 113
Address book, 67
 change order, 64
 edit title, 65
 program/change/delete group, 63
 program/change/delete transfer request, 63
 select title, 65
Address Book Management, 62
ADF, 19
Auto Delete File, 65
Auto Document Feeder, 17, 156
 cleaning, 136
Auto Off, 26
Auto off timer, 58
Auto reset timer
 copier/Document Server, 58
 facsimile, 59
 scanner, 59
 system, 58

B

Bridge unit, 19, 160
Browse network, 87
Bypass tray, 18, 19, 160

C

Changing a group name, 97
Changing an LDAP server, 105
Changing a registered e-mail destination, 84
Changing a registered fax destination, 79
Changing a registered FTP folder, 91
Changing a registered SMB folder, 88
Changing a registered Transfer Station/
 Receiving Station, 101
Changing a user code, 72
Changing paper, 122
Changing the language, 140
Changing the paper size, 122
Check Modes key, 21
Clear
 counter per user code, 61

Clearing misfeeds, 116
Clearing the number of prints, 75
Clear Modes key, 21
Clear/Stop key, 22
Combined function operations, 27
Common key operations, 23
Control panel, 18, 21
Copy Count Display, 51
Copy paper, 163
Cover sheet tray, 57

D

Delete
 all files, 66
Deleting a group, 98
Deleting a registered e-mail destination, 84
Deleting a registered fax destination, 81
Deleting a registered FTP folder, 92
Deleting a registered SMB folder, 89
Deleting a registered Transfer Station/
 Receiving Station, 102
Deleting a user code, 73
Display
 counter, 61
 counter per user code, 61
Displaying destinations registered in
 groups, 97
Displaying the Counter for each user code, 73
Displaying the Total Counter, 141
Display panel, 21, 23
Document Server, 33
 Deleting, 43
 Printing, 40
 Using the Document Server, 35
Do's and Don'ts, 131
Duplex unit, 19, 159

E

E-mail destination, 82
Energy Saver key, 22
Entering text, 143
Environment, 133
Exposure glass, 17
 cleaning, 136
Exposure glass cover, 19
 cleaning, 136
Extended security, 60
Extended Security function, 145
External charge unit management, 60
External options, 19

F

- Fax destination, 76
- Finisher
 - 1000-Sheet Finisher*, 19
 - 500-Sheet Finisher*, 19
- Front cover, 18
- FTP, 89
- Function keys, 22
- Function Priority, 51
- Function reset timer, 52
- Function status indicators, 22

I

- Indicators, 21
- Inquiry, 140
- Inter change unit, 19
- Internal options, 20
- Internal tray, 17
- Internal tray 2 (1 bin tray), 19
- Interrupt key, 22

K

- # key, 22
- Key counter management, 60
- Key Operator Code, 60

L

- Large Capacity Tray, 161
- Large Capacity Tray (LCT), 19
- LCT, 161
- LDAP server, 103
- Loading Paper
 - Large Capacity Tray*, 111
- Loading paper, 110
 - paper tray*, 110

M

- Machine environment, 133
- Main power indicator, 17, 22
- Main power switch, 17, 24
- Maintaining Your Machine, 136
- Main Unit, 151
- Misfeeds, 116
- Moving, 134
- Multi-Access, 29

N

- Number keys, 22

O

- Operation switch, 22, 24
- Options, 156

P

- Panel off timer, 58
- Panel Tone, 51
- Paper
 - changing*, 122
 - loading*, 110
- Paper tray, 18
- Paper tray 2, 18
- Paper tray priority
 - copier*, 55
 - facsimile*, 55
 - printer*, 55
- Paper tray unit, 19
- Paper type
 - bypass tray*, 56
 - tray 1-4*, 56
- Password management for stored files, 66
- Power connection, 134
- Power indicator, 22
- Print
 - address book*, 62
 - counter*, 61
 - counter per user code*, 61
- Printing the Counter for each user code, 74
- Print Priority, 52
- Program/change LDAP server, 66
- Program key, 21
- Programming an LDAP server, 103
- Protection
 - code*, 93, 94
 - destination*, 93

R

- Receiving Station, 99
- Registering a fax destination, 77
- Registering an e-mail destination, 82
- Registering a new user code, 70
- Registering a protection code, 93
- Registering a protection code to a group user, 94
- Registering a protection code to a single user, 93
- Registering a Transfer Station/
Receiving Station, 99
- Registering destination information, 68
- Registering destinations to a group, 95
- Registering Folders, 85
- Registering sender information, 69
- Registering the Transfer Request, 99
- Remarks, 131
- Remove Paper Indicator, 18
- Removing a destination from a group, 96
- Removing jammed staples, 128
- Replacing the Photo Conductor Unit, 137

S

- Safety information, 10
- Sample Copy key, 22
- Saving energy, 26
- Screen contrast knob, 21
- Security, 145
- Set date, 59
- Set time, 59
- Shift sort tray, 19
- Slip sheet tray, 57
- SMB, 85
- Specification
 - Duplex unit*, 159
 - Shift Sort Tray*, 159
- Specifications, 151
 - 1000-Sheet Finisher*, 158
 - Auto Document Feeder*, 156
 - bridge unit*, 160
 - internal tray 2 (1 bin tray)*, 160
 - Large Capacity Tray (LCT)*, 161
 - main unit*, 151
 - paper tray unit*, 161
- Staples
 - adding*, 125
 - removing jammed staples*, 128
- Start key, 22
- System Reset, 28

T

- Toner, 132
 - adding*, 113
 - storage*, 132
- To register an FTP folder, 89
- To register an SMB folder, 85
- Transfer Station, 99
- Tray paper size, 55

U

- Use LDAP server, 66
- User code
 - management*, 59
- User codes, 70
- User Tools/Counter key, 21
- User Tools (System Settings), 47
- Using FTP to Connect, 89
- Using SMB to Connect, 85

V

- Ventilation holes, 17

W

- Warm Up Notice (copier/Document Server), 51
- Web Image Monitor, 44

MEMO

In accordance with IEC 60417, this machine uses the following symbols for the main power switch:

I means **POWER ON.**

⏻ means **STAND BY.**

Type for 4022/DSm622/LD122 AG/Aficio 2022

Type for 4027/DSm627/LD127 AG/Aficio 2027

Printed in China

EN  B097-6507

Free Manuals Download Website

<http://myh66.com>

<http://usermanuals.us>

<http://www.somanuals.com>

<http://www.4manuals.cc>

<http://www.manual-lib.com>

<http://www.404manual.com>

<http://www.luxmanual.com>

<http://aubethermostatmanual.com>

Golf course search by state

<http://golfingnear.com>

Email search by domain

<http://emailbydomain.com>

Auto manuals search

<http://auto.somanuals.com>

TV manuals search

<http://tv.somanuals.com>